

CI5VGM Series
Full-Size Pentium All-in-one CPU Card
Version 1.0A

Industrial CPU Card
PC-Based Computer Boards for Industrial Automation
User's Manual

Copyright Notice

This publication is protected by copyright and all rights are reserved. No part of it may be reproduced or transmitted by any means or in any form, without prior consent of the original manufacturer.

The information in this document has been carefully checked and is believed to be accurate. However, the original manufacturer assumes no responsibility for any inaccuracies that may appear in this manual. In no event will the original manufacturer be liable for direct, indirect, special, exemplary, incidental, incidental or consequential damages resulting from any defect or omission in this manual, even if advised of possibility of such damages. The material contained herein is for informational purposes only.

Acknowledgments

Award is a registered trademark of Award Software International, Inc.

Cyber 9520/25 is a trademark of Trident Technologies Inc.

IBM, PS/2 are trademarks of International Business Machines Corporation.

Intel and Pentium are registered trademarks of Intel Corporation.

Microsoft Windows is a registered trademark of Microsoft Corporation.

MVP3 is a registered trademark of VIA Technologies Inc.

All other product names or trademarks are properties of their respective owners.

Contents

Chapter 1 Introduction.....	1
Checklist.....	3
Description	3
Features	4
Specifications	4
Intelligence	7
Board Dimensions	8
Chapter 2 Installations	10
CPU Installation	11
Memory Installation.....	12
Jumpers on the CI5VGM	14
Connectors on the CI5VGM.....	24
Watchdog Timer Configuration	37
Chapter 3 BIOS Configuration.....	38
Chapter 4 Audio Driver Installation Guide.....	65
Chapter 5 VGA Driver Installation Guide	77
Chapter 6 System Monitor Utility	97
Chapter 7 LANDesk Client Manager	105
Chapter 8 Ethernet Setup User's Guide	113
Appendix.....	126
A. I/O Port Address Map.....	127
B. Interrupt Request Lines (IRQ).....	128

Below are additional information for LCD Panel Type Select and settings for newer CPUs

SW3: LCD Panel Type Select

1	2	3	4	TFT LCD Panel
ON	ON	ON	ON	640x480 -18
OFF	ON	ON	ON	800x600 -18
ON	OFF	ON	ON	1024x768 -18
OFF	OFF	ON	ON	1024x768 -18+18
ON	ON	OFF	ON	1280x1024 -18+18

1	2	3	4	DSTN LCD Panel
ON	ON	ON	OFF	640x480 -16
OFF	ON	ON	OFF	800x600 -16
ON	OFF	ON	OFF	1024x768 -16
OFF	OFF	ON	OFF	1024x768 -24
ON	ON	OFF	OFF	1280x1024 -24

Settings for New Cyrix/AMD CPUs

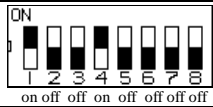
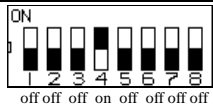
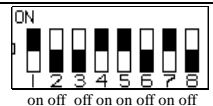
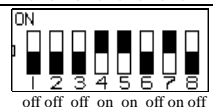
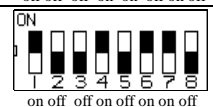
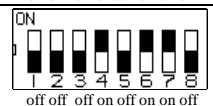
	95MHz	63MHz	3.5x	MII-400 (333MHz)
	100MHz	66MHz	3.5x	MII-433 (350MHz)
	95MHz	63MHz	4x	MII-450 (380MHz)
	100MHz	66MHz	4x	MII-466 (400MHz)
	95MHz	63MHz	5x	K6-2/475 K6-3/475
	100MHz	66MHz	5x	K6-2/500 K6-3/500

1

Introduction

This manual is designed to give you information on the CI5VGM CPU card. It is divided into the following sections:

Checklist	3
Description.....	3
Features.....	4
Specifications.....	4
Intelligence	7
Board Dimensions.....	8

The topics covered in this chapter are as follows:

- ◆ Checklist
- ◆ Description
- ◆ Features
- ◆ Specifications
- ◆ Layout of Key Components and Dimensions

Checklist

Please check that your package is complete and contains the items below. If you discover damaged or missing items, please contact your dealer.

- The CI5VGM Industrial CPU Card
- This User's Manual
- 1 IDE Ribbon Cable
- 1 Floppy Ribbon Connector
- 2 Serial Port Ribbon Cable and 1 Parallel Port Attached to a Mounting Bracket
- 1 Audio Output Ribbon Cable and EXTVGM Daughter Card Audio I/O Connector (supplied only if the CPU card has the audio capability)
- 1 Diskette Containing VIA PCI IDE Driver and Flash Memory Utility, VIA IRQ Routing Driver, VIA VxD Driver
- 2 Diskettes Containing Trident 9520/25 VGA Driver
- 2 Diskettes Containing Intel 82558B LAN Driver
- 5 Diskettes Containing YAMAHA 715 Audio Driver
- 1 Diskette Containing System Monitor Utility
- 1 Optional CD containing *Intel LANDesk Client Manager*

Description

The CI5VGM is a Pentium Industrial CPU card based on the VIA MVP3 chipset and is fully designed for harsh industrial environment. It features a Socket 7 processor connector that is compatible with Pentium-level processors from Intel, Cyrix, AMD and IDT. With three DIMM sockets on board, this card accommodates up to 384MB of system memory.

The CI5VGM comes with Winbond's W83781D hardware monitoring device that monitors system and CPU temperature, system voltages, and CPU and chassis fan speeds to prevent system crashes by warning the user of adverse conditions. The power management feature provides power savings by slowing down the CPU clock, turning off the monitor screen and stopping the HDD spindle motor.

Features

- Socket 7, CPU Speed 90~550MHz
- Bus Speed 60/66/75/83/95/100MHz
- VIA MVP3 AGPset
- Up to 384MB of system memory, ECC function supported
- Trident 9520/25 AGP VGA chipset for LCD & CRT display
- YAMAHA 715 Audio Chip
- 16 level programmable watchdog timer, from 0-30 seconds
- High speed bi-directional SPP/ECP/EPP parallel port
- ISA High Drive
- 2MB~72MB DiskOnChip support
- Hardware Monitoring
- Win95 shut-off, Modem ring-on via ATX power
- 10/100M Base-T Ethernet interface, IEEE 802.3 compliance specification
- Port 80 display LED
- COM2 supports RS232/433/485

Specifications

- **Processor Socket:** Socket 7 connector
- **Processor:**
 - Intel Pentium 120/133/150/166/200
 - Intel Pentium MMX (P55C) 166/200/233
 - Cyrix 6x86/6x86L P150+/P166+/P200+
 - Cyrix 6x86MX PR166/PR200/PR233/PR266
 - Cyrix 6x86MII PR266/PR300/PR333/PR366
 - AMD K5 PR166
 - AMD K6 166/200/233/266/300
 - AMD K6-2/300/333/350/366/380/400/450
 - IDT WinChip C6 180/200/225MHz
 - IDT WinChip2-3D 200/225/266MHz
- **Chipset:** VIA MVP3 AGPset with PCI EIDE and RTC built-in
- **Secondary Cache:** 1 MB

- **Memory Sockets:**
 - Three 168-pin DIMM sockets
 - Memory types: SDRAM (Synchronous DRAM)
 - DIMMs:** EDO DRAM or SDRAM (Synchronous DRAM)
 - DIMM Size:** 8MB, 16MB, 32MB, 64MB, 128MB
- **BIOS:** Y2K compliant Award BIOS, PnP support
 - FLASH EEPROM (256KB) for BIOS update
 - ISA Plug and Play (PnP) extension
 - Power management
- **DMI BIOS Support:**

Desktop Management Interface (DMI) allows users to download system hardware-level information such as CPU type, CPU speed, internal/external frequencies and memory size.
- **Multi I/O:** Winbond W83877TF
- **Parallel Port:** One high-speed parallel port, SPP/EPP/ECP mode
- **Serial Port:** Two 16550 UART compatible ports with COM1 as RS232 and COM2 jumper configurable as RS232/422/485
- **Enhanced IDE:** Two Bus Mastering EIDE mode, up to 4 devices, Two EIDE interfaces for up to four devices, support PIO Mode 3/4 or Ultra DMA/33 IDE Hard Disk, LS-120 and ATAPI CD-ROM.
- **FDD Interface:** Two floppy drives (360KB, 720KB, 1.2MB, 1.44MB, 2.88MB)
- **AGP bus CRT/LCD:** Trident 9520/25 chipset
 - Embedded 2MB/2.5MB (9520/9525) SDRAM display memory
 - Simultaneous CRT & LCD display
 - LCD panel supports DSTN/TFT
 - 1600x1200x256 colors CRT resolution
 - Up to 1280x1024x64K colors resolution for color active matrix TFT panels (12, 18, and 24bit analog) or (12+12), (18+18) double pixel/CLK interface
- **USB Interface:** Two USB pin-header connectors, compliant with USB Specification Rev. 1.0

- **Onboard Audio (optional):** The onboard audio consists of a YAMAHA YMF715-S (OPL3-SA3) single audio chip that integrates OPL3 and its DAC, 16bit Sigma-delta CODEC, MPU401 MIDI interface, joystick with timer, and a 3D enhanced controller including all the analog components which is suitable for multimedia application.
- **DiskOnChip:** The M-Systems flask disk supports system boot and storage capacity from 2MB to 72MB.
- **Watchdog Timer:** 16-level, programmable
 - I/O port 0443H to enable watchdog.
 - I/O port 0441H to disable watchdog.
 - Time-out timing select 0/2/4/6/8/10/12/14/16/18/20/22/24/26/28/30 seconds (+/-20%).
- **PCI Bus Ethernet Interface:** Intel 82558B
 - PCI local bus Ethernet controller
 - IEEE802.3u auto-negotiation for automatic speed selection
 - 10/100Mbps operation in a single port PCI bus master architecture
 - Wake On LAN function support on board
- **Green Function:** Power management via BIOS, activated through mouse/keyboard movement
- **Keyboard and Mouse Connectors:** PS/2 type mini-DIN that supports PC/AT; supports a 5-pin external keyboard connector
- **IrDA Interface:** Pin-header connector for the optional IrDA external connector
- **PICMG Compliance:** Fully compliant to PICMG standards
- **Environmental and Mechanical:**
 - **AT Power Supply:** Max. 15A @+5V
 - **ATX Power Supply:** Min 1A @+5VSB, Max15A@+5V
 - **Temperature:** 0°C to 60°C
 - **Humidity:** 5% to 95%
 - **Dimensions:** 338mm x 122mm

Intelligence

- **Temperature Monitoring and Alert:** A sensor for the CPU temperature on the CI5VGM monitors the CPU temperature and alerts the user through the speaker or buzzer when temperature exceeds the safe heat level.
- **Windows 95 shut-off:** Allows shut-off control from within Windows 95 and through an ATX power supply.
- **Modem ring-on:** Allows system powering on through an external modem and through an ATX power supply.
- **Year 2000 Compliant BIOS:** The onboard Award BIOS is Year 2000 Compliant and will pass software applications that have the tendency to invoke INT1AH function 04H such as year2000.exe utility released by NSTL.

Board Dimensions

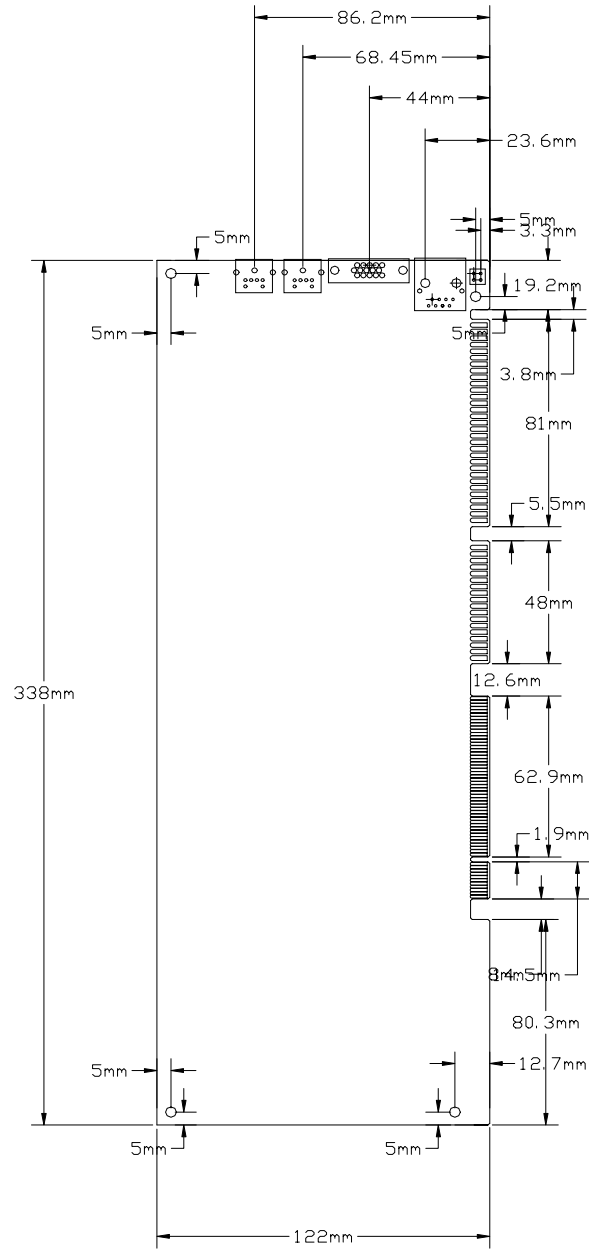

This page is intentionally left blank .

2

Installations

This chapter provides information on how to use the jumpers and connectors on the CI5VGM in order to set up a workable system. The topics covered are:

CPU Installation.....	11
Memory Installation.....	12
Jumpers on the CI5VGM.....	14
Connectors on the CI5VGM.....	24
Watchdog Timer Configuration.....	37

CPU Installation

The CI5VGM Industrial CPU Card supports a ZIF processor socket for Pentium-level processors.

Unlike PGA sockets, ZIF (Zero Insertion Force) sockets come with a lever to secure the processor. Make sure the notch on the corner of the CPU corresponds with the notch on the inside of the socket.

After you have installed the processor into the ZIF socket, check if the jumpers for the CPU type and speed are correct.

NOTE: *Ensure that the CPU heat sink and the CPU top surface are in total contact to avoid CPU overheating problem that would cause your system to hang or be unstable.*

Memory Installation

The CI5VGM Industrial CPU Card supports three 168-pin DIMM sockets for a maximum total memory of 384MB. The memory modules can come in sizes of 16MB, 32MB, 64MB, 128MB in EDO DRAM or SDRAM type.

In populating the DIMM sockets, DIMM1, DIMM2 or DIMM3 can be populated first. Refer to the following table on how to configure the memory.

NOTE: You must install memory modules of the same type, either all SDRAM or all EDO DRAM.

168Pin DIMM (3.3V) - SDRAM or EDO DRAM

(DIMM3)	(DIMM2)	(DIMM1)	Total Memory
8MB	----	----	8MB
16MB	----	----	16MB
32MB	----	----	32MB
64MB	----	----	64MB
128MB	----	----	128MB
8MB	8MB	----	16MB
16MB	8MB	----	24MB
32MB	8MB	----	40MB
64MB	8MB	----	72MB
128MB	8MB	----	136MB
8MB	8MB	8MB	24MB
16MB	8MB	8MB	32MB
32MB	8MB	8MB	48MB
64MB	8MB	8MB	80MB
128MB	8MB	8MB	144MB
16MB	16MB	----	32MB
32MB	16MB	----	48MB
64MB	16MB	----	80MB
128MB	16MB	----	144MB
16MB	16MB	8MB	40MB
32MB	16MB	8MB	56MB
64MB	16MB	8MB	88MB
128MB	16MB	8MB	152MB

168Pin DIMM (3.3V) - SDRAM or EDO DRAM (continued)

(DIMM3)	(DIMM2)	(DIMM1)	Total Memory
16MB	16MB	16MB	48MB
32MB	16MB	16MB	64MB
64MB	16MB	16MB	96MB
128MB	16MB	16MB	160MB
32MB	32MB	-----	64MB
64MB	32MB	-----	96MB
128MB	32MB	-----	160MB
32MB	32MB	8MB	72MB
64MB	32MB	8MB	104MB
128MB	32MB	8MB	168MB
32MB	32MB	16MB	80MB
64MB	32MB	16MB	112MB
128MB	32MB	16MB	176MB
32MB	32MB	32MB	96MB
64MB	32MB	32MB	128MB
128MB	32MB	32MB	192MB
64MB	64MB	-----	128MB
128MB	64MB	-----	192MB
64MB	64MB	8MB	136MB
128MB	64MB	8MB	200MB
64MB	64MB	16MB	144MB
128MB	64MB	16MB	208MB
64MB	64MB	32MB	160MB
128MB	64MB	32MB	224MB
64MB	64MB	64MB	192MB
128MB	64MB	64MB	256MB
128MB	128MB	128MB	384MB

Jumpers on the CI5VGM

The jumpers on the CI5VGM allows you to configure your CPU card according to the needs of your applications. If you have doubts about the best jumper configuration for your needs, contact your dealer or sales representative. The following table lists the connectors on CI5VGM and their respective functions.





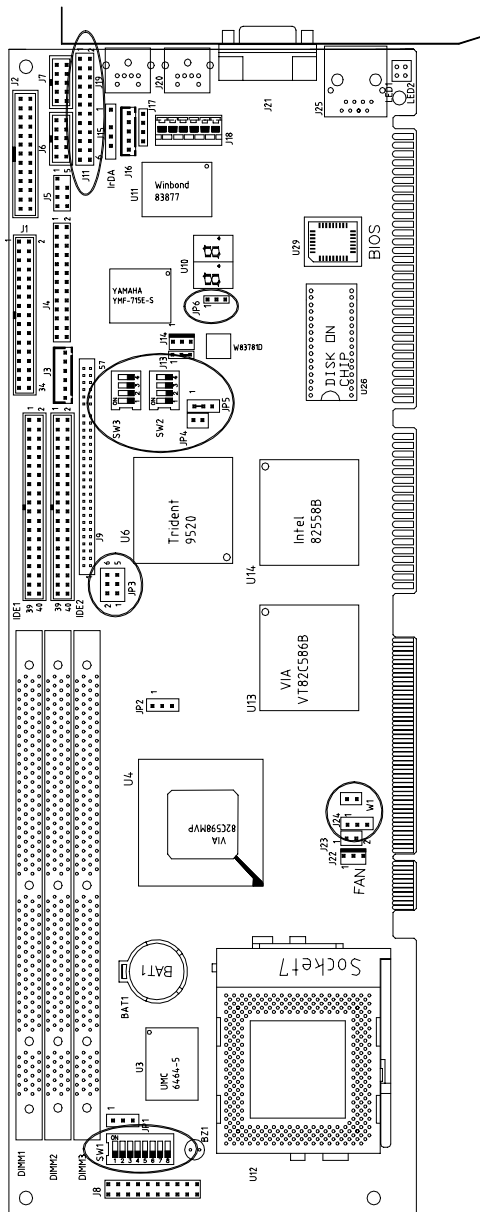



Jumper Locations on the CI5VGM	15
SW1(1-8): CPU Frequency Selector	16
JP2: SDRAM Operating Frequency	19
SW2(1-4): CPU Voltage Selector	19
JP3: LCD Power Setting.....	21
JP4: CRT/LCD Display Selection	21
JP6: DiskOnChip BIOS Expansion Address Select	22
J11: RS232/422/485 (COM2) Selection.....	22
J24: Clear CMOS Content.....	23
W1: Power Supply Select.....	23

Jumper Locations on the CI5VGM

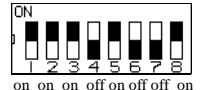

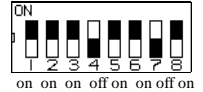

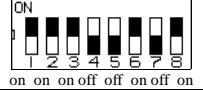
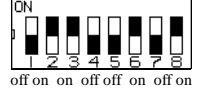
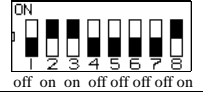
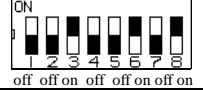

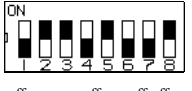

SW1(1-8): CPU Frequency Selector

For Intel Pentium, IDT WinChip 2-3D / C6

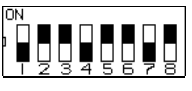
SW1	CPU Clock	AGP Clock	Multiplier	CPU FREQ.
 <p>on on on off off off off on</p>	60MHz	60MHz	1.5x	P54C-90
 <p>off on on off off off off on</p>	66MHz	66MHz	1.5x	P54C-100
 <p>on on on off on on off on</p>	60MHz	60MHz	2x	P54C-120
 <p>off on on off on off on on</p>	66MHz	66MHz	2x	P54C-133
 <p>on on on off on on on off on</p>	60MHz	60MHz	2.5x	P54C-150
 <p>off on on off on on on on</p>	66MHz	66MHz	2.5x	P54C/P55C-166
 <p>on on on off off on on on</p>	60MHz	60MHz	3x	C6-180
 <p>off on on off off on on on</p>	66MHz	66MHz	3x	P54C/P55C-200 WinChip 2-3D / C6-200
 <p>off on on off off off on on</p>	66MHz	66MHz	3.5x	P55C-233
 <p>off off on off off on on on</p>	75MHz	75MHz	3x	WinChip 2-3D / C6-225
 <p>off on on off on on on on</p>	66MHz	66MHz	4x	WinChip 2-3D 266

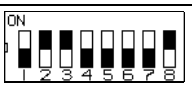
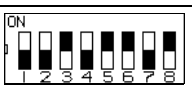
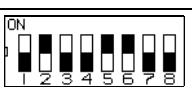
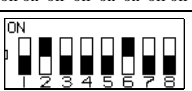
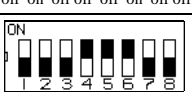
For Cyrix 6x86, 6x86L, 6x86MX. MII CPU

SW1	CPU Clock	AGP Clock	Multiplier	CPU FREQ.
 off on on off on off off on	66MHz	66MHz	2x	P166+ (133MHz)
 off off on on off off on	75MHz	75MHz	2x	P200+ (150MHz)
 off on on on on off on	66MHz	66MHz	2.5x	PR200 (166MHz)
 off on on off off on off on	66MHz	66MHz	3x	PR233 (200MHz)
 off on on off off off on	66MHz	66MHz	3.5x	PR266 (233MHz)
 off off on on on on off on	75MHz	75MHz	2.5x	PR233 (187.5MHz)
 off on off off on on off off	83MHz	66MHz	2.5x	PR266 (208MHz)
 off on off off off on off off	83MHz	66MHz	3x	PR333 (250MHz)
 off off off on on on off off	100MHz	66MHz	2.5x	PR333 (250MHz)
 off off off on off on off off	100MHz	66MHz	3x	PR366 (300MHz)

For AMD K5, K6, K6-2 CPU

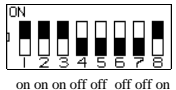
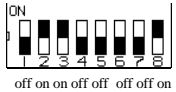
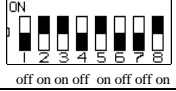
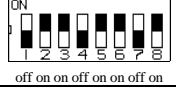
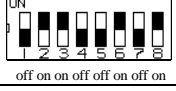
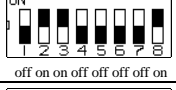
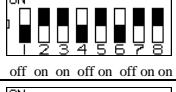
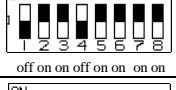
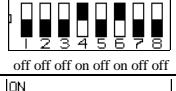
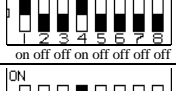
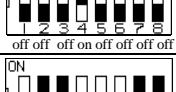
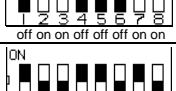
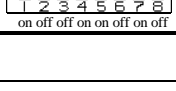
SW1	CPU Clock	AGP Clock	Multiplier	CPU FREQ.
 on on on off off off on	60MHz	60MHz	1.5x	PR90
 off on on off off off on	66MHz	66MHz	1.5x	PR100
 off on on on off off on	66MHz	66MHz	2x	PR133
 off on on on on off on	66MHz	66MHz	2.5x	PR166 / K6-166
 off on on off off off on	66MHz	66MHz	3x	K6-200
 off on on off off off on	66MHz	66MHz	3.5x	K6-233
 off on on on on off on	66MHz	66MHz	4x	K6-266
 off on on on on on on	66MHz	66MHz	4.5x	K6-300
 off off on on on off off	100MHz	66MHz	3x	K6-2/300
 on off on on off off off	95MHz	63MHz	3.5x	K6-2/333
 off off on on off off off	100MHz	66MHz	3.5x	K6-2/350
 off on on off off off on on	66MHz	66MHz	5.5x	K6-2/366
 on off on on on off on off	95MHz	63MHz	4x	K6-2/380

	100MHz	66MHz	4x	K6-2/400
	100MHz	66MHz	4.5x	K6-2/450

JP2: SDRAM Operating Frequency

JP2	SDRAM Frequency
pin 1-2 short	Run CPU Clock
pin 2-3 short	Run AGP Clock

NOTE: Set the SDRAM Frequency to **Run CPU Clock** only when the CPU clock is 100MHz and the DIMM module onboard meets PC-100 specifications.

SW2(1-4): CPU Voltage Selector

For Single Voltage CPU:

Intel P54C, Cyrix 6x86, AMD K5, IDT WinChip C6

SW2	V _{IO}	V _{CORE}
	3.5V	3.5V







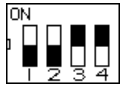

For Dual Voltage CPU:

Intel P55C, Cyrix 6x86L/MX/MII, AMD K6/K6-2, IDT WinChip 2-3D

SW2	V _{IO}	V _{CORE}	CPU
	3.3V	3.5V	WinChip 2-3D (0.35µ)
	3.3V	3.4V	
	3.3V	3.3V	

Remarks: 0.35µ and 0.25µ refers to CPU manufacturing process.

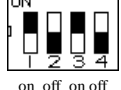
For Dual Voltage CPU:
 Intel P55C, Cyrix 6x86L/MX/MII, AMD K6/K6-2, IDT WinChip 2-3D

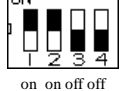
SW2	V _{IO}	V _{CORE}	CPU
 off off on on	3.3V	3.2V	K6-233 (0.35μ)
 on on off off	3.3V	3.1V	
 off on on off	3.3V	3.0V	
 on on off off	3.3V	2.9V	K6-166/200 6x86MX
 off off off on	3.3V	2.8V	WinChip 2-3D (0.35μ) P55C 6x86L
 on on off off	3.3V	2.7V	
 off on off off	3.3V	2.6V	
 on off off off	3.3V	2.5V	
 off off off off	3.3V	2.4V	
 on on off off	3.3V	2.3V	

For Dual Voltage CPU:
Intel P55C, Cyrix 6x86L/MX/MII, AMD K6/K6-2

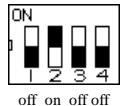
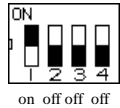
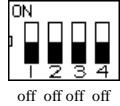
SW2	V _{IO}	V _{CORE}	CPU
 off on off off	3.3V	2.2V	K6, K6-2 (0.25μ)
 on off off off	3.3V	2.1V	
 off off off off	3.3V	2.0V	

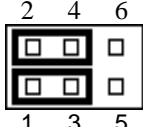
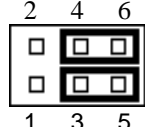

JP3: LCD Power Setting

The CI5VGM XGA interface supports 5V and 3.3V LCD displays. Use JP3 to change between 5V (*default*) and 3.3V panel video signal level.

3.3V Setting	5V Setting
 2 4 6 1 3 5	 2 4 6 1 3 5

JP4: CRT/LCD Display Selection

The JP4 jumper is used to toggle between CRT and LCD display.

JP4	Function	JP4	Function
 short	CRT Display	 open	LCD Display

JP6: DiskOnChip BIOS Expansion Address Select

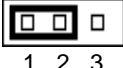
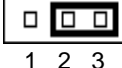
JP6	Address	JP6	Address
 1 2 3	D0000-D7FFF	 1 2 3	D8000-DFFFF (default)

J11: RS232/422/485 (COM2) Selection

COM1 is fixed for RS-232 use only.

COM2 is selectable for RS232, RS-422 and RS-485.

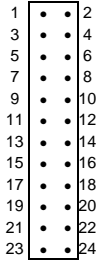
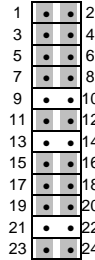
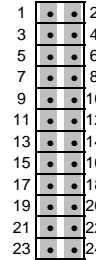

The following table describes the jumper settings of this connector.

COM2 Function	RS-232	RS-422	RS-485
Jumper Setting (pin closed)	all jumpers open	1-2 3-4 5-6 7-8 11-12 15-16 17-18 19-20 23-24	1-2 3-4 5-6 7-8 9-10 11-12 13-14 15-16 17-18 19-20 21-22 23-24
Jumper Illustration	 J11	 J11	 J11

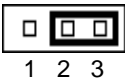
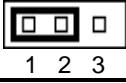
J24: Clear CMOS Content

J24	Setting	Function
 1 2 3	Pin 2-3 Short/Closed	Clear CMOS Content
 1 2 3	Pin 1-2 Short/Closed	Normal Operation (default)

W1: Power Supply Select

W1	Function	W1	Function
 short	ATX Power	 open	AT Power

Note: Failure to set W1 correctly may cause the system not to boot or the CMOS content to be erased.

Connectors on the CI5VGM

The connectors on the CI5VGM allows you to connect external devices such as keyboard, floppy disk drives, hard disk drives, printers, etc. The following table lists the connectors on CI5VGM and their respective functions.

Connector Locations on the CI5VGM.....	25
J1: Floppy Drive Connector	26
J2: Parallel Port Connector.....	26
IDE1, IDE2: EIDE Connectors	27
J3: External ATX Power Connector.....	28
J18: AT Power Connector	28
J4: Audio I/O Connector (optional).....	28
J5: USB Connector.....	29
J6: COM1 Serial Port.....	30
J7: COM2 Serial Port.....	30
J8: Front Bezel Connector.....	31
J9: LCD Panel Connector.....	33
J14: Chassis Fan Power Connector	34
J22, J23: CPU Fan Power Connectors.....	34
J15: IrDA Connector	34
J16: External Keyboard Connector	34
J17: External Mouse Connector	35
J19: PS/2 Keyboard Connector	35
J20: PS/2 Mouse Connector	35
J21: VGA CRT Connector	36
J25: RJ45 Connector	36

Connector Locations on the CI5VGM

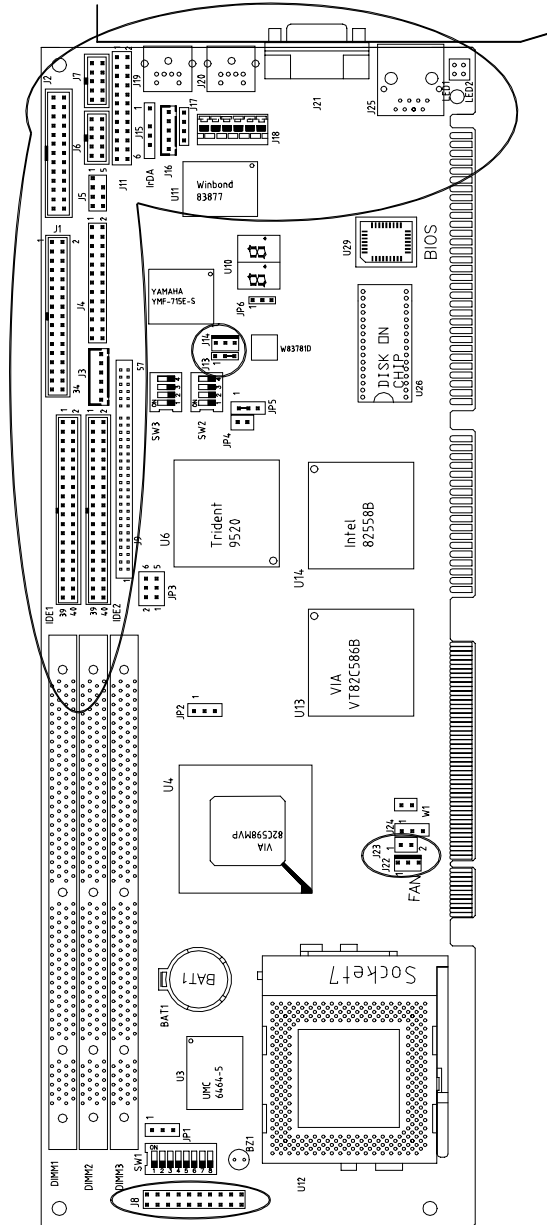

J1: Floppy Drive Connector

J1 is a 34-pin header and will support up to 2.88MB floppy drives.

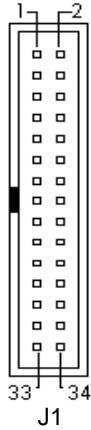

Signal Name	Pin #	Pin #	Signal Name
Ground	1	2	RM/LC
Ground	3	4	No connect
Ground	5	6	No connect
Ground	7	8	Index
Ground	9	10	Motor enable 0
Ground	11	12	Drive select 1
Ground	13	14	Drive select 0
Ground	15	16	Motor enable 1
Ground	17	18	Direction
Ground	19	20	Step
Ground	21	22	Write data
Ground	23	24	Write gate
Ground	25	26	Track 00
Ground	27	28	Write protect
Ground	29	30	Read data
Ground	31	32	Side 1 select
Ground	33	34	Diskette change

J2: Parallel Port Connector

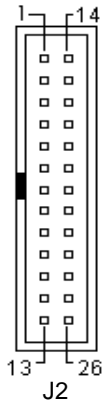

Signal Name	Pin #	Pin #	Signal Name
Line printer strobe	1	14	AutoFeed
PD0, parallel data 0	2	15	Error
PD1, parallel data 1	3	16	Initialize
PD2, parallel data 2	4	17	Select
PD3, parallel data 3	5	18	Ground
PD4, parallel data 4	6	19	Ground
PD5, parallel data 5	7	20	Ground
PD6, parallel data 6	8	21	Ground
PD7, parallel data 7	9	22	Ground
ACK, acknowledge	10	23	Ground
Busy	11	24	Ground
Paper empty	12	25	Ground
Select	13	N/A	N/A

IDE1, IDE2: EIDE Connectors

IDE1: Primary IDE Connector

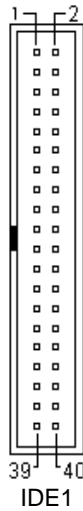

Signal Name	Pin #	Pin #	Signal Name
Reset IDE	1	2	Ground
Host data 7	3	4	Host data 8
Host data 6	5	6	Host data 9
Host data 5	7	8	Host data 10
Host data 4	9	10	Host data 11
Host data 3	11	12	Host data 12
Host data 2	13	14	Host data 13
Host data 1	15	16	Host data 14
Host data 0	17	18	Host data 15
Ground	19	20	Key
DRQ0	21	22	Ground
Host IOW	23	24	Ground
Host IOR	25	26	Ground
IOCHRDY	27	28	Host ALE
DACK0	29	30	Ground
IRQ14	31	32	No connect
Address 1	33	34	No connect
Address 0	35	36	Address 2
Chip select 0	37	38	Chip select 1
Activity	39	40	Ground

IDE2: Secondary IDE Connector

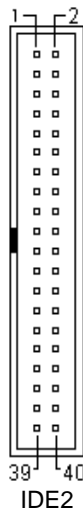

Signal Name	Pin #	Pin #	Signal Name
Reset IDE	1	2	Ground
Host data 7	3	4	Host data 8
Host data 6	5	6	Host data 9
Host data 5	7	8	Host data 10
Host data 4	9	10	Host data 11
Host data 3	11	12	Host data 12
Host data 2	13	14	Host data 13
Host data 1	15	16	Host data 14
Host data 0	17	18	Host data 15
Ground	19	20	Key
DRQ1	21	22	Ground
Host IOW	23	24	Ground
Host IOR	25	26	Ground
IOCHRDY	27	28	Host ALE
DACK1	29	30	Ground
IRQ15	31	32	No connect
Address 1	33	34	No connect
Address 0	35	36	Address 2
Chip select 0	37	38	Chip select 1
Activity	39	40	Ground

J3: External ATX Power Connector



Pin #	Signal Name
1	Dual function power button
2	GND
3	Dual function power button
4	GND
5	PS-ON (soft on/off)
6	5V SB (standby +5V)

J18: AT Power Connector



J18

Pin #	Signal Name
1	N/A
2	+5V
3	+12V
4	-12V
5	GND
6	GND

J4: Audio I/O Connector (optional)

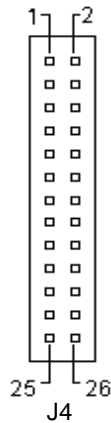

J4

Signal Name	Pin #	Pin #	Signal Name
+12V	1	2	-12V
GND	3	4	Out-R
Out-L	5	6	GND
Auxi-L	7	8	Auxi-R
GND	9	20	Line-R
Line-L	11	12	GND
Min	13	14	VREFO
Vcc	15	16	MIC
RxD	17	18	TXD
GP7	19	20	GP6
GP5	21	22	GP4
GP3	23	24	GP2
GP1	25	26	GP0

J4: Audio I/O Connector (Continued)

The J4 Audio I/O Connector connects to the EXTVGM Audio Daughter Card with the 26-pin ribbon cable supplied with the package. The EXTVGM Audio Daughter card provides two CD-AUDIO IN internal connectors and external connectors for LINE OUT, LINE IN, MICROPHONE, and JOYSTICK/MIDI. Refer to the figure below.

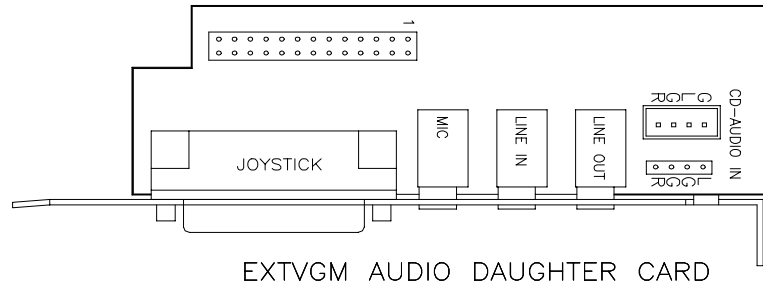

J5: USB Connector

Pin #	Signal Name
1	Vcc
2	USB-
3	USB+
4	Ground

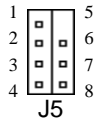

J6: COM1 Serial Port

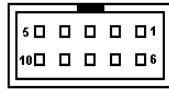

J6

Pin #	Signal Name
1	DCD, Data carrier detect
2	RXD, Receive data
3	TXD, Transmit data
4	DTR, Data terminal ready
5	GND, ground
6	DSR, Data set ready
7	RTS, Request to send
8	CTS, Clear to send
9	RI, Ring indicator
10	NC

J7: COM2 Serial Port

J7, a 10-pin header connector, is the onboard COM2 serial port of the CI5VGM and is configurable as RS-232, RS-422 or RS-485. The following table shows its pin assignments.

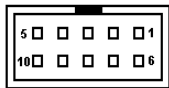

J7

Pin #	Signal Name		
	RS-232	R2-422	RS-485
1	DCD	TX-	DATA-
2	RX	TX+	DATA+
3	TX	RX+	NC
4	DTR	RX	NC
5	GND	GND	GND
6	DSR	RTS-	NC
7	RTS	RTS+	NC
8	CTS	CTS+	NC
9	RI	CTS-	NC
10	NC	NC	NC

J8: Front Bezel Connector

The front bezel of the case has a control panel which provides light indication of the computer activities and switches to change the computer status. J8 is a 20-pin header that provides interfaces for the following functions.

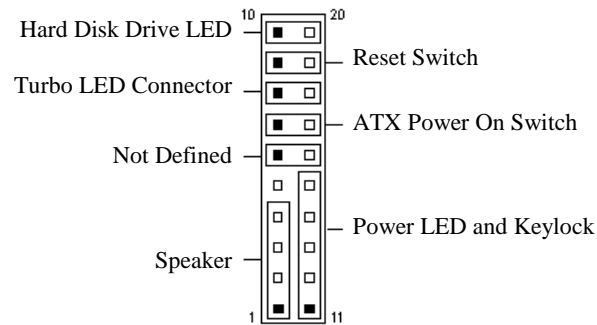

Speaker: Pins 1 - 4

This connector provides an interface to a speaker for audio tone generation. An 8-ohm speaker is recommended.

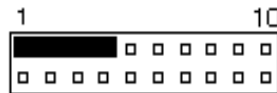

Pin #	Signal Name
1	Speaker out
2	No connect
3	Ground
4	+5V

Power LED and Keylock: Pins 11 - 15

The power LED indicates the status of the main power switch. The keylock switch, when closed, will disable the keyboard function.

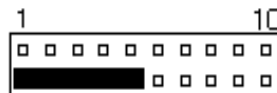

Pin #	Signal Name
11	Power LED
12	No connect
13	Ground
14	Keylock
15	Ground

ATX Power ON Switch: Pins 7 and 17

This 2-pin connector is an “ATX Power Supply On/Off Switch” on the system that connects to the power switch on the case. When pressed, the power switch will force the system to power on. When pressed again, it will force the system to power off.

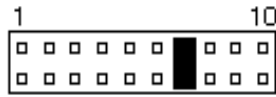

Turbo LED Connector: Pins 8 and 18

There is no turbo/deturbo function on the CPU card. The Turbo LED on the control panel will always be On when attached to this connector.

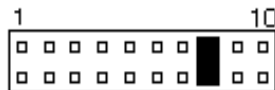

Pin #	Signal Name
8	5V
18	Ground

Reset Switch: Pins 9 and 19

The reset switch allows the user to reset the system without turning the main power switch Off and then On.

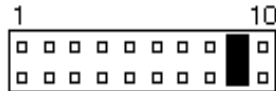

Hard Disk Drive LED Connector: Pins 10 and 20

This connector connects to the hard drive activity LED on control panel. This LED will flash when the HDD is being accessed.

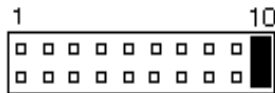

Pin #	Signal Name
10	HDD
20	5V

J9: LCD Panel Connector

J9 is a dual-in-line header for flat panel LCD displays. The following shows the pin assignments of this connector.

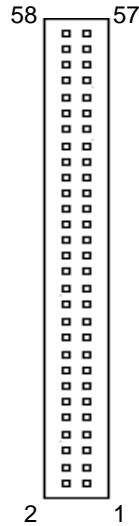

Signal Name	Pin #	Pin #	Signal Name
+12V	1	2	+12V
GND	3	4	GND
+5V/3.3V	5	6	+5V/3.3V
ENPVEE	7	8	GND
P0	9	10	P1
P2	11	12	P3
P4	13	14	P5
P6	15	16	P7
P8	17	18	P9
P10	19	20	P11
P12	21	22	P13
P14	23	24	P15
P16	25	26	P17
P18	27	28	P19
P20	29	30	P21
P22	31	32	P23
GND	33	34	GND
SHFCLK	35	36	FLM
DE	37	38	LP
GND	39	40	ENBLT
GND	41	42	PVDD
ENPVDD	43	44	+5V/3.3V
No Connect	45	46	No Connect
P24	47	48	P25
P26	49	50	P27
P28	51	52	P29
P30	53	54	P31
P32	55	56	P33
P34	57	58	P35

J14: Chassis Fan Power Connector

J14 is a 3-pin header for the chassis fan. The fan must be a 12V fan.

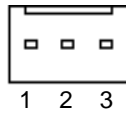

Pin #	Signal Name
1	Rotation
2	+12V
3	Ground

J22, J23: CPU Fan Power Connectors

J22 and J23 are pin headers for the CPU fan. The fan must be a 12V fan.

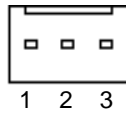

Pin #	Signal Name
1	Rotation
2	+12V
3	Ground



Pin #	Signal Name
1	+5V
2	Ground

J15: IrDA Connector

J15 is used for an IrDA connector for wireless communication.

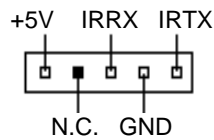

Pin #	Signal Name
1	+5V
2	No connect
3	Ir RX
4	Ground
5	Ir TX

J16: External Keyboard Connector



Pin #	Signal Name
1	Keyboard clock
2	Keyboard data
3	PG
4	GND
5	Vcc

J17: External Mouse Connector

J17

Pin #	Signal Name
1	Mouse data
2	Ground
3	5V
4	Mouse Clock

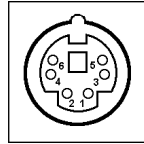
J19: PS/2 Keyboard Connector

J19

Pin #	Signal Name
1	Keyboard data
2	N.C.
3	Ground
4	5V
5	Keyboard clock
6	N.C.

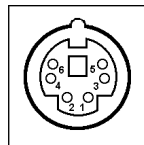
J20: PS/2 Mouse Connector

J20

Pin #	Signal Name
1	Mouse data
2	N.C.
3	Ground
4	5V
5	Mouse Clock
6	N.C.

J21: VGA CRT Connector

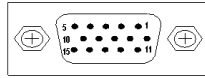

J21

Signal Name	Pin #	Pin #	Signal Name
Red	1	2	Green
Blue	3	4	N.C.
GND	5	6	GND
GND	7	8	GND
N.C.	9	10	GND
N.C.	11	12	N.C.
HSYNC	13	14	VSYNC
NC	15		

J25: RJ45 Connector

This connector is for the 10/100Mbps Ethernet capability of the CPU card. The figure below shows the pin out assignments of this connector and its corresponding input jack.

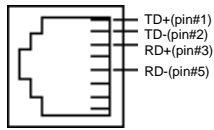

Watchdog Timer Configuration

The function of the watchdog timer is to reset the system automatically and is defined at I/O port 0443H. To enable the watchdog timer and allow the system to reset, write I/O port 0443H. To disable the timer, write I/O port 0441H for the system to stop the watchdog function. The timer has a tolerance of 20% for its intervals.

The following describes how the timer should be programmed.

Enabling Watchdog:

```
MOV  AX, 000FH (Choose the values from 0)
MOV  DX, 0443H
OUT  DX, AX
```

Disabling Watchdog

```
MOV  AX, 00FH (Any value is fine.)
MOV  DX, 0441H
OUT  DX, AX
```

WATCHDOG TIMER CONTROL TABLE

Level	Value	Time/sec	Level	Value	Time/sec
1	F	0	9	7	16
2	E	2	10	6	18
3	D	4	11	5	20
4	C	6	12	4	22
5	B	8	13	3	24
6	A	10	14	2	26
7	9	12	15	1	28
8	8	14	16	0	30

This page was intentionally left blank.

3

BIOS Configuration

This chapter describes the different settings available in the Award BIOS that comes with the CI5VGM CPU card. The topics covered in this chapter are as follows:

BIOS Introduction.....	42
BIOS Setup	42
Standard CMOS Setup.....	44
Date	44
Time	45
Primary HDDs / Secondary HDDs	45
Drive A / Drive B	46
Video	46
Halt On	46
BIOS Features Setup.....	47
Virus Warning	47
CPU Internal Cache / External Cache.....	47
Quick Power On Self Test	48
Boot Sequence.....	48
Swap Floppy Drive.....	48
Boot Up Floppy Seek	48
Boot Up NumLock Status.....	48
Boot Up System Speed.....	48
Gate A20 Option	48
Memory Parity / ECC Check	48
Typematic Rate Setting.....	49
Typematic Rate (Chars/Sec).....	49
Typematic Delay (Msec)	49
Security Option.....	49

PCI/VGA Palette Snoop	49
OS Select for DRAM > 64MB	49
HDD S.M.A.R.T. Capability	49
Video BIOS Shadow.....	50
C8000 - CBFFF Shadow/DC000 - DFFFF Shadow	50
Chipset Features Setup	51
DRAM Timing.....	51
SDRAM Cycle Length.....	51
DRAM Read Pipeline	51
Cache Rd+CPU Wt Pipeline.....	51
Cache Timing.....	51
Video BIOS Cacheable.....	52
System BIOS Cacheable	52
Memory Hole at 15MB - 16MB	52
AGP Aperture Size (MB)	52
Cyrix M2 ADS# delay	50
Auto Detect DIMM/PCI Clk.....	50
Spread Spectrum.....	50
OnChip USB.....	52
USB Keyboard Support	51
CPU Warning Temperature	53
Temperature/Fan Speed/ Voltage	51
Shutdown Temperature.....	51
Power Management Setup	54
ACPI function	54
Power Management	54
PM Control by APM.....	55
Video Off Option.....	55
Video Off Method.....	55
Modem Use IRQ.....	55
Soft-Off by PWR-BTTN	55
HDD Power Down.....	55
Doze Mode	55
Suspend Mode	56
PM Events.....	56
PNP/PCI Configuration.....	57
PNP OS Installed	57
Resources Controlled by.....	57
Reset Configuration Data.....	57
IRQ3/4/5/7/9/10/11/12/14/15, DMA0/1/3/5/6/7 assigned to	57

Load BIOS Defaults	59
Load Setup Defaults	59
Integrated Peripherals	60
OnChip IDE First/Second Channel.....	58
IDE Prefetch Mode.....	60
IDE HDD Block Mode.....	60
IDE Primary/Secondary Master/Slave PIO	60
IDE Primary/Secondary Master/Slave UDMA	61
Init AGP Display First.....	61
Onboard Audio Chip	61
Onboard FDD Controller.....	61
Onboard Serial/Parallel Port.....	61
UART 2 Mode.....	61
Parallel Port Mode.....	61
Supervisor / User Password	62
IDE HDD Auto Detection	63
Save & Exit Setup	64
Exit Without Saving	64

BIOS Introduction

The Award BIOS (Basic Input/Output System) installed in your computer system's ROM supports Intel Pentium II processors in a standard IBM-AT compatible I/O system. The BIOS provides critical low-level support for standard devices such as disk drives, serial and parallel ports. It also adds virus and password protection as well as special support for detailed fine-tuning of the chipset controlling the entire system.

BIOS Setup

The Award BIOS provides a Setup utility program for specifying the system configurations and settings. The BIOS ROM of the system stores the Setup utility. When you turn on the computer, the Award BIOS is immediately activated. Pressing the key immediately allows you to enter the Setup utility. If you are a little bit late pressing the key, POST (Power On Self Test) will continue with its test routines, thus preventing you from invoking the Setup. If you still wish to enter Setup, restart the system by pre or simultaneously pressing the <Ctrl>, <Alt> and <Delete> keys. You can also restart by turning the system Off and back On again. The following message will appear on the screen:

```
Press <DEL> to Enter Setup
```

In general, you press the arrow keys to highlight items, <Enter> to select, the <PgUp> and <PgDn> keys to change entries, <F1> for help and <Esc> to quit.

When you enter the Setup utility, the Main Menu screen will appear on the screen. The Main Menu allows you to select from various setup functions and exit choices.

ROM PCI/ISA BIOS
 CMOS SETUP UTILITY
 AWARD SOFTWARE, INC.

STANDARD CMOS SETUP	INTEGRATED PERIPHERALS
BIOS FEATURES SETUP	SUPERVISOR PASSWORD
CHIPSET FEATURES SETUP	USER PASSWORD
POWER MANAGEMENT SETUP	IDE HDD AUTO DETECTION
PNP/PCI CONFIGURATION	HDD LOW LEVEL FORMAT
LOAD BIOS DEFAULTS	SAVE & EXIT SETUP
LOAD SETUP DEFAULTS	EXIT WITHOUT SAVING
ESC : Quit	↑ ↓ → ← : Select Item
F10 : Save & Exit Setup	(Shift) F2 : Change Color
Time, Date, Hard Disk Type	

The section below the setup items of the Main Menu displays the control keys for this menu. Another section at the bottom of the Main Menu just below the control keys section displays information on the currently highlighted item in the list.

***NOTE:** After making and saving system changes with Setup, you find that your computer cannot boot, the Award BIOS supports an override to the CMOS settings that resets your system to its default.*

We strongly recommend that you avoid making any changes to the chipset defaults. These defaults have been carefully chosen by both Award and your system manufacturer to provide the absolute maximum performance and reliability.

Standard CMOS Setup

“Standard CMOS Setup” choice allows you to record some basic hardware configurations in your computer system and set the system clock and error handling. If the motherboard is already installed in a working system, you will not need to select this option. You will need to run the Standard CMOS option, however, if you change your system hardware configurations, the onboard battery fails, or the configuration stored in the CMOS memory was lost or damaged.

ROM PCI/ISA BIOS
STANDARD CMOS SETUP
AWARD SOFTWARE, INC.

Date (mm:dd:yy) : Wed, Mar 4 1998								
Time (hh:mm:ss) : 00 : 00 : 00								
HARD DISKS	TYPE	SIZE	CYLS	HEAD	PRECOMP	LANDZ	SECTOR	MODE
Primary Master	Auto	0	0	0	0	0	0	Auto
Primary Slave	Auto	0	0	0	0	0	0	Auto
Secondary Master	Auto	0	0	0	0	0	0	Auto
Secondary Slave	Auto	0	0	0	0	0	0	Auto
Drive A	: 1.44M, 3.5in							
Drive B	: None							
Video	: EGA / VGA							
Halt On	: All Errors							
			Base Memory : 640K			Extended Memory : 15360K		
			Other Memory : 384K			Total Memory : 16384K		
ESC : Quit			↑ ↓ → ← : Select Item			PU / PD / + / - : Modify		
F1 : Help			(Shift) F2 : Change Color					

At the bottom of the menu are the control keys for use on this menu. If you need any help in each item field, you can press the <F1> key. It will display the relevant information to help you. The memory display at the lower right-hand side of the menu is read-only. It will adjust automatically according to the memory changed. The following describes the items of this menu.

Date

The date format is:

Day : Sun to Sat
Month : 1 to 12
Date : 1 to 31
Year : 1994 to 2079

To set the date, highlight the “Date” field and use the PageUp/ PageDown or +/- keys to set the current time.

Time

The time format is: **Hour : 00 to 23**
Minute : 00 to 59
Second : 00 to 59

To set the time, highlight the “Time” field and use the <PgUp>/<PgDn> or +/- keys to set the current time.

Primary HDDs / Secondary HDDs

The onboard PCI IDE connectors provide Primary and Secondary channels for connecting up to four IDE hard disks or other IDE devices. Each channel can support up to two hard disks; the first is the “Master” and the second is the “Slave”.

To enter the specifications for a hard disk drive, you must select first a “Type”. There are 45 predefined types and 4 user definable types are for Enhanced IDE BIOS. Type 1 to 45 are predefined. Type “User” is user-definable. For the Primary Master/Slave as well as Secondary Master/Slave, you can select “Auto” under the TYPE and MODE fields. This will enable auto detection of your IDE drives and CD-ROM drive during POST.

Press <PgUp>/<PgDn> to select a numbered hard disk type or type the number and press the <Enter> key. The hard disk will not work properly if you enter incorrect information for this field. If your hard disk drive type is not matched or listed, you can use Type User to define your own drive type manually. If you select Type User, related information is asked to be entered to the following items.

CYLS : Number of cylinders
HEAD : Number of read/write heads
PRECOMP : Write precompensation
LANDZ : Landing zone
SECTOR : Number of sectors
SIZE : Automatically adjust according to the configuration
MODE (for IDE HDD only) : Auto
Normal (HD < 528MB)
Large (for MS-DOS only)
LBA (HD > 528MB and supports
Logical Block Addressing)

NOTE: *The specifications of your drive must match with the drive table. The hard disk will not work properly if you enter incorrect information in these fields. If your hard disk drive type is not matched or listed, you can use Type User to define your own drive type manually.*

Drive A / Drive B

These fields identify the types of floppy disk drive A or drive B that has been installed in the computer. The available specifications are:

360KB 1.2MB 720KB 1.44MB 2.88MB
5.25 in. 5.25 in. 3.5 in. 3.5 in. 3.5 in.

Video

This field selects the type of video display card installed in your system. You can choose the following video display cards:

EGA/VGA	For EGA, VGA, SEGA, SVGA or PGA monitor adapters. (default)
CGA 40	Power up in 40 column mode.
CGA 80	Power up in 80 column mode.
MONO	For Hercules or MDA adapters.

Halt On

This field determines whether the system will halt if an error is detected during power up.

No errors	The system boot will not be halted for any error that may be detected.
All errors	Whenever the BIOS detects a non-fatal error, the system will stop and you will be prompted.
All, But Keyboard	The system boot will not be halted for a keyboard error; it will stop for all other errors
All, But Diskette	The system boot will not be halted for a disk error; it will stop for all other errors.
All, But Disk/Key	The system boot will not be halted for a keyboard or disk error; it will stop for all others.

BIOS Features Setup

This section allows you to configure and improve your system and allows you to set up some system features according to your preference.

ROM / PCI ISA BIOS BIOS FEATURES SETUP AWARD SOFTWARE, INC.			
Virus Warning	: Disabled	Video BIOS Shadow	: Enabled
CPU Internal Cache	: Enabled	C8000-CBFFF Shadow	: Disabled
External Cache	: Enabled	CC000-CFFFF Shadow	: Disabled
Quick Power On Self Test	: Enabled	D0000-D3FFF Shadow	: Disabled
Boot Sequence	: A, C, SCSI	D4000-D7FFF Shadow	: Disabled
Swap Floppy Drive	: Disabled	D8000-DBFFF Shadow	: Disabled
Boot Up Floppy Drive	: Enabled	DC000-DFFF Shadow	: Disabled
Boot Up Numlock Status	: On		
Boot Up System Speed	: High		
Gate A20 Option	: Fast		
Memory Parity / ECC Check	: Disabled		
Typematic Rate Setting	: Disabled		
Typematic Rate (chars/Sec)	: 6		
Typematic Delay (Msec)	: 250		
Security Option	: Setup		
PCI /VGA Palette Snoop	: Disabled	ESC : Quit	↑ ↓ → ← : Select Item
OS Select For DRAM->64MB	: Non-OS2	F1 : Help	PU/PD/+/- : Modify
HDD S.M.A.R.T. capability	: Enabled	F5 : Old Values	(Shift) F2 : Color
		F6 : Load BIOS Defaults	
		F7 : Load Setup Defaults	

Virus Warning

This item protects the boot sector and partition table of your hard disk against accidental modifications. If an attempt is made, the BIOS will halt the system and display a warning message. If this occurs, you can either allow the operation to continue or run an anti-virus program to locate and remove the problem.

NOTE: Many disk diagnostic programs which attempt to access the boot sector table can cause the virus warning. If you will run such a program, disable the Virus Warning feature.

CPU Internal Cache / External Cache

Cache memory is additional memory that is much faster than conventional DRAM (system memory). CPUs from 486-type on up contain internal cache memory, and most, but not all, modern PCs have additional (external) cache memory. When the CPU requests data, the system transfers the requested data from the main DRAM into cache memory, for even faster access by the CPU. These items allow you to enable (speed up memory access) or disable the cache function. By default, these items are *Enabled*.

Quick Power On Self Test

When enabled, this field speeds up the Power On Self Test (POST) after the system is turned on. If it is set to *Enabled*, BIOS will skip some items.

Boot Sequence

This field determines the drive that the system searches first for an operating system. The options are :

A, C, SCSI	D, A, SCSI	SCSI, C, A
C, A, SCSI	E, A, SCSI	C only
C, CDROM, A	F, A, SCSI	LS/ZIP, C
CDROM, C, A	SCSI, A, C	

The default value is *A, C, SCSI*.

Swap Floppy Drive

This item allows you to determine whether or not to enable Swap Floppy Drive. When enabled, the BIOS swaps floppy drive assignments so that Drive A becomes Drive B, and Drive B becomes Drive A. By default, this field is set to *Disabled*.

Boot Up Floppy Seek

When enabled, the BIOS will seek whether or not the floppy drive installed has 40 or 80 tracks. 360K type has 40 tracks while 760K, 1.2M and 1.44M all have 80 tracks. By default, this field is set to *Enabled*.

Boot Up NumLock Status

This allows you to activate the NumLock function after you power up the system. By default, the system boots up with *NumLock* On.

Boot Up System Speed

Leave the default setting of the system speed at *High*.

Gate A20 Option

This field allows you to select how Gate A20 is worked. Gate A20 is a device used to address memory above 1 MB. The default setting is *Fast*.

Memory Parity / ECC Check

When enabled, this allows ECC checking of the CPU's L2 cache. By default, this field is *Disabled*.

Typematic Rate Setting

When disabled, continually holding down a key on your keyboard will generate only one instance. When enabled, you can set the two typematic controls listed next. By default, this field is set to *Disabled*.

Typematic Rate (Chars/Sec)

When the typematic rate is enabled, the system registers repeated keystrokes speeds. You can select speed range from 6 to 30 characters per second. By default, this item is set to **6**.

Typematic Delay (Msec)

When the typematic rate is enabled, this item allows you to set the time interval for displaying the first and second characters. By default, this item is set to *250msec*.

Security Option

This field allows you to limit access to the System and Setup. The default value is *Setup*. When you select *System*, the system prompts for the User Password every time you boot up. When you select *Setup*, the system always boots up and prompts for the Supervisor Password only when the Setup utility is called up.

PCI/VGA Palette Snoop

Some non-standard VGA display cards may not show colors properly. This field allows you to set whether or not MPEG ISA/VESA VGA Cards can work with PCI/VGA. When this field is enabled, a PCI/VGA can work with an MPEG ISA/VESA VGA card. When this field is disabled, a PCI/VGA cannot work with an MPEG ISA/VESA Card.

OS Select for DRAM > 64MB

This option allows the system to access greater than 64MB of DRAM memory when used with OS/2 that depends on certain BIOS calls to access memory. The default setting is *Non-OS/2*.

HDD S.M.A.R.T. Capability

This option enables or disables the S.M.A.R.T. feature found in some hard disks. The default setting is *Enabled*.

Video BIOS Shadow

This item allows you to change the Video BIOS location from ROM to RAM. Video Shadow will increase the video speed.

C8000 - CBFFF Shadow/DC000 - DFFFF Shadow

Shadowing a ROM reduces the memory available between 640KB to 1024KB. These fields determine whether or not optional ROM will be copied to RAM.

Chipset Features Setup

This Setup menu controls the configuration of the motherboard chipset.

ROM PCI/ISA BIOS CHIPSET FEATURES SETUP AWARD SOFTWARE INC.			
Bank 0/1 DRAM Timing	: SDRAM 8ns	CPU Warning Temperature	: 66°C/151°F
Bank 2/3 DRAM Timing	: SDRAM 8ns	Current System Temp.	:
Bank 4/5 DRAM Timing	: SDRAM 8ns	Current CPU Temp.	:
SDRAM Cycle Length	: 3	Current CPU Fan Speed	:
DRAM Read Pipeline	: Enabled	Current Chassis Fan Speed	:
Sustained 3T Write	: Enabled	VCORE	: VCC3
Cache Rd+CPU Wt Pipeline	: Disabled	+12V	: +5V
Cache Timing	: Fast	-5V	: -12V
Video BIOS Cacheable	: Enabled	Shutdown Temperature	: 75°C/167°F
System BIOS Cacheable	: Disabled		
Memory Hole At 15MB-16MB	: Disabled		
AGP Aperture Size	: 64M		
Cyrix M2 ADS# delay	: Disabled		
	:		
Auto Detect DIMM/PCI Clk	: Disabled	ESC : Quit	↑ ↓ → ← : Select Item
Spread Spectrum	: Disabled	F1 : Help	PU/PD/+/- : Modify
		F5 : Old Values	(Shift) F2 : Color
OnChip USB	: Enabled	F6 : Load BIOS Defaults	
USB Keyboard Support	: Disabled	F7 : Load Setup Defaults	

DRAM Timing

The DRAM timing is controlled by the DRAM Timing Registers. The timing type is dependent on the system design. Slower rates may be required in some system designs to support loose layouts or slower memory.

SDRAM Cycle Length

This field sets the length of each SDRAM cycle. By default, this field is set to **3**.

DRAM Read Pipeline

When enabled, this field supports pipelining of DRAM reads.

Sustained 3T Write

This field allows support for PBSRAM sustained 3T writes.

Cache Rd+CPU Wt Pipeline

When enabled, this item allows pipelining of cache reads and CPU writes.

Cache Timing

This field sets the timing of the cache in the system. The options are *fast* and *fastest*. By default, this field is set to *fast*.

Video BIOS Cacheable

When enabled, access to video BIOS addressed at C0000H to C7FFFH is cached, provided that the cache controller is disabled.

System BIOS Cacheable

When enabled, access to the system BIOS ROM addressed at F0000H-FFFFFH is cached, provided that the cache controller is disabled.

Memory Hole at 15MB - 16MB

In order to improve performance, certain space in memory can be reserved for ISA cards. This field allows you to reserve 15MB to 16MB memory address space to ISA expansion cards. This makes memory from 15MB and up unavailable to the system. Expansion cards can only access memory up to 16MB. By default, this field is set to *Disabled*.

AGP Aperture Size (MB)

The field sets aperture size of the graphics. The aperture is a portion of the PCI memory address range dedicated for graphics memory address space. Host cycles that hit the aperture range are forwarded to the AGP without any translation. The options available are 4M, 8M, 16M, 32M, 64M, 128M and 256M. The default setting is *64M*.

Cyrix M2 ADS# delay

This field is only visible when your system supports a Cyrix M2 processor. It enables or disables the ADS# delay signal for Cyrix M2.

Auto Detect DIMM/PCI Clk

When enabled, the system automatically shuts off clocks of unused DIMM/PCI slots. The default setting is *Disabled*. This field is for CE testing use only.

Spread Spectrum

This field sets the value of the spread spectrum. Options are Disabled, 1.8% (CNTR), 0.6% (CNTR), 1.8% (DOWN), and 0.6% (DOWN). The default setting is 0.6% (DOWN). The default setting is *Disabled*. This field is for CE testing use only.

OnChip USB

This field allows you to enable or disable the USB function. The default setting is *Enabled*.

USB Keyboard Support

The field enables or disables the support for a USB keyboard.

CPU Warning Temperature

This field sets the threshold temperature at which an alert is sounded through the system's speaker. The CPU temperature is monitored by the onboard thermal sensor to prevent the CPU from overheating.

Temperature/Fan Speed/Voltage

The values for the system/CPU temperature, CPU/chassis fan speed and system voltages are displayed as monitored by the H/W monitoring IC.

Shutdown Temperature

To avoid hardware damage due to overheat, this field can be configured so that the system shuts down automatically when it reaches the set temperature.

Power Management Setup

The Power Management Setup allows you to save energy of your system effectively. It will shut down the hard disk and turn off video display after a period of inactivity.

ROM PCI/ISA BIOS
POWER MANAGEMENT SETUP
AWARD SOFTWARE, INC.

ACPI function	: Enabled	Primary INTR	: ON
Power Management	: User Define	IRQ3 (COM 2)	: Primary
PM Control by APM	: Yes	IRQ4 (COM 1)	: Primary
Video Off Option	: Suspend -> Off	IRQ5 (LPT 2)	: Primary
Video Off Method	: V/H SYNC +Blank	IRQ6 (Floppy Disk)	: Primary
MODEM Use IRQ	: 3	IRQ7 (LPT 1)	: Primary
Soft-Off by PWRBTN	: Instant-Off	IRQ8 (RTC Alarm)	: Disabled
** PM Timers **		IRQ9 (IRQ2 Redir)	: Secondary
HDD Power Down	: Disabled	IRQ10 (Reserved)	: Secondary
Doze Mode	: Disabled	IRQ11 (Reserved)	: Secondary
Suspend Mode	: Disabled	IRQ12 (PS/2 Mouse)	: Primary
** PM Events **		IRQ13 (Coprocessor)	: Primary
VGA	: OFF	IRQ14 (Hard Disk)	: Primary
LPT & COM	: LPT/COM	IRQ15 (Reserved)	: Primary
HDD & FDD	: ON		
DMA/master	: OFF	ESC : Quit	↑ ↓ → ← : Select Item
PWR-ON by Modem/LAN	: Disabled	F1 : Help	PU/PD/+/- : Modify
RTC Alarm Resume	: Disabled	F5 : Old Values	(Shift) F2 : Color
		F6 : Load BIOS Defaults	
		F7 : Load Setup Defaults	

ACPI function

This field enables or disables the ACPI function.

Power Management

This field allows you to select the type of power saving management modes. There are four selections for Power Management.

Min. Power Saving	Minimum power management
Max. Power Saving	Maximum power management.
User Define	Each of the ranges are from 1 min. to 1hr. Except for HDD Power Down which ranges from 1 min. to 15 min. (Default)

NOTE: In order to enable the CPU overheat protection feature, the Power Management field should not be set to Disabled.

PM Control by APM

This field allows you to use the Advanced Power Management device to enhance the Max. Power Saving mode and stop the CPU's internal clock. If the Max. Power Saving is not enabled, this will be preset to NO.

Video Off Option

The Video Off options are *Suspend -> Off*, *Always On*, and *All Modes -> Off*. By default, this field is set to *Suspend -> Off*.

Video Off Method

This field defines the Video Off features. There are three options.
V/H SYNC + Blank Default setting, blank the screen and turn off vertical and horizontal scanning.

DPMS Allows the BIOS to control the video display card if it supports the DPMS feature.

Blank Screen This option only writes blanks to the video buffer.

Modem Use IRQ

This field names the interrupt request (IRQ) line assigned to the modem (if any) on your system. Activity of the selected IRQ always awakens the system. By default, the IRQ is set to 3.

Soft-Off by PWR-BTTN

This field defines the power-off mode when using an ATX power supply. The Instant-Off mode allows powering off immediately upon pressing the power button. In the Delay 4 Sec mode, the system powers off when the power button is pressed for more than four seconds or places the system in a very low-power-usage state, with only enough circuitry receiving power to detect power button activity or Resume by Ring activity (see next field) when pressed for less than 4 seconds. The default value is *Instant-Off*.

HDD Power Down

When enabled, and after the set time of system inactivity, the hard disk drive will be powered down while all other devices remain active.

Doze Mode

When enabled, and after the set time of system inactivity, the CPU clock will run at a slower speed while all other devices still operate at full speed.

Suspend Mode

When enabled, and after the set time of system inactivity, all devices except the CPU will be shut off.

PM Events

The VGA, LPT & COM, HDD & FDD, DMA/master, PWR-ON by Modem/LAN, RTC Alarm Resume, and Primary INTR sections are I/O events which can prevent the system from entering a power saving mode or can awaken the system from such a mode. When an I/O device wants to gain the attention of the operating system, it signals this by causing an IRQ to occur. When the operating system is ready to respond to the request, it interrupts itself and performs the service. When set to *ON*, activity will neither prevent the system from going into a power management mode nor awaken it. The IRQ section sets the wake-up call of the system. If activity is detected from any enabled IRQ channels in the left-hand group, the system wakes up from Suspend Mode.

PNP/PCI Configuration

This option configures the PCI bus system. All PCI bus systems on the system use INT#, thus all installed PCI cards must be set to this value.

ROM PCI/ISA BIOS
PNP/PCI CONFIGURATION
AWARD SOFTWARE INC.

PNP OS Installed	: No	CPU to PCI Write Buffer	: Enabled
Resources Controlled by	: Manual	PCI Dynamic Bursting	: Enabled
Reset Configuration Data	: Disabled	PCI Master 0 WS Write	: Disabled
		PCI Delay Transaction	: Enabled
IRQ-3 assigned to	: Legacy ISA	PCI Master Read Prefetch	: Enabled
IRQ-4 assigned to	: Legacy ISA	PCI#2 Access #1 Retry	: Disabled
IRQ-5 assigned to	: PCI/ISA PnP	AGP Master 1 WS Write	: Enabled
IRQ-7 assigned to	: Legacy ISA	AGP Master 1 WS Read	: Disabled
IRQ-9 assigned to	: PCI/ISA PnP		
IRQ-10 assigned to	: PCI/ISA PnP	PCI IRQ Activated By	: Level
IRQ-11 assigned to	: PCI/ISA PnP	Assign IRQ for USB	: Enabled
IRQ-12 assigned to	: PCI/ISA PnP	Assign IRQ for VGA	: Enabled
IRQ-14 assigned to	: PCI/ISA PnP		
IRQ-15 assigned to	: PCI/ISA PnP		
DMA-0 assigned to	: PCI/ISA PnP		
DMA-1 assigned to	: PCI/ISA PnP	ESC : Quit	↑ ↓ ← : Select Item
DMA-3 assigned to	: PCI/ISA PnP	F1 : Help	PU/PD/+/- : Modify
DMA-5 assigned to	: PCI/ISA PnP	F5 : Old Values	(Shift) F2 : Color
DMA-6 assigned to	: PCI/ISA PnP	F6 : Load BIOS Defaults	
DMA-7 assigned to	: PCI/ISA PnP	F7 : Load Setup Defaults	

PNP OS Installed

This field allows you to specify if the operating system installed in your system is plug and play aware.

NOTE: *Operating systems such as DOS, OS/2, and Windows 3.x do not use PnP*

Resources Controlled by

This PnP BIOS can configure all of the boot and compatible devices automatically. However, this capability needs you to use a PnP operating system such as Windows 95. The default value is **Manual**.

Reset Configuration Data

This field allows you to determine whether or not to reset the configuration data. The default value is **Disabled**.

IRQ3/4/5/7/9/10/11/12/14/15, DMA0/1/3/5/6/7 assigned to

These fields allow you to determine the IRQ/DMA assigned to the ISA bus and is not available to any PCI slot.

CPU to PCI Write Buffer

When enabled, this option increases the efficiency of the PCI bus to and speed up the execution in the processor. By default, this field is set to *Enabled*.

PCI Dynamic Bursting

When enabled, this option combines several PCI cycles into one. By default, this field is set to *Disabled*.

PCI Master 0 WS Write

When enabled, this option increases the write cycle speed. By default, this field is set to *Disabled*.

PCI Delay Transaction

When enabled, this option delays PCI data transactions.

PCI Master Read Prefetch

When this item is enabled, the system is allowed to prefetch the next read and initiate the next process.

PCI #2 Access #1 Retry

This item enables PCI#2 Access#1 attempts. By default, this field is set to *Disabled*.

AGP Master 1 WS Write

When enabled, writes to the AGP bus are executed with 1 wait states. By default, this field is set to *Enabled*.

AGP Master 1 WS Read

When enabled, reads to the AGP bus are executed with 1 wait states. By default, this field is set to *Disabled*.

PCI IRQ Activated By

This field allows you to select the method by which the PCI bus recognizes that an IRQ service is being requested by a device. The default value is *Level*.

Assign IRQ For USB / VGA

When enabled, an IRQ would be assigned to these items.

Load BIOS Defaults

This option allows you to load the troubleshooting default values permanently stored in the BIOS ROM. These default settings are non-optimal and disable all high-performance features.

ROM PCI/ISA BIOS
CMOS SETUP UTILITY
AWARD SOFTWARE, INC.

STANDARD CMOS SETUP	INTEGRATED PERIPHERALS
BIOS FEATURES SETUP	SUPERVISOR PASSWORD
CHIPSET FEATURES SETUP	USER PASSWORD
POWER MANAGE	DETECTION
PNP/PCI CONF	FORMAT
LOAD BIOS DEF	UP
LOAD SETUP DEF	EXIT WITHOUT SAVING
ESC : Quit	↑ ↓ → ← : Select Item
F10 : Save & Exit Setup	(Shift) F2 : Change Color
Load BIOS Defaults except Standard CMOS Setup	

To load BIOS defaults value to CMOS SRAM, enter “Y”. If not, enter “N”.

Load Setup Defaults

This option allows you to load the default values to your system configuration. These default settings are optimal and enable all high performance features.

ROM PCI/ISA BIOS
CMOS SETUP UTILITY
AWARD SOFTWARE, INC.

STANDARD CMOS SETUP	INTEGRATED PERIPHERALS
BIOS FEATURES SETUP	SUPERVISOR PASSWORD
CHIPSET FEATURES SETUP	USER PASSWORD
POWER MANAGE	DETECTION
PNP/PCI CONF	FORMAT
LOAD BIOS DEF	UP
LOAD SETUP DEFAULTS	EXIT WITHOUT SAVING
ESC : Quit	↑ ↓ → ← : Select Item
F10 : Save & Exit Setup	(Shift) F2 : Change Color
Load BIOS Defaults except Standard CMOS Setup	

To load SETUP defaults value to CMOS SRAM, enter “Y”. If not, enter “N”.

Integrated Peripherals

This option sets your hard disk configuration, mode and port.

ROM PCI/ISA BIOS
INTEGRATED PERIPHERALS
AWARD SOFTWARE INC.

OnChip IDE First Channel	: Enabled	Onboard FDD Controller	: Enabled
OnChip IDE Second Channel	: Enabled	Onboard Serial Port 1	: 3F8/IRQ4
IDE HDD Block Mode	: Disabled	Onboard Serial Port 2	:
IDE Prefetch Mode	: Enabled	UART 2 Mode	:
IDE HDD Block Mode	: Auto		
IDE Primary Master PIO	: Auto	Onboard Parallel Port	: 378/IRQ7
IDE Primary Slave PIO	: Auto	Parallel Port Mode	: SPP
IDE Secondary Master PIO	: Auto		
IDE Secondary Slave PIO	: Auto		
IDE Primary Master UDMA	: Auto		
IDE Primary Slave UDMA	: Auto		
IDE Secondary Master UDMA	: Auto		
IDE Secondary Slave UDMA	: Auto		
Init AGP Display First	: AGP		
Onboard Audio Chip	: Enabled		

ESC : Quit ↑ ↓ ← : Select Item
F1 : Help PU/PD+/- : Modify
F5 : Old Values (Shift) F2 : Color
F6 : Load BIOS Defaults
F7 : Load Setup Defaults

OnChip IDE First/Second Channel

The integrated peripheral controller contains an IDE interface with support for two IDE channels. Select *Enabled* to activate each channel separately.

IDE Prefetch Mode

This field allows your hard disk to prefetch the next read and initiate the next process.

IDE HDD Block Mode

This field allows your hard disk controller to use the fast block mode to transfer data to and from your hard disk drive.

IDE Primary/Secondary Master/Slave PIO

These fields allow your system hard disk controller to work faster. Rather than have the BIOS issue a series of commands that transfer to or from the disk drive, PIO (Programmed Input/Output) allows the BIOS to communicate with the controller and CPU directly.

The system supports five modes, numbered from 0 (default) to 4, which primarily differ in timing. When Auto is selected, the BIOS will select the best available mode.

IDE Primary/Secondary Master/Slave UDMA

These fields allow your system to improve disk I/O throughput to 33Mb/sec with the Ultra DMA/33 feature. The options are *Auto* and *Disabled*.

Init AGP Display First

This field allows the system to initialize first the VGA card in the AGP slot on the motherboard when system is turned on.

Onboard Audio Chip

Select *Enabled* to use the integrated audio chip on the motherboard.

Onboard FDD Controller

Select *Enabled* if your system has a floppy disk controller installed on the system board and you wish to use it. If you install an add-in FDC or the system has no floppy drive, select *Disabled* in this field. This option allows you to select the onboard FDD port.

Onboard Serial/Parallel Port

These fields allow you to select the onboard serial and parallel ports and their addresses. The default values for these ports are:

Serial Port 1	3F8/IRQ4
Serial Port 2	2F8/IRQ3
Parallel Port	378H/IRQ7

UART 2 Mode

This field determines the UART mode in your computer. The settings are *Normal*, *IrDA* and *ASKIR*. The default value is *Normal*.

Parallel Port Mode

This field allows you to determine parallel port mode function.

SPP	Normal Printer Port
EPP	Enhanced Parallel Port
ECP	Extended Capabilities Port

Supervisor / User Password

These two options set the system password. Supervisor Password sets a password that will be used to protect the system and Setup utility. User Password sets a password that will be used exclusively on the system. To specify a password, highlight the type you want and press <Enter>. The Enter Password: message prompts on the screen. Type the password, up to eight characters in length, and press <Enter>. The system confirms your password by asking you to type it again. After setting a password, the screen automatically returns to the main screen.

To disable a password, just press the <Enter> key when you are prompted to enter the password. A message will confirm the password to be disabled. Once the password is disabled, the system will boot and you can enter Setup freely.

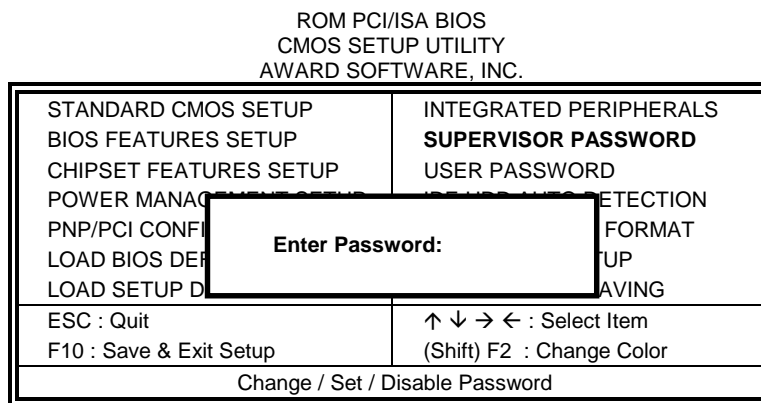

IDE HDD Auto Detection

This option detects the parameters of an IDE hard disk drive, and automatically enters them into the Standard CMOS Setup screen.

ROM PCI/ISA BIOS
STANDARD CMOS SETUP
AWARD SOFTWARE, INC.

HARD DISKS	TYPE	SIZE	CYLS	HEAD	PRECOMP	LANDZ	SECTOR	MODE
Primary Master:								
Select Primary Master Option (N=SKIP) : N								
OPTIONS	TYPE	SIZE	CYLS	HEAD	PRECOMP	LANDZ	SECTOR	MODE
1 (Y)	0	0	0	0	0	0	0	NORMAL
NOTE: Some OSes (like SCO-UNIX) must use "NORMAL" for installation								
ESC: SKIP								

Up to four IDE drives can be detected, with parameters for each appearing in sequence inside a box. To accept the displayed entries, press the "Y" key; to skip to the next drive, press the "N" key. If you accept the values, the parameters will appear listed beside the drive letter on the screen.

Save & Exit Setup

This option allows you to determine whether or not to accept the modifications. If you type “Y”, you will quit the setup utility and save all changes into the CMOS memory. If you type “N”, you will return to Setup utility.

ROM PCI/ISA BIOS
CMOS SETUP UTILITY
AWARD SOFTWARE, INC.

STANDARD CMOS SETUP BIOS FEATURES SETUP CHIPSET FEATURES SETUP POWER MANAGE PNP/PCI CONF LOAD BIOS DEF LOAD SETUP DEFAULTS	INTEGRATED PERIPHERALS SUPERVISOR PASSWORD USER PASSWORD DETECTION FORMAT UP EXIT WITHOUT SAVING
Save to CMOS and Exit (Y/N)? N	
ESC : Quit	↑ ↓ → ← : Select Item
F10 : Save & Exit Setup	(Shift) F2 : Change Color
Save Data to CMOS & Exit Setup	

Exit Without Saving

Select this option to exit the Setup utility without saving the changes you have made in this session. Typing “Y” will quit the Setup utility without saving the modifications. Typing “N” will return you to Setup utility.

ROM PCI/ISA BIOS
CMOS SETUP UTILITY
AWARD SOFTWARE, INC.

STANDARD CMOS SETUP BIOS FEATURES SETUP CHIPSET FEATURES SETUP POWER MANAGE PNP/PCI CONF LOAD BIOS DEF LOAD SETUP DEFAULTS	INTEGRATED PERIPHERALS SUPERVISOR PASSWORD USER PASSWORD DETECTION FORMAT UP EXIT WITHOUT SAVING
Quit Without Saving (Y/N)? N	
ESC : Quit	↑ ↓ → ← : Select Item
F10 : Save & Exit Setup	(Shift) F2 : Change Color
Abandon all Data & Exit Setup	

4

Audio Driver Installation Guide

This chapter describes the audio driver installation procedure for the onboard YAMAHA YMF715-S audio chip. The YMF715-S (OPL3-SA3) single audio chip integrates OPL3 and its DAC, 16bit Sigma-delta CODEC, MPU401 MIDI interface, joystick with timer, and a 3D enhanced controller.

For normal operations and to maximize the audio functions of the motherboard, follow the audio driver installation procedure below.

This chapter contains the following sections:

Installing The Audio Drivers For Windows 95	66
Setting the 3D Function	71
Using YAMAHA Software Wavetable for Windows 95	73
Installing the Audio Drivers for Windows NT 4.0	74

Installing the Audio Drivers for Windows 95

- Step 1. After installing Windows 95, insert the CD or audio drivers floppy disk that comes with your motherboard in the CD-ROM or floppy disk drive (labeled YAMAHA Audio YMF715 Windows 95 Drivers).
- Step 2. Click on Start → Setting → Control Panel → System → Device Manager. Upon clicking on Other Devices, the figure below appears. Remove OPL3-SAX Sound Board, and then click Refresh.

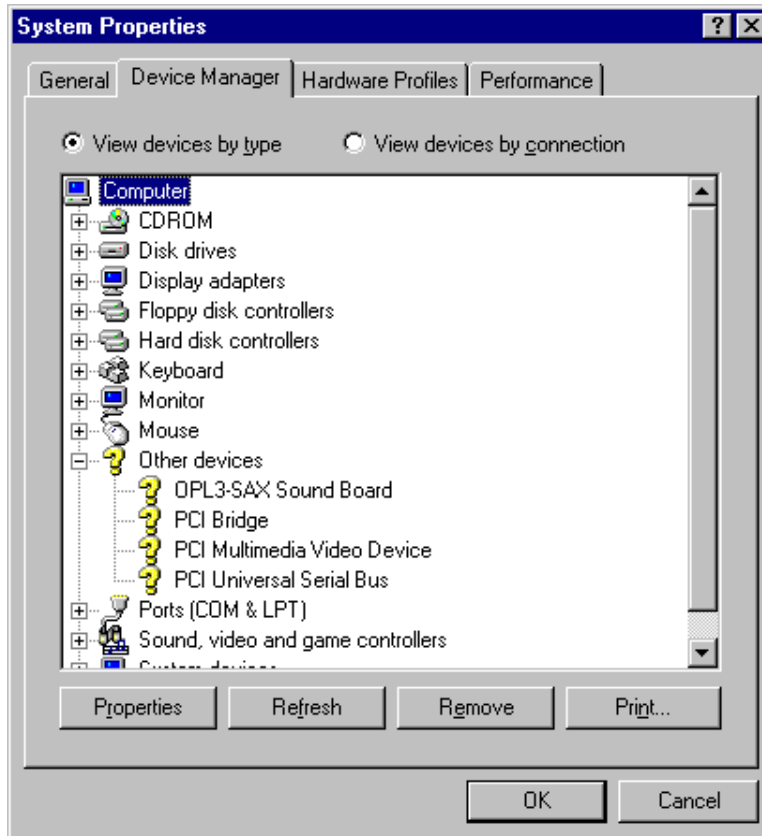

Step 3. When the figure below appears, press the Next to search for the driver.



Step 4. When the figure below appears, click Other Locations..., then type d:\soundlya715\win95 or a:\ and click OK.



Step 5. The Update Device Driver Wizard will find YAMAHA OPL3-SAx Sound System and show the following figure. Click Finish.



Step 6. When the Opl3sa.drv on OPL3-SAx driver could not be found, type the driver location as d:\sound\ya715\win95 or a:\ as shown below. Click OK.

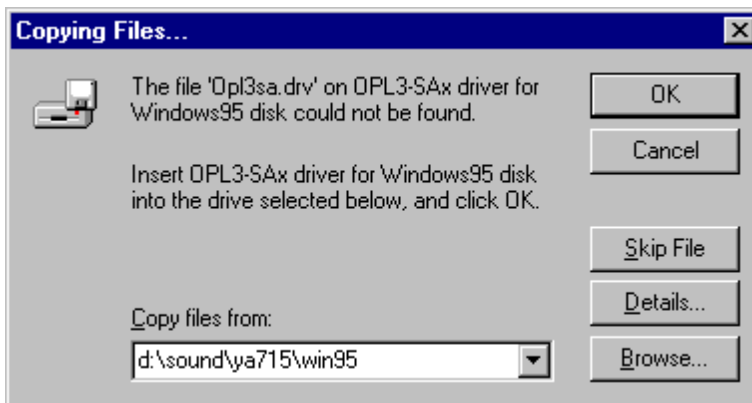

Step 7. When file copying is done and the figure below appears, insert the Windows 95 CD into the CD-ROM, and then click OK.



Step 8. When the driver installation is finished, continue to install the YSTATION software. Press Start → Run, then type d:\Sound\YA715\Win95\ystation\setup or a:\ setup (The disk is labeled YAMAHA Audio Application for Windows 95), then press Enter. Refer to the figure below.

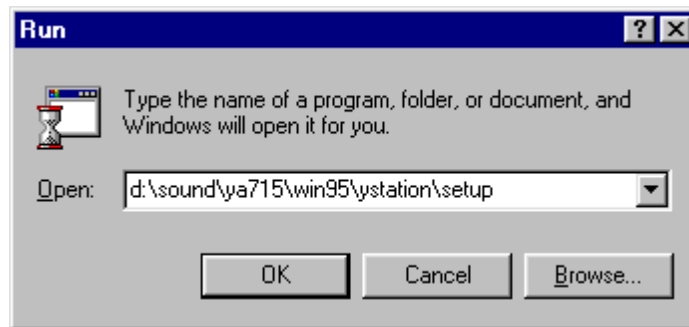

Step 9. When the figure below appears, click Typical, and then continue the installation by following Install Wizard. It is recommended that the default settings assigned by the Install Wizard be applied during the first time installation.

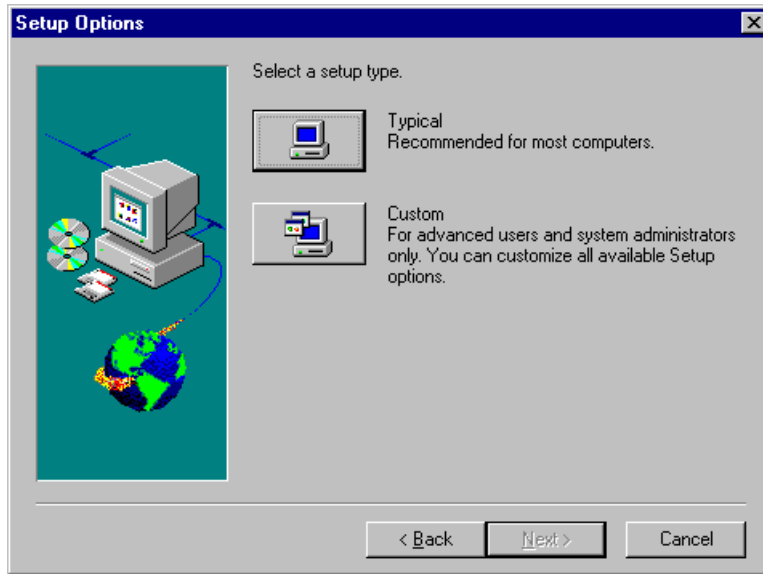

Setting the 3D Function

Step 1. Click Start in the task bar, and then select Settings. Click Control Panel.



Step 2. Double click the OPL3-SAx Config icon.

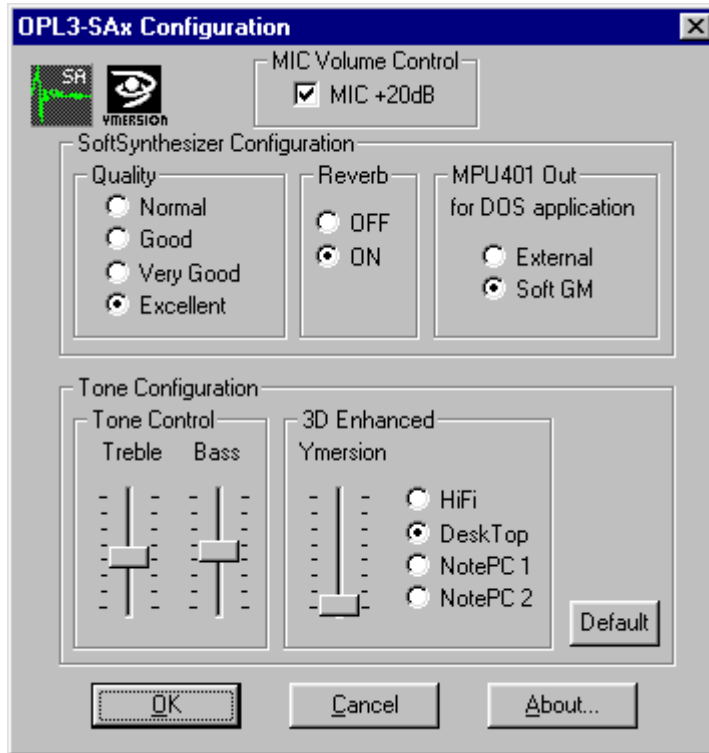

Step 3. Move Ymersion slide bar to adjust the 3D effects.

Using YAMAHA Software Wavetable for Windows 95

The audio driver includes the YAMAHA Soft GM software. After finishing the audio driver installation, you can use this software to change some settings for better MIDI sound quality.

Step 1. To switch to FM or *Soft GM* (Software Wavetable) MIDI generator on Windows 95, click Start in the task bar, and then select Settings. Click Control Panel.

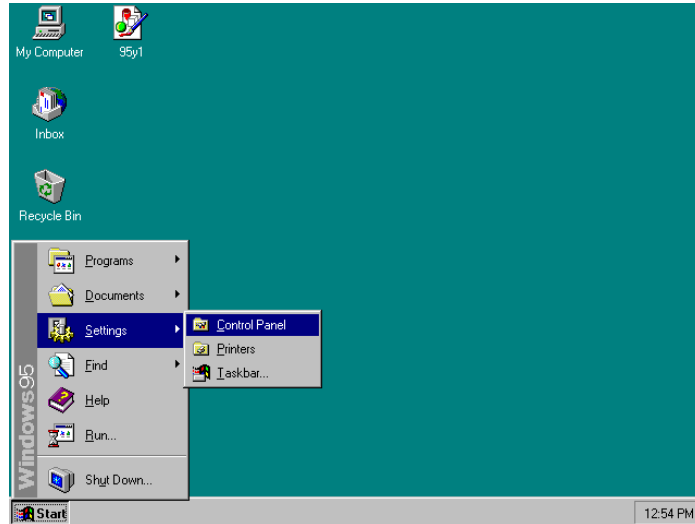

Step 2. In the Control Panel window, double click the Multimedia icon.

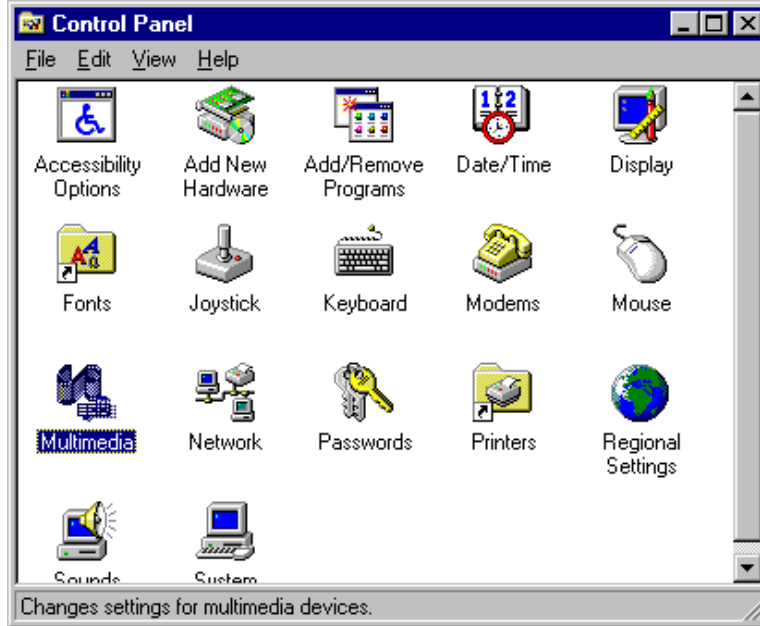

Step 3. When the window below appears, choose the MIDI tab. Three items are shown.

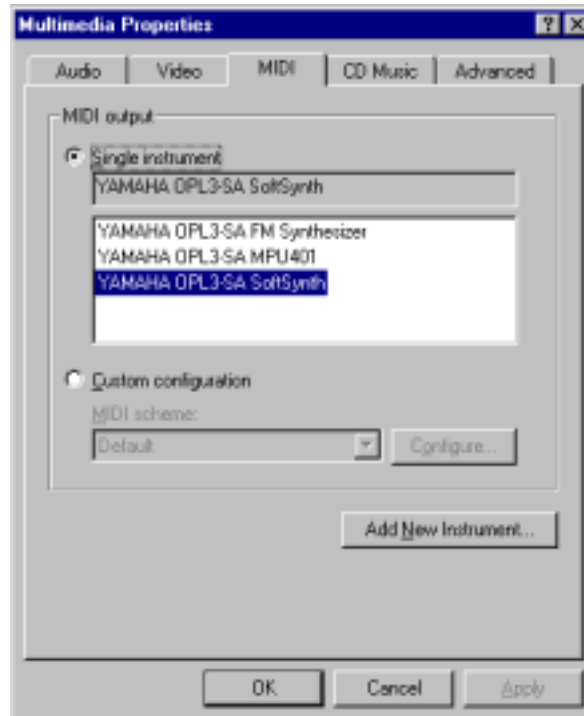

These items are:

- **OPL3-SA FM Synthesizer** Select **OPL3 FM** synthesizer.
- **OPL3-SA MPU401** Select **Hardware Wavetable**.
- **OPL3-SA SoftSynth** Select **Soft GM** (S/W Wavetable).

Depending on which device you would like to select, point the mouse cursor to the device name and click it. Then click the OK button. The device is ready to be used.

NOTE: If you choose *Soft GM* in high quality mode despite the poor CPU power, sound might not be played smoothly. A **Pentium**-based system or faster is recommended to play the *Soft GM* in high quality mode.

You cannot record while playing MIDI files when you are using the software synthesizer.

Installing the Audio Drivers for Windows NT 4.0

- Step 1. Before installing the audio drivers for Windows NT 4.0, you must first install the file **pnpisa.inf**. This file can be found in the Windows NT 4.0 CD or the Service Pack3 CD. It is recommended that the file in the Service Pack3 CD be used. When the file has been found, select the file by clicking the mouse and then click the mouse right button. Click Install to start copying files into your system. When Windows NT prompts you to restart the computer, click Yes.
- Step 2. Upon restarting, Windows NT will find the new hardware *OPL3-SAX*. Select Driver from disk provided by hardware manufacturer. Insert the CD or floppy diskette labeled YAMAHA Audio YMF715 Windows NT 4.0 Drivers, then click OK.
- Step 3. Type A:\ or D:\sound\ya715\winnt40 (if you are using floppy diskette or CD respectively), then click OK.
- Step 4. Select OPL3-SA sound system (xxxxx), then click OK. (xxxxx) refers to the language that you are using.
- Step 5. When the Resource window appears, click OK.
- Step 6. When the Game Port window appears, select Windows NT default driver, then click OK.
- Step 7. Click Yes when Windows NT prompts you to restart the computer.

5

VGA Driver Installation Guide

This chapter describe the VGA driver installation procedure for the onboard Trident 9520/25.

This chapter contains the following sections:

Installing Trident 9520/25 Drivers for Windows 95.....	78
Installing Trident 9520/25 Drivers for Windows 98.....	84
Installing Trident 9520/25 Drivers for Windows NT 4.0	96

Installing Trident 9520/25 Drivers for Windows 95

Step 1. In the Windows 95 screen, click Start. Select Settings, then click the Control Panel icon.

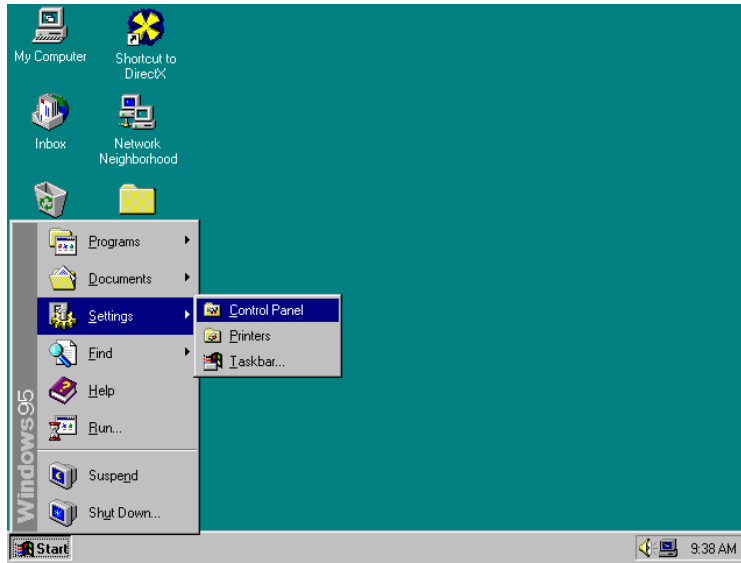

Step 2. Double click Display, then click Settings.

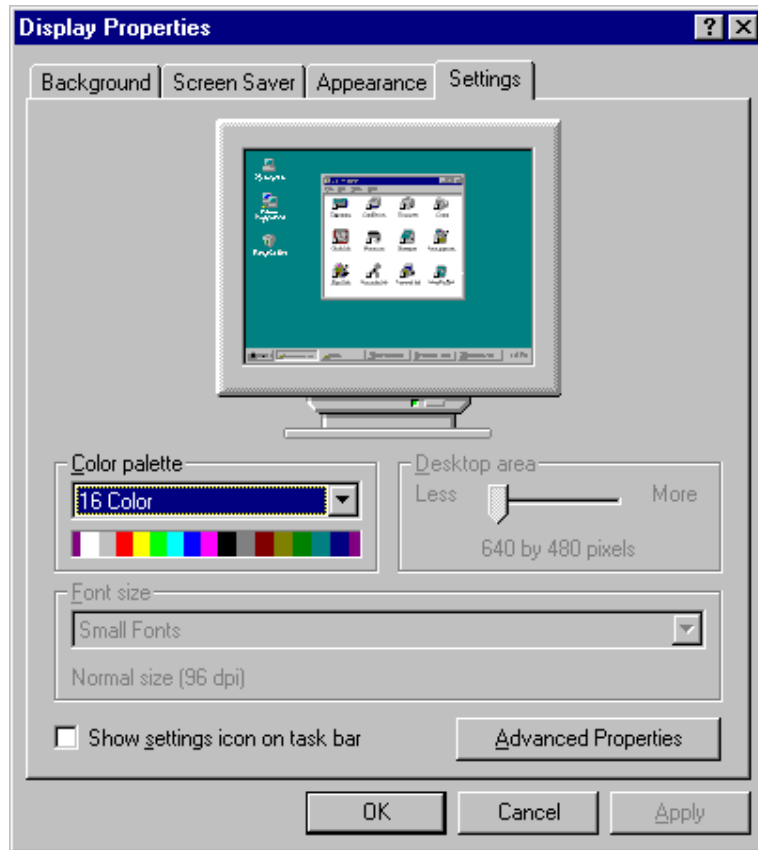

Step 3. Click Advanced Properties, then click Change....

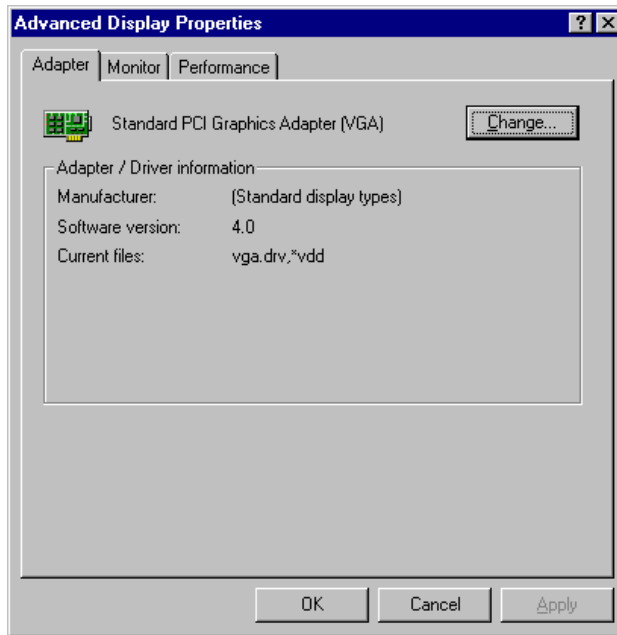

Step 4. Click Have Disk If "D:" is your CDROM, type D:\VGA\Trid9520\WIN95 and click OK. If you are using the floppy disk labeled Trident 9520/25 VGA Driver Windows 95/98, type A:\ and click OK.

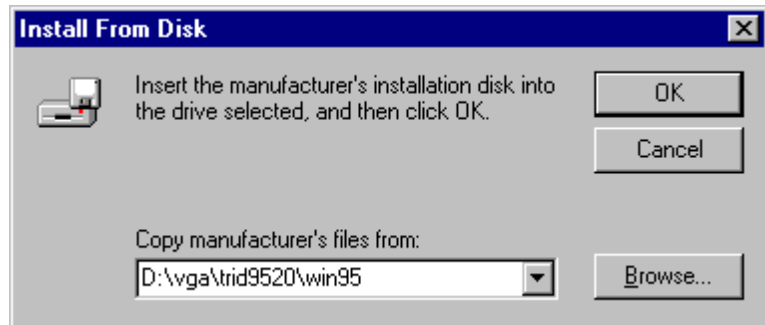
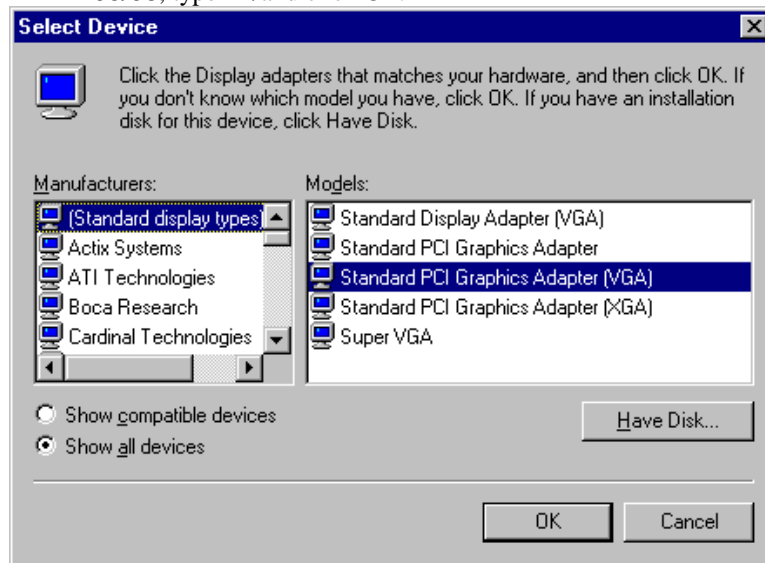

Step 5. Select Trident Cyber 9520/25 PCI/AGP (VX.XX.XXXX.95), then click OK.

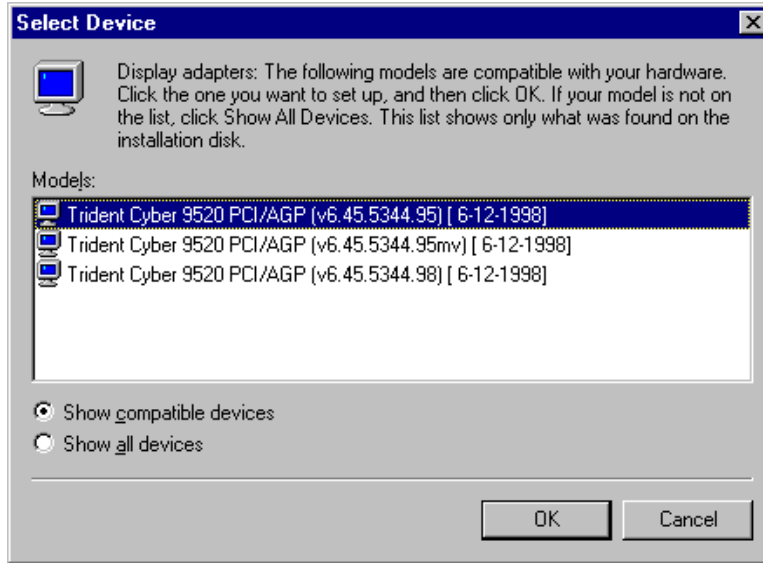

Step 6. After the files are copied, click Close.

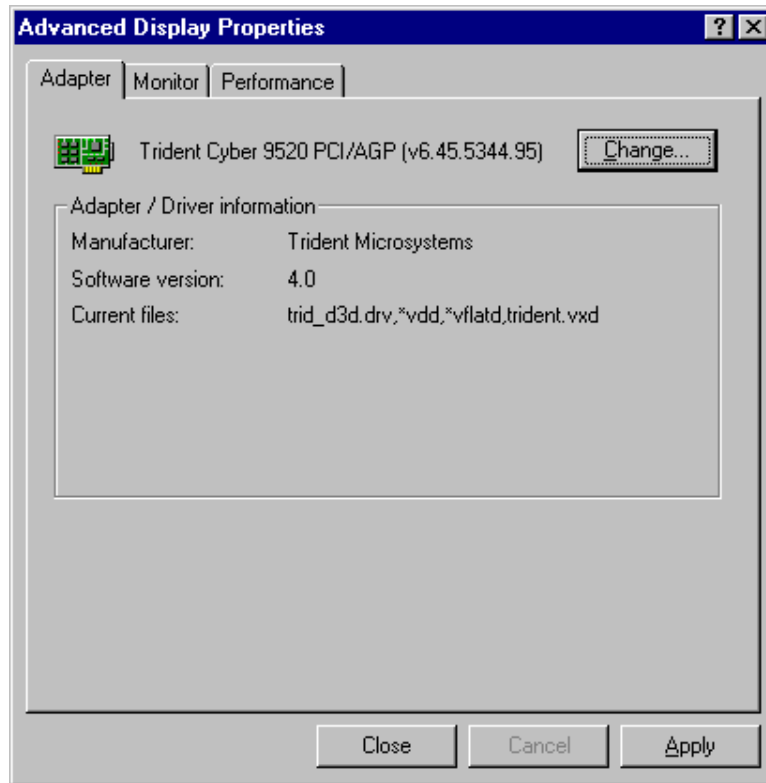

Step 7. Click Yes to restart your computer and for the new settings to

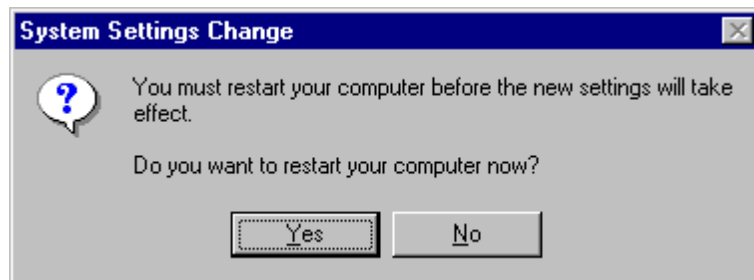

Installing Trident 9520/25 Drivers for Windows 98

Step 1. Click Start. Select Settings, then click the Control Panel icon.

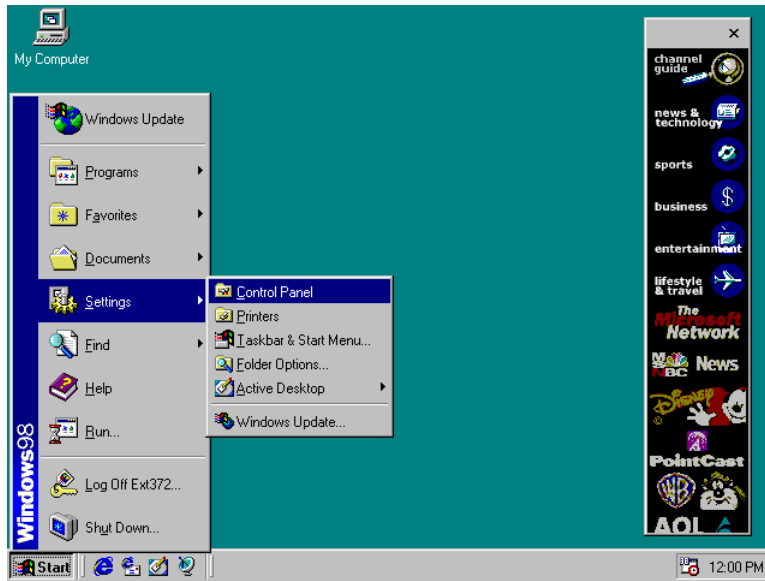

Step 2. Double click Display.

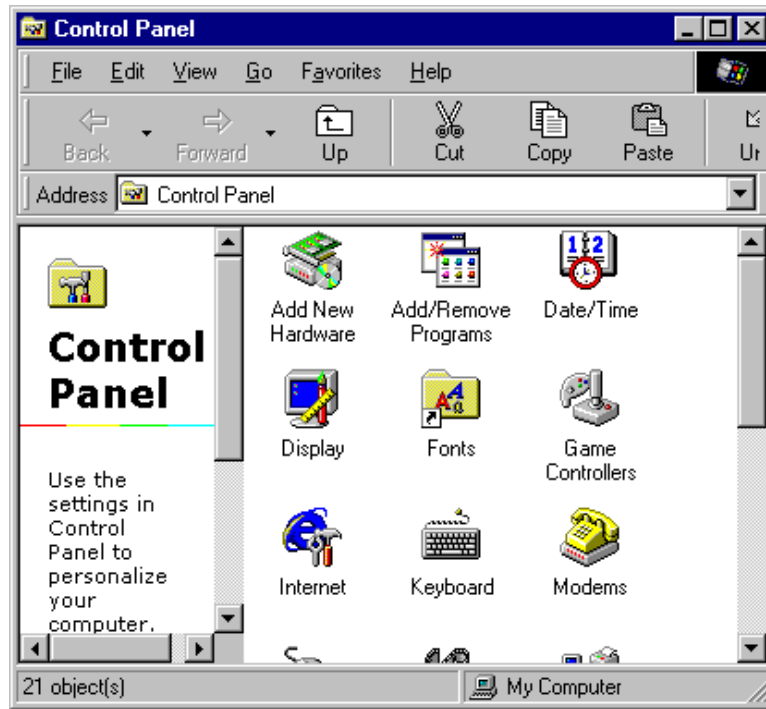

Step 3. Click Settings.

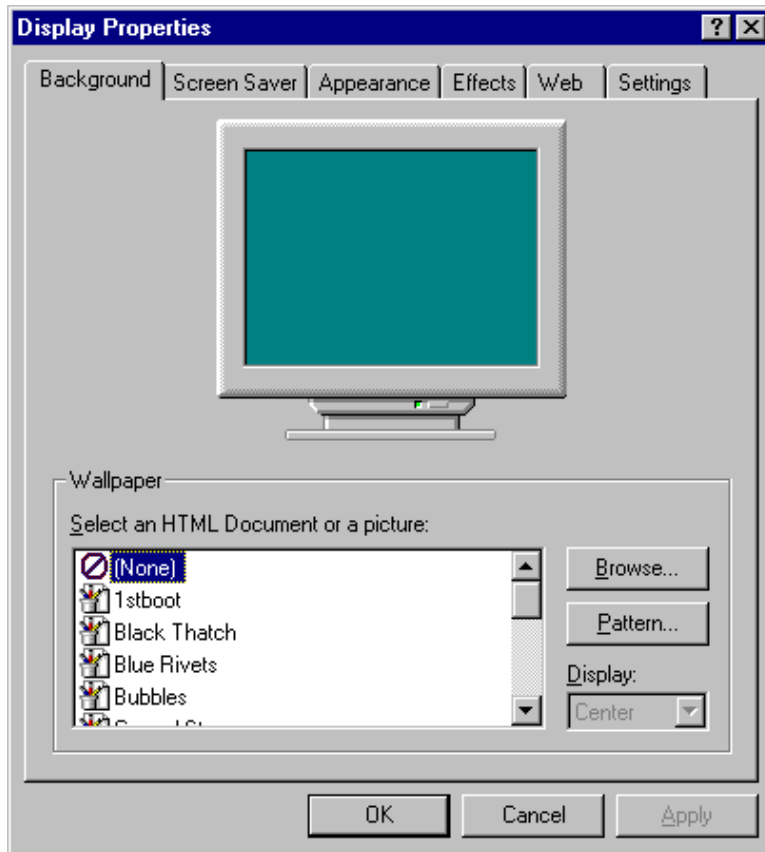

Step 4. Click Advanced.

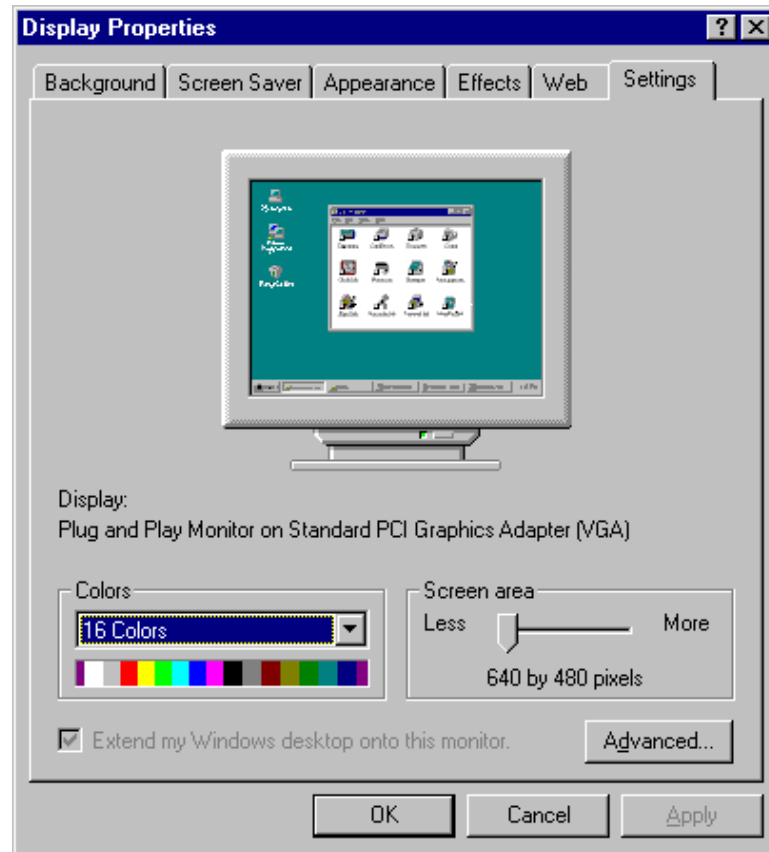

Step 5. Click Adapter.

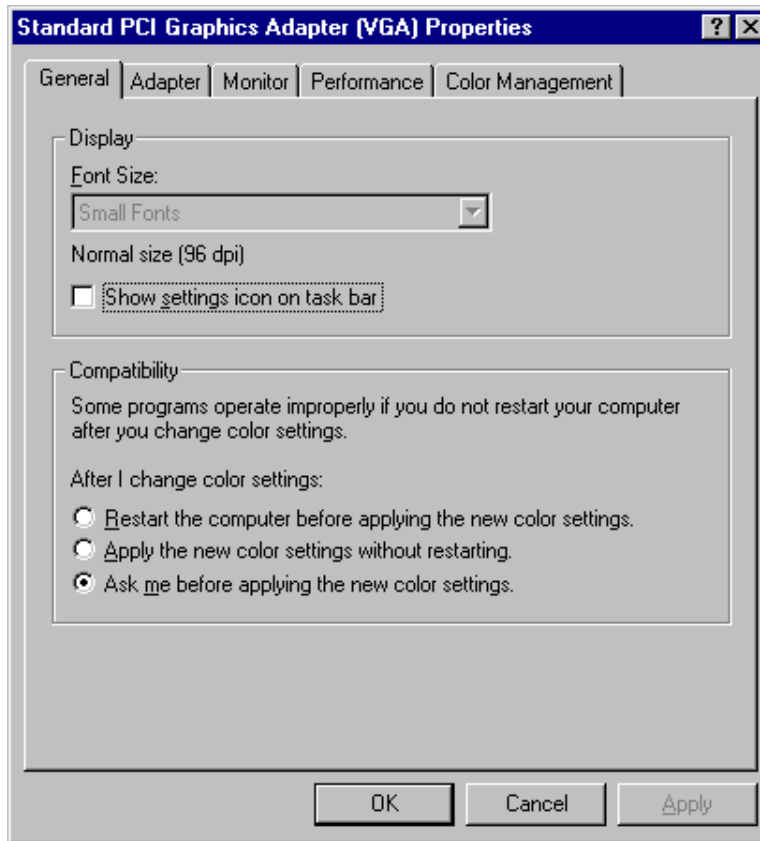

Step 6. Click Change....

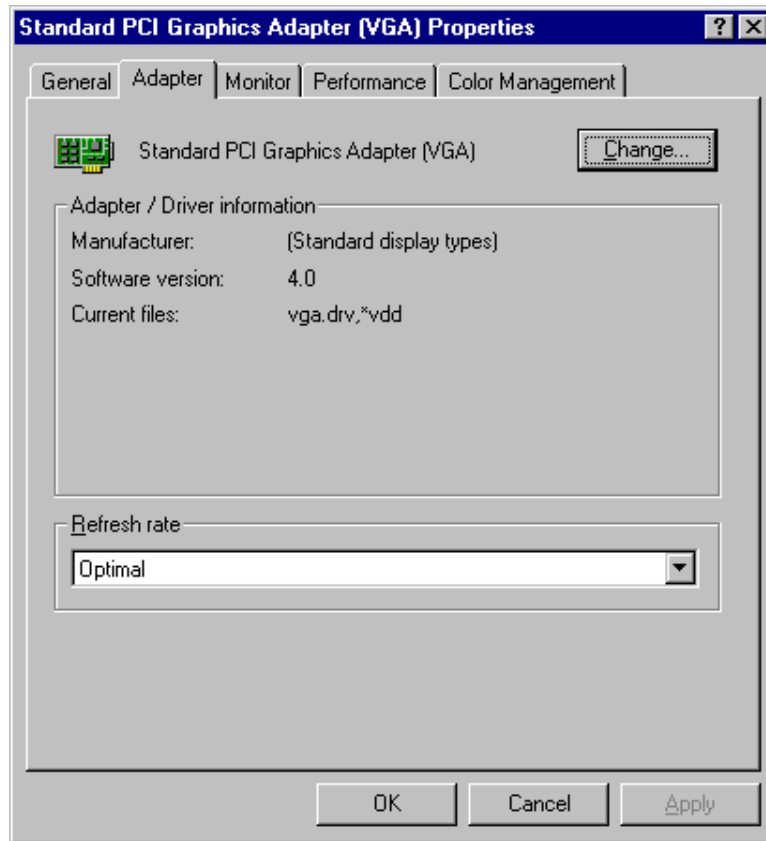

Step 7. Click Next.



Step 8. Select Display a list of all the drivers in a specific location, so you can select the driver you want.



Step 9. Click Have Disk

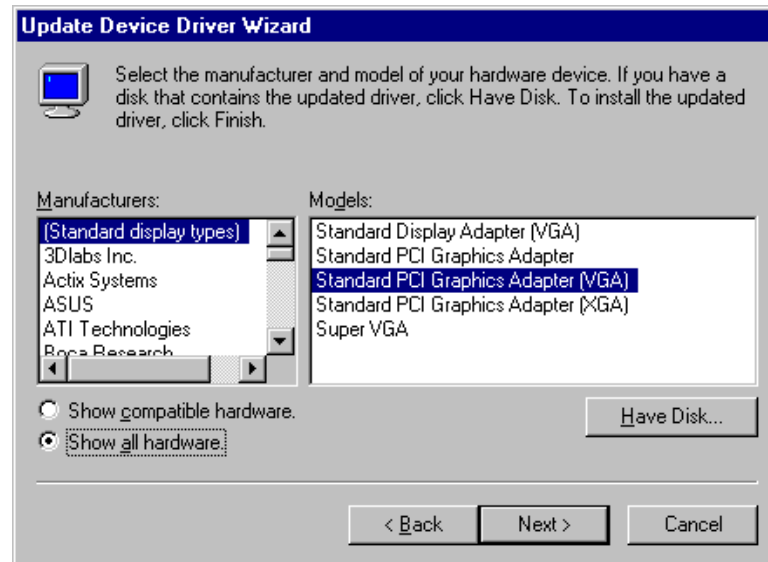

Step 10. If "D:" is your CDROM, type D:\VGA\Trid9520\WIN98, If you are using the floppy disk labeled Trident 9520/25 VGA Driver Windows 95/98, type A:\ and click OK.

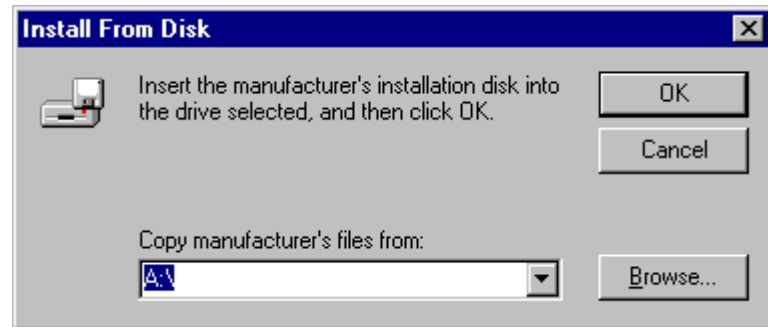

Step 11. Select Trident Cyber 9520/25 PCI/AGP(vx.xx.xxxx.98), then click OK.

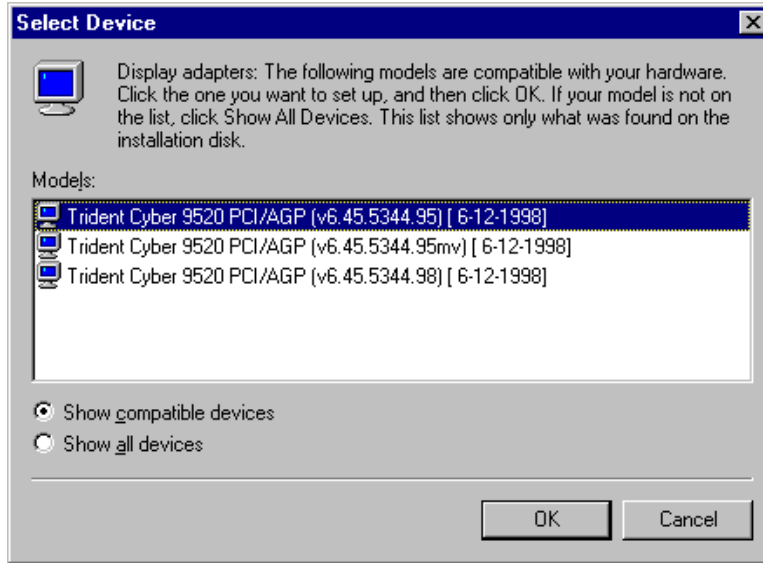

Step 12. Click Next.

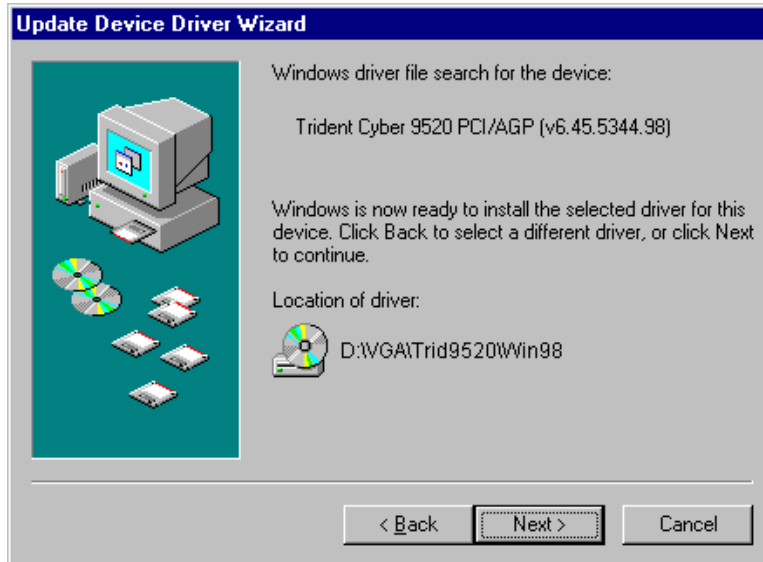

Step 13. After the files are copied, click Finish.



Step 12. Click Close.

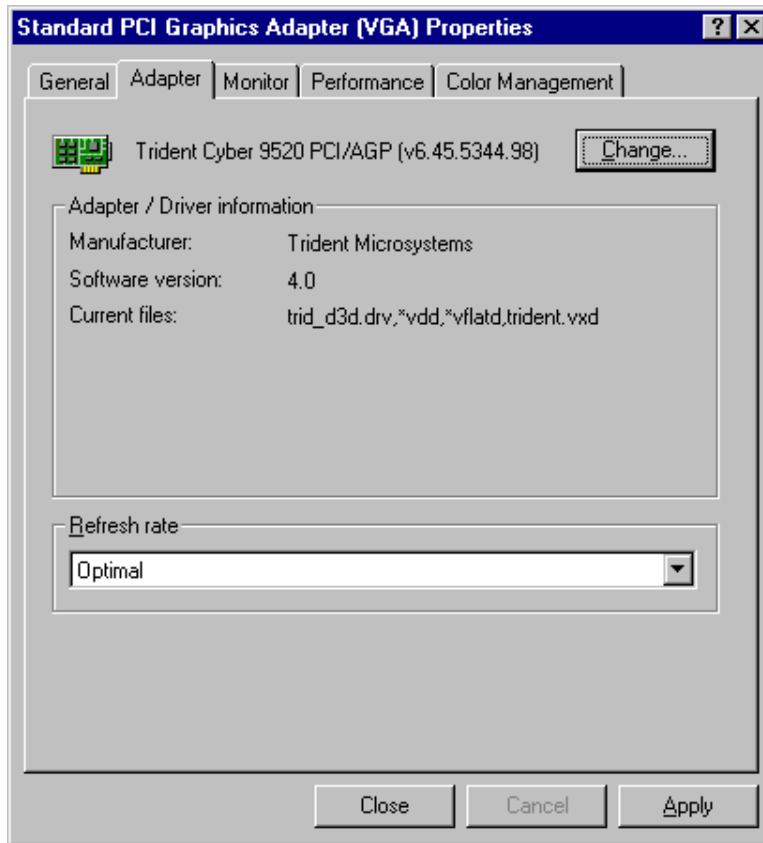

Step 13. Click Close.

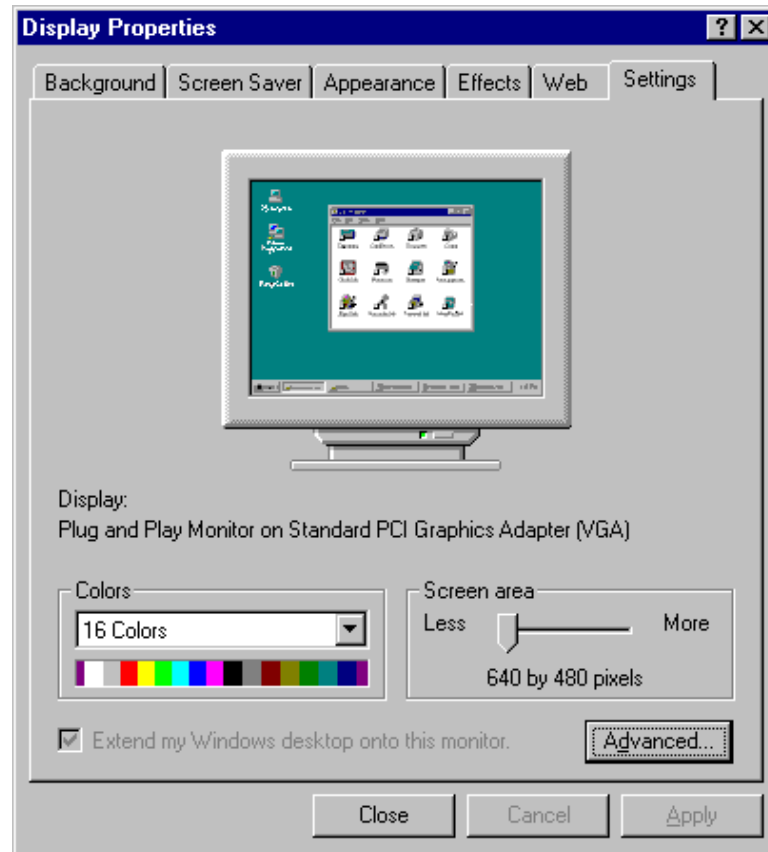

Step 14. Click Yes to restart your computer and for the new settings to take effect.

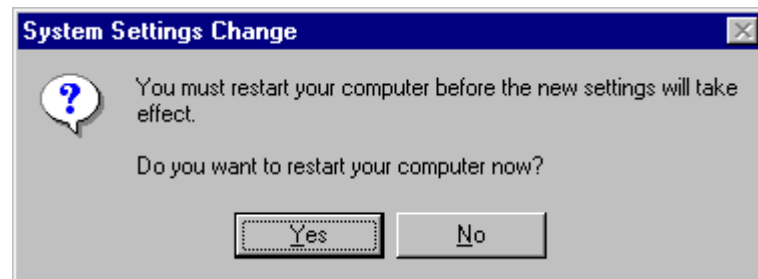

Installing Trident 9520/25 Drivers for Windows NT 4.0

IMPORTANT: You should install the Windows NT 4.0 Service Pack 3 first before installing the Trident 9520/25 VGA drivers. If you don't have the Windows NT 4.0 Service Pack 3, please contact your software vendor or download it from Microsoft's web site.

- Step 1. Boot Windows NT 4.0.
- Step 2. Double click the My Computer icon.
- Step 3. Double click the Control Panel icon.
- Step 4. Double click the Display icon.
- Step 5. Click Change Display Type.
- Step 6. Click Change.
- Step 7. Click Have Disk, then insert the diskette disk labeled Trident 9520/25 VGA Driver Windows NT4.0 or CD containing the Trident 9520/25 VGA Windows NT 4.0 drivers to the floppy disk drive/CD-ROM drive, then type in A:\ (if you are using drive A) or type in D:\VGA\Trid9520\WINNT40 (if you are using drive D which is your CD-ROM drive), and press Enter.
- Step 8. Select Trident Video Accelerator 3D Adapter [TW3001], then click OK.
- Step 9. Click Yes to copy the drivers from the floppy disk/CD to the hard disk.
- Step 10. When copying is done, click OK.
- Step 11. Click Close.
- Step 12. Click OK.
- Step 13. Windows NT 4.0 will prompt you to restart computer. Click OK to change the Windows NT configuration.

6

System Monitor Utility

This chapter introduces System Monitor Utility that comes with the motherboard in conjunction with the onboard hardware monitoring IC. The sections in the following pages give the functions of the utility.

System Monitor is a utility software that oversee the general performance of systems, covering areas like system temperature, system voltage, CPU and system fan rotational speeds. If conditions become adversed, that is, when voltages are erratic or CPU temperature exceeds the safe limits, an alarm will be sounded; thereby preventing system crashing and ensuring overall stability.

NOTE: *System Monitor currently supports English and Chinese under Windows 95/98 and Windows NT. English will be used for other language environments.*

When System Monitor is initiated, the icon below appears in the task bar in the Windows environment.



The following screen appears upon clicking on the System Monitor icon.



Clicking on the upper left corner button would show you the latest company information. "Summary" provides the current system status.

The section below describes the different functions of System Monitor.

1. Computer - displays the current working system version and processor type.

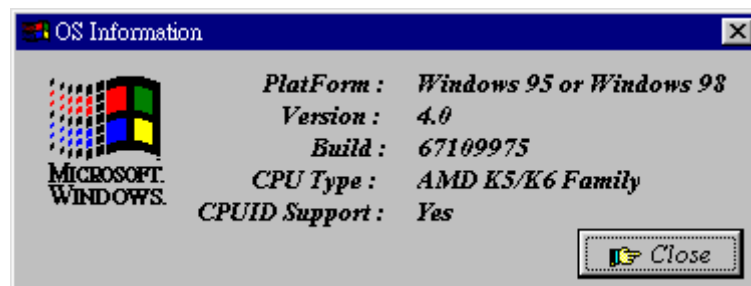

2. Power - displays the current voltage status.

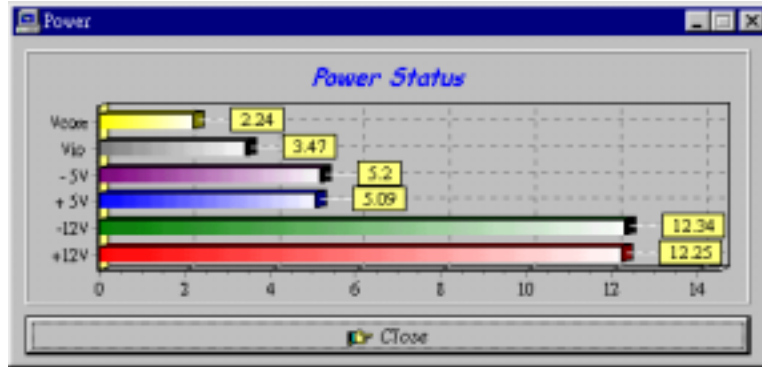

3. Memory - displays the current memory usage status.

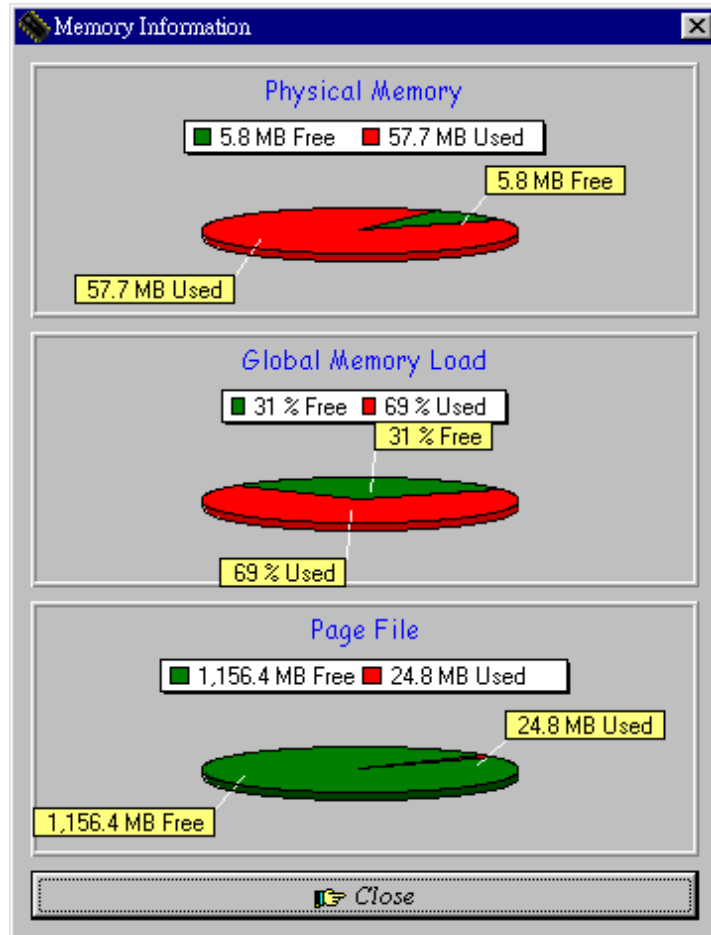

- Fan Speed - displays the current rotational speeds of CPU and chassis fans.

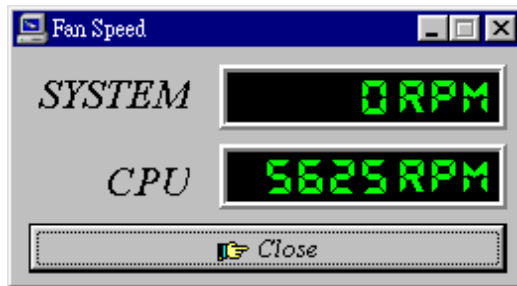

- Disk - displays the disk supported formats and disk space.

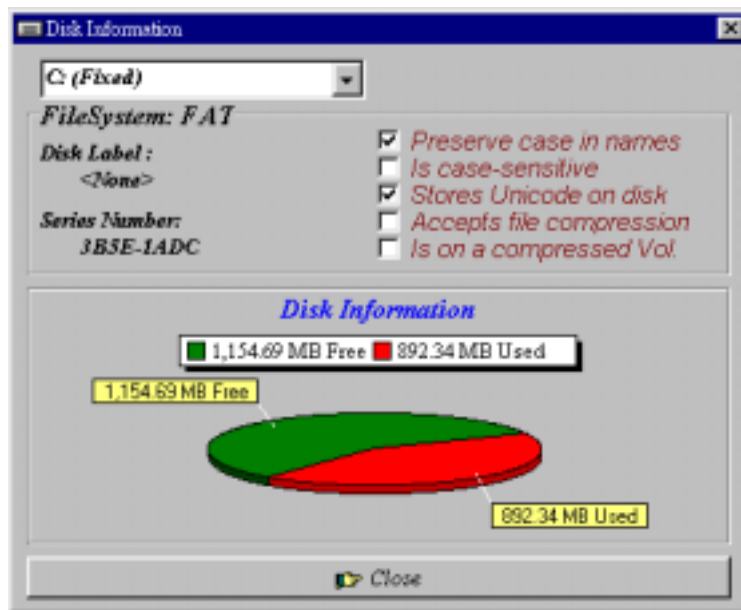

6. Heat - displays the CPU and system temperatures.

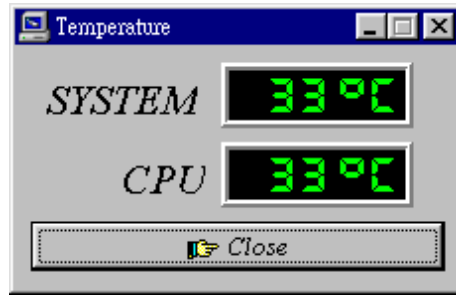

7. Error Log - displays errors occurring after System Monitor is started.

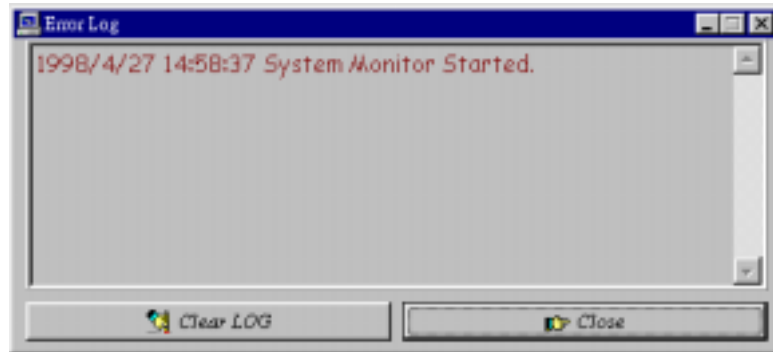

8. Setting - sets the values at which an alarm is sounded.

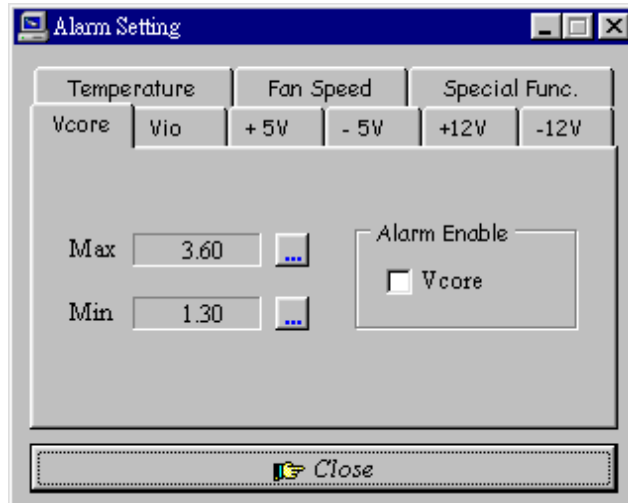

Voltage : the acceptable voltage range between the "MAX" and "MIN" value.

Temperature : temperature threshold.

Fan Rotation Speed : the minimum rotation speed.

NOTE: Intel has defined a margin of difference for the voltages as below:

12 Volts - 10% (10.8V ~ 13.2V)

5 Volts - 5% (4.75 ~ 5.25%)

Vio - 5% (Vio for P54C CPU is 3.5V. Vio for P55C is 3.3V.)

Vcore- 5%

7

LANDesk Client Manager

This chapter gives a brief introduction to the optional LANDesk® Client Manager (LDCM) utility, as well as the installation procedures.

The following items are covered in this chapter:

Introduction	106
Installation	107
Installing the Local Version of LDCM.....	108
Installing the Administrative Version of LDCM	110

Introduction

LANDesk Client Manager provides the capability for managing components (network interface cards, memory, printers, software applications, etc.) within a PC system. It uses the Desktop Management Interface (DMI) standard established by the Desktop Management Task Force (DMTF). Manageable components can be viewed, monitored, and administrated across multiple platforms, either locally or remotely on a network.

The LDCM package has been implemented in two different ways: a user (client/local) version and an administrative version (Remote Companion). The user version provides the ability to only manage the local PC. The administrative version allows a network administrator to manage the local PC and other PC nodes on the network. This means that the administrative version has the ability to gather information about remote PCs, as well as remotely controlling the PCs. The remote access is based upon granted rights by the managed client.

LDCM provides the user with self-help diagnostics, including a PC health meter, local alerting of potential problems, and hardware and software inventory. Automatic polling and alerting of memory and hardware conditions and predictive failure mechanisms minimize downtime and increase effective troubleshooting. LDCM can take periodic “snapshots” of critical configuration files for easy change management and restoration when needed.

To use LDCM, your computer must meet the following requirements:

- Operating System: Windows 95, Windows NT 3.51, or Windows NT4.0
- Memory: about 200KB
- Disk Storage Space: 3-5MB
- Hardware System: a DMI BIOS is required for full LDCM functionality

For network computers, the following requirements also apply:

- Protocols: IPX or IP (WinSock-enabled) communication protocol loaded on the client
- Hardware Interfaces: a network card for communication on the network

Installation

The optional LANDesk utility that comes with the CPU card runs in Windows NT or Windows 95 operating system.

Upon entering the Windows NT 4.0 or Windows 95 environment, insert the CD. Windows will autorun the installation program and show the following screen.

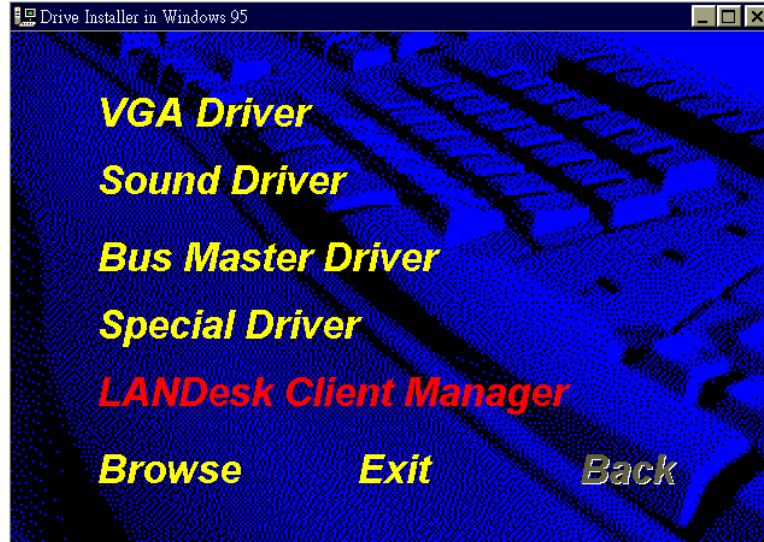

NOTE: During Setup, you will be asked to install Internet Explorer 3.02 in order to continue, or else Setup will be aborted. LDCM supports various languages and will default to English if it is unable to load 'language.dll'..

Installing the Local Version of LDCM

Double Click on 'LANdesk Client Manager' in the initial screen and the following screen will appear. Double click on the local version of LANdesk Client Manager.



When the Welcome screen appears, click on "Next" to continue with Setup.

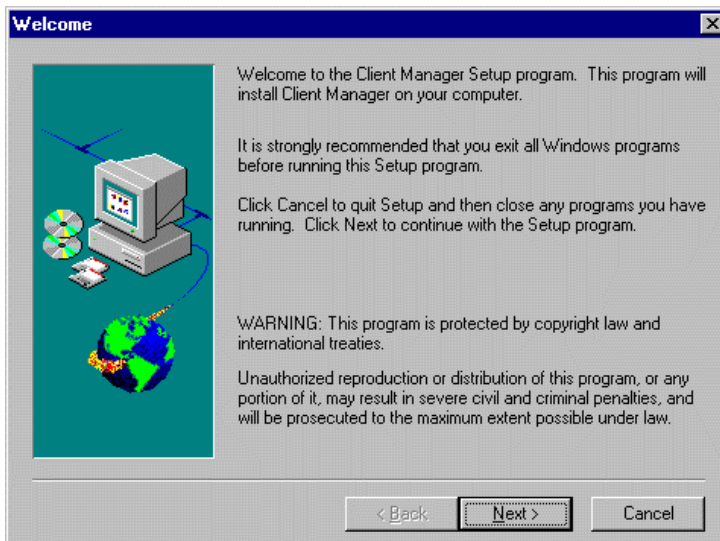

Choose the directory location where Setup will install LANdesk Client Manager. Click "Browse" if you want to change the directory suggested. Otherwise, click "Next" to start installing LDCM.

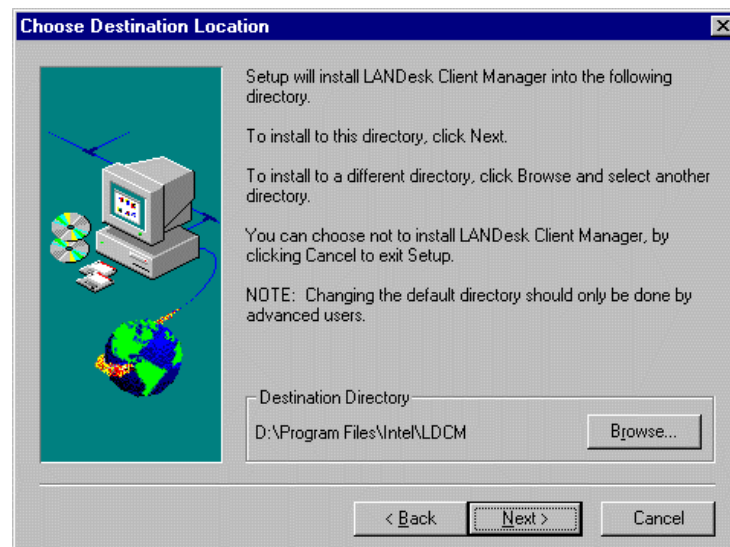

When Setup is finished, changes will have been made to the file AUTOEXEC.BAT. Restart your computer for the changes to take effect.

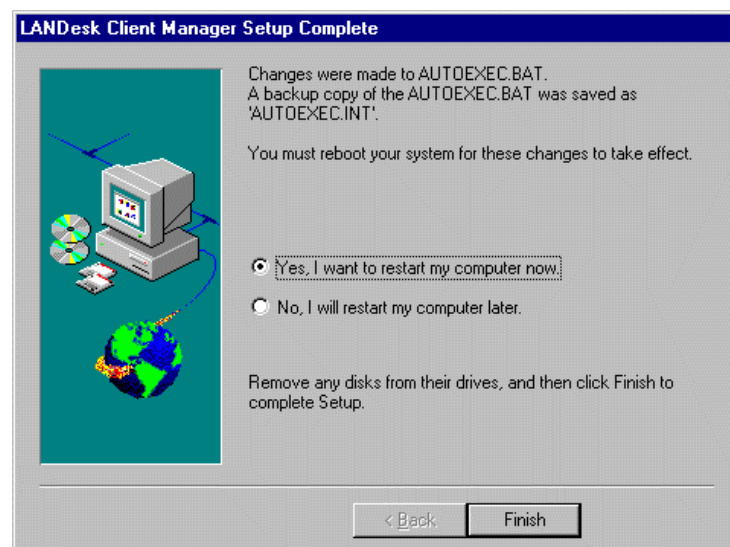

Installing the Administrative Version of LDCM

After double clicking on 'LANdesk Client Manager' in the initial screen, select the administrative version of the LDCM and the Welcome screen below will appear. Click on "Next" to continue.

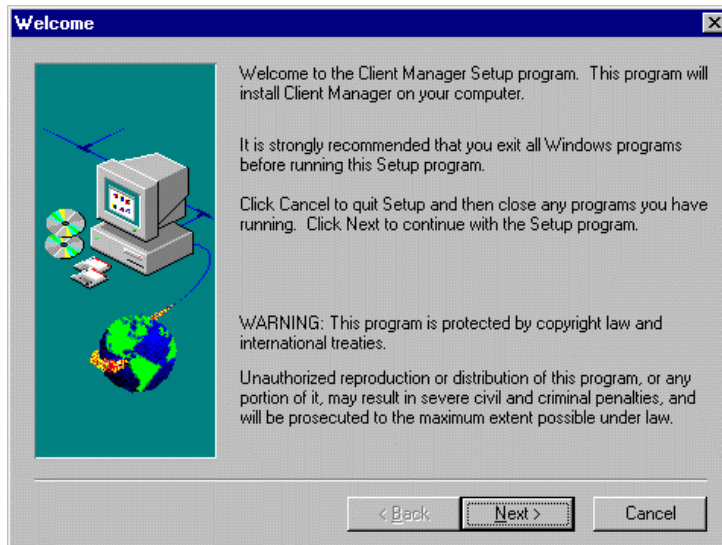

The screen below allows you to install the documentation in Adobe Acrobat format and the Adobe Acrobat Reader software. Select the options you need and click on "Next" to start the installation.

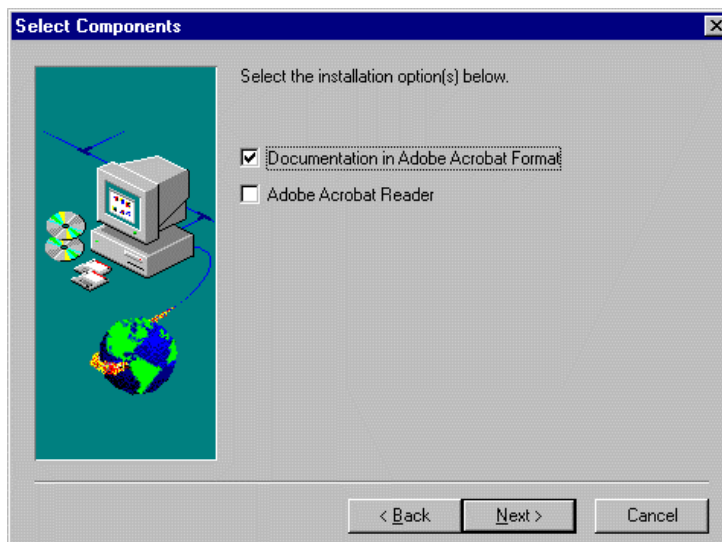

After LANDesk Client Manager Setup is complete, restart your computer to be able to use the LANDesk Client Manager.

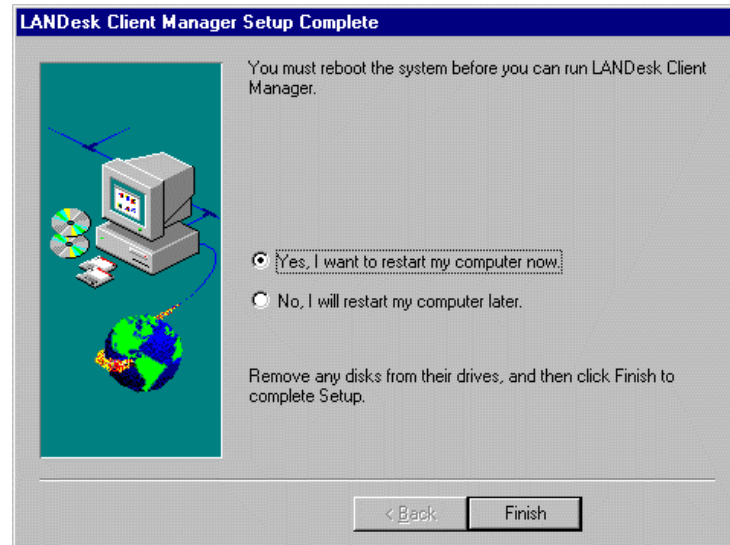

This page is intentionally left blank.

8

Ethernet Setup User's Guide

This chapter gives a brief introduction to the Intel 82558 Fast Ethernet PCI controller.

The following items are covered in this chapter:

Introduction	114
Features	114
Software Drivers Support	114
LAN Driver Installation for Windows 95	113
LAN Driver Installation for Windows NT 4.0.....	121
Running Diagnostics.....	122

Introduction

Intel 82558B is a 32-bit 10/100Mbps Ethernet controller for PCI local bus-compliant PCs. It supports the bus mastering architecture, and Auto-negotiation feature which make it possible to combine one common type of Ethernet cabling – an RJ-45 connector for twisted-pair cabling that can be used for both 10Mbps and 100Mbps connection. Extensive driver support for commonly used network operating systems is also provided.

Features

- Conforms to the Ethernet IEEE 802.3u standard
- Compatible with PCI Local Bus Revision 2.1 specification
- IEEE 802.3u Auto-Negotiation for automatic speed selection
- Supports Full-Duplex/Half-Duplex Operation
- Provides 32-bit bus mastering data transfer
- Supports 10Mbps and 100Mbps operation in a single port
- Supports remote wake-up (Magic Packet*) in APM and ACPI mode

* Requires ATX power supply with 5VSB, 720mA

Software Drivers Support

NetWare ODI Drivers

Novell NetWare 3.x, 4.x, NetWare LAN WorkPlace TCP/IP, Novell LAN Analyzer for NetWare

Packet Drivers

FTP PC/TCP, NCSA TCP/IP

NDIS Drivers

Microsoft LAN Manager V2.x, Windows 3.x, Windows NT 4.0, Windows NT 3.51, Windows 98, Windows 95, SCO3, SCO5; IBM LAN Server 4.0 for DOS and OS/2, and Linux

LAN Driver Installation for Windows 95

The CI5VGM comes with a diskette labeled Intel 82558B LAN Windows 95/98 & Windows NT 4.0 Drivers that is to be used in conjunction with the LAN drivers installation. You must use the correct drivers in order for LAN to function properly. Follow the steps below to install the drivers for Windows 95.

1. Click Start ⇒ Select Settings ⇒ Select Control Panel.

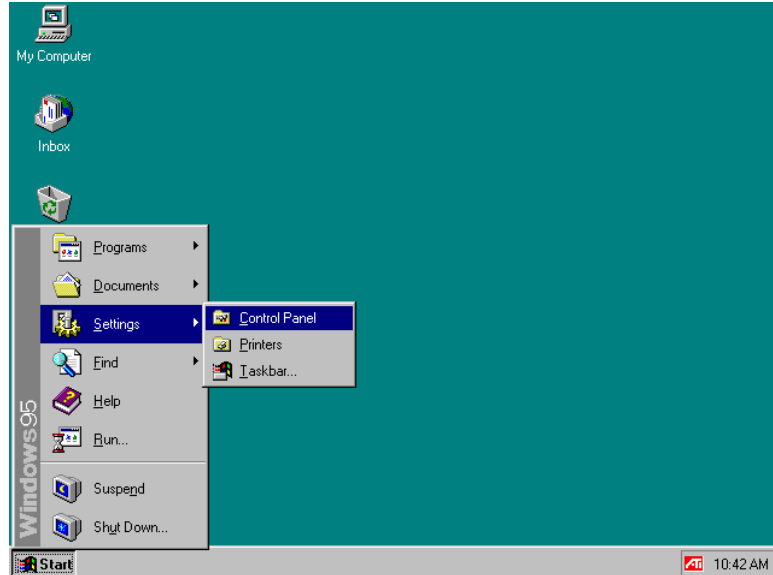

2. Click System.



3. Click Device Manager.

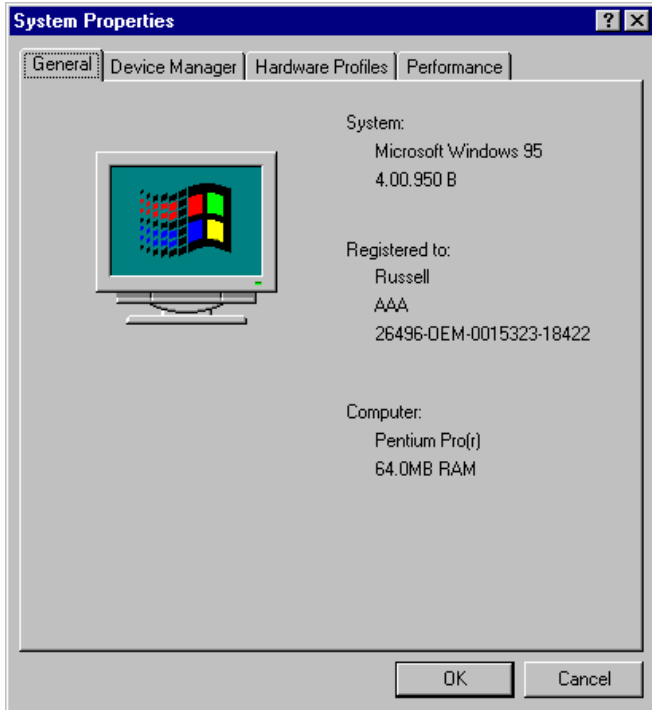

4. Expand Other Devices.

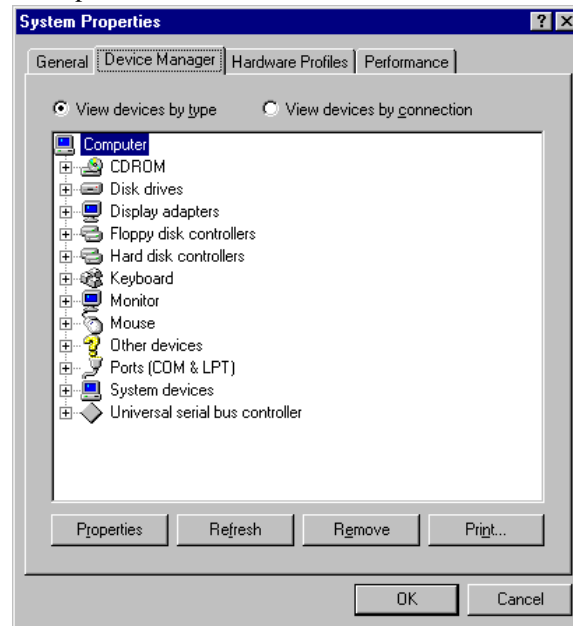

5. Select PCI Ethernet Controller, then click Properties.

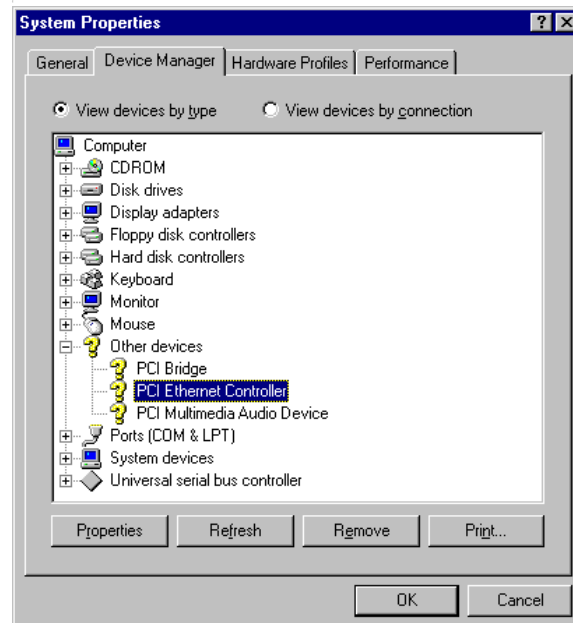

6. Click Driver.

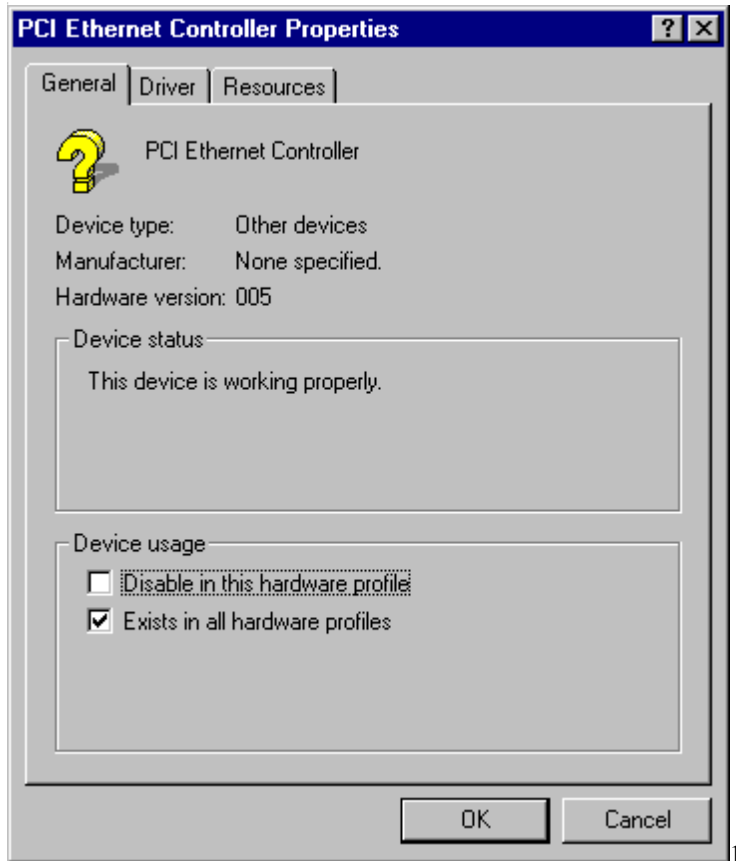

7. Click Update Driver.



8. Insert the diskette labeled Intel 82558B LAN Windows 95/98 & Windows NT 4.0 Drivers into the floppy disk drive, then click Next.



9. Click Finish. Ensure the updated driver mentioned is for Intel 82558 Fast Ethernet.



10. Click OK.



11. Type A:\, then click OK.

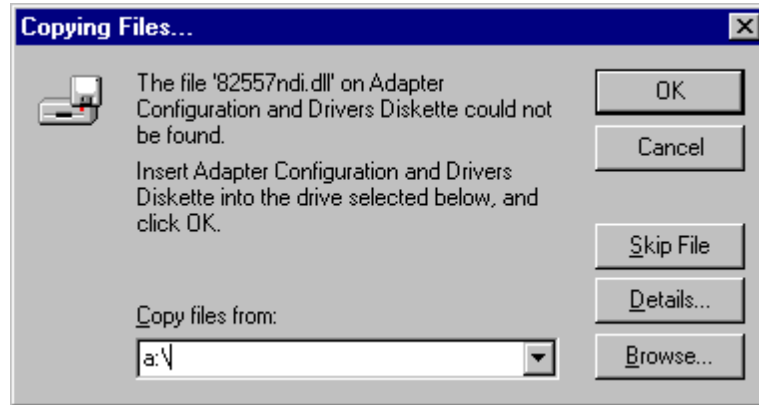

12. Click OK.

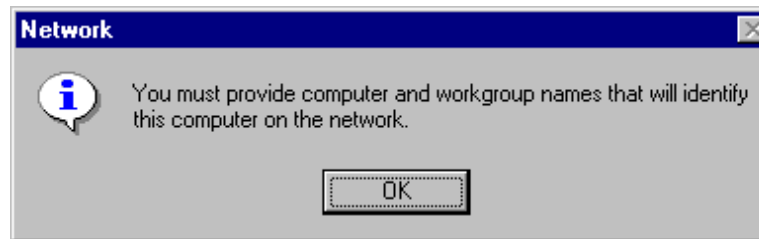

13. Type the *Computer Name* and *Workgroup*, then click Close.

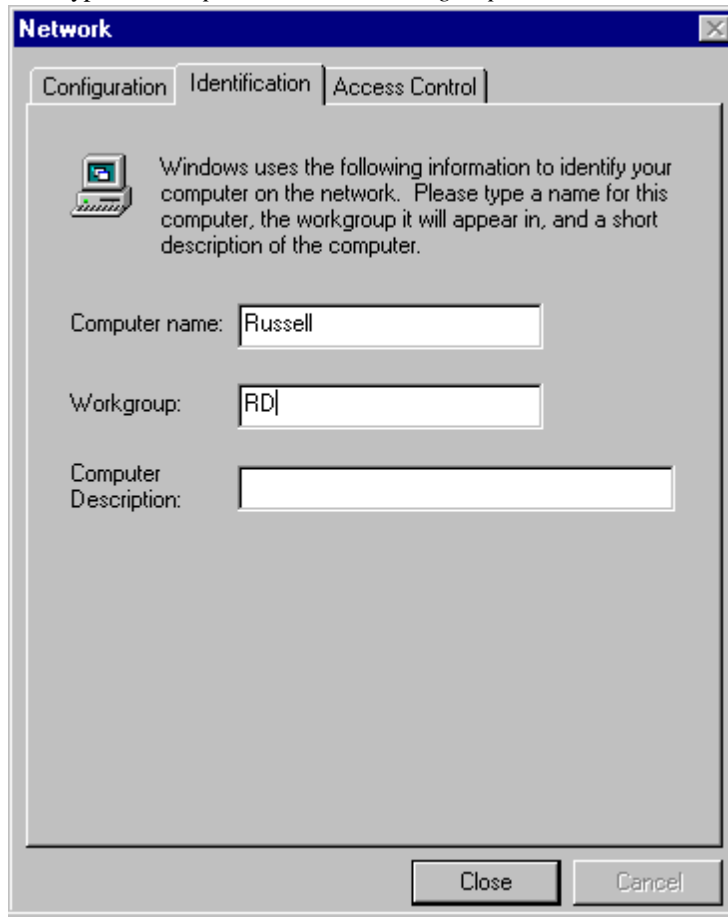

14. Insert the *Windows 95 CD ROM*, then click OK.

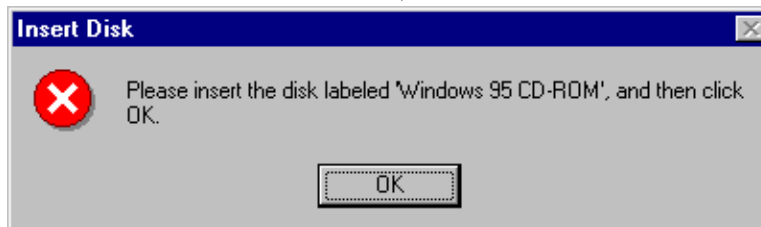

15. Type D:\Win95 (Assuming D:\Win95 is the directory location of the Windows 95 files), then click OK.

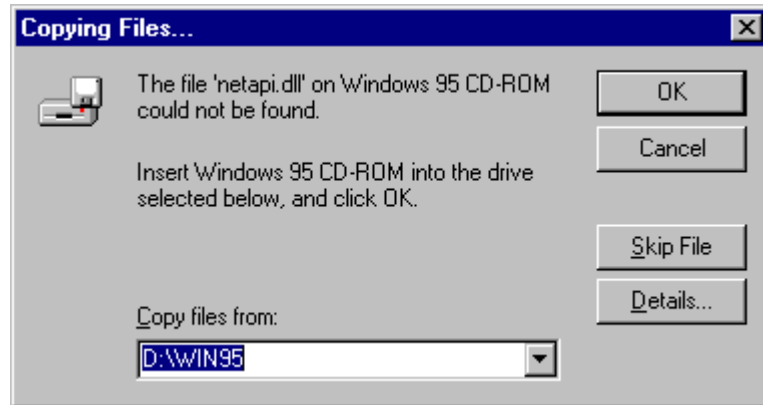

16. Click Yes to restart the computer and for the settings to take effect.

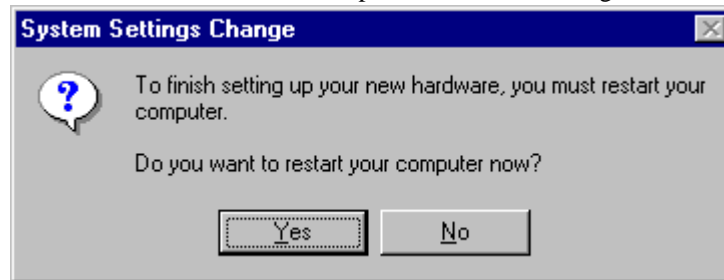

LAN Driver Installation for Windows NT 4.0

The CI5VGM comes with a diskette labeled Intel 82558B LAN Windows 95/98 & Windows NT 4.0 Drivers that is to be used in conjunction of the LAN drivers installation. Follow the steps below to install the drivers for Windows NT 4.0.

1. Click Start ⇒ Settings ⇒ Control Panel.
2. Click Network.
3. Click Yes.
4. Select Wired to the network, then click Next.
5. Click from the list.
6. Click Have Disk.
7. Insert the diskette labeled Intel 82558B LAN Windows 95/98 & Windows NT 4.0 Drivers into the floppy disk drive then click OK.
8. Click OK.
9. Click Next.
10. Select the Protocol that you want then click Next.
11. Select the Network Services then click Next.
12. Click Next.
13. Insert the Windows NT 4.0 CD into the CD-ROM drive. Type d:\ then click Continue.
14. Click OK.
15. Click Next.
16. Click Next.
17. Type your Workgroup then click Next.
18. Click Finish.
19. Click Yes to restart the computer and for the settings to take effect.

Running Diagnostics

The CI5VGM comes with a diskette containing the diagnostic software supporting the Intel 82558B Ethernet controller. Follow the steps below to use the *Setup Utility*.

1. Run the file SETUP.EXE typing a:\setup in the DOS prompt, assuming your floppy disk drive is drive A. Upon doing so, the system starts the *Setup Utility* and shows the following screen.

```

8255x-based PCI EtherExpress™ adapter Setup V4.16
  
```

```

Main Menu
-----
Automatic setup
View adapter configuration
Test adapter
Install network drivers
View Help files
Exit Setup
  
```

Choose AUTOMATIC SETUP to view the adapter's configuration, make sure it works properly, and install the software needed to connect to your network.

Help = F1 Exit = Esc Select = ↑↓ Action = ↵

2. Selecting **View adapter configuration** will show the following.

```

8255x-based PCI EtherExpress™ adapter Setup V4.16
  
```

```

View adapter configuration
-----
Adapter type:.....
Adapter part number:.....
Network address:.....
Interrupt:.....
Bus:.....
Slot:.....
Device:.....
Network speed:.....
Physical layer device:.....
Duplex:.....
Adapter capabilities:
  100BaseTX, full or half duplex.
  10BaseT, full or half duplex.

Press Enter to continue
  
```

Help = F1 Previous = Esc Continue = Enter PCI Advanced = F5

3. Selecting **Test adapter** will show the following screen.

8255x-based PCI EtherExpress™ adapter Setup V4.16

Test adapter

Bus=0 Dev=0Bh Slot=11 Addr=004063001000 IRQ=10

D diagnostic tests:

Adapter tests	Passed
Onboard loopback tests	passed
Network test	passed

10Mbps

This adapter works properly

Press Enter to continue

Help = F1 Press Enter to continue

4. Selecting **Install network drivers** will show the following screen.

8255x-based PCI EtherExpress™ adapter Setup V4.16

Main Menu

Install network drivers

Novel

Microsoft

Other

Exit Setup

Choose OTHER if you use a network operating system from a manufacturer not on this list (such as Banyan or UNIX).

Help = F1 Press Enter to continue

5. Upon selecting **Others** under the **Install network drivers main menu** screen, the following screen will appear.

8255x-based PCI EtherExpress™ adapter Setup V4.16

Other

1. LANtastic 6.0
2. Banyan 6.00 NDIS workstation
3. NDIS 2.x driver notes (OS/2*, LAN Manager* others)
4. Using IBM LAN support for AS/400 and NetWare
5. LAN Server
6. UNIX driver information

Choose OTHER if you use a network operating system from a manufacturer not on this list (such as Banyan or UNIX).

Help = F1 Previous = Esc Select = ↑↓ Accept = ↵

6. Selecting **View Help files** under the **Main menu** will show the following screen.

8255x-based PCI EtherExpress™ adapter Setup V4.16

Main Menu

View Help files

Installing EtherExpress™ PRO/100+ adapter drivers
Latest News and general adapter information
Hardware specifications and cabling information
Adapter installation and special configurations
Running diagnostics and error messages

Help = F1 Previous = Esc Select = ↑↓ Display Choices = ↵

Appendix

A. I/O Port Address Map

B. Interrupt Request Lines (IRQ)

A. I/O Port Address Map

Each peripheral device in the system is assigned a set of I/O port addresses which also becomes the identity of the device. There are a total of 1K port address space available. The following table lists the I/O port addresses used on the Industrial CPU Card.

Address	Device Description
000h - 01Fh	DMA Controller #1
020h - 03Fh	Interrupt Controller #1
040h - 05Fh	Timer
060h - 06Fh	Keyboard Controller
070h - 07Fh	Real Time Clock, NMI
080h - 09Fh	DMA Page Register
0A0h - 0BFh	Interrupt Controller #2
0C0h - 0DFh	DMA Controller #2
0F0h	Clear Math Coprocessor Busy Signal
0F1h	Reset Math Coprocessor
1F0h - 1F7h	IDE Interface
278 - 27F	Parallel Port #2(LPT2)
2F8h - 2FFh	Serial Port #2(COM2)
2B0 - 2DF	Graphics adapter Controller
378h - 3FFh	Parallel Port #1(LPT1)
360 - 36F	Network Ports
3B0 - 3BF	Monochrome & Printer adapter
3C0 - 3CF	EGA adapter
3D0 - 3DF	CGA adapter
3F0h - 3F7h	Floppy Disk Controller
3F8h - 3FFh	Serial Port #1(COM1)

B. Interrupt Request Lines (IRQ)

There are a total of 15 IRQ lines available on the Industrial CPU Card. Peripheral devices use interrupt request lines to notify CPU for the service required. The following table shows the IRQ used by the devices on the Industrial CPU Card.

Level	Function
IRQ0	System Timer Output
IRQ1	Keyboard
IRQ2	Interrupt Cascade
IRQ3	Serial Port #2
IRQ4	Serial Port #1
IRQ5	Parallel Port #2
IRQ6	Floppy Disk Controller
IRQ7	Parallel Port #1
IRQ8	Real Time Clock
IRQ9	Software Redirected to Int 0Ah
IRQ10	Reserved
IRQ11	Reserved
IRQ12	Reserved
IRQ13	80287
IRQ14	Primary IDE
IRQ15	Secondary IDE

Free Manuals Download Website

<http://myh66.com>

<http://usermanuals.us>

<http://www.somanuals.com>

<http://www.4manuals.cc>

<http://www.manual-lib.com>

<http://www.404manual.com>

<http://www.luxmanual.com>

<http://aubethermostatmanual.com>

Golf course search by state

<http://golfingnear.com>

Email search by domain

<http://emailbydomain.com>

Auto manuals search

<http://auto.somanuals.com>

TV manuals search

<http://tv.somanuals.com>