

## **Operator's manual (EPA)**

# **224L**



Please read the operator's manual carefully and make sure you understand the instructions before using the machine.

Lea detenidamente el manual de instrucciones y asegúrese de entender su contenido antes de utilizar la máquina.

Lire attentivement et bien assimiler le manuel d'utilisation avant d'utiliser la machine.

# KEY TO SYMBOLS

## Symbols

**WARNING!** Clearing saws, brushcutters and trimmers can be dangerous! Careless or incorrect use can result in serious or fatal injury to the operator or others. It is extremely important that you read and understand the contents of the operator's manual.



Please read the operator's manual carefully and make sure you understand the instructions before using the machine.



Always wear:

- A protective helmet where there is a risk of falling objects
- Approved hearing protection
- Approved eye protection



Max. speed of output shaft, rpm



This product is in accordance with applicable CE directives.



Watch out for thrown objects and ricochets.



The operator of the machine must ensure, while working, that no persons or animals come closer than 15 metres.



Machines fitted with saw blades or grass blades can be thrown violently to the side when the blade comes into contact with a fixed object. This is called blade thrust. The blade is capable of amputating an arm or leg. Always keep people and animals at least 15 metres from the machine.



Arrows which show limits for handle positioning.



Always wear approved protective gloves.



Wear sturdy, non-slip boots.



Only use non-metallic, flexible cutting attachments, i.e. trimmer heads with trimmer cord.



**Other symbols/decals on the machine refer to special certification requirements for certain markets.**

Switch off the engine by moving the stop switch to the STOP position before carrying out any checks or maintenance.

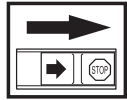

Always wear approved protective gloves.



Regular cleaning is required.

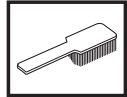

Visual check.



Approved eye protection must always be used.



# CONTENTS

## Contents

### KEY TO SYMBOLS

Symbols ..... 2

### CONTENTS

Contents ..... 3

Note the following before starting: ..... 3

### INTRODUCTION

Dear customer! ..... 4

### WHAT IS WHAT?

What is what? ..... 5

### GENERAL SAFETY PRECAUTIONS

Important ..... 6

Personal protective equipment ..... 6

Machine's safety equipment ..... 7

Cutting equipment ..... 10

### ASSEMBLY

Fitting the loop handle ..... 11

Assembling the cutting equipment ..... 11

### FUEL HANDLING

Fuel handling ..... 13

Fuel ..... 13

### STARTING AND STOPPING

Check before starting ..... 15

Starting and stopping ..... 15

### WORKING TECHNIQUES

General working instructions ..... 17

### MAINTENANCE

Carburetor ..... 19

Muffler ..... 19

Cooling system ..... 20

Spark plug ..... 20

Air filter ..... 20

Maintenance schedule ..... 22

### TECHNICAL DATA

Technical data ..... 23

### FEDERAL AND CALIFORNIA EMISSIONS CONTROL WARRANTY STATEMENT

YOUR WARRANTY RIGHTS AND OBLIGATIONS 24

## Note the following before starting:

Please read the operator's manual carefully.

Maintenance, replacement, or repair of the emission control devices and system may be performed by any nonroad engine repair establishment or individual.



**WARNING!** Long-term exposure to noise can result in permanent hearing impairment. So always use approved hearing protection.



**WARNING!** Under no circumstances may the design of the machine be modified without the permission of the manufacturer. Always use genuine accessories. Non-authorized modifications and/or accessories can result in serious personal injury or the death of the operator or others.

Your warranty may not cover damage or liability caused by the use of non-authorized accessories or replacement parts.



**WARNING!** A clearing saw, brushcutter or trimmer can be dangerous if used incorrectly or carelessly, and can cause serious or fatal injury to the operator or others. It is extremely important that you read and understand the contents of this operator's manual.

Husqvarna

HUSQVARNA AB HUSKVARNA SWEDEN

EMISSIONS CONTROL INFORMATION. THIS ENGINE MEETS US EPA AND CALIFORNIA EXH/EVP REGS FOR [ ] SORE. REFER TO OPERATOR'S MANUAL FOR MAINTENANCE SPECIFICATIONS AND ADJUSTMENTS. EMISSIONS COMPLIANCE PERIOD: [ ]

The Emissions Compliance Period referred to on the Emission Compliance label indicates the number of operating hours for which the engine has been shown to meet Federal and California emissions requirements.

## WARNING

The engine exhaust from this product contains chemical known to the State of California to cause cancer, birth defects or other reproductive harm.

---

# INTRODUCTION

---

## Dear customer!

Congratulations on your choice to buy a Husqvarna product! Husqvarna is based on a tradition that dates back to 1689, when the Swedish King Karl XI ordered the construction of a factory on the banks of the Huskvarna River, for production of muskets. The location was logical, since water power was harnessed from the Huskvarna River to create the water-powered plant. During over 300 years of continuous operation, the Husqvarna factory has produced a lot of different products, from wood stoves to modern kitchen appliances, sewing machines, bicycles, motorcycles etc. In 1956, the first motor driven lawn mowers appeared, followed by chain saws in 1959, and it is within this area Husqvarna is working today.

Today Husqvarna is one of the leading manufacturers in the world of forest and garden products, with quality as our highest priority. We develop, manufacture and market high quality motor driven products for forestry and gardening as well as for building and construction industry.

Your purchase gives you access to professional help with repairs and service whenever this may be necessary. If the retailer who sells your machine is not one of our authorized dealers, ask for the address of your nearest servicing dealer.

It is our wish that you will be satisfied with your product and that it will be your companion for a long time. Think of this operator's manual as a valuable document. By following its' content (using, service, maintenance etc) the life span and the second-hand value of the machine can be extended. If you ever lend or sell this machine, make sure that the borrower or buyer gets the operator's manual, so they will also know how to properly maintain and use it.

Thank you for using a Husqvarna product.

Husqvarna AB has a policy of continuous product development and therefore reserves the right to modify the design and appearance of products without prior notice.

For customer assistance, contact us at our website: [www.usa.husqvarna.com](http://www.usa.husqvarna.com)

# WHAT IS WHAT?

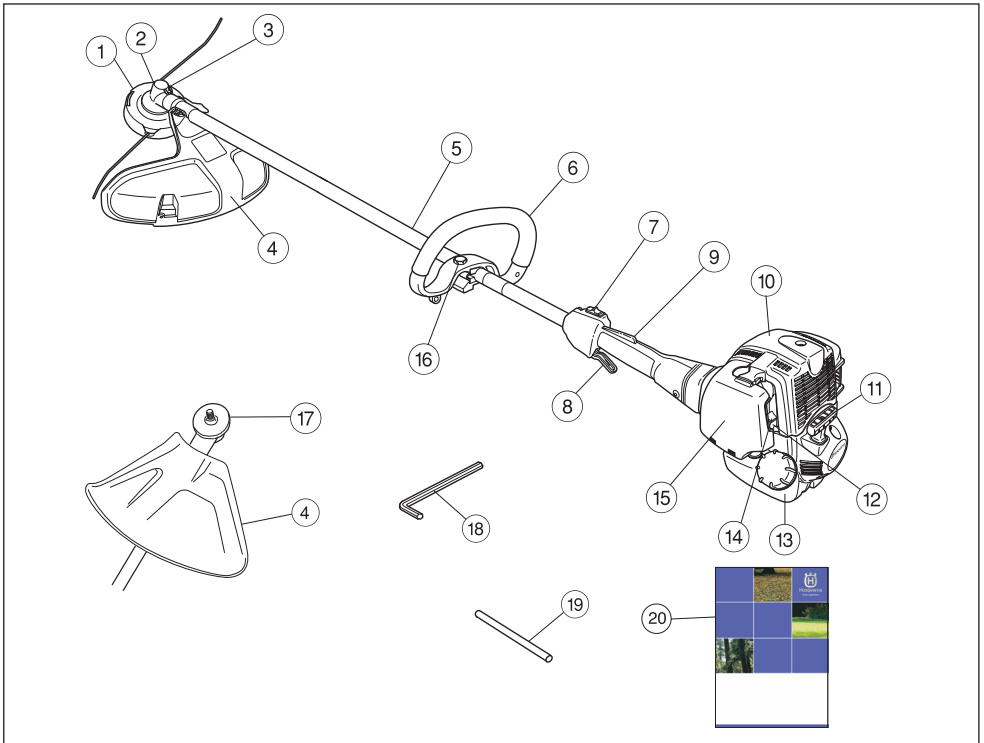

## What is what?

- |                                 |                      |
|---------------------------------|----------------------|
| 1 Trimmer head                  | 11 Starter handle    |
| 2 Bevel gear                    | 12 Air purge         |
| 3 Grease filler cap, bevel gear | 13 Fuel tank         |
| 4 Cutting attachment guard      | 14 Choke control     |
| 5 Shaft                         | 15 Air filter cover  |
| 6 Loop handle                   | 16 Handle adjustment |
| 7 Stop switch                   | 17 Drive disc        |
| 8 Throttle control              | 18 Allen key         |
| 9 Throttle lockout              | 19 Locking pin       |
| 10 Cylinder cover               | 20 Operator's manual |

# GENERAL SAFETY PRECAUTIONS

## Important

### IMPORTANT!

The machine is only designed for trimming grass.

The only accessories you can operate with this engine unit are the cutting attachments we recommend in the chapter on Technical data.

Never use the machine if you are tired, if you have drunk alcohol, or if you are taking medication that could affect your vision, your judgement or your co-ordination.

Wear personal protective equipment. See instructions under the heading Personal protective equipment.

Never use a machine that has been modified in any way from its original specification.

Never use a machine that is faulty. Carry out the checks, maintenance and service instructions described in this manual. Some maintenance and service measures must be carried out by trained and qualified specialists. See instructions under the heading Maintenance.

All covers, guards and handles must be fitted before starting. Ensure that the spark plug cap and ignition lead are undamaged to avoid the risk of electric shock.

The machine operator must ensure that no people or animals come closer than 15 metres while working. When several operators are working in the same area the safety distance should be at least twice the tree height and no less than 15 metres.



**WARNING! The ignition system of this machine produces an electromagnetic field during operation. This field may under some circumstances interfere with pacemakers. To reduce the risk of serious or fatal injury, we recommend persons with pacemakers to consult their physician and the pacemaker manufacturer before operating this machine.**



**WARNING! Running an engine in a confined or badly ventilated area can result in death due to asphyxiation or carbon monoxide poisoning.**

## Personal protective equipment

### IMPORTANT!

A clearing saw, brushcutter or trimmer can be dangerous if used incorrectly or carelessly, and can cause serious or fatal injury to the operator or others. It is extremely important that you read and understand the contents of this operator's manual.

You must use approved personal protective equipment whenever you use the machine. Personal protective equipment cannot eliminate the risk of injury but it will reduce the degree of injury if an accident does happen. Ask your dealer for help in choosing the right equipment.



**WARNING! Listen out for warning signals or shouts when you are wearing hearing protection. Always remove your hearing protection as soon as the engine stops.**

### HEARING PROTECTION

Wear hearing protection that provides adequate noise reduction.



### EYE PROTECTION

Always wear approved eye protection. If you use a visor then you must also wear approved protective goggles. Approved protective goggles must comply with standard ANSI Z87.1 in the USA or EN 166 in EU countries.



### GLOVES

Gloves should be worn when necessary, e.g., when fitting cutting attachments.



### BOOTS

Wear sturdy, non-slip boots.



# GENERAL SAFETY PRECAUTIONS

## CLOTHING

Wear clothes made of a strong fabric and avoid loose clothing that can catch on twigs and branches. Always wear heavy, long pants. Do not wear jewellery, shorts sandals or go barefoot. Secure hair so it is above shoulder level.

## FIRST AID KIT

Always have a first aid kit nearby.



## Machine's safety equipment

This section describes the machine's safety equipment, its purpose, and how checks and maintenance should be carried out to ensure that it operates correctly. See the "What is what?" section to locate where this equipment is positioned on your machine.

The life span of the machine can be reduced and the risk of accidents can increase if machine maintenance is not carried out correctly and if service and/or repairs are not carried out professionally. If you need further information please contact your nearest servicing dealer.

### IMPORTANT!

All servicing and repair work on the machine requires special training. This is especially true of the machine's safety equipment. If your machine fails any of the checks described below you must contact your service agent. When you buy any of our products we guarantee the availability of professional repairs and service. If the retailer who sells your machine is not a servicing dealer, ask him for the address of your nearest service agent.



**WARNING! Never use a machine with faulty safety equipment. The machine's safety equipment must be checked and maintained as described in this section. If your machine fails any of these checks contact your service agent to get it repaired.**

## Throttle lockout

The throttle lockout is designed to prevent accidental operation of the throttle control. When you press the lock (A) (i.e. when you grasp the handle) it releases the throttle control (B). When you release the handle the throttle control and the throttle lockout both move back to their original positions. This movement is controlled by two independent return springs. This arrangement means that

the throttle control is automatically locked at the idle setting.

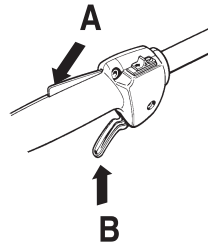

Make sure the throttle control is locked at the idle setting when the throttle lockout is released.

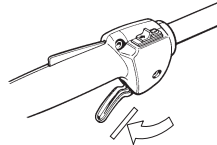

Press the throttle lockout and make sure it returns to its original position when you release it.

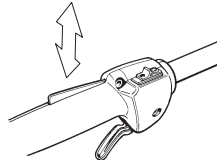

Check that the throttle control and throttle lockout move freely and that the return springs work properly.

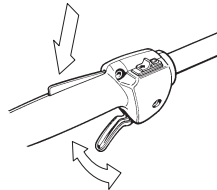

See instructions under the heading Start. Start the machine and apply full throttle. Release the throttle and check that the cutting attachment stops and remains at a standstill. If the cutting attachment rotates with the throttle in the idle position then the carburettor idle setting must

# GENERAL SAFETY PRECAUTIONS

be checked. See instructions under the heading Maintenance.

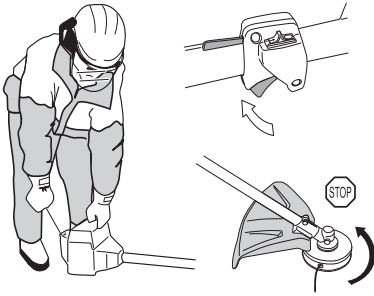

## Stop switch

Use the stop switch to switch off the engine.

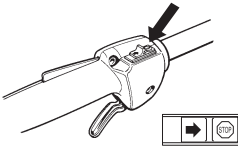

Start the engine and make sure the engine stops when you move the stop switch to the stop setting.

## Cutting attachment guard



This guard is intended to prevent loose objects from being thrown towards the operator. The guard also protects the operator from accidental contact with the cutting attachment.

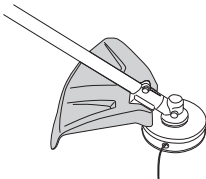

Check that the guard is undamaged and not cracked. Replace the guard if it has been exposed to impact or is cracked.

Always use the recommended guard for the cutting attachment you are using. See chapter on Technical data.



**WARNING! Never use a cutting attachment without an approved guard. See the chapter on Technical data. If an incorrect or faulty guard is fitted this can cause serious personal injury.**

## Vibration damping system



Your machine is equipped with a vibration damping system that is designed to reduce vibration and make operation easier.

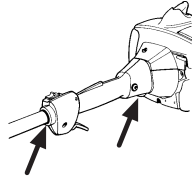

Use of incorrectly wound cord or an incorrect cutting attachment increases the level of vibration. See instructions under the heading Cutting equipment.

The machine's vibration damping system reduces the transfer of vibration between the engine unit/cutting equipment and the machine's handle unit.



Regularly check the vibration damping units for cracks or deformation. Check that the vibration damping element is undamaged and securely attached.



**WARNING! Overexposure to vibration can lead to circulatory damage or nerve damage in people who have impaired circulation. Contact your doctor if you experience symptoms of overexposure to vibration. Such symptoms include numbness, loss of feeling, tingling, pricking, pain, loss of strength, changes in skin colour or condition. These symptoms normally appear in the fingers, hands or wrists. The risk increases at low temperatures.**

## Muffler



The muffler is designed to keep noise levels to a minimum and to direct exhaust fumes away from the user. A muffler fitted with a catalytic converter is also designed to reduce harmful exhaust gases.





# GENERAL SAFETY PRECAUTIONS

In countries that have a warm and dry climate there is a significant risk of fire. We therefore fit certain mufflers with a spark arrestor screen. Check whether the muffler on your machine is fitted with this kind of screen.

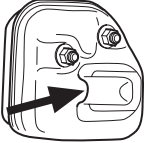

For mufflers it is very important that you follow the instructions on checking, maintaining and servicing your machine.

Never use a machine that has a faulty muffler.



Regularly check that the muffler is securely attached to the machine.

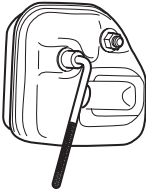

If the muffler on your machine is fitted with a spark arrestor screen this must be cleaned regularly. A blocked screen will cause the engine to overheat and may lead to serious damage.

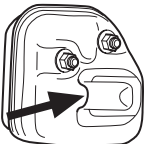

**WARNING! Mufflers fitted with catalytic converters get very hot during use and remain so for some time after stopping. This also applies at idle speed. Contact can result in burns to the skin. Remember the risk of fire!**



**WARNING! The inside of the muffler contain chemicals that may be carcinogenic. Avoid contact with these elements in the event of a damaged muffler.**



**WARNING! Bear in mind that: The exhaust fumes from the engine are hot and may contain sparks which can start a fire. Never start the machine indoors or near combustible material!**

## Locking nut



A locking nut is used to secure some types of cutting attachment.

When fitting, tighten the nut in the opposite direction to the direction of rotation of the cutting attachment. To remove it, undo the nut in the same direction as the cutting attachment rotates. (CAUTION! The nut has a left-hand thread.)

When loosening and tightening the saw blade nut, there is a risk of injury from the teeth of the saw blade. You should therefore always ensure that your hand is shielded by the blade guard when doing this. Always use a socket spanner with a shaft that is long enough to allow this. The arrow in the diagram shows the area where you should operate the socket spanner when loosening or tightening the nut.

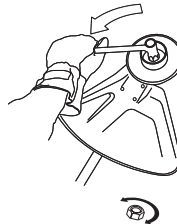

The nylon lining inside the locking nut must not be so worn that you can turn it by hand. The lining should offer a resistance of at least 1.5 Nm. The nut should be replaced after it has been put on approx. 10 times.

# GENERAL SAFETY PRECAUTIONS

## Cutting equipment

This section describes how to choose and maintain your cutting equipment in order to:

- Reduce the risk of blade thrust.
- Obtain maximum cutting performance.
- Extend the life of cutting equipment.

### IMPORTANT!

Only use cutting attachments with the guards we recommend! See the chapter on Technical data.

Refer to the instructions for the cutting attachment to check the correct way to load the cord and the correct cord diameter.



**WARNING! Always stop the engine before doing any work on the cutting attachment. This continues to rotate even after the throttle has been released. Ensure that the cutting attachment has stopped completely and disconnect the HT lead from the spark plug before you start to work on it.**



**WARNING! A faulty cutting attachment may increase the risk of accidents.**

## Trimmer head

### IMPORTANT!

Always ensure the trimmer cord is wound tightly and evenly around the drum, otherwise the machine will generate harmful vibration.

- Only use the recommended trimmer heads and trimmer cords. These have been tested by the manufacturer to suit a particular engine size. This is especially important when a fully automatic trimmer head is used. Only use the recommended cutting attachment. See the chapter on Technical data.



- Smaller machines generally require small trimmer heads and vice versa. This is because when clearing using a cord the engine must throw out the cord radially from the trimmer head and overcome the resistance of the grass being cleared.
- The length of the cord is also important. A longer cord requires greater engine power than a shorter cord of the same diameter.
- Make sure that the cutter on the trimmer guard is intact. This is used to cut the cord to the correct length.
- To increase the life of the cord it can be soaked in water for a couple of days. This will make the line tougher so that it lasts longer.

# ASSEMBLY

## Fitting the loop handle



- Clip the loop handle onto the shaft. Note that the loop handle must be fitted between the arrows on the shaft.

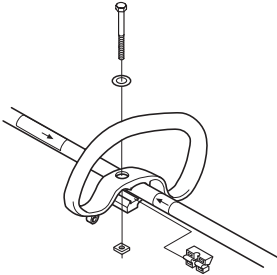

- Slide the spacer into the slot in the loop handle.
- Fit the nut, washer and screw. Do not overtighten.
- Now adjust the trimmer to give a comfortable working position. Tighten the screw.

## Assembling the cutting equipment



### WARNING!

When fitting the cutting attachment it is extremely important that the raised section on the drive disc/support flange engages correctly in the centre hole of the cutting attachment. If the cutting attachment is fitted incorrectly it can result in serious and/or fatal personal injury.

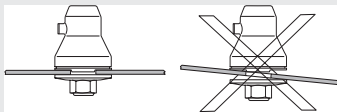

**WARNING!** Never use a cutting attachment without an approved guard. See the chapter on Technical data. If an incorrect or faulty guard is fitted this can cause serious personal injury.

## Fitting a trimmer guard and Superauto II 1" trimmer head

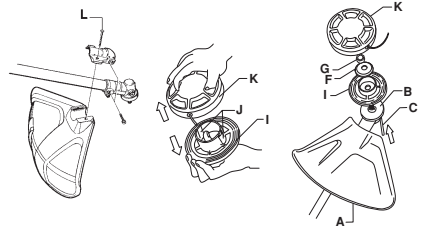

- Fit the correct trimmer guard (A) for use with the trimmer head. Hook the guard onto the fitting on the shaft and secure it with the bolt (L).
- Fit the drive disc (B) on the output shaft.
- Turn the blade shaft until one of the holes in the drive disc aligns with the corresponding hole in the gear housing.
- Insert the locking pin (C) in the hole to lock the shaft.
- To fit the trimmer head, first separate the two halves (see diagram). Proceed as follows:
  - Insert a finger into the centre hole of the cover (I) while grasping the cover with your other fingers. Using the index finger and thumb of your other hand, release the two catches (J) that engage in the cut-outs in the bottom half (K). Pull apart the trimmer head, grasping the cover firmly.
- Place the cover (I) and the support flange (F) on the output shaft. Ensure that the drive disc's guide locates correctly in the cover's centre hole.
- Fit the nut (G). The nut must be tightened to a torque of 35-50 Nm (3.5-5 kpm). Use the socket spanner in the tool kit. Hold the shaft of the spanner as close to the blade guard as possible. To tighten the nut, turn the spanner in the opposite direction to the direction of rotation (Caution! left-hand thread).

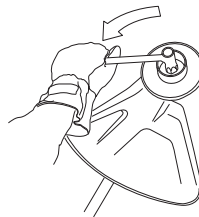

# ASSEMBLY

- Fit the bottom half of the trimmer head (K) to the cover (I) by pressing them together, with the cut-outs on the bottom half aligned with the catches on the cover.

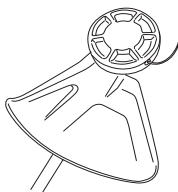

- To dismantle, follow the instructions in the reverse order.

## Fitting other guards and cutting attachments



- Fit the correct trimmer guard (A) for use with the trimmer head. Hook the trimmer guard/combination guard onto the fitting on the shaft and secure with the bolt (L).

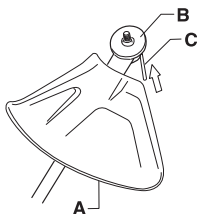
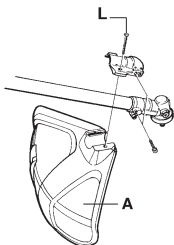

- Fit the disc (B) on the output shaft.
- Turn the blade shaft until one of the holes in the drive disc aligns with the corresponding hole in the gear housing.
- Insert the locking pin (C) in the hole to lock the shaft.
- Screw on the trimmer head/plastic blades (H) in the opposite direction to the direction of rotation.

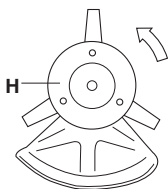
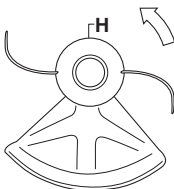

- To dismantle, follow the instructions in the reverse order.

# FUEL HANDLING

## Fuel handling

Never start the machine:

- 1 If you have spilled fuel on it. Wipe off the spillage and allow remaining fuel to evaporate.
- 2 If you have spilled fuel on yourself or your clothes, change your clothes. Wash any part of your body that has come in contact with fuel. Use soap and water.
- 3 If the machine is leaking fuel. Check regularly for leaks from the fuel cap and fuel lines.

## Transport and storage

- Store and transport the machine and fuel so that there is no risk of any leakage or fumes coming into contact with sparks or naked flames, for example, from electrical machinery, electric motors, electrical relays/ switches or boilers.
- When storing and transporting fuel always use approved containers intended for this purpose.
- When storing the machine for long periods the fuel tank must be emptied. Contact your local gas station to find out where to dispose of excess fuel.
- The transport guard must always be fitted to the cutting attachment when the machine is being transported or in storage.
- Ensure the machine is cleaned and that a complete service is carried out before long-term storage.



**WARNING! Take care when handling fuel. Bear in mind the risk of fire, explosion and inhaling fumes.**

## Fuel



**CAUTION!** The machine is equipped with a four-stroke engine. Make sure that there is always sufficient oil in the oil tank.



**WARNING! Fuel and fuel fumes are highly inflammable and can cause serious injury when inhaled or allowed to come in contact with the skin. For this reason observe caution when handling fuel and make sure there is adequate ventilation.**



**WARNING! The catalytic converter muffler gets very hot during and after use. This also applies during idling. Be aware of the fire hazard, especially when working near flammable substances and/ or vapours.**

## Gasoline

Always use an unleaded quality petrol of at least 90 octane (RON).

Use low-emission gasoline, also known as alkylate gasoline, if it is available.

- The lowest recommended octane grade is 87 ((RON+MON)/2). If you run the engine on a lower octane grade than 87 so-called knocking can occur. This gives rise to a high engine temperature and increased bearing load, which can result in serious engine damage.
- When working at continuous high revs a higher octane rating is recommended.
- If the machine is not used for some time the fuel tank should be emptied and cleaned.

## Engine oil

Check the oil level before starting the machine. A too low oil level can cause serious damage to the engine.

When the machine is new the engine oil should be changed after the first month or after 10 hours of operation.

- For the best result and function use HUSQVARNA engine oil.
- When HUSQVARNA engine oil is not available another high grade engine oil can be used. Contact your dealer when selecting oil. Engine oil for four-stroke petrol engines must be used. Quality class at least API SG. In general viscosity class SAE 10W-40 is recommended.
- Never use oil intended for two-stroke engines.

## Oil level

The machine must be switched off and placed on a flat surface when you check the oil level.

Unscrew the oil cap, clean the dipstick located on the cap and insert the cap again without screwing it down. Check the oil level on the dipstick.

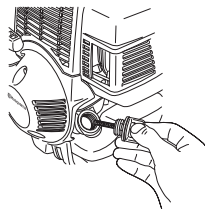

## FUEL HANDLING

When the oil level is low, top up using engine oil to the edge of the oil refill hole.

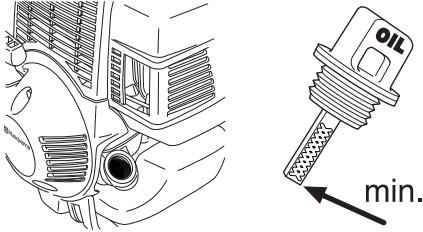

Only use recommended engine oil.

### Fueling



**WARNING!** Taking the following precautions, will lessen the risk of fire:

**Do not smoke or place hot objects near fuel.**

**Always shut off the engine before refuelling.**

**Always stop the engine and let it cool for a few minutes before refuelling.**

**When refuelling, open the fuel cap slowly so that any excess pressure is released gently.**

**Tighten the fuel cap carefully after refuelling.**

**Always move the machine away from the refuelling area before starting.**

Clean around the fuel cap. Clean the fuel and oil tank regularly. The fuel filter should be changed at least once a year. Contamination in the tanks causes malfunction.

Always move the machine about 3 metres from the refuelling position before starting.

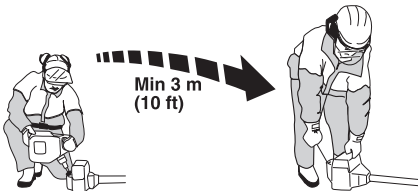

# STARTING AND STOPPING

## Check before starting



- Check that the support flange is not cracked due to fatigue or due to being tightened too much. Discard the support flange if it is cracked.

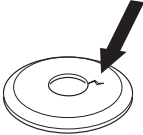

- Ensure the locking nut has not lost its captive force. The nut lock should have a locking force of at least 1.5 Nm. The tightening torque of the locking nut should be 35-50 Nm.



- Check that the trimmer head and trimmer guard are not damaged or cracked. Replace the trimmer head or trimmer guard if they have been exposed to impact or are cracked.

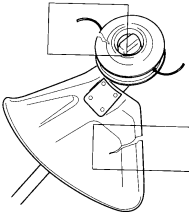

- Never use the machine without a guard nor with a defective guard.
- All covers must be correctly fitted and undamaged before you start the machine.

## Starting and stopping



**WARNING!** The complete clutch cover and shaft must be fitted before the machine is started, otherwise the clutch can come loose and cause personal injury.

Always move the machine away from the refuelling area before starting. Place the machine on a flat surface. Ensure the cutting attachment cannot come into contact with any object.

Make sure no unauthorised persons are in the working area, otherwise there is a risk of serious personal injury. The safety distance is 15 metres.

### Cold engine

**Ignition:** Set the stop switch to the start position.

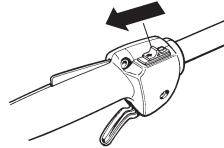

**Choke:** Set the choke control in the choke position.

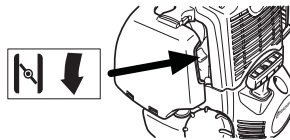

**Primer bulb:** Press the air purge repeatedly until fuel begins to fill the bulb. The bulb need not be completely filled.

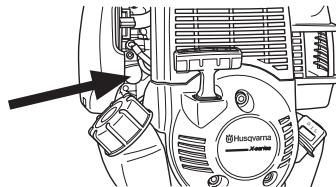

# STARTING AND STOPPING

## Warm engine

**Ignition:** Set the stop switch to the start position.

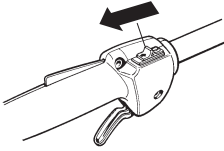

**Choke:** Put the choke in working position.

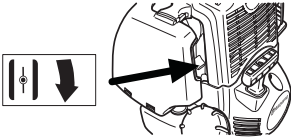

**Primer bulb:** Press the air purge repeatedly until fuel begins to fill the bulb. The bulb need not be completely filled.

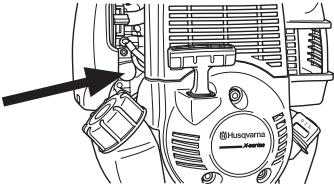

**WARNING!** When the engine is started with the choke in either the choke or start throttle positions the cutting attachment will start to rotate immediately.

## Starting

Hold the body of the machine on the ground using your left hand (CAUTION! Not with your foot!). Grip the starter handle, slowly pull out the cord with your right hand until you feel some resistance (the starter pawls grip), now quickly and powerfully pull the cord. **Never wrap the starter cord around your hand**

Reset the choke when the engine fires, repeat pulling the cord until the engine starts.

**CAUTION!** Do not pull the starter cord all the way out and do not let go of the starter handle when the cord is fully extended. This can damage the machine.



## Stopping

Stop the engine by switching off the ignition with the stop button.

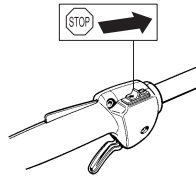



# WORKING TECHNIQUES

## General working instructions

### IMPORTANT!

This section takes up the basic safety precautions for working with a trimmer.

If you encounter a situation where you are uncertain how to proceed you should ask an expert. Contact your dealer or your service workshop.

Avoid all usage which you consider to be beyond your capability.

You must understand the difference between forestry clearing, grass clearing and grass trimming before use.

## Basic safety rules



### 1 Look around you:

- To ensure that people, animals or other things cannot affect your control of the machine.
  - To ensure that people, animals, etc., do not come into contact with the cutting attachment or loose objects that are thrown out by the cutting attachment.
  - CAUTION! Do not use the machine unless you are able to call for help in the event of an accident.
- 2 Inspect the working area. Remove all loose objects, such as stones, broken glass, nails, steel wire, string, etc. that could be thrown out or become wrapped around the cutting attachment.
- 3 Do not use the machine in bad weather, such as dense fog, heavy rain, strong wind, intense cold, etc. Working in bad weather is tiring and often brings added risks, such as icy ground, unpredictable felling direction, etc.
- 4 Make sure you can move and stand safely. Check the area around you for possible obstacles (roots, rocks, branches, ditches, etc.) in case you have to move suddenly. Take great care when working on sloping ground.



- 5 Keep a good balance and a firm foothold.

- 6 Always hold the machine with both hands. Hold the machine on the right side of your body.

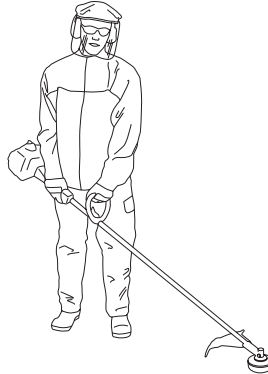

- 7 Keep the cutting attachment below waist level.
- 8 The engine must be switched off before moving.
- 9 Never put the machine down with the engine running unless you have it in clear sight.



**WARNING! Neither the operator of the machine nor anyone else may attempt to remove the cut material while the engine is running or the cutting equipment is rotating, as this can result in serious injury.**

**Stop the engine and cutting equipment before you remove material that has wound around the blade shaft as otherwise there is a risk of injury. The bevel gear can get hot during use and may remain so for a while afterwards. You could get burnt if you touch it.**



**WARNING! Watch out for thrown objects. Always wear approved eye protection. Never lean over the cutting attachment guard. Stones, rubbish, etc. can be thrown up into the eyes causing blindness or serious injury.**

**Keep unauthorised persons at a distance. Children, animals, onlookers and helpers should be kept outside the safety zone of 15 m. Stop the machine immediately if anyone approaches. Never swing the machine around without first checking behind you to make sure no one is within the safety zone.**

# WORKING TECHNIQUES

## Basic working techniques

Always slow the engine to idle speed after each working operation. Long periods at full throttle without any load on the engine can lead to serious engine damage.



**WARNING! Sometimes branches or grass get caught between the guard and cutting attachment. Always stop the engine before cleaning.**

## Grass trimming with a trimmer head



### Trimming

- Hold the trimmer head just above the ground at an angle. It is the end of the cord that does the work. Let the cord work at its own pace. Never press the cord into the area to be cut.

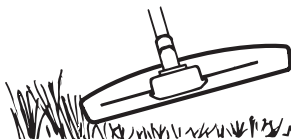

- The cord can easily remove grass and weeds up against walls, fences, trees and borders, however it can also damage sensitive bark on trees and bushes, and damage fence posts.
- Reduce the risk of damaging plants by shortening the cord to 10-12 cm and reducing the engine speed.

### Clearing

- The clearing technique removes all unwanted vegetation. Keep the trimmer head just above the ground and tilt it. Let the end of the cord strike the ground around trees, posts, statues and the like. **CAUTION!** This technique increases the wear on the cord.

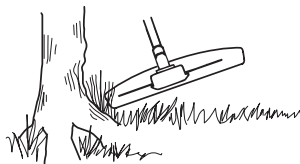

- The cord wears quicker and must be fed forward more often when working against stones, brick, concrete, metal fences, etc., than when coming into contact with trees and wooden fences.
- When trimming and clearing you should use less than full throttle so that the cord lasts longer and to reduce the wear on the trimmer head.

## Cutting

- The trimmer is ideal for cutting grass that is difficult to reach using a normal lawn mower. Keep the cord parallel to the ground when cutting. Avoid pressing the trimmer head against the ground as this can ruin the lawn and damage the tool.

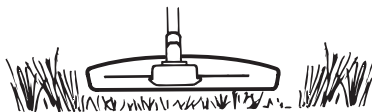

- Do not allow the trimmer head to constantly come into contact with the ground during normal cutting. Constant contact of this type can cause damage and wear to the trimmer head.

## Sweeping

- The fan effect of the rotating cord can be used for quick and easy clearing up. Hold the cord parallel to and above the area to be swept and move the tool to and fro.

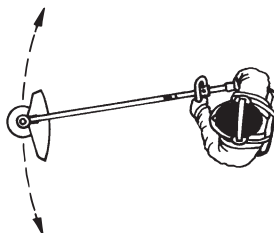

- When cutting and sweeping you should use full throttle to obtain the best results.

# MAINTENANCE

## Carburetor

### Function

- The carburetor governs the engine's speed via the throttle control. Air and fuel are mixed in the carburetor.
- Setting the carburetor involves adapting the engine to suit local conditions, e.g. climate, altitude and the petrol.

### Basic setting

The basic carburetor settings are adjusted during testing at the factory.

**CAUTION!** For optimum adjustment of the carburetor, contact a qualified dealer/service workshop that has a revolution counter at their disposal.

### Adjusting the idle speed (T)

Check that the air filter is clean. When the idle speed is correct, the cutting attachment should not rotate. If adjustment is required, close (turn clockwise) the idle adjustment screw T, with the engine running, until the cutting attachment starts to rotate. Open (turn anticlockwise) the screw until the cutting attachment stops. The idle speed is correctly set when the engine runs smoothly in all positions, and there is a clear margin to the speed at which the cutting attachment starts to rotate.

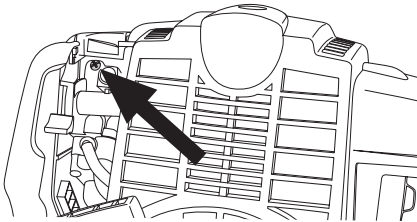

**WARNING!** If the idle speed cannot be adjusted so that the cutting attachment stops, contact your dealer/service workshop. Do not use the machine until it has been correctly adjusted or repaired.

## Muffler

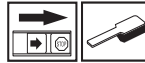

**CAUTION!** Some mufflers are fitted with a catalytic converter. See chapter on Technical data to see whether your machine is fitted with a catalytic converter.

The muffler is designed to reduce the noise level and to direct the exhaust gases away from the operator. The exhaust gases are hot and can contain sparks, which may cause fire if directed against dry and combustible material.

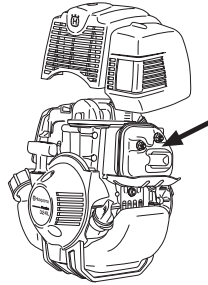

The muffler on your machine is equipped with a spark arrester screen, this should be cleaned regularly. A blocked screen will cause the engine to overheat and may lead to serious damage.

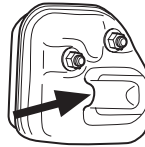

**CAUTION!** Never use a machine with a defective muffler.



**WARNING!** Mufflers fitted with catalytic converters get very hot during use and remain so for some time after stopping. This also applies at idle speed. Contact can result in burns to the skin. Remember the risk of fire!

# MAINTENANCE

## Cooling system



To keep the working temperature as low as possible the machine is equipped with a cooling system.

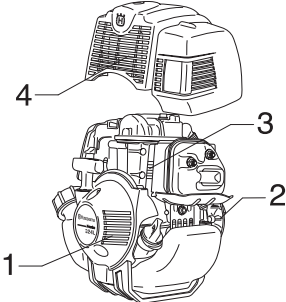

The cooling system consists of:

- 1 Air intake on the starter.
- 2 Fins on the flywheel.
- 3 Cooling fins on the cylinder.
- 4 Cylinder cover (directs cold air over the cylinder).

Clean the cooling system with a brush once a week, more often in demanding conditions. A dirty or blocked cooling system results in the machine overheating which causes damage to the piston and cylinder.

## Spark plug



The spark plug condition is influenced by:

- Incorrect carburetor adjustment.
- A dirty air filter.

These factors cause deposits on the spark plug electrodes, which may result in operating problems and starting difficulties.

If the machine is low on power, difficult to start or runs poorly at idle speed: always check the spark plug first before taking any further action. If the spark plug is dirty, clean it and check that the electrode gap is 0,6-0,7 mm. The spark plug should be replaced after about a month in operation or earlier if necessary.

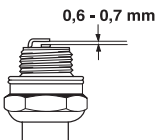

**CAUTION!** Always use the recommended spark plug type! Use of the wrong spark plug can damage the piston/cylinder. Check that the spark plug is fitted with a suppressor.

## Air filter

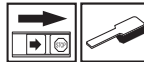

The air filter must be regularly cleaned to remove dust and dirt in order to avoid:

- Carburettor malfunctions
- Starting problems
- Loss of engine power
- Unnecessary wear to engine parts
- Excessive fuel consumption.

Clean the filter every 25 hours, or more regularly if conditions are exceptionally dusty.

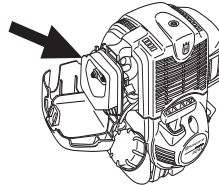

### Cleaning the air filter

Remove the air filter cover and take out the filter. Wash it clean in warm, soapy water. Ensure that the filter is dry before refitting it.

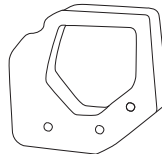

An air filter that has been in use for a long time cannot be cleaned completely. The filter must therefore be replaced with a new one at regular intervals. **A damaged air filter must always be replaced.**

If the machine is used in dusty conditions the air filter should be soaked in oil. See instructions under the heading Oiling the air filter.

# MAINTENANCE

## Oiling the air filter



Always use HUSQVARNA filter oil, art. no. 531 00 92-48. The filter oil contains a solvent to make it spread evenly through the filter. You should therefore avoid skin contact.

Put the filter in a plastic bag and pour the filter oil over it. Knead the plastic bag to distribute the oil. Squeeze the excess oil out of the filter inside the plastic bag and pour off the excess before fitting the filter to the machine. Never use common engine oil. This would drain through the filter quite quickly and collect in the bottom.

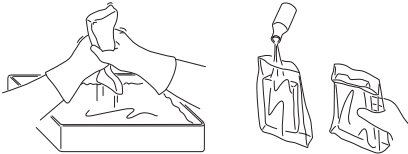

## Bevel gear



The bevel gear is filled with the right quantity of grease at the factory. However, before using the machine you should check that the bevel gear is filled three-quarters full with grease. Use HUSQVARNA special grease.

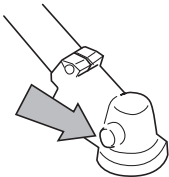

The grease in the bevel gear does not normally need to be changed except if repairs are carried out.

**IMPORTANT!** Use only HUSQVARNA replacement parts. Use of other brands of replacement parts can cause damage to your unit or injury to the operator or others. Your warranty does not cover damage or liability caused by the use of accessories and/or attachments not specifically recommended by HUSQVARNA.

# MAINTENANCE

## Maintenance schedule

The following is a list of the maintenance that must be performed on the machine. Most of the items are described in the Maintenance section. The user must only carry out the maintenance and service work described in this manual. More extensive work must be carried out by an authorised service workshop.

Maintenance	Daily maintenance	Weekly maintenance	Monthly maintenance
Clean the outside of the machine.	X		
Make sure the throttle trigger lock and the throttle function correctly from a safety point of view.	X		
Check that the stop switch works correctly.	X		
Check that the handle and handlebar are undamaged and secured correctly.	X		
Check that the cutting attachment does not rotate at idle.	X		
Clean the air filter. Replace if necessary.	X		
Check that the guard is undamaged and not cracked. Replace the guard if it has been exposed to impact or is cracked.	X		
Check that the trimmer head is undamaged and not cracked. Replace the trimmer head if necessary.	X		
Check that the locking nut of the cutting equipment is tighten correctly.	X		
Check that nuts and screws are tight.	X		
Check that there are no fuel leaks from the engine, tank or fuel lines.	X		
Check the engine oil level and top up if necessary.	X		
Check the starter and starter cord.		X	
Check that the vibration damping elements are not damaged.		X	
Clean the outside of the spark plug. Remove it and check the electrode gap. Adjust the gap to 0,6-0,7 mm, or replace the spark plug. Check that the spark plug is fitted with a suppressor.		X	
Clean the machine's cooling system.		X	
Clean or replace the spark arrestor screen on the muffler (only applies to mufflers without a catalytic converter).		X	
Clean the outside of the carburettor and the space around it.		X	
Check that the bevel gear is filled three-quarters full with lubricant. Fill if necessary using special grease.		X	
Check the fuel filter from contamination and the fuel hose from cracks or other defects. Replace if necessary.			X
Check all cables and connections.			X
Check the clutch, clutch springs and the clutch drum for wear. Replace if necessary by an authorized service workshop.			X
Replace the spark plug. Check that the spark plug is fitted with a suppressor.			X
Check and clean the spark arrestor screen on the muffler (only applies to mufflers fitted with a catalytic converter).			X
Change the engine oil.			X

# TECHNICAL DATA

## Technical data

### 224L

#### Engine

Cylinder displacement, cu.in/cm <sup>3</sup>	1,53/25,0
Cylinder bore, inch/mm	1,38/35
Stroke, inch/mm	1,03/26
Idle speed, rpm	3100
Recommended max. speed, rpm	12000
Speed of output shaft, rpm	8220
Max. engine output, acc. to ISO 8893, kW/ rpm	0,8 / 7000
Catalytic converter muffler	No
Speed-regulated ignition system	No

#### Ignition system

Manufacturer/type of ignition system	Ikeda
Spark plug	NGK CMR5H
Electrode gap, inch/mm	0,024/0,6

#### Fuel and lubrication system

Manufacturer/type of carburetor	Walbro
Fuel tank capacity, US pint/litre	1,16/0,55

#### Weight

Weight without fuel, cutting attachment and guard, Lbs/kg	11,0/5,0
---	----------

#### Sound levels

(see note 1)

Equivalent sound pressure level at the user's ear, measured according to ANSI B175.3-2003, dB(A), min/max:	90/97
--	-------

#### Vibration levels

Vibration levels at handles, measured according to ANSI B175.3-2003, m/s<sup>2</sup>

At idle, left/right handles, min.:	1,9/1,8
At idle, left/right handles, max.:	2,2/1,9
At max. speed, left/right handles, min.:	4,8/11,3
At max. speed, left/right handles, max.:	8,9/14,0

Note 1: Equivalent noise pressure level is calculated as the time-weighted energy total for noise pressure levels under various working conditions with the following time distribution: 1/2 idle and 1/2 max. speed.

NOTE! Noise pressure at the user's ear and vibration on the handles are measured with all the machine's approved cutting equipment fitted. The table indicates the highest and lowest values.

224L		
Approved accessories	Type	Cutting attachment guard, Art. no.
Arbor shaft thread M10		
Plastic blades	Tricut Ø 255 mm	503 93 42-02 / 503 97 71-01
	Tricut Ø 300 mm	503 93 42-02
Trimmer head	S35	503 93 42-02 / 503 97 71-01
	T25	503 93 42-02 / 503 97 71-01
	T35	503 93 42-02 / 503 97 71-01
	Trimmy Fix	503 93 42-02 / 503 97 71-01
	Superauto II	503 93 42-02 / 503 97 71-01

# FEDERAL AND CALIFORNIA EMISSIONS CONTROL WARRANTY STATEMENT

## YOUR WARRANTY RIGHTS AND OBLIGATIONS

The EPA (U.S. Environmental Protection Agency), CARB (California Air Resources Board), Environment Canada and Husqvarna Forest & Garden are pleased to explain the emissions control system's warranty on your 2009 and later small off-road engine. In U.S. and Canada, new equipment that use small off-road engines must be designed, built, and equipped to meet the applicable Federal or Californian stringent anti-smog standards. Husqvarna Forest & Garden must warrant the emissions control system on your small off-road engine for the period listed below provided there has been no abuse, neglect or improper maintenance of your equipment. Your emissions control system may include parts such as the carburetor, ignition system, catalytic converter, fuel tank, filters and other associated components. Also, included may be hoses, belts, connectors, sensors, and other emission-related assemblies. Where a warrantable condition exists, Husqvarna Forest & Garden will repair your small off-road engine at no cost to you including diagnosis, parts and labor.

## MANUFACTURER'S WARRANTY COVERAGE

The emissions control system is warranted for two years. If any emissions-related part on your equipment is defective, the part will be repaired or replaced by Husqvarna Forest & Garden.

## OWNER'S WARRANTY RESPONSIBILITIES

- As the small off-road engine owner, you are responsible for performance of the required maintenance listed in your operator's manual. Husqvarna Forest & Garden recommends that you retain all receipts covering maintenance on your small off-road engine, but Husqvarna Forest & Garden cannot deny warranty solely for the lack of receipts or your failure to ensure the performance of all scheduled maintenance.
- As the small off-road engine owner, you should however be aware that Husqvarna Forest & Garden may deny you warranty coverage if your small off-road engine or a part has failed due to abuse, neglect, or improper maintenance or unapproved modifications.
- You are responsible for presenting your small off-road engine to a Husqvarna Forest & Garden distribution center or service center as soon as the problem exists. The warranty repairs should be completed in a reasonable amount of time, not to exceed 30 days. If you have any questions regarding your warranty coverage, you should contact Husqvarna Forest & Garden at 1-800-487-5951 or visit [www.usa.husqvarna.com](http://www.usa.husqvarna.com).

## WARRANTY COMMENCEMENT DATE

The warranty period begins on the date the engine or equipment is delivered to an ultimate purchaser.

## LENGTH OF COVERAGE

Husqvarna Forest & Garden warrants to the ultimate purchaser and each subsequent owner that the engine or equipment is designed, built, and equipped so as to conform with all applicable regulations adopted by EPA and CARB, and is free from defects in materials and workmanship that causes the failure of a warranted part for a period of two years.

## WHAT IS COVERED

**REPAIR OR REPLACEMENT OF PARTS** Repair or replacement of any warranted part under the warranty must be performed at no charge to the owner at a warranty station. Warranty services or repairs will be provided at all Husqvarna Forest & Garden distribution centers that are franchised to service the subject engines. Throughout the emissions warranty period of two years, Husqvarna Forest & Garden must maintain a supply of warranted parts sufficient to meet the expected demand for such parts.

**WARRANTY PERIOD** Any warranted part that is scheduled for replacement as required in the maintenance schedule, is warranted for the period of time prior to the first scheduled replacement point for that part. If the part fails prior to the first scheduled replacement, the part will be repaired or replaced by Husqvarna Forest & Garden at no cost. Any such part repaired or replaced under warranty is warranted for the remainder of the period prior to the first scheduled replacement point for the part. Any warranted part that is not scheduled for replacement as required in the maintenance schedule, is warranted for two years. If any such part fails during the period of warranty coverage, it will be repaired and replaced by Husqvarna Forest & Garden at no cost. Any such part repaired or replaced under the warranty is warranted for the remaining warranty period. Any warranted part that is scheduled only for regular inspection in the maintenance schedule will be warranted for a period of two years. A statement in such written instructions to the effect of "repair or replace as necessary" will not reduce the period of warranty coverage. Any such part repaired or replaced under warranty will be warranted for the remaining warranty period.

**DIAGNOSIS** The owner must not be charged for diagnostic labor that leads to the determination that a warranted part is in fact defective, provided that such diagnostic work is performed at a warranty station.

**CONSEQUENTIAL DAMAGES** Husqvarna Forest & Garden is liable for damages to other engine components proximately caused by a failure under warranty of any warranted part.



---

# FEDERAL AND CALIFORNIA EMISSIONS CONTROL WARRANTY STATEMENT

---

## EMISSION WARRANTY PARTS LIST

- 1 Carburetor and internal parts
- 2 Intake pipe, airfilter holder and carburetor bolts.
- 3 Airfilter and fuelfilter covered up to maintenance schedule.
- 4 Spark Plug, covered up to maintenance schedule
- 5 Ignition Module
- 6 Muffler with catalytic converter
- 7 Fuel tank

## WHAT IS NOT COVERED

All failures caused by abuse, neglect or improper maintenance are not covered.

## ADD -ON OR MODIFIED PARTS

Add-on or modified parts that are not exempted by CARB or EPA may not be used. The use of any non-exempted add-on or modified parts will be grounds for disallowing a warranty claim. Husqvarna Forest & Garden will not be liable to warrant failures of warranted parts caused by the use of a non-exempted add-on or modified part.

## HOW TO FILE A CLAIM

If you have any questions regarding your warranty rights and responsibilities, you should contact your nearest authorized servicing dealer or call Husqvarna Forest & Garden at 1-800-487-5951 or visit [www.usa.husqvarna.com](http://www.usa.husqvarna.com).

## WHERE TO GET WARRANTY SERVICE

Warranty services or repairs are provided through all Husqvarna Forest & Garden authorized servicing dealers.

## MAINTENANCE, REPLACEMENT AND REPAIR OF EMISSION-RELATED PARTS

Any replacement part may be used in the performance of any warranty maintenance or repairs and must be provided without charge to the owner. Such use will not reduce the warranty obligations of the manufacturer.

## MAINTENANCE STATEMENT

The owner is responsible for the performance of all required maintenance, as defined in the operator's manual.

# Super Auto II Super Auto II 1"



1

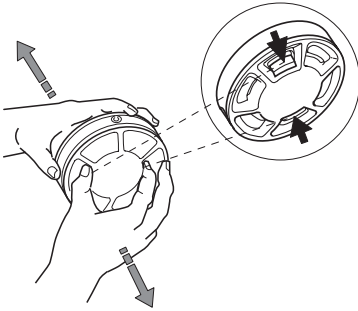

2

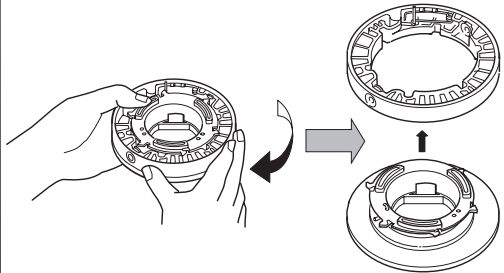

3

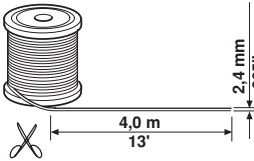

4

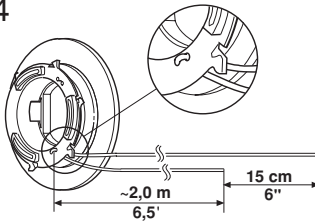

5

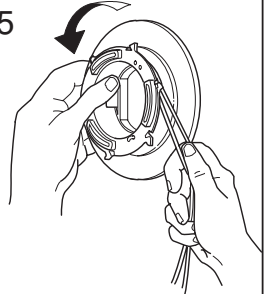

6

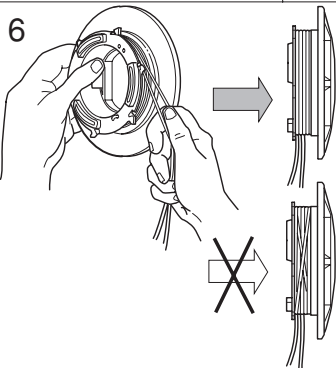

7

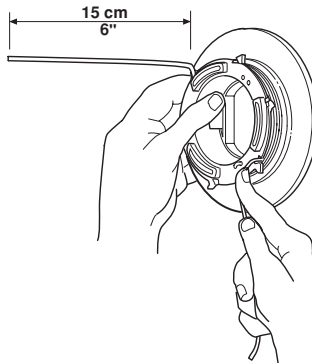

8

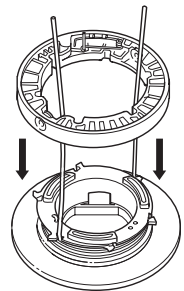

9

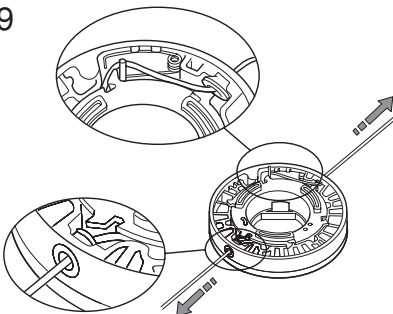

10

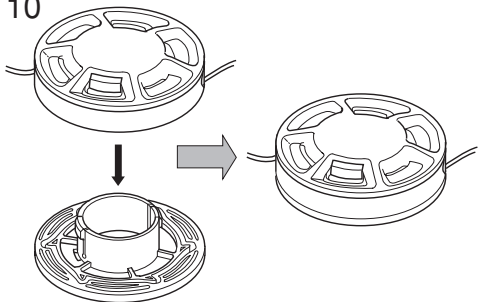

# Tri Cut

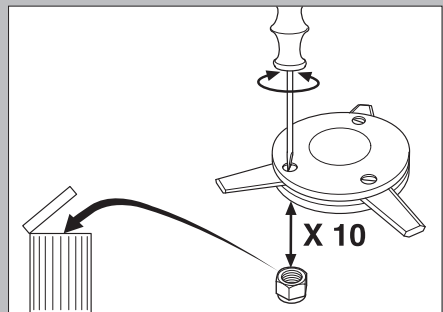
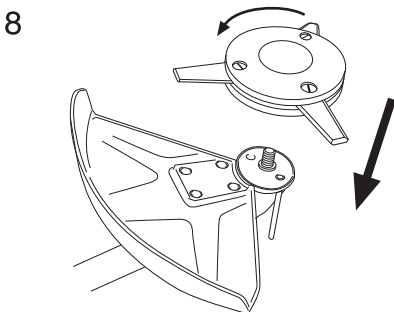
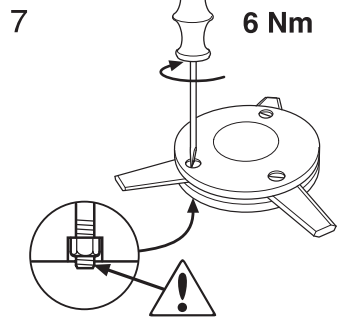
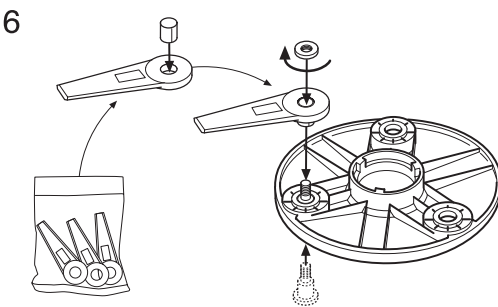
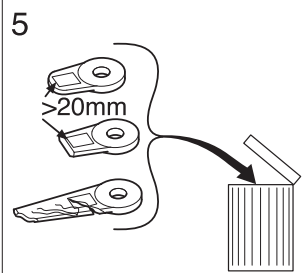
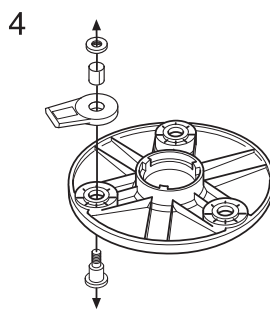
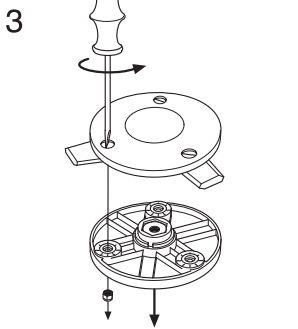
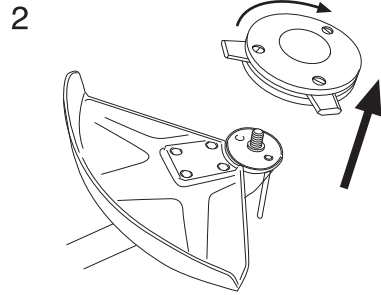
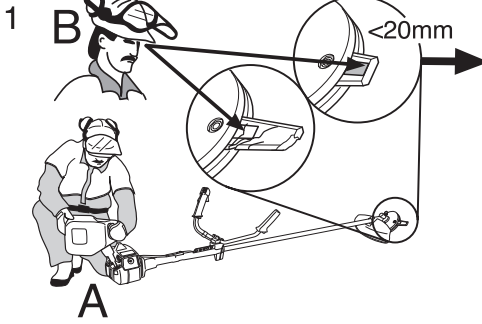

S35



1

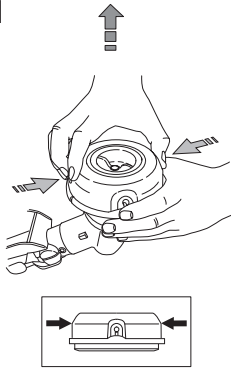

2

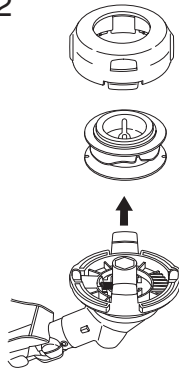

3

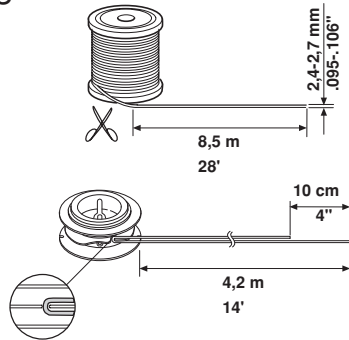

4

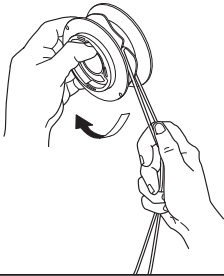

5

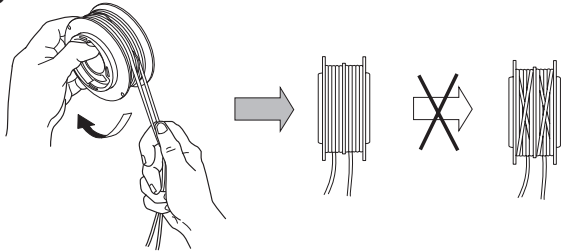

6

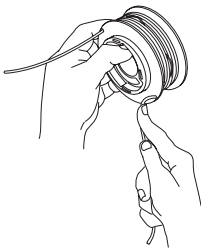

7

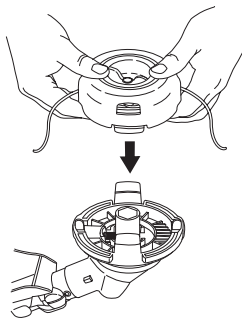

8

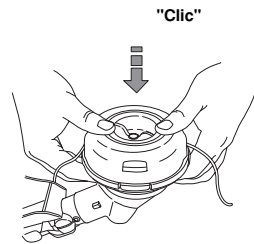

10

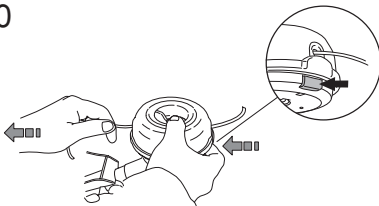

11

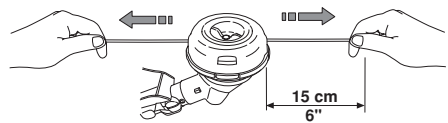

S35



1

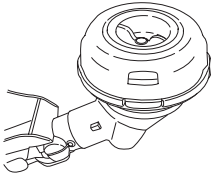

2

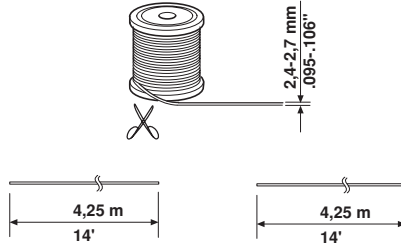

3

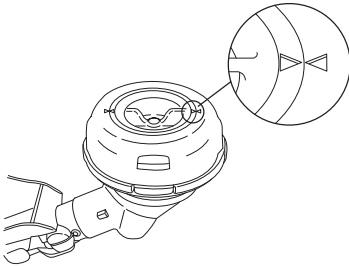

4

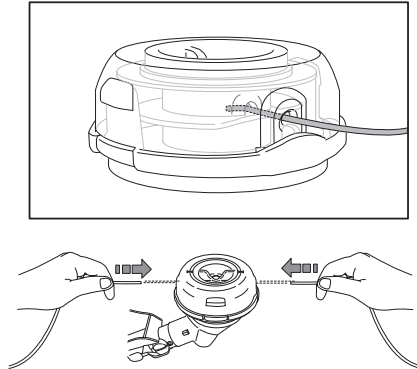

5

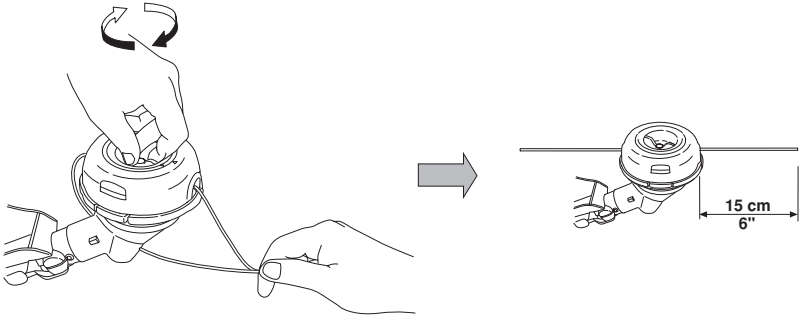

A

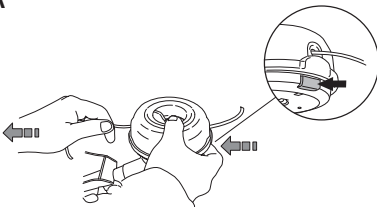

B

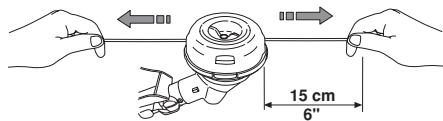

# T35, T35x



1

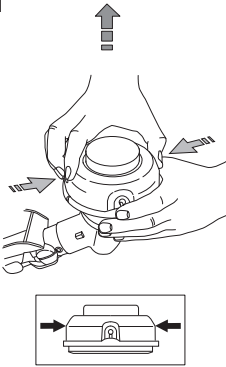

2

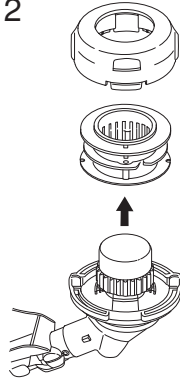

3

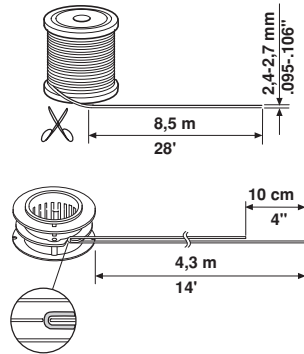

4

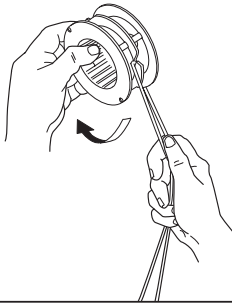

5

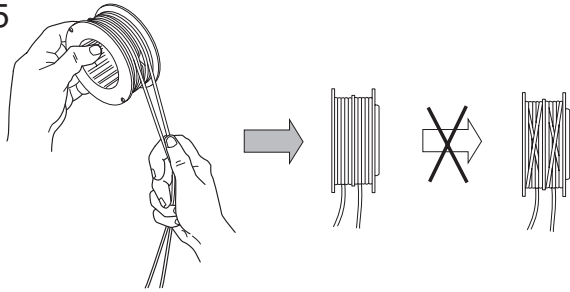

6

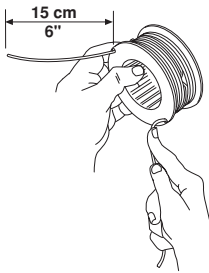

7

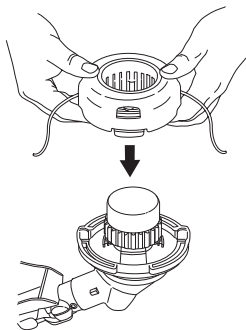

8

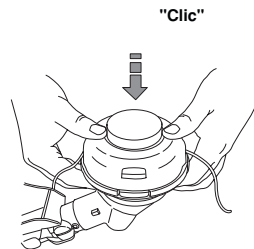

9

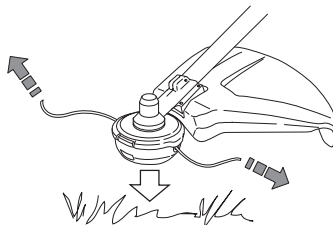

T25

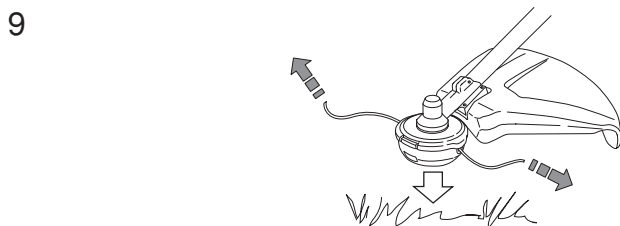
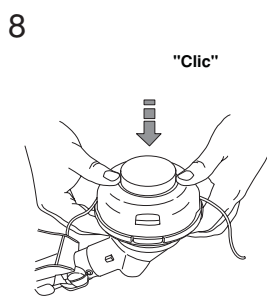
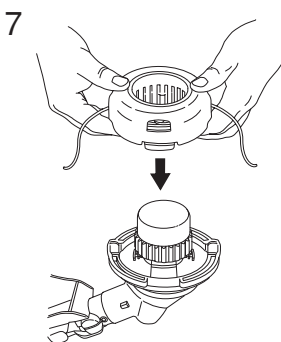
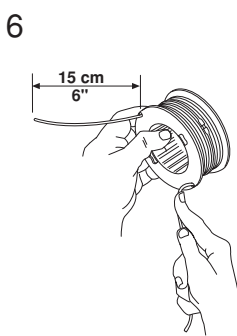
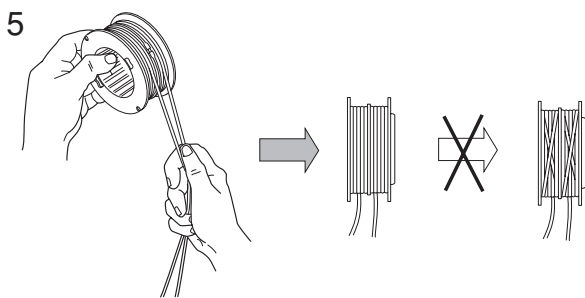
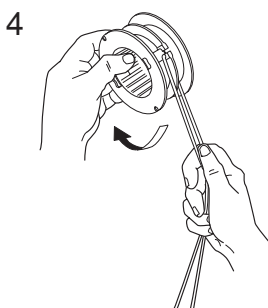
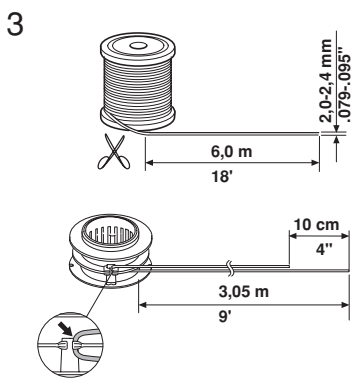
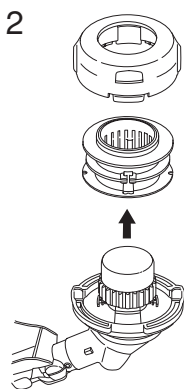
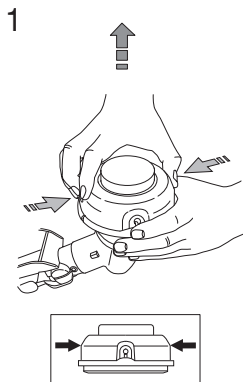











1151387-49



2009-06-10

## Free Manuals Download Website

<http://myh66.com>

<http://usermanuals.us>

<http://www.somanuals.com>

<http://www.4manuals.cc>

<http://www.manual-lib.com>

<http://www.404manual.com>

<http://www.luxmanual.com>

<http://aubethermostatmanual.com>

Golf course search by state

<http://golfingnear.com>

Email search by domain

<http://emailbydomain.com>

Auto manuals search

<http://auto.somanuals.com>

TV manuals search

<http://tv.somanuals.com>