



Technical Reference Manual Hardware and BIOS

**HP Vectra VL 5/xxx Series 5
and XA 5/xxx PC**

Notice

The information contained in this document is subject to change without notice.

Hewlett-Packard makes no warranty of any kind with regard to this material, including, but not limited to, the implied warranties of merchantability and fitness for a particular purpose.

Hewlett-Packard shall not be liable for errors contained herein or for incidental or consequential damages in connection with the furnishing, performance, or use of this material.

Hewlett-Packard assumes no responsibility for the use or reliability of its software on equipment that is not furnished by Hewlett-Packard.

This document contains proprietary information that is protected by copyright. All rights are reserved. No part of this document may be photocopied, reproduced, or translated to another language without the prior written consent of Hewlett-Packard Company.

Centronics® is a registered trademark of Centronics Data Computer Corporation.

Matrox® is a registered trademark of Matrox Electronic Systems Ltd.

MGA™ is a trademark of Matrox Graphics Inc.

Microsoft®, Windows® and MS-DOS® are registered trademarks of Microsoft Corporation.

MMX™ is a trademark of Intel Corporation.

NextStep™ is a trademark of Next Incorporated.

Novell® and Netware® are registered trademarks of Novell Inc.

OS/2™ is a trademark of International Business Machines Corporation.

Pentium® is a registered trademark of Intel Corporation.

SCO UNIX® is a registered trademark of the Santa Cruz Operation.

SoundBlaster™ is a trademark of Creative Technology Limited.

Hewlett-Packard France
Commercial Desktop Computing Division
38053 Grenoble Cedex 9
France

Preface

This manual is a technical reference and BIOS document for engineers and technicians providing system level support. It is assumed that the reader possesses a detailed understanding of AT-compatible microprocessor functions and digital addressing techniques.

Technical information that is readily available from other sources, such as manufacturer's proprietary publications, has not been reproduced.

This manual contains summary information only. For additional reference material, refer to the bibliography, on the next page.

Conventions

The following conventions are used throughout this manual to identify specific numeric elements:

- Hexadecimal numbers are identified by a lower case h.
For example, 0FFFFFFFh or 32F5h
- Binary numbers and bit patterns are identified by a lower case b.
For example, 1101b or 10011011b

Bibliography

- ❑ HP Vectra VL 5/xxx Series 5 *User's Guide* (D4550-90001).
- ❑ HP Vectra VL 5/xxx Series 5 Minitower *User's Guide* (D4570-90001).
- ❑ HP Vectra XA 5/xxx *User's Guide* (D3984-90001).
- ❑ HP Vectra XA 5/xxx Minitower *User's Guide* (D3985-90001).
- ❑ HP Vectra VL 5/xxx Series 5 PC *Familiarization Guide* (D4550-90901).
- ❑ HP Vectra XA 5/xxx PC *Familiarization Guide* (D3984-90901).
- ❑ HP *Network Administrator's Guide* (online).
- ❑ HP Vectra *Accessories Service Handbook - 7th edition* (5965-4074).
- ❑ HP Vectra *PC Service Handbook (Volume 1) - 11th edition* (5965-4075).
- ❑ HP *Support Assistant* CD-ROM (by subscription).

The following Intel® publications provide more detailed information:

- ❑ *Pentium Microprocessor Data Sheet* (241595-002)

Contents

Preface	iii
Conventions.....	iii
Bibliography.....	iv
1 System Overview	
Package	10
Desktop Package.....	10
Minitower Package	11
Plan view of the Chassis Base of the Desktop Package	12
Specifications and Characteristic Data	13
Status Panel.....	13
Physical Characteristics	13
Environmental Specification	14
Electrical Specification.....	15
Documentation	17
Where to Find the Information.....	18
2 System Board	
System Board.....	20
Architectural View	21
Chip-Set	22
PL/PCI Bridge Chip (82439HX)	22
PCI/ISA Bridge Chip (82371SB)	25
Super I/O Chip (37C932)	26
Backplane boards	28

Devices on the Processor-Local Bus	30
The Intel Pentium Microprocessor	30
Cache Memory	32
Main Memory	32
Devices on the PCI Bus	34
Integrated Drive Electronics (IDE)	34
Universal Serial Bus (USB) Controller	36
Devices on the ISA Bus	37
Super I/O Controller	37
Little Ben	40
Other PCI and ISA Accessory Devices Under Plug and Play	40

3 Interface Devices and Mass-Storage Drives

S3 Trio 64V2 Graphics Controller Chip	42
Video Memory	42
Video Modes	43
Available Video Resolutions	46
Connectors	47
Troubleshooting	47
Matrox MGA Millennium Graphics Controller Board	48
Connectors	49
Video Memory	49
Available Video Resolutions	49
Video BIOS	51
HP Ethernet 10/100 BaseT Network Board	52
HP Enhanced Ethernet Network Board	54
Audio Controller	55

Mass-Storage Drives	57
Hard Disk Drives	57
Flexible Disk Drives	57
CD-ROM Drives	57
Connectors and Sockets	58

4 Summary of the HP/Phoenix BIOS

HP/Phoenix BIOS Summary	64
Setup Program	66
Main Menu	66
Configuration Menu	66
Security Menu	68
Power Menu	69
Power Saving and Ergonometry	70
Power-On from Space-Bar	70
Soft Power Down	70
HP Off	70
Remote Power-On (RPO)	71
Advanced Power Management (APM)	75
Desktop Management Interface (DMI)	78
HP Lock	78
BIOS Addresses	79
System Memory Map	79
Product Identification	79
HP I/O Port Map (I/O Addresses Used by the System)	80

5 Power-On Self-Test and Error Messages

Order in Which the Tests are Performed	86
Error Message Summary.....	89
Beep Codes.....	90
Lights on the Status Panel	90

System Overview

This manual describes the *HP Vectra VL 5/xxx Series 5* and *XA 5/xxx PC*, and provides detailed system specifications.

This chapter introduces the external features, and lists the specifications and characteristic data of the system. It also summarizes the documentation which is available.

1 System Overview

Package

Package

Desktop Package

Front view of VL

Front logo does not show processor speed or series information

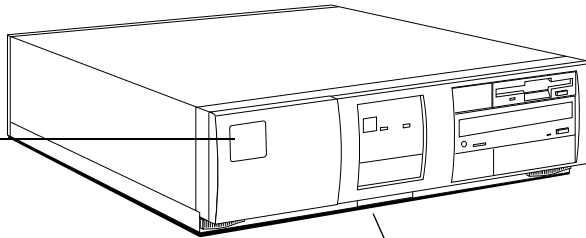

Wty: WBK@	Model VL 5/200 series 5
Sup: SAB@	Prod: D4570A #ABU
	S/N: FR63412345

Product information appears on a label on the lower front recess or the right hand side panel

Rear view of XA

Network connectors:
100 BaseT supports Remote Wake-Up (RWU) only
10 BaseT supports Remote Power-On (RPO) as well as RWU.

Front label does not show processor speed or series information. Instead this information appears on a label on the lower front recess (desktop models) or on the right hand side panel (minitower models).

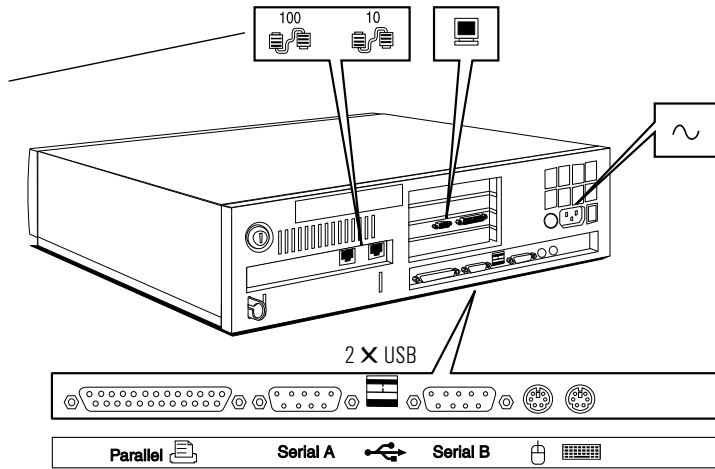

Inside view of VL

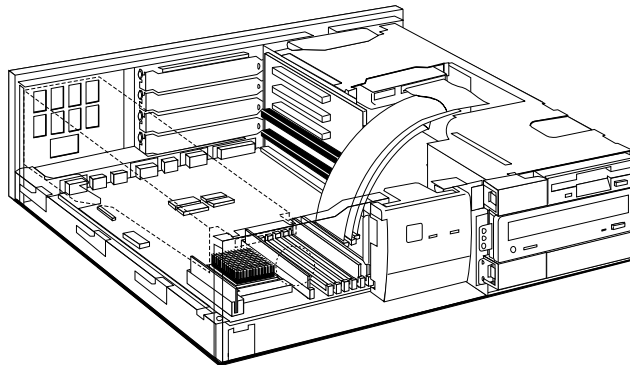

Minitower Package

Rear view of XA

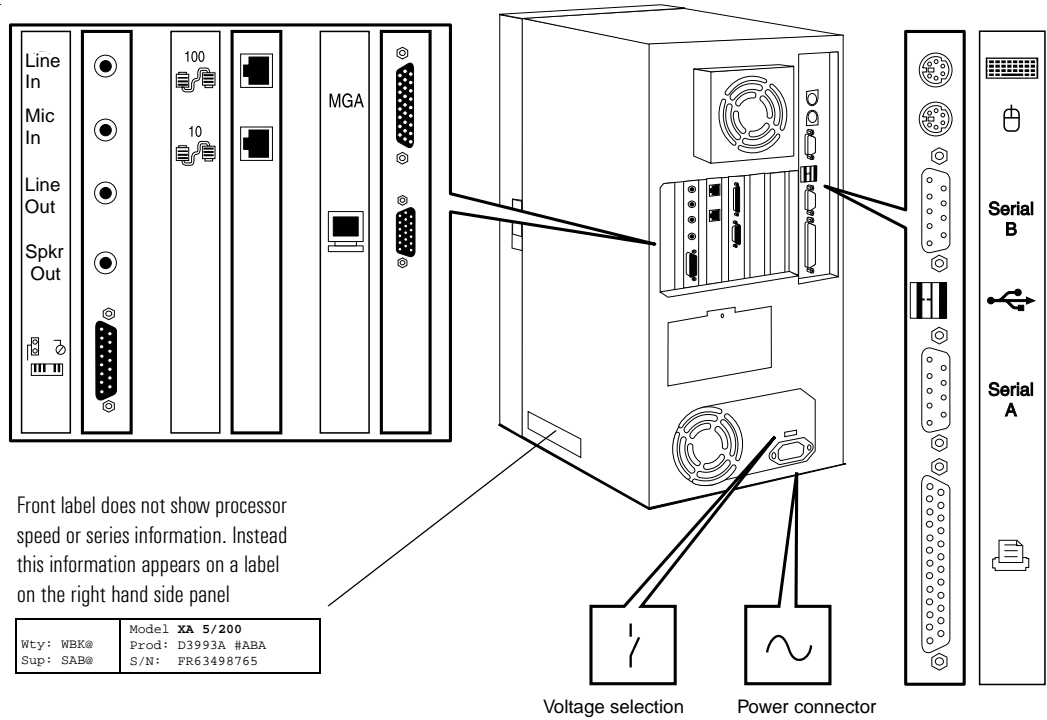

Inside view of VL

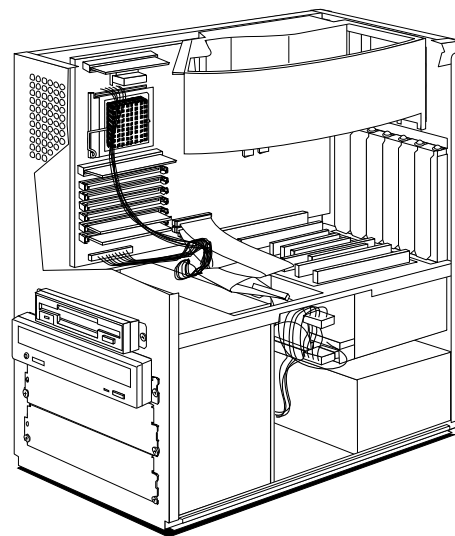

1 System Overview
Package

Plan view of the Chassis Base of the Desktop Package

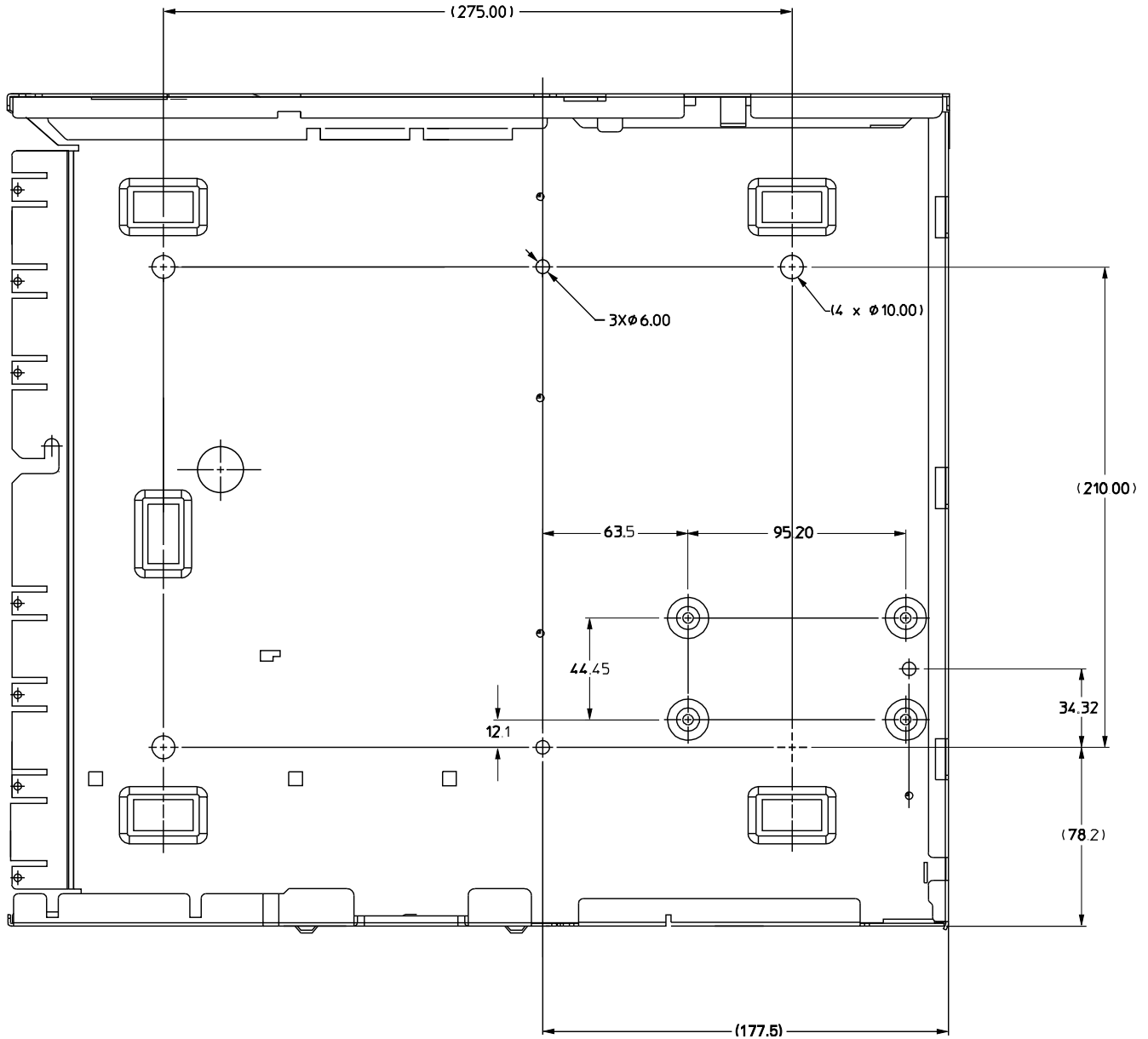

The above illustrations shows a plan view of the desktop model, seen from above. All dimensions are in millimeters.

The mounting holes for the second hard disk (95.20×44.45 mm), and those for mounting the computer on a solid surface (275.00×210.00 mm), are indicated.

Specifications and Characteristic Data

Status Panel

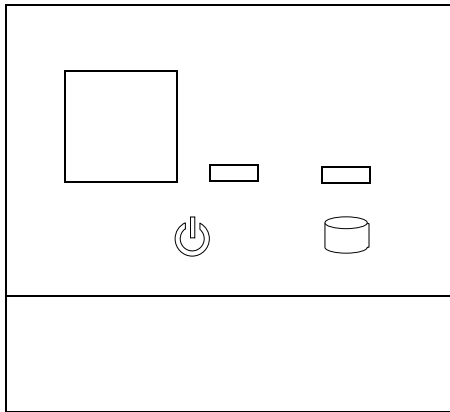

HP Vectra VL 5/xxx
Cover lock on back panel

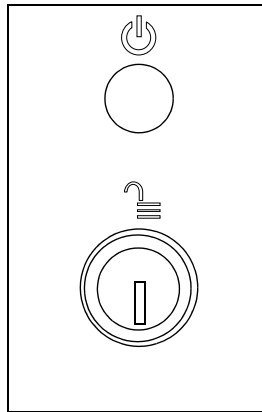

HP Vectra VL 5/xxx MT or
HP Vectra XA 5/xxx MT

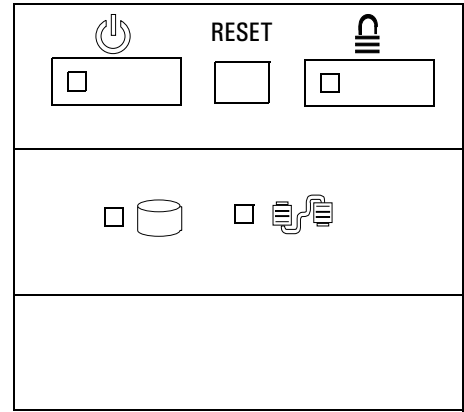

HP Vectra XA 5/xxx
Cover lock on back panel
Multimedia control panel on front

Physical Characteristics

System Processing Unit		
	Desktop	Minitower
Weight	9 kg (20 lbs)	15 kg (33 lbs)
Dimensions	39 cm (D) by 42 cm (W) by 12.5 cm (H) 15.3 inches by 16.5 inches by 4.9 inches	40.5 cm (D) by 21 cm (W) by 41.5 cm (H) 16.0 inches by 8.3 inches by 16.3 inches
Footprint	0.17 m ² (1.8 sq ft)	0.085 m ² (0.91 sq ft)
Keyboard		
Flat	464 mm (W) by 178 mm (D) by 33 mm (H) (18.3 inches by 7 inches by 1.3 inches)	
Standing	464 mm (W) by 178 mm (D) by 51 mm (H) (18.3 inches by 7 inches by 2 inches)	

1 System Overview

Specifications and Characteristic Data

Environmental Specification

System Processing Unit with a Hard Disk	
Typical power consumption	30 W to 40 W (before installing any customer-specific accessories)
Acoustic noise emission	less than 40 dB in the workplace under normal conditions as defined by DIN 45635 T.19 and ISO 7779
Operating temperature	+5°C to +40°C (+40°F to 104°F)
Recommended operating temperature	+15°C to +40°C (+59°F to +104°F)
Storage temperature	-40°C to +70°C (-40°F to +158°F)
Over temperature shutdown	+50°C (+122°F)
Operating humidity	15% to 80% RH (non-condensing)
Storage humidity	8% to 80% RH (non-condensing)
Operating altitude	3100 m max (10000 ft max)
Storage altitude	4600 m max (15000 ft max)

Operating temperature and humidity ranges may vary depending upon the mass storage devices installed. High humidity levels can cause improper operation of disk drives. Low humidity levels can aggravate static electricity problems and cause excessive wear of the disk surface.

Electrical Specification

For the desktop models:

Parameter	Limit for the Power Supply	Notes	Limit per PCI Accessory Slot	Limit per ISA Accessory Slot
Input voltage	100-127, 200-240 Vac	Auto-ranging	—	—
Input voltage range	90-264 Vac		—	—
Input current (max)	3 A		—	—
Input power (max)	150 W		—	—
Input power (typical ¹)	< 44 W < 29 W < 24 W < 5 W	Fully-on mode Standby mode Suspend mode Off (but plugged)	—	—
Input frequency	45 Hz to 66 Hz		—	—
Available power	100 W (continuous)		25 W (max)	7 W (max)
Max current at +5 V	13.5 A	Together, these two must not exceed 13.5 A	4.5 A	4.5 A
Max current at +3.3 V	6 A		—	—
Max current at -5 V	0.1 A		—	0.1 A
Max current at +12 V	4.5 A		1.5 A	0.5 A
Max current at -12 V	0.3 A		0.1 A	0.3 A
Input power (when turned Off)	Less than 5 W		When the PC is Off, but still plugged in, an independent mini power supply keeps the network board active enough to watch out for the "Remote Power-On" (RPO) signal (see page 71 for description)	
Available power (when Off)	0.25 W			
Available current (when Off)	0.05 A			

¹Dependant on operating system and PC configuration

1 System Overview

Specifications and Characteristic Data

For the minitower models:

Parameter	Limit for the Power Supply		Notes	Limit per PCI Accessory Slot	Limit per ISA Accessory Slot
Input voltage	100-127 Vac	200-240 Vac	Switch selectable		
Input voltage range	90-140 Vac	180-264 Vac			
Input current (max)	5 A	3 A			
Input power (max)	200 W				
Input power (typical ¹)	< 44 W < 29 W < 24 W < 5 W		Fully-on mode Standby mode Suspend mode Off (but plugged)	—	—
Input frequency	45 Hz to 66 Hz				
Available power	160 W (continuous)			25 W (max)	7 W (max)
Max current at +5 V	20 A		Together, these two must not exceed 20 A	4.5 A	4.5 A
Max current at +3.3 V	12 A			—	—
Max current at -5 V	0.2 A		—	—	0.1 A
Max current at +12 V	4.4 A		—	1.5 A	0.5 A
Max current at -12 V	0.5 A		—	0.1 A	0.3 A
Max current at +5 Vst	0.05 A		—	—	—

¹Dependant on operating system and PC configuration

When the computer is turned off, but left plugged in at the mains, the power consumption falls below 5 watts, but is not zero. A small trickle current continues to flow, supplying power to the CMOS memory, considerably extending the lifetime of the on-board battery.

If the computer is completely unplugged from the mains, the real time clock continues to operate, from the charge stored in the battery.

Documentation

The table below summarizes the availability of documentation that is appropriate to the *HP Vectra VL* and *XA 5/xxx* PCs. Three dots, '...', are used to indicate 'VL' or 'XA', as appropriate. Only selected publications are available on paper. Most are available as printable files from the HP division support servers, and as viewable files (which can also be printed) on the *HP Support Assistant* CD-ROM.

Line of HP Vectra 6/xxx:	Division Support Server		Support Assistant CD-ROM		Paper-based	
	VL	XA	VL	XA	VL	XA
HP Vectra ... 5/xxx User's Guide	PDF file	PDF file	PDF file	PDF file	<i>DT</i> : D4550A <i>MT</i> : D4570A	<i>DT</i> : D3984A <i>MT</i> : D3985A
HP Vectra ... 5/xxx Familiarization Guide	PDF file	PDF file	PDF file	PDF file	D4550-90901	D3984-90901
HP Vectra VL and XA 5/xxx Technical Reference Manual	PDF file		PDF file		no	
HP Vectra PC Service Handbook (Vol 1, 11th Edition)	PDF file	PDF file	PDF file	PDF file	5965-4075	
HP Vectra Accessory Service Handbook (7th Edition)	PDF file		PDF file		5965-4074	
Network Administrators Guide	PDF file		PDF file		no	

Each PDF file (portable document format) can be viewed on the screen by opening the file with Acrobat Reader. You can use the page-up, page-down, goto page, search string functions to read the document on the screen. (Note, though, that there is difference between the page number that is printed on the page, and the page number that Acrobat Reader indicates, because of the presence of the front matter pages). To print the document, press Ctrl+P whilst you have the document on the screen.

1 System Overview

Documentation

Where to Find the Information

The following table summarizes the availability of information within the HP Vectra VL and XA 5/xxx PC documentation set.

	User Guide	User Online	Familiarization Guide	Service Handbook	Technical Reference Manual
Introducing the computer					
Product features	Key features	Exploring	New features	Exploded view Parts list	Key features
Product model numbers				Product range CPL dates	
Using the computer					
Connecting cables and turning on	Keyboard, mouse, display, network, printer, power				
Finding on-line information	Finding READ.MEs and on-line documentation				
Environmental		Working in comfort			System overview
Formal documents	Software license agreement Warranty information	S/w license agreement			
Upgrading the computer					
Opening the computer	Full details				
Supported accessories	Some part number details			Full PN details	
Replacing accessories	How to install		New procedures		
Configuring devices		Configuring peripherals			Problem fixes
Fields and their options within Setup					Key fields
Repairing the computer					
Troubleshooting	Basic		New symptoms	Service notes	Advanced
Technical information	Basic	Detailed			Advanced
System board	Jumpers, switches and connectors		Jumpers, switches and connectors How to replace	Jumpers, switches and connectors	Jumpers, switches and connectors Chip-set details
BIOS	Basic details		Upgrading		Technical details Memory maps
Power-On Self-Test routines (POST)	Key error codes and suggestions for corrective action				Order of tests Complete list

System Board

The next chapter describes the video, disk, audio and network devices which are supplied with the various models of the computer.

This chapter describes the components of the system board, taking in turn the components of the Processor-Local Bus, the Peripheral Component Interconnect (PCI) bus and the Industry Standard Architecture (ISA) bus.

2 System Board

System Board

System Board

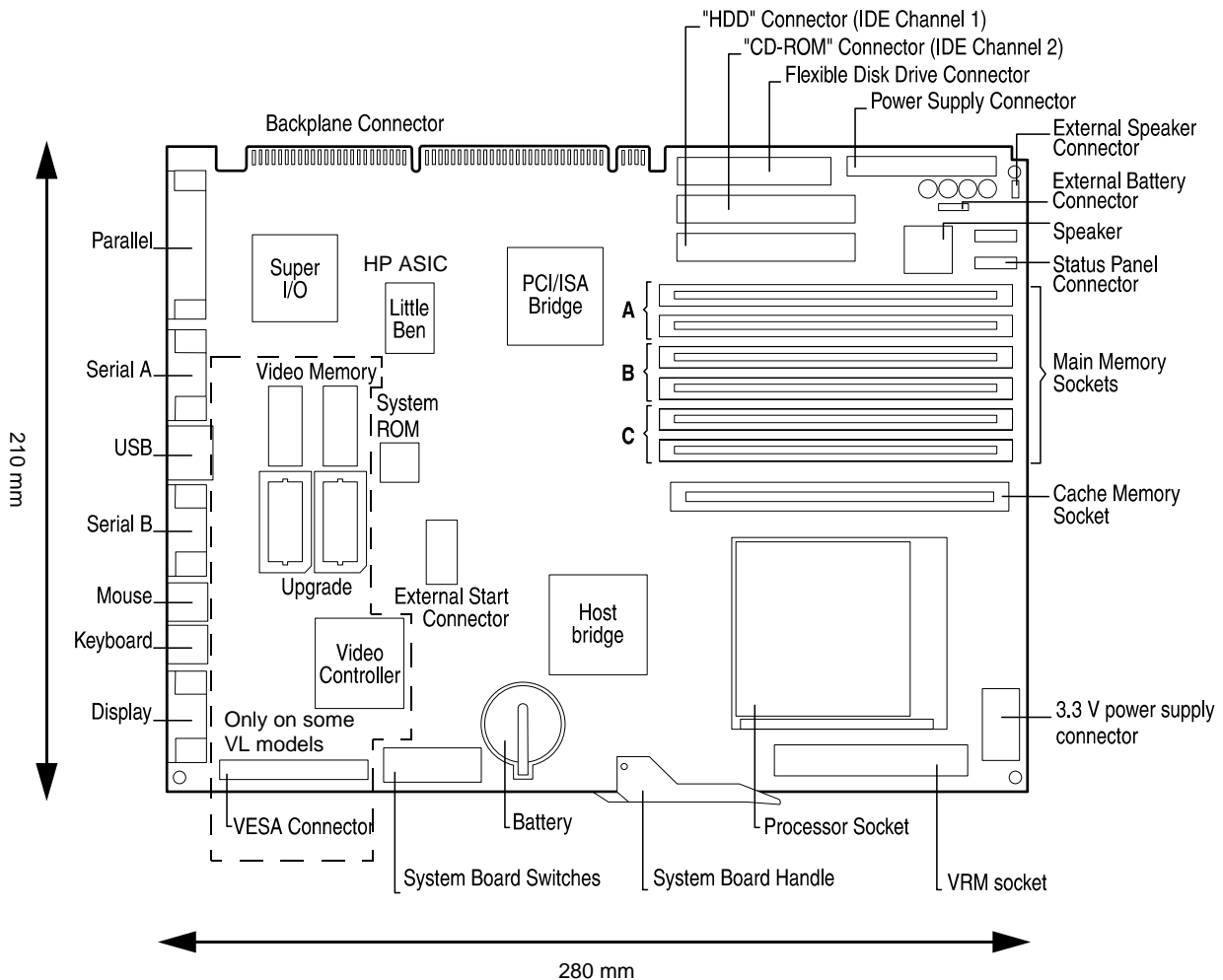

The video memory, video memory upgrade sockets, graphics controller and display connector are not loaded on any models that are supplied with a Matrox MGA Millennium board in a PCI accessories slot. This includes all models of the *HP Vectra XA 5/xxx PC* (desktop and minitower), and some models of the *HP Vectra VL 5/xxx Series 5 PC* (desktop and minitower).

Architectural View

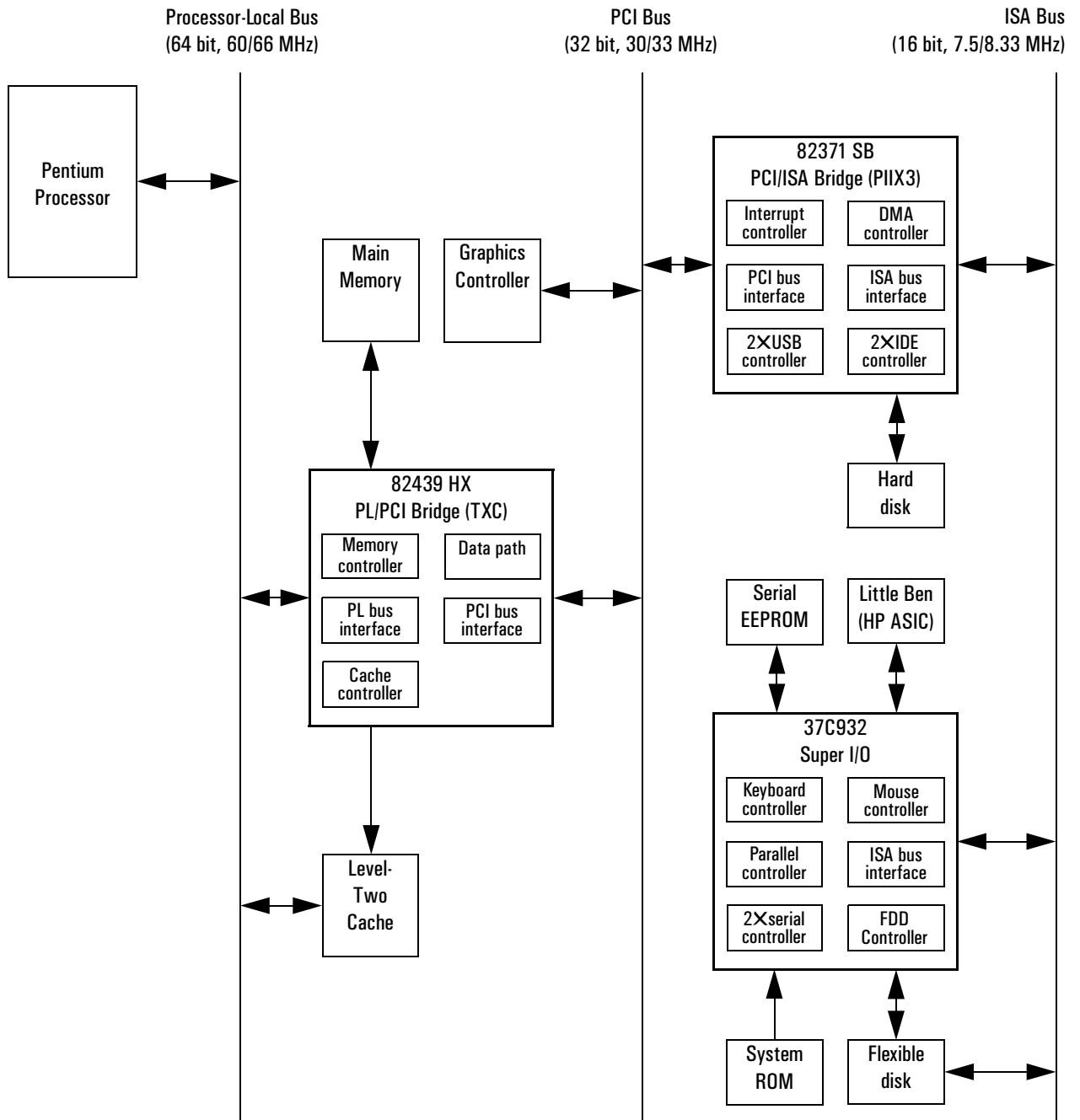

Chip-Set

The chip-set comprises three chips. These interface between the three main buses (the Processor-Local bus, the PCI bus and the ISA bus).

- The TXC chip (82439HX) is a combined *PL/PCI bridge* and *cache controller* and *main memory controller* and *PCI-to-PL bus data path*.
- The PIIX3 chip (82371SB) is a combined *PCI/ISA bridge* and *IDE controller* and *USB controller*.
- The Super I/O chip (37C932) is a combined *serial interface* and *parallel interface* and *keyboard controller* and *mouse controller* and *flexible disk drive controller*.

The TXC and PIIX3 chips are PCI 2.1 compliant, and provide for *PCI Concurrency*. Concurrent data transfers that do not contest for the same resources (such as processor to memory concurrent with PCI peer to peer, or processor to ISA device concurrent with PCI device to memory) are allowed to interleave their transfers more finely than with previous chip sets. This has little effect on the throughput of the system, but results in a greatly reduced worst-case latency. This leads to a much smoother operation of video capture, MPEG clips and audio clips.

To find out more about how this is achieved, the reader is referred to the Intel documentation on the 82430HX chip set. Relevant key words include: the *multi-transaction timer* (MTT), the *passive release* mechanism, and the *PCI delayed transaction* mechanism.

PL/PCI Bridge Chip (82439HX)

The bridge between the Processor Local Bus (PL Bus) and the PCI Bus is encapsulated in a 324 pin ball grid array (BGA) package.

PL Bus Interface

The TXC chip monitors each cycle that is initiated by the processor, and forwards those to the PCI bus that are not targeted at the local memory. It translates PL bus cycles into PCI bus cycles.

The chip supports the SMM mode of the Pentium processor, the CPU stop clock hardware function, and the keyboard lock function. These are used by the LittleBen chip, as described on page 73.

PCI Bus Interface

Sequential PL-to-PCI memory write cycles are translated into PCI zero wait state burst cycles. The maximum PCI burst transfer can be from 256 bytes to 4 KB. The chip supports advanced snooping for PCI master bursting, and provides a pre-fetch mechanism dedicated for IDE read.

The PCI arbiter supports PCI bus arbitration for up to four masters using a rotating priority mechanism. Its hidden arbitration scheme minimizes arbitration overhead.

Data Path

Storage elements are provided for bidirectional data buffering among the 64-bit PL data bus, the 64/32-bit memory data bus, and the 32-bit PCI address/data bus.

There are three FIFO (first-in first-out) queues, and one read buffer for the bridges of the PL, PCI, and Memory buses. This buffering is used, partly, to smooth the differences in bandwidths between the three buses, thereby improving the overall system performance. During bus operations between the PL, PCI and Memory buses, the chip receives control signals from the TXC, performs functions such as latching data, forwarding data to destination bus, data assemble and disassemble.

Error correcting code (ECC) and parity bits are generated for memory writes, and optional parity checking for memory reads. This operation always sustains zero wait performance on PL-to-Memory, and always streams zero wait performance on PCI-to-Memory and Memory-to-PCI.

Whilst accesses to the local memory are in progress, whether it be from the PL or PCI bus, the TXC maintains control of the secondary cache, DRAMs, and the datapath.

Level-2 Cache Memory Controller

This unit controls the L2 cache memory, adopting a *write back* policy, in a direct mapped organization. An 8-bit tag is used to allow the lowermost 64 MB of main memory to be cached (if more than 64 MB of main memory is installed, accesses to the uppermost regions will be made directly to the main memory modules, and not via the cache memory mechanism). When a 512 KB cache memory module is installed, the chip set allows provision for an 11-bit tag to be used to allow 512 MB of main memory to be cached, but this facility has not been enabled in the HP BIOS. More details on the use of HP cache memory are given on page 32.

The cache memory line width is 32-bytes (256-bits), four times the width of the Processor-Local data bus. Reads and writes always involve a full cache line, and so require four back-to-back cycles on the bus. Since they involve

2 System Board

Chip-Set

accesses to related addresses, they do not need four independent accesses to main memory, but can be organized as a pipelined burst. The second, third and fourth cycles in each burst require less time to complete than the first. This is because the first cycle includes the addressing phase and memory pre-charge timing. The read and write access timing has the pattern 3-1-1-1. However, the timing for 64-byte burst reads can be even better than this (3-1-1-1,2-1-1-1 for a dual bank back-to-back burst read¹, and 3-1-1-1,1-1-1-1 for a single bank back-to-back burst read²) provided that the main memory banks have been filled contiguously.

There are two programmable non-cacheable regions, with an option to disable local memory in these regions. A 64 KB to 1 MB cache summary is provided.

Main Memory Controller The main memory controller supports up to 512 MB of main memory (*dynamic random access memory*, DRAM), arranged in banks of any mixture of memory capacities, provided that each bank contains a pair of identical single interline memory modules (SIMMs). The *HP Vectra VL 5/xxx Series 5* and *XA 5/xxx PCs* have provision for three banks. With the 32 MB module from HP, this gives a total capacity of 192 MB. With a future 64 MB module from HP, it will give a total capacity of 384 MB.

In the case of 66 MHz PL bus operation, memory accesses have a timing pattern of 5-2-2-2 for a page-hit. This degrades to 8-2-2-2 for a row-miss, and to 11-2-2-2 for a page-miss. When the banks have been filled in an arbitrary order, back-to-back burst reads keep to the 5-2-2-2,5-2-2-2 timing pattern. When the banks have been filled contiguously (bank A, then bank B, then bank C), back-to-back burst reads are improved to a 5-2-2-2,3-2-2-2 timing pattern.

The controller supports relocation of system management memory. It supports a read cycle power saving mode, and a CAS before RAS *Intelligent Refresh* mode of operation, with a CAS# driving current that is programmable.

The controller is fully configurable for the characteristics of the shadow RAM (640 KB to 1 MB). It supports concurrent write back. To implement the optional error correcting code (ECC) or parity checking, 36-bit SIMMs must be installed exclusively (see page 33 for more details).

1. As used for the HP 512 KB cache memory module.
2. As used for the HP 256 KB cache memory module.

PCI/ISA Bridge Chip (82371SB)

This chip is encapsulated in a 208 pin plastic quad flat pack (PQFP) package.

PCI Bus Interface	This part of the chip performs PCI-to-ISA, and ISA-to-PCI bus cycle translation. It supports the Plug-and-Play mechanism.
ISA Bus Interface	As well as accepting cycles from the PCI bus interface, and translating them for the ISA bus, the ISA bus interface also requests the PCI master bridge to generate PCI cycles on behalf of a DMA or ISA master. The ISA bus interface contains a standard ISA bus controller and data buffering logic. It can directly support six ISA slots without external data or address buffering.
IDE Controller	The PCI master/slave IDE controller, supporting four devices, two on each of two channels, is described on page 34.
USB Controller	The PCI USB controller, supporting two connectors, is described on page 36.
DMA Controller	The seven channel DMA controller incorporates the functionality of two 82C37 DMA controllers. Channels 0 to 3 are for 8-bit DMA devices, while channels 5 to 7 are for 16-bit devices (see page 82). The channels can be programmed for any of the four transfer modes: the three active modes (single, demand, block), can perform three different types of transfer: read, write and verify. The address generation circuitry can only support a 24-bit address for DMA devices.
Interrupt Controller	The sixteen channel interrupt controller incorporates the functionality of two 82C59 interrupt controllers. The two controllers are cascaded, giving 14 external and two internal interrupt sources (see page 82).
Counter / Timer	The chip contains a three-channel 82C54 counter/timer. The counters use a division of the 14.31818 MHz OSC input as the clock source.

2 System Board

Chip-Set

Super I/O Chip (37C932)

The *Super I/O* chip (FDC37C932) is contained within a 160-pin PQFP package. The chip provides the control for the following devices.

Function	Logical device number
Flexible disk controller	0
Parallel port controller	3
UART1 controller	4
UART2 controller	5
RTC	6
Keyboard controller	7
Mouse controller	7
General purpose I/O (GPIO)	8

Serial / parallel communications ports

The two 9-pin serial ports (whose pin layouts are depicted on page 58) support RS-232-C and are buffered by 16550 UARTs, with 16 Byte FIFOs. They can be programmed as COM1, COM2, COM3, COM4, or disabled.

The 25-pin parallel port (also depicted on page 58) is Centronics compatible, supporting IEEE 1284. It can be programmed as LPT1, LPT2, or disabled. It can operate the four modes:

- Standard mode (PC/XT, PC/AT, and PS/2 compatible).
- Bidirectional mode (PC/XT, PC/AT, and PS/2 compatible).
- Enhanced mode (enhanced parallel port, EPP, compatible).
- High speed mode (MS/HP extended capabilities port, ECP, compatible).

FDC

The integrated *flexible drive controller* (FDC) supports any combination of two from the following: tape drives, 3.5-inch flexible disk drives, 5.25-inch flexible disk drives. It is software and register compatible with the 82077AA, and 100% IBM compatible. It has an A and B drive-swapping capability and a non-burst DMA option.

Keyboard and Mouse Controller

The computer has an 8042-based keyboard and mouse controller. The connector pin layouts are shown on page 58. The Windows 95 keyboard is

described on page 37.

- RTC** The real-time clock (RTC) is 146818A-compatible. With an accuracy of 20 ppm (parts per million). The configuration RAM is implemented as 256 bytes of CMOS memory.
- Serial EEPROM** This is the non-volatile memory which holds the default values for the CMOS memory (in the event of battery failure, or the user pressing **F9** in *Setup*).
- General Purpose I/O** There are several general purpose I/O pins. Some of these are used on the *HP Vectra* to sense the current settings of system board switches (page 31 and page 39).

Description	GPIO number
Reserved (HP security from Little Ben IRQ)	GPIO10
Ratio of processor frequency to processor local bus frequency (as per SW-4)	GPIO11
Auto soft lock	GPIO12
Backplane identification BPID0 (always = 0); (see BPID1, below)	GPIO13
Host bus frequency selection, as indicated by SW-1	GPIO14
Host bus frequency selection, as indicated by SW-2	GPIO15
Serial EEPROM clear (as per SW-6)	GPIO16
Ratio of processor frequency to processor local bus frequency (as per SW-3)	GPIO17
Backplane identification BPID1 (desktop = 1, minitower = 0)	GPIO20
Serial EEPROM data out	GPIO21
Serial EEPROM data in	GPIO22
Serial EEPROM clock	GPIO23
Serial EEPROM chip select	GPIO24
Reserved (for fax or general purpose light)	GPIO25

2 System Board

Backplane boards

Backplane boards

Desktop (front view)

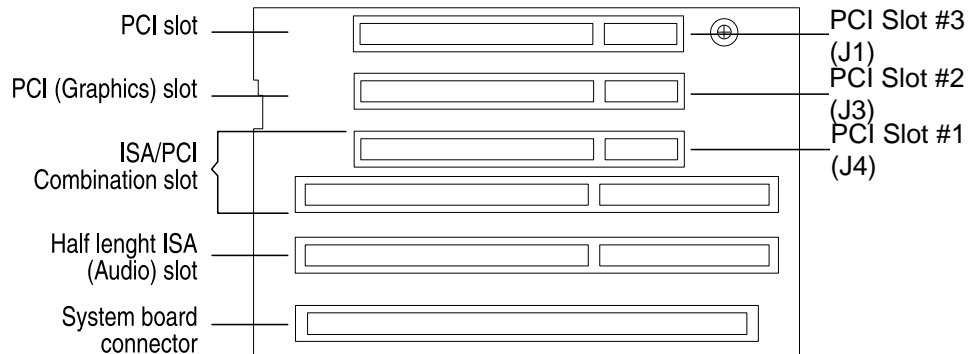

Desktop (rear view)

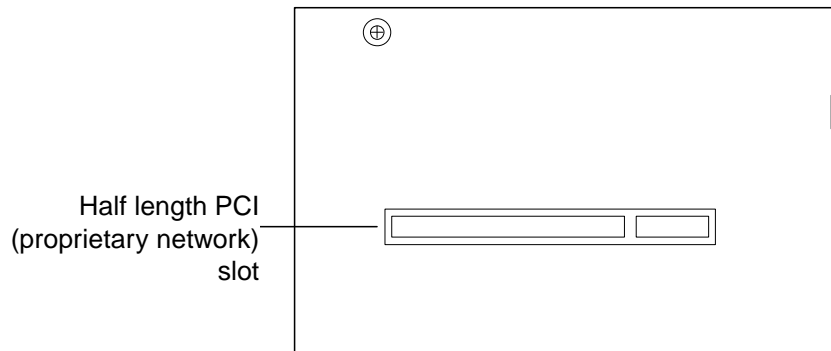

Minitower (top view)

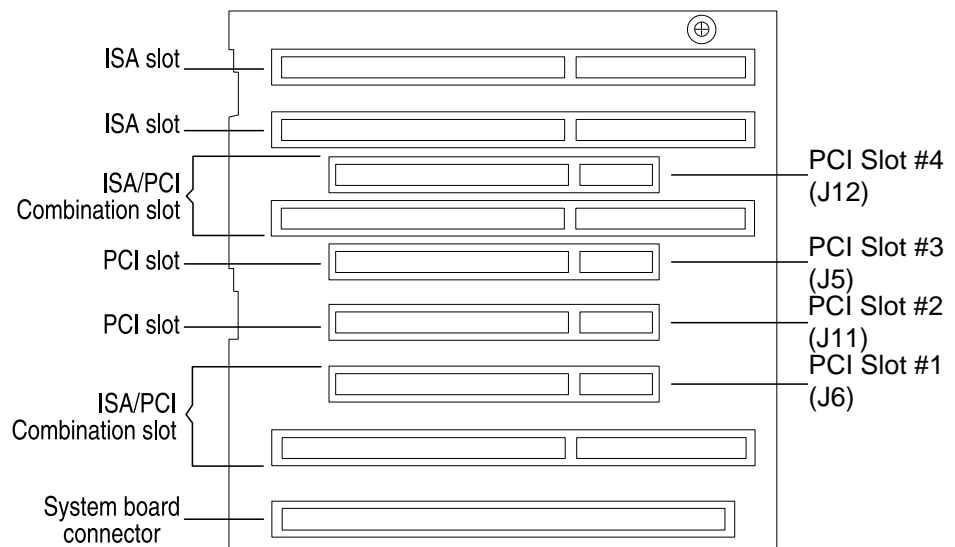

	Desktop			Minitower		
	Total	Occupied in base models	Occupied in top models	Total	Occupied in base models	Occupied in top models
PCI slots (normal)	2	0	1×Graphics	2	0	1×Graphics 1×Network
Proprietary PCI slots (short length, network) ¹	1	0	1×Network	0	—	—
PCI/ISA combination slots	1	0	0	1	0	0
PCI/ISA (short length) combination slots ²	0	—	—	1	0	1×Audio
ISA slots (full length)	0	—	—	2	0	0
ISA slots (short length) ²	1	0	1×Audio	0	—	—

¹HP proprietary slot on the rear side of the desktop back plane board

²To accommodate ISA boards up to a maximum length of 16 cm (6.3 inches)

2 System Board

Devices on the Processor-Local Bus

Devices on the Processor-Local Bus

The Intel Pentium Microprocessor

The Pentium processor is packaged in a *pin-grid-array* (PGA), and is seated on the system board in a *zero-insertion-force* (ZIF) *socket 7*. Only upgrades that are pin compatible with the original processor, manufactured by Intel, are supported.

P54CS chips working at 133 and 150 MHz (along with P54C chips working at 75, 90, 100 MHz and new versions of the 120 MHz chip) require a 3.3 V supply. A passive shorting block is sufficient to connect the regulated 3.3 V output of the power supply directly to the Pentium processor.

P54CS chips working at 166 and 200 MHz require between 3.45 and 3.60 V. They need an VRE *voltage regulator module* (VRM), in which the voltage is actively derived from the 3.3 V, 5 V and 0 V outlets of the power supply.

P55C chips, with MMX technology, require two voltage supplies: 3.3 V for the input and output buffers, and 2.8 V for the core logic. It requires an active VRM that is specifically designed for use with the MMX processor. This VRM can be identified by the inscription “2.8 V” marked on the board.

Any thermal contact material between the processor and the heat-sink must not be removed or disturbed. The cooling needs of the processor are critical.

MMX Technology

The instruction set of the MMX processor includes 57 new instructions, four new 64-bit data formats (depicted below) and eight new 64-bit MMX registers. As well as the pipelined parallelism of the traditional Pentium architecture, MMX is capable of SIMD parallelism (single-instruction/multiple-data). Instead of combining a pair of operands to produce a single result, each instruction is able to gang each operation over a large number of pairs of operands, so producing a large number of results concurrently. This type of parallelism is particularly useful when processing large vectors and arrays of data (in graphics and audio processing, for example).

Quadword	64 bit							
Packed double word	32 bit				32 bit			
Packed word	16 bit	16 bit	16 bit	16 bit	16 bit	16 bit	16 bit	
Packed byte	8 bit	8 bit	8 bit	8 bit	8 bit	8 bit	8 bit	

Bus Frequencies

The location of the system board switches is shown in the diagram on page 20. Five of these switches (SW-1,2,3,4 and 7) determine the working frequencies of the PC, and the three frequency multipliers (M1, M2 and M3), as summarized in the table below. The uses of the other switches are summarized on page 39.

There is a 14.318 MHz crystal oscillator on the system board whose frequency is multiplied, by a phase locked loop, to 50, 60 or 66 MHz for the Processor Local (PL) bus, according to the settings of SW-1 and SW-2. This is further multiplied, to the processor core frequency, by a factor of 1.5, 2, 2.5 or 3, according to the settings of SW-3 and SW-4. The PCI bus works at half the frequency of the PL bus. The ISA bus works at a third or a quarter of the frequency of the PCI bus, according to the setting of SW-7.

You will need to change these switches when you replace the original system board, for a repair, so as to match the processor. You will not need to change the switches if you upgrade the original processor using the correct Intel Overdrive. It is not recommended to upgrade to another processor that may have different voltage requirements.

Processor Frequency	M1	PL Bus Frequency	M2	PCI Bus Frequency	M3	ISA Bus Frequency	PL Frequency			Multiplier M1		M3	VRM ¹
							SW-1	SW-2	SW-8	SW-3	SW-4	SW-7	
75 MHz ²	1.5	50 MHz	2	25 MHz	3	8.33 MHz	Closed	Closed	Closed	Open	Open	Open	Vcc
90 MHz ²	1.5	60 MHz	2	30 MHz	4	7.5 MHz	Closed	Open	Closed	Open	Open	Closed	Vcc
100 MHz ²	1.5	66 MHz	2	33 MHz	4	8.25 MHz	Open	Closed	Closed	Open	Open	Closed	Vcc
120 MHz ²	2	60 MHz	2	30 MHz	4	7.5 MHz	Closed	Open	Closed	Closed	Open	Closed	Vcc,Vre
133 MHz	2	66 MHz	2	33 MHz	4	8.25 MHz	Open	Closed	Closed	Closed	Open	Closed	Vcc
150 MHz	2.5	60 MHz	2	30 MHz	4	7.5 MHz	Closed	Open	Closed	Closed	Closed	Closed	Vcc,Vmmx
166 MHz	2.5	66 MHz	2	33 MHz	4	8.25 MHz	Open	Closed	Closed	Closed	Closed	Closed	Vre,Vmmx
200 MHz	3	66 MHz	2	33 MHz	4	8.25 MHz	Open	Closed	Closed	Open	Closed	Closed	Vre,Vmmx
233 MHz ²	3.5	66 MHz	2	33 MHz	4	8.25 MHz	Open	Closed	Open	Open	Open	Closed	Vmmx

¹Where there is a choice indicated, install the one that is appropriate for the given processor.

²These processors are not available for these models of HP Vectra PC at the time of printing. This information is provided for completeness only.

The computer may execute erratically, if at all, or may overheat, if it is configured to operate at a higher processor speed than the processor is capable of supporting. This can cause damage to the computer.

2 System Board

Devices on the Processor-Local Bus

Setting the switches to operate at a slower speed, than the processor is capable of supporting, can still cause erratic behavior in some case, and would reduce the instruction throughput in others.

Cache Memory

The computer supports two levels of cache memory, each with a 32-byte line width. The Level-1 (L1) cache memory is fabricated on the processor chip. The Level-2 (L2) cache memory is a slower module on the system board. Each acts as temporary storage for data and instructions from the main memory. Since the system is likely to use the same, or adjacent, data several times, it is faster to get it from the on-chip or on-board cache memory than from the main memory.

The L1 cache memory is divided into two separate banks: an L1 I-cache for instruction words, and an L1 D-cache for data words. On a P54 processor, each has a capacity of 8 KB; on an MMX (P55) processor, each has a capacity of 16 KB.

The L2 cache memory is controlled by the PL/PCI bridge chip in the system board chip-set (see page 23 for a description, and details of timing patterns and tag size). A single HP cache memory module consists of 256 KB or 512 KB of direct mapped, write-back, synchronous *pipelined burst*, 8.5 ns static random access memory (SRAM). The chip-set does not support asynchronous or *burst* SRAM modules.

Main Memory

There are six main memory module sockets, arranged in three banks (A to C). One bank is already occupied by the pair of *single interline memory modules* (SIMMs) that contain the 16 MB or 32 MB of memory that is supplied with the computer.

Different banks can have different capacities (8, 16, 32 or 64 MB), but must be composed of identical pairs of modules (2×4, 2×8, 2×16 or 2×32 MB). By installing a pair of 32 MB SIMMs in every bank, first removing the memory modules that were supplied with the computer, the maximum capacity of 192 MB of main memory can be attained.

The banks can be filled, or left empty, in any order. However, there is a performance advantage to filling the banks in the order A, B, C. The explanation for this is outlined in the description of the cache memory controller on page 23.

Each bank that is used must contain a pair of identical modules: the same speed (60 or 70 ns), the same width (32-bit or 36-bit), and the same technology (*extended data out*, EDO, or *fast page mode*, FPM). Different banks can contain different speed modules (but the computer will work at the speed of the slowest bank). Different banks can contain different width modules (but parity and error correcting codes, ECC, are not enabled if any 32-bit width pairs of modules are used). Different banks can contain different technology modules.

The following table indicates the recommended capacities of main memory.

Operating System	Minimum Memory Capacity	Recommended Memory Capacity
Windows 3.11	4 to 8 MB	12 to 16 MB
Windows 95	8 MB	16 to 24 MB
Windows NT	12 MB	24 to 32 MB
OS/2	4 to 8 MB	16 MB

The *Setup* program automatically detects which memory module capacity, speed, and type is installed in each bank. Individual pages of memory can be configured as cacheable or non-cacheable by software or hardware. They can also be enabled and disabled by hardware or software.

Error Correcting Code Operation

Error correcting code (ECC) is available when using 36-bit memory modules. The original 32-bit modules must be removed so that the memory is populated exclusively by 36-bit modules. The appropriate field must be set in the **Memory** sub-menu of the **Configuration** menu of the *Setup* program.

Using ECC, a single bit error in any 72-bit line of memory (64 data bits plus 8 parity bits) is corrected automatically and transparently. A double bit error causes an NMI to be generated, and the computer to be halted.

If more than two bits are faulty within any given 72-bit line, the effect is the same as it would have been without error correction. The effect of executing a faulty instruction is always unpredictable, and might cause the program to 'hang'. The effect of reading a faulty data word is often similarly unpredictable, but can sometimes be tolerated (for instance, it might merely appear as a corrupted pixel on a video display).

An extra delay is introduced in the chip set while it is performing the ECC conversions, so causing ECC memory to have a slower access than non-ECC memory. Moreover, ECC memory modules are available only in 70 ns FPM technology.

Devices on the PCI Bus

PCI Device	Device Name		Device Number	Function	AD[xx]	Chip-set Interrupt Connection			
	DT	MT				INTA	INTB	INTC	INTD
PL/PCI bridge	TXC		0 (00h)	0	11	—	—	—	—
PCI/ISA bridge	PIIX3		15 (0Fh)	0	26	—	—	—	—
IDE controller				1		—	—	—	—
USB controller				2		—	—	—	—
Integrated graphics controller	S3 Trio 64V2		13 (0Dh)	0	24	A	—	—	—
PCI slot #1	J4	J6	7 (07h)	—	18	A	B	C	D
PCI slot #2	J3	J11	10 (0Ah)	—	21	D	A	B	C
PCI slot #3	J1	J5	6 (06h)	—	17	C	D	A	B
PCI slot #4 (minitower models)	—	J12	12 (0Ch)	—	23	B	C	D	A
PCI Proprietary slot (desktop models)	—	—	11 (0Bh)	—	22	C	D	A	B

The distribution of the interrupt lines is described more fully on page 82.

Models without any PCI boards, such as the Matrox Millennium Graphics controller or the Ethernet Network controller, are supplied with a PCI terminator. This should be plugged into any PCI slot, and removed if ever a PCI accessory board is subsequently installed.

Integrated Drive Electronics (IDE)

The IDE controller is implemented as part of the PIIX3 chip (the PCI/ISA bridge). It is driven from the PCI bus, and has PCI-Master capability. It supports Enhanced IDE (EIDE) and Standard IDE. To use the Enhanced IDE features the drives must be compliant with Enhanced IDE.

Up to four IDE devices are supported: two (one master and one slave) connected to the primary channel, and two (one master and one slave) to the secondary channel. The primary channel is fitted with an IDE cable with two connectors. The secondary channel is fitted with an IDE cable with one or two connectors (one for the desktop models, two for the minitower models). If a single device (a hard disk drive or a CD-ROM drive) is attached

to a channel, it should be in the master position (the connector that is closest to the system board, unless the markings on the cables state otherwise).

It is possible to mix a fast and a slow device, such as a hard disk drive and a CD-ROM, on the same channel without affecting the performance of the fast device. The BIOS sends a command to each drive to determine, automatically, the fastest configuration that it supports. However, in general, the primary channel cable is recommended for hard disk drives, and the secondary channel cable for CD-ROM drives.

Transfer Rates Versus Modes of Operation

The controller supports 32-bit Windows I/O transfers. Five PIO modes, and three DMA modes are supported. The five supported PIO modes allow the following transfer rates.

Mode	0	1	2	3	4
Cycle time (ns)	600	383	240	180	120
Transfer rate (MB/s)	3.33	5.22	8.33	11.1	16.7

The three DMA modes allow the following transfer rates:

Mode	0	1	2
Cycle time (ns)	480	150	120
Transfer rate (MB/s)	4.2	13.3	16.7

Disk Capacity Versus Modes of Addressing

The amount of addressable space on a hard disk is limited by three factors: the physical size of the hard disk, the addressing limit of the IDE hardware, and the addressing limit of the BIOS. The Extended-CHS addressing scheme allows larger disk capacities to be addressed than under CHS, by performing a translation. If the *Setup* field has been set to **automatic**, the logical block addressing (LBA) mode will be selected for each device that supports it.

	Cylinders per Device	Heads per Cylinder	Sectors per Track	Bytes per Sector	Bytes per Device
CHS	64	16	1024	512	528 M
ECHS	64	256	1024	512	8.4 G
LBA	-	-	256 M (= 2 ²⁸)	512	137 G

2 System Board

Devices on the PCI Bus

Universal Serial Bus (USB) Controller

When the *HP Vectra VL 5/xxx Series 5* and *XA 5/xxx PCs* were first released, they were preloaded with the Microsoft Windows 95 operating system, version SR2. The Microsoft Supplement 2.1 software, which provides support of the Universal Serial Bus, was not available. When it becomes available, it can be obtained from the Hewlett-Packard World Wide Web site: <http://www.hp.com/go/vectrasupport/>

You can verify that your PC has Windows 95 support for the USB installed by clicking on the “Add Software” folder in the Windows 95 Control Panel, and see if OSR 2.1 WDM/supplement is installed. If it is not listed, you should install the Microsoft Supplement 2.1 software.

USB works only if the USB interface has been enabled within the *HP Setup* program. Currently, only the Microsoft Windows 95 operating system provides support for the USB.

Devices on the ISA Bus

ISA Device	Index	Data
Super I/O	15Ch	15Dh
Little Ben (HP ASIC)	496h	497h

Super I/O Controller

The *Super I/O* chip (37C932) is part of the chip set, and is described on page 26.

The computer is supplied with a Logitech 2-button mouse, and a C3758A keyboard with the following features:

- Space bar power on, to start the computer from the *Off* state (if **power on from keyboard** is enabled in the *Setup* program).
- Windows key (next to the keys), which has the same effect as clicking the “Start” button on the Windows 95 task bar.
- Pull-down key (next to the right key), which has the same effect as clicking the right mouse button.

Serial EEPROM

The computer uses 4 Kbit of Serial EEPROM implemented within a single 512 K × 8-bit ROM chip. Serial EEPROM is ROM in which one byte at a time can be returned to its unprogrammed state by the application of appropriate electrical signals. In effect, it can be made to behave like very slow, non-volatile RAM. It is used for storing the contents of the CMOS memory (the tattoo string, the serial number, and the parameter settings for the *Setup* program), even during long periods of the computer being unplugged from the mains supply.

When installing a new system board, the Serial EEPROM will have a blank serial number field. This will be detected automatically by the BIOS, which will then prompt the user to enter the serial number which is printed on the identification label on the back of the computer.

2 System Board

Devices on the ISA Bus

Flash EEPROM (the System ROM)

The computer uses 256 KB of Flash EEPROM implemented within a single 256 K × 8-bit ROM chip (or in two 128 K × 8-bit chips). Flash EEPROM is ROM in which the whole memory can be returned to its unprogrammed state by the application of appropriate electrical signals to its pins. It can then be reprogrammed with the latest firmware.

The System ROM contains: 64 KB of system BIOS (including the boot code, the ISA and PCI initialization, RPO, DMI, the *Setup* program and the Power-On Self-Test routines, plus their error messages); 32 KB of video BIOS; 32 KB of Plug-and-Play code; and 32 KB of power management code. The functions of these are summarized in Chapters 4 and 5.

Updating the System ROM

The System ROM can be updated with the latest BIOS. This can be downloaded, as a compressed file, from the *HP Electronic Services*. You must specify the model of the computer since the utility which is supplied for a different model cannot be used with this one. (More information is given in the “Hewlett-Packard Support and Information Services” chapter in the *User's Guide* that was supplied with the computer).

The compressed file, once downloaded, can be executed. This causes it to be expanded out into a number of files, including:

- the Flash EEPROM reprogramming utility program, **phlash.exe**
- the BIOS upgrade file, **HA0700xx.FUL**
- the binary file, **PFMHA106.bin**
- the batch file, **flash.bat**
- a number of ***.txt** files, giving information about the new version of the BIOS, and instructions on how to install it.

The *Phlash* utility must be run from a diskette.

Do not switch off the computer until the system BIOS update procedure has completed, successfully or not, otherwise irrecoverable damage to the ROM may be caused. The control panel switches are automatically disabled to prevent accidental interruption of the flash programming process.

System Board Switches

Five of the *system board switches* (whose location is shown on page 20) set the working frequencies for the computer, as summarized on page 31. The others set the configuration for the computer, as summarized in the table on the next page.

Switch	Functions of the System Board Switches
1-4,7-8	Bus frequencies (see the table on page 31)
5	Password: Open = enabled (default) Closed = disabled / clear User and Administrator passwords
6	Clear CMOS: Open = normal (default) Closed = clear CMOS (to reload the <i>Setup</i> program defaults)
9	Keyboard space-bar power-on: Open = disabled Closed = enabled (default)
10	Product identification: Open = normal operation (default) Closed = clear the product identification field in the CMOS memory

By setting switch SW6 in the **Closed** position, not only is the configuration data cleared (in the CMOS memory and the Serial EEPROM), but also all the Plug-and-Play data that had been saved in the Serial EEPROM. However, the serial number, the tattooing string, the date and the time are each retained.

By setting switch SW9 in the **Closed** position, the Power-On Space-Bar function is enabled. Note, though, that it must *also* be enabled in the **Power-On Space-Bar** field of the Power Menu in the *Setup* program.

Turning the computer on, with switch SW10 in the **Closed** position, clears the product identification field in the BIOS, and causes the computer to prompt for the new information. By identifying the product correctly (after replacing a defective system board by a new one), the BIOS is able to tailor itself for the particular product, and to enable the appropriate features.

2 System Board

Devices on the ISA Bus

Updating the BIOS Before Considering Replacing the System Board

If the computer is faulty, but it starts up correctly, and the fault is not clearly due to the system board hardware, then it is advisable to check the BIOS version number. The BIOS version number can be found from the summary screen, or the *Setup* program, obtained by pressing **[Esc]** or **[F2]**, respectively, when the computer has just been restarted, as described in Chapter 4.

If it is not the current version of the BIOS, the System ROM should be flashed with the new version, as described on the previous page. The computer should then be re-run to see if this has cleared the problem.

Little Ben

Little Ben is an HP application specific integrated circuit (ASIC), designed to be a companion to the Super I/O chip. It is described on page 73.

Other PCI and ISA Accessory Devices Under Plug and Play

Plug and Play is an industry standard for automatically configuring the computer's hardware. When you start the computer, the Plug and Play system BIOS can detect automatically which hardware resources (IRQs, DMAs, memory ranges, and I/O addresses) are used by the system-based components.

All PCI accessory boards are Plug and Play, although not all ISA boards are. Check the accessory board's documentation if you are unsure.

The computer is PCI 2.1 compliant, and PnP 1.1 compliant. This meets the "Windows 95 Required" level for Plug and Play. Accessory boards which are Plug and Play are automatically configured by the operating system (Windows 95) or by the BIOS (other operating systems).

In general, in a Plug and Play configuration, resources for an ISA board have to be reserved first (using a utility under Windows 95 or ICU for DOS/Windows) and then you can plug in your board. If you want to install an ISA board when running a non Plug-and-Play operating system, such as Windows for Workgroups, you have to reserve the resources for the board using the ICU (for Windows). Failure to do so may lead to resource conflicts.

The procedure for installing an ISA accessory board that is not Plug and Play in Windows 3.11 or Windows 95 is described in the *User's Guide* that is supplied with the computer.

Interface Devices and Mass-Storage Drives

This chapter describes the video, mass storage, audio and network devices which are supplied with the computer. It also summarizes the pin connections on internal and external connectors.

S3 Trio 64V2 Graphics Controller Chip

Most models of the *HP Vectra VL 5/xxx Series 5 PC* are supplied with a graphics controller chip integrated on the system board. This 64-bit PCI Ultra VGA graphics controller can be characterized as follows:

- 100% compatible with IBM[®] VGA display standard
- 32-bit video memory access with 1 MB, 50 ns, EDO, video DRAM. Increased to 64-bit access when an additional 1 MB DRAM is installed
- integrated 24-bit RAMDAC
- fully programmable Pixel Clock Generator up to 170 MHz
- 60 MHz clock for video memory
- fast linear addressing with full software relocation
- green power saving features
- playback acceleration, continuous interpolation on X, continuous interpolation on Y
- DDC 2B compliant.

Video Memory

1 MB is fitted as standard. Two sockets are provided for installation of an additional 1 MB (two modules, each with a 512 KB, 60 ns surface mount chip). The installed video memory capacity is detected automatically by the BIOS.

The controller gives 32-bit video memory access, with 1 MB of video RAM fitted. This is increased to 64-bit access when the additional 1 MB upgrade is installed.

There is no orientation key to determine the polarity of the upgrade chips, so care must be exercised to align the point on the chips with the cut edge of the socket. A special extraction tool (5041-2553) is needed when removing them again.

Video Modes

Standard and Enhanced Video Graphics Array (VGA) modes are available. Hardware acceleration of graphical user interface (GUI) operations is provided, and acceleration for 8, 16 and 32-bit pixel depths.

The following table details the standard VGA modes which are currently implemented in the video BIOS. These modes are supported by standard BIOS functions. The video BIOS (which is mapped contiguously in the address range C0000h to C7FFFh) contains all the routines required to configure and access the graphics subsystem.

Standard VGA Modes

Mode No.	Standard	Interface Type	Resolution	No. of Colors	Vertical Refresh (Hz)	Horizontal Refresh (kHz)	Dot Clock (MHz)
00h	VGA	text	40 x 25 chars	b/w	70	31.5	25.175
00h*	VGA	text	40 x 25 chars	b/w	70	31.5	25.175
00h+	VGA	text	40 x 25 chars	b/w	70	31.5	28.322
01h	VGA	text	40 x 25 chars	16	70	31.5	25.175
01h*	VGA	text	40 x 25 chars	16	70	31.5	25.175
01h+	VGA	text	40 x 25 chars	16	70	31.5	28.322
02h	VGA	text	80 x 25 chars	b/w	70	31.5	25.175
02h*	VGA	text	80 x 25 chars	b/w	70	31.5	25.175
02h+	VGA	text	80 x 25 chars	b/w	70	31.5	28.322
03h	VGA	text	80 x 25 chars	16	70	31.5	25.175
03h*	VGA	text	80 x 25 chars	16	70	31.5	25.175
03h+	VGA	text	80 x 25 chars	16	70	31.5	28.322
04h	VGA	graphics	320 x 200	4	70	31.5	25.175
05h	VGA	graphics	320 x 200	4	70	31.5	25.175
06h	VGA	graphics	640 x 200	2	70	31.5	25.175
07h	VGA	text	80 x 25 chars	b/w	70	31.5	28.322
07h+	VGA	text	80 x 25 chars	b/w	70	31.5	28.322
0Dh	VGA	graphics	320 x 200	16	70	31.5	25.175
0Eh	VGA	graphics	640 x 200	16	70	31.5	25.175
0Fh	VGA	graphics	640 x 350	b/w	70	31.5	25.175
10h	VGA	graphics	640 x 350	16	70	31.5	25.175
11h	VGA	graphics	640 x 480	2	60	31.5	25.175
12h	VGA	graphics	640 x 480	16	60	31.5	25.175
13h	VGA	graphics	320 x 200	256	70	31.5	25.175

3 Interface Devices and Mass-Storage Drives

S3 Trio 64V2 Graphics Controller Chip

The extended modes supported by the video BIOS are:

Extended Video Modes with 1 MB DRAM

Extended Mode No.	VESA Mode No.	Interface Type	Resolution	No. of Colors	Vertical Refresh (Hz)	Horizontal Refresh (kHz)	Dot Clock (MHz)
4Eh	207h	graphics	1152 x 864	256	60	55	80.000
4Fh	208h	graphics	1280 x 1024	8	60	63.7	110.000
51h	212h	graphics	640 x 480	16.7 M	60	31.5	25.000
52h	213h	graphics	640 x 400	16.7 M	70	31.5	25.000
54h	10Ah	text	132 x 43 chars	16	70	31.5	40.000
55h	109h	text	132 x 25 chars	16	70	31.5	40.000
65h	10Dh	graphics	320 x 200	32,768	70		12.540
66h	10Eh	graphics	320 x 200	65,536	70		12.540
67h	10Fh	graphics	320 x 200	16.7 M	70		12.540
68h	100h	graphics	640 x 400	256	70	31.5	25.175
69h	101h	graphics	640 x 480	256	60	31.5	25.175
69h	101h	graphics	640 x 480	256	72	37.9	31.500
69h	101h	graphics	640 x 480	256	75	37.5	31.500
69h	101h	graphics	640 x 480	256	85	45	36.000
6Ah	102h	graphics	800 x 600	16	60	37.9	40.000
6Ah	102h	graphics	800 x 600	16	72	48.1	50.000
6Ah	102h	graphics	800 x 600	16	75	47.5	49.500
6Ah	102h	graphics	800 x 600	16	85	53.6	56.000
6Bh	103h	graphics	800 x 600	256	60	37.9	40.000
6Bh	103h	graphics	800 x 600	256	72	48.1	50.000
6Bh	103h	graphics	800 x 600	256	75	46.8	49.500
6Bh	103h	graphics	800 x 600	256	85	53.6	56.000
6Ch	104h	graphics	1024 x 768	16	60	48.4	65.000
6Ch	104h	graphics	1024 x 768	16	70	56.5	75.000
6Ch	104h	graphics	1024 x 768	16	75	60.2	80.000
6Ch	104h	graphics	1024 x 768	16	85	68.7	95.000
6Dh	105h	graphics	1024 x 768	256	60	48.4	65.000
6Dh	105h	graphics	1024 x 768	256	70	56.5	75.000
6Dh	105h	graphics	1024 x 768	256	75	60.0	80.000
6Dh	105h	graphics	1024 x 768	256	85	68.7	95.000
6Eh	106h	graphics	1280 x 1024	16	60		110.000
70h	110h	graphics	640 x 480	32,768	60	31.5	25.175
70h	110h	graphics	640 x 480	32,768	72	37.5	31.500
70h	110h	graphics	640 x 480	32,768	75	37.5	31.500
70h	110h	graphics	640 x 480	32,768	85	45	36.000

3 Interface Devices and Mass-Storage Drives

S3 Trio 64V2 Graphics Controller Chip

Extended Mode No.	VESA Mode No.	Interface Type	Resolution	No. of Colors	Vertical Refresh (Hz)	Horizontal Refresh (kHz)	Dot Clock (MHz)
71h	111h	graphics	640 x 480	65,536	60	31.5	25.175
71h	111h	graphics	640 x 480	65,536	72	37.5	31.500
71h	111h	graphics	640 x 480	65,536	75	37.5	31.500
71h	111h	graphics	640 x 480	65,536	85	45	36.000
72h	112h	graphics	640 x 480	16.7 M	60	31.5	25.175
72h	112h	graphics	640 x 480	16.7 M	72	37.9	31.500
72h	112h	graphics	640 x 480	16.7 M	75	37.5	31.500
72h	112h	graphics	640 x 480	16.7 M	85	45	36.000
73h	113h	graphics	800 x 600	32,768	60	37.9	40.000
73h	113h	graphics	800 x 600	32,768	72	48.1	50.000
73h	113h	graphics	800 x 600	32,768	75	46.8	49.500
73h	113h	graphics	800 x 600	32,768	85	53.6	57.000
74h	114h	graphics	800 x 600	65,536	60	37.9	40.000
74h	114h	graphics	800 x 600	65,536	72	48.1	50.000
74h	114h	graphics	800 x 600	65,536	75	46.8	49.500
74h	114h	graphics	800 x 600	65,536	85	53.6	57.000

Extended Video Modes with 2 MB DRAM

Extended Mode No.	VESA Mode No.	Interface Type	Resolution	No. of Colors	Vertical Refresh (Hz)	Horizontal Refresh (kHz)	Dot Clock (MHz)
6Fh	107h	graphics	1280 x 1024	256	60	65	55.000
6Fh	107h	graphics	1280 x 1024	256	72	77.7	65.000
6Fh	107h	graphics	1280 x 1024	256	75	79.5	67.000
75h	115h	graphics	800 x 600	16.7 M	60	37.9	40.000
75h	115h	graphics	800 x 600	16.7 M	72	41.8	50.000
75h	115h	graphics	800 x 600	16.7 M	75	46.8	49.500
75h	115h	graphics	800 x 600	16.7 M	85	53.6	57.000
76h	116h	graphics	1024 x 768	32,768	60	48.9	65.000
76h	116h	graphics	1024 x 768	32,768	70	56.5	75.000
76h	116h	graphics	1024 x 768	32,768	75	60.2	80.000
76h	116h	graphics	1024 x 768	32,768	85	68.7	95.000
77h	117h	graphics	1024 x 768	65,536	60	48.9	65.000
77h	117h	graphics	1024 x 768	65,536	70	56.5	75.000
77h	117h	graphics	1024 x 768	65,536	75	60.2	80.000
77h	117h	graphics	1024 x 768	65,536	85	68.7	95.000
7Ch	120h	graphics	1600 x 1200	256	48.5i	62.00	67.000

3 Interface Devices and Mass-Storage Drives

S3 Trio 64V2 Graphics Controller Chip

Available Video Resolutions

Drivers are supplied with the computer. At the time of release, these bear the version number: A.02.04. The following table lists the available video resolutions using these drivers. The available resolutions may be different with later versions of each of these drivers.

	Resolution	Number of colors	Refresh Rate (Hz)	Memory
Windows 95	640 x 480	16, 16M 256, 64K	60 60, 72, 75, 85	1 MB
	800 x 600	16, 256, 64K	60, 72, 75, 85	
	1024 x 768	256	60, 72, 75, 85	
	640 x 480	16M	60, 72, 75, 85	2 MB
	800 x 600	16M	60, 72, 75, 85	
	1024 x 768	64K	60, 72, 75, 85	
	1280 x 1024	256	60, 75, 85	
	1600 x 1200	256	60	
Windows 3.11	640 x 480	16 256, 32K, 64K	60 60, 72, 75, 85	1 MB
	800 x 600	256, 32K, 64K	60, 72, 75, 85	
	1024 x 768	256	60, 72, 75, 85	
	640 x 480	16M	60, 72, 75, 85	2 MB
	800 x 600	16M	60, 72, 75, 85	
	1024 x 768	32K, 64K	60, 72, 75, 85	
	1280 x 1024	256	60, 75, 85	
	1600 x 1200	256	60	
Windows NT 4.0 or 3.5x	640 x 480	16 256, 64K	60 60, 72, 75, 85	1 MB
	800 x 600	256, 64K	60, 72, 75, 85	
	1024 x 768	256	60, 72, 75, 85	
	640 x 480	16M	60, 72, 75, 85	2 MB
	800 x 600	16M	60, 72, 75, 85	
	1024 x 768	64K	60, 72, 75, 85	
	1280 x 1024	256	60, 75, 85	
	1600 x 1200	256	60	
Windows OS/2 Warp	640 x 480	16 256, 64K	60 60, 72, 75, 85	1 MB
	800 x 600	256	60, 72, 75, 85	
	1024 x 768	256	60, 72, 75, 85	
	640 x 480	16M	60, 72, 75, 85	2 MB
	800 x 600	64K	60, 72, 75, 85	
	1024 x 768	64K	60, 72, 75, 85	
	1280 x 1024	256	60, 75	

If Video Plug and Play is **enabled** in *Setup*, and a DDC monitor is detected, *Setup* will automatically configure the best refresh rate. For non DDC monitors, or when video Plug and Play is **disabled**, refresh rates can be changed in *Setup*.

The number of colors supported is limited by the graphics card and the video RAM. The resolution/refresh-rate combination is limited by a combination of the display, the graphics card, and the video RAM.

Connectors

The layout of the pins for the DB15 VGA socket are depicted on page 62.

The Video Electronics Standards Association (VESA) defines a standard video connector, variously known as the VESA *feature* connector, *auxiliary* connector, or *pass-through* connector. This connector (whose pin names are listed in a table on page 58) is integrated on the system board, and is connected directly to the pixel data bus and the synchronization signals.

The graphics controller supports an output-only VESA *feature* connector in VGA mode. It is disabled by default and must be enabled in the *Setup* program. Use of the VESA feature connector will disable the 1 MB video memory upgrade, if one is installed. Only the standard 1 MB of video memory will be used.

Troubleshooting

To get the hardware configuration information, click on the “Control Panel/Display/Settings/Advanced Properties” menu in Windows 95. This gives information of the form: Manufacturer=S3, Chip Type=775 Rev E, DAC Type=Internal, Memory=1 MB, Features=DirectDraw, Software Version=4.0.

The “Software Version” is the version number of the driver builder. To obtain the driver version, you need to click on the “System/Device Manager/Display Adapter/S3 Trio 64V2 Hewlett-Packard VL5” menu. To obtain the version number of Microsoft DirectDraw, find the **Ddraw.dll** file, and click on Properties with the right mouse button.

Matrox MGA Millennium Graphics Controller Board

All models of the *HP Vectra XA 5/xxx PC* and a few models of the *HP Vectra VL 5/xxx Series 5 PC* are supplied with a Matrox MGA Millennium PCI graphics controller on a board fitted in a PCI accessory slot. The on-board MGA-2064W processor communicates with the Pentium processor along the PCI bus. The controller can be characterized as follows:

- 100% hardware- and BIOS-compatible with IBM[®] VGA display standard
- 64-bit video memory access
- Hardware acceleration of graphical user interface (GUI) operations
- Support for up to 8 MB Window RAM (WRAM) at 50 ns
- Integrated 24-bit, 220 MHz RAMDAC
- Pixel clock maximum frequency of 135 MHz
- Green power saving features
- Standard and Enhanced Video Graphics Array (VGA) modes
- Acceleration for 3D, playback, MPEG (when an optional upgrade module from Matrox is fitted), continuous interpolation on X, replication on Y
- DDC 2B compliant.

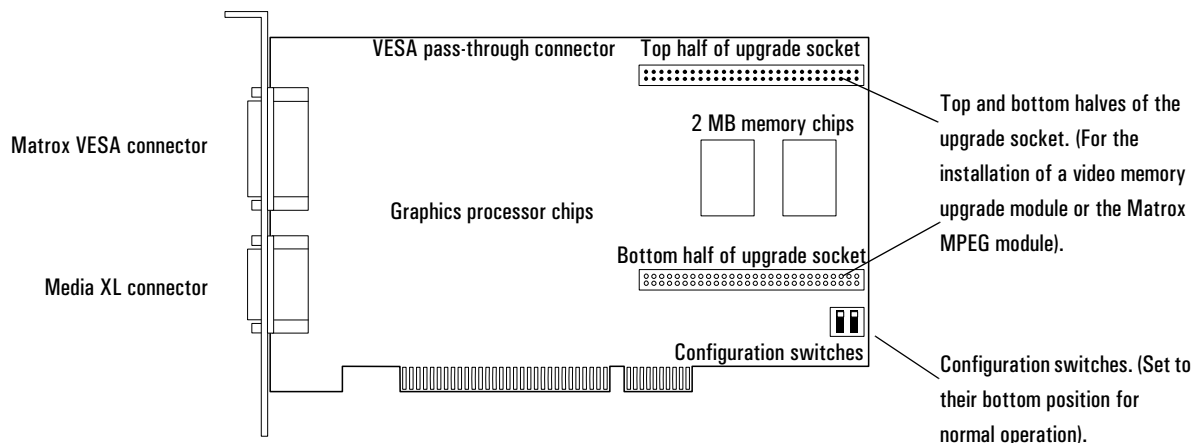

Connectors

The Video Electronics Standards Association (VESA) defines a standard video connector, variously known as the VESA *feature* connector, *auxiliary* connector, or *pass-through* connector. The video controller supports an output-only VESA *feature* connector in VGA mode. This connector (whose pin names are listed in a table on page 58) is integrated on the PCI board, is connected directly to the pixel data bus and the synchronization signals, and is automatically enabled all of the time.

There are two connectors on the back panel: the normal DB15 VGA connector, for connecting to HP displays, and a Media XL connector (used by the MPEG accessory, not supported by HP). The layout of the pins for the DB15 VGA connector are shown on page 62.

If you install a VESA-standard video accessory board that uses the MGA video adapter, connect the accessory board's cable to the VESA pass-through connector on the board.

Video Memory

The video memory (also known as window RAM, or WRAM) is a local block of RAM for holding two major data structures: the double buffer (to hold one frame steady on the screen whilst the next one is being processed), and the Z-buffer (for storing depth information for each pixel). It is dual ported, so that it can be inputting and outputting simultaneously. There is also hardware support for Gouraud shading, Phong shading and texture mapping.

The Matrox MGA Millennium graphics controller board is supplied with 2 MB of video memory. This can be upgraded to 4 MB with a D3557B upgrade module, or to 8 MB with an MGA-MIL/MOD6 upgrade module (ordered from Matrox). The upgrade socket can alternatively be used for the installation of the Matrox MGA Media XL upgrade module (also ordered from Matrox) to support MPEG. The switch settings do not have to be changed.

Available Video Resolutions

The number of colors supported is limited by the graphics device and the video memory. The resolution/color/refresh-rate combination is limited by a combination of the display driver, the graphics device, and the video memory. If the resolution/refresh-rate combination is set higher than the display can support, you risk damaging the display.

3 Interface Devices and Mass-Storage Drives

Matrox MGA Millennium Graphics Controller Board

Resolution	Number of colors	Maximum Refresh Rate (Hz)	Memory
640 x 480	256, 64K, 16M	200	2 MB
800 x 600	256, 64K, 16M		
1024 x 768	256, 64K	120	
1280 x 1024	256	110	
1600 x 1200	256	85	
640 x 480	256, 64K, 16M	200	4 MB
800 x 600	256, 64K, 16M		
1024 x 768	256, 64K, 16M	120	
1280 x 1024	256, 64K, 16M (24 bpp)	110	
1600 x 1200	256, 64K	85	
640 x 480	256, 64K, 16M	200	8 MB
800 x 600	256, 64K, 16M		
1024 x 768	256, 64K, 16M	120	
1280 x 1024	256, 64K, 16M	110	
1600 x 1200	256, 64K, 16M (24 bpp)	85	

The table below summarizes the 2D video resolutions which are supported. Note, though, SCO Unix only supports 15 bpp (bits per pixel), instead of 16 bpp, and does not support 32 bpp; OS/2 does not support 24 bpp.

Number of Colors	256	64 K Hi-Color	16.7 M True-Color	16.7 M True-Color
Bits per Pixel	8	16	24	32
640 X 480	2 MB, 200 Hz			
800 X 600	2 MB, 200 Hz			
1024 X 768	2 MB, 120 Hz		4 MB, 120Hz	
1152 X 882 ¹	2 MB, 120 Hz		4 MB, 120 Hz	
1280 X 1024	2 MB, 110 Hz	4 MB, 110 Hz		8 MB, 110 Hz
1600 X 120	2 MB, 85 Hz	4 MB, 85 Hz	8 MB, 85 Hz	Not supported

¹1152 X 882 is not preset on HP displays

The maximum 2D resolutions for any given video memory capacity and color scale can be found from the following table:

Number of Colors	256	64 K Hi-Color	16.7 M True-Color	16.7 M True-Color
Bits per Pixel	8	16	24	32
2 MB	1600 X 1200	1024 X 768	800 X 600	800 X 600
4 MB	1600 X 1200	1600 X 1200	1280 X 1024	1152 X 882 ¹
8 MB	1600 X 1200	1600 X 1200	1600 X 1200	Not supported

^{1.} 1152 X 882 is not preset on HP displays

Drivers are supplied with the computer. At the time of release, these bear the following version numbers:

- 1.22p for Windows for Workgroups 3.11
- 3.17b61 for Windows 95
- 2.30 for Windows NT 4.0.

Video BIOS

The Matrox MGA Millennium board has a flash video BIOS that can be updated like a system BIOS, using a flash utility. This is achieved as follows:

- 1 Create a DOS boot diskette, and copy the following files to it:
 - xxxxxxxx.bin (a binary file whose name depends on the version)
 - dos4gw.exe
 - progbios.exe
 - updbios.bat
- 2 Switch off the PC, and take out the Matrox board (this is necessary since the board switches are not accessible whilst it is in place).
- 3 Set SW-1, on the Matrox board, to ON (BIOS unprotected).
- 4 Reinstall the Matrox board, insert the boot diskette, and switch on the PC.
- 5 Run the **updbios.bat** command file or **progbios.exe -i *.bin**.
- 6 Switch off the PC, and take out the boot diskette and the Matrox board.
- 7 Set SW-1, on the Matrox board, to OFF (BIOS protected).
- 8 Reinstall the Matrox board, and switch on the PC.

Executing **progbios.exe -d** allows the BIOS revision date to be checked. The video BIOS revision number can be checked by clicking on the MGA control panel (Display Properties/MGA Settings/Advanced for Windows 95).

HP Ethernet 10/100 BaseT Network Board

The *HP Ethernet 10/100 BaseT Network Board* is supplied on all models of the *HP Vectra XA 5/xxx PC*. It is based on the AMD PCnet-PCI-II 79C971 network processor chip.

On desktop models, it is installed in a dedicated PCI accessory slot underneath the internal, hard disk drive, rear-shelf, plugged into the PCI Junior slot that is situated on the rear of the double-sided backplane board.

On the rear panel there are two RJ-45 unshielded twisted-pair (UTP) connectors, whose pin-out is shown in the diagram on page 62. One is fully compliant with the 10-BaseT, 10 Mbits per second, ISO 8802-3 (IEEE/ANSI 802.3) standard. It supports the Remote Power-On (RPO) feature that is described on page 71.

The other RJ-45 connector is fully compliant with the 100-BaseT, 100 Mbits per second, ISO 8802-3 (IEEE/ANSI 802.3u) standard. This connector supports the Remote Wake-Up feature, but not Remote Power-On.

The two lights indicate which of the network sockets is connected (they are not link lights or activity lights). The controller automatically detects which of the two connectors is presently in use.

There is a socket, on the network board, to support an Option ROM of up to 256 KB. This is not compatible with the Option ROM chip from the Enhanced Ethernet Network board.

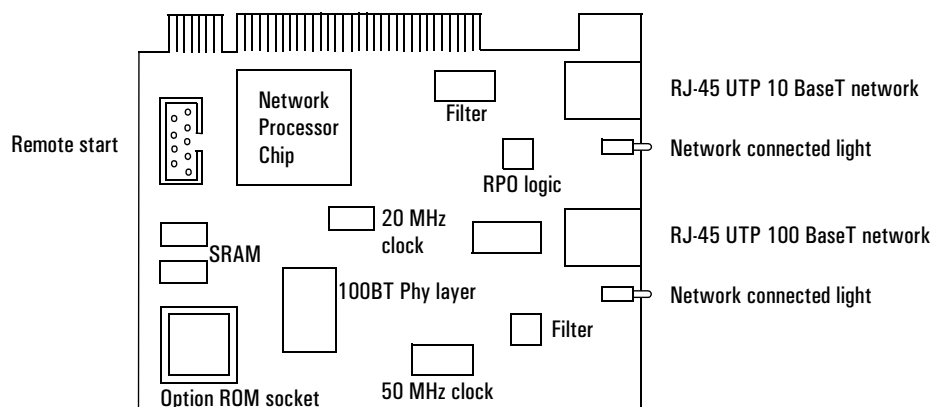

Remote Power-On (RPO) There is a cable from the Remote Start connector, on the network board, to the External Start connector, on the system board. This is used by the Remote Power-On feature (RPO) that is described on page 71. This cable must be routed through the hole in the chassis. Not doing so, and allowing the cable to be routed with the flexible disk drive and IDE cables, will raise the risk of radio frequency interference (RFI) cross-talk.

The board is supplied with power, even whilst the rest of the computer is turned off, via a line called *VStandby* on the External Start Connector. This connector also carries the control lines which the network board uses to turn on the main power supply, and to send or receive other control and status information.

When shutdown into its RPO state, the 10 BaseT side of the board draws 30 mA, well within the 50 mA capability of the special RPO power supply. (The 100 BaseT side of the board would draw more than 50 mA if connected, and hence does not support RPO).

Look-Ahead Packet Processing (LAPP)

Standard drivers wait until a complete frame has been received before processing it, and passing it to the application buffer. They then wait for the controller buffer to be empty before starting to receive the next frame.

If there are many small frames, and a large amount of Windows application switching, the network utilization rate can fall below 50%. The PC-Net controller utilization of the system bus is about 4%. The remaining 96% can be used by suitable LAPP drivers to start inter-frame data transfers to the application stack buffer. By reducing the latency between frame reception, the network utilization and throughput is increased.

Drivers

The board can be configured completely by software (no switches or jumpers need changing). Drivers for the network board are supplied with the computer. At the time of release, these bear the version number P.01.05.

HP Enhanced Ethernet Network Board

The *HP Enhanced Ethernet Network Board* is supplied on some models of the *HP Vectra VL 5/xxx Series 5 PC*. It is based on the AMD PCnet-PCI-II 79C970 network processor chip.

On desktop models, it is installed in a dedicated PCI accessory slot underneath the internal, hard disk drive, rear-shelf, plugged into the PCI Junior slot that is situated on the rear of the double-sided backplane board.

This controller is fully compliant with the 10-BaseT, 10 Mbits per second, ISO 8802-3 (IEEE/ANSI 802.3) standard. There is a socket to support an Option ROM of up to 32 KB. On the rear panel there is an RJ-45 unshielded twisted-pair (UTP) connector, whose pin-out is shown in the diagram on page 62.

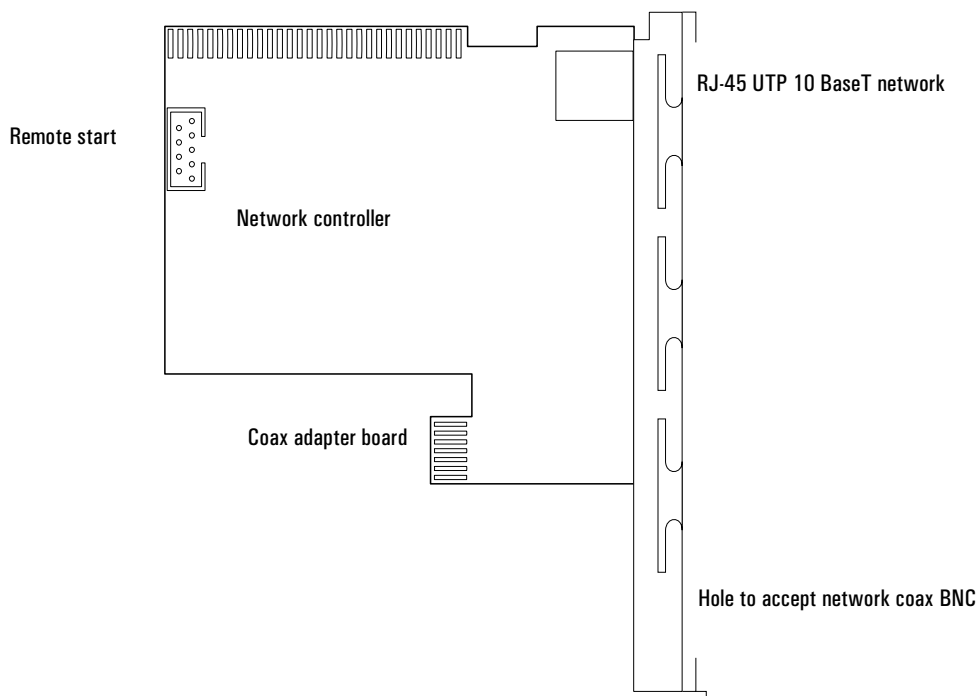

Remote Power-On (RPO) There is a cable from the Remote Start connector, on the network board, to the External Start connector, on the system board. This is used by the Remote Power-On feature (RPO) that is described on page 71. This cable must be routed through the hole in the chassis. Not doing so, and allowing the cable to be routed with the flexible disk drive and IDE cables, will raise the risk of radio frequency interference (RFI) cross-talk.

The board is supplied with power, even whilst the rest of the computer is turned off, via a line called *VStandby* on the External Start Connector. This connector also carries the control lines which the network board uses to turn on the main power supply, and to send or receive other control and status information.

When shutdown into its RPO state, the board draws 20 mA, well within the 50 mA capability of the special RPO power supply.

Drivers

The board can be configured completely by software (no switches or jumpers need changing). Drivers for the network board are supplied with the computer. At the time of release, these bear the version number T.01.00.

Audio Controller

The Creative Labs CT2970 SoundBlaster 16 audio interface, supplied on some models in an ISA slot, can be summarized as follows:

- line-out (stereo) jack: 20 Hz to 20 kHz frequency response, 83 dB signal to noise ratio, 0.2% total harmonic distortion
- headphones jack: 2 W PMPO per channel, 32 Ω load
- speaker connector: 0.2% total harmonic distortion
- line-in (stereo) jack: 15 k Ω , 0 V to 2 V peak-to-peak
- CD audio-in connector: 15 k Ω , 0 V to 2 V peak-to-peak
- microphone input: 600 Ω , dynamic, 30 mV to 200 mV peak-to-peak
- MIDI /joystick interface connector: MPU-401 UART compatible
- 8-bit and 16-bit stereo sampling: 5 kHz to 44.1 kHz
- Creative OPL3 synthesizer: 20 polyphonic voices
- typical electrical current: +5 V (250 mA), +12 V (250 mA), -12 V (50 mA)

3 Interface Devices and Mass-Storage Drives

Audio Controller

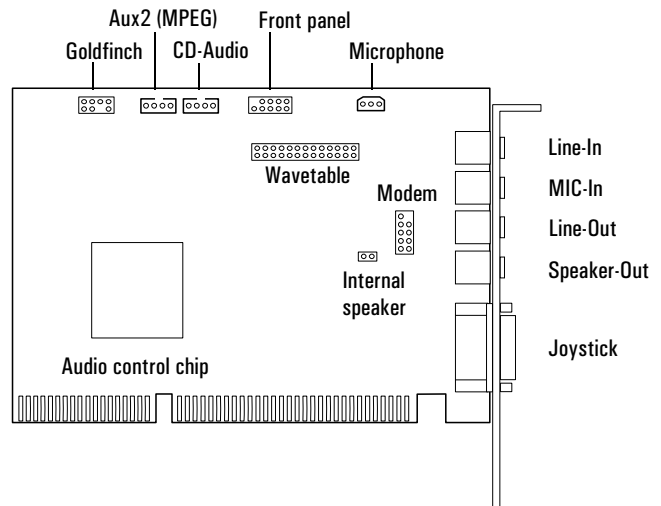

The board is compliant with Microsoft PC 95 revised / PC 96. It has a full duplex codec, and supports a volume control on the front panel.

Drivers

Drivers for the audio board, working with the Windows NT operating system, are supplied with the computer. These are required since the board is Plug-and-Play, but the operating system is not. It is the user's responsibility to avoid conflicts with other devices using the same resources (such as IRQ, DMA and I/O lines). The user can use the configuration manager to change the board settings, choosing either the default configuration, or changes to any of the parameters.

Windows for Workgroups 3.11 drivers rely on ICU and its configuration manager, which must be installed. Windows 95 is a true Plug-and-Play operating system, and does not need such drivers.

Mass-Storage Drives

The IDE controller is described on page 34. The flexible disk controller is described on page 26.

Hard Disk Drives

A 3.5-inch hard disk drive is supplied on an internal shelf in some models.

	2.5 GB IDE	1.6 GB IDE
HP product number	D2784-69001	D4621-69001
Manufacturer	Quantum	Quantum
Product name	Fireball TM 2550	Fireball TM 1700

Flexible Disk Drives

A 3.5-inch, 1.44 MB flexible disk drive (D2035B) is supplied on the top front-access shelf of all models.

CD-ROM Drives

Most models have a 8× IDE CD-ROM drive (D4381A) supplied in a 5.25-inch front-access shelf.

	8× IDE
HP product number	D4381A
Manufacturer	Hitachi
Product name	CDR-7930
Formatted storage capacity	650 MB

If a disk is still in the drive after power failure or drive failure, the disk can be reclaimed by inserting a stout wire, not unlike a straightened paper-clip, into the dedicated hole at the bottom of the door.

In order to allow correct CD-ROM drive detection by the *Setup* program, leave the device configuration jumper on the rear connector in the cable select (CS) or master (MA) positions.

3 Interface Devices and Mass-Storage Drives

Connectors and Sockets

Connectors and Sockets

IDE Hard Disk Drive Data Connector			
Pin	Signal	Pin	Signal
1	Reset#	2	Ground
3	HD7	4	HD8
5	HD6	6	HD9
7	HD5	8	HD10
9	HD4	10	HD11
11	HD3	12	HD12
13	HD2	14	HD13
15	HD1	16	HD14
17	HDO	18	HD15
19	Ground	20	orientation key
21	DMARQ	22	Ground
23	DIOW#	24	Ground
25	DIOR#	26	Ground
27	IORDY	28	SPSYNC:CSEL
29	DMACK#	30	Ground
31	INTRQ	32	IOCS16#
33	DA1	34	PDIAG#
35	DA0	36	DA2
37	CS0#	38	CS1#
39	DASP#	40	Ground

Flexible Disk Drive Data Connector			
Pin	Signal	Pin	Signal
1	Ground	2	LDENSEL#
3	Ground	4	Microfloppy
5	Ground	6	EDENSEL
7	Ground	8	INDX#
9	Ground	10	MTEN1#
11	Ground	12	DRSELO#
13	Ground	14	DRSEL1#
15	Ground	16	DTENO#
17	Ground	18	DIR#
19	Ground	20	STP#
21	Ground	22	WRDATA#
23	Ground	24	WREN#
25	Ground	26	TRKO#
27	Ground	28	WRPRDT#
29	Ground	30	RDDATA#
31	Ground	32	HDSEL1#
33	Ground	34	DSKCHG#

Status Panel Connector			
Pin	Signal	Pin	Signal
1	LCK_LED_K	2	LCK_LED_A
3	PWR_LED_K	4	PWR_LED_A
5	not connected	6	common
7	Push_On	8	RED_LED_A
9	HDD_LED_K	10	HDD_LED_A
11	_Reset	12	Ground
13	LCK_PUSH2	14	LCK_PUSH2

External Start and Remote Start Connectors			
Pin	Signal	Pin	Signal
1	ExternalStart	2	Ground
3	Wake1#	4	Wake2#
5	not connected	6	Wake3#
7	PowerGood	8	not connected
9	Vstandby	10	orientation key

Audio Board Connectors

Wavetable Connector			
Pin	Signal	Pin	Signal
1	Ground	2	not connected
3	Ground	4	MIDI input
5	Ground	6	Vcc
7	Ground	8	MIDI output
9	Ground	10	Vcc
11	Ground	12	not connected
13	not connected	14	Vcc
15	Ground	16	not connected
17	Ground	18	+12 V
19	Ground	20	Line-in (right)
21	Ground	22	-12 V
23	Ground	24	Line-in (left)
25	Ground	26	Reset B

Goldfinch Connector			
Pin	Signal	Pin	Signal
1	Line-in (right)	2	Analog ground
3	Line-in (left)	4	Analog ground
5	orientation key	6	Analog ground
7	Analog ground	8	Analog ground

Aux2 MPEG Connector	
Pin	Signal
1	Left channel
2	Ground
3	Ground
4	Right channel

Int. Speaker Connector	
Pin	Signal
1	Power signal out
2	Analog ground

CD Audio Connector	
Pin	Signal
1	Ground
2	Left channel
3	Ground
4	Right channel

Modem Connector			
Pin	Signal	Pin	Signal
1	Analog ground	2	orientation key
3	Line-in	4	Analog ground
5	Line-out (left)	6	Analog ground
7	Line-out (right)	8	Modem speaker
9	Analog ground	10	Microphone in

Front Panel Connector			
Pin	Signal	Pin	Signal
1	Ground	2	orientation key
3	Headphones left	4	Head return left
5	Headphones right	6	Head return right
7	Volume low limit	8	Volume DC cntl
9	Volume high limit	10	not used

Microphone Connector	
Pin	Signal
2nd ring:	3 Signal and power
3rd ring:	2 Ground
1st ring:	1 Signal and power

3 Interface Devices and Mass-Storage Drives

Connectors and Sockets

PCI Connector							
Pin	Signal	Pin	Signal	Pin	Signal	Pin	Signal
B1	-12 V	A1	TRST#	B47	AD[12]	A47	AD[11]
B2	TCK	A2	+12 V	B48	AD[10]	A48	Ground
B3	Ground	A3	TMS	B49	+ 3.3 V	A49	AD[09]
B4	TDO	A4	TDI	B50	AD[08]	A50	C/BE#[0]
B5	+5 V	A5	+5 V	B51	AD[07]	A51	+ 3.3 V
B6	+5 V	A6	INTA#	B52	Ground	A52	AD[06]
B7	INTB#	A7	INTC#	B53	AD[05]	A53	AD[04]
B8	INTD#	A8	+5 V	B54	AD[03]	A54	Ground
B9	Ground	A9	reserved	B55	Ground	A55	AD[02]
B10	reserved	A10	PRSNT#	B56	AD[01]	A56	AD[00]
B11	+ 3.3 V	A11	reserved	B57	+5 V	A57	+5 V
	orientation key		orientation key	B58	+5 V	A58	+5 V
B12	reserved	A12	reserved	B59	+5 V	A59	+5 V
B13	Ground	A13	RESET#	B60	ACK64#	A60	REQ64#
B14	CLK	A14	+ 3.3 V		orientation key		orientation key
B15	Ground	A15	GNT#	B61	reserved	A61	Ground
B16	REQ#	A16	Ground	B62	Ground	A62	C/BE#[7]
B17	+ 3.3 V	A17	reserved	B63	C/BE#[5]	A63	C/BE#[6]
B18	AD[31]	A18	AD[30]	B64	C/BE#[4]	A64	+ 3.3 V
B19	AD[29]	A19	Ground	B65	Ground	A65	PAR64
B20	Ground	A20	AD[28]	B66	AD[63]	A66	AD[62]
B21	AD[27]	A21	AD[26]	B67	AD[61]	A67	Ground
B22	AD[25]	A22	+ 3.3 V	B68	+ 3.3 V	A68	AD[60]
B23	Ground	A23	AD[24]	B69	AD[59]	A69	AD[58]
B24	C/BE#[3]	A24	IDSEL	B70	AD[57]	A70	Ground
B25	AD[23]	A25	Ground	B71	Ground	A71	AD[56]
B26	+ 3.3 V	A26	AD[22]	B72	AD[55]	A72	AD[54]
B27	AD[21]	A27	AD[20]	B73	AD[53]	A73	+ 3.3 V
B28	AD[19]	A28	Ground	B74	Ground	A74	AD[52]
B29	Ground	A29	AD[18]	B75	AD[51]	A75	AD[50]
B30	AD[17]	A30	AD[16]	B76	AD[49]	A76	Ground
B31	C/BE#[2]	A31	+ 3.3 V	B77	+ 3.3 V	A77	AD[48]
B32	Ground	A32	FRAME#	B78	AD[47]	A78	AD[46]
B33	IRDY#	A33	Ground	B79	AD[45]	A79	Ground
B34	+ 3.3 V	A34	TRDY#	B80	Ground	A80	AD[44]
B35	DEVSEL#	A35	Ground	B81	AD[43]	A81	AD[42]
B36	Ground	A36	STOP#	B82	AD[41]	A82	+ 3.3 V
B37	LOCK#	A37	+ 3.3 V	B83	Ground	A83	AD[40]
B38	PERR#	A38	SDONE	B84	AD[39]	A84	AD[38]
B39	Ground	A39	SBO#	B85	AD[37]	A85	Ground
B40	SERR#	A40	Ground	B86	+ 3.3 V	A86	AD[36]
B41	+ 3.3 V	A41	C/BE#[1]	B87	AD[35]	A87	AD[34]
B42	AD[15]	A42	PAR	B88	AD[33]	A88	Ground
B43	+ 3.3 V	A43	+ 3.3 V	B89	Ground	A89	AD[32]
B44	+ 3.3 V	A44	+ 3.3 V	B90	reserved	A90	reserved
B45	AD[14]	A45	+ 3.3 V	B91	reserved	A91	Ground
B46	Ground	A46	AD[13]	B92	Ground	A92	reserved

16-bit ISA Connector (8-bit ISA uses the A and B connectors)			
Pin	Signal	Pin	Signal
B1	Ground	A1	CHCHK#
B2	RESDRV	A2	SD7
B3	+5 V	A3	SD6
B4	IRQ9	A4	SD5
B5	-5 V	A5	SD4
B6	DRQ2	A6	SD3
B7	-12 V	A7	SD2
B8	NOWS#	A8	SD1
B9	+12 V	A9	SD0
B10	Ground	A10	CHRDY
B11	SMWTC#	A11	AENx
B12	SMRDC#	A12	SA19
B13	IOWC#	A13	SA18
B14	IORC#	A14	SA17
B15	DEK3#	A15	SA16
B16	DRQ3	A16	SA15
B17	DAK1#	A17	SA14
B18	DRQ1	A18	SA13
B19	REFRESH#	A19	SA12
B20	BCLK	A20	SA11
B21	IRQ7	A21	SA10
B22	IRQ6	A22	SA9
B23	IRQ5	A23	SA8
B24	IRQ4	A24	SA7
B25	IRQ3	A25	SA6
B26	DAK2#	A26	SA5
B27	TC	A27	SA4
B28	BALE	A28	SA3
B29	+5 V	A29	SA2
B30	OSC	A30	SA1
B31	Ground	A31	SA0
D1	M16#	C1	SBHE#
D2	IO16#	C2	LA23
D3	IRQ10	C3	LA22
D4	IRQ11	C4	LA21
D5	IRQ12	C5	LA20
D6	IRQ15	C6	LA19
D7	IRQ14	C7	LA18
D8	DAK0#	C8	LA17
D9	DRQ0	C9	MRDC#
D10	DAK5#	C10	MWTC#
D11	DRQ5	C11	SD8
D12	DAK6#	C12	SD9
D13	DRQ6	C13	SD10
D14	DAK7#	C14	SD11
D15	DRQ7	C15	SD12
D16	+5 V	C16	SD13
D17	MASTER16#	C17	SD14
D18	Ground	C18	SD15

3 Interface Devices and Mass-Storage Drives

Connectors and Sockets

Power Supply Connector for System Board			
Pin	Signal	Pin	Signal
1	PwrGood	13	Remote_On
2	VSTDBY	14	-5 V supply
3	+5 V supply	15	-12 V supply
4	+5 V supply	16	+12 V supply
5	+5 V supply	17	Ground
6	+5 V supply	18	Ground
7	+5 V supply	19	Ground
8	+3.3 V supply	20	Ground
9	+3.3 V supply	21	Ground
10	+3.3 V supply	22	Ground
11	+3.3 V supply	23	Ground
12	+3.3 V supply	24	Ground

Battery Pack Connector	
Pin	Signal
1	VBATT
2	orientation key
3	reserved
4	Ground

USB Connector	
Pin	Signal
1	Vcc
2	Data +
3	Data -
4	Ground

Socket Pin Layouts

<h4>RJ-45 UTP Connector</h4> <p>Not Used - 4 RxD1 - 3 TxD2 - 2 TxD1 - 1</p> <p>5 - Not Used 6 - RxD2 7 - Not Used 8 - Not Used</p>	<h4>VGA Connector</h4> <p>Red - 1 Green - 2 Blue - 3 Not Used - 4 Ground - 5</p> <p>6 - Ground 7 - Ground 8 - Ground 9 - Not used 10 - Ground 11 - Not Used 12 - Not Used 13 - H-Sync 14 - V-Sync 15 - Not Used</p>
<h4>Keyboard and Mouse Connector</h4> <p>Not Used - 6 +5Vdc - 4 Not Used - 2</p> <p>5 - Clock 3 - Ground 1 - Data</p>	<h4>Parallel Port Connector</h4> <p>Strobe - 1 DO - 2 D1 - 3 D2 - 4 D3 - 5 D4 - 6 D5 - 7 D6 - 8 D7 - 9 ACK - 10 BUSY - 11 PE - 12 SLCT - 13</p> <p>14 - AUTO FD 15 - ERROR 16 - INIT 17 - SLIN 18 - Ground 19 - Ground 20 - Ground 21 - Ground 22 - Ground 23 - Ground 24 - Ground 25 - Ground</p>
<h4>Serial Port Connector</h4> <p>1 - CF (DCD) 2 - BB (RD) 3 - BA (TD) 4 - CD (DTR) 5 - AB (GND)</p> <p>(DSR) CC - 6 (RTS) CA - 7 (CTS) CB - 8 (RI) CE - 9</p>	

Summary of the HP/Phoenix BIOS

This chapter and the following two chapters give an overview of the features of the HP/Phoenix BIOS.

HP/Phoenix BIOS Summary

The System ROM contains the POST (power-on self-test) routines, and the BIOS: the System BIOS, video BIOS (for models with an integrated video controller), network BIOS (for models with a network controller), and low option ROM. This chapter, and the following one, give an overview of the following aspects:

- menu-driven *Setup* with context-sensitive help (in US English only), described next in this chapter.
- The address space, with details of the interrupts used, described at the end of this chapter.
- The Remote Power-On (RPO), which is the mechanism for turning on the computer remotely from the network, described later in this chapter.
- The Power-On-Self-Test or POST, which is the sequence of tests the computer performs to ensure that the system is functioning correctly, described in the next chapter.

The system BIOS is identified by the version number **HA.07.xx**. The procedure for updating the System ROM firmware is described on page 38.

Press **F2**, to run the *Setup* program, while the initial “Vectra” logo is being displayed immediately after restarting the PC. Alternatively, press **Esc** to view the summary configuration screen, an example of which is depicted on the next page. By default, this remains on the screen for 20 seconds, but by pressing **F5** once, it can be held on the screen indefinitely until **F1** is pressed. Pressing **F10** will cause the computer to be turned off.

XA/200 – Copyright 1997 Hewlett-Packard – HA.07.xx			
Any line of text can be entered here as a 'tattoo' for the computer			
BIOS version	HA.07.xx	PC Serial Number	FR54011111
CPU Date Code	N/A	LAN MAC address	08-0009-85-03-00
System RAM	: 32 MB	Processor type	: Pentium
Bank A	: 32 MB (EDO)	COM1	: 3F8H (Serial A)
Bank B	: None	COM2	: 2F8H (Serial B)
Bank C	: None	COM3	: None
Video RAM	: Not available	COM4	: None
System Cache	: 512KB (Synchronous)	LPT1	: 378H
Video Device	: Matrox (External)	LPT2	: None
1st IDE Device	: HDD 2500 MB	LPT3	: None
2nd IDE Device	: None	Flexible Disk A	: 1.44 MB
3rd IDE Device	: CD-ROM	Flexible Disk B	: None
4th IDE Device	: None	Display type	: Not Available
ISA PnP	: Not Installed	PCI Slot #1	: Not Installed
ISA PnP	: Not Installed	PCI Slot #2	: Not Installed
		PCI Slot #3	: Not Installed
<F1> to continue, <F2> to run Setup, <F10> to power off, <F5> to retain			

Setup Program

To run the *Setup* program, interrupt the POST by pressing **(F2)** when the **F2=Setup** message appears on the initial “Vectra” logo screen.

The band along the top of the screen offers five menus: Main, Configuration, Security, Power, and Exit. These are selected using the left and right arrow keys. Each menu is discussed in the following sub-sections. For a more complete description, see the *User’s Guide* that was supplied with the PC.

Main Menu

The Main Menu presents the user with a list of fields, such as “System Time” and “Key auto-repeat speed”. These can be selected using the up and down arrow keys, and can have their values changed using the **(F7)** and **(F8)** keys.

The “Item-Specific Help” field changes automatically as the user moves the cursor between the fields. It tells the user what the presently highlighted field is for, and what the options are.

Some fields are not changeable. Examples include fields that are for information only, and fields whose contents become “frozen” by the setting of a value in some other field. Such fields are displayed in a different color, without the “[” and “]” brackets. When the user moves the cursor with the up and down arrow keys, these fields are skipped.

Some fields disappear completely when a choice in another field makes their appearance inappropriate (for example, the “Key auto-repeat speed” and “Delay before auto-repeat” fields disappear when the user selects **Yes** in the “Running Windows 95” field, since these parameters can be set within the Windows 95 operating system).

Configuration Menu

The Configuration Menu does not have the same structure as the Main Menu and Power Menu. Instead of presenting a list of fields, it offers the user a list of sub-menus. Again, the user steps between the options using the up and down arrow keys, but presses the **(Enter)** key to enter the chosen sub-menu (and the **(Esc)** key to go back again when finished).

If access to devices has been disabled in the Security Menu, then the configuration of those devices on the Configuration Menu becomes frozen, as shown in the diagram below for Serial port A. The field becomes starred,

appears in a different color, and cannot be changed.

Phoenix BIOS Setup – Copyright 1985-95 Phoenix Technologies Ltd. Copyright 1997 Hewlett-Packard Rev. HA.07.xx			
Configuration			
Integrated I/O Ports			Item-Specific Help
Parallel port		[378h IRQ7]	Enables or disables the on-board parallel port at the specific address. 'Disabled' frees resources used by the port.
Parallel port mode		[Centronix TM]	
Serial port A		* 3F8h IRQ4	
Serial port B		[Disabled]	
[*] = The device is disabled for security reasons. To enable it, use the Security/Hardware Protection menu.			
F1 Help ESC Exit	↑ ↔	Select Item Select Menu	F7/F8 Change Values Enter Select > Sub-Menu
			F9 Setup Defaults F10 Previous Values

Disabling a device in the Configuration Menu (for example, Serial port B in the diagram above) has the advantage of freeing the resources (such as IRQs and peripheral addresses). Disabling a device in the Security Menu disables the access, not the device. It does not have the advantage of freeing the resources, but has the advantage of temporarily disabling the device without losing the configuration settings.

The **USB interface** field, in the USB Devices sub-menu, is **disabled** by default.

The **Modem IRQ** field, in the Modem sub-menu, is used when a modem accessory has been installed. It does not enable the IRQ on the modem. It is used to indicate, to the System BIOS, which of the IRQ lines should wake up the PC when the modem receives a ringing tone. It is only applicable with an APM 1.2 compatible operating system, such as Windows 95.

4 Summary of the HP/Phoenix BIOS

Setup Program

Security Menu

Sub-menus are presented for changing the characteristics and values of the User Password, the System Administrator Password, the amount of protection against use of the system's drives and network connections (using the Hardware Protection sub-menu), and the amount of protection against being able to boot from the system's drives and network connections (using the Start-Up Center sub-menu).

The minimum lengths of either type of password can be set to a specific number of characters, or to **none**. The maximum length of each is 32 characters. A limit can be set for the maximum number of retries that are permitted if the password is mistyped, and whether a delay should be imposed (of successively increasing lengths: 4 seconds, 8 seconds, 16 seconds, and finally 32 seconds) before successive retries are accepted (using the **exponential** setting for the "Lock Time Between Attempts" field).

The "User Password" sub-menu grants access to the keyboard lock timer option. Once this password has been set, the menu gives access to the main sub-menu of user preferences.

Under the "Hardware Protection" sub-menu, the following devices can have their access **enabled/disabled**: flexible disk controller, IDE controllers, serial and parallel ports, network controller. Writes to the flexible disk can be **disabled**, so as to prevent the exporting of data. Writes to the hard disk drive boot sector can be **disabled**, for instance as a protection against viruses.

Under the "Start-Up Center" sub-menu, the *Setup* program not only allows the user to select which devices are **enabled** or **disabled** for booting up the system, but also indicates their order of precedence when more than one is enabled: network, flexible disk drive, CD-ROM drive, or hard disk drive.

If the "Start from Network" field is not changeable with **F7** and **F8**, either wait until the 50% position on the histogram has been reached before pressing **F2**, or use **Esc** to go to the summary screen, and press **F2** from there.

If the system will not boot from the network when there is a hard disk drive present, disable the IDE and remove the hard disk drive.

Power Menu

The “Power” menu allows the user to set the standby delay. It also allows the system administrator to decide whether the network, serial ports, mouse, or space bar are enabled as a means of reactivating the system from *Standby* or *Suspend*. It is also possible to specify whether the network is enabled as a means of reactivating the system from *Off*, using the remote power-on (RPO) facility (as described in the next section of this chapter).

Power Saving and Ergonometry

Power-On from Space-Bar

The *power-on from the space-bar* function is enabled, provided that:

- The computer is connected to a Windows 95 keyboard (recognizable by the Power-On icon on the space bar).
- The computer is running the Windows 95 operating system.
- The function has not been disabled by setting SW-9 to **closed** on the system board switches.
- The function has not been disabled in the “Power” menu of the *Setup* program.

Soft Power Down

When the user requests the operating system to shutdown, the environment is cleared, and the computer is powered off. At the time of release, the drivers bear the version number A.01.00 (or SPD.02.01 for Windows NT 4.0). They are supplied with Windows NT and Windows 95. *Soft Power Down* is not available with OS/2.

The hardware to do this, and the complement function, *HP Off* (as described in the next section), is contained within the HP ASIC chip, LittleBen. This chip is described on page 73.

HP Off

If the user attempts to turn the PC off at the status panel, the PC logic will delay the shutting down of the power supply until it is safe to do so. *HP Off* protects the user from some types of unintentional data loss, providing a safe shutdown of running applications and unsaved files. It is available under the Windows 95 operating system provided that the appropriate driver is installed.

- 1 In the control panel, double-click on the Power icon.
- 2 Click on the **HP Off** tab to select *HP Off*, or on **Immediate Power Off** to cancel it.
- 3 Select the time-out period, between one and five seconds.

The time-out period is the delay during which the power-down command can be cancelled (whilst the **About to shut down Windows** message is displayed on the screen). If the user cancels, the computer is returned to normal operation; otherwise, the computer goes on to check if there are any unsaved files. If there are, it offers three choices: **yes** (to saving the unsaved changes, followed by shutdown), **no** (thereby shutting down without saving the changes), and **cancel** (to return to normal operation).

Remote Power-On (RPO)

Remote power-on (RPO) provides a way to turn on the computer from a communication channel, such as a Network or Modem, using facilities that have been incorporated in the Little Ben chip and the ExtStart connector. It allows system administrators, and authorized users, switch on the computer from anywhere over an Ethernet network, perform remote administration or other tasks, and return it to *Off* or *Suspend* mode afterwards.

Magic Packet

Magic packet is a standard for remote power-on and remote wake-up developed by HP and Advanced Micro Devices (AMD). The standard defines a Magic Packet frame as the computer's unique Ethernet *Media Access Control* (MAC) address (which it has stored in an EEPROM on the network board), repeated 16 times and encoded in a valid network packet.

Any Magic Packet-compatible management application (such as *HP Open-View Workgroup Node Manager*) can send a Magic Packet frame. An administrator can do this manually, or can incorporate it into a management script.

The packet travels over any type of Ethernet LAN to the target PC.

The only component not completely off in the computer is the network chip, which rests in a special low power mode. Power is supplied by a line called *VStandby*, on the ExtStart connector, whose pin layout is shown in the table on page 58, as long as the power cord is plugged in. The independent mini power supply provides the power necessary to keep one part of the network chip ready to receive a wake-up signal (see page 15 for electrical specifications). This is the only signal it can respond to in this state.

4 Summary of the HP/Phoenix BIOS

Power Saving and Ergonometry

The network chip sends a signal over the External Start connector, where it is received by the special network remote power chip. This in turn switches on the main power supply.

The PC starts normally from whatever operating system is installed, just as if the power supply had been switched on from the external power switch. The display does not itself need to have RPO. If a password has been set, the **start with keyboard locked** option must be enabled, to allow the operating system to boot.

Activity within the Setup Program

Since the user is not physically present, the level of security must be tighter. There must be a distinction between the user-boot process, and the RPO-boot process. HP provides all the necessary *Setup* options to keep users from interfering with the computer during the remote session.

Administrators can set the management package to toggle on options like:

- Keyboard lock mode: This offers the same suite of security features as the external “keyboard lock” button (keyboard, mouse, reset and power button disabled).
- Floppy disable: this makes sure the computer cannot be disrupted by re-booting from a diskette.

RPO is available when the POST routines have finished executing. It is initialized by an SMI signal which is triggered from the mains power button.

A power failure when the computer is in RPO mode will deactivate the RPO feature. RPO is intended for resource management (such as virus cleaners, nightly backups, etc.), not for crisis management (thunderstorm recovery, power failure, etc.).

Little Ben

Little Ben is an HP application specific integrated circuit (ASIC), designed to be a companion to the Super I/O chip, that is connected between the chip-set and the processor. It contains the following:

- BIOS timer
 - hardware wired 50 ms long 880 Hz beep module.
 - automatic blinker that feeds the LEDs module with a 1 Hz oscillator signal.
- security protection (access, flash and anti-virus protection)
 - For 128, 256 or 512 KB Flash EEPROMs.
 - For the Super I/O space: the Serial EEPROM, serial ports, parallel port and mass storage drives (disable write on Flexible Disk Drive, disable boot on any drive, disable use of any embedded drive)
- hard and soft control for the power supply (available with Windows NT and Windows 95, but not with OS/2)
- Advanced power management (APM) version 1.2 (available with Windows 95 and OS/2, but not with Windows NT)
- glue logic (such as programmable chip selects)

The computer can be turned on by typing the space-bar on the keyboard, or when it receives an external signal from a network board. The power consumption has been kept as low as possible. When *VccState* and *PowerGood* pins are both low, all output pins are in tri-state mode, except for *RemoteOnBen* which continues to be driven. This allows the computer to be powered from the standby power supply, and to be restarted even after a power loss has occurred.

When the user requests a ShutDown from the operating system, the environment is first cleared. Any request to turn off the computer, from the control panel, or from the operating system, can only be granted if the computer is not locked by Little Ben's lock bit (otherwise the power remains on, a red light is illuminated, and the buzzer is sounded).





The *SMI_OFF* signal is asserted if the Hard Soft Power Down mode (HSPD) is enabled when Little Ben is instructed to turn off the computer (via the status panel or soft power down). The BIOS first performs some RPO initialization, and then proceeds to power down the computer. If the watch-



4 Summary of the HP/Phoenix BIOS

Power Saving and Ergonometry

dog timer detects that the BIOS is inactive (and not reloading the timer once every 6 seconds), the computer is turned off without further BIOS acknowledgment.

The following table summarizes the main signals that drive or are driven by the Little Ben chip.

Signal ¹	Address	Description
SMI_OFF		User wants to power off: computer enters RPO shutdown mode (computer clock, HDDs all stopped; only RTC, Little Ben and network board still active)
SMI_RWU 	pin 69, LBen channel 7	Signal from RTC, FAX, control panel, and power key on keyboard. Magic Frame from network board: computer wakes up from RPO mode.
CoffeeBreak# 	pin 66, LBen channel 0	Connected to the lock button (coffee break) on the control panel.
ASL# 	pin 65, LBen channel 4	Connected to the Super IO Auto Soft Lock (ASL) timer. Reset by an interrupt from the keyboard or mouse.
APM chip-set SMI# 	pin 67, LBen channel 2	SMIs from the chip set pass first to Little Ben, then are sent on to the processor on the SMI# line
SMI#		
StopClk#		Stops the processor clock
SMI_CONFIG		Tells Little Ben that the processor is in SMM
SMI_ACT#		
SMI_TRIG_EN		
SMI channels	index Ah	Used to enable individual SMI channels during the boot process
SMI_EN	index Bh, bit 0	Enable general SMI generation (during the boot process)
SMI status register	index 10h	This register is cleared when the computer is re-booted
SM	index 11h, bit 1	When set, computer mains button is disabled
	index 11h, bit 2	When set, Flash ROM is write protected; Super IO space is write protected (Serial EEPROM access, serial ports configuration, parallel port configuration, flexible disk drive configuration)
	index 11h, bit 4	When set, flexible disk drive is write protected
PWD_EN	pin 21 index Dh, bit 3	Not used
Super Secure Mode	pin 64 (shared with FLPWPT#)	Not used

1.  indicates triggered on a rising edge;  indicates triggered on a falling edge

Advanced Power Management (APM)

The BIOS is APM 1.2 compliant, providing it with facilities for *advanced power management* (APM). APM is incorporated in Windows for Workgroups 3.11, Windows 95 and OS/2, but not Windows NT. A file called **power.exe** is needed for APM under DOS.

APM is a standard, defined by Intel and Microsoft, for a power-saving mode that is applicable under a wide range of operating systems. It supports the following modes: *Fully-on*, *Standby*, *Suspend*, *Hibernation* and *Off*. Of these, APM 1.2 supports *Fully-on*, *Standby*, *Suspend* and *Off*, as summarized in the following table.

	Fully-On	Standby	Suspend	Off
Brought about using:		Setup menu	Operating system	Operating system Status panel button
Resume events:		Keyboard Mouse	Keyboard Fax / Modem Network (RWU)	Space-bar Network (RPO)
Resume delay:		Instantaneous	A few seconds	Boot delay
Processor	Normal speed	Clock throttled (divided by 8)	Halted	Halted
Hard disk drive	Normal speed	Normal speed	Halted	Halted
Display	Normal operation	Blanked (< 30 W)	Blanked (< 5 W typ)	Blanked (< 5 W typ)
Power consumption	24 W to 47 W		< 30 W	< 3 W

The *Suspend* mode is managed at the operating system level only, from the Windows 95 Start menu. There is no longer the inter-activity between the *Setup* program and the operating system, and no longer a “sleep at” item on the *Setup* program menus, to avoid the BIOS from shutting down the system at the wrong moment.

RPO defines a variation from the standard *Off* state. In *RPO* mode, the main CPU hardware is off while a RPO function is powered by a power supply called *VStandby*. *VStandby* is active as soon as the computer is plugged in. RPO hardware can produce a triggering signal which turns on the computer.

4 Summary of the HP/Phoenix BIOS

Power Saving and Ergonometry

The following diagram gives a simplified view of the useful states that the computer can be in: the three *On* states (*Fully-On*, *Standby* and *Suspend*), the *RPO* state (when the CPU is *Off*, and the RPO hardware is powered by VStandby), the *Off* state (when everything is powered off), and the state that is caused by power failure or unplugging the computer.

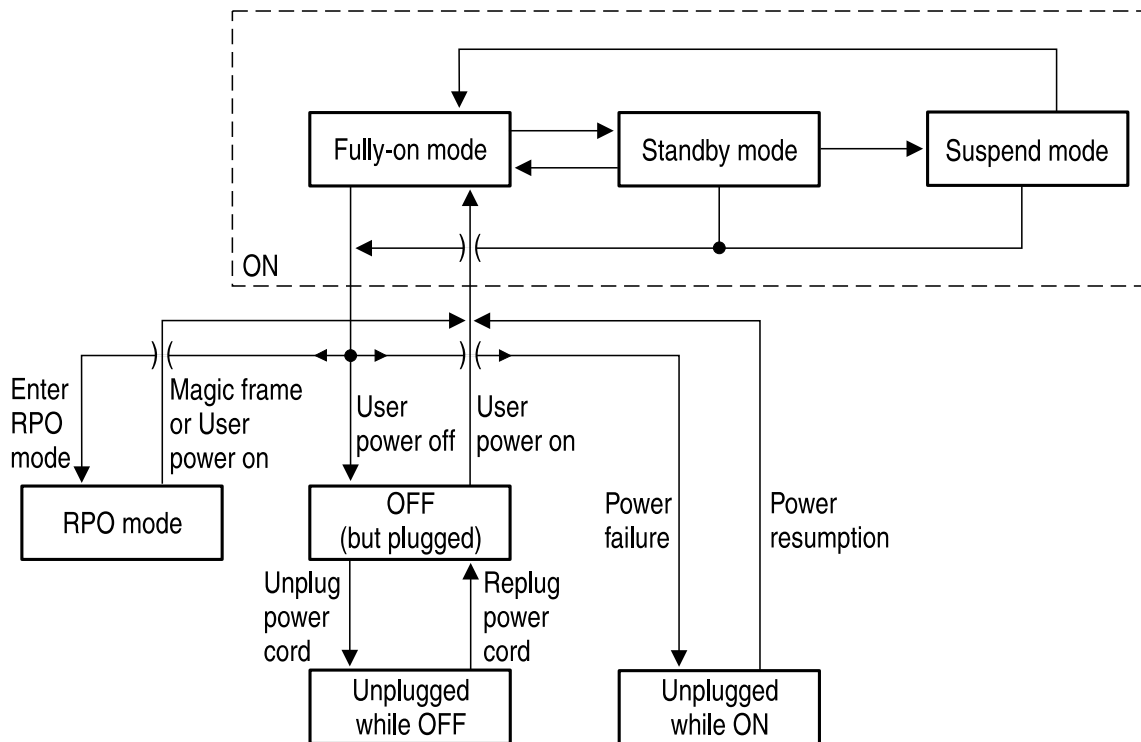

The following diagram gives a more accurate, more detailed account of the valid state changes.

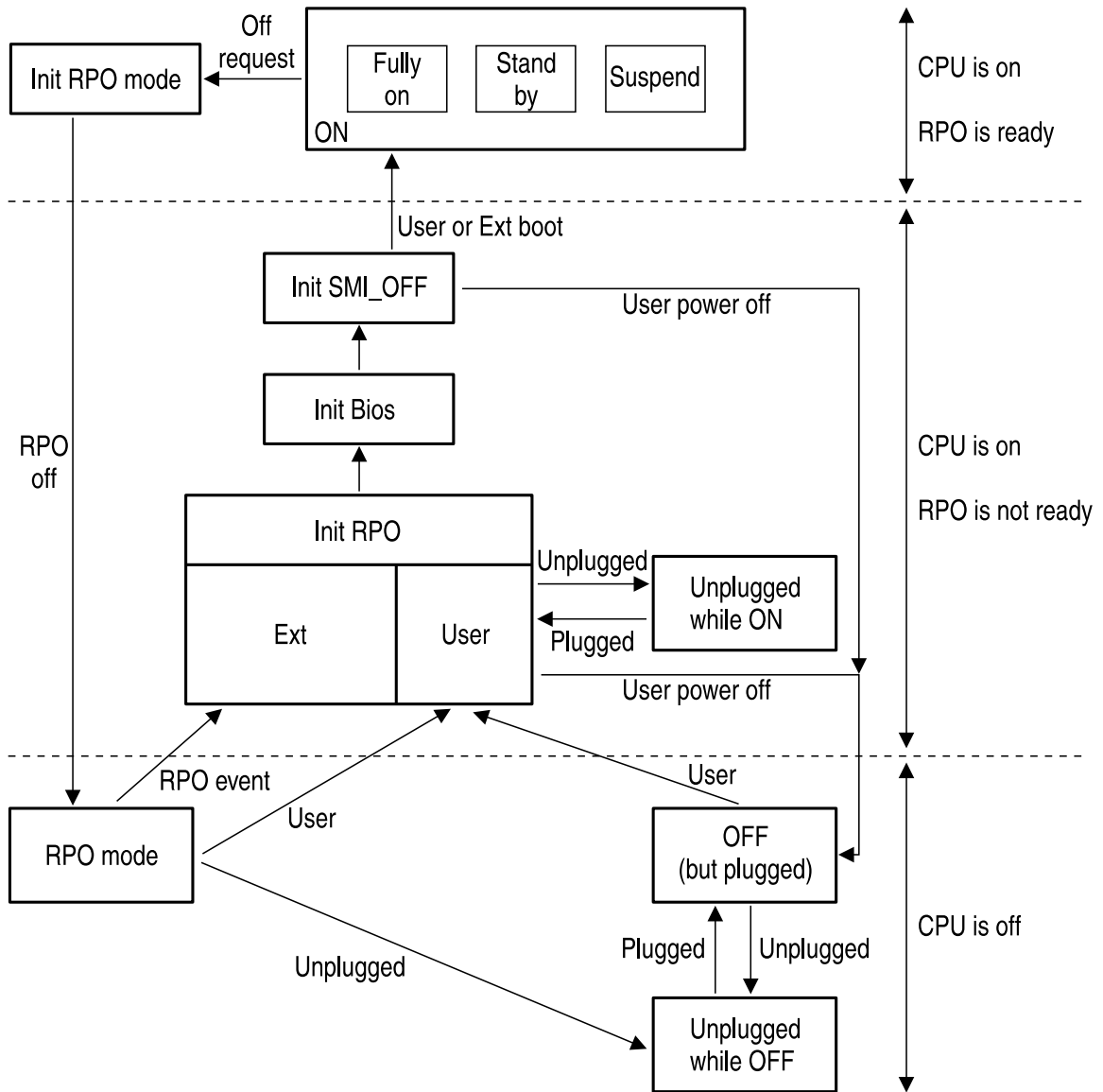

4 Summary of the HP/Phoenix BIOS

Power Saving and Ergonometry

Desktop Management Interface (DMI)

HP TopTOOLS 2 is an integrated, easy-to-use desktop management application for efficient inventory, configuration, fault and security management. It is fully DMI compliant. It provides facilities for real-time monitoring and management of over 300 attributes of the PC (both the local PC, and remote ones over the network).

HP Lock

The purpose of the *HP Lock* utility is to provide a more convenient, and more dynamic access to the security features of the PC than was previously possible. (Previously, it had been necessary to restart the PC, and to call the *Setup* program). It is available, on the *HP Vectra VL 5/xxx Series 5 PC* only, running the Windows 95 operation system.

Facilities are provided for:

- Passwords
- Lock options (such as screen hiding and screen saving)
- Start-up protection
- Disk drive access (enabled or disabled)
- Communications port access (enabled or disabled)

These can be accessed by clicking on the “Lock my HP Vectra PC” menu in the Control Panel. You can then use the “How to Lock”, “Lock Options” and “Advanced” menus.

The two options “Lock when entering Energy Saving Mode” and “Lock when activating Screen Saver” are currently under development. You will be able to download the completed software form the HP World Wide Web site:

<http://www.hp.com/go/vectrasupport/>.

BIOS Addresses

This section provides a summary of the main features of the HP system BIOS. This is software that provides an interface between the computer hardware and the operating system.

System Memory Map

Reserved memory used by accessory boards must be located in the area from C8000h to EFFFFh.

0 - 3FFh	Interrupt vector table	640 KB: The addresses 0-9FFFFh are collectively known as the Base memory area
400h - 4FFh	BIOS data area	
500h - 9EFFFh		
9F000h - 9FFFFh	Extended BIOS data area	
A0000h - BFFFFh	128 KB: Video memory area	
C0000h - C7FFFh	32 KB: Video BIOS area	
C8000h - D7FFFh	64 KB: available for accessory boards (used by the boot ROM, if configured in the <i>Setup</i> program)	
D8000h - EFFFFh	96 KB: available after the POST (for upper memory block, UMB, for example)	
F0000h - FFFFFh	64 KB: System BIOS area	
100000h - FFFFFFFFh	1 MB plus: Extended memory	

Product Identification

The reserved addresses in the 64 KB BIOS ROM data area, which contain various product identification and BIOS identification strings, are no longer accessed directly. Instead, the information is obtained from utilities in the Desk Management Interface (DMI).

4 Summary of the HP/Phoenix BIOS

BIOS Addresses

HP I/O Port Map (I/O Addresses Used by the System¹)

Peripheral devices, accessory devices and system controllers are accessed via the system I/O space, which is not located in system memory space. The 64 KB of addressable I/O space comprises 8-bit and 16-bit registers (called I/O ports) located in the various system components. When installing an accessory board, ensure that the I/O address space selected is in the free area of the space reserved for accessory boards (100h to 3FFh).

The following address map is not BIOS dependent, but is determined by the operating system. However, the *Setup* program can be used to change some settings. Beware that some of the I/O addresses are allocated dynamically.

I/O Address Ports	Function
0000h - 000Fh	DMA controller 1
0020h - 0021h	Interrupt controller 1
0040h - 0043h	Interval timer 1
0060h, 0064h	Keyboard controller
0061h	System speaker, or NMI status and control
0070h	NMI mask register, RTC and CMOS address
0071h	RTC and CMOS data
0081h - 0083h, 008Fh	DMA low page register
0092h	Alternate reset and A20 Function
00A0h - 00A1h	Interrupt controller 2
00C0h - 00DFh	DMA controller 2
00EAh - 00EBh	Internal port
00F0h - 00FFh	Co-processor error
0102h	Graphics controller (Matrox MGA)
0170h - 0177h	IDE hard disk drive controller secondary channel
01F0h - 01F7h	IDE hard disk drive controller primary channel
0200h - 0207h	Joystick port (Soundblaster)

1. If configured (legacy resources only).

4 Summary of the HP/Phoenix BIOS

BIOS Addresses

I/O Address Ports	Function
0220h - 022Fh	Audio interface 1 (Soundblaster)
0240h - 024Fh	Audio interface 2 (Soundblaster)
0260h - 026Fh	Audio interface 3 (Soundblaster)
0278h - 027Fh	Parallel port 2
0279h	IO read data port for ISA Plug and Play enumerator
0280h - 028Fh	Audio interface 4 (Soundblaster)
02E8h - 02EFh	Serial port 4
02F8h - 02FFh	Serial port 2
0300h - 0301h	MPU-401 MIDI interface 2 (Soundblaster)
0330h - 0331h	MPU-401 MIDI interface 1 (Soundblaster)
0370h - 0371h	Ultra I/O controller
0372h - 0375h	Secondary flexible disk drive controller
0376h	IDE hard disk drive controller secondary channel
0377h	Secondary flexible disk drive controller
0378h - 037Ah	Parallel port 1
0388h - 038Bh	Ad-lib / FM synthesized music (Soundblaster)
03B0h - 03DFh	Graphics controller (Matrox MGA)
03E8h - 03EFh	Serial port 3
03F0h - 03F5h	Primary flexible disk drive controller
03F6h	IDE hard disk drive controller primary channel
03F7h	Primary flexible disk drive controller
03F8h - 03FFh	Serial port 1
0496h - 049Fh	Internal ports (Little Ben)
0678h - 067Bh	Parallel port 2 if ECP mode is selected
0778h - 077Bh	Parallel port 1 if ECP mode is selected
0CF8h - 0CFh	Configuration registers for PCI devices

4 Summary of the HP/Phoenix BIOS

BIOS Addresses

DMA Channel Controllers

Only “I/O-to-memory” and “memory-to-I/O” transfers are allowed. “I/O-to-I/O” and “memory-to-memory” transfers are disallowed by the hardware configuration.

The system controller supports seven DMA channels, each with a page register used to extend the addressing range of the channel to 16 MB. The following table summarizes how the DMA channels are allocated.

First DMA controller (used for 8-bit transfers)	
Channel	Function
0	Available
1	SoundBlaster or ECP mode for parallel port
2	Flexible disk I/O
3	ECP mode for parallel port or SoundBlaster
Second DMA controller (used for 16-bit transfers)	
Channel	Function
4	Cascade from first DMA controller
5	SoundBlaster or Available
6	Available
7	Available or SoundBlaster

Interrupt Controllers

The system has two 8259A compatible interrupt controllers. They are arranged as a master interrupt controller and a slave that is cascaded through the master.

The following table shows how the master and slave controllers are connected. The Interrupt Requests (IRQ) are numbered sequentially, starting with the master controller, and followed by the slave.

IRQ (Interrupt Vector)		Interrupt Request Description
IRQ0(08h)		System Timer
IRQ1(09h)		Keyboard Controller
IRQ2(0Ah)	Slave IRQ	Cascade connection from INTC2 (Interrupt Controller 2)
	IRQ8(70h)	Real Time Clock
	IRQ9(71h)	Available for accessory board (ISA/PCI)
	IRQ10(72h)	SoundBlaster 3, or Available for accessory board (ISA/PCI)
	IRQ11(73h)	Available for accessory board (ISA/PCI)
	IRQ12(74h)	Mouse, or ISA accessory board
	IRQ13(75h)	Co-processor
	IRQ14(76h)	IDE, or ISA accessory board
	IRQ15(77h)	Secondary IDE or ISA/PCI accessory board
IRQ3(0Bh)		Serial Port 2, Serial Port 4, or ISA accessory board
IRQ4(0Ch)		Serial Port 1, Serial Port 3, or ISA accessory board
IRQ5(0Dh)		SoundBlaster 1, Parallel Port 2, or ISA accessory board
IRQ6(0Eh)		Flexible Disk Controller
IRQ7(0Fh)		SoundBlaster 2, Parallel Port 1, or ISA accessory board

Using the *Setup* program:

- IRQ3 can be made available by disabling serial ports 2 and 4.
- IRQ4 can be made available by disabling serial ports 1 and 3.
- IRQ5 can be made available by disabling the parallel port 2.
- IRQ7 can be made available by disabling parallel ports 1 and 2.

PCI Interrupt Request Lines

PCI devices generate interrupt requests using up to four PCI interrupt request lines (INTA#, INTB#, INTC#, and INTD#).

When a PCI device makes an interrupt request, the request is re-directed to the system interrupt controller. The interrupt request will be re-directed to one of the IRQ lines made available for PCI devices.

4 Summary of the HP/Phoenix BIOS

BIOS Addresses

The PCI interrupt lines A, B, C and D are spread across the four inputs of the interrupt router (which is part of the PCI/ISA bridge, in the PIIX3 chip). Since most PCI devices are single-function, this allows for an even distribution of the lines. The distribution is shown in the following diagram. In this, Slot 4 is present only on minitower models (and is omitted on desktop models); Slot R refers to the PCI proprietary slot on the rear side of the double sided backplane of desktop models (and is omitted on minitower models).

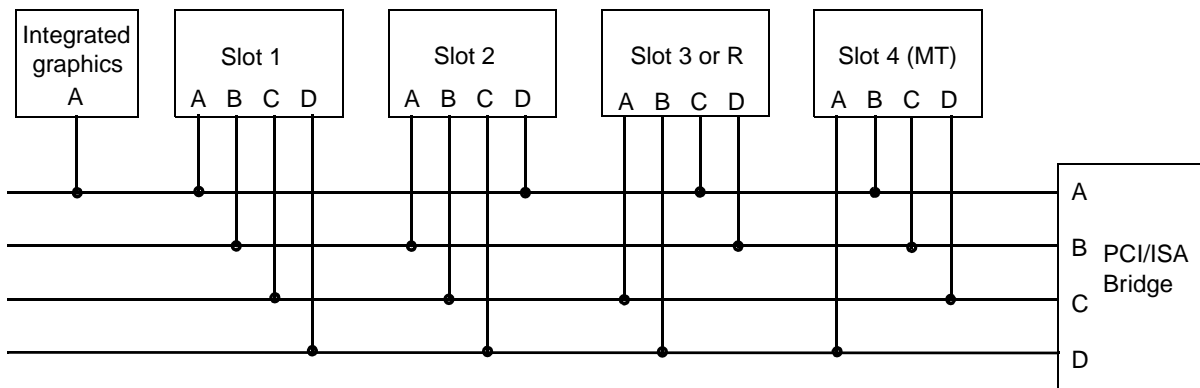

PCI interrupts are then mapped into ISA interrupts inside the PCI/ISA Bridge (in the PIIX3 chip), by configuring registers 60h through 63h.

Bit	Description
7	Routing of interrupts: when enabled, this bit routes the PCI interrupt signal to the PC-compatible interrupt signal specified in bits[3:0]. At reset, this bit is disabled (set to 1)
6:4	Reserved: read as 000
3:0	IRQ# Routing Bits: these bits specify which IRQ signal to generate. Possible values are: 3, 4, 5, 6, 7, 9, 10, 11, 12, 14, 15.

The possible choices given by the *Setup* program are 9, 10, 11, 15. If some of these are unavailable due to ISA cards, some interrupts will have to be shared.

The IDE controller is actually configured in *legacy mode*, and uses IRQ 14 (IRQ 15 for the secondary channel). The mode setting is in configuration byte 09h of the IDE controller, device 01h.

Power-On Self-Test and Error Messages

This chapter describes the Power-On Self-Test (POST) routines, which are contained in the computer's ROM BIOS, the error messages which can result, and the suggestions for corrective action.

Order in Which the Tests are Performed

Each time the system is powered on, or a reset is performed, the POST is executed. The POST process verifies the basic functionality of the system components and initializes certain system parameters.

The POST starts by displaying a graphic screen with the initial “Vectra” logo when the PC is restarted. If the POST detects an error, the error message is displayed inside a *view system errors* screen, in which the *error message utility* (EMU) not only displays the error diagnosis, but the suggestions for corrective action (see page 89 for a brief summary). Error codes are no longer displayed.

Devices, such as memory and newly installed hard disks, are configured automatically. The user is not requested to confirm the change. Newly removed hard disks are detected, and the user is prompted to confirm the new configuration by pressing (F4). Note, though, that the POST does not detect when a hard disk drive has been changed.

During the POST, the BIOS and other ROM data is copied into high-speed shadow RAM. The shadow RAM is addressed at the same physical location as the original ROM in a manner which is completely transparent to applications. It therefore appears to behave as very fast ROM. This technique provides faster access to the system BIOS firmware.

The following table lists the POST routines in the order in which they are executed (from the shadow RAM). If the POST is initiated by a soft reset (Ctrl) (Alt) and (Delete), the RAM tests are not executed and shadow RAM is not cleared. In all other respects, the POST executes in the same way following power-on or a soft reset.

Test	Description
System BIOS Tests	
LED Test	Tests the LEDs on the control panel.
System (BIOS) ROM Test	Calculates an 8-bit checksum. Test failure causes the boot process to abort.
RAM Refresh Timer Test	Tests the RAM refresh timer circuitry. Test failure causes the boot process to abort.
Interrupt RAM Test	Checks the first 64 KB of system RAM used to store data corresponding to various system interrupt vector addresses. Test failures cause the boot process to abort.

5 Power-On Self-Test and Error Messages

Order in Which the Tests are Performed

Shadow the System ROM BIOS	Tests the system ROM BIOS and shadows it. Failure to shadow the ROM BIOS will cause an error code to display. The boot process will continue, but the system will execute from ROM. This test is not performed after a soft reset (using Ctrl , Alt , and Delete).
Load CMOS Memory	Checks the serial EEPROM and returns an error code if it has been corrupted. Copies the contents of the EEPROM into CMOS RAM.
CMOS RAM Test	Checks the CMOS RAM for start-up power loss, verifies the CMOS RAM checksums. Test failure causes error codes to display.
CPU Cache Memory Test	Tests the processor's internal level-one cache RAM. Test failure causes an error code to display and the boot process to abort.
Video Tests	
Initialize the Video	Initializes the video subsystem, tests the video shadow RAM, and, if required, shadows the video BIOS. A failure causes an error code to display, but the boot process continues.
System Board Tests	
8042 Self-Test	Downloads the 8042 and invokes the 8042 internal self-test. A failure causes an error code to display.
Timer 0/Timer 2 Test	Tests Timer 0 and Timer 2. Test failure causes an error code to display.
DMA Subsystem Test	Checks the DMA controller registers. Test failure causes an error code to display.
Interrupt Controller Test	Tests the Interrupt masks, the master controller interrupt path (by forcing an IRQ0), and the industry-standard slave controller (by forcing an IRQ8). Test failure causes an error code to display.
Real-Time Clock Test	Checks the real-time clock registers and performs a test that ensures that the clock is running. Test failure causes an error code to display.
Audio Test	If the audio board is present, invokes a built-in self-test. Test failure causes an error code to display.
Memory Tests	
RAM Address Line Independence Test	Verifies the address independence of real-mode RAM (no address lines stuck together). Test failure causes an error code to display.
Size Extended Memory	Sizes and clears the protected mode (extended) memory and writes the value into CMOS bytes 30h and 31h. If the system fails to switch to protected mode, an error code is displayed.
Real-Mode Memory Test (First 640KB)	Read/write test on real-mode RAM. (This test is <i>not</i> done during a reset using Ctrl , Alt , and Delete). The test checks each block of system RAM to determine how much is present. Test failure of a 64 KB block of memory causes an error code to display, and the test is aborted.
Shadow RAM Test	Tests shadow RAM in 64 KB segments (except for segments beginning at A000h, B000h, and F000h). If they are <i>not</i> being used, segments C000h, D000h and E000h are tested. Test failure causes an error code to display.

5 Power-On Self-Test and Error Messages

Order in Which the Tests are Performed

Protected Mode RAM Test (Extended RAM)	Tests protected RAM in 64 KB segments above 1 MB. (This test is <i>not</i> done during a reset using <input type="checkbox"/> Ctrl <input type="checkbox"/> Alt and <input type="checkbox"/> Delete). Test failure causes an error code to display.
Keyboard / Mouse Tests	
Keyboard Test	Invokes a built-in keyboard self-test of the keyboard's microprocessor and tests for the presence of a keyboard and for stuck keyboard keys. Test failure causes an error code to display.
Mouse Test	If a mouse is present, invokes a built-in mouse self-test of the mouse's microprocessor and for stuck mouse buttons. Test failure causes an error code to display.
Network Test	If the network board is present, invokes a built-in self-test. Test failure causes an error code to display.
Tests of Flexible Disk Drive A	
Flexible Disk Controller Subsystem Test	Tests for proper operation of the flexible disk controller. Test failure causes an error code to display.
Coprocessor Tests	
Internal Numeric Coprocessor Test	Checks for proper operation of the numeric coprocessor part of the processor. Test failure causes an error code to display.
Communication Port Tests	
Parallel Port Test	Tests the integrated parallel port registers, as well as any other parallel ports. Test failure causes an error code to display.
Serial Port Test	Tests the integrated serial port registers, as well as any other serial ports. Test failure causes an error code to display.
Hard Disk Drive Tests	
Hard Disk Controller Subsystem Test	Tests for proper operation of the hard disk controller. Test failure causes an error code to display. The test does not detect hard disk replacement or changes in the size of the hard disk.
System Configuration Tests	
System Generation	Initiation of the system generation (SYSGEN) process, which compares the configuration information stored in the CMOS memory with the actual system. If a discrepancy is found, an error code will be displayed.
Plug and Play Configuration	Configures any Plug and Play device detected (either PCI or ISA): <ul style="list-style-type: none"> <input type="checkbox"/> All PCI devices, and any ISA device necessary for loading the operating system will be configured for use. <input type="checkbox"/> Any ISA device that is not required for loading the operating system, will be initialized (prepared for loading of a device driver), but not fully configured for use.

Error Message Summary

The POST section of the HP BIOS no longer displays numeric error codes (such as 910B) but gives a self-explanatory, descriptive diagnosis, and a list of suggestions for corrective action. The following table summarizes the most significant of the problems that can be reported.

Message	Explanation or Suggestions for Corrective Action
Operating system not found	Check whether the disk, HDD, FDD or CD-ROM disk drive is connected. If it is connected, check that it is detected by POST. Check that your boot device is enabled on the <i>Setup</i> Security menu. If the problem persists, check that the boot device contains the operating system.
Missing operating system	If you have configured HDD user parameters, check that they are correct. Otherwise, use HDD type "Auto" parameters.
Failure fixed disk (preceded by a 30" time-out)	Check that HDD is connected. Check that HDD is detected in POST. Check that boot on hard disk drive is enabled in <i>Setup</i> .
Diskette Drive A (or B) error	Check whether the diskette drive is connected. Check <i>Setup</i> for the configuration.
System battery is dead	You may get this message if the computer is disconnected for a few days. When you Power-on the computer, run <i>Setup</i> to update the configuration information. The message should no longer be displayed. Should the problem persist, replace the battery.
Keyboard error	Check that the keyboard is connected.
Resource Allocation Conflict -PCI device 0079 on system board	Clear CMOS.
Video Plug and Play interrupted or failed. Re-enable in Setup and try again	You may have powered your computer Off/On too quickly and the computer turned off Video plug and play as a protection.
System CMOS checksum bad - run Setup	CMOS contents have changed between 2 power-on sessions. Run <i>Setup</i> for configuration.
I/O device IRQ conflict	Serial ports A and B may have been assigned the same IRQ. Assign a different IRQ to each serial port and save the configuration.
No message, system "hangs" after POST	Check that cache memory and main memory are correctly set in their sockets.
Other	An error message may be displayed and the computer may "hang" for 20 seconds and then beep. The POST is probably checking for a mass storage device which it cannot find and the computer is in Time-out Mode. After Time-out, run <i>Setup</i> to check the configuration.

Beep Codes

If a terminal error occurs during POST, the system issues a beep code before attempting to display the error. Beep codes are useful for identifying the error when the system is unable to display the error message.

Beep Pattern	Beep Code ¹	Numeric Code	Description
-	1	B4h	This does not indicate an error. There is one short beep before system startup.
— --	02	98h	Video configuration failure or option ROMs check-sum failure
— - - - - -	0223	16h	BIOS ROM check-sum failure
— - - - - -	0300	20h	DRAM refresh test failure
— - - - - -	0303	22h	8742 Keyboard controller test failure
— - - - - -	0340	2Ch	RAM failure
— - - - - -	0343	2Eh	RAM failure on data bits in low byte of memory bus
— - - - - -	0400	30h	RAM failure on data bits in high byte of memory bus
-- - - - -	2023	46h	ROM copyright notice check failure
- - - - - -	2230	58h	Unexpected interrupts test failure
— - - - - -	02022		Continuous beeps. Keyboard error

¹Where digits 1, 2, 3, 4 represent the number of short beeps, and 0 represents the occurrence of a single long beep.

Lights on the Status Panel

When the computer is first powered on, the *power-on* light on the status panel illuminates yellow for about a second before changing to green. This change of color is caused by the execution of an instruction early in the System BIOS code.

If the light remains at yellow, therefore, it indicates a failure of the processor or the System ROM in the instruction-fetch process. Check that the processor is correctly seated in its socket, and that its VRM is also correctly seated.

Free Manuals Download Website

<http://myh66.com>

<http://usermanuals.us>

<http://www.somanuals.com>

<http://www.4manuals.cc>

<http://www.manual-lib.com>

<http://www.404manual.com>

<http://www.luxmanual.com>

<http://aubethermostatmanual.com>

Golf course search by state

<http://golfingnear.com>

Email search by domain

<http://emailbydomain.com>

Auto manuals search

<http://auto.somanuals.com>

TV manuals search

<http://tv.somanuals.com>