



HP CA350/CB350

Digital Camera
User Manual

Table of Contents

Preface.....v

About this Manual.....	v
Copyright.....	v
Federal Communications Commission (FCC) Compliance.....	v
Declaration of Conformity.....	vi
Trademark Recognition.....	vi
Safety and Handling Precautions Camera Information.....	vi
Battery Information.....	vii
Camera & battery recycle notice.....	vii
Camera on operating notice.....	vii
Using this Menu.....	viii
Photography Terms and Definitions.....	viii

Package Contents.....1

Getting Started.....2

Attaching the Wrist Strap.....	2
Inserting the Batteries.....	2
Inserting an SD/SDHC Memory Card.....	3
Camera Memory.....	4
Camera Views.....	4
Front View.....	4
Back View.....	5
Top View.....	5
Bottom View.....	5
Left/Right View.....	6
Initial Settings.....	8
Setting the Language.....	8
Using Setup Menu.....	8
Setting Battery Type.....	9

Modes.....	10
Shooting mode.....	10
Playback mode.....	10
Switching between Shooting mode and Playback Mode.....	10
Selecting the Shooting mode options.....	11
LCD Monitor Layout and Icon Descriptions.....	12
Shooting Mode Screen Layout.....	12
Playback Mode Screen Layout.....	14
Playback mode display of still images.....	14
Playback mode of videos.....	15
Playback mode of audio clips.....	15
Changing the LCD Monitor Display.....	17

Using Shooting Functions.....19

Shooting Image.....	19
Taking Photos.....	19
Using the Stabilizer.....	19
Setting the Zoom Control.....	20
Zoom buttons.....	20
Using Flash.....	20
Setting the Focus Mode.....	22
Using the Function Menu.....	24
Shooting Mode.....	24
Resolution.....	25
Quality.....	25
EV Compensation.....	25
White Balance.....	26
ISO.....	27
Metering.....	27
Color Mode.....	28
Shooting Menu.....	29
Setting the Shooting Scene Mode.....	29
- Using Smile Capture Mode.....	33

- Using Intelligent Scene Mode.....	33
- Using Blink Detection Mod.....	36
- Using Aperture Priority Mode.....	37
- Using Shutter Priority Mode.....	37
- Using Manual Exposure Mode.....	38
Setting the Self-Timer/Burst.....	39
Setting the AEB.....	40
Setting the AF Area.....	40
Setting the AF Lamp.....	41
Setting Sharpness.....	41
Setting Saturation.....	42
Setting Contrast.....	43
Setting the Digital Zoom.....	43
Setting the Date & Time Imprint.....	44
Setting Instant Review.....	45
Recording Videos.....	45
Setting the Video Quality.....	46
YouTube Mode.....	47
Recording Voices.....	48

Using the Viewing Functions.....49

Viewing in Single Navigation.....	49
Viewing thumbnails.....	49
Zooming images.....	51
Playing Videos.....	51
To capture screenshot image from a video clip.....	52
Playing Voice Recording.....	53
Playing Voice Memo.....	53
Deleting an Image/Video/Audio.....	54
Playback Menu.....	55
View Slideshow.....	56
Delete.....	56
Protect.....	57

Remove Red Eyes.....	58
Voice Memo.....	59
Modify Color.....	60
Crop.....	62
Resize.....	63
DPOF.....	64
PictBridge.....	65
Making Connections.....	66
Connecting the Camera a PC.....	66
Connecting the Camera to a Printer.....	66
Troubleshooting.....	67
Getting Help.....	68

Preface

About this Manual

This manual is designed to assist you in using your new digital camera. All information presented is as accurate as possible but is subject to change without notice.

For the latest revision, please visit www.hp.com/support.

Copyright

This manual contains proprietary information protected by copyright. All rights are reserved. No part of this manual may be reproduced by any mechanical, electronic or other means, in any form, without prior written permission of the manufacturer. © Copyright 2009

Federal Communications Commission (FCC) Compliance

This equipment has been tested and found to comply with the limits for a Class B digital device, pursuant to Part 15 of the FCC Rules. These limits are designed to provide reasonable protection against harmful interference in a residential installation. This equipment generates, uses, and can radiate radio frequency energy and, if not installed and used in accordance with the instructions, may cause harmful interference to radio communications. However, there is no guarantee that interference will not occur in a particular installation. If this equipment does cause harmful interference to radio or television reception, which can be determined by turning the equipment off and on, the user is encouraged to try to correct the interference by one or more of the following measures:

- Reorient or relocate the receiving antenna.
- Increase the distance between the equipment and the receiver.
- Connect the equipment to an outlet on a circuit different from that to which the receiver is connected.
- Consult the dealer or an experienced radio/TV technician for help.

Warning: A shielded-type power cord is required in order to meet FCC emission limits and to prevent interference to radio and television reception. Use only shielded cable to connect I/O devices to this equipment. Any changes or modifications not expressly approved by the manufacturer may void your warranty and service agreement.

Declaration of Conformity

This device complies with Part 15 of the FCC rules. Operation is subject to the following conditions:

- This device may not cause harmful interference.
- This device must accept any interference received, including interference that may cause undesired operation.

Trademark Recognition

Windows 2000/XP/Vista are registered trademarks of Microsoft Corporation in the United States and/or other countries. Macintosh and Mac OS are registered trademarks of Apple Inc. In addition, all other companies or product names are trademarks or registered trademarks of their respective companies.

Safety and Handling Precautions Camera Information

- Do not take apart or attempt to service the camera yourself.
- Do not expose the camera to moisture, or extreme temperatures.
- Allow the camera to warm up when moving from cold to warm temperatures.
- Do not touch the camera lens.
- Do not expose the lens to direct sunlight for extended periods.
- Do not use abrasive chemicals, cleaning solvents or strong detergents to clean the product. Wipe the product with a slightly damp soft cloth.

Battery Information

- If batteries are already installed, make sure to power off camera before removing and inserting new batteries.
- When using batteries in this product, ensure that they are inserted correctly. Inserting the batteries upside down can cause damage to the product and possibly cause an explosion.
- When the camera is used for an extended period of time, it is normal for the camera body to feel warm.

Camera & battery recycle notice



In the European Union, do not discard this product and battery as unsorted municipal waste. Contact local authorities for recycling program information.

Camera on operating notice

On operating temperatures



Your camera is designed for use under the temperatures between 0°C and 40°C (32°F and 104°F). Shooting in extremely cold or hot places that exceed this range is not recommended.

Do not use/ store the camera in the following places

- In an extremely hot, cold or humid place. In places such as in a car parked in the sun, the camera body may become deformed and this may cause a malfunction.
- Under direct sunlight or near a heater, the camera body may become discolored or deformed, and this may cause a malfunction.
- Close and contact with magnetic objects.
- Be careful not to let sand or dust get into the camera. This may cause the camera to malfunction, and in some cases this malfunction cannot be repaired.

Using this Menu

Symbols used in this manual are explained below:

 <p>Note</p>	This indicates useful information when using your camera.
 <p>Warning</p>	This indicates warning message that should be read before using the function.

Photography Terms and Definitions

Terms	Definitions
auto exposure bracketing (AEB)	A simple technique professional photographers use to ensure they properly expose their pictures, especially in challenging lighting situations. When AEB is selected, the camera automatically takes three or more shots with a different exposure for each frame.
auto focus (AF)	Auto focus refers to a camera lens' ability to adjust its configuration in order to focus properly on a subject regardless of whether it is near or far from the camera. Auto focus lenses generally provide vastly superior image quality than do their fixed focus cousins since they do not have to rely on their depth of field. Also known as: "AF", "auto-focus"
album	An end-user created object that is used to logically group data objects according to some user-defined criteria. An album may or may not be a physical folder in a file system.
Analog to Digital Converter (A/D or ADC)	A circuit that converts an analog signal, having a continuously varying amplitude, to a digitally quantized representation using binary output signals.
aspect ratio	cf. image aspect ratio, pixel aspect ratio.

auto white balance (AWB)	With auto white balance, the camera attempts to determine the color temperature of the light and automatically adjust for that color temperature. Many people just leave the camera set to auto white balance all the time.
Charge Coupled Device (CCD)	A type of silicon integrated circuit used to convert light into an electronic signal.
compression	The process of encoding information using fewer bits cf. image compression, sound file compression
Digital Print Order Format (DPOF)	A standardized ASCII file created in a digital camera and stored on removable media along with the image files that indicate how many copies of which images should be printed. It also allows index prints, cropping, and text overlays to be specified.
digital still camera (DSC)	A camera incorporating an image sensor which outputs a digital signal representing a still picture, or records a digital signal representing a still picture on a removable medium, such as a memory card or magnetic disk.
dynamic range	cf. ISO DSC dynamic range, colour gamut, luminance ratio
Exif/JPEG	A compressed file format for digital cameras in which the images are compressed using the baseline JPEG standard, described in ISO 12234-2, and metadata and thumbnail images are stored using TIFF tags within an application segment at the beginning of the JPEG file.
exposure index	A numerical value that is inversely proportional to the exposure provided to an image sensor to obtain an image. Images obtained from a camera using a range of exposure index values will normally provide a range of image quality levels.
ISO speed	A numerical value calculated from the exposure provided at the focal plane of an electronic camera to produce specified camera output signal characteristics using the methods described in the referenced standard. The ISO speed should correlate with the highest exposure index value that provides peak image quality for normal scenes.

JPEG	Joint Photographic Experts Group. An image compression method defined in ISO/IEC 10918-1.
protocol	Defined mechanisms for exchanging data between devices.
StorageID	A device-specific four byte unsigned integer (UINT32) that represents a unique storage area that may contain data objects. The most significant sixteen bits of a StorageID represents the PhysicalStorageID, while the least significant sixteen bits of a StorageID represents the LogicalStorageID.
USB	Universal serial bus, a digital interface for connecting up to 64 devices in a tiered-star topology. See http://www.usb.org .
white balance	The adjustment of electronic still picture color channel gains or image processing so that radiation with relative spectral power distribution equal to that of the scene illumination source is rendered as a visual neutral.

Source: ISO/WE 12231 Photography-- Electronic still-picture cameras -- Terminology

Package Contents

Please check the contents of your camera package. It should contain:



Digital camera

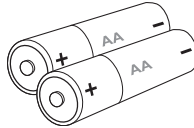

AA battery x 2 pcs



Wrist strap

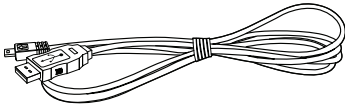

USB cable



Warranty Card

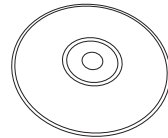

User Manual and Software
installation

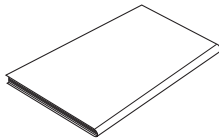

Quick Start guide

Getting Started

Attaching the Wrist Strap

Follow these instructions to attach the wrist strap to your camera to better protect your new camera:

1. Insert the smaller loop of the strap in the strap eyelet.
2. Thread the larger loop of the strap through the short loop and pull tight to attach the strap to the camera.

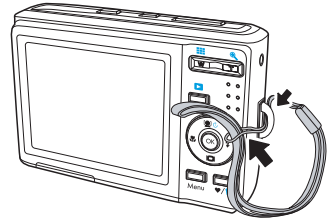

Inserting the Batteries

Follow these instructions to insert the AA batteries into the battery compartment. If batteries are already installed, make sure to power off camera before inserting new batteries. Please read "Battery Information" before inserting/removing batteries.

1. If batteries are already installed, make sure to power off camera before removing and inserting new batteries.
2. Open the battery compartment at the bottom of the camera.

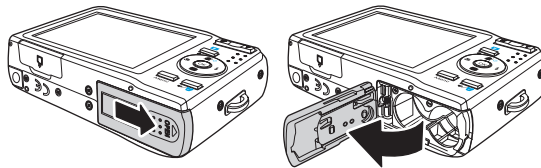

3. Insert the batteries into the compartment with the terminal facing inside the camera and the batteries indent next to the compartment door.

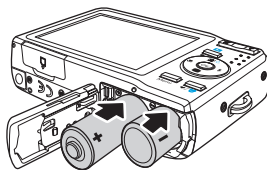

4. Close the battery compartment.

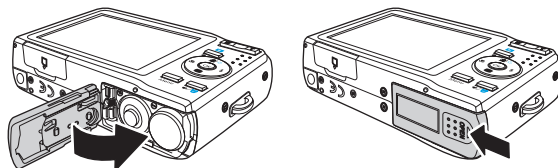

Inserting an SD/SDHC Memory Card

Expand your camera's storage by using SD or SDHC memory cards.

1. Open the SD card compartment at the bottom of the camera.
2. Insert the SD/SDHC card into the memory card slot with the metallic contacts facing the back side of the camera.
3. Push the SD/SDHC card into the memory slot until it clicks into place.
4. Close the SD card compartment.

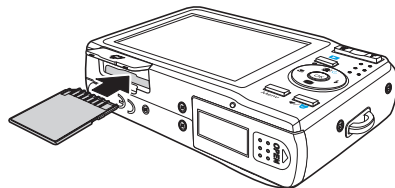
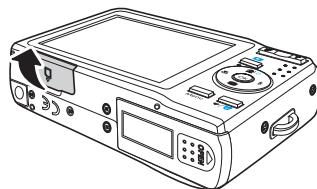

To remove the SD/SDHC card

1. Open the battery compartment.
2. Gently push the card until it clicks and pops out.
3. Pull out the card carefully.

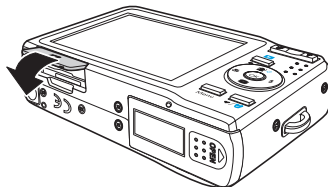

Camera Memory

Your camera supports SD cards of up to 4GB in size. It also supports SDHC cards with a maximum capacity of 32GB. If there is a storage card inserted in the memory slot, the camera automatically saves all images, videos and audio clips in the external storage card.

The  icon indicates the camera is using SD card.



Not all cards may be compatible with your camera. When purchasing additional cards, please check the card specifications. You can ensure optimal compatibility by purchasing HP brand SD cards.

Camera Views

Front View

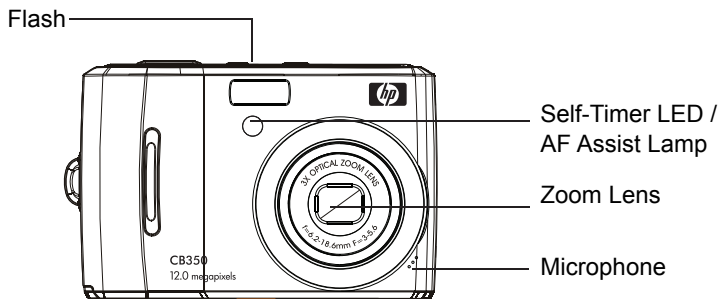

Back View

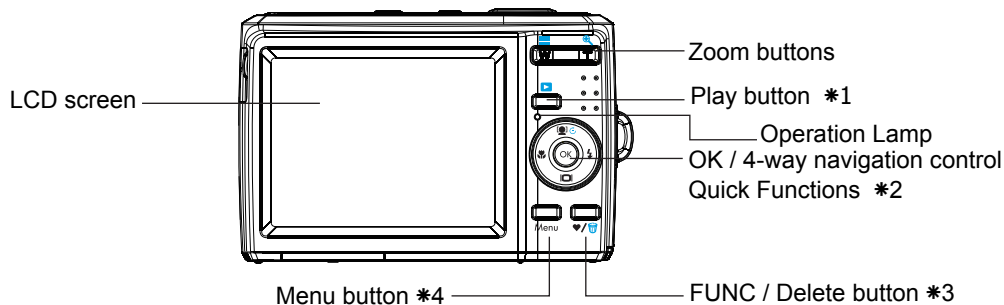

*# Please refer to the notes for marked item with * at page 6*

Top View

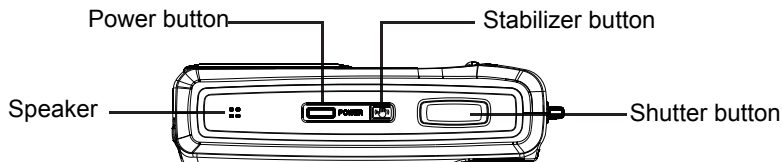

Bottom View

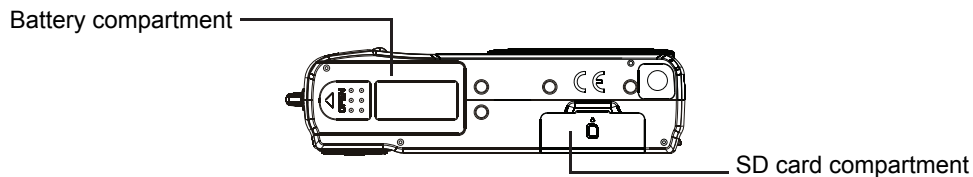

Left/Right View

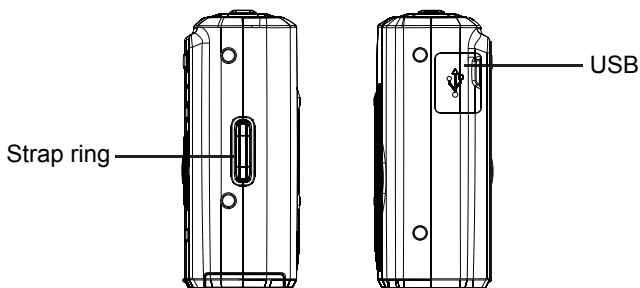

Button *1: Play

If the camera is turned off, press and hold to turn on camera in Playback mode.
If the camera is turned on, press to toggle camera to Playback or Shooting mode.

Button *2: FUNC/Delete

In Shooting mode, press to enter FUNC menu.
In Playback mode, press to delete an image, video or audio clip.

Button *3: Navigation Control

The 4-way **Navigation Control** and the **OK** button allows you to access the various menus available from the On Screen Display (OSD). Further functions of these buttons are as follows:

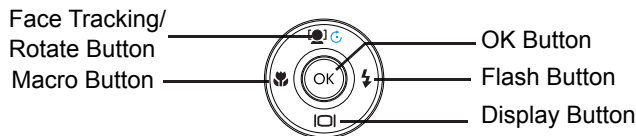

Button *4: Menu button





Press **Menu** button on camera exits if you've navigated into mode settings and don't want to make a selection

Button	Usage
OK	1. Confirm a selection when using the OSD menus.
Flash/ Right	<ol style="list-style-type: none"> 1. In Shooting mode, press to scroll through the flash mode options. (Auto, Anti Red-eye, Slow Sync and Off) 2. In Playback mode, press to view the next image, video or audio clip. 3. In Playback Video mode, press to fast forward video playback 4. In Menu mode, press to change submenus.
Macro/ Left	<ol style="list-style-type: none"> 1. In Shooting mode, press to switch focus mode (Macro, PF, INF). 2. In Playback mode, press to view the previous image, video or audio clip. 3. In Playback Video mode, press to rewind video playback 4. In Menu, press to exit a submenu or to navigate through the menu selections.
Up/Face Tracking/ Rotate	<ol style="list-style-type: none"> 1. In Menu mode, press to navigate through the menu and submenu selections. 2. In Shooting mode, press to turn the face tracking function on and off. 3. In Playback Video/ Audio mode, press to Start/Pause video or audio playback. 4. In Playback photo mode, press to rotate the image clockwise 90 degrees by each press of the button. This feature is applicable for still images only.
Display/Down	<ol style="list-style-type: none"> 1. In Playback mode, press to change the LCD screen display to show or hide OSD icons. 2. In Shooting mode, press to change LCD screen display to show or hide OSD icons and guide lines. 3. In Menu mode, press to navigate through the menu and submenu selections. 4. In Playback Video/ Audio mode, press to stop video/audio playback.

Initial Settings

You will be prompted to set up the language and the date and time when the camera is turned on for the first time.







Setting the Language

1. Press , ,  or  to move through the selection.
2. Select a language, and then press **OK** to apply.

Using Setup Menu

You can access the Setup menu whether you are in Shooting or Playback mode. The Setup menu allows you to configure general camera settings.

To go to Setup Menu:

1. Press  to launch the Shooting/Playback Menu.
2. Use the  or  key to change the menu tab to **Setup**  menu.
3. Use the  or  key to move through the menu selections.
4. To select an item, press the **OK** button or .
5. Change the submenu settings using the 4-way navigation control.
6. Press the **OK** button to save and apply settings.

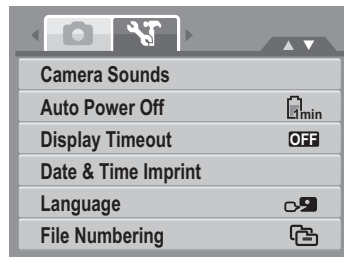

Setting Battery Type

To ensure the camera displays the battery level correctly, be sure to set the battery type in Setup Menu to match the installed battery type: **Alkaline** / **NiMH** / **Lithium** / **Oxyride**.

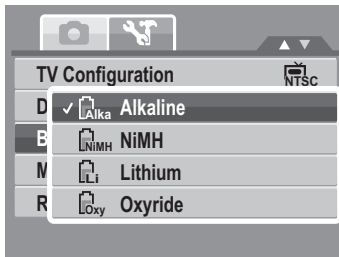

Modes

Your camera has two modes:

Shooting mode

- Set to Shooting mode to capture images and record videos and audio clips.
- Shooting mode can be further set to many options such as auto, video and scene selection. See "[Selecting the Shooting mode options](#)" below.

Playback mode



- Set your camera to Playback mode so you can view and edit captured images as well as playback videos and audio clips. You can also attach a voice memo to any image in this mode.

Shooting mode is selected by default when using the Power button to turn on the camera. When you turn on your camera using the Power button, it will automatically set to shooting mode.

Switching between Shooting mode and Playback Mode

In Shooting mode, press the **Play** button to switch to Playback mode.
In Playback mode, press the **Play** button to switch back to Shooting mode.

Selecting the Shooting mode options

1. Set the camera to Shooting mode.

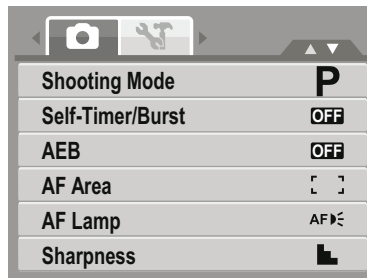
2. Press **MENU** to launch Shooting mode Menu.
3. Select **Shooting Mode**, and then press  to enter submenu.
4. Select a mode.
5. Press the **OK** button to apply selected mode.



Use the 4-way navigation control to move through the menu selections.

LCD Monitor Layout and Icon Descriptions

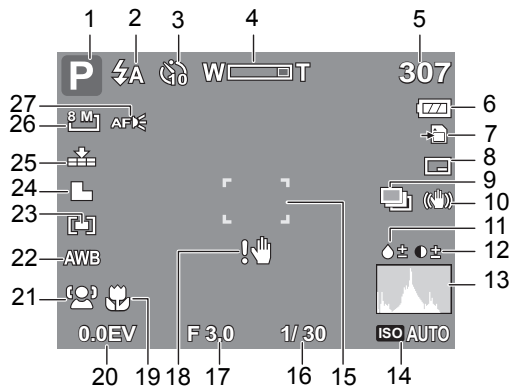
Shooting Mode Screen Layout



No.	Item	Description
1	Shooting mode	Indicates the current mode.
2	Flash	Indicates flash settings.
3	Self-Timer/Burst	Indicates Self-Timer/Burst settings.
4	Zoom indicator	Displays zoom.
5	Shots remaining	Indicates the remaining shots available.
6	Battery	Indicates battery level.
7	Storage media	Indicates current storage media in use.
8	Date & Time Imprint	Indicates date & time imprint is enabled.
9	Auto Exposure Bracketing (AEB)	Indicates AEB function is enabled

10	Stabilizer	Indicates stabilizer function is enabled.
11	Saturation	Displays saturation settings.
12	Contrast	Displays contrast settings.
13	Histogram	Displays the darkest and brightest values, corresponding to black and white respectively.
14	ISO	Displays ISO settings.
15	Displays focus area settings	Use to frame subject to capture.
16	Shutter speed	Displays shutter speed settings.
17	Aperture value	Displays aperture settings.
18	Shake warning	Indicates that the camera is shaking.
19	Macro	Indicates macro is enabled.
20	Exposure	Displays exposure settings.
21	Face tracking	Indicates face tracking is enabled.
22	White balance	Displays white balance settings.
23	Metering	Displays metering settings.
24	Sharpness	Displays sharpness settings.
25	Quality	Displays quality settings.
26	Resolution	Displays resolution settings.
27	AF lamp	Indicates AF lamp is enabled.

Playback Mode Screen Layout

The Playback mode display varies depending on the type of image being viewed.

Playback mode display of still images:

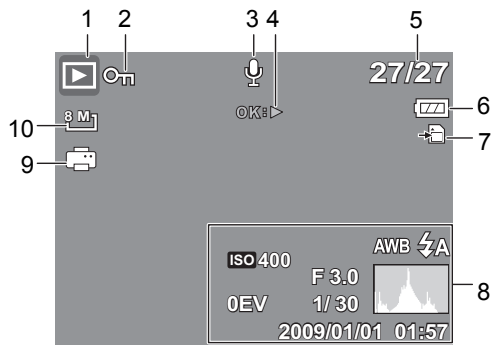

No.	Item	Description
1	Playback mode	Indicates playback mode.
2	Protect	Indicates file is protected.
3	Voice memo	Indicates voice memo is attached.
4	Button intro	Indicates the button to press on the camera to play a video or audio file.
5	File Number	Indicates the current image file number and the total files in the camera.
6	Battery	Indicates battery level.
7	Storage media	Indicates storage medium in use.
8	Recording information	Displays the image details of the current file.
9	DPOF	Indicates the file is marked for printing.
10	Resolution	Displays the resolution settings.

Playback mode of videos:

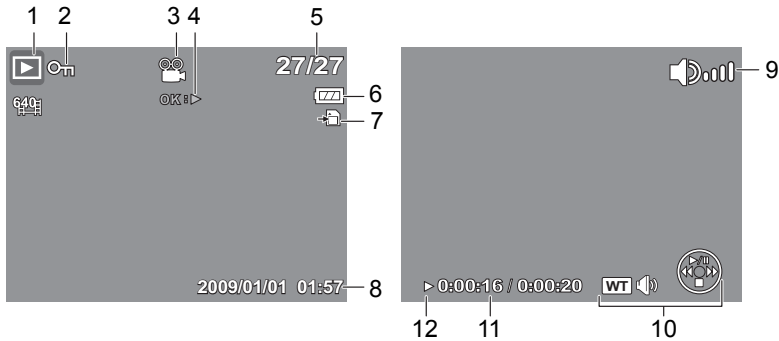

No.	Item	Description
1	Playback mode	Indicates playback mode.
2	Protect	Indicates file is protected.
3	Video clip	Indicates the file is a video.
4	Button intro	Indicates the button to press on the camera to play a video or audio file.
5	File Number	Indicates the current image file number and the total files in the camera.
6	Battery	Indicates battery level.
7	Storage media	Indicates storage medium in use.
8	Shooting information	Displays the image details of the current file.
9	Volume	Indicates volume settings.
10	Key indicator	Indicates the buttons to press on the camera to apply the functions.
11	Played time	Indicates played time.
12	Playing status	Displays playing status.

Playback mode of audio clips:

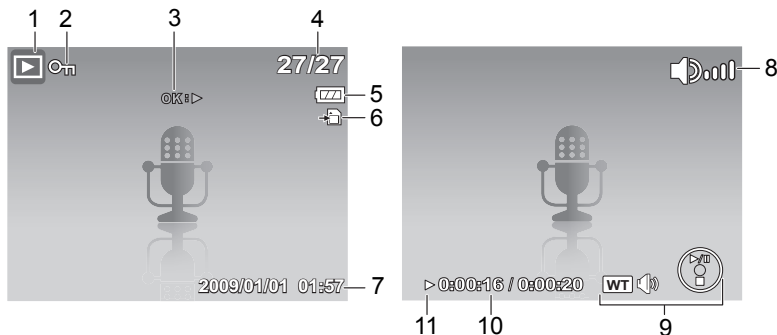

No.	Item	Description
1	Playback mode	Indicates playback mode.
2	Protect	Indicates file is protected.
3	Button intro	Indicates the button to press on the camera to play a video or audio file.
4	File no. / Total no.	Indicates the file number over the total number of files in the storage card.
5	Battery	Indicates battery level.
6	Storage media	Indicates used storage memory.
7	Shooting information	Displays shooting information of the file.
8	Volume	Indicates volume settings.
9	Key indicator	Indicates the buttons to press on the camera to apply the functions.
10	Played time	Indicates played time.
11	Playing status	Displays playing status.

Changing the LCD Monitor Display

The type of information displayed on the LCD screen can be changed using the button.



OSD on

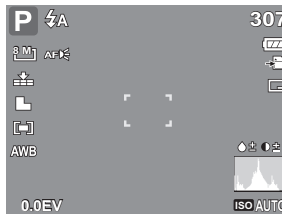

Full OSD on

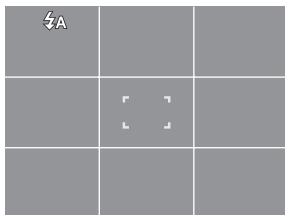

Guide lines on



OSD off



- The OSD information may vary depending on the shooting mode type.
- The following icons, if enabled, are still displayed on the LCD even when OSD off or Guide lines on: AEB, Face tracking, AF lamp, Self-Timer/Burst, and Macro.
- Use the "Guide lines" to properly set image for capture.

In Playback mode, the LCD display can be changed into any of the following:



OSD on

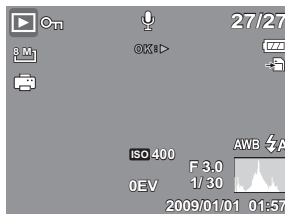

Full OSD on



OSD off



LCD display cannot be changed in the following situations:

- Manual exposure mode
- Recording video or audio clips
- Playing video or audio clips
- Playing slide show

Using Shooting Functions

Shooting Image

Taking Photos

1. Turn on the camera by pressing the **Power** button. By doing this, your camera is also set to shooting mode.
2. Frame the shot using the focus bracket on the LCD monitor. See Image 1.
3. Press the shutter button half-way down. The camera automatically adjusts the focus and exposure. When the camera is ready to take the photo, the frame bracket turns green, the shutter speed and aperture value are displayed. See Image 2.
4. Fully press the **Shutter** button to capture image.



When the shake warning icon  appears, hold the camera steadily, use a tripod, or refer to "Using the Stabilizer" section to stabilize the camera and prevent blurred images.



Image 1



Image 2

Using the Stabilizer

The Stabilizer function prevents blurred images caused by shaking.



Stabilizer button

To activate Stabilizer

- Press the **Stabilizer** button on top of your camera to enable/disable stabilizer.

If Stabilizer is enabled, the stabilizer icon is displayed on the LCD monitor and the ISO setting is automatically set to Auto.



Stabilizer
on

Setting the Zoom Control

Your camera features up to 3x optical zoom and up to 5x of digital zoom. Optical zoom is achieved by mechanically adjusting the lens. While digital zoom is activated through the menu settings.

To adjust the optical zoom:

1. Press Menu button in shooting mode, and activate digital zoom, see Image 1.
2. Press the Zoom buttons to **zoom in** or zoom out an image.
3. The zoom indicator appears on the LCD monitor. 

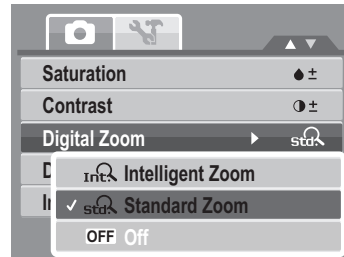

Image1

Zoom buttons

Press to zoom out. —  — Press to zoom in.

To adjust the digital zoom:

1. Activate digital zoom.
2. Press the **T** button to optically zoom in to the maximum until it stops.
3. Release the button.

4. Press the **T** button again to switch to digital zoom automatically. Zooming continues.

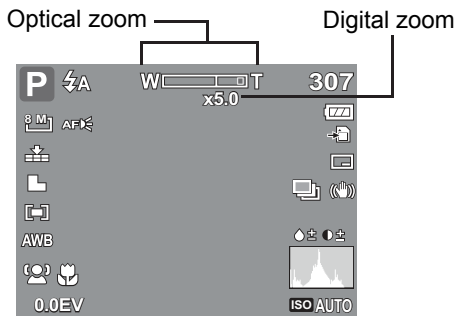

Digital zoom is not activated in recording video.

Using Flash

When taking pictures in difficult lighting conditions, use the **Flash** button to get correct exposure. This function cannot be activated in recording video or continuous shooting.

To activate Flash:

- Press the **Flash/Right** button on your camera repeatedly until your desired flash mode is displayed on the LCD monitor.

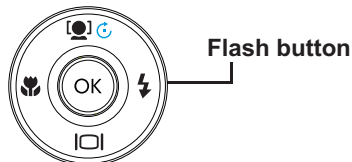

Your camera is equipped with five flash modes:

⚡A Auto. The flash fires automatically whenever extra lighting is needed.

⚡👁 Red-eye reduction. The flash fires twice to reduce the red-eye effect.

⚡ Forced on. The flash fires whenever you press the shutter button regardless of lighting conditions.

⚡SL Slow sync. The flash fires with a slow shutter speed.

🚫 Forced off. The flash is turned off.

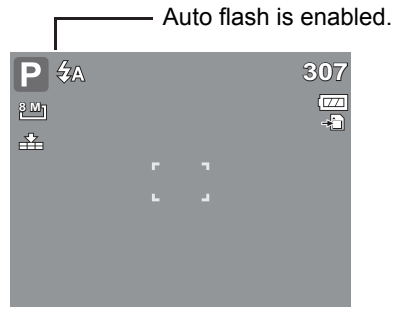

Flash function is only available in shooting still images but not available in Burst and AEB modes.

Setting the Focus Mode

To set the Focus mode

- Press the **Macro** button repeatedly until the desired focus mode icon is displayed on the lower left corner of the LCD monitor.

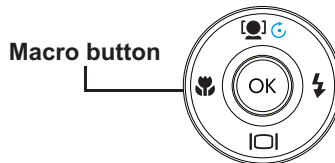

Your camera supports the four focus modes:

Normal. With normal focus, the focus range starts from .8 meters (~ 2 ½ feet). When the camera is set to normal mode, there is no icon displayed on the screen.

 **Macro.** This mode is designed for close-up photography. If Macro is enabled, you can capture the detail and sharpness of a very close image by fixed focus.

PF Pan Focus. The camera focuses on every object.

INF Infinity. The camera focuses on distant objects.

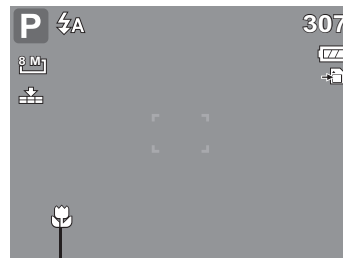

Macro enabled

Using the Function Menu

The hot key of “heart” (FUNC button) is used for a quick setup of the latest six shooting modes (You may choose Special Scene, Video, Voice REC in Shooting Mode Menu) and to adjust capturing settings in Shooting Mode.



• Press the **FUNC** of your camera to launch My Mode Menu.



• Press the **FUNC** again to close the menu.

- The Menu options bar displays the six latest used shooting modes.
- The available options for each item on the menu bar is shown in the Menu options.

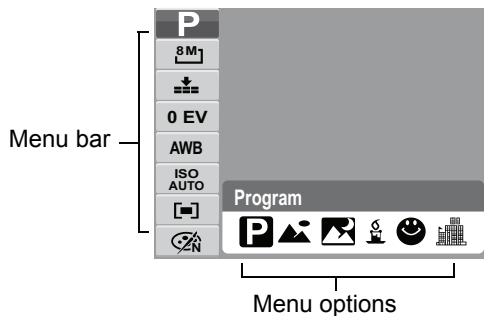

Shooting Mode

It shows the selected mode from Menu options bar.

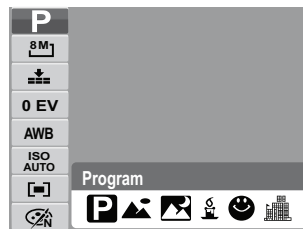

Resolution

The Resolution setting is used to set the resolution before you capture the image. The higher the resolution, the more memory space is required.



The maximum resolution option for CB350 is 12M.

The maximum resolution option for CA350 is 10M.

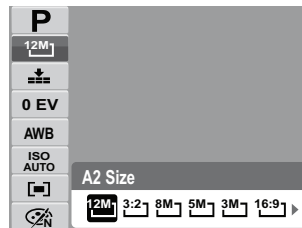

Quality

The quality setting lets you adjust the quality level of your photos before you capture them. However, the higher the quality, the more memory space is required in your memory card. The available settings for still images are as follows:

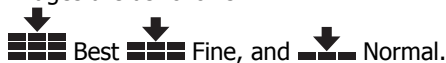



Best, Fine, and Normal.



EV Compensation

In dim lighting condition, the auto exposure function may provide an incorrect exposure value. The EV Compensation function allows you to adjust the exposure value and correctly expose your images. Available for still images only.



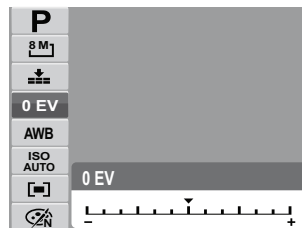



- To adjust EV settings, press the  or  key to increase/ decrease the value. Press the OK button to save and apply changes.
- The available settings are: 0EV, +0.3EV, +0.7EV, +1.0EV, +1.3EV, +1.7EV, +2.0EV, -0.3EV, -0.7EV, -1.0EV, -1.3EV, -1.7EV, -2.0EV.

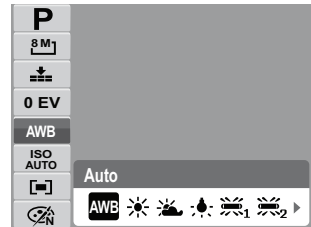

White Balance

The White Balance setting allows you to adjust the image color temperature according to the ambient light condition when recording the still images and video.



Icon	Item	Description
	Auto	The camera automatically adjusts the white balance.
	Sun	Ideally used for bright sunny conditions.
	Cloudy	Ideally used for cloudy conditions.
	Tungsten	Ideally used for indoor photos with tungsten or halogen lighting without a flash.
	Fluorescent H	Ideally used for indoor photos with blue-tinted fluorescent lighting.
	Fluorescent L	Ideally used for indoor photos with red-tinted fluorescent lighting.
	Manual	Used when light source cannot be specified. Press the shutter button for the camera to be pointed at a white object and adjust the appropriate white balance setting automatically according to the environment.

ISO

The ISO function lets you adjust the ISO sensitivity in recording still images depending on the lightning levels of your surroundings.

- Use a higher ISO setting in dim conditions and a lower ISO setting in brighter conditions.
- Available settings are: Auto, 50, 100, 200, 400, 800, 1600,3200 (3M, 16:9<2M>, VGA)

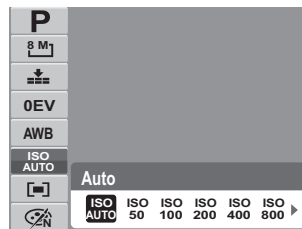

Note



If the Stabilizer is enabled, ISO is automatically set to Auto and cannot be adjusted. To adjust ISO, disable Stabilizer first.

Metering

The Metering function lets you select the area of the subject or frame by which the camera measures light to record still images or video.

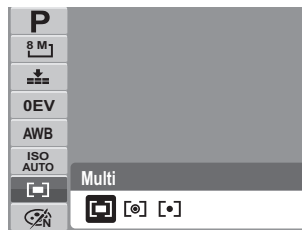
- As you move through the selection, the preview on the LCD monitor changes synchronously.



Icon	Item	Description
	Multi	The camera measures the exposure readings from multiple points in the subject area.
	Center	The camera measures the average light from the entire frame but gives more importance to the values near the center.
	Spot	The camera selects the exposure value based on the center of your picture.

Color Mode

The Color Mode function lets you record still images or video and apply different colors or tones for a more artistic effect. Tinting an image's color can make them appear more vivid.

- As you move through the selection, the preview on the LCD monitor changes synchronously.

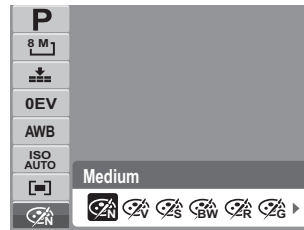

Icon	Item	Description
	Normal	The camera records normally.
	Vivid	The camera captures the image with more contrast and saturation emphasizing on the bold colors.
	Sepia	Images are captured in sepia tones.
	B&W	Images are captured in black and white.
	Vivid Red	Images are tinted red. Ideally used to record images like flowers and cars to make them more vivid.
	Vivid Green	Images are tinted green. Ideally used to record images like mountains and lawns to make them more vivid.
	Vivid Blue	Images are tinted blue. Ideally used to record images like the sky and the ocean, to make them look more vivid.

Shooting Menu

If you are in shooting mode, you can access the Shooting menu simply by pressing the





MENU button on your camera.

When the menu is displayed, use the 4-way navigation control and the **OK** button to move through menu selections and apply your desired settings. To close the menu anytime, press the menu button again.

The Shooting menu allows you to change modes, and setup other capture settings.



1. Press **MENU** to launch the Shooting Menu.
2. Use the  or  key to move through the menu selections.
3. To select an item, press .
4. Change the submenu settings using the 4-way navigation control.
5. Press the **OK** button to save and apply settings.

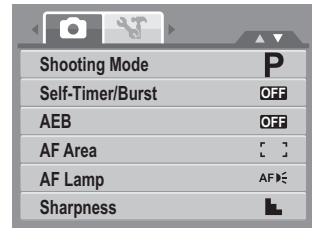





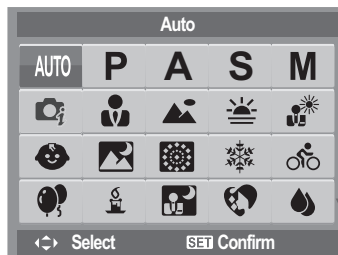
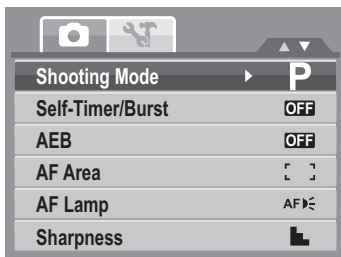

















Setting the Shooting Scene Mode

Setting the Shooting Scene mode allows you to capture images with preset settings according to the scenes or environment.



Icon	Item	Description
	Auto	The simplest way to shoot basic images. Settings are adjusted automatically.
	Program	The camera automatically adjusts suitable shooting settings like shutter speed and aperture values.
	Aperture Priority	This feature lets users to adjust the aperture value and the camera automatically selects the shutter speed to match the brightness.
	Shutter Priority	This feature lets users to adjust the shutter speed and the camera automatically selects the aperture value to match the brightness.
	Manual Exposure	This feature lets users adjust the shutter speed and aperture value regardless of brightness.
	Intelligent Scene	The camera detects the shooting conditions and automatically switches to the appropriate scene mode.
	Portrait	The camera blurs the background to focus on the subject.
	Landscape	This feature is used to emphasize wide scenic views.

Icon	Item	Description
	Sunset	This feature enhances the red hue for recording sunset images.
	Shaded gray	This feature is used to capture the image of a backlight object by changing the metering.
	Kids	This feature is used to capture still images of children.
	Night Scene	This feature is used to capture scenery in low light conditions.
	Fireworks	This feature slows shutter speed to capture fireworks explosions.
	Snow	This feature is used for beach and snow scenes.
	Sports	This feature captures still images of high-speed subjects.
	Party	This feature is used for wedding or indoor party settings.
	Candlelight	This feature is used to capture warm candle light effects.
	Night Portrait	This feature is used to capture portrait pictures with night or dark background.
	Soft Skin	This feature enhances skin tone thus facial skin appears smooth.

Icon	Item	Description
	Soft Flowing Water	This feature enhances smooth effects like water or silk.
	Food	This feature is used to capture food images. The increased saturation in this mode makes the captured image more enticing.
	Building	This feature enhances the edges of captured images.
	Text	This feature enhances the black and white contrast normally used when capturing text images.
	Auction	Pictures taken in Auction mode are automatically saved under a specific folder named "_AUCTION".
	Smile Capture	This feature uses face tracking to auto detect faces to capture. When smiles are detected, it continuously captures the image.
	Blink Detection	This feature detects if the subject blinked an eye when the image is captured and gives the user an option whether to save it or not.
	Pre-composition	This feature captures a image temporarily as a reference. Full press shutter after referring the subject to the reference point.
	Couples Portrait	This feature uses face tracking to auto detect faces to capture portraits photos without the help of others. When over two faces are detected, AF is automatically activated. The camera starts count down and captures a picture in two seconds.
	Video	This mode is used to record video clips.
	Voice REC	This mode is used to record audio clips.

- Using Smile Capture Mode

The Smile Capture mode uses smile tracking to automatically capture images. This feature is most useful in capturing different angles and smiles of moving people. When capturing an image with more than one person, the camera detects the smile of the closest person on the center of the screen.

To activate Smile Capture

1. Select 😊 from the Scene Mode submenu.
2. Focus the camera on the subject to capture.
3. The smile capture icon blinks every second and the white focus frame turns green to denote camera activity.
4. When a smile is detected, the camera will automatically take a shot of the image.

The camera displays a white frame when a face is detected.



When capturing an image with several faces, face tracking function may take up more time tracking faces for the first time.

- Using Intelligent Scene Mode

With the Intelligent Scene Mode, the camera automatically detects the shooting conditions and switches to the appropriate scene and settings when aiming on a subject. This feature is most useful for novice users; capturing great images even with basic photography skills.

Intelligent scene icon. After the camera detects the shooting conditions, this icon changes to show the detected scene mode.



Face tracking is automatically enabled.

To activate Intelligent Scene





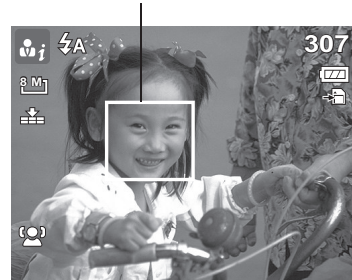



1. Select  from the Scene Mode submenu.
2. Focus the camera on the subject to capture.
3. The camera detects the shooting conditions and switches to an appropriate scene mode.
4. Press the shutter button half-way down to focus the subject. The frame turns green to indicate focus is set.
5. Press the shutter button to take the shot.

The camera displays a solid white frame when a face is detected.



When Intelligent Scene function is enabled, icons will be displayed even in Guideline, None Display modes and when press the shutter button half-way down.

The table below shows the modes supported by Intelligent scene:

Icon	Intelligent Scene Modes	Description
	Portrait	This mode is set when a face is detected.
	Landscape	This mode is set when: <ul style="list-style-type: none"> • There is no face detected. • The focus distance is more than 1.5 meters. • The EV setting is greater than 11 or 10.5.
	Sunset	This mode is automatically set when sunset lighting is detected.
	Macro	This mode is set when: <ul style="list-style-type: none"> • There is no face detected • The focus distance is within the macro range. <p>This mode can only be detected when you press the shutter button half-way down.</p>
	Shaded Gray	This mode is set when the EV setting greater than 2.5.
	Backlight Portrait	This mode is set when a face is detected with an EV setting greater than 2.5.
	Night Scene	This mode is set when: <ul style="list-style-type: none"> • There is no face detected. • The focus distance is more than 1.5 meters. • The EV setting is lower than 5 or 4.5.
	Night Portrait	This mode is set when a face is detected with an EV setting lower than 5 or 4.5.

- Using Blink Detection Mode

The Blink Detection mode tracks faces and determines captured image that contain subjects with closed eyes. After shooting, when the camera detects that the subject blinked an eye, a menu selection appears to ask the user whether to save the image or not. This feature saves time in managing photos to be stored or deleted from the memory.

1. Select  from the Scene Mode submenu.

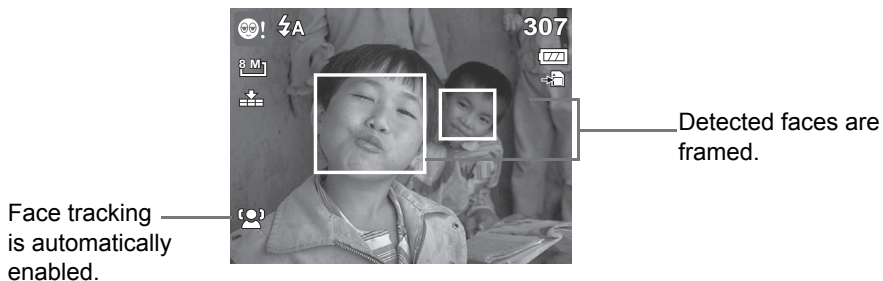

2. Press the shutter button half-way down to focus the subject. The frame turns green to indicate focus is set.
3. Press the shutter button to capture the image. The image is automatically saved unless the camera detects that the subject blinked an eye. In this case, the screen on the right is displayed:
4. Select **Save Image** to save or **Cancel** to disregard.



- Using Aperture Priority Mode

With Aperture Priority mode, users can adjust the aperture value and the camera automatically sets the shutter speed to match the brightness.



Displays the aperture value

- Using Shutter Priority Mode

With Shutter Priority mode, users can adjust the shutter speed and the camera automatically sets the aperture value to match the brightness.









Displays the shutter speed value

- Using Manual Exposure Mode

With Manual Exposure mode, users can manually adjust the shutter speed and the aperture value.

To activate Manual Exposure

1. Select **M** from the Scene Mode submenu.
2. Press **OK** button to enter the adjust mode.
3. Use the  or  keys to select the shutter speed options or Use the  or  keys to select the aperture value options.
4. Use the  or  keys to increase or decrease the aperture or shutter speed values.
5. Use the **OK** button to switch between aperture and shutter speed adjustment and vice versa.
6. Press the shutter button to capture the image.



Displays the aperture and shutter speed value



When you press the shutter button half-way down press the shutter button, the difference between the correct and selected exposure is displayed in red.

Setting the Self-Timer/Burst

Your camera features a Self-Timer and Burst which can be set in the Self-Timer/Burst function in the Shooting Menu. The Self-Timer allows you to take photos after a pre-defined delay. While burst lets you take consecutive shots. This function is only available in recording still images. The Self-Timer/Burst setting is automatically set to off when you turn off the camera.

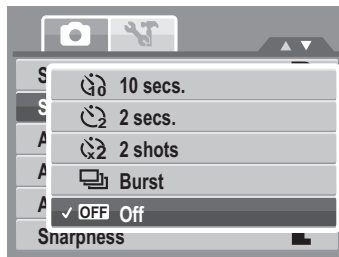
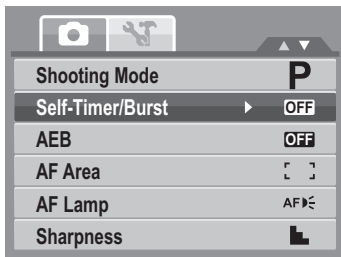

Icon	Item	Description
	10 Secs. Self-Timer	Sets a 10 seconds delay to capture image after pressing the shutter button.
	2 Secs. Self-Timer	Sets a 2 seconds delay to capture image after pressing the shutter button.
	2 Shots Self-Timer	Performs delay and capture twice: <ul style="list-style-type: none"> • Performs a 10-second delay, and then captures the image. • Performs another 2 seconds delay and then captures the image again.
	Burst	Performs continuous shooting when the shutter button is pressed. Stops shooting when the shutter button is released.
	Off	Captures an image without time delay.

Setting the AEB

AEB stands for Automatic Exposure Bracketing. This feature captures the same image with 3 different exposure settings.

- The settings are recorded in the following order: standard exposure, under exposure, and over exposure.
- Available settings are: [On] and [Off].



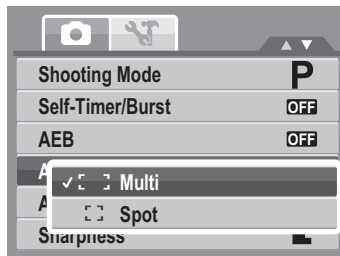

Setting the AF Area

AF stands for Automatic Focus. This feature determines the area on which the camera focuses.



The table below shows the available AF area settings.

Icon	Item	Description
	Multi	The camera automatically selects focus area within the wide frame.
	Spot	The focus area is fixed on the center spot.

Setting the AF Lamp

The AF Lamp function allows the camera to better focus; even in low light conditions.

If AF Lamp is set to Auto, the AF lamp located in the front of the camera, emits a red light by pressing the shutter button half-way down allowing the camera to focus easily.





Setting Sharpness

This function allows you to enhance or soften finer details of your photos.



The table below shows the available Sharpness settings.



Icon	Item	Description
	High	Sharpens the image.
	Medium	Medium sharpness.
	Low	Softens the image.

Setting Saturation

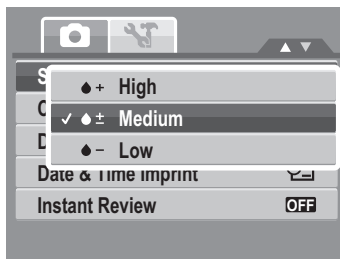
The Saturation function lets you adjust the color saturation in your photos. Use a higher saturation setting for rich colors and a lower saturation setting for more muted tones.



The table below shows the available Saturation settings.

Icon	Item	Description
	High	Enhances saturation.
	Medium	Medium saturation is applied.
	Low	Reduces saturation.

Setting Contrast

This function allows you to adjust the contrast of your photos.

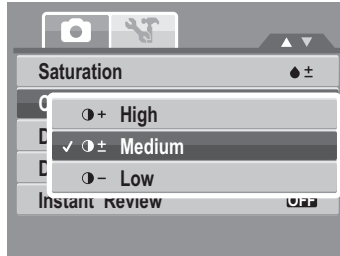



Setting the Digital Zoom

This feature controls the digital zoom mode of your camera.

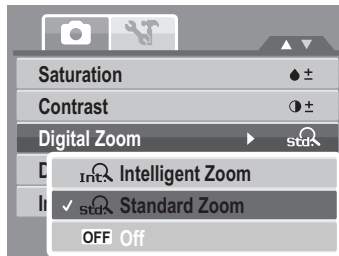
Your camera enlarges an image using the optical zoom first. When the zoom scale exceeds 3x, the camera uses digital zoom.



The table below shows the available Digital Zoom settings.

Icon	Item	Description
	Intelligent Zoom	Enlarges the image digitally with almost no distortion. This feature is available for still images only
	Standard Zoom	Enlarges all image sizes up to a maximum of 5x, but the image quality deteriorates.
	Off	Uses the optical zoom only.



- Digital Zoom is not available in Smile Capture, Video, and Voice Recording modes.
- The maximum Intelligent zoom scale varies depending on the image type and resolution.

Setting the Date & Time Imprint

The Date & Time Imprint function allows you to add the recorded date and time on your photos.

The recording date and time are based on your camera's clock settings. Once date and time are imprint on a photo, they can no longer be edited or deleted. Limitations of Date & Time Imprint functions are as follows:

- Available for still images only.
- May slow down AEB/ continuous shooting when Date & Time Imprint is enabled in /AEB/ Burst mode.
- If Date & Time Imprint is enabled, digital zoom is automatically turned off.
- In vertical or rotated images, the date and time on your photos still appear horizontally.

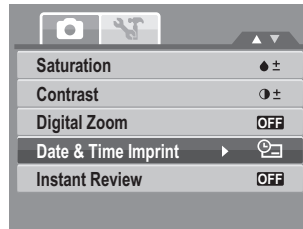
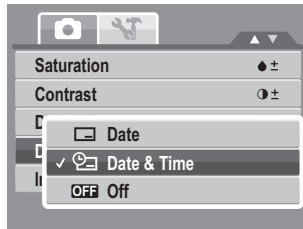

Setting Instant Review

The Instant Review function lets you view the captured image right after shooting it. If Instant Review is On, the camera will display the captured image for 1 second on the LCD monitor.

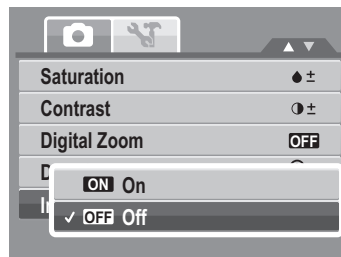
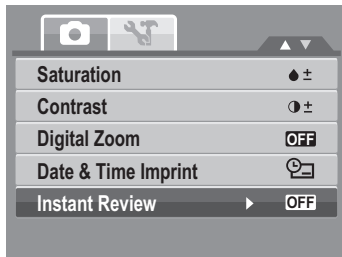

Recording Videos

You can record videos with the camera, the available recording time depends on the capacity of the memory card. Videos can be recorded until the maximum memory capacity has been reached.

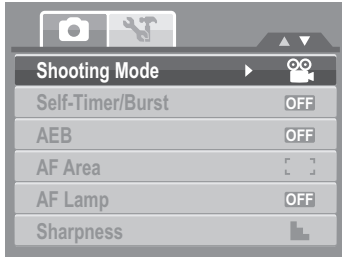

- When the maximum capacity for a single video has been reached, simply press the shutter button again to continue recording.
- The camera will automatically stop recording when the memory capacity is full.
- Digital zoom is not available in video recording.
- Sound cannot be recorded while pressing the **W**  **T** control.
- Auto Power Off is not available in video recording or pause recording.

Setting the Video Quality

The Video Quality function icon appears only in Video Mode. Use this function to adjust the resolution and quality of video clips.

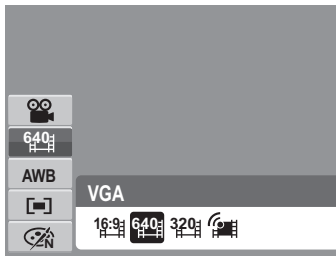

Image Quality Matrix

The higher the image quality, the higher the amount of the data used per second(average bit rate), the smoother the playback video.

Video Quality	Average Bit Rate
720 x 400	4.8Mbps
640 x 480	4.8Mbps
320 x 240	4Mbps

YouTube Mode

The YouTube Mode allows you to record videos with predefined video settings for easy upload to the YouTube website.

YouTube supports two file upload standards:

- Single File Uploaded. The maximum videos file size is up to 100 MB.
- YouTube Uploaded. The maximum videos file size is up to 1 GB.

Most uploaded videos length ranges within 5 minutes. Therefore when you record using the YouTube mode, the following standards are followed:

- Recorded videos are set to YouTube standard resolution of 640 X 480.
- Recording automatically stops when the file reaches 100 MB.

Recorded videos in the YouTube mode are stored following the DCF rule, however videos are saved in a specific folder named "_UTUBE".

- To record a YouTube videos, select  from the Video Quality function. Available recording time for a YouTube is up to 10 minutes.

Recording Voices

1. From the Shooting mode menu, select **Voice**.
The Voice Recording screen layout is displayed on the LCD monitor.
2. Press the **Shutter** button to start recording.
3. Press the **Shutter** button again to stop recording.



Voice recording will automatically stop when the maximum memory capacity is full.

Using the Viewing Functions

View images, videos and audio clips through your camera's Playback mode.

Viewing in Single Navigation

The single navigation mode displays the image one by one on the LCD monitor. To view images/videos/audio clips, follow the steps below.



Press the **Play**  button to set or turn on the camera to Playback mode.

Still Image



Video



Audio Clip



Viewing thumbnails

1. Press the **W** button to view 9-image thumbnails.
2. Use the navigation controls to move through the items.
3. Press the **OK** button to select the image and view it normally.



Scroll bar. If scroll bars appear, it indicates that the screen can be scrolled.

Thumbnail view



Thumbnail icons

When you view the thumbnails, some images may contain icons. These icons indicate the type of file or recording.

Icon	Item	Description
	Voice Memo	Indicates that a voice memo is attached to the image.
	Video	Indicates a recorded video. The image displayed is the first frame of the video clip.
	Locked File	Indicates that the image has been locked. Locked files cannot be edited or deleted.
	Voice Record	Indicates a voice recording file.
	File Error	Indicates an error file. Image or video files that are not taken by this camera or edited by computer may not be recognized

Zooming images

The zoom view function works with still images only.





- In medium view, press the **T** button repeatedly until the desired zoom view.
- The 4 arrows on the LCD monitor indicate that the image is zoomed in.

- Press the **Play**  button to close zoom view.



Playing Videos

1. Set the camera to Playback mode.
2. Use the navigation controls to scroll through the saved images.



3. During playback, use the **W**  **T** to control volume. Press the **T** button to increase volume. Press the **W** button to decrease volume.
4. Press the  key to pause playback. Press the  key again to resume. When paused, the play info will remain on screen except **WT** .



- The play info, except the **WT**  icon, will be displayed when the video is paused, during REW/FF or frame by frame modes
- Volume cannot be adjusted when paused or during REW/FF modes.



To capture screenshot image from a video clip

1. During playback of video, press the  key to pause playback on your desired video frame to capture.
2. Press the **Shutter** button to capture screenshot.
3. The camera will automatically stop playback. The LCD monitor displays the captured image in Single navigation mode.







This feature does not function when the memory card is full or the folder cannot be created. The  icon does not appear on the screen either.

Playing Voice Recording

1. Set the camera to Playback mode.
2. Use the navigation controls to scroll through the saved images. When viewing a voice recording file, the LCD monitor displays the screen layout of Audio clips. See picture on the right.
3. Press the  key to play the voice recording.
4. During playback, use the  to control volume. The volume icon appears on the screen. Press the **T** button to increase volume. Press the **W** button to decrease volume.



5. Press the  key to pause playback. Press the  key again to resume. When paused, the play info will remain on screen except  .
6. Press the  key to stop the playback. The LCD monitor displays the image in Single navigation mode.









Volume cannot be adjusted during pause or REW/FF modes.

Playing Voice Memo

Voice memo is separately recorded and attached to a captured image.

1. Set the camera to Playback mode.
2. Use the navigation controls to scroll through the saved images. An image file with voice memo has a voice memo icon located on the top center of the LCD monitor. See picture on the right.

3. Press the  key to play the voice recording.
4. During playback, use the  to control volume. Press the **T** button to increase volume. Press the **W** button to decrease volume.
5. Press the  key to pause playback. Press the  key again to resume. When paused, the play info will remain on screen except  .
6. Press the  key to stop the playback. The LCD monitor displays the image in Single navigation mode.

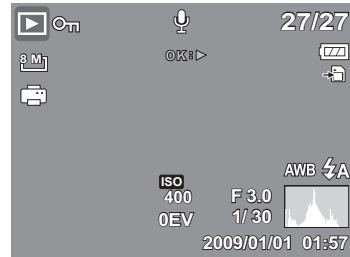

Volume cannot be adjusted when you pause the voice memo.

Deleting an Image/Video/Audio



There are two ways to delete an image/video/audio:

- Using the **Delete** button, or
- Using Playback Menu Delete settings.

Using the Delete Button



Use the **Delete** button on your camera to delete or mark an image/video/audio clip for deletion.

1. Set the camera to Playback mode.
2. View images/videos/audio clips in Single navigation mode.
3. Use the  or  key to scroll the display.
4. When the desired image/video/audio clip is displayed on the LCD monitor, press the Delete button.
5. A confirmation selection appears on screen.
6. Select **Delete**.
7. Press the **OK** button to delete.



Note Locked files cannot be deleted at any time. When you try to delete a locked file, the camera displays "File Locked" message on the LCD monitor.

Playback Menu

The Playback menu allows you to edit images, record voice memo, and setup playback settings.

To go to Playback Menu:

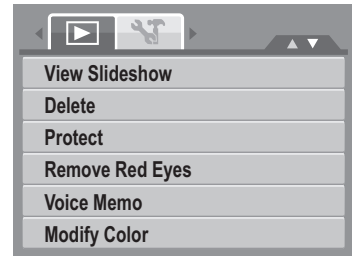

1. Set the camera to Playback mode.
2. Press  MENU to launch the Playback Menu.
3. Change the submenu settings using the 4-way navigation control.
4. Press the **OK** button to save and apply settings.



View Slideshow



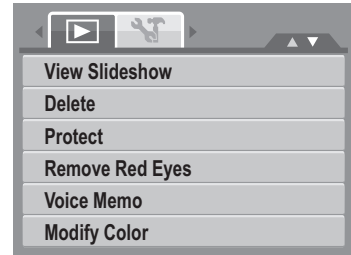

The view slideshow function allows you to view all stored photos/videos in still image format in a continuous sequence.

To view slideshow:

1. From the Playback menu, select View Slideshow. The Slideshow menu appears.
2. Set the slideshow settings.
3. Select **Start**, and then press the **OK** button to start the slideshow.
4. During slideshow, press the **OK** button to pause slideshow.
5. Use the  or  key to move through the options. Select whether to **Continue** or **Exit** the slideshow.
6. Press the **OK** button to apply selected option.



To change slideshow settings:

1. From the Slideshow menu, use the  or  key to move through the selections.
2. Select Interval setting. Press the  or  key to adjust.
3. Select Transition setting. Press the key to adjust. Choose among the available transition settings:
 - Horizontal • Shrink • Fade • Random
4. Select Repeat setting. Press the key to adjust. Available settings are: Yes, No.

Delete

The Delete function lets you remove unwanted files in the internal memory or on the memory card. Protected files cannot be erased, to delete, unprotect the file first. See "Protect Section".

To delete a photo/video/audio clip:

1. From the Playback menu, select **Delete**.
2. The Delete submenu is displayed on the LCD monitor. Select available settings:
 - **This image**. Select one file to delete.
 - **Voice Memo Only**. Delete only the attached voice memo, the image is retained in the memory.
 - **Multi-Images**. Select multiple files to delete at the same time.
 - **All**. Delete all files.



Protect

The Protect function lets you lock a photo or video to protect it from being modified or accidentally erased. A protected file has a lock icon when viewed on Playback mode.

To protect files:

1. From the Playback menu, select **Protect**.
2. The Protect submenu is displayed on the LCD monitor.

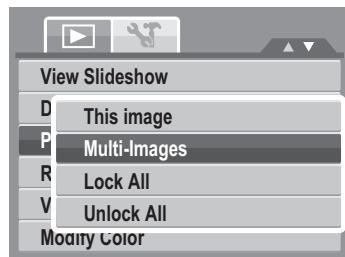

Select available settings:

- **This image**. Select one file to lock.
- **Multi-Images**. Select multiple files from the thumbnail view to lock.
- **Lock All**. Lock all files
- **Unlock All**. Unlock all files.



Remove Red Eyes

The function is used to reduce red eye in captured images. This function is only available for still images. It can be applied to an image several times, but the quality may gradually deteriorate.

1. Set the camera to Playback mode.
2. Press the  or  key to scroll and select an image.
3. Press the MENU button to launch the Playback menu.
4. Select **Remove Red Eyes**.
5. Select **Start**.
6. Press the **OK** button to start correction.

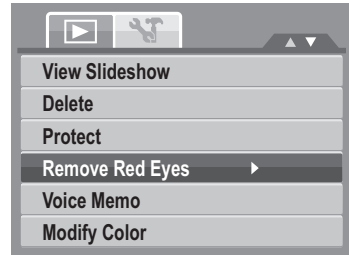

Steps 5 and 6



Step 7





7. After completing Remove Red Eyes, a menu selection appears. Select whether to:
 - **Overwrite. Save** and replace the old file with the new one.
 - **Save Changes.** Save the new file as a new one.
 - **Cancel.** Cancel Remove Red Eyes.
8. Press the **OK** button to save/cancel changes.

Voice Memo

The Voice Memo function allows you to record and attach a voice memo to a saved image. You can record a maximum of 30 seconds of Voice memo per image. This function is only available in still images.

To record voice memo:

1. Set the camera to Playback mode.
2. Press the  or  key to scroll and select an image to attach voice memo to.
3. Press the **MENU** button to launch the Playback menu.
4. Select **Voice Memo**.
5. Select **Start**, and then press the **OK** button to start recording.

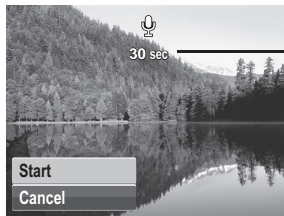
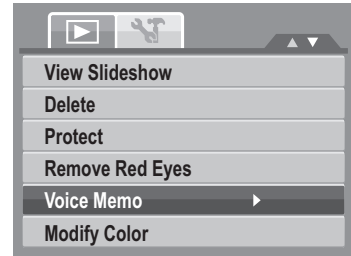

Time left (n seconds) for recording.



6. Select Stop, and then press the **OK** button to stop recording.





When you record voice memo to an image with an existing voice memo, the old recording is automatically changed to the new one.

Modify Color

The function lets you adjust edit still images to apply different colors or tones for a more artistic effect. An edited photo in this function is saved as a new file.

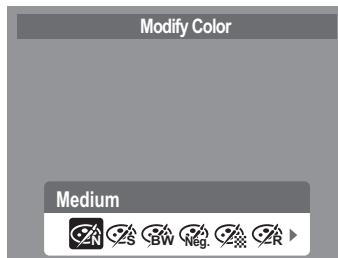
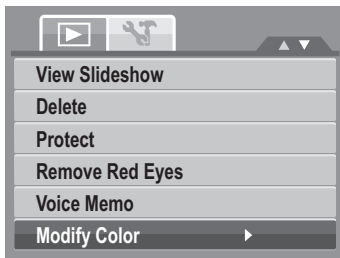



1. Set the camera to Playback mode.
2. Press the  or  key to scroll and select an image to edit.
3. Press the **MENU** button to launch the Playback menu.
4. Select **Modify Color**. The Photo Edit submenu appears.



5. Press the  or  key to scroll and select an option. As you move through the selection, the preview on the LCD monitor changes synchronously.

The succeeding table shows the available settings.



Icon	Item	Description
	Medium	No effect is added to the image.
	Sepia	Image is saved with a sepia tone.
	B&W	Image is saved in black and white.

	Negative	Image appears to be the opposite of the original image.
	Mosaic	Image is saved with mosaic tiles.
	Vivid Red	Image is saved with reddish tint.
	Vivid Green	Image is saved with greenish tint.
	Vivid Blue	Image is saved with bluish tint.

Crop

The function allows you to trim an image to another image size. This function is only available for still images.

To trim an image:

1. Set the camera to Playback mode.
2. Use the  or  key to scroll and select an image to trim.
3. Press the **MENU** button to launch the Playback menu.
4. Select Crop. The Trim screen layout is displayed on the LCD monitor.
5. Use the  control to change size.

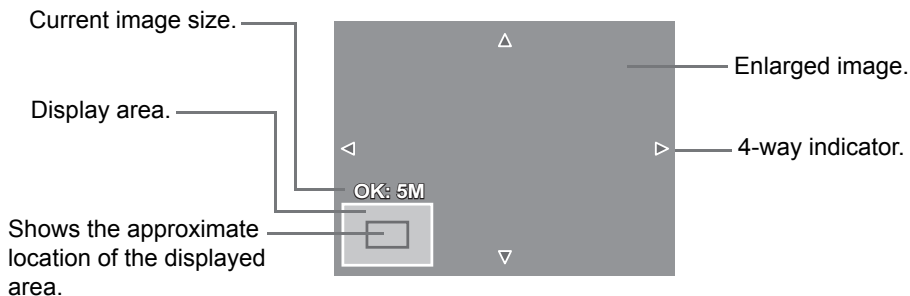
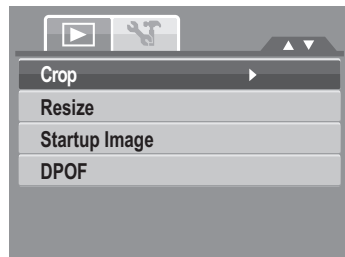

- Crop function is not available for photos with image size set to VGA.
- All images will be trimmed in 4:3 ratio regardless of its original image ratio.

Resize

The Resize function allows you to change the image resolution of large images to smaller ones. This function is only available for still images.

To resize an image:

1. Set the camera to Playback mode.
2. Use the key to scroll and select an image to resize.
3. Press the **MENU** button to launch the Playback menu.
4. Select **Resize**. The Resize submenu is displayed on the LCD monitor.
5. Select size among: 8M, 5M, 3M, and VGA.
Available size settings may vary depending on original image size. Unavailable settings appear as gray icons in Resize submenu.
6. After selecting size, a menu selection appears. Select whether to:
 - **Overwrite**. Save and replace the old file with the new one.
 - **Save Changes**. Save the new file as a new one.
 - **Cancel**. Cancel resize.
7. Press the **OK** button to save/cancel changes.

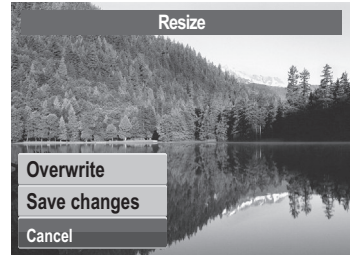

Resize function is not available for photos with image size set to VGA.

DPOF

The Digital Print Order Format (DPOF) function allows you to mark image in your memory card for printing and allows you to specify the number of copies that you want to print at a later date. When all images to be printed are marked, take the memory card to a digital printing service, or use a DPOF compatible printer.

To set DPOF:

1. Press the **MENU** button to launch the Playback menu.
2. Select **DPOF**. The submenu appears. Available settings are as follows:
 - **This Image**. Select a single image to mark.
 - **All**. Mark all images in the memory card.
 - **Reset**. Reset all DPOF settings to initial default settings.

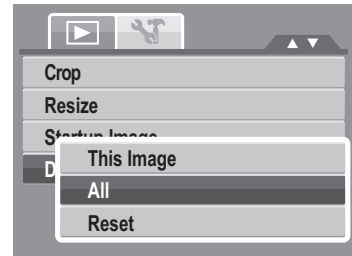

You can specify up to 99 copies for DPOF. If you specify 0 copies, the DPOF setting of that image is automatically disabled.

PictBridge

The PictBridge function allows you to print images captured by your camera without connecting the camera to a PC. Print images with a PictBridge compatible printer directly.

To activate PictBridge:

Connect your camera to a PictBridge compatible printer using the USB cable. See illustration below.

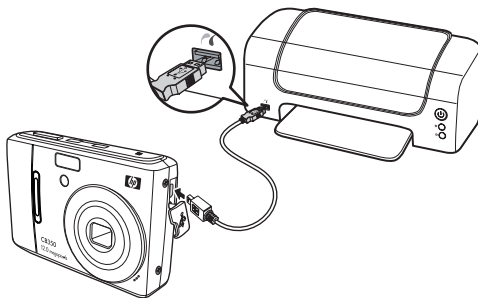

Note If the printer does not support date & time imprint, the date & time imprint function will be disabled in PictBridge.

Making Connections

Connecting the Camera a PC

You can transfer photos, videos and audio files to your PC.

1. Connect the camera to a PC using the USB cable.
2. Turn on the camera.
3. The PC detects the connection. The internal memory of camera and memory card display as removable drives in the file manager. No image is displayed on the LCD monitor.

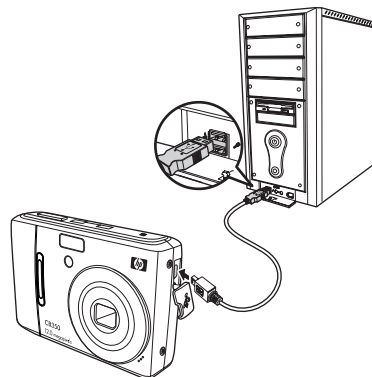

Connecting the Camera to a Printer

You can print your photos directly using a PictBridge compatible printer.

1. Turn on your camera.
2. Set PictBridge settings.
3. Connect the camera to the printer using the USB cable.

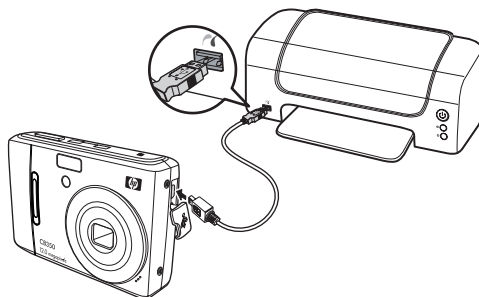

Troubleshooting

Problem	Cause and/or Action
Camera does not turn on.	The batteries may be exhausted. Charge or replace the batteries.
Camera turns off automatically.	Press any button except the Power button to turn on the camera.
LCD turns blank.	Press any button except the Power button to turn on the LCD.
Empty battery icon is displayed on the LCD, and then the camera turns off.	Batteries are exhausted, please replace or recharge.
LCD screen displays 'No images in memory'.	The image file on the memory card. Image file format may not be supported.
LCD screen displays 'Not available for this file'.	Function is only available for specific file types. File format is not supported.
LCD screen displays 'Memory full'.	Memory card is full. Replace the memory card with a new one or delete unnecessary images.
LCD screen displays 'File locked'.	This file is locked. Unlock the file.
LCD screen displays 'Card locked'.	The memory card is protected. Remove the card and slide the write-protect switch to it's unlock position.
LCD screen displays 'CARD HAS WRONG FORMAT'.	The memory card is protected. Remove the card and slide the write-protect switch to it's unlock position.
LCD screen displays 'Copy error'.	The memory card is protected. Remove the card and slide the write-protect switch to it's unlock position. The memory card is full. Replace card or delete unnecessary files.
The lens got stuck up.	Do not force the lens to go back. The type of the battery used may be incorrect or the battery power level is too low. Change the battery or charge the battery before using the camera.

Getting Help

Should you have a technical support question or your HP Digital Camera require service within the warranty period, please contact the original point of purchase or an authorized HP reseller in your country. If service is not available at those locations, please contact an HP Branded Product warranty agent from the support contact list provided below. A service agent will work with you to troubleshoot your issue and if necessary, issue a Return Material Authorization (RMA) number in order to replace your HP Branded Product. For warranty claims, you will be required to provide a copy of your original dated sales receipt as proof of purchase and the issued RMA number. You will be responsible for shipping charges when shipping the product to the service center. The service agent will provide you with an address and you will also be responsible for any shipping charges to the warranty service center. Once your product is received by this service center, a replacement unit will be shipped back to you typically within 5 business days.

Contact/phone Support:	
Language	Contact/phone Support:
Chinese	simp.chinese@hpodd.com
	trad.chinese@hpodd.com
Deutsch	deutsch@hpodd.com
Dutch	hollands@hpodd.com
English	english@hpodd.com
Espanol	espanol@hpodd.com
Français	francais@hpodd.com
Italiano	italiano@hpodd.com
Japanese	nippon@hpodd.com
Korean	korean@hpodd.com
Portuguese	portugues@hpodd.com
Svensk	svensk@hpodd.com

Contact/phone Support:		
Country	Language	Number
Europe Region (EMEA)		
België	Dutch and German	+ 32 2700 1724
Français	French	+ 33 171230454
Deutschland	German	+ 49 6950073896
Ireland	English	+ 353 1850882016
Italia	Italian	+ 39 269682189
Netherlands	Dutch	+ 31 202015093
Espana	Spanish	+ 34 914533458
Switzerland	German/French/Italian	+ 41 18009686
UK	English	+ 44 2073652400
North America		
United States	English	1.866.694.7633
Canada	English and French	1.866.694.7633

P/N: 7525C00078A

Free Manuals Download Website

<http://myh66.com>

<http://usermanuals.us>

<http://www.somanuals.com>

<http://www.4manuals.cc>

<http://www.manual-lib.com>

<http://www.404manual.com>

<http://www.luxmanual.com>

<http://aubethermostatmanual.com>

Golf course search by state

<http://golfingnear.com>

Email search by domain

<http://emailbydomain.com>

Auto manuals search

<http://auto.somanuals.com>

TV manuals search

<http://tv.somanuals.com>