

CHICAGO

Electric Power Tools

SPOTLIGHT

3 Million Candle Power with 9" Lens

Model 08825

OPERATING INSTRUCTIONS



3491 Mission Oaks Blvd., Camarillo, CA 93011
Visit our Web site at <http://www.harborfreight.com>

Copyright© 2003 by Harbor Freight Tools®. All rights reserved. No portion of this manual or any artwork contained herein may be reproduced in any shape or form without the express written consent of Harbor Freight Tools.

For technical questions, please call 1-800-444-3353

SPECIFICATIONS

ITEM	DESCRIPTION
Lens	9" Diameter Round x 1/8" Thick Glass Lens
Construction	ABS-Orange with Black Ring
Rated Candle Power	3 Million (ON2 Setting), 1 Million (ON1 Setting)
Light Source	115 Watt Blue Halogen Bulb (H-3 / 12V)
Power Source	Two 6V, 4Ah Batteries
Power Adapter	120 VAC / 60 Hz
Output Voltage	15 VDC
Car Adapter	Auto-Lighter-Type, Fused w/ 5 Ft. Long Cord
Weight	6.5 Lbs.
Overall Dimensions	9" W X 11" in Length

SAVE THIS MANUAL

You will need the manual for the safety warnings and precautions, assembly instructions, operating and maintenance procedures, parts list and diagram. Keep your invoice with this manual. Write the invoice number on the inside of the front cover. Keep the manual and invoice in a safe and dry place for future reference.

SAFETY WARNINGS AND PRECAUTIONS

1. **AVOID WORKING ALONE.** If an accident happens, an assistant can bring help.
2. **KEEP PRODUCT USAGE AREA CLEAN.** Keep area free from moisture or oil. Cluttered areas invite injuries.
3. **KEEP CHILDREN AWAY FROM PRODUCT USAGE AREA.** Allow children to handle this product only with supervision.
4. **CHECK FOR DAMAGED PARTS.** Before using this product, carefully check that it will operate properly and perform its intended function. Check for damaged parts and any other conditions that may affect its operation. Replace or repair damaged or worn parts immediately.
5. **REPLACEMENT PARTS AND ACCESSORIES.** Use only identical replacement parts.
6. **ALWAYS BE AWARE OF DANGER OF FIRE** and place the Spotlight away from sides of tent or any flammable materials while illuminated.
7. **DISPOSE OF BATTERY PROPERLY.** Never put in fire. Contact local Hazardous Waste Disposal authorities for proper guidelines.
8. **NEVER LOOK DIRECTLY INTO THE SPOTLIGHT.**

REV 06/03; 09/03; 10/04; 01/07

9. **AVOID TOUCHING THE LENS** as it may become hot during operation.
10. **DO NOT DISASSEMBLE THE BATTERY** or remove any parts from the Battery and surrounding connections.
11. **DO NOT ALLOW THE SPOTLIGHT TO BE EXPOSED TO FIRE OR HIGH HEAT** as this may result in an explosion.
12. **DISCONNECT POWER.** Unplug charger when not in use.
13. **MAINTENANCE.** For your safety, maintenance should be performed regularly by a qualified technician.
14. **SPOTLIGHT IS NOT COMPLETELY WATERPROOF.**

Warning: The warnings, cautions, and instructions discussed in this instruction manual cannot cover all possible conditions and situations that may occur. It must be understood by the operator that common sense and caution are factors which cannot be built into this product, but must be supplied by the operator.

Warning: Operation of equipment in close proximity to a heart pacemaker could cause interference or failure of the pacemaker.

Warning: This product contains or, when used, produces a chemical known to the State of California to cause cancer and birth defects or other reproductive harm. (California Health & Safety Code § 25249.5, et seq.)

Note: Performance of this tool (if powered by line voltage) may vary depending on variations in local line voltage. Extension cord usage may also affect tool performance.

PROPER VOLTAGE WARNINGS

Common household current is 110-120 volts. As long as the outlet used with the tool is rated from 110-120V there will be no complications using it with household receptacles. Plug the tools with Power Adapter into a 110-120V properly grounded outlet protected by a 15-amp, dual element time delay fuse or circuit breaker.

NEVER try to plug a 110-120V tool into a 220-240V circuit or serious complications and possible injury to the operator may occur. The plugs have different shapes to prevent this.

UNPACKING

When unpacking your Spotlight, check to make sure the following parts are included. If any parts are missing or broken, please call **Harbor Freight Tools** at 1-800-444-3353.

CHARGING INSTRUCTIONS

Actual charging of the Spotlight Battery is required before using the Spotlight.
To *recharge* the Battery follow the directions below.

1. To charge the Battery (3), your Spotlight comes with an AC/DC Adapter (19). Lift the Waterproof Stopper (7) on top of Spotlight. Insert the round end of the AC/DC Adapter (19) into the AC/DC Socket (13). Plug the prong end of the AC/DC Adapter (19) into an electrical outlet. The red charging light will turn on while the battery is being recharged. **See Figure A, B.**
2. Charging time will take from 10 to approximately 12 hours. The red light will shut off automatically when the battery is fully charged. After the battery is charged for the required time, unplug the AC/DC Adapter from the wall socket and the AC/DC Socket on the Spotlight. **Never attempt to turn on the Spotlight while it is being recharged.** Once recharged, with the AC/DC Adapter removed, the Spotlight is ready to be used. A fully charged Spotlight will provide approximately a 20 minute strong beam or 50 minute weaker beam.

Note: After each use of the spotlight, always fully recharge the battery.

Note: This unit is equipped with an automatic shutoff. If the Battery's power is running low, the unit will automatically stop operating to protect the battery. Charge the battery immediately.

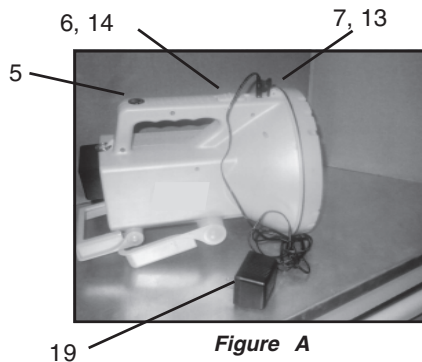

Figure A

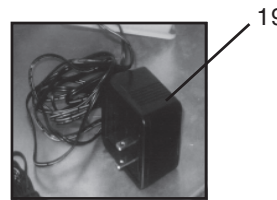

Figure B



Figure C

CAR ADAPTER

1. Your Spotlight comes with a Car Adapter (20, 21). To operate your Car Adapter, remove the Rubber Cover (5) and insert the narrow end of the Car Adapter (21) into the 12 V Inlet (17) underneath. **Figure A.** The other end (20) will fit into your car's cigarette lighter socket. **See Figure C.**
2. The Spotlight is ready to be used while plugged into the Car Adapter. The Car Adapter will not charge the Spotlight's battery, however. **While using the Car Adapter, take care so that the car's battery does not get discharged.**

OPERATION

To assist you with operating your Spotlight, please refer to the Operational Figures as well as the Parts List and Assembly Diagram.

1. Push forward on the 3-Way Slider Switch (6) to one of the two ON positions to turn the Spotlight ON. Pull the 3-Way Slider Switch all the way back to turn the Spotlight OFF - see **Switch**, right.

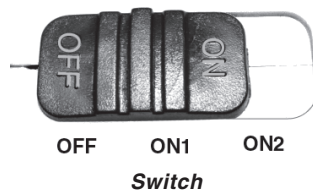

Switch

2. Adjust the Stands (22a & 22b) to angle the beam of light to the desired position. **Figure D.**

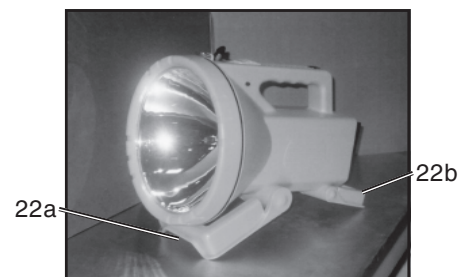

Figure D

REV 06/03; 09/03; 08/04; 10/04; 01/07

REPLACING BATTERY

Remove Rear Cover (2). Remove pin/connectors from the old Battery. Reconnect **Red** and **Black** pins/connectors to the proper corresponding connectors on the new battery. After connecting properly, put the new Battery back in Housing. Replace Rear Cover (2).

Caution: Burns or an explosion could occur if handled improperly. (See Battery Disposal).

See Figure E.

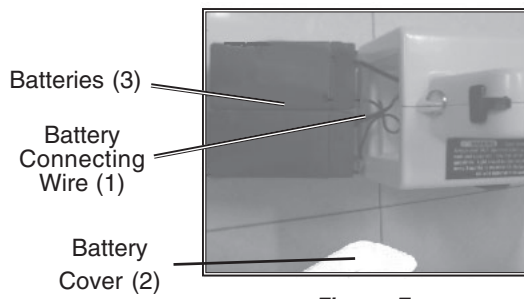

Figure E

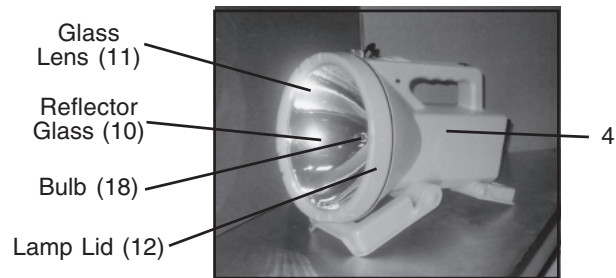

Figure F

See Parts Drawing on Page 6.

IF THERE IS ANY QUESTION ABOUT A CONDITION BEING SAFE OR UNSAFE, DO NOT OPERATE THE TOOL.

WARNING—BATTERY DISPOSAL

The Spotlight is powered by a Battery which will have a long life span. When the Battery is no longer functioning, the used up Battery should be properly recycled. Many states require recycling. Contact your local solid waste authority for information on recycling.

Battery Lifetime

Note: Always recharge the Spotlight within a 24 hour period after each use.

Caution: Never completely discharge the battery. Deep battery discharge will decrease battery life.

The battery capacity will be reduced if the Spotlight is not used for 3 months. It is recommended that the battery be recharged at least one time every 3 months.

Note: The battery should be charged before the first use.

MAINTENANCE

1. For better and safer performance, keep all parts of this product clean and dry.
2. Periodically check to see that all hardware is in place.

PARTS LIST

PART	DESCRIPTION	QTY
1	Battery Connecting Wire	1
2	Rear Cover	1
3	Battery	2
4	Plastic Body Housing	1
5	Rubber Cover	1
6	3-Way Slider Switch Cover	1
7	Waterproof Stopper over Adapter Socket	1
8	Iron Ring	1
9	Sealing Ring	1
10	Reflector Glass	1
11	Glass Lens	1
12	Lamp Lid	1
13	Socket (Power Adapter)	1
14	Switch	1
15	Circuit Board	1
16	Charging Light	1
17	12V Inlet	1
18	Bulb	1
19	AC/DC Adapter	1
20/21	Car Adapter	1
22a	Adjustable Stand (front) (not shown)	1
22b	Adjustable Stand (back) (not shown)	1

PARTS DRAWING

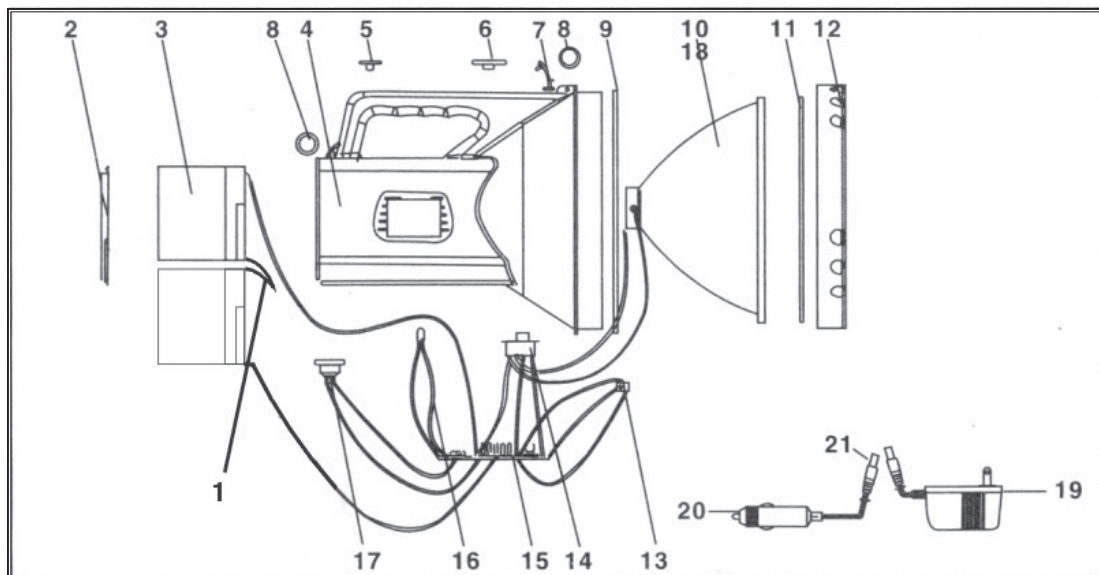

NOTE: Some parts are listed and shown for illustration purposes only and are not available individually as replacement parts.

PLEASE READ THE FOLLOWING CAREFULLY

THE MANUFACTURER AND/OR DISTRIBUTOR HAS PROVIDED THE PARTS DIAGRAM IN THIS MANUAL AS A REFERENCE TOOL ONLY. NEITHER THE MANUFACTURER NOR DISTRIBUTOR MAKES ANY REPRESENTATION OR WARRANTY OF ANY KIND TO THE BUYER THAT HE OR SHE IS QUALIFIED TO MAKE ANY REPAIRS TO THE PRODUCT OR THAT HE OR SHE IS QUALIFIED TO REPLACE ANY PARTS OF THE PRODUCT. IN FACT, THE MANUFACTURER AND/OR DISTRIBUTOR EXPRESSLY STATES THAT ALL REPAIRS AND PARTS REPLACEMENTS SHOULD BE UNDERTAKEN BY CERTIFIED AND LICENSED TECHNICIANS AND NOT BY THE BUYER. THE BUYER ASSUMES ALL RISK AND LIABILITY ARISING OUT OF HIS OR HER REPAIRS TO THE ORIGINAL PRODUCT OR REPLACEMENT PARTS THERETO, OR ARISING OUT OF HIS OR HER INSTALLATION OF REPLACEMENT PARTS THERETO.

REV 09/03; 08/04; 01/07

Free Manuals Download Website

<http://myh66.com>

<http://usermanuals.us>

<http://www.somanuals.com>

<http://www.4manuals.cc>

<http://www.manual-lib.com>

<http://www.404manual.com>

<http://www.luxmanual.com>

<http://aubethermostatmanual.com>

Golf course search by state

<http://golfingnear.com>

Email search by domain

<http://emailbydomain.com>

Auto manuals search

<http://auto.somanuals.com>

TV manuals search

<http://tv.somanuals.com>