

Fishfinder 160 Blue



owner's
manual

© 2001 GARMIN Corporation

GARMIN International, Inc.
1200 East 151st Street, Olathe, Kansas 66062, U.S.A.
Tel. 913/397.8200 or 800/800.1020
Fax 913/397.8282

GARMIN (Europe) Ltd.
Unit 5, The Quadrangle, Abbey Park Industrial Estate, Romsey, SO51 9AQ, U.K.
Tel. 44/1794.519944
Fax 44/1794.519222

GARMIN Corporation
No. 68, Jangshu 2nd Road, Shijr, Taipei County, Taiwan
Tel. 886/2.2642.9199
Fax 886/2.2642.9099

All rights reserved. Except as expressly provided herein, no part of this manual may be reproduced, copied, transmitted, disseminated, downloaded or stored in any storage medium, for any purpose without prior written consent of GARMIN Corporation. GARMIN Corporation hereby grants permission to download a single copy of this manual onto a hard drive or other electronic storage medium to be viewed for personal use, provided that such electronic or printed copy of this manual contains the complete text of this copyright notice and provided further that any unauthorized commercial distribution of this manual is strictly prohibited.

Information in this manual is subject to change without notice. GARMIN Corporation reserves the right to change or improve its products and to make changes in the content without obligation to notify any person or organization of such changes. Visit the GARMIN web site (www.garmin.com) for current updates and supplemental information concerning the use and operation of this and other GARMIN products.

GARMIN, DCG, and See-Thru are registered trademarks and Fishfinder 160 Blue is a trademark of GARMIN Corporation and may not be used without the express permission of GARMIN Corporation.

December 2001

Part Number 190-00199-00 Rev. B

Printed in Taiwan

Customer Service Product Registration

Help us better support you by completing our on-line registration today! Have the serial number of your Fishfinder 160 Blue handy and connect to our web site (www.garmin.com). Look for the Product Registration link on the Home page.

Why should you register your Fishfinder 160 Blue?

- Notification of product updates
- Notification of new products
- Lost or stolen unit tracking

Thank you for choosing the GARMIN Fishfinder 160 Blue™. This product is designed for easy operation and to provide years of reliable service.

Please take the time to read this Owner's Manual, and learn the operation of your new unit. This will help ensure that you get the most from the Fishfinder 160 Blue.

If you encounter a problem, or just have a question, contact our Product Support Department at 913-397-8200 or 800-800-1020, Monday — Friday 8:00 a.m. to 5:00 p.m. Central Time.

Enjoy your new Fishfinder 160 Blue and once again thank you for choosing GARMIN.

Introduction

Limited Warranty

GARMIN Corporation warrants this product to be free from defects in materials and manufacture for one year from the date of purchase. GARMIN will, at its sole option, repair or replace any components that fail in normal use. Such repairs or replacement will be made at no charge to the customer for parts or labor. The customer is, however, responsible for any transportation costs. This warranty does not cover failures due to abuse, misuse, accident or unauthorized alteration or repairs.

THE WARRANTIES AND REMEDIES CONTAINED HEREIN ARE EXCLUSIVE AND IN LIEU OF ALL OTHER WARRANTIES EXPRESS OR IMPLIED OR STATUTORY, INCLUDING ANY LIABILITY ARISING UNDER ANY WARRANTY OF MERCHANTABILITY OR FITNESS FOR A PARTICULAR PURPOSE, STATUTORY OR OTHERWISE. THIS WARRANTY GIVES YOU SPECIFIC LEGAL RIGHTS, WHICH MAY VARY FROM STATE TO STATE.

IN NO EVENT SHALL GARMIN BE LIABLE FOR ANY INCIDENTAL, SPECIAL, INDIRECT OR CONSEQUENTIAL DAMAGES, WHETHER RESULTING FROM THE USE, MISUSE, OR INABILITY TO USE THIS PRODUCT OR FROM DEFECTS IN THE PRODUCT. SOME STATES DO NOT ALLOW THE EXCLUSION OF INCIDENTAL OR CONSEQUENTIAL DAMAGES, SO THE ABOVE LIMITATIONS MAY NOT APPLY TO YOU.

To obtain warranty service, call the GARMIN Customer Service department (913-397-8200 or 800-800-1020) for a returned merchandise tracking number. The unit should be securely packaged with the tracking number clearly marked on the outside of the package and sent freight prepaid and insured to a GARMIN warranty service station. A copy of the original sales receipt is required as the proof of purchase for warranty repairs. GARMIN retains the exclusive right to repair or replace the unit or software or offer a full refund of the purchase price at its sole discretion. SUCH REMEDY SHALL BE YOUR SOLE AND EXCLUSIVE REMEDY FOR ANY BREACH OF WARRANTY.

Packaging and Accessories

The Fishfinder 160 Blue Standard Package Includes:

- Fishfinder 160 Blue
- Protective Front Cover
- Surface Mount Bracket with Knobs
- Power/Data Cable
- Owner's Manual and Quick Reference Guide Label
- Dual Frequency Transom Mount Transducer (with depth/temp)* and separate Speed Sensor*

Optional Dual Frequency Transducers and Accessories:

Plastic Transom Mount (with depth/temp)*

Bronze Thru-Hull (depth only)

Plastic Thru-Hull (depth only)

Speed Sensor*

Temperature Sensor

10' Transducer Extension Cable

20' Transducer Extension Cable

Second Mounting Station

Flush Mounting Kit

Swivel Mount, 1" RAM

Cigarette Lighter Adapter

Power/Data Cable

18-Pin A/C PC Adapter (US)

18-Pin A/C PC Adapter (EURO)

* **Included with Optional Package**

Introduction

Table of Contents

Introduction	i-vi
Customer Service	i
Limited Warranty	ii
Packaging and Accessories.....	iii
Unit Display	vi
Installation	1-9
Transducers	1
Transom Mount Installation	2
In-hull Installation	3
Speed Sensor Installation.....	4
Wiring Harness Installation	5
Wiring to a Fuse Block	5
Display Installation (Surface Mount)	7
Display Installation (Flush Mount)	8
Testing the Installation	9

Unit Operation	10-29
Keypad Functions	10
Backlight	10
Display Information	11
Using the Adjustment Bar:	
Range	12
Zoom	13
View	13
Gain	14
Setup Menu:	
Chart Tab	
Frequency	15
Fish Symbols.....	16
Whiteline	17
Scroll Speed	17
Scale.....	18
Tools Tab	
Depth Line	18
Flasher	19
Simulator	19
Noise Reject	19
Numbers Tab	
Number Size	20
Battery Voltage.....	21
Temperature	21
Speed	22
Depth Number	22

Alarms Tab

Fish Alarm	23
Shallow Water	24
Deep Water	24
Battery Voltage	25

System Tab

Contrast	25
Beeper	26
NMEA Output	26
Language	26

Calibrations Tab

Keel Offset	27
Water Type	27
Calibrate Speed	27

Units Tab

Depth	28
Temperature	28
Speed	28

Memory Tab

Remember	29
Factory Setup	29
Software Version	29

Table of Contents

On the Water	30-35
Understanding Sonar	30
Transducer Coverage	31
Understanding the Chart	32
Whiteline	33
Thermoclines	34
Simulator Mode	35
Appendix A: Specifications	36
Appendix B: Alarm Messages and Icons	37
Appendix C: Index	38

Fishfinder 160 Blue

Introduction

What can the Fishfinder 160 Blue Display?



The screen shots shown in this manual are simulated. Images seen during actual operation will be influenced by environmental conditions, and may differ from the images shown here.

The Fishfinder 160 Blue is capable of displaying a variety of useful information about the underwater environment. Below are a few things the unit will help you see.

Water Depth

The unit displays water depth and can provide a warning for shallow or deep-water conditions.

Battery Voltage

The unit can display the battery voltage that is available to the unit.

Water Temperature

If equipped with a capable transducer or temperature sensor, the unit can display the water temperature.

Speed Over Water*

If equipped with a capable transducer or speed sensor, the unit can display the boat's speed over water.

Fish

The unit displays fish as arches or fish symbols, and can alert you when a fish is detected.

Thermocline and Structure

With GARMIN's See-Thru® technology, the Fishfinder 160 Blue can display more than just the thermocline and structure. The unit displays fish in and below the thermocline, trees, brush and deadfall like you have never seen before!

Bottom Shape and Type

Garmin's unique DCG® (Depth Control Gain) system provides a clear graphic representation of the bottom type and its shape.

Transducer Frequency*

If equipped with a capable transducer, the unit will display the frequency selected for use; either 200kHz, 50kHz or Dual.

* Requires optional transducer or speed sensor

Transducers

The transducer acts as the eyes and ears of your new sonar. Proper transducer selection and installation are critical to the operation of your unit.

Included in the *Optional Package* is a 200/50kHz frequency (10°/40° cone angle), depth and temperature sensing, transom mount transducer. This transducer provides good all-around performance. Other optional dual frequency transducers are available from your local dealer or GARMIN.

The transducer transmits sound waves toward the bottom in a cone shape. The wider the cone angle, the larger the coverage area at a given depth. While it is good to see as large of an area as possible, it is best to select a frequency setting that suits the water that you are on.

With a dual frequency transducer, you may select either a 200kHz frequency, a 50kHz frequency or both. The 50kHz frequency setting provides a wide cone angle. This wide cone angle produces a large coverage area, but less detailed bottom resolution. In areas where bottom contours change quickly, this can result in “dead zones” where fish cannot be seen.

In contrast, the 200kHz frequency setting provides a narrow cone angle. This narrow cone angle produces a smaller viewing area (compared to a wide cone angle at the same depth), but with improved bottom resolution and a smaller dead zone.

The Dual frequency setting will provide you the most accurate depth and fish returns by transmitting signals at both 200kHz and 50kHz.

Transducers

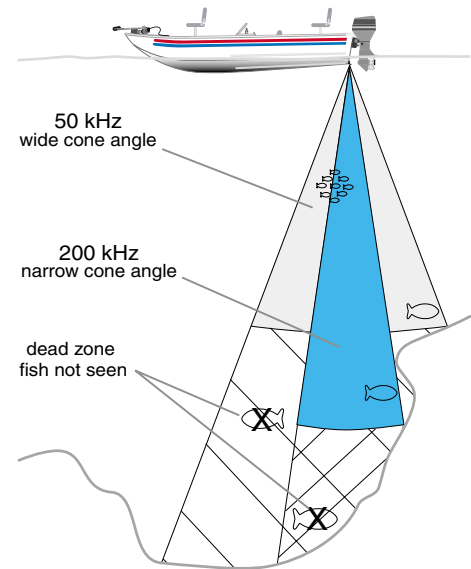

Installation

Mounting the Transducer



DO NOT mount the transducer behind strakes, struts, fittings, water intake or discharge ports, or anything that creates air bubbles or causes the water to become turbulent. It is important that the transducer be in calm, non-turbulent water for optimal performance.

NOTICE: Both the Transom Mount Transducer and the Speed Sensor must be installed separately. These two sensors may not be combined.

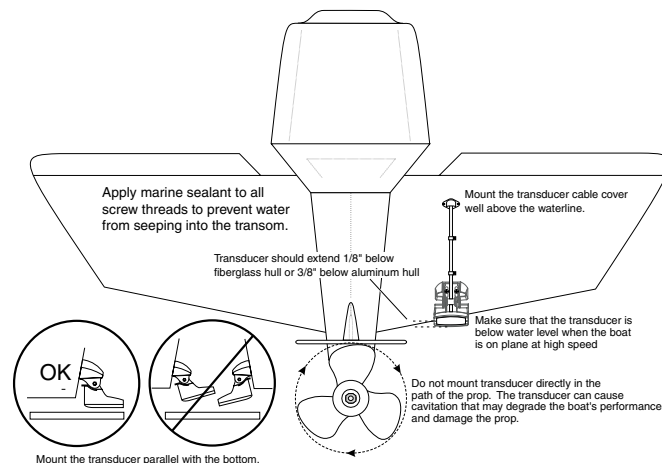

Mount the transducer parallel with the bottom.

Proper transducer installation is key to getting the best performance from your new unit. If the transducer lead is too short, extension cables are available from your GARMIN dealer. **DO NOT** cut the transducer lead or any part of the transducer cable, as this will void your warranty. The cable cannot be spliced and connected to any existing (GARMIN or non-GARMIN) transducer cables.

Following are some tips and basic installation instructions for the optional dual frequency transducer and speed sensor. Detailed installation instructions are provided in the transducer kits.

Transom Mount Installation

Dual Frequency Transom Mount Transducer (with depth/temp).

In-Hull Installation

To avoid drilling a hole to mount a thru-hull transducer, a transom mount transducer may be used with epoxy inside a boat (also called “shoot-thru-hull” installation). For a transducer to be mounted inside the hull (shoot-thru, not thru-hull), the boat must be fiberglass, no core (contact your boat manufacturer if you are unsure). Test by placing a small amount of water inside the hull, placing the transducer on top of the water, then verifying the accuracy of the locators versus the current water depth. If they are the same, use epoxy (non-silicone based) to affix the transducer to the inside of the hull. If using a temperature sensing transducer, the temperature displayed will reflect the hull temperature.

Selecting a Location

The location has to be solid fiberglass, devoid of any air bubbles, laminates, fillers or dead air space. The location needs to be in an area of clean water at all speeds. Do not place the transducer over any strakes or behind any obstruction on the hull that would create turbulence.

Testing the Location

Place the transducer in the water, pointed directly at the bottom, and set the unit for optimum performance. Place the transducer in the test device as show on the side bar. If the sonar performance is significantly degraded, another location will need to be tested.

Mounting the Transducer



Many modern hulls have a pre-located pocket for In-hull transducer installation. If you are unsure if your hull is equipped with a prelocated pocket, contact your hull manufacturer.

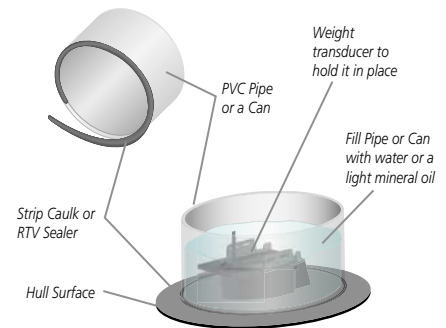

Testing the Location

Installation

Mounting the Transducer/ Speed Sensor

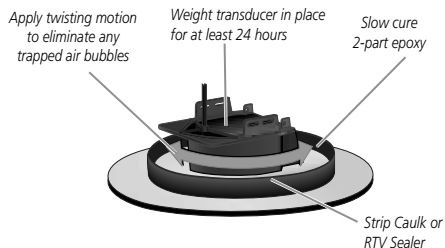

Installing the Transducer

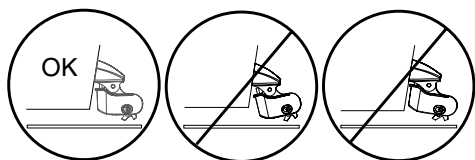

Adjust the speed sensor so it is parallel with the bottom of the boat. If the speed sensor is not adjusted properly, the sonar may experience inaccurate or degraded speed readings.

In-Hull Installation (continued)

Installing the Transducer:

1. Lightly sand the surface of the hull and face of the transducer with 400 grit wet or dry sandpaper.
2. Build a dam using strip caulk about 1/4" tall. Pour about 1/8" of 2-part, slow cure epoxy in the dam. Place the transducer in the epoxy, turning the transducer to work out any air bubbles.
3. Weight the transducer in place and allow to cure for 24 hours.

Speed Sensor Installation

The speed sensor should be mounted as near the center of the boat as possible. Like the transducer, for the speed sensor to operate properly, it should be located in non-turbulent water. Follow the directions in the speed sensor installation instructions to assemble the speed sensor with the mounting bracket, drill holes in the transom, mount the assembly and route the cable.

Drill a 3/4" hole well above the water line.
Coat the inside of the hole with Marine Sealant.

Position Cable Clamps about one-third of the distance from the hole to the transducer.

Drill 1/8" pilot holes 3/8" deep for the mounting screws.
Coat the screws with Marine Sealant before installing them.

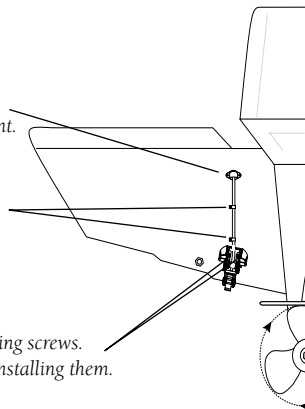

Wiring Harness Installation

The Fishfinder 160 Blue comes with a wiring harness that connects the unit to power and the transducer with one easy-to-remove connection. Make sure the wiring harness will reach the unit before beginning installation.

If it is necessary to extend the power/data wires, use a wire of comparable size and keep your extension as short as possible. If the transducer lead is too short, DO NOT cut the transducer lead to lengthen the cable. This will void the warranty. Transducer extension cables are available in 10' or 20' lengths from your GARMIN dealer.

Wiring to a Fuse Block

If your boat has an electrical system, it may be possible to wire the unit directly to an unused holder on your current fuse block. If you are using the boat's fuse block, remove the in-line fuse holder supplied with the unit.

Installing the Wiring Harness:

1. Determine the polarity of the fuse holder using a Test Light or Volt Meter.
2. Install the Red (+) wire on the Positive Fuse Holder Terminal.
3. Install the Black (-) wire on the Negative Fuse Holder Terminal.
4. Install a 2 amp fuse in the Fuse Holder.



During a typical installation, only the Red and Black wires are used. The Blue wire supplies NMEA data, and doesn't have to be connected for normal operation of the unit. The Yellow (alarm) wire is not used, because the Fishfinder 160 Blue does not support external alarms.

Installing the Wiring Harness

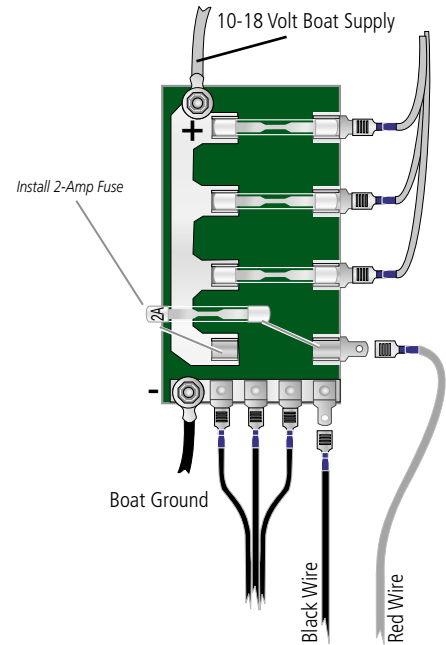

Fishfinder 160 Blue

Installation

Installing the Wiring Harness

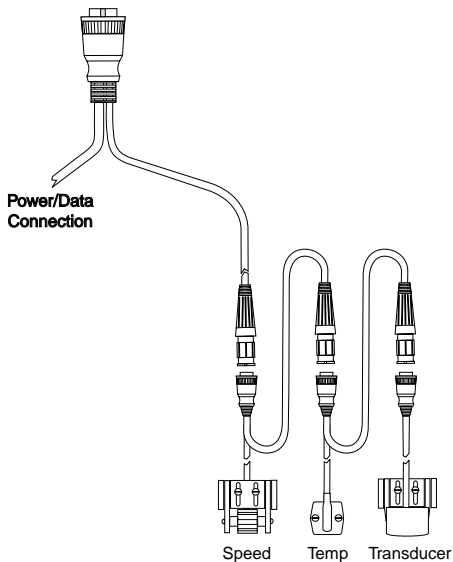

Connecting a Transducer to Multiple Sensors

Wiring Harness Installation (continued)

If your boat does not have a fuse block, the unit can be wired directly to the battery. Make sure the 2-Amp in-line fuse supplied with the unit is installed.

The Fishfinder 160 Blue can be connected to another piece of NMEA-compatible electronic equipment. If equipped with a capable transducer and speed sensor, the Fishfinder 160 Blue sends depth, temperature and speed information that could be displayed on another device.

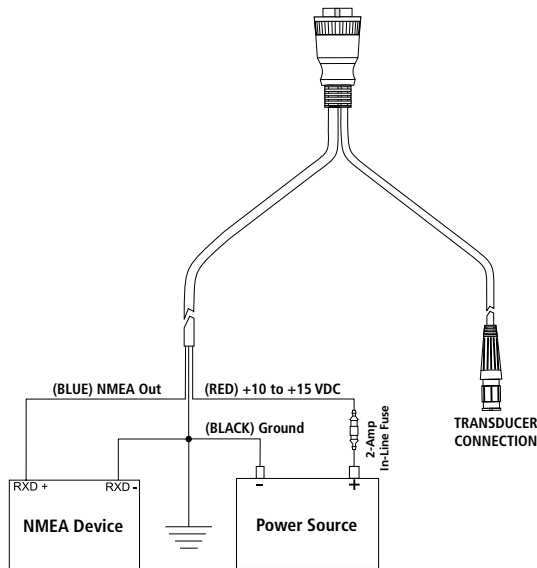

Display Installation (Surface Mount)

The Fishfinder 160 Blue can be mounted to a flat surface using the supplied Surface Mount Bracket.

Surface Mounting the Display:

1. Position the Surface Mount Bracket in the desired location. Leave approximately 2" behind the unit for cable clearance.
2. Mark the location of the four mounting holes with a pencil.
3. Drill pilot holes for the mounting fasteners (not included in kit).
4. Secure the Surface Mount Bracket using the mounting fasteners.
5. Slip the unit into the Surface Mount Bracket.
6. Tighten the knobs to secure the unit to the bracket.



The Surface Mount Bracket is designed to be secured using a flat head screw. If you use a screw with a countersunk head, you risk damaging the Surface Mount Bracket.



Installing the Display

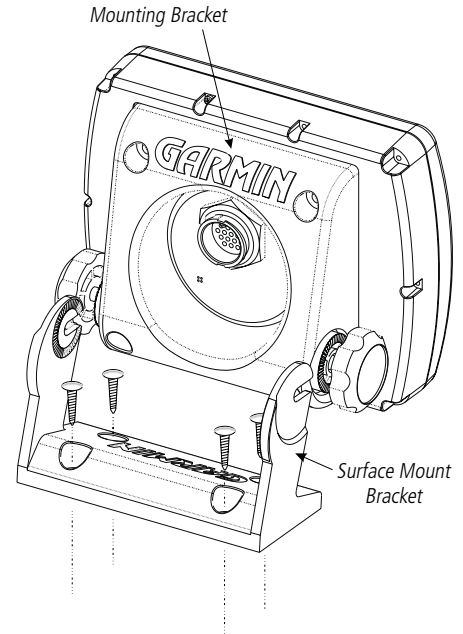

Installing the Display



Be careful not to install screws that are too long!
The mounting holes in the unit are approximately 1/4" deep. Installing screws that are too long will damage the unit and void the warranty.

Display Installation (Flush Mount)

The Fishfinder 160 Blue can be mounted flush against a dash or electronics rack that is no more than 1/4" thick.

Flush Mounting the Display:

1. Remove the Mounting Bracket from the back of the unit by removing its four screws.
2. Using the Mounting Bracket as a template, mark the location of the four mounting holes and the center relief hole.
3. Drill the mounting holes using a 6mm or 15/64" drill.
4. Using a 1-7/8" hole saw, cut the center relief.
5. Secure the unit to the mounting surface using four M5 screws.

If you are flush mounting the unit on a sheet metal surface, use the mounting bracket on the back to help reinforce the metal. You may also purchase the optional Flush Mounting Kit and follow the flush mounting instructions included with the kit.

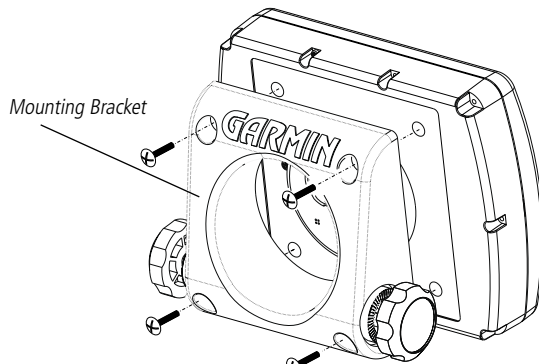

Testing the Installation

S Simulator On



Simulator Message and Icon

If the Fishfinder 160 Blue is in Simulator Mode, the message “Simulator On” will be displayed along the bottom of the screen. The message will be replaced by the “S” icon indicating that the unit is running in simulator mode.

Testing the Installation

While it is possible to perform some checks with the boat trailered, the boat should be in the water to properly test the installation.

Press the **POWER** button and the Fishfinder 160 Blue should power on. If the unit fails to power on, verify that the wiring adapter is seated properly in the back of the unit, the Red and Black wires are connected to the correct polarity, and the 2-Amp fuse is installed and not blown. If the unit is connected to a power supply that exceeds 18 VDC, a ‘Battery Voltage High’ warning will be displayed and the unit will turn off.

As the unit powers on, it should immediately start showing the bottom. Verify that the unit is not in the simulator mode. If the unit is in the simulator mode, make sure that the transducer is connected to the wiring harness.

To test the transducer and speed sensor installation, gradually increase the boat’s speed while checking the unit operation. If the unit displays intermittently or fails to display, verify that the transducer and speed sensor are aligned parallel with the bottom. If necessary, adjust their heights until the unit operates correctly. It may be necessary to make several adjustments to ensure proper operation throughout the speed range. If the signals do not improve, it may be necessary to move the transducer or speed sensor to a different location.



When adjusting the depth of the transducer, make the adjustments in small increments, like 1/8”. Placing the transducer or speed sensor too deep can adversely affect the boat’s performance and increase the risk that they may strike underwater objects.

Unit Operation

Keypad Functions



Arrow Keys

The **ARROW** keys are used to select items on the Adjustment Bar and Setup Menu and to change field data.

Enter Key

The **ENTER** key is used to activate/deactivate the Adjustment Bar and Setup Menu data fields for review or change.

Setup Key

The **SETUP** key is used to activate/deactivate the Setup Menu.

Power and Backlight Key

The **POWER** key is used to turn the unit on/off and to activate the display backlight. Press and hold to turn the unit on or off.

Pressing the **POWER** key briefly will activate the backlight or change the backlight setting. There are three backlight settings; Off, Medium and High.

At the top left of the display you will find the Adjustment Bar and a variety of user-selectable information including Depth, Battery Voltage, Water Temperature, and Speed Over Water. To provide data on Speed Over Water, the Fishfinder 160 Blue requires an additional speed sensor.

The Depth Scale and the Flasher are displayed from top to bottom along the right side of the display. Messages and Alarm Icons are displayed along the bottom.



If the unit is unable to track the bottom for any reason, the digits in the depth window will flash on and off to alert the user that the unit is not tracking the bottom.

Describing The Display

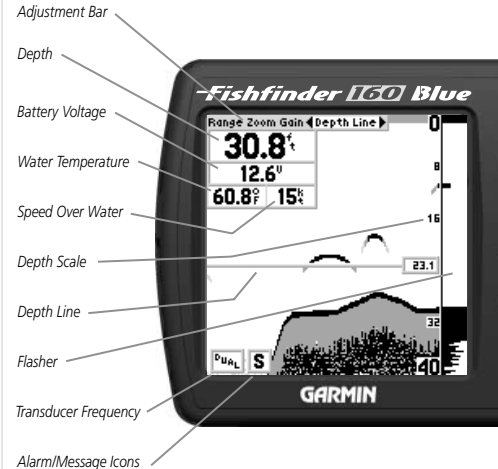

Unit Operation

The Adjustment Bar

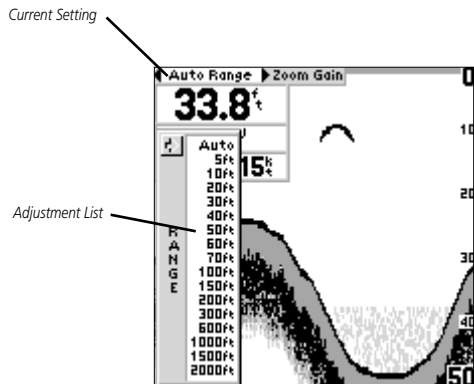

Range Adjustment

Using the Adjustment Bar

The Adjustment Bar allows direct access to the most commonly changed settings. These include the Depth Range, Zoom setting, and the Gain (sensitivity) of the unit.

Place the highlight (white bar) over the desired selection using the **RIGHT** or **LEFT** Arrow key, and the current setting will be displayed in the highlight. To immediately change the setting, press the **UP** or **DOWN** Arrow key. If you wish to review the available settings before making a change, press the **ENTER** key to activate the adjustment list.

Range

The Range Adjustment is used to set the display depth range. The unit can be set to automatically track the bottom or set to a user-specified depth range.

To select a Depth Range:

1. Highlight 'Range' on the Adjustment Bar.
2. Using the **UP** or **DOWN** Arrow, place the pointer at the desired depth range.

To set the unit to automatically track the bottom:

1. Highlight 'Range' on the Adjustment Bar.
2. Using the **UP** or **DOWN** Arrow, select 'Auto' at the top of the adjustment list.

Zoom

The Zoom Adjustment is used to quickly select a display zoom scale.

To change the Zoom Scale:

1. Highlight 'Zoom' on the Adjustment Bar.
2. Using the **UP** or **DOWN** Arrow, select the desired display zoom level.
When a scale other than 'No Zoom' is selected, the Adjustment Bar will display a new selection labeled 'View.'

View

The View Adjustment is available only when a Zoom Scale other than 'No Zoom' is selected. This setting allows you to select a specific area to view on the display, or allows the unit to automatically select a viewing area based on the bottom.

To change the View:

1. Highlight 'View' on the Adjustment Bar.
2. Press the **UP** or **DOWN** Arrows to change the setting.

To have the unit automatically set a View:

1. Highlight 'View' on the Adjustment Bar.
2. Using the **UP** or **DOWN** Arrow, move the slider to the top or bottom of the range, then release and press the Arrow again.

The Adjustment Bar

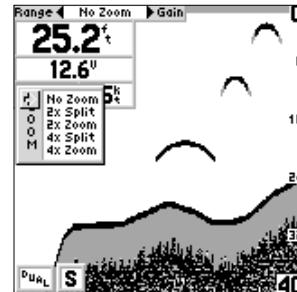

Zoom Adjustment

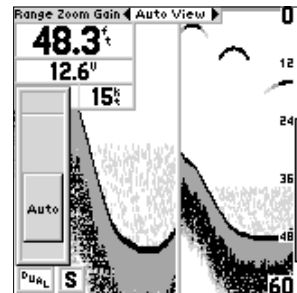

View Adjustment

Unit Operation

The Adjustment Bar

Gain

The Gain Adjustment allows the user to control the sensitivity of the unit's receiver. This provides some flexibility in what is seen on the display. To see more detail, increase the receiver sensitivity by selecting a higher gain (+). If there is too much detail or if the screen is cluttered, lowering the sensitivity (-) may increase the clarity of the display.

To change the Gain:

1. Highlight 'Gain' on the Adjustment Bar.
2. Using the **UP** or **DOWN** Arrows, move the pointer to the desired setting.

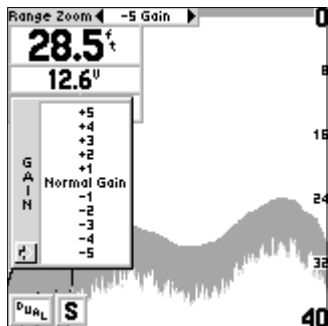

Minimum Gain

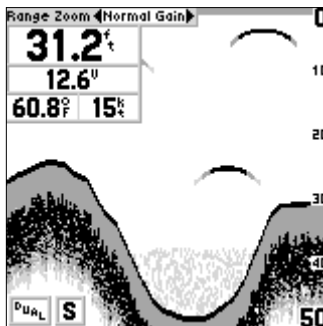

Normal Gain

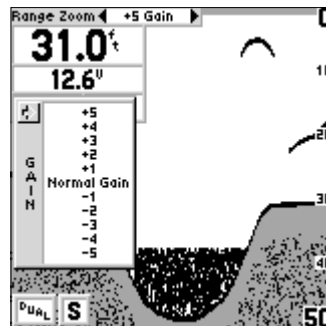

Maximum Gain

SETUP MENU

The Setup Menu contains the unit settings that should not require frequent change. The Setup Menu is divided into eight tabs: Chart, Tools, Numbers, Alarms, System, Calibrations, Units, and Memory. Each tab will be described in more detail in this section.

To enter and exit the Setup Menu, press the **SETUP** button on the face of the unit. The first time that the **SETUP** button is pressed, the Setup Menu will be displayed with the 'Chart' tab highlighted in black. Pressing the **UP** or **DOWN** arrow will move the highlight between the tab selections. Press the **RIGHT** arrow to access the selection fields. Each time the Setup Menu is accessed, the unit will return to the last edited selection field. Press the **LEFT** arrow key to get back to the tabs.

Chart Tab

The 'Chart' tab allows the user to determine the appearance of the scrolling chart display. To access the 'Chart' tab, place the highlight over it using the arrow keys.

Frequency

The 'Frequency' setting allows you to choose a transducer frequency. Frequency refers to the "pitch" of the sound that the transducer sends and receives. You may choose '200kHz' (default), '50kHz' or 'Dual' frequency.

Setup Menu: Chart Tab

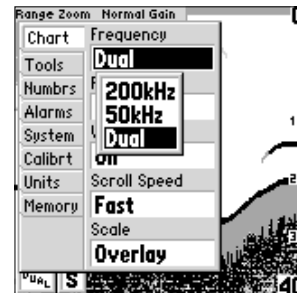

Frequency Settings

Unit Operation

Setup Menu: Chart Tab

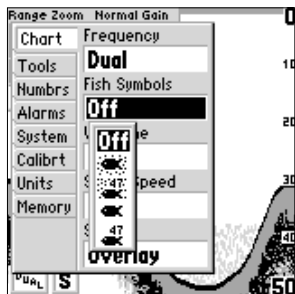

Fish Symbols

Off

— Arches will be displayed representing suspended targets. All available background information will be displayed.



— Suspended targets displayed as symbols. In this mode, background information will still be displayed making fish identification easier.



— Same as above, with target depth displayed.



— Suspended targets displayed as symbols. No background information will be displayed in this mode.



— Same as above, with target depth displayed.

Frequency (continued)

The wide cone angles associated with low frequencies (40° for 50kHz) provide a large coverage area for finding fish. However, this also means that wide cone angles produce less bottom detail and resolution. The narrow cone angles associated with high frequencies (10° for 200kHz) provide better bottom resolution and crisper detail, but therefore cannot show a large coverage area for finding fish. Dual frequency mode combines the improved contour detail and depth readings of the 200kHz frequency with the wide coverage area of the 50kHz frequency.

To select a Frequency:

1. Highlight the 'Chart' tab on the Setup Menu.
2. Highlight the 'Frequency' selection field and press **ENTER**.
3. Using the **UP** or **DOWN** Arrow, choose '200kHz,' '50kHz' or 'Dual' and press **ENTER**. The selected frequency will be displayed in the bottom left-hand corner of the chart.

Fish Symbols

'Fish Symbols' allows the user to determine how the chart will display underwater targets and background information. If 'Fish Symbols' is set to 'Off,' the unit will display all of the available information about the underwater environment. If a fish symbol is selected, the chart will display only the information related to that symbol.

To select a Fish Symbol:

1. Highlight the 'Chart' tab on the Setup Menu.
2. Highlight the 'Fish Symbols' selection field and press **ENTER**.
3. Using the **UP** or **DOWN** Arrow, select the desired symbol and press **ENTER**.



NOTE: When the frequency is set to 'Dual,' the appearance of the fish symbols will change. Fish returns from the center of the beam will be black, but the fish returns from the edges of the beam will be clear.

Whiteline

'Whiteline' controls how the unit displays information about the bottom type (hard or soft). With the Whiteline 'OFF', the bottom return will display as black and contain no information on bottom hardness. With Whiteline 'ON', the bottom return will become gray-scaled. The degree of gray-scale can be used to determine bottom hardness. See page 33 for more details on this feature.

To change the Whiteline Setting:

1. Highlight the 'Chart' tab on the Setup Menu.
2. Highlight the 'Whiteline' selection field and press **ENTER**.
3. Choose 'On' or 'Off' and press **ENTER** to accept the selection.

Scroll Speed

You can adjust the speed that the chart scrolls from right to left by using the 'Scroll Speed' selection field. If you are sitting still or the chart is moving too fast, slowing the scroll rate can be beneficial.

To adjust the Scroll Speed:

1. Highlight the 'Chart' tab on the Setup Menu.
2. Highlight the 'Scroll Speed' selection field and press **ENTER**.
3. Choose 'Fast,' 'Medium,' 'Slow' or 'Pause,' then press **ENTER** to accept the selection.

Setup Menu: Chart Tab

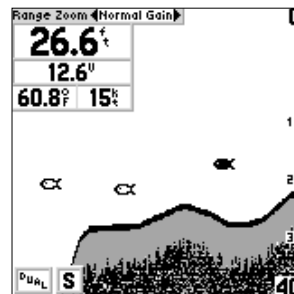

Fish Symbols in Dual Frequency Mode

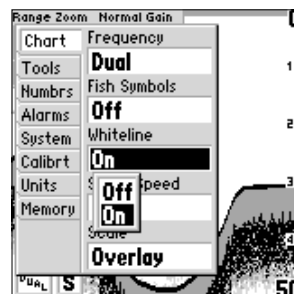

Whiteline Selections

Unit Operation

Setup Menu: Chart/Tools Tabs

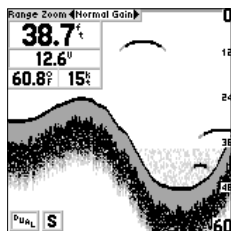

Scale — 'Overlay'

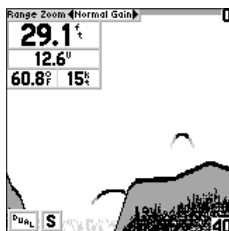

Scale — 'Corners'

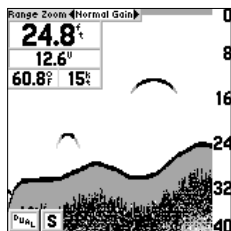

Scale — 'Basic'

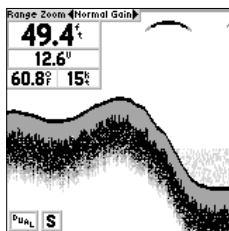

Scale — 'No Scale'

Scale

The depth 'Scale' is displayed vertically along the right side of the chart. The depth 'Scale' can be configured to display in four different modes: as an 'Overlay,' in the 'Corners,' as a 'Basic' Scale, or with 'No Scale.'

To change the Scale Setting:

1. Highlight the 'Chart' tab on the Setup Menu.
2. Highlight the 'Scale' selection field and press **ENTER**.
3. Choose 'Overlay,' 'Corners,' 'Basic' or 'No Scale,' then press **ENTER** to accept the selection.

Tools Tab

The 'Tools' tab contains the 'Depth Line,' 'Flasher,' 'Simulator' and 'Noise Reject' tools. The 'Depth Line' tool is used to quickly identify a set depth or to measure the depth of underwater objects. The 'Noise Reject' and 'Flasher' tools are used to enhance the chart and help in identifying and providing information about an underwater return. The 'Simulator' tool is used to enhance the simulator mode by allowing you to customize the simulated transducer selection. To access the 'Tools' tab, place the highlight over it using the arrow keys.

Depth Line

When the 'Depth Line' tool is activated, a Depth Line selection is added to the Adjustment Bar.

To activate the Depth Line:

1. Highlight the 'Tools' tab on the Setup Menu.
2. Highlight the 'Depth Line' selection field and press **ENTER**.
3. Select 'On' and press **ENTER**.

To change the Depth Line Setting:

1. Place the highlight over the 'Depth Line' selection on the Adjustment Bar.
2. Use the **UP** or **DOWN** Arrow to change the setting, press **ENTER** to accept the change.

Flasher

With the 'Flasher' tool active, a graphic Flasher representation will be displayed on the far right side of the chart. This graphic Flasher displays structure and bottom returns much the same as a true Flasher. You may find this feature particularly useful when using 'Fish Symbols.'

To Turn the Graphic Flasher on and off:

1. Highlight the 'Tools' tab on the Setup Menu.
2. Highlight the 'Flasher' selection field and press **ENTER**.
3. Select 'On' or 'Off' and press **ENTER** to accept the selection.

Simulator

The 'Simulator' tool allows the unit to simulate the use of four different transducer configurations: 'Depth Only', 'Temp', 'Speed', or 'Temp and Speed'. These choices allow the user to view more accurate depictions of actual unit operation. For details on using the simulator, see page 35.

Noise Reject

The 'Noise Reject' tool helps filter unwanted noise from the chart. The 'Noise Reject' tool can be turned 'Off,' set for 'Auto' (automatic) adjustment or set for 'Manual' adjustment.



Remember when setting the Noise Reject tool, the higher the noise rejection setting, the more likely the unit is to not show fish or structure.

Continued on page 20

Download from www.Somanuals.com. All Manuals Search And Download.

Setup Menu: Tools Tab

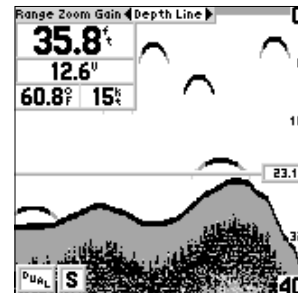

Depth Line Activated

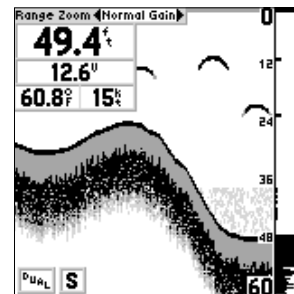

Graphic Flasher Activated

Unit Operation

Setup Menu: Tools/Numbers Tabs

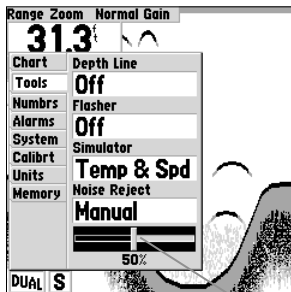

Noise Reject Manual Adjustment Slider

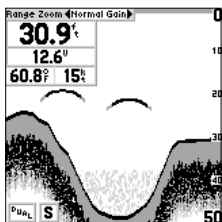

Normal Numbers

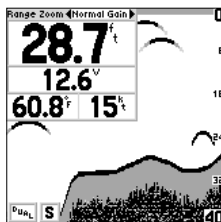

Large Numbers

Noise Reject (continued)

To change the Noise Reject Setting:

1. Highlight the 'Tools' tab on the Setup Menu.
2. Highlight the 'Noise Reject' selection field and press **ENTER**.
3. Choose 'Off,' 'Auto,' or 'Manual' and press **ENTER**.

To manually adjust the Noise Reject Setting:

1. Select 'Manual' in the 'Noise Reject' field of the 'Tools' tab, then press **ENTER**. A slider will appear below the 'Noise Reject' selection field.
2. Use the Up or Down **ARROW** key to highlight the slider, then press **ENTER**.
3. Use the Left or Right **ARROW** key to manually adjust the Noise Reject to the desired setting, then press **ENTER**.

Numbers Tab

The 'Numbrs' (Numbers) tab allows you to choose whether you would like to see normal or large numbers on the chart. You can also configure the unit to display 'Battery Voltage,' (water) 'Temperature,' and 'Speed' Over Water if the unit is equipped with capable sensors. You can also set up how the unit finds the digital 'Depth Number.' To access the 'Numbrs' tab, place the highlight over it using the arrow keys.

Number Size

This setting determines the size of the numbers displayed in the 'Depth,' 'Temperature,' 'Battery Voltage' and 'Speed' fields on the chart.

To select Normal or Large Numbers:

1. Highlight the 'Numbrs' tab on the Setup Menu.
2. Highlight the 'Number Size' selection field and press **ENTER**.
3. Choose 'Normal' or 'Large' and press **ENTER** to accept the selection.

Setup Menu: Numbers Tab

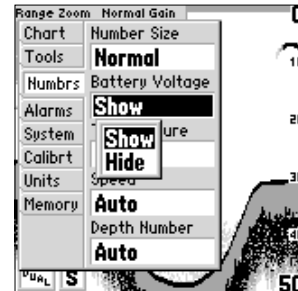

Battery Voltage Selections

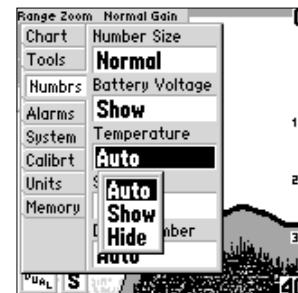

Temperature Display Selections

Battery Voltage

The Fishfinder 160 Blue can display the current battery voltage on the chart.

To show or hide the Battery Voltage display field:

1. Highlight the 'Numbrs' tab on the Setup Menu.
2. Highlight the 'Battery Voltage' selection field and press **ENTER**.
3. Choose 'Show' or 'Hide' and press **ENTER** to accept the selection.

Temperature

The Fishfinder 160 Blue can display the water temperature when equipped with a temperature-sensing transducer. The unit has the ability to automatically sense when a temperature-capable transducer is connected. The temperature field can be shown or hidden, regardless of the transducer installed.

To set the Temperature display field:

1. Highlight the 'Numbrs' tab on the Setup Menu.
2. Highlight the 'Temperature' selection field and press **ENTER**.
3. Choose 'Auto,' 'Show' or 'Hide,' then press **ENTER** to accept the selection.

Unit Operation

Setup Menu: Numbers Tab

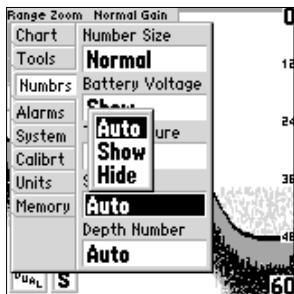

Speed Display Selections

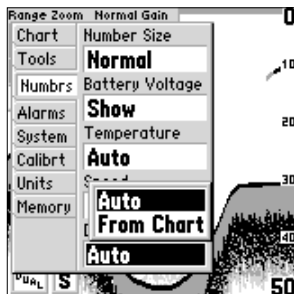

Depth Number Selections

Speed

The Fishfinder 160 Blue can display the boat's 'Speed' Over Water when equipped with a speed sensor. When set to 'Auto,' the unit will automatically sense when a capable sensor is connected and display the boat's speed.

To set the Speed display field:

1. Highlight the 'Numbrs' tab on the Setup Menu.
2. Highlight the 'Speed' selection field and press **ENTER**.
3. Choose 'Auto,' 'Show' or 'Hide,' then press **ENTER** to accept the selection.

Depth Number

The 'Depth Number' setting refers to how the unit finds the digital depth number that is displayed in the upper left corner of the screen. When set to 'Auto,' the unit will show the most accurate digital depth possible. However, this may cause the chart to update slower as the unit calculates the 'Auto' depth. When set to 'From Chart' (default), the unit finds the digital depth from the same image you see on the chart. The 'From Chart' setting allows the chart to update faster than when the unit is set to 'Auto' and is recommended when using the unit in deep water.



NOTE: In 'From Chart' mode, the Fishfinder 160 Blue may not be able to get the digital Depth Number if the bottom is not visible on the chart. Adjust the Depth Range on the Adjustment Bar until the bottom is visible, or change the setting to 'Auto' to get the digital Depth Number.

To change the Depth Number Setting:

1. Highlight the 'Numbrs' tab on the Setup Menu.
2. Highlight the 'Depth Number' selection field and press **ENTER**.
3. Choose 'Auto' or 'From Chart,' then press **ENTER** to accept the selection.

Setup Menu: Alarms Tab

Alarms Tab

The 'Alarms' tab allows you to activate and configure the four alarms available in the Fishfinder 160 Blue. To access the 'Alarms' tab, place the highlight over it using the arrow keys. See page 37 for alarm icons and messages.

Fish Alarm

The 'Fish Alarm' can be configured to sound by fish size. There are four different alarm selections: 'Off,' 'Small, Medium and Large,' 'Medium and Large,' or 'Large.' The 'Fish Alarm' will sound with or without the 'Fish Symbols' activated on the Chart Tab of the Setup Menu.

To set a Fish Alarm:

1. Highlight the 'Alarms' tab on the Setup Menu.
2. Highlight the 'Fish Alarm' selection field and press **ENTER**.
3. Choose the desired setting, then press **ENTER** to accept the selection.

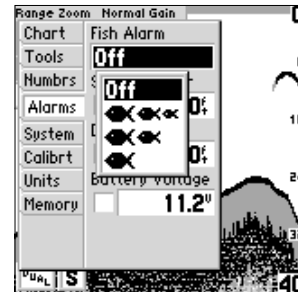

Fish Alarm Selections

Unit Operation

Setup Menu: Alarms Tab

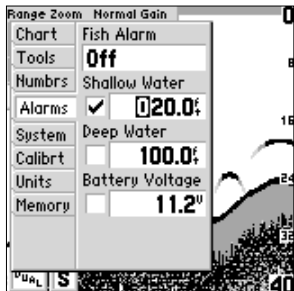

Shallow Water Alarm

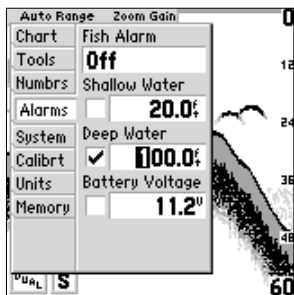

Deep Water Alarm

Shallow Water

The 'Shallow Water' Alarm can be set to sound a warning at a depth determined by the user. The alarm must be activated before the unit will sound a warning.

To activate/deactivate the Shallow Water Alarm:

1. Highlight the 'Alarms' tab on the Setup Menu.
2. Highlight the 'Shallow Water' checkbox.
3. Pressing **ENTER** will insert or remove a check mark in the checkbox.

To set the Shallow Water Alarm depth:

1. Highlight the 'Shallow Water' depth field and press **ENTER**.
2. Use the Arrow Keys to input the desired depth, then press **ENTER** to accept the setting.

Deep Water

The 'Deep Water' Alarm can be set to sound a warning at a depth determined by the user. The alarm must be activated before the unit will sound a warning.

To activate/deactivate the Deep Water Alarm:

1. Highlight the 'Alarm' tab on the Setup Menu.
2. Highlight the 'Deep Water' checkbox.
3. Pressing **ENTER** will insert or remove a check mark in the checkbox.

To set the Deep Water Alarm depth:

1. Highlight the 'Deep Water' depth field and press **ENTER**.
2. Use the Arrow Keys to input the desired depth, then press **ENTER** to accept the setting.

Battery Voltage

When activated, the 'Battery Voltage' Alarm will warn you when the battery voltage reaches a user determined state of discharge.

To activate/deactivate the Battery Voltage Alarm:

1. Highlight the 'Alarm' tab on the Setup Menu.
2. Highlight the 'Battery Voltage' checkbox.
3. Pressing **ENTER** will insert or remove a check mark in the checkbox.

To set the Battery Voltage Alarm:

1. Highlight the 'Battery Voltage' field and press **ENTER**.
2. Use the Arrow Keys to input the desired voltage, then press **ENTER** to accept the setting.

System Tab

The 'System' tab contains the 'Contrast,' 'Beeper,' 'NMEA Output' and 'Language' setups. To access the 'System' tab, use the arrow keys to highlight it.

Contrast

The display 'Contrast' may need to be adjusted to compensate for light levels or viewing angles.

To adjust the Contrast:

1. Highlight the 'System' tab on the Setup Menu.
2. Highlight the 'Contrast' Adjustment field and press **ENTER**.
3. Using the Right/Left **ARROW** keys, move the slider Right to darken the screen, or Left to lighten the screen. When finished, press **ENTER** to accept the setting.

Setup Menu: Alarms/System Tabs

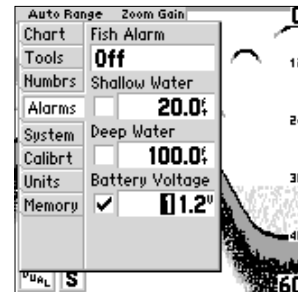

Battery Voltage Alarm

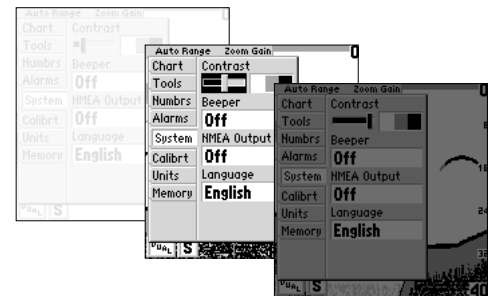

Contrast Adjustment

Unit Operation

Setup Menu: System Tab



Beeper Selections



Language Selections

Beeper

The 'Beeper' field contains three settings: 'Off,' 'Alarms Only,' and 'Key & Alarm.'

To change the Beeper Setting:

1. Highlight the 'System' tab on the Setup Menu.
2. Highlight the 'Beeper' field and press **ENTER**.
3. Choose 'Off,' 'Alarms Only,' or 'Key & Alarm,' then press **ENTER** to accept the setting.

NMEA Output

The Fishfinder 160 Blue has the ability to output information about Depth, Speed, and Water Temp for display on another NMEA-compatible device.

To activate/deactivate the NMEA Output:

1. Highlight the 'System' tab on the Setup Menu.
2. Highlight the 'NMEA Output' field and press **ENTER**.
3. Choose 'Off' or 'On,' then press **ENTER** to accept the setting.

Language

The Fishfinder 160 Blue can display chart information in several different languages.

To select a Language:

1. Highlight the 'System' tab on the Setup Menu.
2. Highlight the 'Language' field and press **ENTER**.
3. Use the Arrow Keys to select the desired language from the list and press **ENTER** to accept the setting.

Calibrations Tab

The 'Calibr' tab contains the 'Keel Offset' and 'Water Type' setups, and a 'Calibrate Speed' function for use when a speed sensor is installed.

Keel Offset

The 'Keel Offset' field allows the user to offset the depth reading for a keel or for the draw on a larger vessel. This setting should not need to be changed on smaller recreational boats.

To set a Keel Offset:

1. Highlight the 'Calibr' tab on the Setup Menu.
2. Highlight the 'Keel Offset' field and press **ENTER**.
3. Use the Arrow Keys enter a new offset, then press **ENTER** to accept.

Water Type

Since sound waves travel through fresh and salt water at different rates, it is necessary to select the 'Water Type' to ensure accurate depth readings.

To change the Water Type:

1. Highlight the 'Calibr' tab on the Setup Menu.
2. Highlight the 'Water Type' selection field and press **ENTER**.
3. Choose 'Fresh' or 'Salt,' then press **ENTER** to accept the selection.

Calibrate Speed

The 'Calibrate Speed' field will be enabled when a speed sensor is installed or when you are in simulator mode. This allows you to calibrate the Fishfinder speed to your boat's speedometer or to your GPS speed.

To calibrate the Speed:

1. Highlight the 'Calibr' tab on the Setup Menu.
2. Highlight the 'Calibrate Speed' button and press **ENTER**.
3. Run your boat, noting your top speed. Stop the boat and press **ENTER**.
4. With the speed field highlighted, press **ENTER** and input your top speed. Highlight 'OK,' and press **ENTER** to finish the calibration.

Download from www.Somanuals.com. All Manuals Search And Download.

Setup Menu: Calibrations Tab

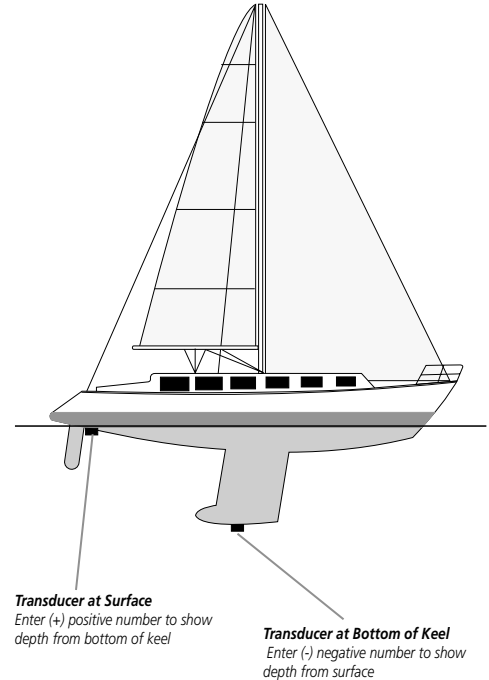

Unit Operation

Setup Menu: Units Tab

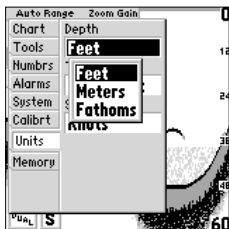

Depth Selections

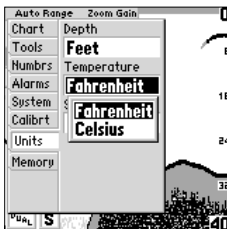

Temperature Selections

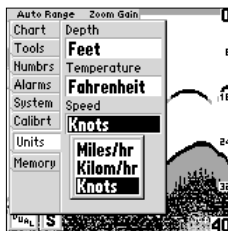

Speed Selections

Units Tab

The 'Units' tab contains settings for 'Depth,' 'Temperature' and 'Speed.' To access the 'Units' tab, use the arrow keys to highlight it.

Depth

The 'Depth' field can be configured to display in Feet (ft), Meters (m) or Fathoms (fa).

To select a Depth Unit:

1. Highlight the 'Units' tab on the Setup Menu.
2. Highlight the 'Depth' field and press **ENTER**.
3. Select 'Feet,' 'Meters' or 'Fathoms,' then press **ENTER** to accept the new setting.

Temperature

If equipped with a temperature-capable transducer or a separate temperature sensor, the unit can display water temperature in Fahrenheit (°F) or Celsius (°C).

To Select a Temperature Unit:

1. Highlight the 'Units' tab on the Setup Menu.
2. Highlight the 'Temperature' field and press **ENTER**.
3. Select 'Fahrenheit' or 'Celsius,' then press **ENTER** to accept the setting.

Speed

If equipped with a speed sensor, the unit can display the boat's 'Speed' Over Water. The unit can be configured to display 'Miles-Per-Hour' (mh), 'Kilometers-Per-Hour' (kh), or 'Nautical Miles-Per-Hour' (kt).

To select a Speed Unit:

1. Highlight the 'Units' tab on the Setup Menu.
2. Highlight the 'Speed' field and press **ENTER**.
3. Select 'Miles/hr,' 'Kilom/hr' or 'Knots,' then press **ENTER** to accept the new setting.

Memory Tab

The 'Memory' tab contains the settings for unit memory and allows you to reset the unit to the factory settings and review the software version. To access the 'Memory' tab, use the arrow keys to highlight it.

Remember

The Fishfinder 160 Blue can be set to remember its settings each time you power it on. You can set it to remember the settings in the Setup Menu ('Setup Only') or the unit's settings in both the Setup Menu and the Adjustment Bar ('All').

To select a Memory Setting:

1. Highlight the 'Memory' tab on the Setup Menu.
2. Highlight the 'Remember' field and press **ENTER**.
3. Choose 'All' or 'Setup Only,' then press **ENTER** to accept the selection.

Factory Setup

To restore the Factory Settings:

1. Highlight the 'Memory' tab on the Setup Menu.
2. Highlight the 'Factory' Setup button and press **ENTER**.
3. Choose 'OK' to reset the unit or 'Cancel' to abort.

Software Version

The 'Software Version' Button will report information about the current software version in the unit and display the Unit ID Number.

To activate the Software Version Window:

1. Highlight the 'Memory' tab on the Setup Menu.
2. Highlight the 'Software Version' button and press **ENTER**.
3. Press **ENTER** to close the information window.

Setup Menu: Memory Tab

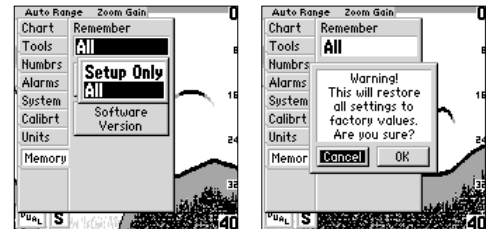

Remember Selections

**Restore
Factory Settings**



Software Version Information

Unit Operation and the Chart

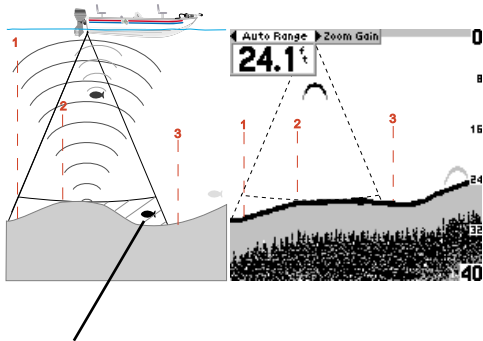

This fish is currently in a Dead Zone and is not detected by the sonar. The fish is in the coverage area of the transducer, but remember the first strong return sets the bottom level. The fish will never be detected since the bottom level will never be set below the fish. The fish on the right side of the display (shown in light grey) will be detected and displayed when the transducer cone passes over the fish.

Understanding Sonar

If you are unfamiliar with sonar, or need help determining what is displayed on the chart, then this section may be for you. This section is intended to help the novice user gain some understanding of how the Fishfinder 160 Blue operates and how it can help improve their fishing productivity.

To understand what the unit is displaying, it is important to have a general knowledge of how the unit works and how it determines what to display. Briefly described, the unit operates by transmitting sound waves toward the bottom of a lake, stream or seabed in a cone-shaped pattern. When a transmitted sound wave strikes an underwater object such as the bottom, a piece of structure, or a fish, sound is reflected back to the transducer. The transducer collects the reflected sound waves and sends the data to the unit to be processed and displayed on the chart. Underwater data is displayed on the chart in the order that the reflected sound waves are received. The diagram in the sidebar demonstrates this, showing an underwater scene as it would be displayed on the chart. Generally speaking, if the only thing between the transducer and a flat bottom is water, the first strong return will come from the bottom directly below the transducer, this return will set the bottom level. Weaker secondary returns provide the detailed data. Stronger returns will display in darker colors, with black being the strongest return. In Examples 1 and 2 (page 32), you can see that the branches and the fish were the strongest secondary returns and are indicated in black on the display.

That is a brief description of how your Fishfinder operates. Let's take a look at how this data can help you to improve your fishing.

Transducer Coverage

The area covered by the transmitted sound waves is determined by the cone angle of the transducer and the water depth. The 50kHz frequency provides a 40° cone angle, with a coverage width that is approximately 2/3 of the water depth. As shown in the sidebar, the 40° cone angle (50kHz frequency) approximately covers the area of a 20 foot diameter circle at a 30 foot depth. The 200kHz frequency provides a 10° cone angle, with a coverage width that is approximately 2/10 of the water depth. As shown, the 10° cone angle (200kHz frequency) approximately covers the area of a 6 foot diameter circle at a 30 foot depth.

When using the Fishfinder 160 Blue in 'Dual' frequency mode, the unit transmits both 50kHz and 200kHz signals at the same time. The 'Dual' frequency capability of the Fishfinder 160 Blue allows the user to have a large coverage area and still retain good bottom resolution. When in 'Dual' frequency mode the unit uses the 200kHz to display detailed bottom information, keeping "Dead Zones" to a minimum, and the 50kHz signal for the large coverage area.

Fish returns from the 50kHz and 200kHz beams will appear differently on the display. The 50kHz beam tends to show longer fish returns than the 200kHz beam. The examples below show simulated fish returns at 50 and 200 kHz.

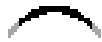

50kHz



200kHz

Transducer Coverage

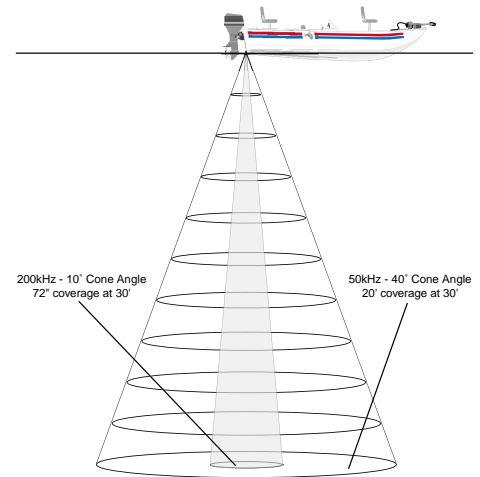

Understanding the Chart



Remember that the Fishfinder displays a 2-D picture of the underwater environment. The fish and tree could be located anywhere in the coverage area produced by the sonar cone at the object's indicated depth.

Understanding the Chart

It is important to understand that the unit does not display a 3-D representation of the underwater environment. The unit can display multiple things at the same time, but cannot determine from *where* the return originated. It can only determine *when* the return was received.

Examples 1 and 2 provide a look at the underwater world from a top view, and illustrate how these views would be displayed on the chart. On both charts it appears the fish and tree are side by side as shown in Example 1. However, when we look at Example 2, we see that the fish can be several feet from the tree. It is important to remember that the Fishfinder cannot determine where in the coverage area the tree or fish are, only that the returns were received at the indicated depths in the same time frame.

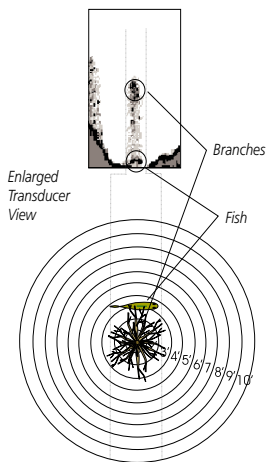

Example 1

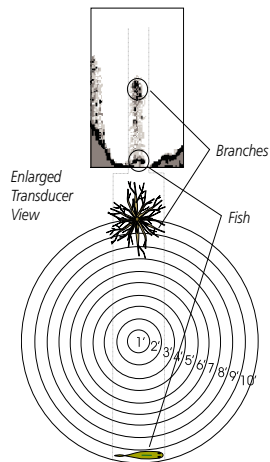

Example 2.

Whiteline

The Fishfinder 160 Blue can help you to determine if the bottom is hard or soft. When the sonar soundwaves are reflected back by the bottom, a hard bottom will return a stronger signal than a soft bottom. The stronger the bottom return, the wider the bottom layer is displayed. The unit uses the Whiteline function to make this bottom layer information easier to distinguish.

When viewing the display without Whiteline active, the bottom return is black. While you can make some determination of the bottom type, the black return makes this more difficult. With the Whiteline active, the bottom return appears layered in shades of gray and black, which makes determining the bottom type easier and more reliable. Example 3 shows the bottom return with and without the Whiteline activated.

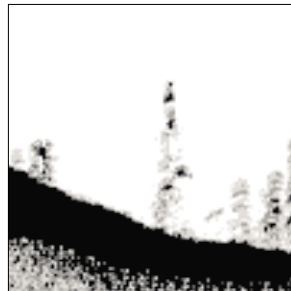

Whiteline Turned Off

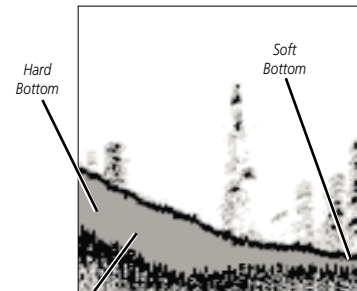

Whiteline

Whiteline Activated



Understanding the Chart

Whiteline can also help you to determine the type of bottom structure that is displayed on the chart. By determining the hardness of the structure you can make a better informed decision as to the type of structure.



Structure is hard, probably a rock or stump



Structure is soft, probably a mud pile

Understanding the Chart

Thermoclines

A rough definition of a thermocline is a break in water where the water temperature changes at a faster rate than the water above it. The thermocline is usually displayed as a gray level, as shown below.

One of the unique features offered by GARMIN is See-Thru technology. A benefit of See-Thru technology is that it allows the Fishfinder 160 Blue to see fish inside thermoclines.

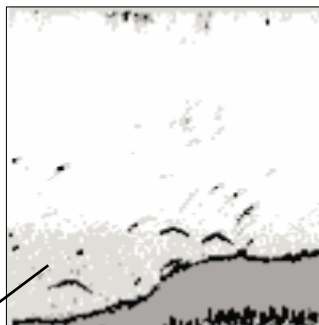

Thermocline

Simulator Mode

The Fishfinder 160 Blue comes with a built-in simulator. While in simulator mode, the unit will display a random bottom scene, and the Fishfinder 160 Blue can be controlled just as if it were on the water. Using simulator mode allows the user to practice and learn the operation of the unit without having to be on the water.

If the Fishfinder 160 Blue is turned on without a transducer connected, the unit will start in simulator mode. Also the unit can be switched into simulator mode by selecting one of the simulated transducer options from the 'Simulator Selection' field as described below. The unit will indicate that it is running in simulator mode by displaying a message across the bottom of the screen. The message will be replaced by the "S" simulator-mode icon in the lower left corner of the screen.

The unit can be configured to act as if a variety of transducers are installed while in the simulator mode.

To Select a Simulated Transducer:

1. Press the **SETUP** button on the face of the unit.
2. Using the Arrow keys, highlight the 'Tools' tab then the 'Simulator' selection field.
3. Press **ENTER**. Choose the desired transducer from the list.
4. Press **ENTER** to accept the transducer selection.

To exit the Simulator, select 'Off' from the list or transducer selections, or turn the unit off.

Simulator Mode

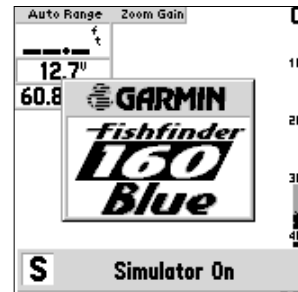

Simulator Message and Icon

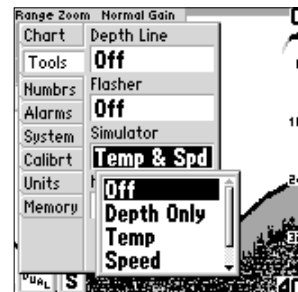

Simulator Transducer Selections

Specifications

Physical

Case: Fully gasketed, high-impact plastic alloy

Display: 3.3" x 3.3" (8.3 x 8.3 cm), 4.6" diagonal (11.7 cm),
160 H x 160 W pixels, FSTN LCD with incandescent backlighting

Size: 4.93" H x 6.3" W x 3.0" D (12.5 x 16 x 7.6 cm)

Weight: 22 oz.

Temperature Range: +5° to 158°F (-15°C to 70°C)

Waterproof: IEC 529, level IPX-7 (submerged to 1 meter for 30 minutes)

Power

Input: 10 to 18 VDC with High Voltage Protection

Usage: 12 watts maximum

Nominal: 12 VDC @ 0.8 amps

Performance

Sonar Power Output: 500 watts (RMS), 4000 watts (peak to peak)

Frequency: 200/50 kHz (10°/40°)

Depth 1500 foot max depth*

NMEA

Support: NMEA 0183 Versions 2.0 - 2.3

Output Sentences: DBT, DPT, NTW, VHW

* Depth capability is dependent on water salinity, bottom type and other water conditions.

Specifications subject to change without notice.

Messages and Alarms

Alarm Messages and Icons

The Fishfinder 160 Blue displays a message when an alarm is tripped. To clear the message, press the **ENTER** key. If the **ENTER** key is not pressed, the unit will automatically remove most messages after 10 seconds and display a reminder icon in the lower left corner of the chart until the alarm is no longer valid.

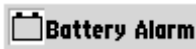

Battery Voltage Low



Deep Water Alarm



Shallow Water Alarm

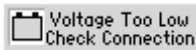

Supply Voltage Low

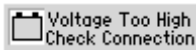

Supply Voltage High



Unit Needs Repair



Unit Needs Repair

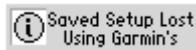

Memory Deleted

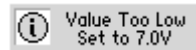

Increase Battery Voltage
Alarm Setting



Fish Alarm

Index

A	
Accessories	iii
Adjustment Bar	12-14
Alarm Messages	37
Alarms Tab	23-25
Arrow Keys	10
B	
Backlight	10
Battery	37
Battery Voltage Alarm	25
Battery Voltage Display	21
Beeper	26
Bottom Structure	vi, 32-33
C	
Calibrate Speed	27
Calibrations Tab	27
Chart Tab	15-18
Contrast	25
Customer Service	i

D	
Deep Water Alarm	24
Depth Line	18-19
Depth Number	22-23
Depth Range	12
Depth Scale	18
Depth Units	28
Display	vi, 11
Display Installation	7-8
E	
Enter Key	10
F	
Factory Setup	29
Fish Alarm	23
Fish Symbols	16-17
Flasher	19
Flush Mounting the Display	8
Frequency	15-16, 31
G	
Gain Adjustment	14
Graphic Flasher	19
I	
In-Hull Installation	3
Installing the Display	7-8
Installing the Speed Sensor	4
Installing the Transducer	2-4
Installing the Wiring Harness	5-6

Index

K	
Keel Offset.....	27
Keypad.....	10
L	
Language.....	26
Limited Warranty.....	ii
M	
Memory Tab.....	29
Messages.....	37
Mounting the Display.....	7-8
Mounting the Speed Sensor.....	4
Mounting the Transducer.....	2-4
N	
NMEA Output.....	26
Noise Reject.....	19
Number Size.....	20
Numbers Tab.....	20-23
O	
Operation.....	30
P	
Packaging.....	iii
Power Key.....	10
Product Registration.....	i
R	
Range Adjustment.....	12
Remember Settings.....	29
Restore Factory Settings.....	29

S	
Scale.....	18
Scroll Speed.....	17
Setup Key.....	10
Setup Menu.....	15-29
Shallow Water Alarm.....	24
Simulator.....	19, 35
Software Version.....	29
Specifications.....	36
Speed Calibration.....	27
Speed Display.....	22
Speed Sensor Installation.....	4
Speed Units.....	28
Surface Mounting the Display.....	7
System Tab.....	25-26
T	
Table of Contents.....	iv-v
Temperature Display.....	21
Temperature Units.....	28
Testing the Installation.....	9
Thermocline.....	vi, 34

Index

T	
Tools Tab.....	18-20
Transducers.....	1, 31
Transom Mount Installation	2
U	
Understanding Sonar.....	30
Understanding the Chart.....	32-34
Units Tab.....	28
V	
View Adjustment.....	13
W	
Warranty	ii
Water Depth.....	vi, 28
Water Temperature.....	vi, 21, 28
Water Type	27
Whiteline	17, 33
Wiring Harness Installation.....	5-6
Z	
Zoom Adjustment	13



© 2001 GARMIN Corporation

GARMIN International, Inc.
1200 East 151st Street, Olathe, Kansas 66062, U.S.A.

GARMIN (Europe) Ltd.
Unit 5, The Quadrangle, Abbey Park Industrial Estate, Romsey, SO51 9AQ, U.K.

GARMIN Corporation
No. 68, Jangshu 2nd Road, Shijr, Taipei County, Taiwan

www.garmin.com

Free Manuals Download Website

<http://myh66.com>

<http://usermanuals.us>

<http://www.somanuals.com>

<http://www.4manuals.cc>

<http://www.manual-lib.com>

<http://www.404manual.com>

<http://www.luxmanual.com>

<http://aubethermostatmanual.com>

Golf course search by state

<http://golfingnear.com>

Email search by domain

<http://emailbydomain.com>

Auto manuals search

<http://auto.somanuals.com>

TV manuals search

<http://tv.somanuals.com>