

# COMPONENT

.com

Technisches Handbuch / Technical Manual

## Systembaugruppe / Systemboard D1382

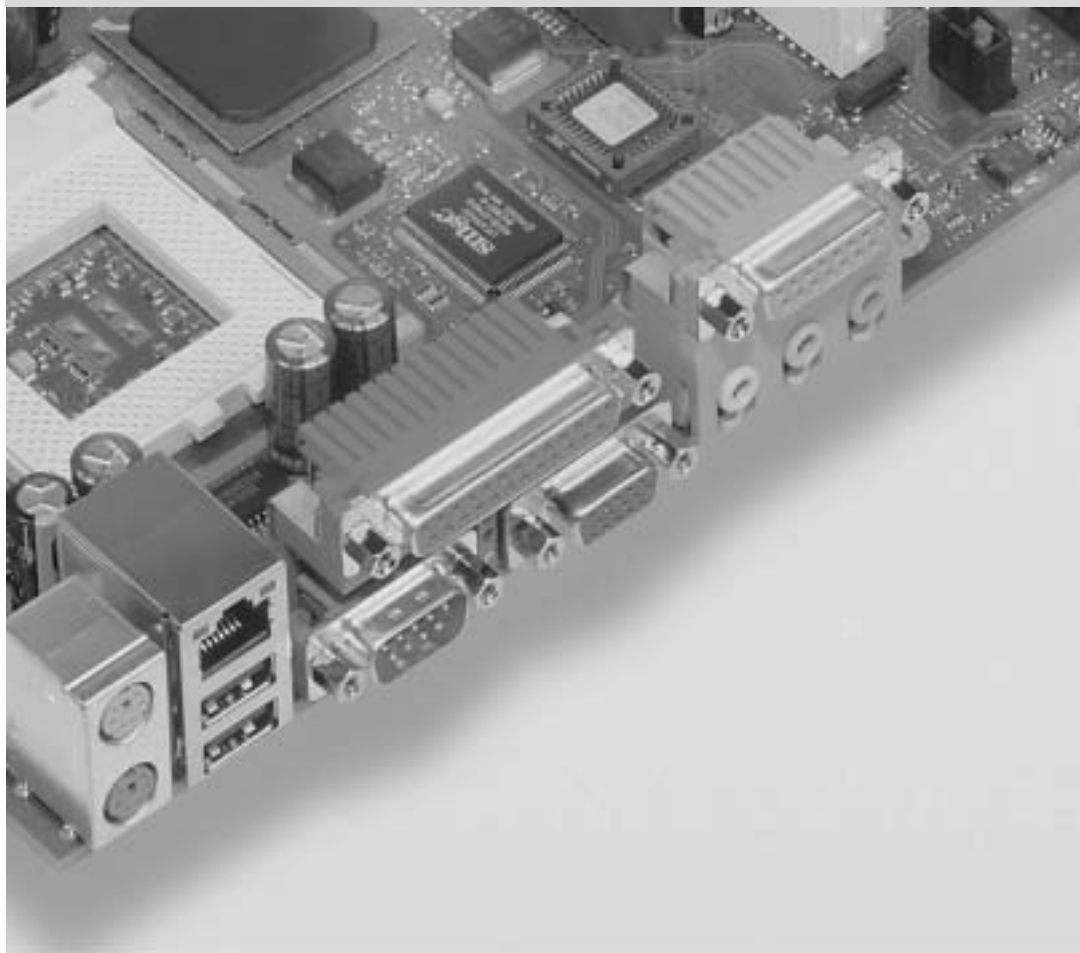

**FUJITSU** COMPUTERS  
**SIEMENS**

## Are there ...

... any technical problems or other questions which you would like to be clarified?

Please contact:

- your sales partner
- your sales outlet

Further information can be found in the "Safety and Ergonomics" manual.

The latest information on our products, tips, updates, etc., can be found on the internet under:

*<http://www.fujitsu-siemens.com>*

## Are there ...

... any technical problem or other question you need clarified?

Please contact:

- your sales partner
- your sales outlet

You will find further information in the manual "Safety and Ergonomics".

The latest information on our products, tips, updates, etc., can be found on the Internet under:

*<http://www.fujitsu-siemens.com>*



Dieses Handbuch wurde auf Recycling-Papier gedruckt.  
This manual has been printed on recycled paper.  
Ce manuel est imprimé sur du papier recyclé.  
Este manual ha sido impreso sobre papel reciclado.  
Questo manuale è stato stampato su carta da riciclaggio.  
Denna handbok är tryckt på recyclingpapper.  
Dit handboek werd op recycling-papier gedrukt.

Herausgegeben von/Published by  
Fujitsu Siemens Computers GmbH

Bestell-Nr./Order No.: **A26361-D1382-Z120-1-7419**  
Printed in the Federal Republic of Germany  
AG 0402 04/02



**A26361-D1382-Z120-1-7419**

German

English

**Systembaugruppe  
D1387  
System Board D1387**

**Technisches Handbuch  
Technical Manual**

**Ausgabe April 2002  
April 2002 edition**

Pentium and Celeron are registered trademarks of Intel Corporation, USA.

Microsoft, MS, MS-DOS and Windows are registered trademarks of Microsoft Corporation.

PS/2 and OS/2 Warp are registered trademarks of International Business Machines, Inc.

All other trademarks referenced are trademarks or registered trademarks of their respective owners, whose protected rights are acknowledged.

Copyright © Fujitsu Siemens Computers GmbH 2002

All rights, including rights of translation, reproduction by printing, copying or similar methods, in part or in whole, are reserved.

Offenders will be liable for damages.

All rights, including rights created by patent grant or registration of a utility model or design, are reserved.

Delivery subject to availability. Right of technical modification reserved.

This manual was produced by  
cognitas. Gesellschaft für Technik-Dokumentation mbH  
[www.cognitas.de](http://www.cognitas.de)

Intel, Pentium and Celeron are registered trademarks of Intel Corporation, USA.

Microsoft, MS, MS-DOS and Windows are registered trademarks of Microsoft Corporation.

PS/2 and OS/2 Warp are registered trademarks of International Business Machines, Inc.

All other trademarks referenced are trademarks or registered trademarks of their respective owners, whose protected rights are acknowledged.

All rights, including rights of translation, reproduction by printing, copying or similar methods, even of parts are reserved.

Offenders will be liable for damages.

All rights, including rights created by patent grant or registration of a utility model or design, are reserved. Delivery subject to availability.

Right of technical modification reserved.

This manual was produced by  
cognitas. Gesellschaft für Technik-Dokumentation mbH  
[www.cognitas.de](http://www.cognitas.de)

---

# Contents

Introduction.....	1
Notational conventions .....	1
Important notes.....	1
Information about boards .....	2
Features .....	3
External ports .....	4
Internal ports and connectors .....	5
Temperature / System monitoring.....	6
Hard disk connection .....	7
LAN connector.....	7
Screen resolution.....	8
PCI bus interrupts.....	8
Settings with switches and jumpers .....	9
Recovering System BIOS - switch 2 .....	9
Add-on modules .....	10
Installing and removing processors.....	11
Upgrading main memory.....	12
Replacing the lithium battery.....	13
Glossary .....	14





---

## Introduction



Depending on the configuration chosen, some of the hardware components described may not be available on your system board.

You will find further information in the "BIOS Setup" description.

Further information about drivers is provided in the readme files on the hard disk, on the supplied drivers diskettes, on the "Drivers & Utilities" or on the "ServerStart" CD.

## Notational conventions

The meanings of the symbols and fonts used in this manual are as follows:



Pay particular attention to text marked with this symbol. Failure to observe this warning endangers your life, destroys the device, or may lead to loss of data.



Supplementary information, remarks, and tips follow this symbol.

- ▶ Text which follows this symbol describes activities that must be performed in the order shown.
- ┆ This symbol indicates that you must enter a blank space (press the Space Bar) at this point.
- ↵ This symbol indicates that you must press the Enter key.

*Text in this typeface* indicates screen outputs.

**Text in this bold typeface** indicates the entries you make via the keyboard.

*Text in italics* indicates commands or menu items.

"Quotation marks" indicate names of chapters or terms.

## Important notes

Store this manual close to the device. If you pass the device on to third parties, you should pass this manual on with it.



Be sure to read this page carefully and note the information before you open the device.

You cannot access the system board components without first opening the device. How to dismantle and reassemble the device is described in the Operating Manual accompanying the device.

Please observe the safety information provided in the "Important notes" chapter in the device's operating manual.

Incorrect replacement of the lithium battery may lead to a risk of explosion. It is therefore essential to observe the instructions in the "Add-on modules" - "Replacing the lithium battery" section.



The shipped version of this board complies with the requirements of the EEC directive 89/336/EEC "Electromagnetic compatibility".

Compliance was tested in a typical PC configuration.

When installing the board, refer to the specific installation information in the Operating Manual or Technical Manual for the receiving device.

Connecting cables for peripherals must be adequately shielded to avoid interference.



Components can become very hot during operation. Ensure you do not touch components when making extensions to the system board. There is a danger of burns!



The warranty is invalidated if the device is damaged during the installation or replacement of system expansions. Information on which system expansions you can use is available from your sales outlet or the customer service centre.

## Information about boards

To prevent damage to the system board or the components and conductors on it, please take great care when you insert or remove boards. Take great care to ensure that extension boards are slotted in straight, without damaging components or conductors on the system board, or any other components, for example EMI spring contacts.

Be especially careful with the locking mechanisms (catches, centring pins etc.) when you replace the system board or components on it, for example memory modules or processors.

Never use sharp objects (screwdrivers) for leverage.



Boards with electrostatic sensitive devices (ESD) are identifiable by the label shown.

When you handle boards fitted with ESDs, you must, under all circumstances, observe the following points:

- You must always discharge static build up (e.g. by touching a grounded object) before working.
- The equipment and tools you use must be free of static charges.
- Remove the power plug from the mains supply before inserting or removing boards containing ESDs.
- Always hold boards with ESDs by their edges.
- Never touch pins or conductors on boards fitted with ESDs.

## Features

The components and connectors marked are not necessarily present on the system board.

- System board in  $\mu$ ATX format
- Intel processor Pentium 4 from 1.4 GHz and with 400 /533 MHz Front Side Bus.

Pentium 4 processors support MMX technology and Intel Streaming SIMD Extensions. The size and frequency of first-level cache and second-level cache are dependent upon the processor used.

- Intel chipset 845G
- Intel 82562 LAN controller (10/100 Mbit/s) with RJ45 interface  
WOL with Magic Packet™ is supported, as is booting from LAN with InCom LAN BootP or Intel PXE.
- VGA: 24 bit and 350 MHz RAMDAC; Dynamic Video Memory (DVM)
- Analogue Devices AD1981A (AC'97) Audio Codec  
internal: Stereo CD-In, Audio front panel  
external: Mono Micro-In, Stereo Line-In, Stereo Line-Out
- 2 DIMM slots for 128 MB up to 2 GB main memory (DDR-DIMM memory modules meet the PC2100 specification) without ECC
- Fujitsu Siemens Computers Systemüberwachung und Temperaturüberwachung
- Flash BIOS
- Power-on functions:
  - Wake on RTC
  - Wake on LAN
  - Wake on PCI Cards
  - Wake on USB
  - COM1 wake up support (standby)
- Energy saving functions:
  - APM and ACPI (requires an operating system that supports ACPI)
  - Switching on/off, standby mode, suspend mode via on/off switch
  - Switching on/off via software
- Security functions:
  - Processor serial number
  - Cover monitoring: cover monitoring reports when the cover has been opened without authorisation.
  - System, Setup and Keyboard password
  - parallel and serial ports can be deactivated
  - Floppy disk write-protection via *BIOS Setup*
  - Boot hard disk virus warning function
  - Flash BIOS and EEPROMs (on the memory modules) virus protection function.
- 3 PCI slots  
PCI slots support 3.3 V main and auxiliary voltages.

- 1 AGP slot  
The AGP slot supports 4x AGP mode. Only AGP boards with 1.5 V are supported.
- IDE hard disk controller connected to PCI bus for up to four IDE drives (e.g. IDE hard disk drives, ATAPI CD-ROM drives)  
The IDE hard disk controller are ATA100, ultra DMA capable and support PIO modes 0-4.
- Floppy disk drive controller (possible formats: 720 KB, 1.44 MB, 2.88 MB)
- The system board supports booting from a 120 MB IDE floppy disk drive.
- Real-time clock/calendar with integrated battery backup
- 4 internal USB ports (C / D and E / F)
- 1 internal serial port for chipcard reader (SmartCard reader).
- 1 external parallel port (ECP- and EPP-compatible)
- 1 external serial port (16C550 compatible with FIFO)
- 2 external PS/2 ports for keyboard and mouse
- 2 external USB ports (A / B)

## External ports

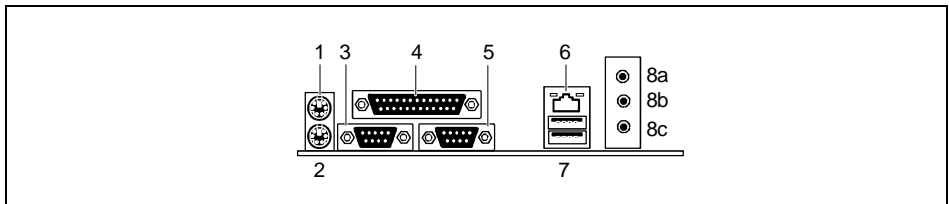

- 1 = PS/2 mouse port
- 2 = PS/2 keyboard port
- 3 = Serial port
- 4 = Parallel port
- 5 = VGA
- 6 = LAN connector

- 7 = USB ports A and B
- 8a = Audio Line-Out  
Headphones
- 8b = Audio Line-In
- 8c = Audio Micro-In

The components and connectors marked are not necessarily present on the system board.

## Internal ports and connectors

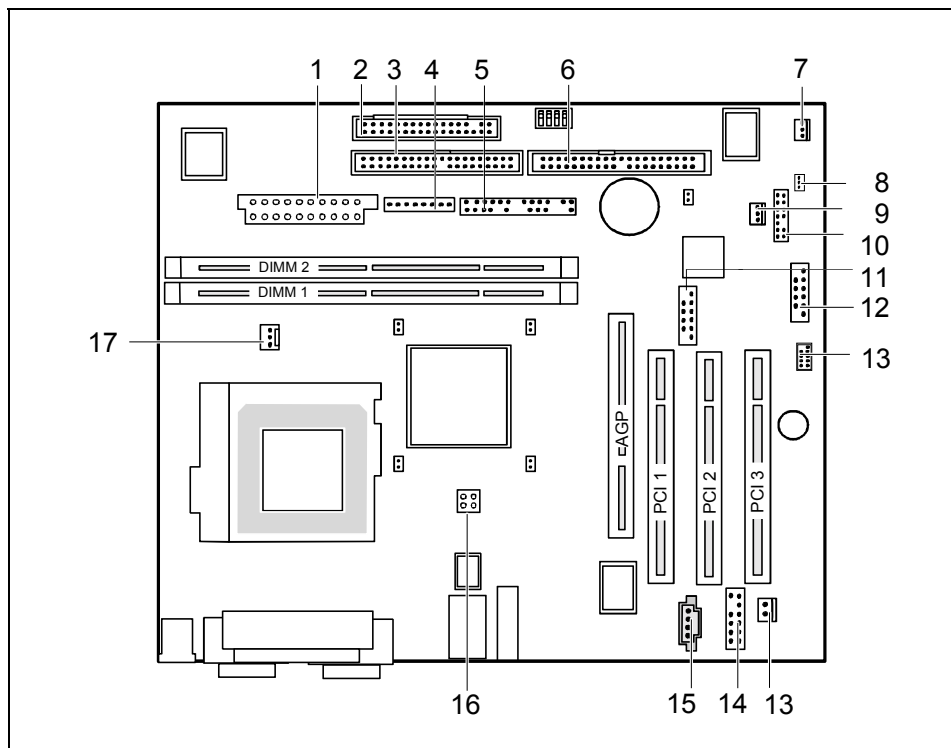

- |                                    |                                     |
|------------------------------------|-------------------------------------|
| 1 = Power supply ATX               | 10 = LCD display                    |
| 2 = Floppy Disk Drive              | 11 = USB ports C / D                |
| 3 = IDE drives 3 and 4 (secondary) | 12 = USB ports E / F                |
| 4 = Power supply monitoring        | 13 = COM2                           |
| 5 = Connector for front panel      | 14 = SP/DIF (digital Audio)         |
| 6 = IDE drives 1 and 2 (primary)   | 15 = Audio front panel              |
| 7 = Fan 2                          | 16 = CD audio input                 |
| 8 = OEM LED                        | 17 = Power supply                   |
| 9 = Cover monitoring               | 18 = Fan 1 (e.g. for the processor) |

The components and connectors marked are not necessarily present on the system board.

## Temperature / System monitoring

Temperature and system monitoring aim to reliably protect the computer hardware against damage caused by overheating. In addition, any unnecessary noise is also prevented by reducing the fan speed, and information is provided about the system status. Cover monitoring protects the system from unauthorised opening.

An onboard controller developed by Fujitsu Siemens Computers controls the temperature and system monitoring.

The following functions are supported:

### **Temperature monitoring:**

Measurement of the processor and the system temperature with an onboard temperature sensor.

### **Temperature control:**

The temperature is controlled by adjusting the fan speed and/or by reducing the clock frequency of the processor. The clock frequency of the processor is dependent upon the setting in the *BIOS Setup*. Temperature-dependent processor speed control enables a reduced fan speed, decreasing noise.

### **Fan monitoring:**

Fans which have been removed, blocked or sticky fans are detected. Blocked or sticky fans are operated with 12 V pulse voltage. If the device has a monitored fan removed while the system is switched off this is indicated by the message LED when the system is switched on again and processed by the BIOS or the application.

### **Fan control:**

With the exception of the auxiliary fan (AUX), the fans are regulated according to temperature.

### **Sensor monitoring:**

The removal of, or a fault in, a temperature sensor is detected. Should this happen all fans monitored by this sensor run at maximum speed, to achieve the greatest possible protection of the hardware. If the device has a monitored fan removed while the system is switched off this is indicated by the message LED when the system is switched on again and processed by the BIOS or the application.

### **Cover monitoring:**

Unauthorised opening of the cover is detected, even when the system is switched off. However, this will only be indicated when the system is switched on again.

**Voltage monitoring:**

The voltages 12 V, 5 V and the CMOS battery are monitored.

With hardware monitoring - regardless of the operating system and processor - the advantages compared to conventional software monitoring are clear:

- suitable for all operating systems and processor types
- no additional load on processor (performance)
- optimum temperature protection, even if process faults or faults are present in the operating system
- optimum noise reduction

Three different operating modes are available and can be configured in *BIOS Setup - System Management*.

**Hard disk connection**

An ultra ATA/66 or ultra ATA/100 hard disk must be connected with a cable especially designed for the ultra ATA/66or ultra ATA/100 mode.

- ▶ Connect the end of the cable marked with blue to the system board.

**LAN connector**

This system board has an optional Intel 82550EM LAN controller which supports transfer speeds of 10 Mbit/s and 100 Mbit/s. The LAN controller is equipped with a 3 KB transmission and receiving buffer (FIFO) and supports WOL function through Magic Packet™.

It is also possible to boot a device without its own boot hard disk via LAN. Here Bootix LAN BootP and Intel PXE are supported.

Basic AOL II is also supported. Basic AOL II helps to protect systems against theft or damage. Basic AOL II can also inform the administrator about hardware faults and software errors.

The LAN RJ45 connector is equipped with a yellow and a green LED (light emitting diode).

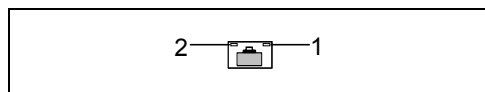

1 = a connection exists (e.g. to a hub).

2 = Link Mode: the LAN connection is active.  
WOL mode: a Magic Packet™ is being received.

## Screen resolution

Depending on the operating system used, the screen resolutions in the following table refer to the system board screen controller.

If you are using an external screen controller, you will find details of supported screen resolutions in the Operating Manual or Technical Manual supplied with the controller.

Screen resolution	Refresh rate (Hz)	bpp	Colour
1024 x 768	120	32	16 bit
1280 x 1024	100	32	16 bit
1600 x 1200	85	32	16 bit

## PCI bus interrupts

The following table shows which PCI bus interrupts are assigned on the system board.

PCI bus interrupt	Component on system board:
B, C, D, A	PCI bus slot 1
C, D, A, B	PCI bus slot 2
D, A, B, C	PCI bus slot 3
E, F, G, H	PCI bus slot 4
F, G, H, A	PCI bus slot 5
G, H, A, B	PCI bus slot 6
A, B	AGP slot
D	First USB controller
H	Second USB controller
E	LAN controller
B	SMBus
B	AC'97 Audio



## Settings with switches and jumpers

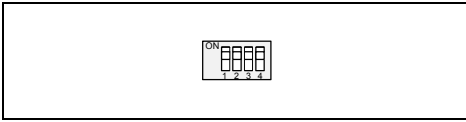

Switch 1 = must always be set to *off*  
Switch 2 = System BIOS recovery  
Switch 3 = must always be set to *off*  
Switch 4 = must always be set to *off*



The clock frequency of the processor is set automatically.

### Recovering System BIOS - switch 2

Switch 2 enables recovery of the old system BIOS after an attempt to update has failed. To restore the old system BIOS you need a Flash BIOS Diskette (please call our customer service centre).

- On*                The System BIOS executes from floppy drive A: and the inserted "Flash-BIOS-Diskette" restores the System BIOS on the system board.
- Off*                Normal operation (default setting).

## Add-on modules



Exit Suspend mode, switch off the device and remove the power plug from the mains supply, before carrying out any of the procedures described in this chapter! Even when you have switched off the device, parts (e.g. memory modules, AGP and PCI extension boards) are still supplied with power. All PCI slots support 3.3 V main and auxiliary voltages. AGP boards support 1,5 V main and auxiliary voltages.

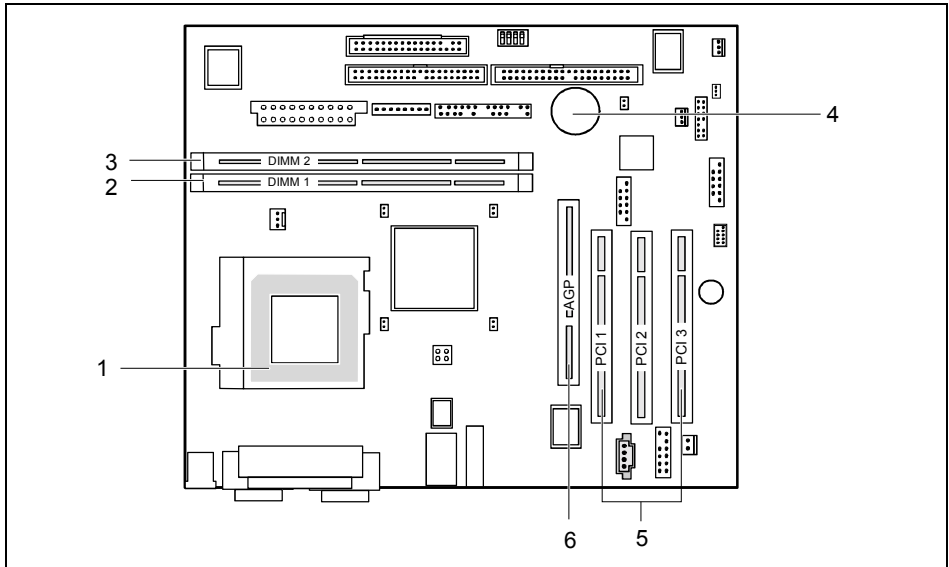

1 = Socket for processor with heat sink  
 2 = Location bank 1 for main memory  
 3 = Location bank 2 for main memory

4 = Lithium battery  
 5 = PCI slots 1, 2, 3  
 6 = AGP slot

## Installing and removing processors

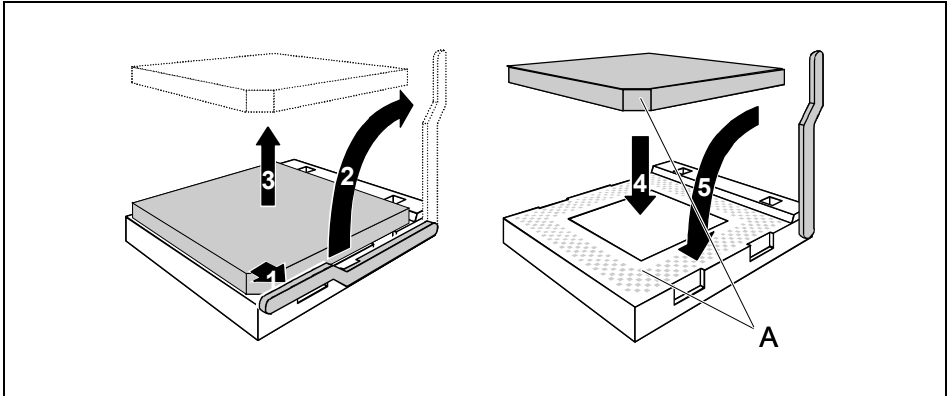

- ▶ Pull the lever in the direction of the arrow (1) and lift it as far as it will go (2).
- ▶ Remove the old processor from the socket (3).
- ▶ Insert the new processor in the socket so that the angled corner of the processor matches the coding on the socket (A) with regard to the position (4).



The angled corner of the processor may be covered by the heat sink. In this case let yourself be guided by the marking in the rows of pins on the underside of the processor.

- ▶ Push the lever back down until it clicks into place (5).

## Upgrading main memory

These slots are suitable for 128, 256, 512 and 1024 Mbyte DDR memory modules of the DIMM format.

Memory modules with different memory capacities can be combined.



You may only use unbuffered 2,5 V memory modules. Buffered memory modules are not supported.

DDR-DIMM memory modules must meet the PC2100 specification.

### Installing a memory module

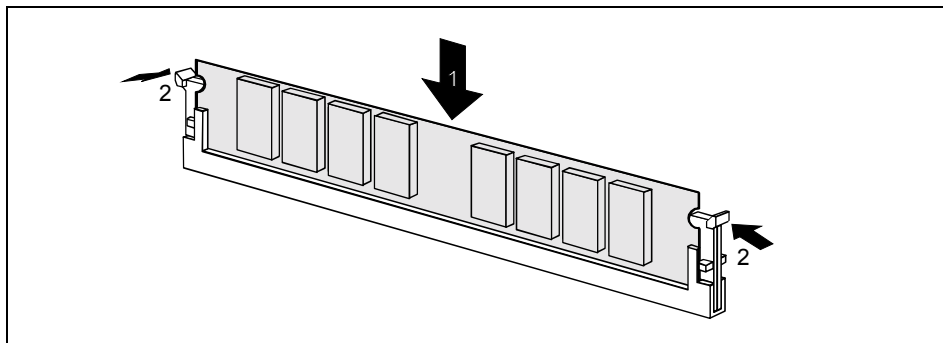

- ▶ Push the holders on each side of the memory compartment outwards.
- ▶ Insert the memory module into the location (1).
- ▶ At the same time flip the lateral holders upwards until the memory module snaps in place (2).

### Removing a memory module

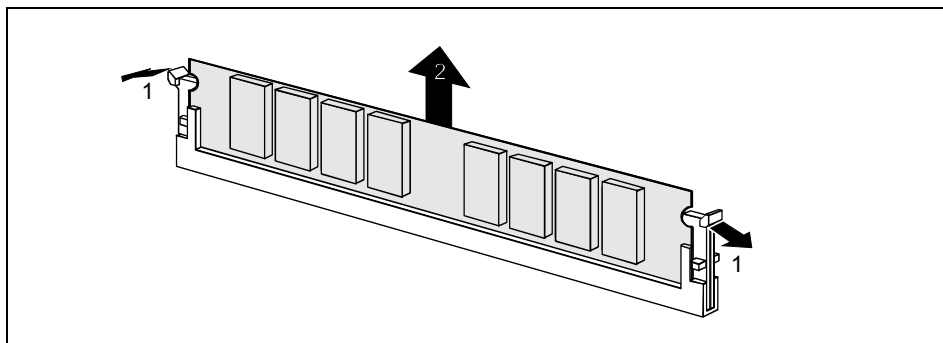

- ▶ Push the clips on the right and left of the compartment outward (1).
- ▶ Carefully remove the memory module from the compartment (2).

## Replacing the lithium battery



Incorrect replacement of the lithium battery may lead to a risk of explosion.

The lithium battery must be replaced with an identical battery or a battery type recommended by the manufacturer (CR2032).

Do not throw lithium batteries into the household waste. They must be disposed of in accordance with local regulations concerning special waste.

Ensure that you insert the battery the right way round. The plus pole must be on the top!

The following graphic representation is also valid if the lithium battery is built-in vertically.

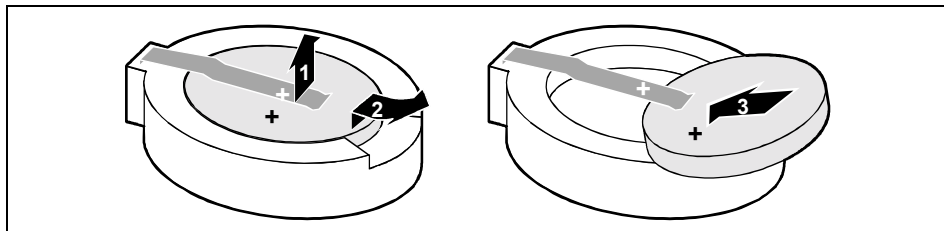

- ▶ Lift the contact (1) a few millimetres and remove the battery from its socket (2).
- ▶ Insert a new lithium battery of the same type into the socket (3).

## Glossary

The technical terms and abbreviations given below represent only a selection of the full list of common technical terms and abbreviations.

Not all technical terms and abbreviations listed here are valid for the described system board.

ACPI	Advanced Configuration and Power Management Interface
AC'97	Audio Codec '97
AGP	Accelerated Graphics Port
AMR	Audio Modem Riser
AOL	Alert On LAN
APM	Advanced Power Management
ATA	Advanced Technology Attachment
BIOS	Basic Input Output System
CAN	Controller Area Network
CPU	Central Processing Unit
CNR	Communication Network Riser
C-RIMM	Continuity Rambus Inline Memory Module
DIMM	Dual Inline Memory Module
ECC	Error Correcting Code
EEPROM	Electrical Erasable Programmable Read Only Memory
FDC	Floppy Disk Controller
FIFO	First-In First-Out
FSB	Front Side Bus
FWH	Firmware Hub
GMCH	Graphics and Memory Controller Hub
GPA	Graphics Performance Accelerator
I <sup>2</sup> C	Inter Integrated Circuit
IAPC	Instantly Available Power Managed Desktop PC Design
ICH	I/O Controller Hub
IDE	Intelligent Drive Electronics
IPSEC	Internet Protocol Security

ISA	Industrial Standard Architecture
LAN	Local Area Network
LSA	LAN Desk Service Agent
MCH	Memory Controller Hub
MMX	MultiMedia eXtension
P64H	PCI64 Hub
PCI	Peripheral Component Interconnect
PXE	Preboot eXecution Environment
RAM	Random Access Memory
RAMDAC	Random Access Memory Digital Analogue Converter
RDRAM	Rambus Dynamic Random Access Memory
RIMM	Rambus Inline Memory Module
RTC	Real Time Clock
SB	Soundblaster
SDRAM	Synchronous Dynamic Random Access Memory
SGRAM	Synchronous Graphic Random Access Memory
SIMD	Streaming Mode Instruction (Single Instruction Multiple Data)
SMBus	System Management Bus
SVGA	Super Video Graphic Adapter
USB	Universal Serial Bus
VGA	Video Graphic Adapter
WOL	Wake On LAN

## Free Manuals Download Website

<http://myh66.com>

<http://usermanuals.us>

<http://www.somanuals.com>

<http://www.4manuals.cc>

<http://www.manual-lib.com>

<http://www.404manual.com>

<http://www.luxmanual.com>

<http://aubethermostatmanual.com>

Golf course search by state

<http://golfingnear.com>

Email search by domain

<http://emailbydomain.com>

Auto manuals search

<http://auto.somanuals.com>

TV manuals search

<http://tv.somanuals.com>