

Statement:

This manual is the intellectual property of Foxconn, Inc. Although the information in this manual may be changed or modified at any time, Foxconn does not obligate itself to inform the user of these changes.



Trademark:

All trademarks are the property of their respective owners.
Intel® and Pentium® are registered trademarks of Intel Corporation.
PS/2 and OS/2 is the registered trademarks of IBM, Inc.
Windows® 95/98/2000/NT/XP is the registered trademark of Microsoft.
Award® is the registered trademark of Award, Inc.

Version:

User's Manual V1.0 in English for 661M03 series motherboard.
P/N:91-181-613-11-43

Symbol description:

-  **Note:** refers to important information that can help you to use motherboard better.
-  **Attention:** indicates that it may damage hardware or cause data loss, and tells you how to avoid such problems.
-  **Warning:** means that a potential risk of property damage or physical injury exists.

More information:

If you want more information about our products, please visit Foxconn's website: www.foxconnchannel.com



Item Checklist:

Thank for your purchasing Foxconn's 661M03 series motherboard. Please check the package; if there are missing or damaged items, contact your distributor as soon as possible.

- ❖ 661M03 series motherboard (x1)
- ❖ Foxconn Utility CD (x1)
- ❖ User's Manual (x1)
- ❖ IDE Ribbon cable (x1)
- ❖ FDD Ribbon cable (x1)
- ❖ I/O Shield (x1)
- ❖ SPDIF Cable (x1) (optional)
- ❖ USB 2.0 Cable (x1) (optional)



Declaration of conformity



HON HAI PRECISION INDUSTRY COMPANY LTD
66 , CHUNG SHAN RD., TU-CHENG INDUSTRIAL DISTRICT,
TAIPEI HSIEN, TAIWAN, R.O.C.

declares that the product

Motherboard
661M03 series

is in conformity with

(reference to the specification under which conformity is declared in
accordance with 89/336 EEC-EMC Directive)

- EN 55022/A1: 2000 Limits and methods of measurements of radio disturbance characteristics of information technology equipment
- EN 61000-3-2/A14:2000 Electromagnetic compatibility (EMC)
Part 3: Limits
Section 2: Limits for harmonic current emissions
(equipment input current \leq 16A per phase)
- EN 61000-3-3/A1:2001 Electromagnetic compatibility (EMC)
Part 3: Limits
Section 2: Limits of voltage fluctuations and flicker in low-voltage supply systems for equipment with rated current \leq 16A
- EN 55024/A1:2001 Information technology equipment-Immunity characteristics limits and methods of measurement

Signature :

Place / Date : TAIPEI/2003

Printed Name : James Liang

Position/ Title : Assistant President

Declaration of conformity



Trade Name: Foxconn
Model Name: **661M03**
Responsible Party: PCE Industry Inc.
Address: 458 E. Lambert Rd.
Fullerton, CA92835
Telephone: 714-738-8868
Facsimile: 714-738-8838

Equipment Classification: FCC Class B Subassembly
Type of Product: Motherboard
**Manufacturer: HON HAI PRECISION INDUSTRY
COMPANY LTD**
Address: 66 , CHUNG SHAN RD., TU-CHENG
INDUSTRIAL DISTRICT, TAIPEI HSIEN,
TAIWAN, R.O.C.

Supplementary Information:

This device complies with Part 15 of the FCC Rules. Operation is subject to the following two conditions : (1) this device may not cause harmful interference, and (2) this device must accept any interference received, including interference that may cause undesired operation.

Tested to comply with FCC standards.

Signature :

A handwritten signature in black ink that reads "James Liang".

Date : 2003

Table of Contents

Chapter 1 Product Introduction

Main Features	2
Motherboard Layout	5

Chapter 2 Installation Instructions

CPU	10
Memory	14
Power Supply	17
Rear Panel Connectors	18
Other Connectors	20
Expansion Slots	26
Jumpers	29

Chapter 3 BIOS Description

Enter BIOS Setup	33
Main menu	33
Standard CMOS Features	35
BIOS Features	38
Advanced BIOS Features	39
Advanced Chipset Features	43
Integrated Peripherals	47
Power Management Setup	51
PnP/PCI Configurations	55
PC Health Status	56
Frequency/Voltage Control	57
Load Fail-Safe Defaults	58
Load Optimized Defaults	58
Set Password	58
Save & Exit Setup	59
Exit Without Saving	59

Table of Contents

Chapter 4	Driver CD Introduction	
Utility CD content		61
Start to install drivers		62
Install IDE Driver		62
Install AGP Driver		63
Install VGA Driver		63
Install DirectX		64
Install USB 2.0 Driver		65
Using 4-/6-Channel Audio		65
Install LAN Driver		71
Install Norton Internet Security 2004		72
Chapter 5	Directions for Bundled Software	
SuperStep		74
SuperLogo		77
SuperUpdate		79
Chapter 6	Special BIOS Functions	
SuperSpeed		85
SuperBoot		86
SuperBIOS-Protect		87
SuperRecovery		88

 **Warning:**

1. Attach the CPU and heatsink using silica gel to ensure full contact.
2. It is suggested to select high-quality, certified fans in order to avoid damage to the motherboard and CPU due to high temperatures.
3. Never turn on the machine if the CPU fan is not properly installed.
4. Ensure that the DC power supply is turned off before inserting or removing expansion cards or other peripherals, especially when you insert or remove a memory module. Failure to switch off the DC power supply may result in serious damage to your system or memory module.

 **Warning:**

We cannot guarantee that your system will operate normally while over-clocked. Normal operation depends on the over-clock capacity of your device.

 **Attention:**

Since BIOS programs are upgraded from time to time, the BIOS description in this manual is just for reference. We do not guarantee that the content of this manual will remain consistent with the actual BIOS version at any given time in the future.

 **Attention:**

The pictures of objects used in this manual are just for your reference. Please refer to the physical motherboard.



Chapter 1

Thank you for your buying Foxconn's 661M03 series motherboard. This series of motherboard is one of our new products and offers superior performance, reliability and quality, at a reasonable price. This motherboard adopts the advanced SiS 661FX+ 963/963L chipset, providing users a computer platform with a high integration-compatibility-performance price ratio.

This chapter includes the following information:

- ❖ Main Features
- ❖ Motherboard Layout

Main Features

Size

- mATX form factor of 9.6"x 8.5"

Microprocessor

- Supports Intel® Pentium®4 socket 478 (Willamette/Northwood/Prescott) processors
- Supports Intel® Celeron® socket 478 (Willamette/Northwood) processors
- Supports FSB at 400MHz/533MHz/800MHz
- Support Hyper-Threading technology

Chipset

- SiS chipset: 661FX (North Bridge) + 963/963L (South Bridge)

System Memory

- Two 184-pin DIMM slots
- Supports PC 3200/PC 2700/PC 2100 memory
- Supports 128/256/512 Mb technology up to 2GB

Onboard IDE

- Supports up to 4 independent drives
- Supports Ultra DMA 133/100/66
- Two fast IDE interfaces supporting four IDE devices, including IDE hard disk and CD-ROM/DVD-ROM drives

Onboard FDD

- One FDD interface
- Supports two 3.5" or 5.25" FDDs with 360K/720K/1.2M/1.44M/2.88M format

USB 2.0 Ports:

- Supports hot plug
- Six USB 2.0 ports (four rear panel ports, one onboard USB headers providing two extra ports)
- Supports wake-up from S1 and S3 mode
- Supports USB 2.0 Protocol up to 480 Mbps transmission rate

Onboard 1394 (optional)  IEEE 1394

- Supports hot plug
- With rate of transmission up to 400Mbps
- Self-configured addressing
- Can connect with 2 independent 1394 units synchronously at most, such as HDD, CD-ROM

Onboard LAN 

- Supports 10/100Mbit/sec Ethernet
- LAN interface built-in on board

Onboard I/O

- Two high-speed 16550 compatible UARTs (COM1/COM2) with 16 byte send/receive FIFO
- One infrared interface (optional)
- One parallel port supporting SPP/EPP/ECP mode

Onboard Graphics  AGP 8X

- Supports integrated VGA display functions
- Supports external AGP3.0 specification; supports 8X/4X display cards

Onboard Audio  channel

- AC' 97 2.3 Specification Compliant
- Supports S/PDIF output
- Onboard Line-in jack, Microphone jack, Line-out jack
- Supports 5.1 channels audio (setting via software)

Expansion Slots

- Three PCI slots
- One AGP slot
- One CNR slot (optional)

BIOS

- Licensed advanced AWARD (Phoenix) BIOS, supports flash ROM, plug-and-play ready
- Supports IDE, CD-ROM, SCSI HDD or USB device boot up

Green Function

- Supports ACPI (Advanced Configuration and Power Interface)
- Supports five system modes—S0 (normal), S1 (power on suspend), S3 (suspend to RAM), S4 (suspend to disk – depends on OS) and S5 (soft-off)

Advanced Features

- PCI 2.2 Specification Compliant
- Supports Windows 98/2000/ME/XP soft-off
- Supports Wake-on-LAN
- Supports PC Health function (capable of monitoring system voltage, CPU temperature, system temperature and fan speed)

Motherboard Layout

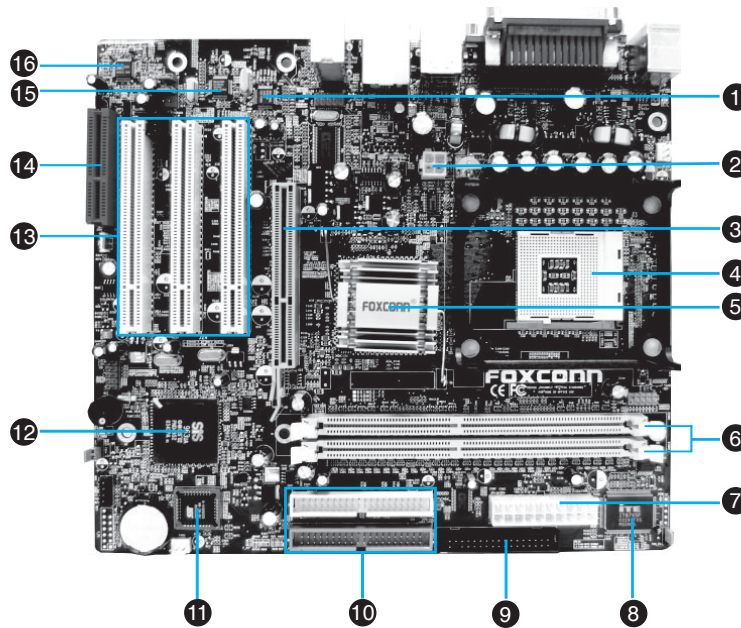

Note:

The above motherboard layout is provided for reference only; please refer to the physical motherboard.

1 1394 PHY (optional)

The RTL8801B is IEEE 1394a 100/200/400 Mbps 2-Port Cable Transceiver/Arbiter (PHY) Chip. Provides two fully compliant cable ports at 100/200/400 Mbps.

2 ATX 12V connector

This power connector connects the 4-pin 12V plug from the ATX 12V power supply.

3 AGP slot

This Accelerated Graphics Port (AGP) slot supports 1.5V AGP 8X/4X mode graphics cards for 3D graphical applications.

4 CPU socket

A 478-pin surface mount, Zero Insertion Force (ZIF) Socket for the Intel® Pentium® 4 processor, with 800/533/400MHz system bus that allows 6.4GB/s/4.2GB/s and 3.2GB/s data transfer rates, respectively.

5 North Bridge controller

The SiS 661FX controller integrates a high performance host interface for the Intel® Pentium® 4 processor, a DDR memory controller, a high performance graphics engine (integrated graphics), and SiS MuTIOL technology.

6 DDR DIMM sockets

These two 184-pin DIMM sockets support up to 2GB system memory using unbuffered non-ECC PC 3200/PC 2700/PC 2100 DDR DIMMs.

7 ATX power connector

This 20-pin connector connects to an ATX power supply. The power supply must have at least 1A on the +5V standby lead (+5VSB).

8 Super I/O controller

The Low Pin Count (LPC) interface provides the commonly used Super I/O functionality. The chipset supports a high-performance floppy disk controller for a 360K/720K/1.44M/2.88M floppy disk drive, a multi-mode parallel port, two serial ports and a Flash ROM interface.

9 Floppy disk connector

This connector accommodates the provided ribbon cable for the floppy disk drive. One side of the connector is slotted to prevent incorrect insertion of the floppy disk cable.

10 IDE connectors

These dual-channel bus master IDE connectors support Ultra DMA 133/100/66/33 devices. Both the primary (blue) and secondary (white) connectors are slotted to prevent incorrect insertion of the IDE ribbon cable.

11 Flash Rom

This 4Mb firmware contains the programmable BIOS program.

12 South Bridge controller

Referred to as the SiS 963/SiS 963L MuTIOL Media I/O, this controller integrates the audio controller with AC'97 interface, Ethernet MAC, Universal Serial Bus Host controller, IDE Master/Slave controllers and the MuTIOL Connect to PCI Bridge.

13 PCI Slots

These three 32-bit PCI 2.2 expansion slots support bus master PCI cards like SCSI or LAN cards with 133MB/s maximum throughput.

14 CNR Slot (optional)

This slot is specifically designed for the Communication and Networking Riser (CNR) card. The CNR supports V.90 analog modem, 2-channel audio, etc.

15 LAN PHY

The SiS 963L/963 integrated 10/100Mbps Fast Ethernet with Realtek external PHY supports your local area networking needs.

16 Audio CODEC (optional)

The ALC655 is an AC'97 CODEC that allows 6-channel audio playback. The audio CODEC provides six DAC channel for 5.1 surround sound, S/PDIF output and Line-in stereo inputs, integrated headphone amplifier, greater than 90dB dynamic range with the jack sense and jack enumeration feature.

Chapter 2

This chapter introduces the hardware installation process, including the installation of the CPU and memory. It also addresses the connection of your power supply, use of the rear panel connectors, connection of hard drive and floppy drive data cables, and setting up various other feature of the motherboard. Caution should be exercised during the installation process. Please refer to the motherboard layout prior to any installation and read the contents in this chapter carefully.

This chapter includes the following information:

- ❖ CPU
- ❖ Memory
- ❖ Power Supply
- ❖ Rear Panel Connectors
- ❖ Other Connectors
- ❖ Expansion Slots
- ❖ Jumpers

 **Notes:**

Take note of the following precautions before you install components or change settings.

1. Use a grounded wrist strap or touch a safely grounded object, such as an attached power supply, before handling components to avoid damaging them due to static electricity.
2. Unplug the power cord before opening your chassis or touching any component.
3. Hold components by their edges to avoid touching any exposed integrated circuits (ICs).
4. Whenever you uninstall a component, place it on a grounded anti-static pad or into anti-static bag that it came in.

CPU

This motherboard accepts Intel socket 478 processors (CPUs) with a front side bus (FSB) of 400/533/800 MHz processors with Hyper-Threading technology are supported.

Warning :

The CPU pins must be properly aligned with the holes in the socket, otherwise the CPU may be damaged.

Installation of CPU

Follow these steps to install a CPU.

1. Unlock the socket by pressing the lever sideways, then lift it up to a 90° angle.

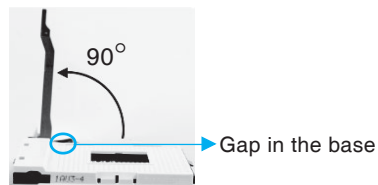

2. Align the cut edge to the gap in the base of the socket. Carefully insert the CPU into the socket until it fits in place.

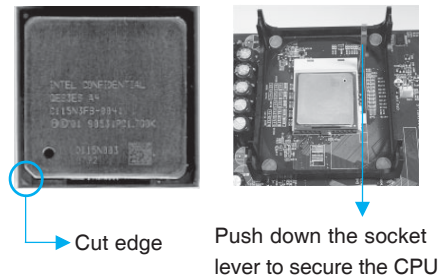

3. When the CPU is in place, press it firmly on the socket while you push down the socket lever to secure the CPU. The lever clicks on the side tab to indicate that it is locked.

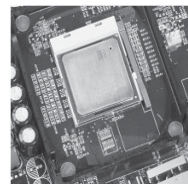

Installation of CPU Fan

New technology allows processors to run at higher and higher frequencies. To avoid problems arising from high-speed operation, for example, overheating, you need to install the proper fan. The following procedures are provided for reference only, please refer to your CPU fan user guide to install it.

1. Locate the CPU retention mechanism
2. If required, apply a light coating of silica gel to the top of the CPU. base (surrounds the CPU socket).

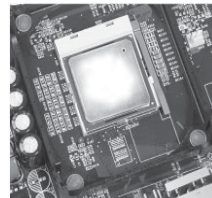
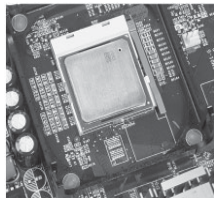

Note: The CPU heatsink may have a pre-applied thermal compound. In that case, the silica gel is not required.

3. Attach the fan to the base.
4. Connect the power fan's power cable to the appropriate 3-pin connector on the motherboard.

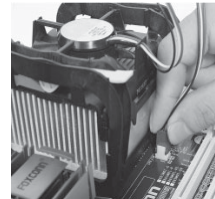
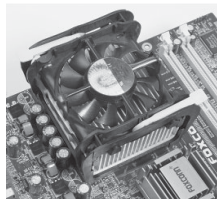

Warning :

Excessive temperatures will severely damage the CPU and system. Therefore, make sure that the cooling fan works normally at all times in order to prevent overheating and damaging to the CPU.

i Attention:

1. Position the fan with the retention mechanism on top of the heatsink. Align and snap the four hooks of the retention mechanism to the holes on each corner of the module base.
2. Make sure that the fan and retention mechanism assembly perfectly fits the heatsink and module base, otherwise you cannot snap the hooks into the holes.

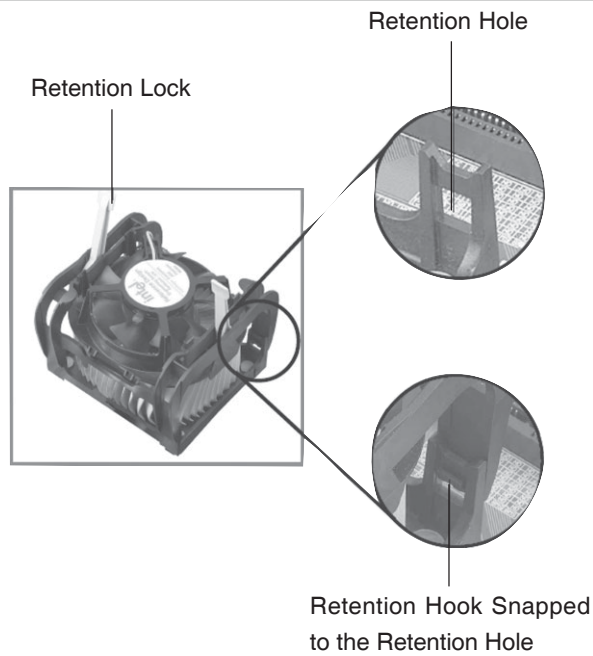

w Warning:

Keep the retention locks lifted upward while fitting the retention mechanism to the module base.

i Attention:

1. Push down the locks on the retention mechanism to secure the heatsink and fan to the module base.
2. When secured, the retention locks should point to opposite directions.

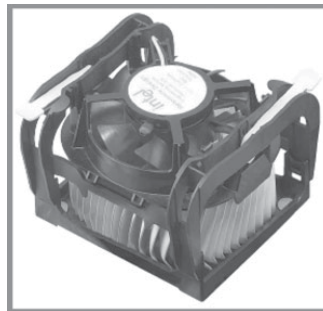

CPU Qualified Vendor List

The following table lists the CPU modules that have been tested and qualified for use with this motherboard.

Vendor	Type	FSB	Frequence
Intel	Pentium (Northwood)	400 MHz	2.0GHz, 2.5GHz
Intel	Pentium (Northwood)	533 MHz	2.4GHz, 2.66GHz, 2.8GHz, 3.06GHz
Intel	Pentium (Northwood)	800 MHz	2.4GHz, 2.6GHz, 3.0GHz
Intel	Pentium (Prescott)	800 MHz	2.8GHz
Intel	Celeron (Northwood)	400 MHz	2.0GHz, 2.1GHz, 2.4GHz
Intel	Willamette	400 MHz	1.8GHz

Memory

This motherboard includes two, 184-pin, dual in-line memory module (DIMM) sockets. You can install corresponding PC 3200 (DDR400), PC 2700 (DDR333), or PC 2100 (DDR266) memory modules. You must install at least one memory module to ensure normal operation. If you install two modules, they must be the same speed. Mixing memory modules from different manufacturers is not recommended.

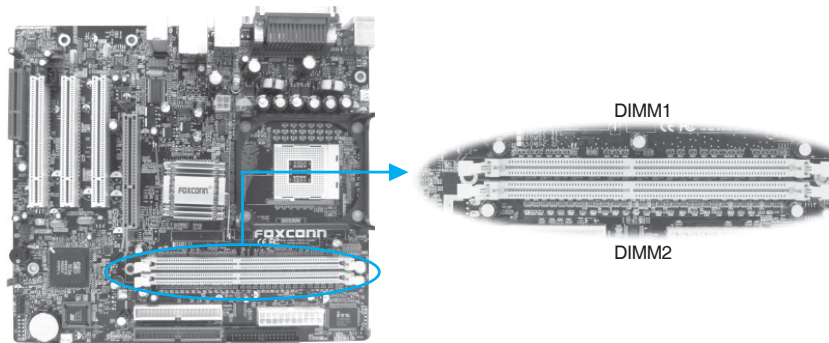

Installation of DDR Memory

1. There is only one gap in the center of the DIMM socket, and the memory module can be fixed in one direction only. Unlock a DIMM socket by pressing the module clips outward.
2. Align the memory module to the DIMM socket and insert the module vertically into the DIMM socket.

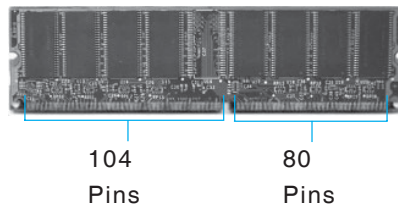

3. The plastic clips at both sides of the DIMM socket will lock automatically.

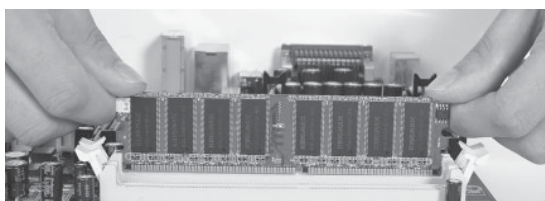

Warning :

Be sure to unplug the AC power supply before adding or removing expansion cards or other system peripherals, especially the memory devices, otherwise your motherboard or the system memory might be seriously damaged.

Memory Qualified Vendor List

The following table lists the Memory modules that have been tested and qualified for use with this motherboard.

Vender	Type	Size
Nanya	PC2100 (DDR 266)	128MB
Nanya	PC2700 (DDR 333)	256MB, 512MB
Micron	PC2700 (DDR 333)	256MB, 512MB
Micron	PC3200 (DDR 400)	256MB
Winbond	PC2700 (DDR 333)	256MB, 512MB
Kingston	PC2100 (DDR 266)	256MB
Kingston	PC2700 (DDR 333)	256MB, 512MB
Kingston	PC3200 (DDR 400)	256MB
A-DATA	PC2700 (DDR 333)	256MB
Transcend	PC2700 (DDR 333)	256MB
Transcend	PC3200 (DDR 400)	256MB
KingMax	PC2100 (DDR 266)	128MB, 256MB
KingMax	PC2700 (DDR 333)	256MB
TwinMOS	PC3200 (DDR 400)	512MB
Apacer	PC2700 (DDR 333)	256MB
HY	PC2100 (DDR 266)	512MB

Vender	Type	Size
HY	PC3200 (DDR 400)	256M,512M
Samsung	PC2100 (DDR 266)	128M, 256M
Samsung	PC3200 (DDR 400)	512M

 **Note:**

Make sure to use only the tested and qualified DDR DIMMS listed above. Other DDR DIMMs manufactured by other vendors may not be suitable for this motherboard.

Power Supply

This motherboard uses an ATX power supply. In order to avoid damaging any devices, make sure that they have been installed properly prior to connecting the power supply.

20-pin ATX power connector: PWR1

PWR1 is the ATX power supply connector. Make sure that the power supply cable and pins are properly aligned with the connector on the motherboard. Firmly plug the power supply cable into the connector and make sure it is secure.

4-pin ATX_12V Power Connector: PWR2

The ATX power supply connects to PWR2 and provides power to the CPU.

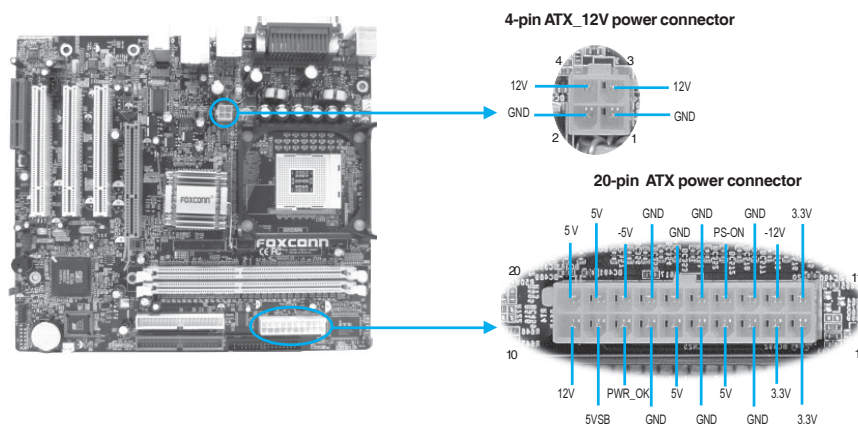

i Attention:

You have to press the power button for more than four seconds if you change the default "Instant Off" setting to "Delay 4 Sec" from the "Power Button Override" option in the BIOS Power Management Setup.

Rear Panel Connectors

This motherboard provides the ports as below:

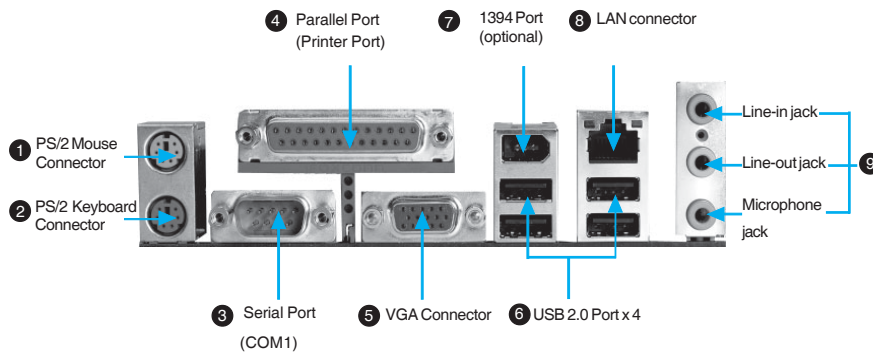

1 PS/2 Mouse Connector

This green 6-pin connector is for a PS/2 Mouse.

2 PS/2 Keyboard Connector

This purple 6-pin connector is for a PS/2 keyboard.

3 Serial Port (COM1)

This 9-pin COM1 port is for pointing devices or other serial devices.

4 Parallel Port (Printer Port)

This 25-pin port connects a parallel printer, a scanner, or other devices.

5 VGA Connector

The VGA connector is for output to a VGA-compatible device.

6 USB 2.0 ports

These four Universal Serial Bus (USB) ports are available for connecting USB 2.0/1.1 devices.

7 1394 port (optional)

This digital interface supports electronic devices such as digital cameras, scanners and printers.

⑧ LAN connector

This port allows connection to a Local Area Network (LAN) through a network hub.

⑨ Line-in jack, Line-out jack, Microphone jack

When using a two-channel sound source, the Line-out jack is used to connect to speakers or headphones; the Line-in port connects to an external CD player, tape player or other audio device. The Microphone jack is used to connect to the microphone.

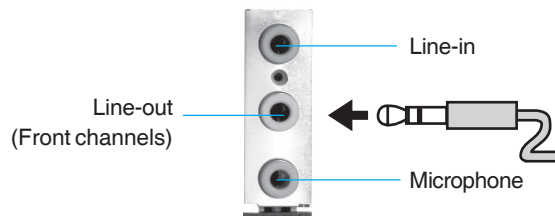

When using a 6-Channel sound source, connect the front speaker to the green audio output; connect the surround sound speaker to the blue audio input; connect the center speaker/subwoofer to the red Microphone input, as shown in the following figure:

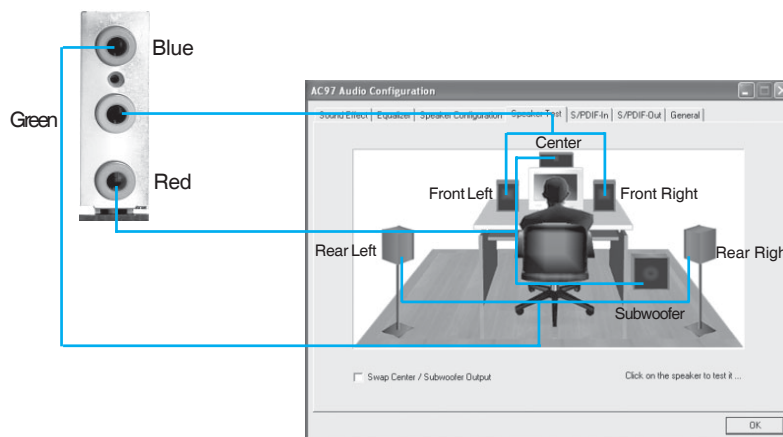

Other Connectors

This motherboard includes connectors for FDD, IDE HDD, USB, CPU/system fan, and others.

FDD Connector

This motherboard includes a standard FDD connector, supporting 360K, 720K, 1.2M, 1.44M, and 2.88M FDDs.

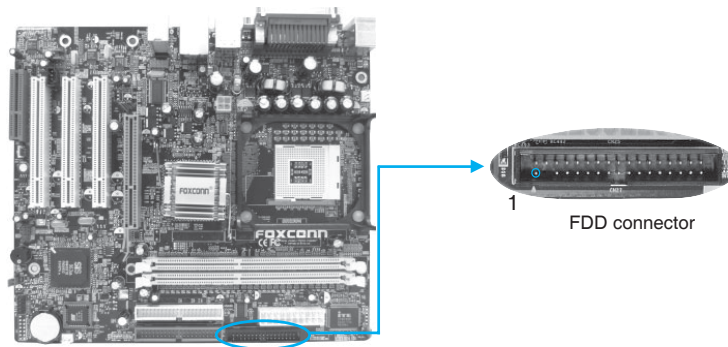

HDD connectors: IDE1 & IDE2

This connectors supports the provided UltraDMA 133/100/66 IDE hard disk ribbon cable. Connect the cable's blue connector to the primary (recommended) or secondary IDE connector, then connect the gray connector to the Ultra DMA 133/100/66 slave device (hard disk drive) and the black connector to the Ultra DMA 133/100/66 master device. If you install two hard disks, you must configure the second drive as a slave device by setting its jumper accordingly. Refer to the hard disk documentation for the jumper settings.

Attention:

Ribbon cables are directional, therefore, make sure to always connect with the cable on the same side as pin 1 of the IDE1/IDE2 or FDD connector on the motherboard.

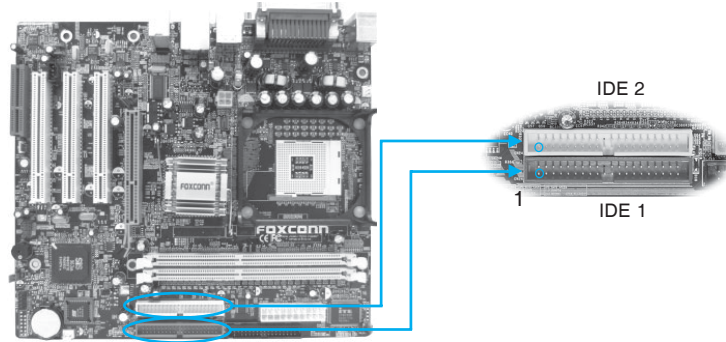

Front Panel Connector: F_P1

This motherboard includes one connector for connecting the front panel switch and LED indicators.

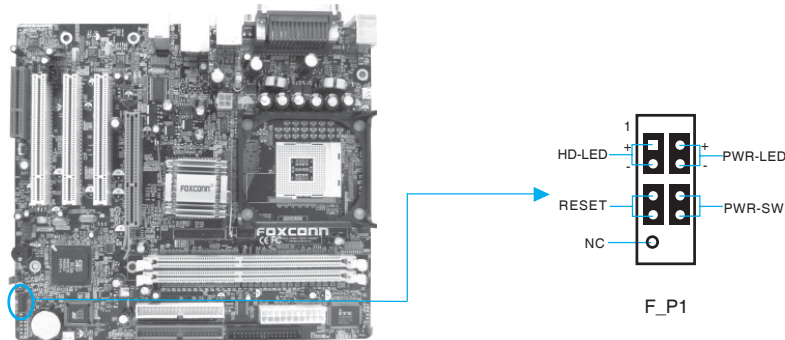

Hard Disk LED Connector (HD-LED)

The connector connects to the case's IDE indicator LED indicating the activity status of IDE hard disk.

Reset Switch (RESET)

Attach the connector to the Reset switch on the front panel of the case; the system will restart when the switch is pressed.

Power LED Connector (PWR LED)

Attach the connector to the power LED on the front panel of the case. The Power LED indicates the power supply's status. When the system is in S0 status, the LED is on. When the system is in S1 status, the LED is blink; When the system is in S3 or S5 status, the LED is off.

IrDA Header: IR (optional)

This connector supports wireless transmitting and receiving device. Before using this function, configure the settings of IR Address, IR Mode and IR IRQ from the “INTEGRATED PERIPHERALS” section of the CMOS SETUP.

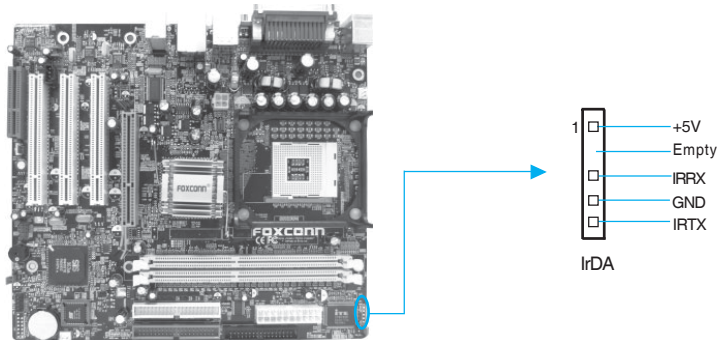

USB Headers: F_USB 1

Besides four USB ports on the rear panel, the series of motherboards also have one 10-pin headers on board which may connect to front panel USB cable (optional) to provide additional two USB ports.

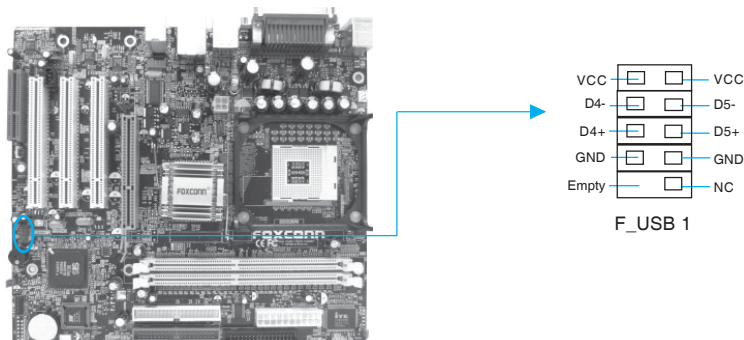

Fan Connectors: CPU_FAN, FAN1

The speed of CPU_FAN and FAN1 can be detected and viewed in “PC Health Status” section of the CMOS SETUP. These fans will be automatically turned off after the system enters suspend mode.

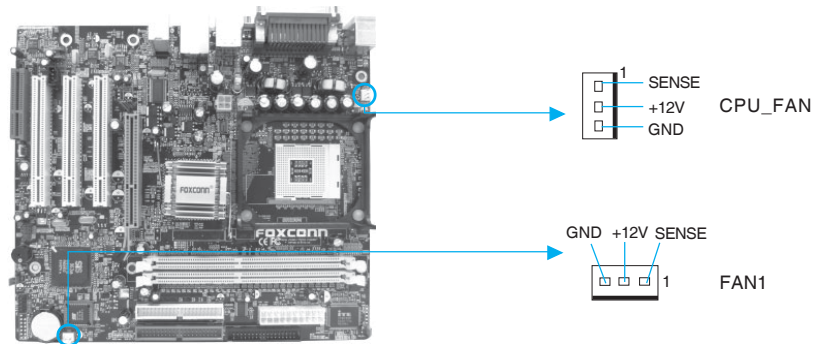

Audio Connectors: CD_IN

CD_IN is Sony standard CD audio connector, it can be connected to a CD-ROM drive through a CD audio cable.

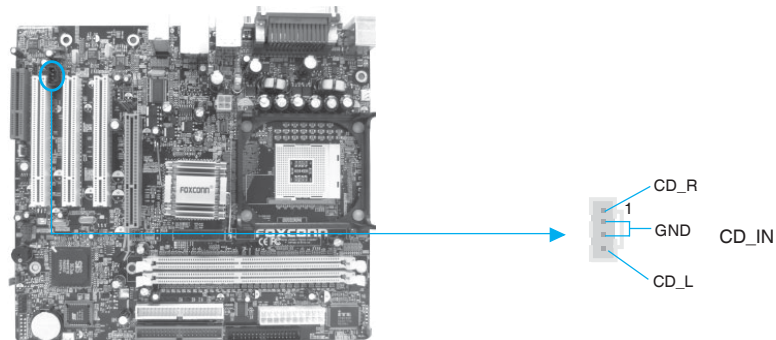

1394 Header: F_1394 (optional)

The 1394 expansion cable can be connected to either the front (provided that the front panel of your chassis is equipped with the appropriate interface) or rear panel of the chassis.

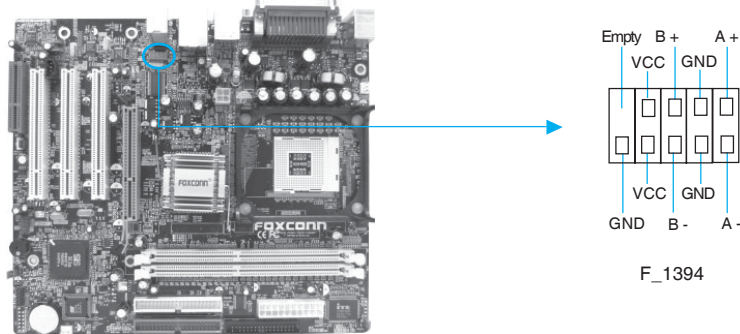

Wake-Up On LAN: WOL

Through the Wake-Up On LAN function, a wake event occurring from the network can wake up the system. To utilize this function, please be sure an ATX 12V power supply with a 5VSB line capable of delivering a current of at least 720mA, and a LAN adapter which supports this function. Then connect the header to the relevant connector on the LAN adapter, set “MACPME Power Up Control” and “PCIPME Power Up Control” to enabled in the “POWER MANAGEMENT SETUP” section of the CMOS SETUP. Save and exit, then boot the operating system once to make sure this function takes effect.

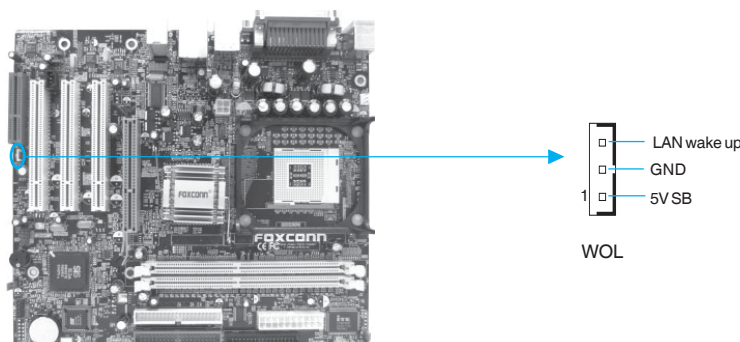

Audio Interface: F_AUDIO

The audio interface provides two kinds of audio output choices: the Front Audio, the Rear Audio. Their priority is sequenced from high to low (Front Audio to Rear Audio). If headphones are plugged into the front panel of the chassis (using the Front Audio), then the Speaker Out (Rear Audio) on the rear panel will not work. If you do not want to use the Front Audio, pin 5 and 6, pin9 and 10 must be unlocked, and then the signal will be sent to the rear audio port.

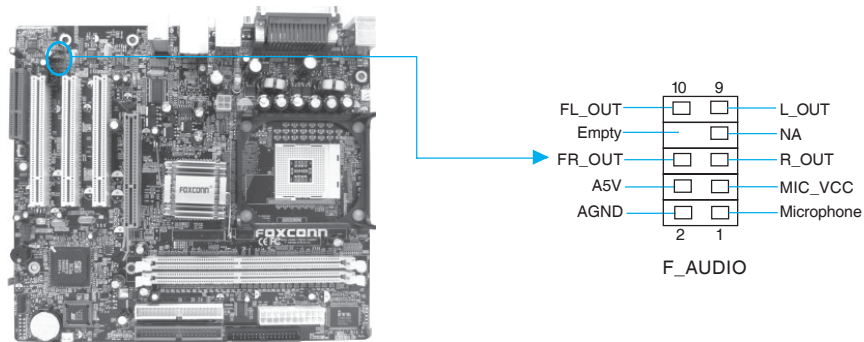

S/PDIF Out Connector: SPD_OUT

The S/PDIF out connector is capable of providing digital audio to external speakers or compressed AC3 data to an external Dolby digital decoder.

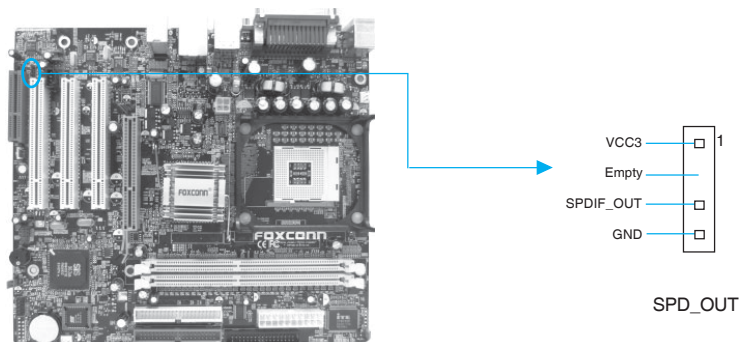

Expansion Slots

This motherboard includes three 32-bit Master PCI bus slots, one AGP slot and one CNR slot (optional).

PCI Slots

The expansion cards can be installed in the three PCI slots. When you install or take out such cards, you must make sure that the power plug has been pulled out. Please read carefully the instructions provided for such cards, and install and set the necessary hardware and software for such cards, such as the jumper or BIOS setup.

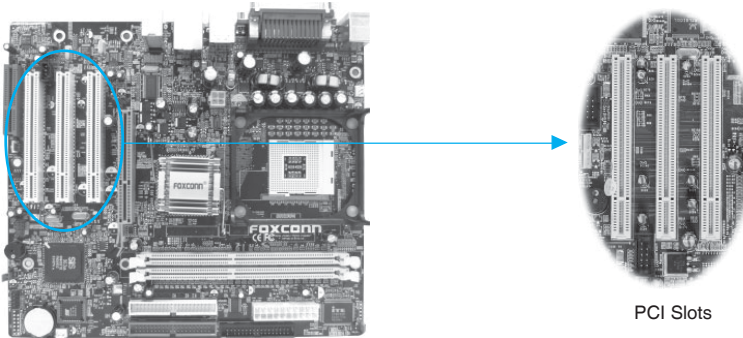

AGP Slot

This motherboard has an AGP slot that supports 1.5V AGP cards. AGP is an interfacing specification designed to display 3D images. It provides a specialized 66Mhz, 32-bit channel to allow the graphic controller to directly access the master memory and supports 4X and 8X speeds.

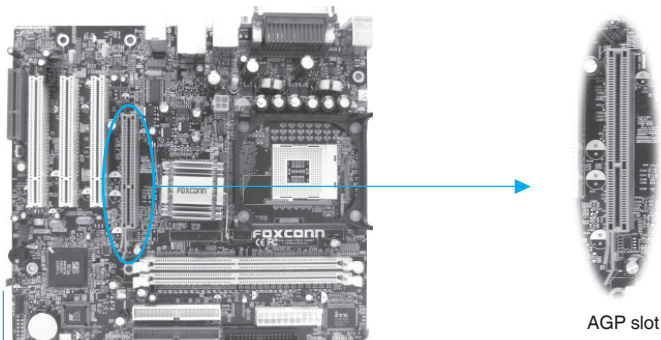

Warning:

The motherboard may be damaged if a 3.3V AGP card is used. Make sure that your AGP card is 1.5V specification. Note the notches on the card golden fingers to ensure that they fit the AGP slot on your motherboard.

Installing an expansion card

1. Before installing the expansion card, read carefully the documentation that came with it and make the necessary hardware settings for the card.
2. Make sure to unplug the power cord before adding or removing any expansion cards.
3. Remove the bracket opposite the slot that you intend to use.
4. Align the card connector with the slot and press firmly until the card is completely seated in the slot.
5. Secure the card to the chassis with the screw you removed earlier.

AGP Qualified Vendor List

The following table lists the CPU modules that have been tested and qualified for use with this Motherboard.

Vender	Type	Video Memory
MSI	MS-8895 GeForce 4 MX 440 8X	64MB
MSI	MS-8904 GeForce FX5800 8X	128MB
MSI	MS-8907 GeForce FX5200 8X	128MB
MSI	MS-8911 GeForce FX5200 8X	128MB
MSI	MS-8912 GeForce FX5600 8X	128MB
MSI	MS-8912 GeForce FX5900 8X	128MB
MSI	MSI Ti4200-VTD 8X	128MB
ASUS	V9569/TD FX5600 8X	128MB
ATI	ATI Radeon 9700 8X	128MB

Vender	Type	Video Memory
WinFast	A340 TDH 8X	128MB
Gigabyte	GA-GF1280 GeForce 2 MX	32MB
UNIKA	7917 Geforce4 MX440	64MB
Gigabyte	GV-R9600 8X	128MB
WinFast	S650 GeForce 3 Ti500 4X	64MB
ELSA	ELSA GLADIAC 518 8X	64MB
ATI	ATI 7000 VE 4X	64MB

Note:

Make sure to use only the tested and qualified AGP card listed above. Other AGP card manufactured by other vendors may not be suitable for this Motherboard.

CNR Slot (optional)

The motherboard provides this Communication and Networking Riser (CNR) interface which can support audio and modem functions. Mechanically the CNR shares the PCI3 slot, thus when you insert the CNR card, the neighboring PCI3 slot cannot be used.

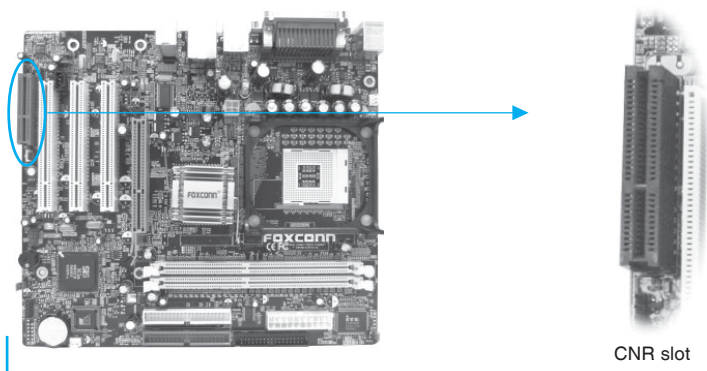

Jumpers

The users can change the jumper settings on this motherboard if needed. This section explains how to use the various functions of this motherboard by changing the jumper settings. Users should read the following contents carefully prior to modifying any jumper settings.

Description of Jumpers

1. For the jumpers on this motherboard, pin 1 can be identified by the silk-screen printed “▲” next to it. However, in this manual, pin 1 is simply labeled as “1”.
2. The following table provides some explanation of the jumper pin settings. User should refer to this when adjusting jumper settings.

Jumper	Diagram	Definition	Description
1	1 [■] [■] [□]	1-2	Set pin1 and pin2 closed
	1 [□] [■] [■]	2-3	Set pin2 and pin3 closed
1	1 [■] [■] [■]	Closed	Set the pin closed
	1 [□] [□] [□]	Open	Set the pin opened

Clear CMOS Jumper: CLS_CMOS

This motherboard uses the CMOS RAM to store all the set parameters. The CMOS can be cleared by removing the CMOS jumper.

How to clear CMOS?

1. Turn off the AC power supply and quickly connect pins 1 and 2 together using the jumper cap.
2. Return the jumper setting to normal (pins 2 and 3 locked together with the jumper cap).
3. Turn the AC power supply back on.

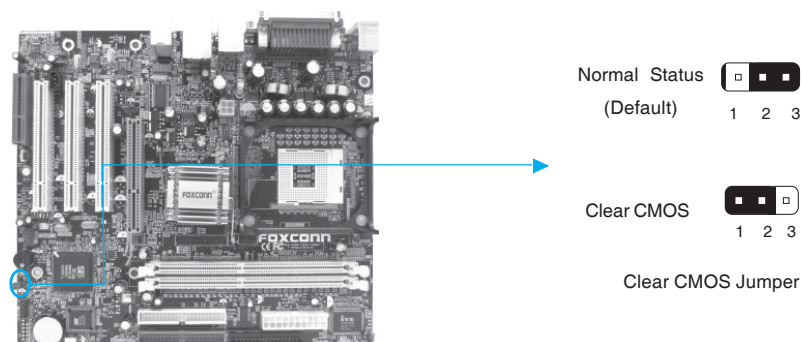

Warning:

1. Disconnect the power cable before adjusting the jumper settings.
2. Do not clear the CMOS while the system is turned on.

BIOS-Protection Jumper: FWH_EN

The motherboard BIOS is inside the FWH. If the jumper FWH_EN is set as disable (Pin2 & Pin3), the system BIOS is protected from being attacked by a serious virus, such as the CIH virus. You will be unable to flash the BIOS to the motherboard when the system BIOS is protected.

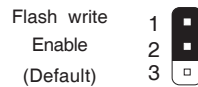
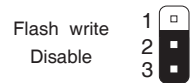
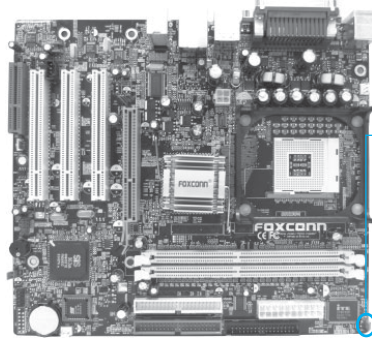

BIOS-Protection Jumper

CNR Audio Selection Jumper: J24

This jumper is used to set enable or disable CNR audio. The default status for J24 is set to disable (Pin1 & Pin2), then you cannot use the CNR audio and onboard audio is available. If you want to use CNR audio, set J24 to enable (Pin2 & Pin3).

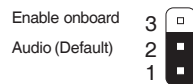
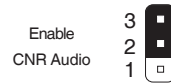
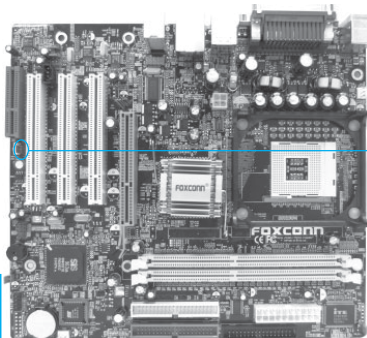

CNR Audio Selection Jumper

Starting up for the first time

1. After making all the connections, replace the system case cover.
2. Be sure that all switches are off.
3. Turn on the devices in the following order.
 - a. Monitor
 - b. External SCSI devices (starting with the last device on the chain)
 - c. System power
4. After applying power Led on the system front panel case lights up. For ATX power supplies, the system LED lights up when you press the ATX power switch. If your monitor complies with green standards or if it has a power standby feature, the monitor LED may light up or switch between orange and green after the system LED turns on. The system then runs the power-on tests. While the tests are running, the BIOS beeps or additional messages appear on the screen. If you do not see anything within 30 seconds from the time you turned on the power, the system may have failed a power-on test. Check the jumper settings and connections or call your retailer for assistance.
5. At power on, hold down <Delete> to enter BIOS Setup. Follow the instructions in Chapter 3.

Powering off the computer

1. Using the OS shut down function

If you use windows 98/ME/2000/XP, click the Start button, click Shut Down, then the OK button to shut down the computer. The power supply should turn off after Windows shuts down.
2. Using the dual function power switch

While the system is ON, pressing the power switch for less than 4 seconds puts the system to sleep mode or to soft-off mode, depending on the BIOS setting. Pressing the power switch for more than 4 seconds lets the system enter the soft-off mode regardless of the BIOS setting.

Chapter 3

This chapter tells how to change system settings through the BIOS Setup menus. Detailed descriptions of the BIOS parameters are also provided.

You have to run the Setup Program when the following cases occur:

1. An error message appears on the screen during the system POST process.
2. You want to change the default CMOS settings.

This chapter includes the following information:

- ❖ Enter BIOS Setup
- ❖ Main Menu
- ❖ Standard CMOS Features
- ❖ BIOS Features
- ❖ Advanced BIOS Features
- ❖ Advanced Chipset Features
- ❖ Integrated Peripherals
- ❖ Power Management Setup
- ❖ PnP/PCI Configurations
- ❖ PC Health Status
- ❖ Frequency/Voltage Control
- ❖ Load Fail-Safe Defaults
- ❖ Load Optimized Defaults
- ❖ Set Password
- ❖ Save & Exit Setup
- ❖ Exit Without Saving

Enter BIOS Setup

The BIOS is the communication bridge between hardware and software, correctly setting up the BIOS parameters is critical to maintain optimal system performance. Power on the computer, when the following message briefly appears at the bottom of the screen during the POST (Power On Self Test), press key to enter the AWARD BIOS CMOS Setup Utility.

Press TAB to show POST screen, DEL to enter SETUP.

 **Note:**

We do not suggest that you change the default parameters in the BIOS Setup, and we shall not be responsible for any damage that result from any changes that you make.

Main Menu

The main menu allows you to select from the list of setup functions and two exit choices. Use the arrow keys to select among the items and press <Enter> to accept or go to the sub-menu.

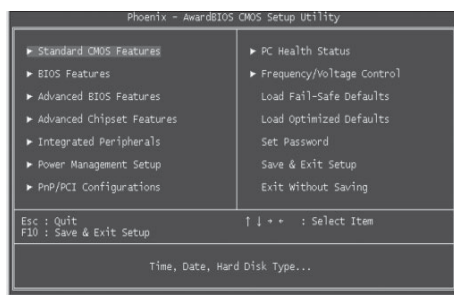

Main Menu

The items in the main menu are explained as below:

Standard CMOS Features

The basic system configuration can be set up through this menu.

BIOS Features

The special features can be set up through this menu.

Advanced BIOS Features

The advanced system features can be set up through this menu.

Advanced Chipset Features

The values for the chipset can be changed through this menu, and the system performance can be optimized.

Integrated Peripherals

All onboard peripherals can be set up through this menu.

Power Management Setup

All the items of Green function features can be set up through this menu.

PnP/PCI Configurations

The system's PnP/PCI settings and parameters can be modified through this menu.

PC Health Status

This will display the current status of your PC.

Frequency/Voltage Control

Frequency and voltage settings can be adjusted through this menu.

Load Fail-Safe Defaults

The default BIOS settings can be loaded through this menu.

Load Optimized Defaults

The optimal performance settings can be loaded through this menu, however, the stable default values may be affected.

Set Password

The password can be set up through this menu.

Save & Exit Setup

Save CMOS value settings to CMOS and exit setup.

Exit Without Saving

Abandon all CMOS value changes and exit setup.

Standard CMOS Features

This sub-menu is used to set up the standard CMOS features, such as the date, time, HDD model and so on. Use the arrow keys select the item to set up, and then use the <PgUp> or <PgDn> keys to choose the setting values.

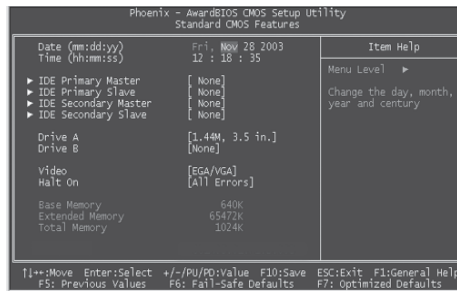

Standard CMOS Features Menu

Date

This option allows you to set the desired date (usually as the current day) with the <day><month><date><year> format.

- Day—weekday from Sun. to Sat., defined by BIOS (read-only).
- Month—month from Jan. to Dec..
- Date—date from 1st to 31st, can be changed using the keyboard.
- Year—year, set up by users.

Time

This option allows you to set up the desired time (usually the current day) with <hour><minute><second> format.

IDE Primary/Secondary Master/Slave

These categories identify the HDD types of 2 IDE channels installed in the computer system. There are three choices provided for the Enhanced IDE BIOS: None, Auto, and Manual. “None” means no HDD is installed or set; “Auto” means the system can auto-detect the hard disk when booting up; by choosing “Manual” and changing Access Mode to “CHS”, the related information should be entered manually. Enter the information directly from the keyboard and press < Enter>:

Cylinder	number of cylinders	Head	number of heads
Precomp	write pre-compensation	Landing Zone	landing zone
Sector	number of sectors		

Award (Phoenix) BIOS can support 3 HDD modes: CHS, LBA and Large or Auto mode.

CHS	For HDD<528MB
LBA	For HDD>528MB & supporting LBA (Logical Block Addressing)
Large	For HDD>528MB but not supporting LBA
Auto	Recommended mode

Drive A/B

This option allows you to select the kind of FDD to be installed, including “None”, [360K, 5.25 in], [1.2M, 5.25 in], [720K, 3.5 in], [1.44M, 3.5 in] and [2.88 M, 3.5 in].

Video

The following table is provided for your reference in setting the display mode for your system.

EGA/VGA	Enhanced Graphics Adapter / Video Graphic Array. For EGA, VGA, SEGA, SVGA, or PGA monitor adapters.
CGA 40	Color Graphic Adapter, powering up in 40 column mode.
CGA 80	Color Graphic Adapter, powering up in 80 column mode.
MONO	Monochrome adapter, including high resolution monochrome adapters.

Halt On

This category determines whether or not the computer will stop if an error is detected during powering up.

All Errors	Whenever the BIOS detects a nonfatal error, the system will stop and you will be prompted.
No Errors	The system boot will not stop for any errors that may be detected.
All, But Keyboard	The system boot will not stop for a keyboard error; but it will stop for all other errors.
All, But Diskette	The system boot will not stop for a disk error; but it will stop for all other errors.
All, But Disk/Key	The system boot will not stop for a keyboard or disk error, but it will stop for all other errors.

Memory

This is a Display-Only Category, determined by POST (Power On Self Test) of the BIOS.

Base Memory	The BIOS POST will determine the amount of base (or conventional) memory installed in the system.
Extended Memory	The BIOS determines how much extended memory is present during the POST.
Total Memory	Total memory of the system.

BIOS Features



BIOS Features Menu

❖ [SuperBoot] SuperBoot (Default: Disabled)

SuperBoot allows system-relevant information to be stored in CMOS upon the first normal start-up of your PC, and the relevant parameters will be restored to help the system start up more quickly on each subsequent start-up. The available setting values are: Disabled and Enabled.

❖ [SuperBIOS-Protect] SuperBIOS-Protect (Default: Disabled)

SuperBIOS-Protect function protects your PC from being affected by viruses, e.g. CIH. The available setting values are: Disabled and Enabled.

❖ [SuperRecovery] SuperRecovery Hotkey (Default: LSHIFT+F12)

SuperRecovery provides the users with an excellent data protection and HDD recovery function. There are 12 optional hotkey and the default hotkey is LSHIFT+F12.

❖ [SuperSpeed] CPU Clock (Depending on the specification of the CPU)

The conventional over-clock method uses the jumpers on the motherboard, and it is both troublesome and apt to errors. By using SuperSpeed, a CPU can be overclocked by keying in the desired. If you use FSB 400 MHz CPU, the setting range is from 100 MHz to 132 MHz; FSB 533 MHz CPU, the setting range is from 133 MHz to 165 MHz; FSB 800MHz CPU, the setting range is from 200 MHz to 232 MHz.

⚠ Warning:

Be sure your selection is right. CPU over speed will be dangerous!
We will not be responsible for any damages caused.

Advanced BIOS Features

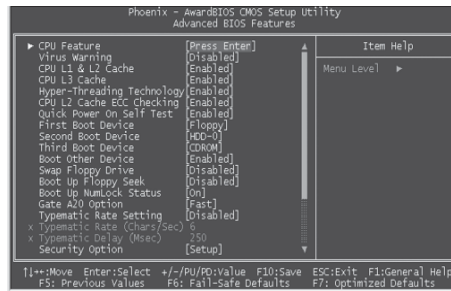

Advanced BIOS Features Menu

❖ CPU Feature

Press enter to set the items of CPU feature. Please refer to page 42.

❖ Virus warning (Default: Disabled)

Allows you to choose the VIRUS warning feature for IDE hard disk boot sector protection. If this function is enabled and someone attempt to write data into this area, BIOS will show a warning message on screen and an alarm will beep. The available setting values are: Disabled and Enabled.

Note: Such function provides protection to the start-up sector only; it does not protect the entire hard disk.

❖ CPU L1 & L2 Cache (Default: Enabled)

This option is used to turn on or off the CPU L1 and L2 cache. The available setting values are: Disabled and Enabled.

❖ CPU L3 Cache (Default: Enabled)

This option is used to enable or disable CPU L3 cache. The available setting values are: Disabled and Enabled.

❖ Hyper-Threading Technology (Default: Enabled)

This option is used to turn on or off the Hyper-threading function of the CPU. The available setting values are: Disabled and Enabled.

Note: This function will not be displayed until a CPU that supports Hyper-Threading has been installed.

❖ CPU L2 Cache ECC Checking (Default: Enabled)

This option is used to enable or disable CPU L2 cache ECC Checking. The available setting values are: Disabled and Enabled.

❖ **Quick Power On Self Test (Default: Enabled)**

Enable this option to shorten the power on testing (POST) and have your system start up faster. The available setting values are: Disabled and Enabled.

❖ **First/Second/Third Boot Device (Default: Floppy/HDD- 0/CDROM)**

This option allows you to set the boot device's sequence. The available setting values are: Floppy, LS120, HDD-0, SCSI, CDROM, HDD-1, HDD-2, HDD-3, ZIP100, USB-FDD, USB-ZIP, USB-CDROM, USB-HDD, LAN and Disabled.

❖ **Boot Other Device (Default: Enabled)**

With this function set to enable, the system will to boot from some other devices if the first/second/third boot devices failed. The available setting values are: Disabled and Enabled.

❖ **Swap Floppy Drive (Default: Disabled)**

If you have two floppy diskette drivers in your system, this option allows you to swap the assigned drive letters. The available setting values are: Disabled and Enabled.

❖ **Boot Up Floppy Seek (Default: Disabled)**

If this option is enabled, BIOS will activate the floppy drive during the system boot and the drive's indicator will flash after the activation. The magnetic head will move back and forth from A to B. The available setting values are: Disabled and Enabled.

❖ **Boot Up NumLock Status (Default: On)**

This option defines if the keyboard Num Lock key is active when your system is started. The available setting values are: On and Off.

❖ **Gate A20 Option (Default: Fast)**

This option is used to set up the A20 signal control necessary for access to the 1MB memory. The available setting values are: Normal and Fast.

❖ **Typematic Rate Setting (Default: Disabled)**

If this option is enabled, you can use the following two items to see the typematic rate and the typematic delay settings for your keyboard. The available setting values are: Disabled and Enabled.

❖ **Typematic Rate (Chars/Sec) (Default: 6)**

Use this option to define how many characters per second a held-down key generated.

❖ **Typematic Delay (Msec) (Default: 250)**

Use this option to define how many milliseconds must elapse before a held-down key begins generating repeat characters.

❖ **Security Option (Default: Setup)**

When it is set to "Setup", a password is required to enter the CMOS Setup screen; When it is set to "System", a password is required not only to enter CMOS Setup, but also to start up your PC.

❖ **APIC Mode (Default: Enabled)**

This option is used to enable or disable APIC mode. The available setting values are: Disabled and Enabled.

❖ **MPS Version Control For OS (Default: 1.4)**

This option is used to set up the version of MPS Table used in NT4.0 OS.

❖ **OS Select For DRAM > 64MB (Default: Non-OS2)**

This option is only required if you have installed more than 64 MB of memory and you are running the OS/2 operating system. Otherwise, leave this option at the default.

❖ **HDD S.M.A.R.T Capability (Default: Disabled)**

This option is used to enable or disable hard disk S.M.A.R.T. support function. The available setting values are: Disabled and Enabled.

❖ **Report No FDD For WIN 95 (Default: No)**

If you are using the Windows 95 and running a system with on floppy drive, select "Yes" for this option to ensure compatibility with Windows 95 logo certification. The available setting values are: No and Yes.

❖ **Video BIOS Shadow (Default: Enabled)**

This option is used to enable or disable Video BIOS Shadow. If you enable this option, the video BIOS will be copied to RAM. Video shadow will increase the video speed. The available setting values are: Disabled and Enabled.

❖ **Small Logo (EPA) Show (Default: Enabled)**

This option allows you to enable or disable the EPA logo. The available setting values are: Disabled and Enabled.

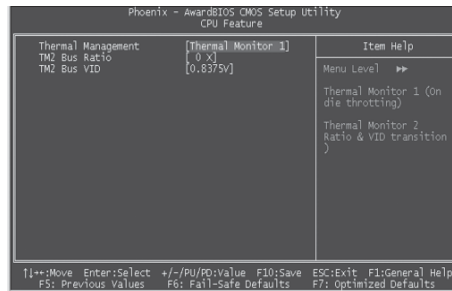

CPU Feature Menu

❖ **Thermal Management (Default: Thermal Monitor 1)**

This option is used to manage Prescott CPU thermal.

Note: This function will not be displayed until a Prescott CPU has been installed.

❖ **TM2 Bus Ratio (Default: 0 X)**

Represents the frequency bus ratio of the throttled performance state that will be initiated when the on-diesensor goes from not hot to hot.

❖ **TM2 Bus VID (Default: 0.8375V)**

Represents the voltage of the throttled performance state that will be initiated when the on-diesensor goes from not hot to hot.

Advanced Chipset Features

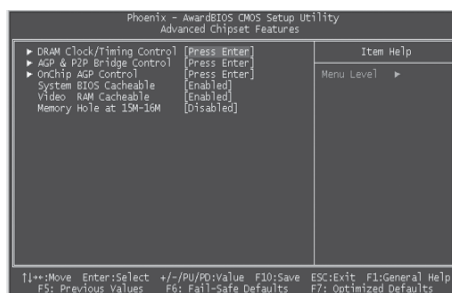

Advanced Chipset Features Menu

❖ DRAM Clock/Timing Control

Press enter to set the items about DDR RAM. Please refer to page 44.

❖ AGP & P2P Bridge Control

Press enter to set the items about AGP. Please refer to page 45.

❖ OnChip AGP Control

Press enter to set the items about onchip AGP. Please refer to page 46.

❖ System BIOS Cacheable (Default: Enabled)

Select "Enabled" to allow caching of the system BIOS which may improve performance. If any other program writes to this memory area, a system error may result. The available setting values are: Enabled and Disabled.

❖ Video RAM Cacheable (Default: Enabled)

Select "Enabled" to allow caching of the Video BIOS which may improve performance. If any other program writes to this memory area, a system error may result. The available setting values are: Enabled and Disabled.

❖ Memory Hole at 15M-16M (Default: Disabled)

This option is used to determine whether the 15M-16M address field of memory is reserved for the ISA expansion card. The available setting values are: Enabled and Disabled.

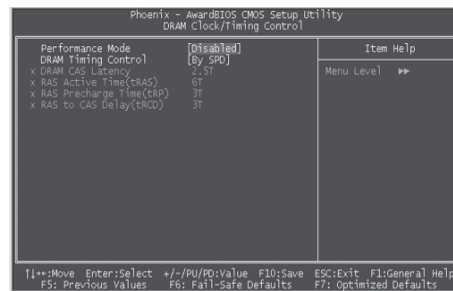

DRAM Clock/Timing Control Menu

- ❖ **Performance Mode (Default: Disabled)**
This option is used to disable or enable performance mode.
- ❖ **DRAM Timing control (Default: By SPD)**
This option determines DRAM timing using SPD or manual configuration. Only set as manual, the following 4 items can be updated.
- ❖ **DRAM CAS Latency (Default: 2.5T)**
This option determines CAS Latency. The available setting values are: 2T, 2.5T, 3T.
- ❖ **RAS Active Time (tRAS) (Default: 6T)**
This option determines RAS active time. The available setting values are: 4T - 9T.
- ❖ **RAS Precharge Time (tRP) (Default: 3T)**
This option is used to define the idel clocks after issuing a precharge command to the SDRAM.
- ❖ **RAS to CAS Delay (tRCD) (Default: 3T)**
This option is used to define the minimum RAS to CAS delay using 1us granularity.

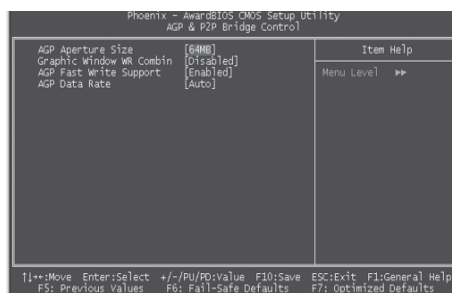

AGP & P2P Bridge Control Menu

❖ **AGP Aperture Size (Default: 64 MB)**

This option defines the size of the aperture if you use an AGP graphics adapter. The aperture is a portion of the PCI memory address range dedicated for graphic memory address space.

Note: This function does not work when Onboard VGA is used.

❖ **Graphic Window WR Combin (Default: Disabled)**

This option is used to disable or enable Graphic Window Write Combin mode.

❖ **AGP Fast Write Support (Default: Enabled)**

Use this option to enable or disable AGP fast write support.

❖ **AGP Data Rate (Default: Auto)**

Use this option to set AGP data rate.



OnChip AGP Control Menu

❖ **VGA Share Memory Size (Default: 32 MB)**

This option is used to set the onboard VGA share memory size. The available setting are 16MB, 32MB, 64MB, 128MB.

❖ **Graphics Engin Clock (Default: 133 MHz)**

This option is used to set onchip AGP graphics engin clock. The available setting are 100 MHz, 133MHZ, 166MHZ, 200MHZ.

Integrated Peripherals

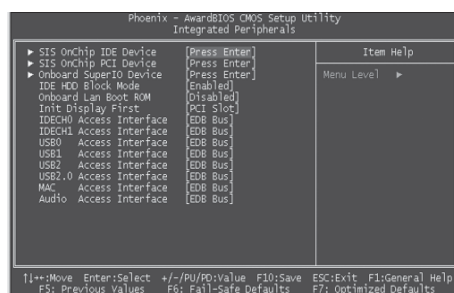

Integrated Peripherals Menu

❖ SIS Onchip IDE Device

Press enter to set onchip IDE device. Please refer to page 48.

❖ SIS Onchip PCI Device

Press enter to set onchip PCI device. Please refer to page 49.

❖ Onboard SuperIO Device

Press enter to set Onboard SuperIO device. Please refer to page 50.

❖ IDE HDD Block Mode (Default: Enabled)

This option is used to set whether the IDE HDD Block Mode is allowed. The available setting values are: Disabled and Enabled.

❖ Onboard Lan Boot ROM (Default: Disabled)

This option is used to decide whether to invoke the boot ROM of the onboard LAN chip.

❖ Init Display First (Default: PCI Slot)

This option is used to set which display device will be used first when your PC starts up. The available setting values are: AGP and PCI Slot.

❖ IDE CH0/1 Access Interface (Default: EDB Bus)

This option is used to set IDE CH0/1 access interface. The available setting values are: PCI Bus and EDB Bus.

❖ USB0/1/2/2.0 Access Interface (Default: EDB Bus)

This option is used to set USB0/1/2/2.0 Access Interface. The available setting values are: PCI Bus and EDB Bus.

❖ MAC Access Interface (Default: EDB Bus)

This option is used to set MAC access interface. The available setting values are: PCI Bus and EDB Bus.

❖ **Audio Access Interface (Default: EDB Bus)**

This option is used to set audio Access Interface. The available setting values are: PCI Bus and EDB Bus.

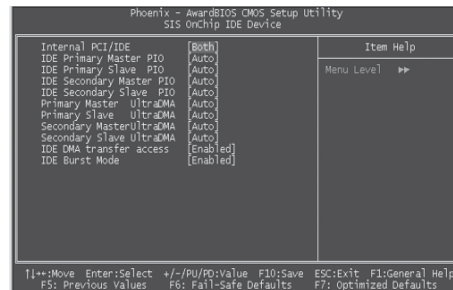

SIS OnChip IDE Device Menu

❖ **Internal PCI/IDE (Default: Both)**

This option is used to set the ports of onboard IDE. The available setting values are: Disabled, Primary, Secondary and Both.

❖ **IDE Primary/ Secondary Master/Slave PIO (Default: Auto)**

These four items let you assign which kind of PIO (Programmed Input/Output) is used by IDE devices. Choose Auto to let the system auto detect which PIO mode is the best or select a PIO mode from 0-4.

❖ **Primary/Secondary Master/Slave UltraDMA (Default: Auto)**

UltraDMA technology provides faster access to IDE devices. If you install a device that supports UltraDMA, change the appropriate item on this list to Auto. The available setting values are: Disabled and Auto.

❖ **IDE DMA transfer access (Default: Enabled)**

This option is used to enable or disable IDE DMA transfer access.

❖ **IDE Burst Mode (Default: Enabled)**

This option is used to enable or disable IDE burst mode.

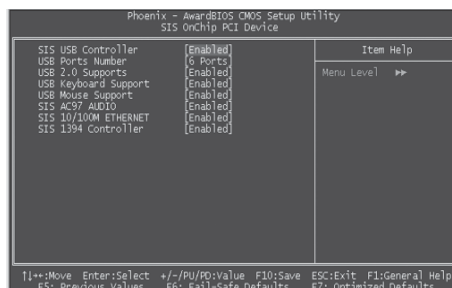

SIS OnChip PCI Device Menu

- ❖ **SIS USB Controller (Default: Enabled)**
This option is used to enable or disable SIS USB controller.
- ❖ **USB Ports Number (Default: 6 ports)**
This option is used to select the USB ports number.
- ❖ **USB 2.0 Supports (Default: Enabled)**
This option is used to enable or disable USB 2.0.
- ❖ **USB Keyboard Support (Default: Enabled)**
This option is used to enable or disable USB keyboard under legacy OS.
- ❖ **USB Mouse Support (Default: Enabled)**
This option is used to enable or disable USB mouse under legacy OS.
- ❖ **SIS AC97 AUDIO (Default: Enabled)**
This option is used to enable or disable SIS AC97 AUDIO.
- ❖ **SIS 10/100M ETHERNET (Default: Enabled)**
This option is used to enable or disable SIS 10/100M ethernet.
- ❖ **SIS 1394 Controller (Default: Enabled) (optional)**
This option is used to enable or disable SIS 1394 controller.

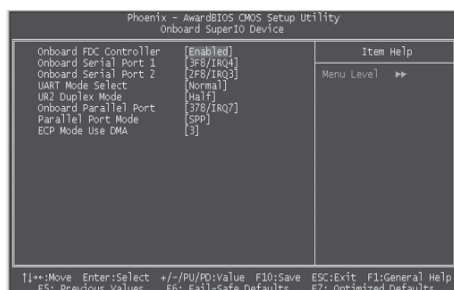

Onboard SuperIO Device Menu

❖ **Onboard FDC Controller (Default: Enabled)**

This option is used to set whether the Onboard FDC Controller is enabled. The available setting values are: Disabled and Enabled.

❖ **Onboard Serial Port1/2 (Default: 3F8/IRQ4 / 2F8/IRQ3)**

This option is used to assign the I/O address and interrupt request (IRQ) for the onboard serial port 1/2.

Note: Do not try to set the same values for serial ports 1 and 2.

❖ **UART Mode Select (Default: Normal)**

Use this option to select the UART mode. Setting values include Normal, IrDA, ASKIR and SCR. The setting value is determined by the infrared module installed on the board.

❖ **UR2 Duplex Mode (Default: Half)**

This option is available when UART 2 mode is set to either ASKIR or IrDA. This option enables you to determine the infrared function of the onboard infrared chip. The available setting values are: Half and Full.

❖ **Onboard Parallel Port (Default: 378/IRQ7)**

This option allows you to determine onboard parallel port controller I/O address and interrupt request (IRQ). Setting values include Disabled, 378/IRQ7, 278/IRQ5 and 3BC/IRQ7.

❖ **Parallel Port Mode (Default: SPP)**

Select an address and corresponding interrupt for the onboard parallel port. Setting values include SPP, EPP, ECP, ECP+EPP.

❖ **ECP Mode Use DMA (Default: 3)**

Select a DMA Channel for the parallel port when using the ECP mode. This field is only configurable if Parallel Port Mode is set to ECP. The available setting values are: 3 and 1.

Power Management Setup

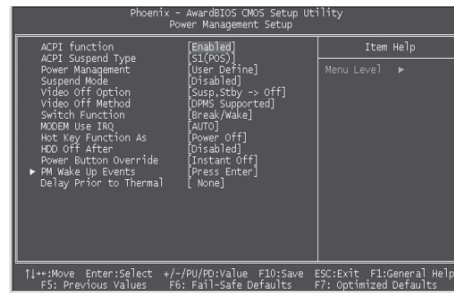

Power Management Setup Menu

❖ ACPI function (Default: Enabled)

ACPI stands for “Advanced Configuration and Power Interface”. ACPI is a standard that defines power and configuration management interfaces between an operating system and the BIOS. In other words, it is a standard that describes how computer components work together to manage system hardware. In order to use this function the ACPI specification must be supported by the OS (for example, Windows2000 or WindowsXP). The available setting values are: Enabled and Disabled.

❖ ACPI Suspend Type (Default: S1(POS))

This option is used to set the energy saving mode of the ACPI function. When you select “S1 (POS)” mode, the power will not shut off and the supply status will remain as it is, in S1 mode the computer can be resumed at any time. When you select “S3 (STR)” mode, the power will be cut off after a delay period. The status of the computer before it enters STR will be saved in memory, and the computer can quickly return to previous status when the STR function wakes. When you select “S1 & S3” mode, the system will automatically select the delay time.

❖ Power Management (Default: User Define)

This option is used to set the power management scheme. Available settings are: User Define, Min Saving and Max Saving.

❖ Suspend Mode (Default: Disabled)

This option is used to set the idle time before the system enters into sleep status. The setting values are Disabled and 1 Min - 1 hour.

❖ **Video Off Option (Default: Susp, Stby -> off)**

This option is used to set video off option. The setting values are Always On, Suspend -> off, Susp,Stby -> off, All Modes -> off.

❖ **Video Off Method (Default: DPMS Supported)**

This option is used to define the video off method. "Blank Screen" mode means that after the computer enters power saving mode, only the monitor will close, however, the vertical and horizontal scanning movement of the screen continues. When you select the "V/H SYNC + Blank" mode the vertical and horizontal scanning movement of screen stops when the computer enters power saving mode. "DPMS Supported" mode is a new screen power management system, and it needs to be supported by the monitor you're using.

❖ **Switch Function (Default: Break/Wake)**

This option is used to enable or disable switch function to wake up. The setting values are Break/Wake and disabled.

❖ **MODEM Use IRQ (Default: AUTO)**

This option is used to set the IRQ in which the MODEM can use. The system will automatically wake up when the Modem receives an incoming call.

❖ **Hot Key Function As (Default: Power Off)**

This option is used to define the hot key function. The available setting values are Disabled, Power off, Suspend.

❖ **HDD Off After (Default: Disabled)**

This option is used to define the continuous HDD idle time before the HDD enters power saving mode. The setting values are Disabled and 1 Min -15 Min.

❖ **Power Button Override (Default: Instant Off)**

This option is used to set the power down method. This function is only valid for systems using an ATX power supply.

When "Instant Off" is selected, press the power switch to immediately turn off power.

When "Delay 4 Sec" is selected, press and hold the power button for four seconds to turn off power.

❖ **PM Wake Up Events**

Press enter to set the items of PM wake up Events. Please refer to page 53.

❖ **Delay Prior to Thermal (Default: None)**

This option is used to set the delay time before the CPU enters auto thermal mode. The setting values are None, 1Min, 2 Min, 4 Min, 8 Min, 16 Min, 32 Min, 64 Min.

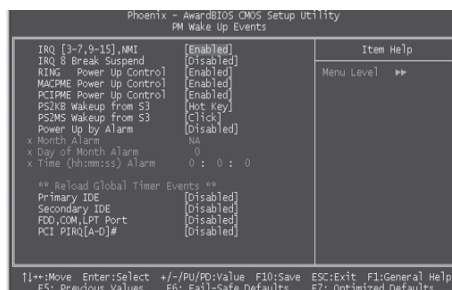

PM Wake Up Events Menu

❖ **IRQ [3-7,9-15], NMI (Default: Enabled)**

This option is used to enable or disable IRQ[3-7,9-15], NMI.

❖ **IRQ 8 Break Suspend (Default: Disabled)**

This option is used to enable or disable IRQ8 break suspend.

❖ **RING Power Up Control (Default: Enabled)**

If this option is enable, it allows the system to resume from a software power down or power saving mode whenever there is an incoming call to an installed fax/modem. This function needs to be supported by the relevant hardware and software. The setting values are Disabled and Enabled.

❖ **MACPME Power Up Control (Default: Enabled)**

This option is used to enable or disable the system to be waken up by onboard LAN.

❖ **PCIPME Power Up Control (Default: Enabled)**

This option is used to enable or disable the system to be waken up by PCI card.

❖ **PS2KB Wakeup from S3 (Default: Hot Key)**

This option is used to set which action will wake up PS/2 keyboard from S3 status. The setting values are Any Key, Hot Key, Password.

❖ **PS2MS Wakeup from S3 (Default: Click)**

This option is used to set which action will wake up PS/2 mouse from S3 status. The setting values are Disabled, Click, Move & Click.

❖ **Power Up by Alarm (Default: Disabled)**

This option is used to set the timing of the start-up function. In order to use this function, the start-up password function must be canceled. Also, the PC power source must not be turned off. The setting values are Disabled and Enabled.

❖ Month Alarm

This option is used to set the timing for the start-up month. The setting values contain 0 - 12 and NA.

❖ Day of Month Alarm

This option is used to set the timing for the start-up day of the month. The setting values contain 0 - 31.

❖ Time (hh:mm:ss) Alarm

This option is used to set the timing for the start-up time. The setting values contain hh:0 - 23; mm:0 - 59; ss:0 - 59.

❖ Primary/Secondary IDE (Default: Disabled)

When these items are enabled, the system will restart the power saving timeout counters when any activity is detected on any of the drives or devices on the primary or secondary IDE channels. The setting values are Disabled and Enabled.

❖ FDD, COM, LPT Port (Default: Disabled)

when this option is enabled, the system will restart the power saving timeout counters when any activity is detected on the floppy disk drive, serial ports, or the parallel port.

❖ PCI PIRQ [A-D]# (Default: Disabled)

When this option is disabled, any PCI device set as the master will not power on the system.

PnP/PCI Configurations

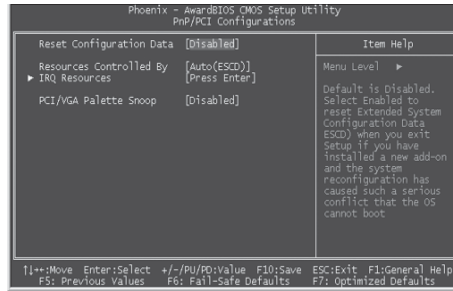

PnP/PCI Configurations Menu

❖ **Reset Configuration Data (Default: Disabled)**

This option is used to set whether the system is permitted to automatically distribute IRQ DMA and I/O addresses when each time that the machine is turned on. The setting values are Disabled and Enabled.

❖ **Resources Controlled By (Default: Auto(ESCD))**

This option is used to define the system resource control scheme. If all cards you use support PnP, then select Auto (ESCD) and the BIOS automatically distributes interruption resources. If you install ISA cards not supporting PnP, you will need to select "Manual" and manually adjust interruption resources in the event of hardware conflicts. However, since this motherboard has no ISA slot, this option does not apply.

❖ **IRQ Resources**

Press the <Enter> key, then manually set IRQ resources.

❖ **PCI/VGA Palette Snoop (Default: Disabled)**

If you use a non-standard VGA card, use this option to solve graphic acceleration card or MPEG audio card problems (e.g., colors not accurately displayed). The setting values are Disabled and Enabled.

PC Health Status

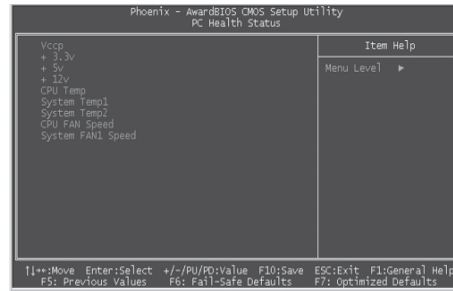

PC Health Status Menu

❖ **Vccp, +3.3v, +5v, +12v**

The current voltages will be automatically detected by the system.

❖ **CPU Temp**

The current CPU temperature will be automatically detected by the system.

❖ **System Temp1**

The system temperature1 will be automatically detected by the system.

❖ **System Temp2**

The system temperature2 will be automatically detected by the system.

❖ **CPU FAN Speed**

The CPU fan speed will be automatically detected by the system.

❖ **System FAN1 Speed**

The system fan1 speed will be automatically detected by the system.

Frequency/Voltage Control

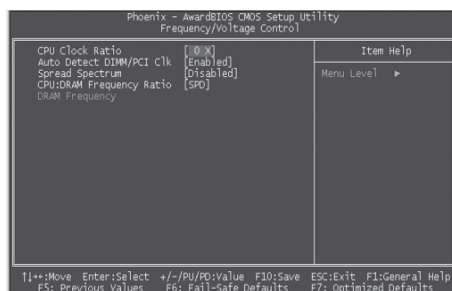

Frequency/Voltage Control Menu

❖ **CPU Clock Ratio (Default: based on CPU specifications)**

This option is used to set the ratio of an unlocked CPU. Using different CPU, the setting values are different.

Note: this option is invisible for locking frequency CPU.

❖ **Auto Detect DIMM/PCI Clk (Default: Enabled)**

This option is used to set whether the clock of an unused PCI/DIMM slot will be disabled to reduce electromagnetic interference. The setting values are Disabled and Enabled.

❖ **Spread Spectrum (Default: Disabled)**

If you enable spread spectrum, it can significantly reduce the EMI (Electro-Magnetic Interference) generated by the system.

❖ **CPU: DRAM Frequency Ratio (Default: SPD)**

This option is used to set CPU:DRAM Frequency Ratio.

❖ **DRAM Frequency**

This option is used to show DRAM frequency.

 **Warning:**

Be sure your selection is right. CPU over speed will be dangerous!
We will not be responsible for any damages caused.

Load Fail-Safe Defaults

Press <Enter> to select this option. A dialogue box will pop up that allows you to load the default BIOS settings. Select <Y> and then press <Enter> to load the defaults. Select <N> and press <Enter> to exit without loading. The defaults set by BIOS set the basic system functions in order to ensure system stability. But if your computer cannot POST properly, you should load the fail-safe defaults to restore the original settings. Then carry out failure testing. If you only want to load the defaults for a single option, you can select the desired option the <F6> key.

Load Optimized Defaults

Select this option and press <Enter>, and a dialogue box will pop up to let you load the optimized BIOS default settings. Select <Y> and then press <Enter> to load the optimized defaults. Select <N> and press <Enter> to exit without loading. The defaults set by BIOS are the optimized performance parameters for the system, to improve the performance of your system components. However, if the optimized performance parameters are not supported by your hardware devices, it will likely cause system reliability and stability issues. If you only want to load the optimized default for a single option, select the desired option and press the <F7> key.

Set Password

When you select the Set Password option, the following message will appear in the center of the screen, which will help you to set the password:

Enter Password:

Enter your password, not exceeding 8 characters, then press <Enter>. The password you enter will replace any previous password. When prompted, key in the new password and press <Enter>.

If you do not want to set a password, just press <Enter> when prompted to enter a password, and in the screen the following message will appear. If no password is keyed in, any user can enter the system and view/modify the CMOS settings.

Password Disabled!!!

Press any key to continue ...

Under the menu “Advanced BIOS Features Setup”, if you select “System” from the Security Option, you will be prompted to enter a password once the system is started or whenever you want to enter the CMOS setting program. If the incorrect password is entered, you will not be permitted to continue.

Under the menu “Advanced BIOS Features Setup”, if you select “Setup” from the Security Option, you will be prompted to enter a password only when you enter the CMOS setting program.

Save & Exit Setup

When you select this option and press <Enter>, the following message will appear in the center of the screen:

SAVE to CMOS and EXIT (Y/N)?Y

Press <Y> to save your changes in CMOS and exit the program; press <N> or <ESC> to return to the main menu.

Exit Without Saving

If you select this option and press <Enter>, the following message will appear in the center of the screen:

Quit Without Saving (Y/N)?N

Press <Y> to exit CMOS without saving your modifications; press <N> or <ESC> to return to the main menu.

Chapter 4

The utility CD that came with the motherboard contains useful software and several utility drivers that enhance the motherboard features.

This chapter includes the following information:

- ❖ Utility CD content
- ❖ Start to install drivers
 - Install IDE Driver
 - Install AGP Driver
 - Install VGA Driver
 - Install Direct X
 - Install USB2.0 Driver
 - Using 4-/6-Channel Audio
 - Install LAN Driver
- ❖ Install Norton Internet Security 2004

Utility CD content

This motherboard comes with one Utility CD. To begin using the CD, simply insert the CD into your CD-ROM drive. The CD will automatically displays the main menu screen.

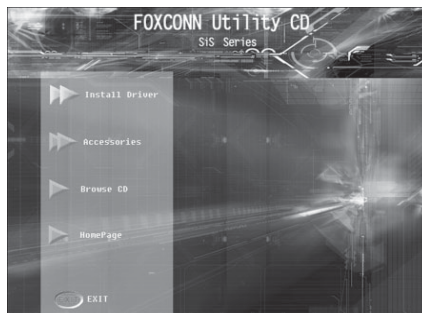

1. Install Driver

Using this choice, you can install all the drivers for your motherboard. You should install the drivers in order and you need to restart your computer after the drivers all installed.

- A. IDE Driver
- B. AGP Driver
- C. VGA Driver
- D. Direct X
- E. USB 2.0 Driver
- F. Audio Driver
- G. LAN Driver

2. Accessories

Use this option to install additional software programs.

- A. SuperUtility
- B. Adobe Reader
- C. Norton Internet Security 2004

3. Browse CD

Click here to browse CD content.

4. Homepage

Click here to visit Foxconn motherboard homepage.

Note:

1. Install the latest patch first if your OS is Windows XP or Windows 2000.
2. Follow the CD screen order to install your motherboard drivers.

Start to Install drivers

Select <Install Driver>, and click to enter the install driver screen. You can select the driver that you want to install and begin the setup steps.

Note:

The following setup steps are based on Windows XP environment. There may be some differences with other operating systems.

Install IDE Driver

Click <Install Driver> from the main menu and enter the install driver menu (as shown in fig. 1). Click <IDE Driver> to start the installation.

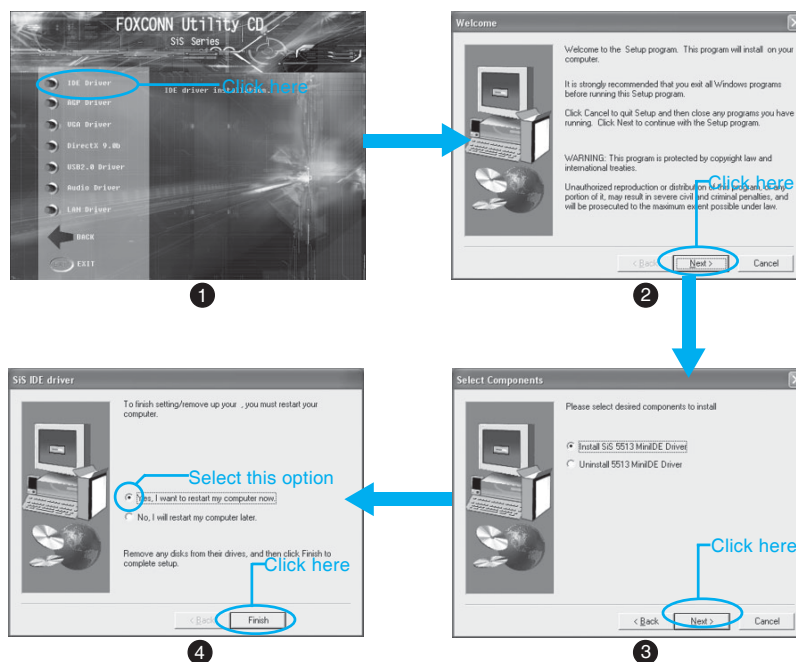

Install AGP Driver

Click <Install Driver> from the main menu and enter the install driver menu (as shown in fig. 1). Click <AGP Driver> to start the installation.

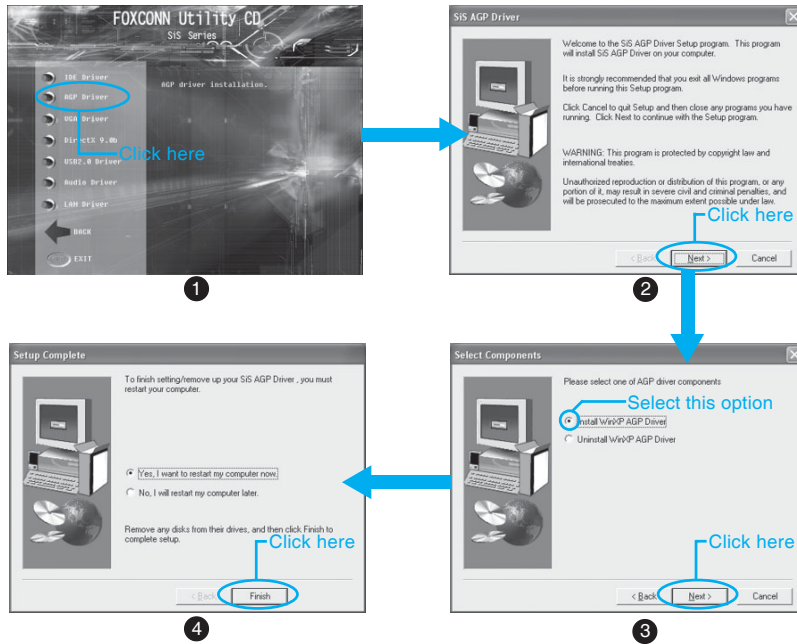

Install VGA Driver

Click <Install Driver> from the main menu and enter the install driver menu (as shown in fig. 1). Click <VGA Driver> to start the installation.

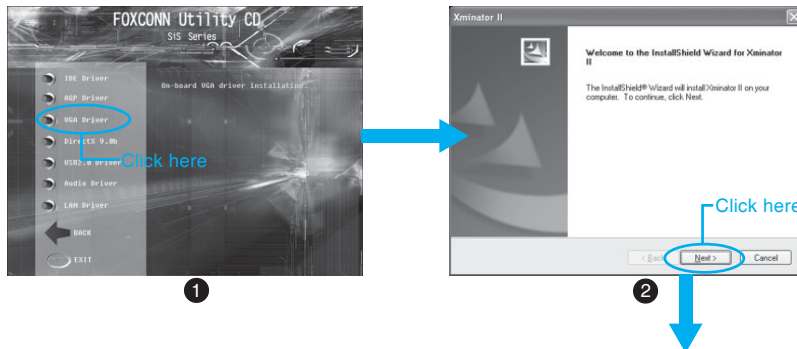

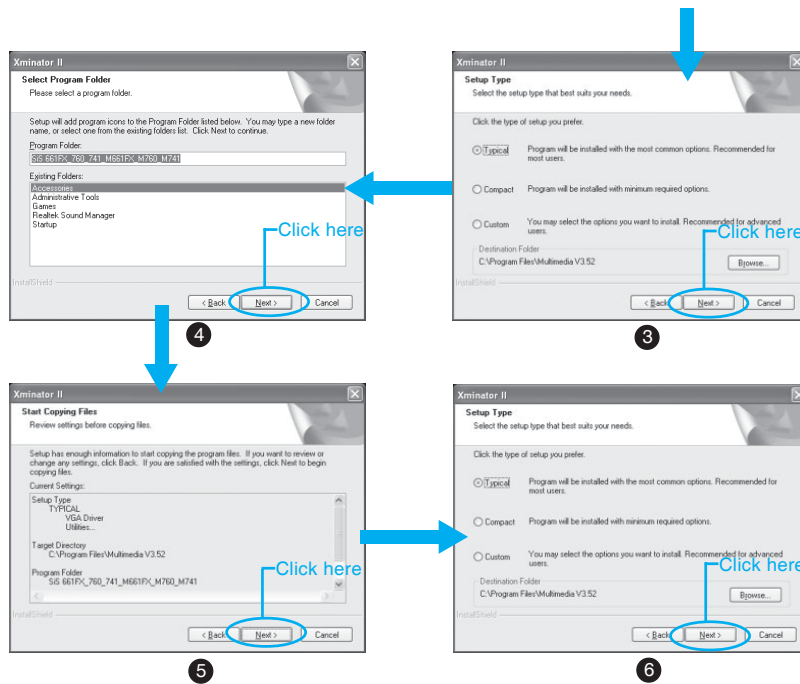

Install DirectX

Click <Install Driver> from the main menu and enter the install driver menu (as shown in fig. 1). Click <DirectX> to start the installation.

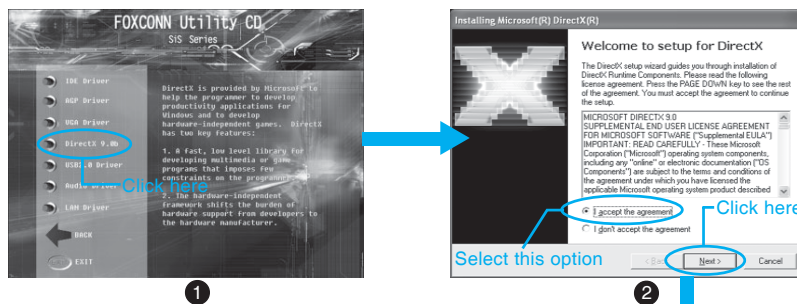

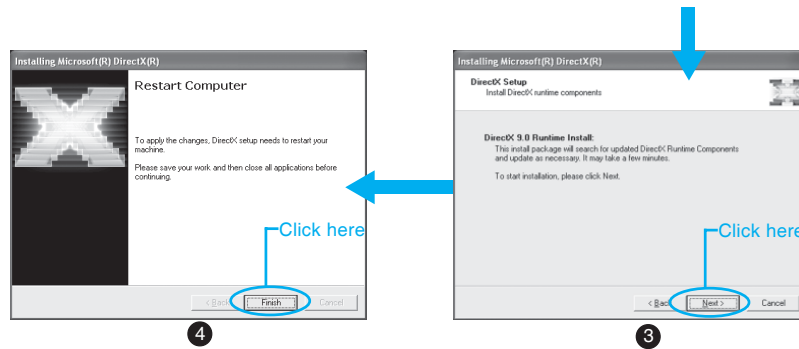

Install USB 2.0 Driver

Click <Install Driver> from the main menu and enter the install driver menu (as shown in fig. 1). Click <USB 2.0 Driver> to open the USB 2.0 setup guide. Please read the guide carefully and select the relevant installation method. If you want to know further information, please visit our website: www.foxconnchannel.com.

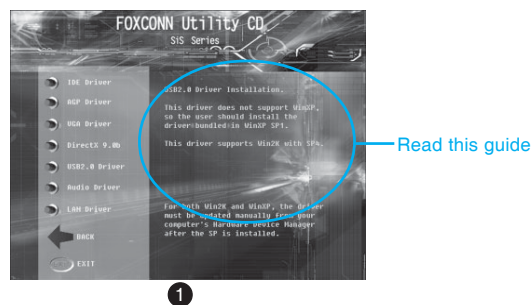

Using 4-/6-Channel Audio

The motherboard is equipped with the Realtek ALC655 chip, which provides support for 6-Channel audio output, including 2 front, 2 rear, 1 center and 1 subwoofer channel. ALC655 allows the board to attach 4 or 6 speakers for a better surround sound effect. This section will tell you how to install and use the 4-/6-Channel audio function on the board.

Installing the Audio Driver

You need to install the driver for the Realtek ALC655 chip before you can use the 4-/6-Channel audio function. Follow the procedures described below to install the drivers for different operating systems.

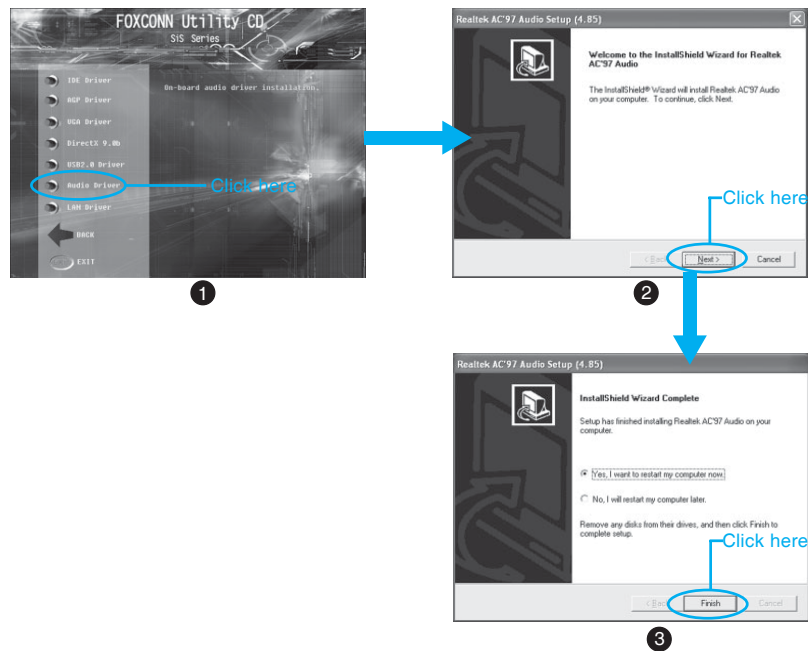

Attaching Speakers

To perform multichannel audio operation, connect multiple speakers to the system. You should connect the same number of speakers as the audio channels you will select in the software utility.

2-Channel Analog Audio Output

The audio connectors on the rear panel already provide 2-Channel analog audio output. The rear panel's audio connectors can be transformed to 4-/6-Channel analog audio connectors automatically when you select the correct setting in the software utility. For information about the setting, refer to Selecting 4- or 6-Channel setting later in this section.

Make sure all speakers are connected to Line-out connectors. Diverse connector configurations for 2-, 4- and 6-Channel using rear panel connectors are described below:

2-Channel Analog Audio Output

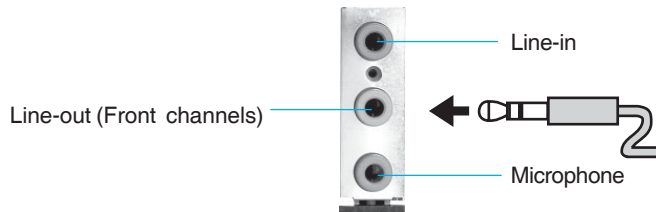

Description: Line-out, Line-in and Microphone functions all exist under 2-Channel configuration.

4-Channel Analog Audio Output

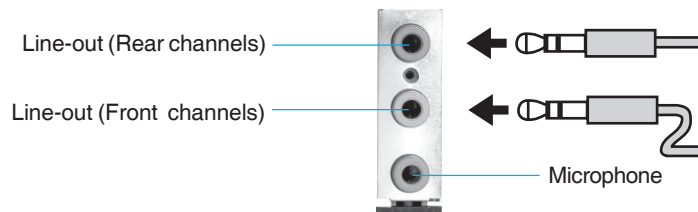

Description: Line-in is converted to Line-out under the 4-Channel configuration.

6-Channel Analog Audio Output

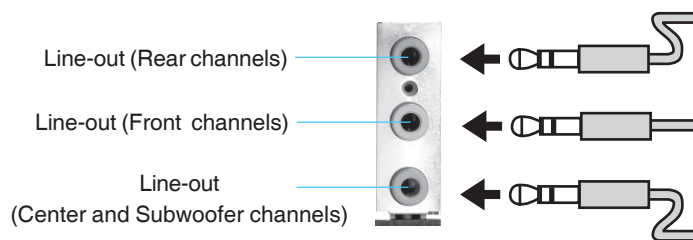

Description: Both Line-in and Microphone are converted to Line-out under the 6-channel configuration.

Digital Audio Output

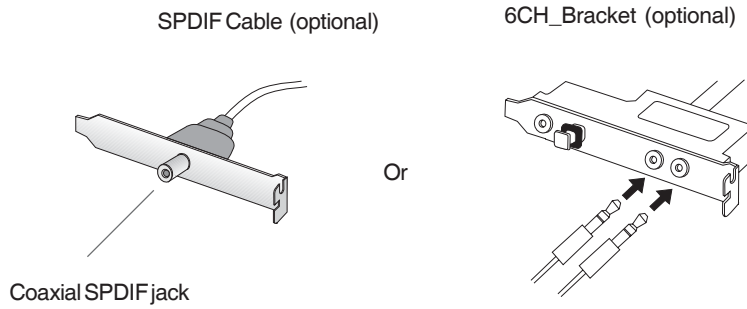

Description: Connect the SPDIF speakers to the Coaxial SPDIF jack.

Selecting 4- or 6-Channel Setting

1. Click the audio icon  from the Windows tray bar at the bottom of the screen.
2. Select any surround sound effect you prefer from the “Environment” pull-down menu under the **Sound Effect** tab.

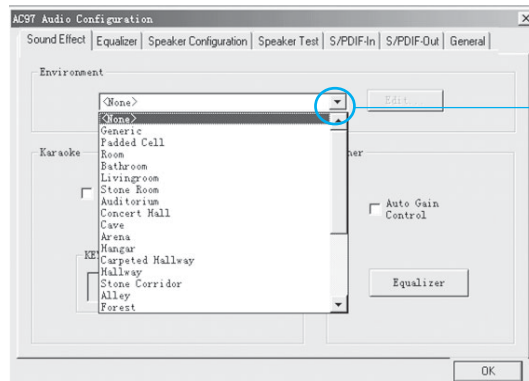

Click here and the pull-down menu will appear.

3. Click the **Speaker Configuration** tab.

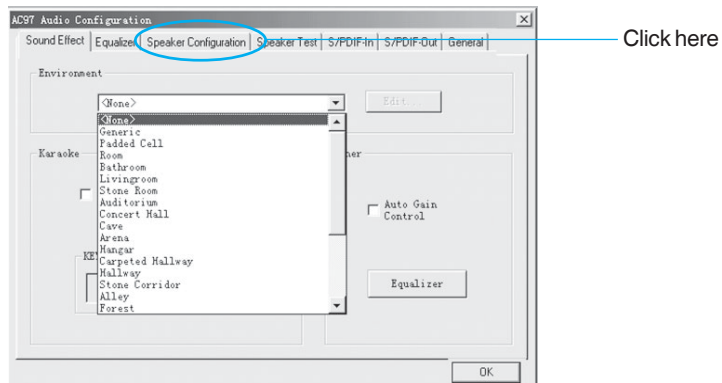

4. The following window appears.

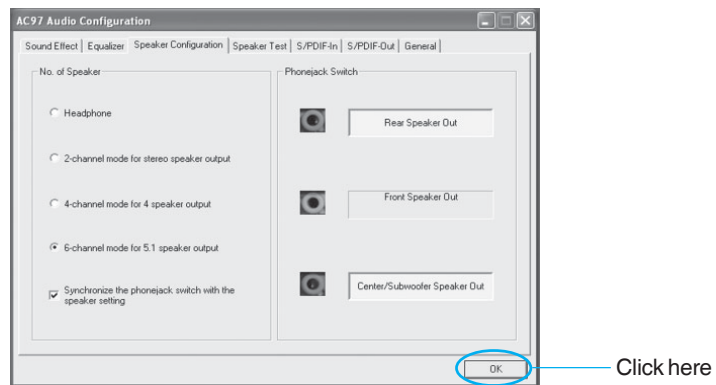

5. Select the multi-Channel operation you prefer from **No. of Speaker**.

6. Click **OK**.

Testing the Connected Speakers

To ensure 4- or 6-Channel audio operation works properly, you may need to test each connected speaker to make sure every speaker works properly. If any speaker fails to sound, then check whether the cable is inserted firmly to the connector or replace the bad speakers with good ones.

Testing Each Speaker

1. Click the audio icon  from the window tray bar at the bottom of the screen.
2. Click the **Speaker Test** tab.
3. The following window appears.

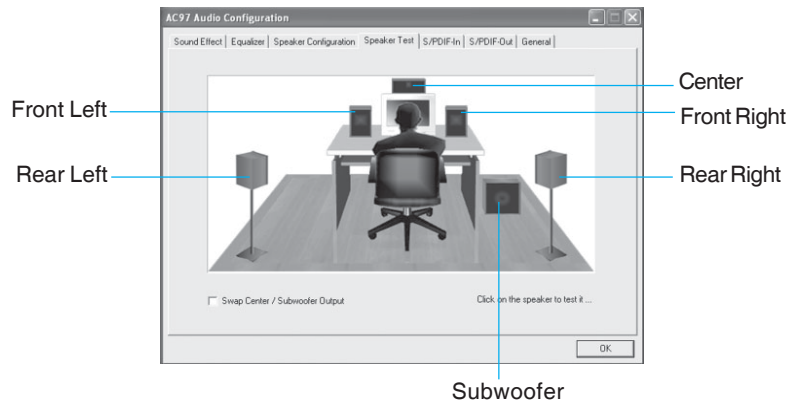

4. Select the speaker which you want to test by clicking on it.

Playing Karaoke

The Karaoke function will automatically remove human voice (lyrics) and leave melody for you to sing the song. **The function can only be used with the 2-Channel audio configuration**, so make sure “2 channels mode” is selected in the “No. of Speakers” column before playing Karaoke.

Playing Karaoke

1. Click the audio icon  from the window tray at the bottom of the screen.
2. Make sure the **Sound Effect** tab is selected.
3. Select **Voice Cancellation** in the “Karaoke” column.

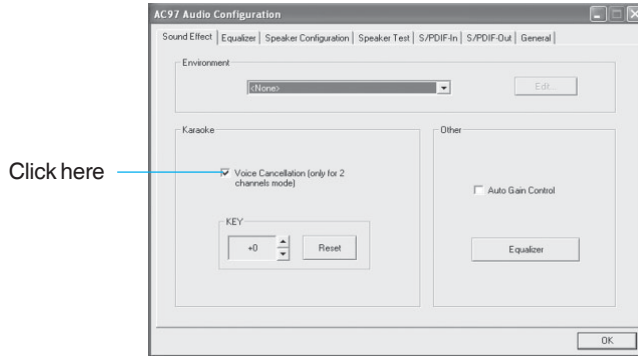

4. Click **OK**.

Install LAN Driver

Click <Install Driver> from the main menu and enter the install driver menu (as shown in fig. 1). Click <LAN Driver> to start the installation.

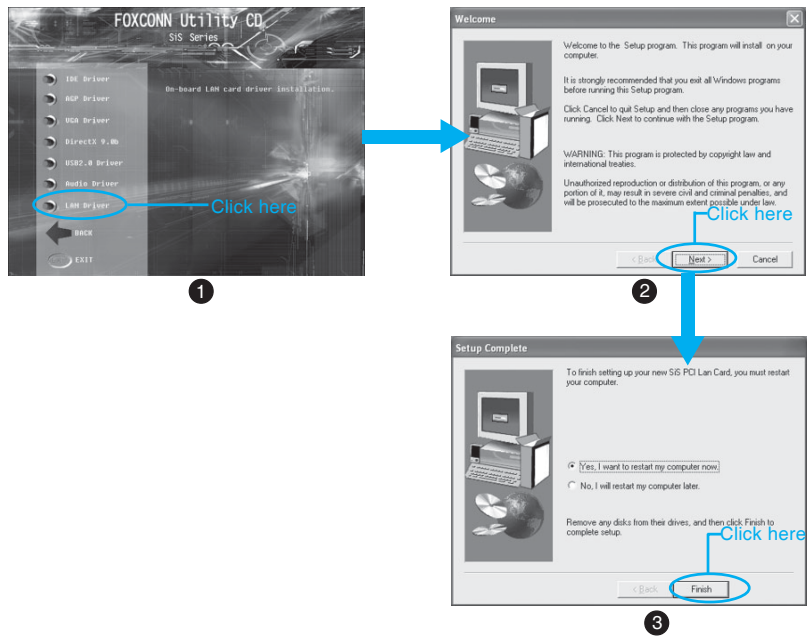

Install Norton Internet Security 2004

From the main menu, select <Accessories> (as shown in following fig. 1). Click <Norton Internet Security 2004> to start the setup.

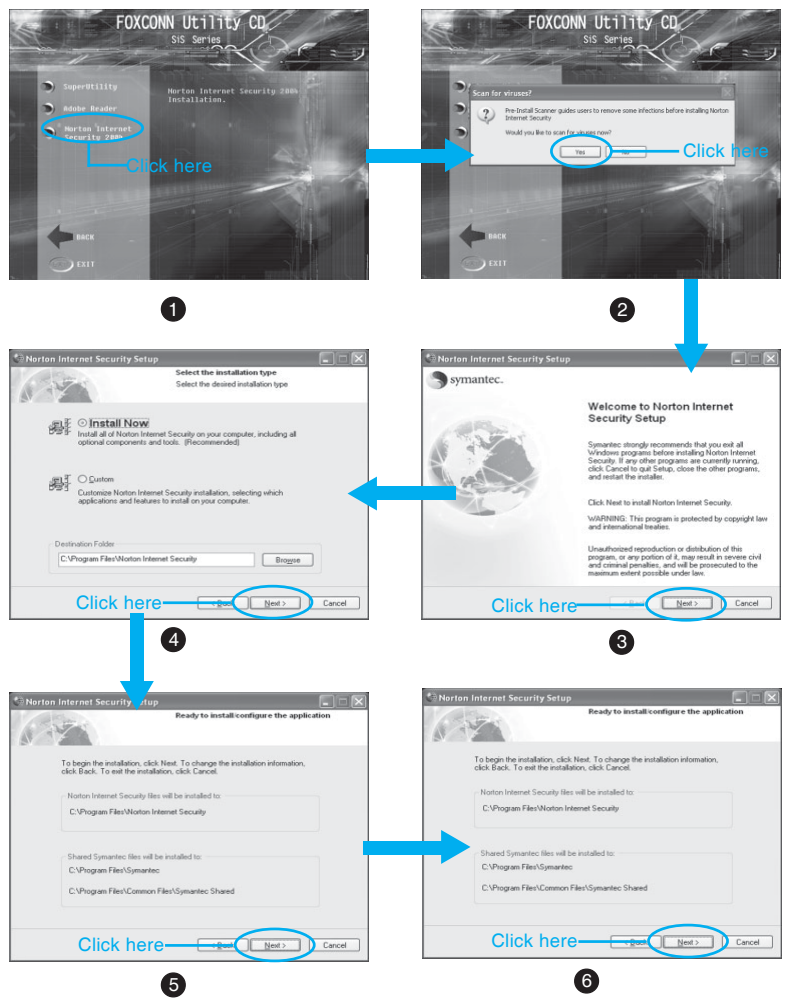

Note:

If your system is Windows 98 or Window ME, please make sure that your Internet Explorer version is 5.01 with service pack 2 or higher.

Chapter 5

This chapter will introduce how to use attached software.

This chapter provides the following information:

- ❖ SuperStep
- ❖ SuperLogo
- ❖ SuperUpdate

SuperStep

SuperStep is a utility that allows users to change the frequency of the CPU. It also displays system health information including CPU temperature, CPU voltage, and PCI/AGP clock.

SuperStep features:

1. Supports Win98SE, WinME, Win2000 and WinXP.
2. Automatic alarm mechanism when system runs irregularly.
3. Adjusts the CPU frequency to speed up your system and achieve better system performance.
4. Simple and easy to operate, with a user-friendly graphics interface.

Using SuperStep:

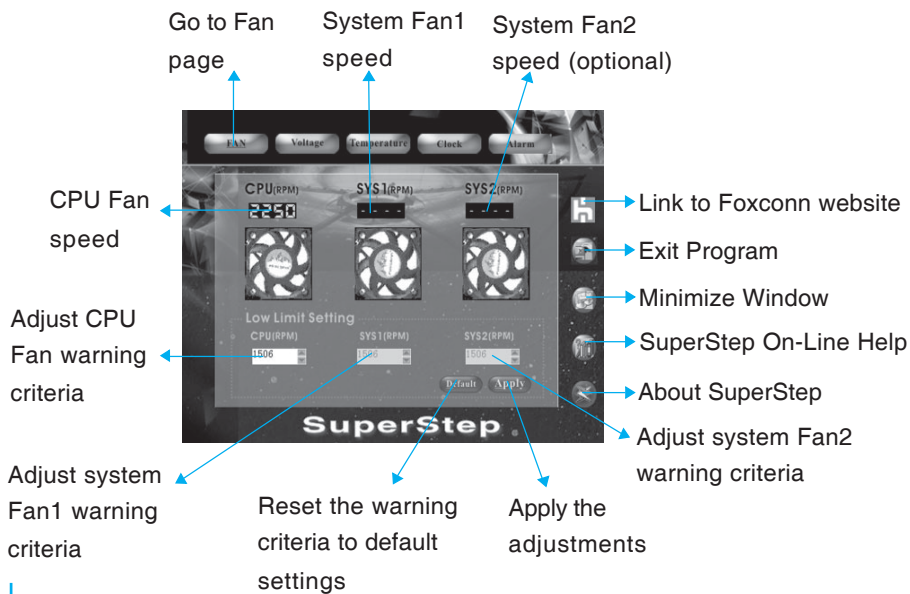

Go to Voltage page

Adjust voltage warning criteria (upper limit)

Current voltage readings

	Value (V)	High (V)	Low (V)
V Core A:	1.45	1.792	1.200
V Core B:	1.48	1.792	1.200
+3.3V:	3.34	3.952	2.624
+5V:	4.89	5.994	4.005
-12V:	12.28	13.194	10.822
-12V:	11.95	-10.800	-13.264
-5V:	-	0.000	0.000
5VSB:	5.11	6.012	4.000
VBAT:	3.26	3.952	2.624

Reset the warning criteria to default

Apply the adjustments

Adjust voltage warning criteria (lower limit)

Go to Temperature page

Current CPU temperature

Current system temperature

Adjust CPU temperature warning criteria

Adjust system temperature warning criteria

Reset the warning criteria to default

Apply the adjustments

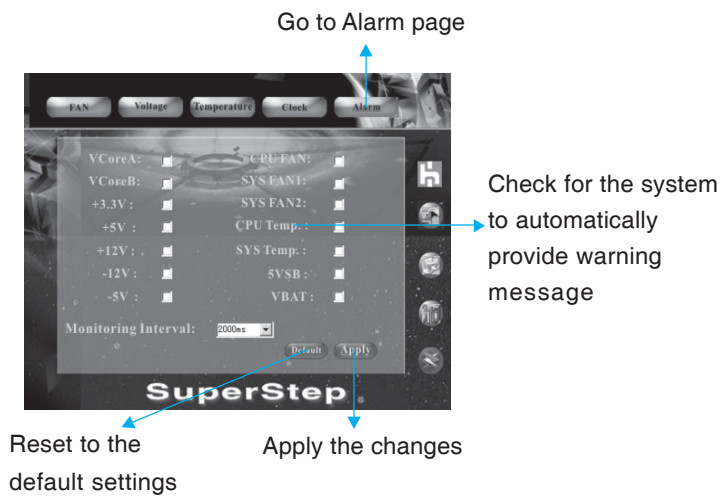
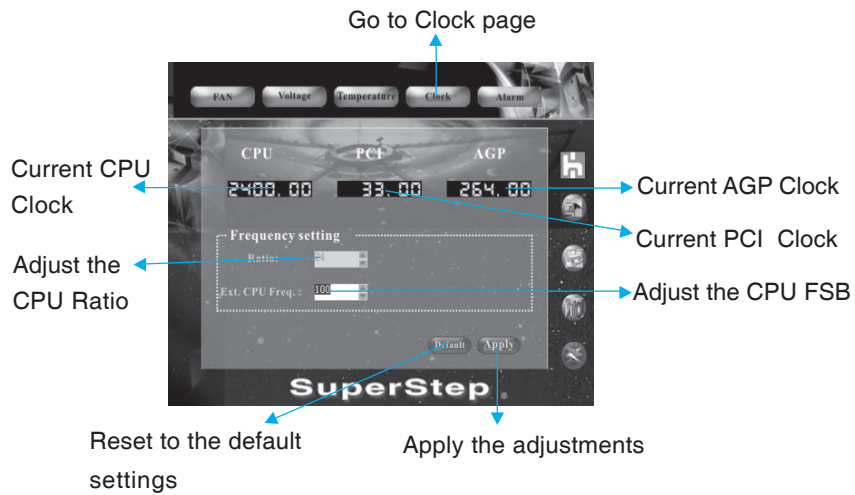

SuperLogo

SuperLogo is a Windows utility that allows users to change the BIOS sign on logo. The utility is able to replace and backup the BIOS logo, and update and backup the BIOS image within the Windows environment.

SuperLogo features:

1. Supports Win2000 and WinXP.
2. Supports 2Mb and 4Mb size flash parts, flash write method is independent with flash type.
3. Simple and easy to operate, with a user-friendly graphics interface.
4. Supports BMP and JPEG graphic format files. The best color is 16 or 256 colors. The best resolution is 136x84 for top-right logo and 640x480 or 800x600 for full screen logo.

Using SuperLogo:

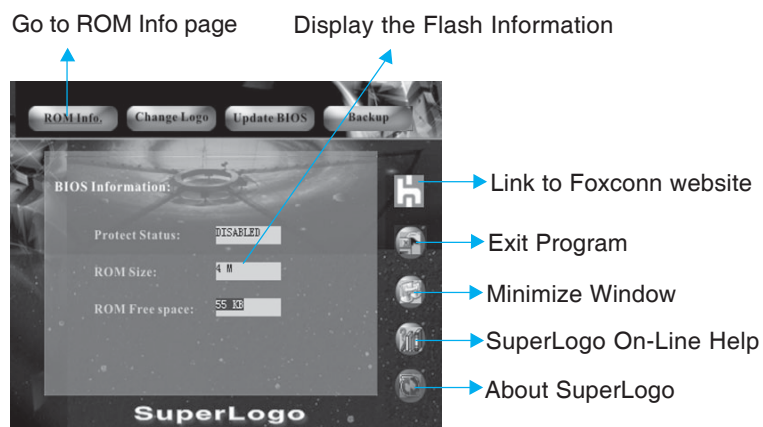

Go to Change Logo page

Full screen mode

Top-Right mode

Boot without logo

Follow the Wizard to complete the logo update

Go to Update BIOS page

BIOS image file location

Browse a BIN file for updating BIOS

Follow the Wizard to complete the BIOS function

Go to Backup page

Backup whole BIOS image

Backup Logo

Follow the Wizard to complete the backup function

SuperUpdate



SuperUpdate is a Windows utility that allows users to backup and upgrade the system BIOS from local or internet.

SuperUpdate features:

1. Supports Win2000 and WinXP.
2. Supports 2Mb and 4Mb size flash parts; flash write method is independent of flash type.
3. Simple and easy to operate, with a user-friendly graphics interface.

Using SuperUpdate:

The screenshot shows the SuperUpdate application window. It has a dark background with white text. At the top, it says 'SuperUpdate'. Below that, there are two columns of fields: 'Current BIOS Info.' and 'New BIOS File Info.'. The 'Current BIOS Info.' fields include Product (661M03), Version (01), Date (11/14/03), Image Size (4M), and Flash Part (S31_305F040/2V). The 'New BIOS File Info.' fields include File Name and File Size. There are 'Load' and 'Update' buttons between these columns. Below the fields is a 'Progress' section with three progress bars for 'Erasing', 'Programming', and 'Verifying', each with a percentage indicator. At the bottom, there is a 'Backup' button and a 'Live Update' button. On the right side of the window, there are several icons: a globe, a power button, a window icon, a question mark, and a document icon. Arrows point from these icons to labels: 'Link to Foxconn website', 'Exit Program', 'Minimize Window', 'SuperUpdate On-Line Help', and 'About SuperUpdate'. Other arrows point from text labels to specific parts of the interface: 'Browse BIOS bin file from local HDD' points to the 'Flash Part' field; 'Perform the BIOS update from local image' points to the 'Update' button; 'Upgrading BIOS via internet automatically' points to the 'Live Update' button; and 'Backup system BIOS to an image file' points to the 'Backup' button.

Backup BIOS to local image:

1. Click <Backup> to backup current BIOS file.

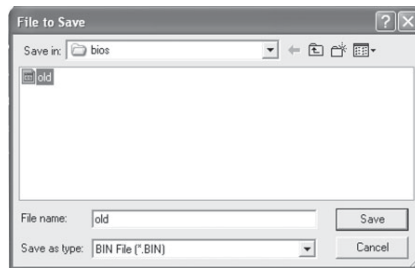

2. Click <OK> to finish the backup process.

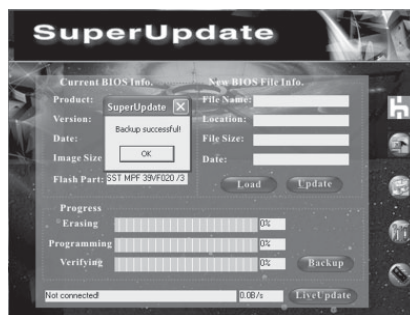

Update BIOS from local image:

1. Click <Load> to load a new BIOS file.



2. Click <Update>, the following message will appear.

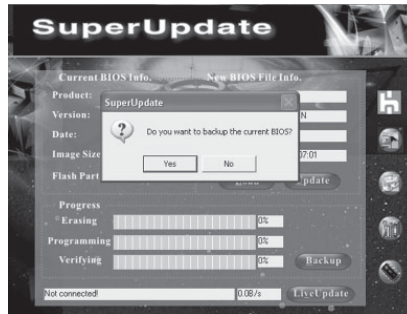

3. Click <Yes> to backup the current BIOS, then start to update the BIOS.

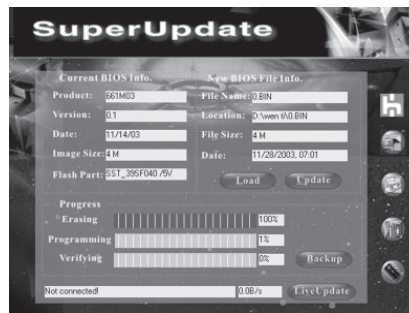

4. Click <Restart >to finish the update process.

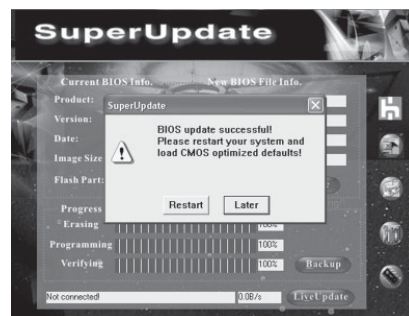

Update BIOS On-line:

1. Click <Liveupdate> to automatically update the BIOS from the internet.

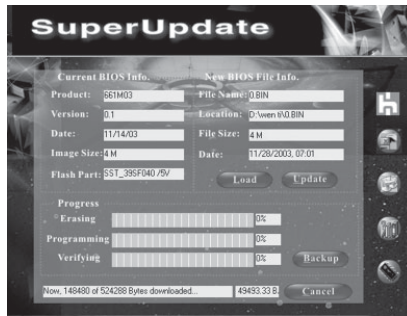

2. Click <Yes> to backup the current BIOS.

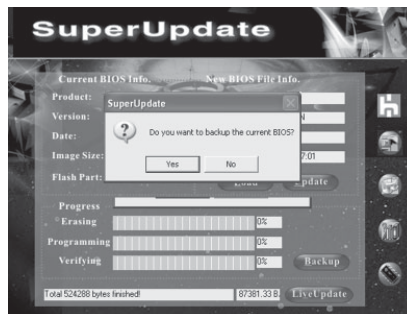

3. Click <OK> to update BIOS.

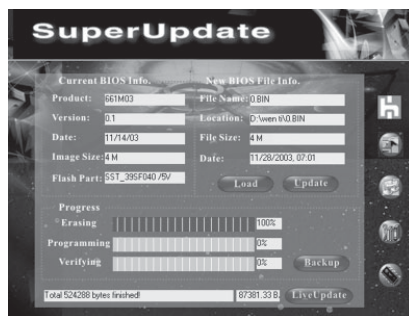
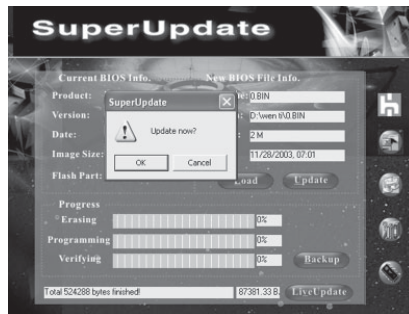

4. Click <Restart >.

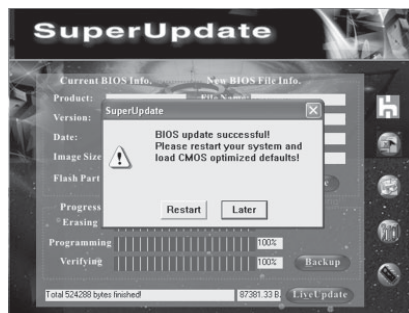

Chapter 6

This chapter will introduce special functions of BIOS and how to use them in detail. It can further exert the max potential of motherboard to bring you super-value enjoyment.

This chapter introduces the following special functions of BIOS:

- ❖ SuperSpeed
- ❖ SuperBIOS-Protect
- ❖ SuperBoot
- ❖ SuperRecovery

SuperSpeed

SuperSpeed is a powerful and efficient Easy Technology for PC DIY fans. It offers a friendly interface. Users can set the CPU Clock easily in the BIOS setup.

Procedures:

1. Correctly install your CPU.
2. Plug in other configurations and restore the system.
3. Switch on power to the system and press the key to enter BIOS Setup.
4. Enter the <BIOS Features> menu to set the CPU clock.
5. Save and exit BIOS Setup; your system will now boot successfully.

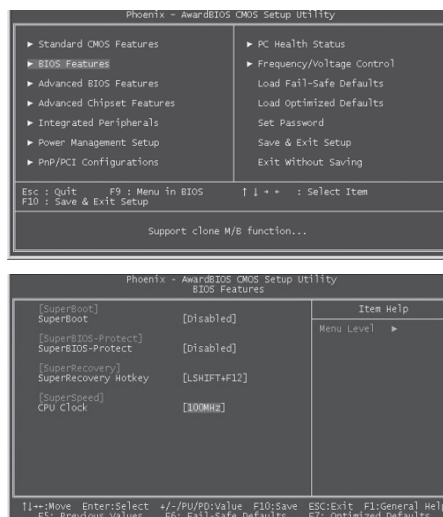

BIOS provides you a set of basic values for your processor selection instead of the jumper settings. The processor speed can be manually set from the <BIOS Features> menu screen.

Warning:

Be sure your selection is right. CPU over speed can be dangerous! We will not be responsible for any damages caused.

SuperBoot

SuperBoot technology greatly reduces the long boot process time of computers. A BIOS without SuperBoot has to perform many routines every time when the system starts, such as checking the system core and initializing system peripherals. Now with SuperBoot, a PC can boot up without any unnecessary. SuperBoot is quite easy to use: choose the right option in CMOS setup (refer to BIOS features), SuperBoot saves the information when the PC boots up at the first time and restores the parameters for the system, thus letting the PC boot freely and rapidly.

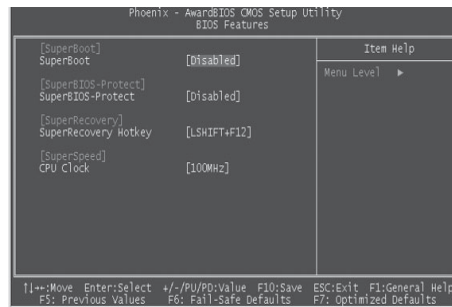
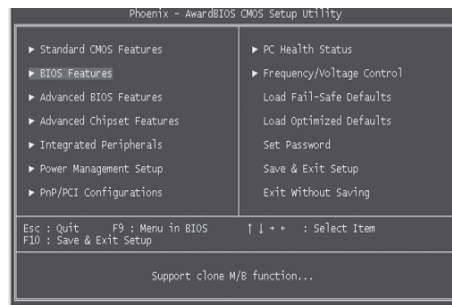

Notes:

1. If the previous boot was not completed then the BIOS will perform a normal POST, even if SuperBoot is enabled.
2. No matter whether SuperBoot is enabled or not, the BIOS will perform a normal POST if the CMOS fails.

SuperBIOS-Protect



The BIOS of the motherboard is contained inside the Flash ROM. Severe viruses, such as the CIH virus, are so dangerous that they may overwrite the BIOS. If the BIOS has been damaged, the system will be unable to boot. We provide the following solution which protects the system BIOS from being attacked by such viruses.

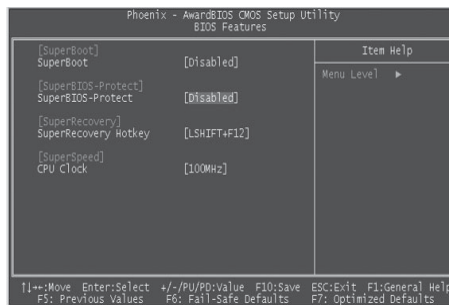
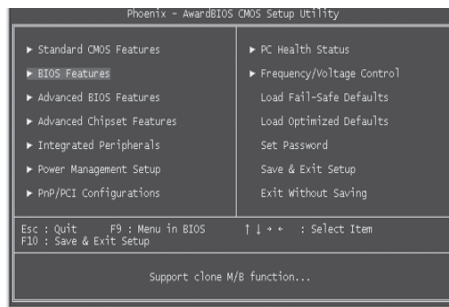

There are two ways to implement this function:

1. Set the jumper (FWH_EN) to disable; the flash ROM cannot be overwritten.
2. Set the jumper (FWH_EN) to enable and enable “SuperBIOS-Protect” in the CMOS section of BIOS Features. In this way, the BIOS cannot be overwritten, but the DMI information can be updated.

Note: FWH_EN default is enable.

SuperRecovery



SuperRecovery is an easy-to-operate tool for backing up or recovering your hard disk data. It offers simplified user interfaces with hotkey access and allows you to experience unprecedented high security and reliability with extra functions, such as hotkey launch, and powerful anti-virus protection.

Features:

1. Password Protection:

You can set a password for each HDD.

2. Data Protection:

Hidden partitions can only be accessed during data back up or recovery. Even reformatting the disk using FDISK or PQMAGIC will not allow access to the disk. This means that data backed up in a hidden partition is very secure.

3. Intelligent Menu:

Unavailable items will be displayed in gray. For example, if you haven't divided a hidden partition, items like "Release Hidden Partition", "Back up" and "Recovery" will be displayed in gray and can't be selected. And, when you select an item, the related information will appear on the bottom of the screen.

Disclaimer:

Please study this software program's specification carefully before using it. The vendor shall not be liable for any damages arising out of or in connection with the use of this program, including liability for lost profit or data, or any other damages whatsoever.

System Requirements:

1. ATA5 or above compliant IDE HDD;
2. FAT16, FAT32, NTFS files system;
3. PS/2 keyboard or USB keyboard.

Hotkey Selection:

You should enter the CMOS set up interface first by pressing during POST (Power On Self Test). Then select the "SuperRecovery Hotkey" option to adjust the hotkey settings in the "BIOS Features" menu.

There are 12 options: LSHIFT (Left Shift)+F1~F12. LSHIFT+F12 is the default.

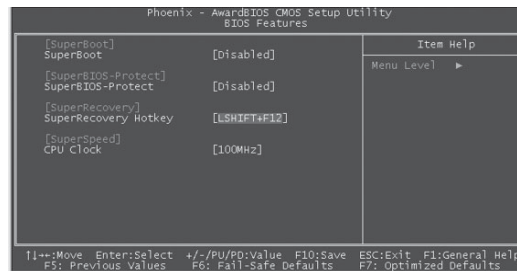

Hard Disk Selection:

The hard disk selection menu will be displayed after you press the hotkey, listing all the IDE HDDs installed in your system. You can switch the highlight bar to make a selection and press <Enter> to confirm it.

Attention:

1. Make sure that you have selected a HDD before entering the main menu.
2. Make sure that the HDD you selected is ATA5 or higher. For HDDs lower than ATA5, there will be a “No Support” message in the HDD list menu listing beside the name of it.
3. Only one HDD can be operated at a time;

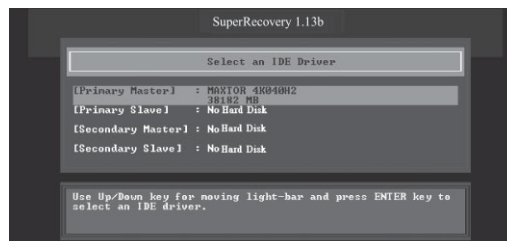

4. If you have assigned a password to the selected HDD, you will be prompted to provide it before proceeding.

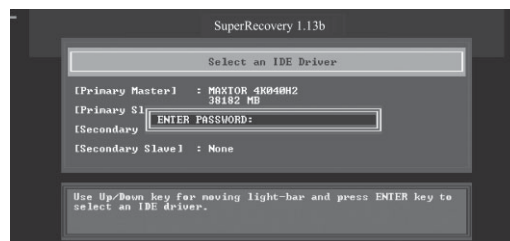

Main Menu:

Select a HDD to enter main menu. There are five function items, “Divide Hidden Partition”, “Release Hidden Partition”, “Backup”, “Recovery” and “Change Password”. You can switch the highlight bar to make a selection on the operation which should be performed on the HDD and confirm your selection by pressing <Enter>. The following operation will be performed on the disk you selected.



Divide Hidden Partition:

1. What is a Hidden Partition?

SuperRecovery can be used to divide a hidden partition, which is to be reserved for backing up HDD data. The partitioning will erase all the old data saved in the HDD, to make sure that the following operations can be continued. Once the division is done, any future variation to the HDD will never affect the hidden partition, such as virus, causing turbulence, windows system breaking down or data loss. SuperRecovery can recover all the data backed up in hidden partition, letting you easily get your computer on track again.

2. Divide Hidden Partition:

- A. Enter a percentage of the HDD total capacity or an actual size in MB as the size of the hidden partition, such as “30%” or “3000”. Press <Enter> to confirm your input. As the average rate of compression is 50% or so, you are suggested to divide 30% of the total as the capacity of the hidden partition;
- B. The system will then prompt you to Enter <Y> or <N> for confirmation. Press <Y> to restart the computer, and the division for hidden partition will go into effect after the system is restarted.

Attention :

1. All the HDD data will be cleared by the partitioning process, so it is better to do the division on an empty HDD.
2. At the same time, the overall HDD capacity will decrease in order to make space for the hidden partition, which will be come unavailable for normal use.

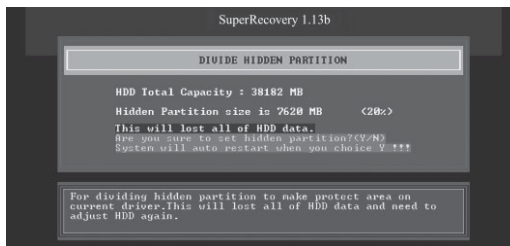
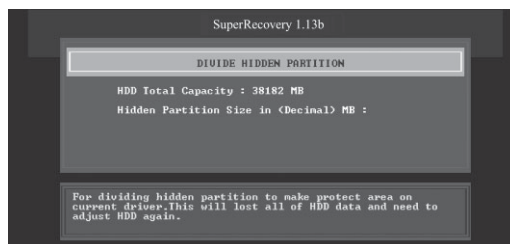

Release Hidden Partition:

This is used to release the hidden partition. If you choose this option and press <Y> to confirm, the system will be restarted to release the hidden partition. But the released partition is still unavailable for you after the system is restarted. It's necessary for you to enable it by using FDISK, PQMAGIC, or some other tools.

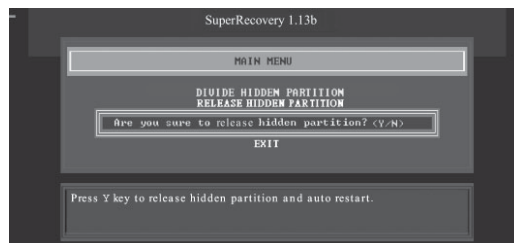

Backup:

Select BACKUP to enter the Backup interface, where you can find the following three sub-function items: "BACKUP CMOS SETUP", "BACKUP PARTITION TABLE" and "BACKUP HARDDISK DATA". Switch the highlight bar by pressing the arrow keys to make a selection and then press <Enter> to confirm your choice.

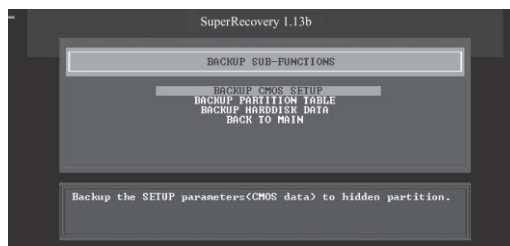

1. Backup CMOS Setup:

- A. Support backing up of the CMOS data.
- B. The backing up or recovery of CMOS data should be done on a motherboard of the same type.

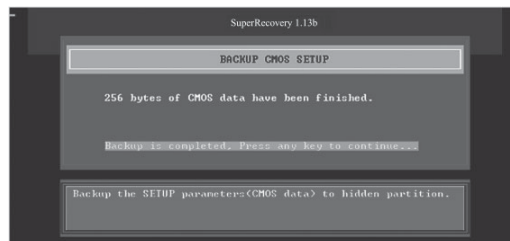

2. Backup Partition Table:

This function can help to backup all partition tables including extended partitions.

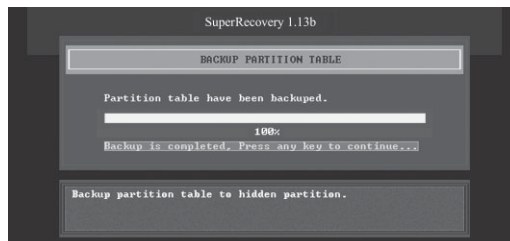

3. Backup Hard disk Data:

A. If there are active partitions (system partition), you can choose to backup an active partition or the whole disk. But only one can be taken between the two choices. Old data will be replaced by the newly backed up data.

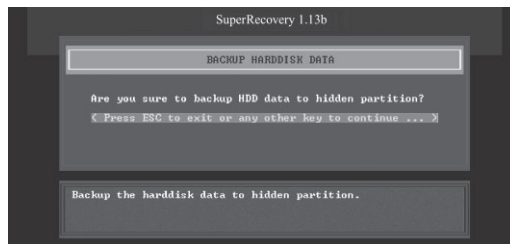
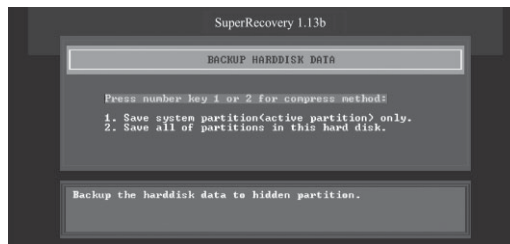

B. Backing up with the progress bar showing.

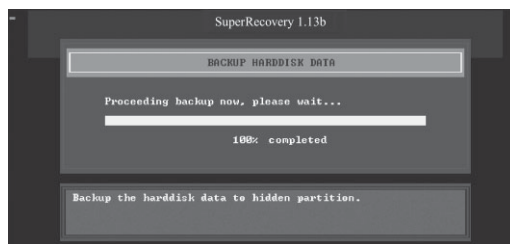

C. A report with all the critical data on this operation will be displayed after the backup is completed.

- Original Size: The data size loaded in selected partition;
- Valid Size: The size of valid data.
- Elapsed Time: How long the procession cost.
- Compressed Size: The size of data after compression.
- Compressed Rate: Compressed Size/Valid Size.

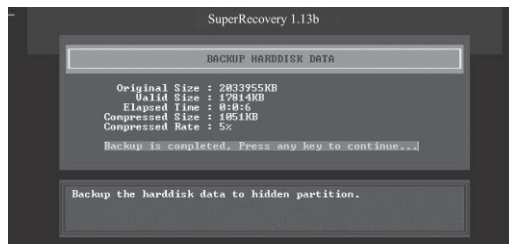

4. Back to Main:

This option is used to exit the Backup interface.

Recovery:

Select RECOVERY to enter the Recovery interface. You will see the following sub-function items: RECOVER CMOS SETUP, RECOVER PARTITION TABLE and RECOVER HARDDISK DATA. You can switch the highlight bar by pressing the arrow keys to make a selection and press <Enter> to confirm your selection.

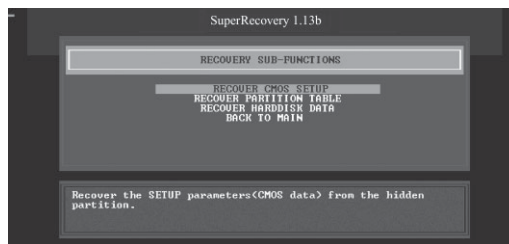

1. Recover CMOS Setup:

This function is used to restore the latest backup of CMOS settings you made.

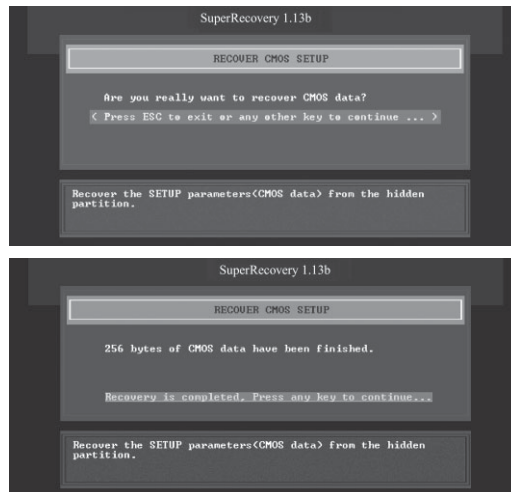

2. Recover Partition Table:

This function is used to recover all partition tables including extended partitions.

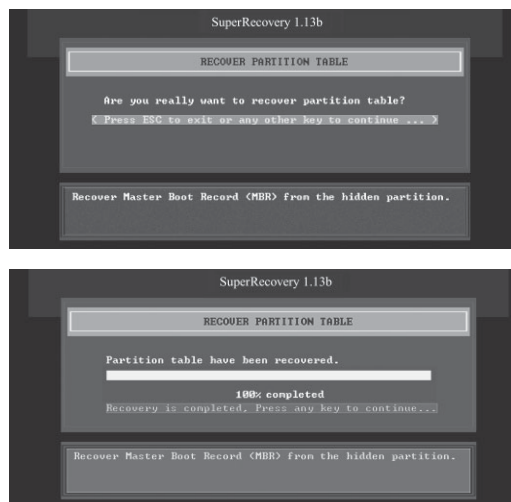

3. Recover Hard disk Data:

This option is used to restore the backed up data from the hidden partition.



4. Back to Main:

This option is used to exit the Recovery interface.

CHANGE PASSWORD Introduction:

Select CHANGE PASSWORD to enter the Change Password interface.

- A. Enter the old password first. Press <Enter> if password is null.
- B. Enter the new password. Then enter the same again to confirm it.
- C. Press <Enter> for null password.
- D. The password will be saved in the hidden partition.

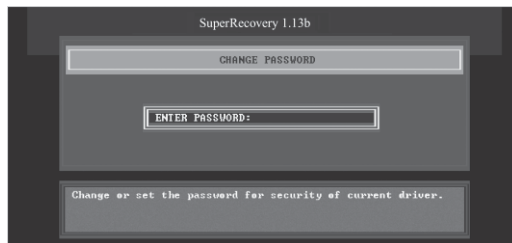

Free Manuals Download Website

<http://myh66.com>

<http://usermanuals.us>

<http://www.somanuals.com>

<http://www.4manuals.cc>

<http://www.manual-lib.com>

<http://www.404manual.com>

<http://www.luxmanual.com>

<http://aubethermostatmanual.com>

Golf course search by state

<http://golfingnear.com>

Email search by domain

<http://emailbydomain.com>

Auto manuals search

<http://auto.somanuals.com>

TV manuals search

<http://tv.somanuals.com>