

First Alert®

RECORDING
wired
CAMERA SYSTEM

7 in

**7" LCD with
built-in DVR**

USER'S MANUAL

Model

HS-4705-400 4 Channels/4 Cameras

H.264

**advanced video
compression**



**mobile phone/
web ready**

500GB

500GB DVR



night vision



**indoor/outdoor
400 TVL cameras**



First Alert®

WELCOME

Thank you for choosing First Alert for your security needs!

For more than half a century, First Alert has made the home-safety and security products that make your job easier. Our products are built to the highest standard which has earned us a leadership role in the home-safety and security product categories. We are committed to serving our customers, from the professionals who install our products, to the families and businesses who count on them. First Alert has been helping families and businesses stay safe for over 50 years. By having a First Alert Security System, you're taking the first step in protecting your home or business from damage or theft. We're watching, even when you're not.

This manual is written for the HS-4705-400 DVR. It was accurate at the time it was completed. However, because of our ongoing effort to constantly improve our products, additional features and functions may have been added since that time and on-screen displays may change. We encourage you to visit our website at www.brkelectronics.com to check for the latest manuals (English and Spanish), firmware updates, downloads, other security camera products and announcements. You'll find this product line under Products >> Security Cameras >> Wired Cameras.

©2012 BRK Brands, Inc.
a Jarden Corporation company (NYSE:JAH)
www.brkelectronics.com

All rights reserved. Distributed by BRK Brands, Inc. 3901 Liberty Street Road, Aurora, IL 60504-8122. Due to continuing product development, the product inside the packaging may look slightly different than the one on the package.

BRK Brands, Inc. is a subsidiary of Jarden Corporation (NYSE: JAH). To obtain warranty service, contact the Consumer Affairs Division at 1-800-323-9005, Monday through Friday, 7:30 a.m. - 5 p.m., Central Standard Time.

Made in China

MAIN DESCRIPTION

Four channel H.264 digital video recorder with Internet remote surveillance, motion detection, PTZ and alarm control suitable for applications such as high-end residential - new or remodel, light commercial, small business/retail, small warehouse or small grocery.

PRODUCT FEATURES

- H.264 Compression & Virus free Linux O/S
- Real hexaplex operation - simultaneous record, playback, mobile phone live view, backup, control, & remote access
- 500GB SATA hard drive installed
- Supports smart phone live view & E-mail alarm
- Customizable E-mail alerts
- Supports 4-channel D1 (Highest), HD1 (High) or CIF (Normal) Real-time simultaneous recording
- Supports 4-channel simultaneous playback
- User-friendly interface: 16 bit true color, semi-transparent GUI with notes for selected menu items
- Advanced motion detection activated recording
- 24/7 Scheduled Recording
- Network monitoring through internet access
- Supports USB or external DVD backup
- Hi-speed backup/upgrade/record via USB2.0
- PTZ camera control
- CMOS Color 400TVL cameras with 30 IR LED's for up to 50' night vision and IP65 weather rating

| SECTION | DESCRIPTION | PAGE NUMBER |
|--------------------------------|---|-------------|
| 1 | Introduction | 2-3 |
| 2 | Safety | 6 |
| 3 | Product Overview | 7 |
| | What is in the Box | 7 |
| | DVR Controls | |
| | Front Panel | 8 |
| | Back Panel | 9 |
| | Remote Control | 10 |
| | Mouse Controls | 11 |
| | Camera Power Connections | 12 |
| Connecting Devices | 12 | |
| 4 | Initial Setup - System Operation | 13 |
| | System Start Up | 13 |
| | Power On/Off | 13 |
| | User Login | 13 |
| | Live View Screen | 14 |
| | Quick Access Menu | 14 |
| | Main Menu Access | 14 |
| | Password Setup | 15 |
| | Camera Display Setup | 16 |
| | Display | 16 |
| | Video/Audio | 16 |
| Language, Date and Time | 17 | |
| 5 | Basic Operation | 18 |
| | Recording | 18 |
| | Configure Recording Options | 18 |
| | Recording Schedule (Timer Recording) | 18 |
| | Privacy Mask Field | 19 |
| | Motion Detect Setup | 19 |
| | Playback | 20 |
| | Playback and Record Search | 20 |
| | On-Screen Playback Controls | 20 |
| | File List | 20 |
| Backup | 21 | |
| HDD Management | 21 | |

| SECTION | DESCRIPTION | PAGE NUMBER |
|---|--|-------------|
| 6 | Advanced Operation | 22 |
| | Alarm | 22-23 |
| | Alarm Setup | 22-23 |
| | E-mail Setup | 23 |
| | System Info and System Update | 24 |
| | System Maintain | 24 |
| | Upgrade Firmware | 24 |
| | PTZ Setup and Control | 25 |
| | Step 1: Connect your PTZ Camera to this DVR | 25 |
| | Step 2: Configure PTZ Communication Settings | 25 |
| Step 3: Configure the Operation and Control of your PTZ Camera(s) | 25 | |
| Step 4: Configure the CRUISE SETTING of your PTZ Camera | 26 | |
| 7 | Remote Access | 27 |
| | Network Setup for Remote Access | 27 |
| | DHCP (Dynamic Host Configuration Protocol) | 27 |
| | Static IP | 27 |
| | UPnP (Universal Plug and Play) | 28 |
| | PPPoE (Point-to-Point Protocol Over Ethernet) | 28 |
| | DDNS (Dynamic Domain Name Service) | 29-30 |
| | Port Forwarding | 30-32 |
| | Remote Surveillance | 33 |
| | Remote Surveillance using Internet Explorer 8 | 33-34 |
| | Using Remote Surveillance | 34 |
| | Remote Surveillance Main Screen | 35 |
| | Live Viewing Tab | 36 |
| Playback Tab | 37-38 | |
| Setup Tab | 39 | |
| Setting, Maintenance and Host Info Tabs | 40 | |
| 8 | Mobile Phone | 41 |
| | Mobile Setup | 41 |
| | Windows Mobile Pro (6.0 or later) OS Phones | 41-42 |
| | Symbian (S60 3rd or later) OS Phones | 43-44 |
| | Android 1.5 Mobile OS Phones | 45-46 |
| | Apple iPhone on 3G Networks OS Phones | 47 |
| | Blackberry OS 5.0 Phones (Curve 8900, Bold 9700, Tour 9630) | 48-49 |
| 9 | Appendix | 50 |
| | Hard Drive Removal and Installation | 50 |
| | Specifications | 51 |
| | FAQ's (Frequently Asked Questions) | 52-53 |
| | Troubleshooting | 54 |
| | Notes | 55 |

SAFETY PRECAUTIONS

- Do not drop, puncture, or disassemble the cameras or DVR.
- Do not tug on the power adapter. Use the plug to remove it from the wall.
- Do not expose the cameras or DVR to high temperatures.
- For your own safety, avoid using the DVR when there is a storm or lightning in your area.
- Use the cameras and DVR with care. Avoid pressing hard on the cameras or DVR body.
- Do not crush or damage the power cable

FCC COMPLIANCE

FCC Compliance Class B Digital Device

This equipment has been tested and found to comply with the limits for a Class B digital device, pursuant to Part 15 of the FCC rules. These limits are designed to provide reasonable protection against harmful interference in a residential installation. This equipment generates, uses and can radiate radio frequency energy and, if not installed and used in accordance with the instructions, may cause harmful interference to radio communications.

However, there is no guarantee that the interference will not occur in a particular installation. If this equipment does cause harmful interference to radio or television reception, which can be determined by turning the equipment off and on, the user is encouraged to try to correct the interference by one or more of the following measures:

- Reorient or relocate the receiving antenna.
- Increase the separation between the equipment and receiver.
- Connect the equipment into an outlet on a circuit different from that of the receiver.
- Consult the dealer or an experienced radio or TV technician for help.

Notice: Only peripherals complying with FCC class B limits may be attached to this equipment. Operation with non-compliant peripherals or peripherals not recommended by First Alert / BRK Brands, Inc. is likely to result in interference to radio and TV reception. Changes or modifications to the product, not expressly approved by First Alert / BRK Brands, Inc., could void the user's authority to operate the equipment.

Important: The information shown in the FCC Declaration of Conformity paragraph below is a requirement of the FCC and is intended to supply you with information regarding the FCC approval of this device. The phone number listed below is for FCC related questions only and not intended for questions regarding the connection or operation for this device.

FCC Declaration of Conformity for devices with the FCC logo. Responsible Party: First Alert / BRK Brands, Inc., 3901 Liberty Street Rd., Aurora, IL. 60504-8122. Telephone: (630) 851 - 7330. Product / Model: HS-4705-400.

We, First Alert / BRK Brands, Inc. declare under our sole responsibility that the device to which this declaration relates: Complies with Part 15 of the FCC Rules. Operation is subject to the following two conditions: (1) this device may not cause harmful interference, and (2) this device must accept any interference received, including interference that may cause undesired operation.

FCC Certification (if applicable)

This device contains a radio transmitter. Accordingly, it has been certified as compliant with 47 CFR Part 15 of the FCC Rules for intentional radiators. Products that contain a radio transmitter are labeled with an FCC ID.

FIRE AND SHOCK HAZARD STATEMENT



CAUTION: TO REDUCE THE RISK OF ELECTRIC SHOCK. UNPLUG ALL POWER SOURCES, INCLUDING CAMERAS FROM THE DVR BEFORE REMOVING COVER. FAILURE TO DO SO CAN RESULT IN DAMAGE TO THE DVR OR ITS COMPONENTS AS WELL AS INJURY OR DEATH.

The lightning flash with arrowhead symbol, within an equilateral triangle, is intended to alert the user to the presence of un-insulated "dangerous voltage" within the product's enclosure that may be of sufficient magnitude to constitute a risk of electric shock.

The exclamation point within an equilateral triangle, is intended to alert the user to the presence of important operating and maintenance (servicing) instructions in the literature accompanying the appliance.

WARNING: TO PREVENT FIRE OR SHOCK HAZARD, DO NOT EXPOSE THIS UNIT TO RAIN OR MOISTURE

CAUTION: TO PREVENT ELECTRIC SHOCK, MATCH WIDE BLADE OF THE PLUG TO THE WIDE SLOT AND FULLY INSERT

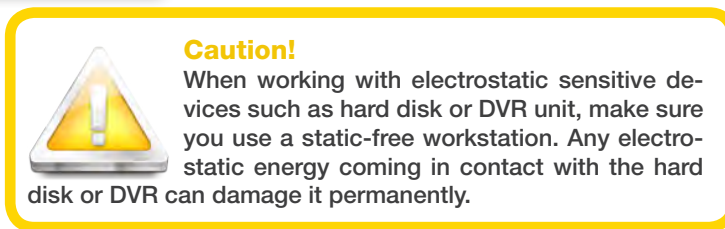

DISPOSAL



These symbols indicate that it is prohibited to dispose of these batteries in the household waste. Take spent batteries that can no longer be charged to the designated collection points in your community.

WHAT'S IN THE BOX

HS-4705-400
4 Channel Digital DVR
with 500GB Hard Drive



400 TVL Camera
Quantity 4



2 Window
Warning Decals



Quick Install Guide



Installation Software
and Manuals



USB 2.0 Mouse



Remote Control



RJ45 Ethernet Cable



Power Supply for
DVR and Cameras



60' BNC Video & DC Power Cable
Quantity 4



5-way Power splitter -
4 cameras, 1 DVR

FRONT PANEL



| ITEM | FUNCTION | CONTROL | DESCRIPTION |
|------|-------------------|---------|---|
| 1 | LCD ON/OFF | | Turns LCD Display on or off |
| 2 | Standby/Window | | Function 1: Press and hold to enter/exit standby mode. Function 2: Switch between Quad view and CHN 1-4 single channel view. |
| 3 | MENU/EXIT | | Press to open/close the main menu |
| 4 | Navigation/OK/PTZ | | In menus, press to confirm selections; in PTZ mode, press to change the navigation buttons to control the connected PTZ camera (not included) Press to move cursor up; in PTZ mode, press to pan camera up Press to move cursor down; in PTZ mode, press to pan camera down Press to move cursor left; in PTZ mode, press to pan camera left Press to move cursor right; in PTZ mode, press to pan camera right |
| 5 | USB | | Connect a USB flash drive to the left port for data backup and firmware upgrades. Connect a USB mouse to the right port |
| 6 | IR Sensor | | IR receiver for the remote control |
| 7 | LED Indicators | | Visual indicators for Power, Record, Alarm, Hard Drive (HDD) and Network Status. |
| 8 | Main Screen | | 7" LCD Color Monitor |

BACK PANEL

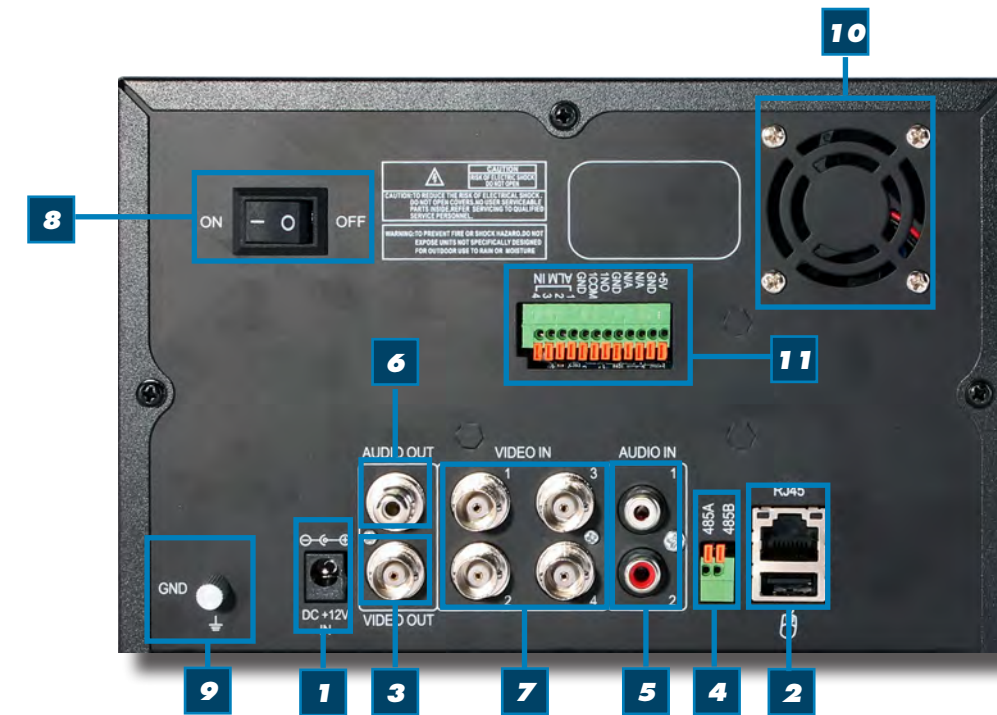



| ITEM | FUNCTION | DESCRIPTION |
|------|--------------|---|
| 1 | POWER Input | DC 12V/3A power connection |
| 2 | Network | For connecting RJ45 ethernet cable to PC or router |
| 3 | Video Output | For connecting to a BNC monitor (800 x 600) |
| 4 | RS485 | For connecting PTZ cameras |
| 5 | Audio Input | For connecting audio signal from audio capable cameras or self powered microphones (RCA jacks). Note: Audio can only be recorded on Channel 1 and 2. Be sure the Audio 1 matches the Video 1 and Audio 2 matches Video 2. |
| 6 | Audio Output | For connecting audio signal to amplified speakers (RCA jacks) |
| 7 | Video Input | For connecting video signal from cameras (BNC) |
| 8 | Power Switch | Power On/Off |
| 9 | Ground | Ground connection |
| 10 | Fan | Cooling Fan |
| 11 | Alarm Block | For connecting up to 4 alarm inputs, one alarm output |

REMOTE CONTROL

Remote Control Operation

The remote control is the secondary input device for navigating the system's interface. In device operation, the enter key has the same function as "left click" of the mouse.

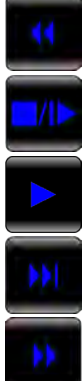
| ITEM | FUNCTION | DESCRIPTION |
|------|---|---|
| 1 | STANDBY | Press to turn standby mode ON/OFF |
| 2 | LOGIN/LOCK | If "Security" has been enabled in the setup menu, press to open the user password login screen. |
| 3 | Number/Channel Buttons | While in menus, press buttons 0~9 to enter values; In Live View, press 1~4 to view channels in full-screen |
| 4 | Window Display  | Press to show quad display |
| 5 | MENU | Opens the main menu |
| 6 | PTZ | Press to open the PTZ control window |
| 7 | EXIT | Close menu windows |
| 8 | Navigation/OK  | In menus, press to confirm selections; in PTZ mode, press to change the navigation buttons to control the connected PTZ camera (not included) |
| | | Press to move cursor up; in PTZ mode, press to pan camera up |
| | | Press to move cursor down; in PTZ mode, press to pan camera down |
| | | Press to move cursor left; in PTZ mode, press to pan camera left |
| 9 | + / - | In menus, press to adjust values |
| 10 | RECORD | Press to start manual recording |
| 11 | STOP | Press to stop manual recording |
| 12 | EXTRA | For future use |
| 13 | Playback Controls  | Increase reverse playback speed 2X, 4X, 8X |
| | | Press to freeze playback to one frame, then press again to advance frame-by-frame |
| | | Press to start playback |
| | | Press to slow playback speed by 1/2, 1/4, 1/8 |
| | | Press to increase forward playback speed 2X, 4X, 8X |



Remote Control

TIP: When using the remote control to enter password and camera titles, select the field using the navigation buttons, press ENTER, and then press the number buttons.



Battery Replacement - Instructions for Use

Always purchase the correct size and grade of battery most suitable for intended use. Replace all batteries of a set at the same time. Clean the battery contacts and also those of the device prior to battery installation. Ensure the batteries are installed correctly with regard to polarity (+ and -). Remove batteries from equipment that is not to be used for an extended period of time. Remove used batteries promptly.

MOUSE CONTROLS

Mouse Operation with this DVR

The mouse is the primary input device for navigating system menus. NOTE: Unless otherwise noted, all system functions described in this manual are achieved through mouse input.

To use a mouse with the system:

Connect a USB mouse to the USB MOUSE port on back panel of the system.

NOTE: Only the USB 2.0 port on the front panel is designed for data backup to a USB flash drive. Do not connect a USB flash drive to the USB MOUSE port or vice versa.

Use the mouse buttons to perform the following:

1 Left-Button:

- Click to select a menu option
- During live viewing in split-screen double-click on a channel to view the selected channel in full-screen
- Double-click the channel again to return to split-screen view
- Selecting letter or number on the virtual keypad

2 Right-Button:

- Click to open the Quick Access Menu
- Exits any window
- Exits any menu or re-opens previous menu

3 Scroll-Wheel:

- Not used

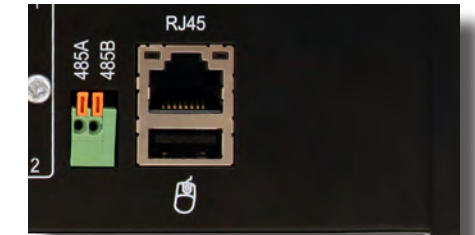

DVR Back Connect Mouse



DVR Front Face Connect USB Drive

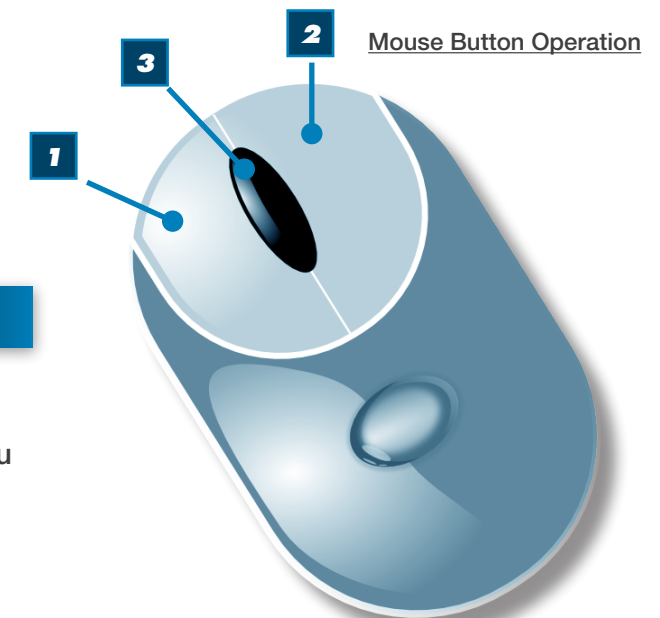

VIRTUAL KEYPAD

Virtual Keypad

To enter text or numerical data, the system uses a virtual keypad. In fields where letters or numbers can be entered, you can switch between various formats – numbers, upper case (ABC) and lower case (abc) and Symbols. See below.

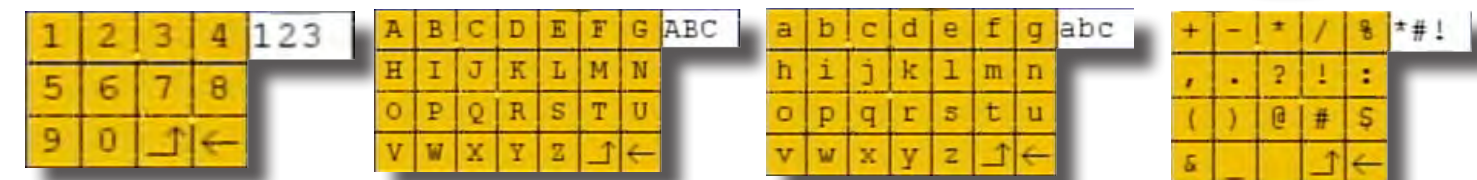

Numbers

Letters-Uppercase

Letters-Lowercase

Symbols

INSTALLING CAMERAS

Mounting Cameras and Running Cable

Select the position for the camera and secure the camera stand. Screw the camera onto the stand. Adjust camera to the proper view angle. Make sure the lens is upright relative to the subject. Tighten the thumb bolt. First Alert cameras can be either ceiling or wall mounted by simply reversing the camera stand mounting. See "Camera Orientation" Info box. Holes are provided on both the bottom and top of the camera housing to accommodate most mounting requirements. Run cable from camera to DVR location. See Information box below on "Longer Cable Runs".



Camera Orientation
It's important the camera is mounted correctly to ensure the image is not upside down as the camera lens can only be positioned one way.

Longer Cable Runs
Longer cable runs may require an upgrade to RG59 Coax cable. First Alert kits ship with economical AV cable that is designed to work well up to the length of cable provided, usually around 60 feet. If longer distances between camera and DVR are required, you will need to upgrade to RG59 Coax cable. We provide several lengths up to 300 feet. In addition, if you need to run cable for in-wall installations, then you may require fire rated cable, FT-4/CMR UL approved for in-wall installations.

CONNECTING DEVICES

Follow this diagram to make device connections. Note, some devices are not included with this kit. See "What's in the Box" for included devices.

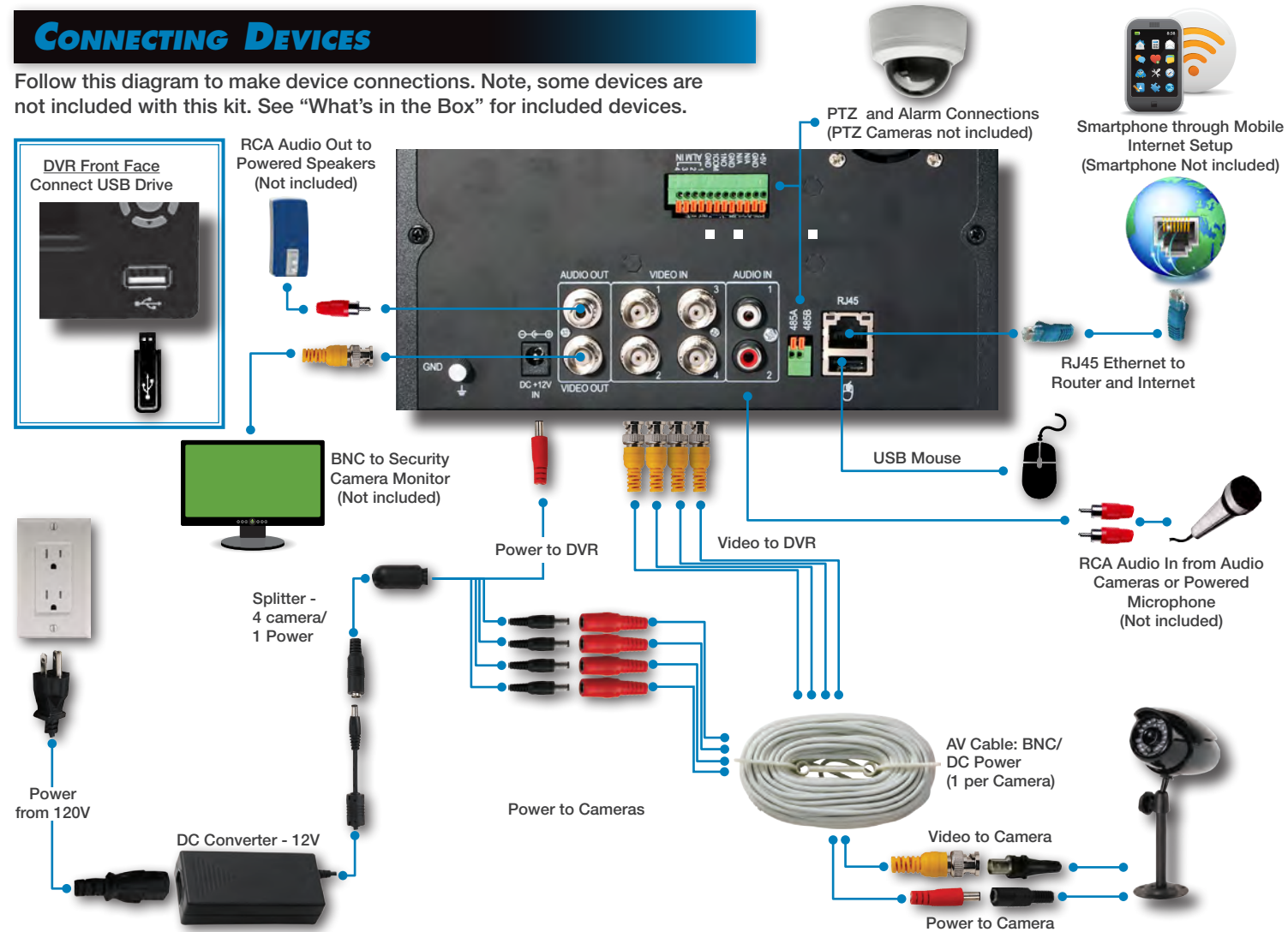

SYSTEM START UP

Power On/Off

To power the system On/Off, connect the power cable to the DC 12V port on the rear panel. Flip the toggle switch on in the back of the DVR. At startup, the system performs a basic system check and runs an initial loading sequence. After a few moments, the system loads a live display view.



Power Switch



Standby Mode

The system can also be put into Standby Mode. Power will remain to the system but will not be recording. To start/stop Standby Mode:

1. Press and hold the STANDBY button on the front panel or remote control until the prompt closes. The system enters standby mode. You can also enter Standby mode through the Quick Access Menu. See next page.
2. To exit standby mode, press and hold the STANDBY button on the front panel or remote control until the system beeps. The system will begin powering up.

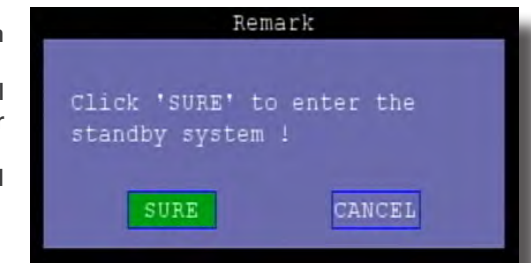

Standby Mode

User Login

Password

ATTENTION: By default, passwords are disabled on the system. You do not need to enter a password when accessing any system menus. However, for security purposes, it is highly recommended to enable passwords on the system using the Password Menu. See "Password" section for details on setting up passwords. Click EXIT to cancel password setup.

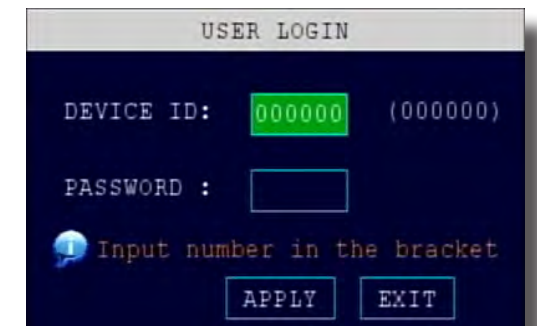

User Login Menu

Live View Screen

The Live View Screen is the home or main viewing screen. It shows live video of all current cameras connected to the DVR. You can double-click a channel at any time to view it in single-channel mode. You access all menus from this Live View screen via the Quick Access Menu. You will also see the Channel number or name, time and day information (see page 16 "Camera Display Setup" for customizing the Live View Screen). It is also where you will see various information and warning icons, depending on what is happening in the system or with the alarms that may be set.

- [R]** means the channel is recording
- [M]** means motion detection alarm activated on the channel
- [I]** means an input on the alarm block activated on the channel
- [H]** means either the hard drive is not installed, it is bad or it is full
- [B]** means Tamper Alarm has been activated on the channel



Main Viewing Screen
Showing No HDD in DVR



Quick Access Menu

Quick Access Menu

When using the mouse, use the Quick Access Menu to access several system options, including the Main Menu. Select one of the following options:

- MAIN MENU: Opens the main system menu
- KEYLOCK: Requires User Login to access menus
- CHN SWITCH: Select type of split-screen display
- VIDEO SEARCH: Open the Search Menu to view recorded video
- PTZ : Opens the PTZ control menu
- MUTE: Mute listen-in audio on the system. Recording of audio is still enabled.
- MANUAL REC: Start manual recording
- STOP REC: Stop manual recording
- ROTATION: Sets the time each channel is visible when rotating through channels. The Loop Time in seconds is set in the Video Setup Screen
- START CRUISE: Click to start preset PTZ Camera motion
- STOP CRUISE: Click to stop preset PTZ Camera motion
- STANDBY: Puts system in standby mode.

To close the Sub-Menu, click anywhere on-screen.

Main Menu Access

To open the Main Menu: Right-click anywhere on-screen to open the Quick Access Menu and select MAIN MENU (mouse only), or press the MENU button on the remote control or front panel of the system.

NOTE: If passwords are enabled on the system, you need to select your Device ID and enter the 6-digit numerical password to open the Main Menu.

Main Menu

1. SEARCH: Search for recorded video on the system.
2. RECORD: Configure recording parameters (quality, resolution), set record modes, and enable/disable audio recording. Note: Audio capable cameras (not included) are required for audio recording on the system.
3. HDD: Display hard drive status and format the internal hard drive of the system.
4. BASIC: Open the Basic Setup Menu, which lets you set the system language, date and time, device IDs and passwords, and configure display, audio and video settings.
5. ADVANCE: Opens the Advanced Setup Menu, which lets you view system info, configure alarm, PTZ, motion detect, maintenance, mobile, and network settings.
6. EXIT: Closes the Main Menu.



Main Menu

PASSWORD SETUP

Setting Up Passwords

When you first startup your DVR, you are automatically logged in as the ADMIN under Device ID: 000000. By default, passwords are disabled on the system. You will not need a password to log in or access menus. You will not need a password to access your system using the browser-based remote software.

The system employs two levels of user authorities connected to a Device ID. The levels are as follows:

1. ADMIN (administrator): Has full control of the system, and can change both administrator and user passwords and enable/disable password checking
2. USER (normal user): Only has access to live viewing, search, playback, and other limited authorities.

For security reasons, it is highly recommended to enable passwords on your system. If you enable passwords, you must select a 6-digit ADMIN password and a 6-digit USER password. The ADMIN and USER passwords must not be the same.

To customize Password settings, click BASIC from the Main Menu, then click PASSWORD. You are now in the PASSWORD Menu. From here you can change the DEVICE ID:

1. Device ID: Click the field beside Device ID and enter a 6-digit numerical Device ID using the Virtual Keyboard.
- Next, in the PASSWORD drop down menu click ENABLE to set up Admin and User passwords. NOTE: Only the Administrator can enter the PASSWORD setup.

- PASSWORD: Password must be 1-6 digits
- RETYPE: You must retype the passwords.
- NETWORK PW CLEAN: When activated, it means you will not have to use a password to log on to the system remotely via Internet Explorer. This does not disable the DVR logon password requirement. You will still need a password to log in the DVR if one was setup.

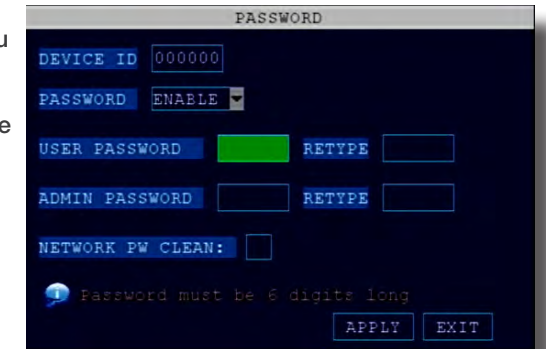

User Password Setup



No HDD installed

NOTE: If there is no HDD installed, or the HDD is not recognized, or the HDD is not formatted in Live View a red **[H]** will be displayed in the video preview interface. You must format the HDD in the DVR before first use. See: Menu > HDD management > Format. After formatting, the system will restart.

CAMERA DISPLAY SETUP

Setting Up Cameras for Viewing and Recording

Use the Display Setup menu to customize channel titles, show/hide the date and time in live viewing and playback, and enable/disable preview channels. To customize Display settings, click BASIC from the Main Menu, then click DISPLAY:

Display

- Configure the following options:
 - NAME:** Click any of the fields and enter a new title for the selected channel using the Virtual Keyboard (mouse only)
 - POSITION:** Reposition the channel title; select TOPLEFT, BOTTOMLEFT, TOPRIGHT, BOTTOMRIGHT, or OFF. If OFF, the title will not be displayed for the selected channel
 - COLOR:** Adjust CHROMATICITY, LUMINOSITY, CONTRAST, and SATURATION for the selected channel
 - PREVIEW:** This feature can be very useful if your display monitor is in public view. With PREVIEW in the OFF selection that channel will appear black on the display to give the impression that no cameras are connected and the system is not recording. Select ON/OFF to enable or disable this feature
 - PREVIEW TIME:** Select ON/OFF to show/ hide the date and time during live viewing
 - RECORD TIME:** Select ON/OFF to show/hide the date and time during playback.
- Click APPLY to save your settings. Click SURE in the REMARK window. Click EXIT.



Display Setup Menu



Color Set-up

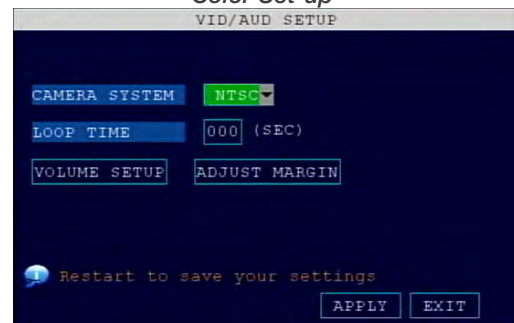

Video/Audio Menu

Video/Audio

Use the Video/Audio menu to set the resolution and camera setup on the system. To configure Video/Audio options:

- Under CAMERA SYSTEM, select NTSC or PAL. (See info box below)
- Under LOOP TIME (SECOND), enter with virtual keypad from 1 to 300
- Under VOLUME SETUP, adjust slider from 0 to 63. Click X to save.
- Under MARGIN, adjust TOP, BOTTOM, LEFT, RIGHT margin with slider from 0 -20.
- Click APPLY. Click SURE in the REMARK window.
- Click EXIT in all menus until all windows are closed.



Audio/Video Recording

Caution: Audio surveillance in some states is illegal or requires permission from one or both parties to record someone's voice. Laws are also different from residential vs. commercial applications. Some federal, state, and local laws prohibit certain surveillance activities and/or the use or distribution of the information obtained from such activities. Prior to using this system, you should become familiar with the pertinent laws to ensure compliance with those applicable to surveillance activities.



NTSC or PAL?

NTSC (National Television Standards Committee) is the video system or standard used in North America and most of South America. In NTSC, 30 frames are transmitted each second. Each frame is made up of 525 individual scan lines.

PAL (Phase Alternating Line) is the predominant video system or standard mostly used overseas. In PAL, 25 frames are transmitted each second. Each frame is made up of 625 individual scan lines.

LANGUAGE, DATE AND TIME

Setting Up Language/Date/Time

Set the system language, date and time, passwords, and configure audio and display options. The Basic Setup Menu contains the following sub-menus: Language, Date/Time, Password, Display, and Video/Audio.

Language

To change the system language, from the drop-down menu select LANGUAGE. Click APPLY. Click CLOSE in the confirmation window. Click EXIT to close the menu.

NOTE: The system will restart when you finish system language setup. The default is English.

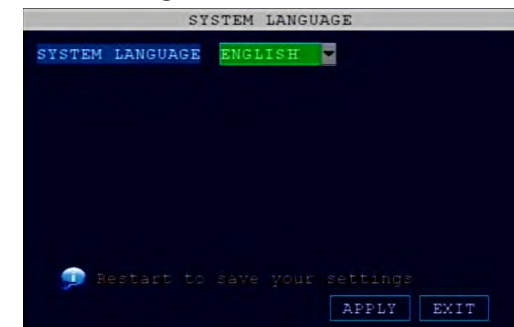

System Language Menu

Date/Time

It is highly recommended to immediately set the date and time when first setting up your system. To set the date and time:

- Click DATE/TIME and configure the following options:
 - DATE:** Enter the day, month, and year.
 - DATE FORMAT:** Select DD/MM/YYYY, MM/DD/YYYY, or YYYY/MM/DD
 - TIME:** Enter the time
 - TIME FORMAT:** Use the drop-down menu and select 12HOURS or 24HOURS. If 12HOURS is selected, then set AM or PM.
 - DST:** Use the drop-down menu to select ON/OFF to enable/disable Daylight Savings Time. See below for details on setting DST.
- Click ZONE to enter your time zone from -12 to +12. To find your time zone visit www.worldtimezone.com or other similar sites. See Info box for US codes.
- Click MODIFY DATE AND TIME. The new date and time are saved. Click EXIT.

Daylight Savings Time (DST)

To set daylight savings time:

- Under DST, select ON. DST options appear.
- Under DST MODE select one of the following:
 - DEFAULT:** The Default setting will apply the United States daylight savings time period from the second Sunday of March to the first Sunday in November (go to step 3)
 - CUSTOM:** Set customized start and end times for DST (go to step 4)
- If using the DEFAULT, click APPLY. Click EXIT.
- If setting a CUSTOM DST, use the drop-down menus to select a week and month for the start and end times.
- Click APPLY. Click CLOSE in the confirmation window.
- Click EXIT in each menu until all windows are closed.



Why Set a Date & Time?

It's important to set the proper date and time before continuing so that you can easily locate recorded events. Inaccurate dates and times on files may affect their admissibility as evidence in court. In addition, when changing current time settings, to avoid possible confusion with the time stamps on recorded and currently recording files, stop all ongoing recording processes before altering the system time and restart recording using the new settings.

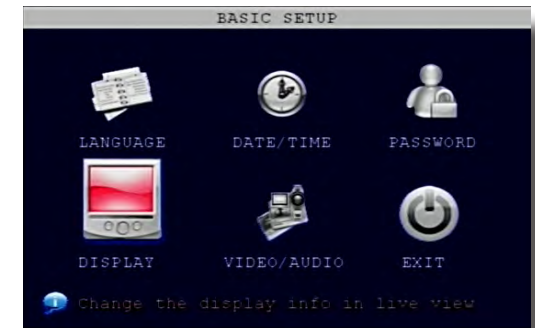

Basic Setup Menu



US World Time Zones - UTC Codes

UTC stands for Universal Time Coordinates or Greenwich Mean Time (GMT)

| | |
|----------------|----------------|
| Eastern: | -5 |
| Central: | -6 |
| Mountain: | -7 |
| Western: | -8 |
| Alaska/Hawaii: | -9 through -11 |

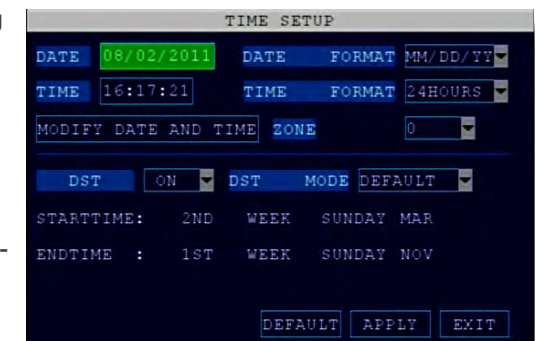

System Time/Date Setup

BASIC SETUP

Use the BASIC SETUP menu to configure language, date and time settings, password setup, along with display, video and audio settings. You can also exit the system through this menu. The Basic Setup menu contains the following sub-menus: Language, Date/Time, Password, Display, Video/Audio and Exit.



Basic Setup Menu

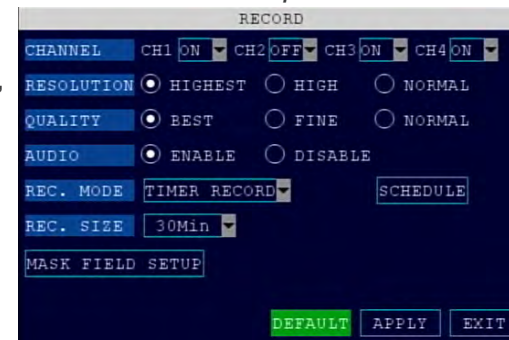

Record Menu

| Bitrate in Kbps | | | |
|-----------------|--------|------|------|
| Image Quality | Normal | Fine | Best |
| Normal (CIF) | 384 | 512 | 768 |
| High (HD1) | 512 | 768 | 1024 |
| Highest (D1) | 512 | 768 | 1024 |

RECORDING

RECORD Mode

Configure Recording Options:

You have three recording options: **Continuous**, **Schedule** and **Motion**. By default, the DVR is set to record continuously. Set parameters as follows:

- From the Main Menu click RECORD. Under CHANNEL, use the drop-down menus and select ON/OFF to enable/disable recording from the selected channel. Note: If CHANNEL is set to OFF, then Motion Detect, Alarm and Manual Record are also disabled for that channel.
- Under RESOLUTION, select Highest, High and Normal. NOTE: NTSC: @30fps, PAL: @25fps. Recording capabilities for both NTSC & PAL: Channels 1 - 4: D1, HD1, CIF.
- Under QUALITY, select Best, Fine or Normal. This relates to bitrate in Kbps.
- AUDIO, select ENABLE or DISABLE. If audio recording is enabled, the system will record audio from connected audio capable cameras (not included). See caution statement on audio recording in **Video/Audio** section.
- REC. MODE, select POWER UP or TIMER RECORD. If you select POWER UP, the system will record continuously (Normal Recording) when the system is powered on. If you select TIMER RECORD, you have to set a recording schedule on the system.
- REC. SIZE (Record Size), select 15MIN, 30MIN, 45MIN, or 60MIN. NOTE: Record Size sets the file size for recorded video files on the system. Instead of recording data as one large file, the system will divide the data into blocks of 15, 30, 45, or 60 minutes. This makes the recorded data easier to search
- MASK FIELD lets you block a specific portion of a channel you do not want recorded or shown on the display screen. This can be useful if you need to conceal a sensitive area being captured by the camera. See next section for details.
- Click APPLY. Click SURE in the REMARK window. Click EXIT.

Recording Schedule (TIMER RECORD)

You can program the DVR to record according to a customized recording schedule. The Schedule Grid shows the days of the week and hour blocks 00~23. You can set Alarm Recording (Red), General Recording (Green), or Manual Recording (Blue) to each time block of each day. To set a recording schedule:

- Open the Main Menu and click RECORD.
- Under REC. MODE, select TIMER RECORD.
- Click SCHEDULE. The Schedule menu opens.
- Under CHANNEL, select specific channels or select ALL.
- Below the grid, click either ALARM (red), GENERAL (Green), or MANUAL RECORD (Blue) and then click a time block on the desired day.
- Use the FROM/TO drop-down menus to copy the schedule of one day to another. For example, if you want your schedule for Monday to be the same on Wednesday: under FROM select MON, under TO select WED, and then click COPY.
- Click APPLY. Click OK in the REMARK window. Click EXIT.

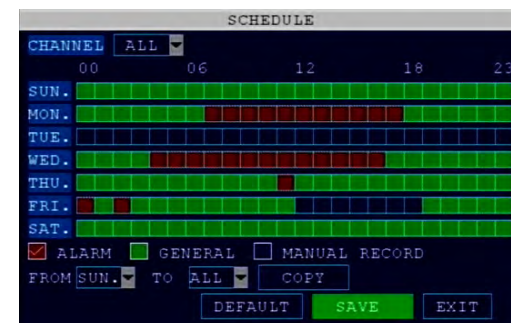

Recording Schedule



CCTV Resolution

CCTV resolution is measured in vertical and horizontal pixel dimensions and typically limited by the capabilities of both the camera and the recorder that you are using for your CCTV surveillance installation. CCTV systems use an analog video signal. For television specifications (which CCTV uses) the highest resolution that can be captured and stored is 704 x 480 (NTSC for the United States) and 720 x 576 (PAL for Europe). This resolution is known as D1 resolution. A high end CCTV recorder is capable of recording at up to D1 resolution.

CCTV Resolutions

D1: 704 x 480
 HD1 (2CIF): 704 x 240
 CIF: 352 x 240
 QCIF: 176 x 120

Recording Schedule (TIMER RECORD) Example

You want your system to record continuously on all channels from 9 AM to 5 PM Monday to Friday. You also want Alarm/Motion recording from 5 PM to 9 AM. You do not want the system to record Saturday or Sunday:

- Open the Schedule menu.
- Under CHANNEL, select ALL.
- Click the blue NO RECORD block below the grid. A checkmark will appear in the block.
- Under SUN, click blocks 00~23. The blocks will turn blue.
- Under FROM, select SUN. Under TO select SAT, and then click COPY.
- Click the red ALARM block below the grid.
- Under MON, click blocks 00~08 and blocks 17~23. The blocks will turn red.
- Under FROM, select MON. Under TO select TUE, and then click COPY. Repeat for Wednesday, Thursday, and Friday. Your completed schedule should be the same as the schedule to the right.
- Click SAVE. Click CLOSE in the confirmation window. Click EXIT in all menus until all windows are closed.

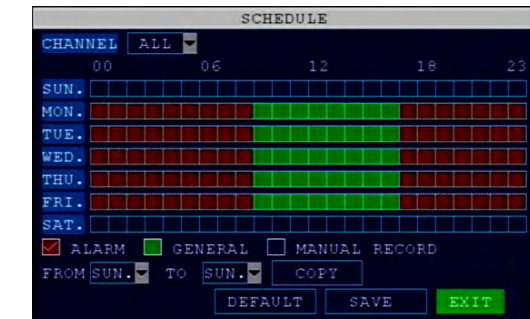

Recording Schedule

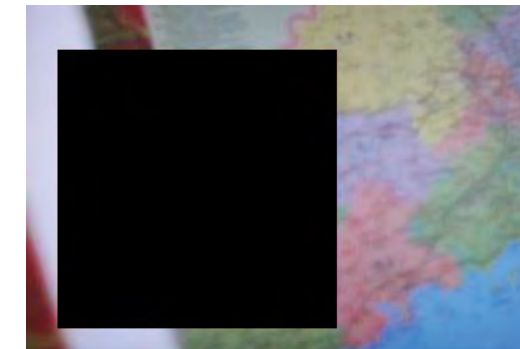

Privacy Mask Field

MASK FIELD lets you block a specific portion of a channel you do not want recorded or shown on the display screen. This can be useful if you need to conceal a sensitive area being captured by the camera. To use the Privacy Mask Field:

- From the Record menu, click MASK FIELD. The Mask Field menu opens.
- Choose a channel you wish to apply the Mask Field.
- Select ON from the SWITCH drop-down menu.
- Click SETUP. The Mask menu will be replaced by the full-screen camera view of the desired channel. Using the mouse, click and drag the cursor over the area you want to conceal. A single click will produce a small black square.
- Right-click anywhere on the screen to return to the Mask Field menu.
- Click APPLY. Click OK in the REMARK window. Click EXIT.

Motion Detect Setup

You can configure motion detection for each channel (Camera) connected to the DVR. To configure motion detection:

- From the Main Menu click ADVANCED. Then click MD (Motion Detect).
- Under STATUS, select ON to enable motion detection for the desired channel.
- Under SENSITIVITY, select 1 through 4. The higher the number, the more sensitive the motion detection.
- Under MD AREA SETUP, click SETUP. The red motion grid appears over the selected channel in full screen.
- Click the blocks in the grid to enable/disable motion detection. Red=motion detection enabled; Clear=motion detection disabled.
- Right-click anywhere on the screen to return to the Motion Detection menu.
- Click APPLY. Click SURE in the confirmation window.
- Click EXIT in all menus until all windows are closed.

NOTE: You can disable the MD buzzer in the Alarm Setup menu.

When MD is triggered, in the Live View Screen you will see a red **[M]** in the Channel with a MD warning. You may also see a **[R]** if you set up the channel to record when an alarm is triggered.



Motion Detect Menu

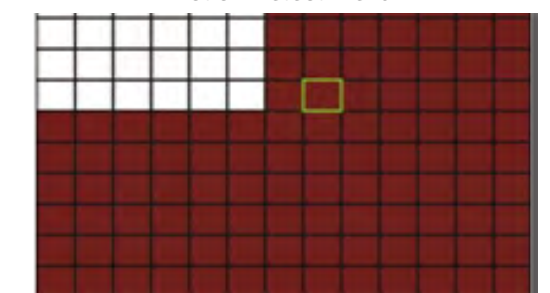

Motion Detect Grid

PLAYBACK

PLAYBACK Mode

Playback and Record Search

View recorded video on the system through the RECORD SEARCH Menu. To begin playback:

1. There are two ways to access the VIDEO SEARCH menu. Right-click anywhere on the screen and select VIDEO SEARCH from the Quick Access Menu. The RECORD SEARCH Menu opens, or from the Main Menu select SEARCH.

NOTE: When you first open the RECORD SEARCH Menu, it displays the current month and date.

2. Click PLAYBACK to playback the last minute of recorded video (Quick Search) OR Under CHN select a specific channel or select ALL.
3. Under DATE, enter a date using the Virtual Keyboard (mouse only).
4. Click SEARCH. Recorded events on the system appear in red (alarm events—includes both alarm and motion events) and green (normal recording).
5. Click a date in the Month Grid to search for video files.
6. Click a time block in the Hour Grid to view the video. Playback begins.
7. Move the mouse slightly to display the on-screen play back controls. You can also use the playback control with buttons on the remote control or front panel of the system.

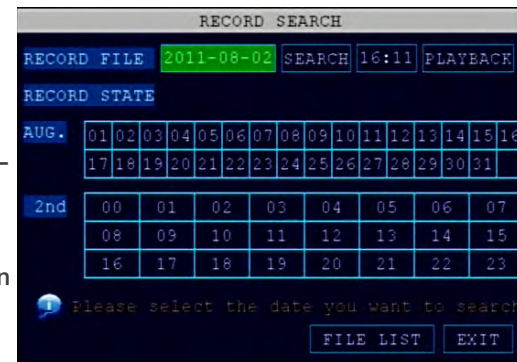

Record/Search Menu



On-screen Playback Controls

On-screen Playback Controls

To use the on-screen playback controls:

1. Click the VCR-like controls to play, pause, fast forward, rewind, and slow down playback.
2. Drag the slider to adjust the volume (audio capable camera required, not included). Select the box to mute the audio.
3. Click X to quit playback and return to the Search menu.

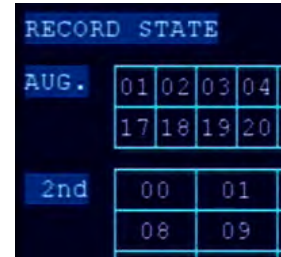

Record State

← Month Grid

← Hour Grid

8. Under RECORD STATE, the system shows recorded events in a Month Grid and a Time Grid. The selected day of the month will be outlined in red. Green=normal recording; Red=alarm recording (includes both alarm and motion events). Click a date in the month grid to view recorded video files for that selected date in the hour grid.

File List

Use the FILE LIST sub-menu to see a detailed list of all the FILE recorded video on your system. To open the FILE LIST:

1. From the RECORD SEARCH Menu, click SEARCH to search the system for recorded video.
2. Click FILE LIST at the bottom of the menu. The FILE LIST menu opens.

To use the File List:

1. Under TYPE, select NORMAL to view only normal recordings, ALARM, to view alarm recordings (includes alarm and motion detection), or ALL to view all video on your system.
2. Use the buttons on the side panel to navigate the file list:
 - FIRST: Jump to the first page of the list
 - PRE: Turn to the previous page
 - NEXT: Turn to the next page
 - LAST: Jump to the last page of the list
 - ALL: Select all files
 - OTHER: Toggles selections between checked and unchecked
 - BACKUP: After selecting a file(s), click to begin copying the data to a USB flash drive (not included);
3. Click any file to begin playback.

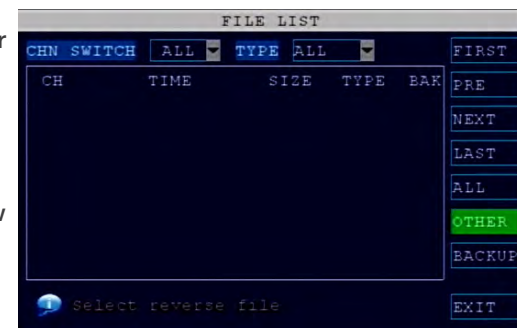

File List Menu

Backup

Use the FILE LIST sub-menu to find recorded video on your system and copy it to a USB flash drive (not included).

NOTE: The system is compatible with most major brands of USB flash drives, with capacities from 256 MB to 4 GB.

To backup recorded data:

1. Connect a blank USB flash drive to the top USB port on the front panel of the system.
2. Open the FILE LIST menu and search for recorded data on the system as shown above.
3. Select the file you want to backup and click the “BACKUP” box next to the file name. Select multiple files if desired. Click ALL to select all files; click OTHER to deselect all files. NOTE: The size of each file is shown in the File List menu. Use this to help you find a USB flash drive large enough to hold all the files you wish to backup.
4. Click BACKUP from the side-panel to immediately begin copying the files to the USB flash drive. NOTE: Backup progress appears in the status window. DO NOT remove the USB flash drive during backup.
5. When the space in backup device is less than recording file, the system will prompt “Space not enough”...
6. You can remove USB device directly when backup is finished



USB Backup

Warning!. Do not remove the USB drive during backup.

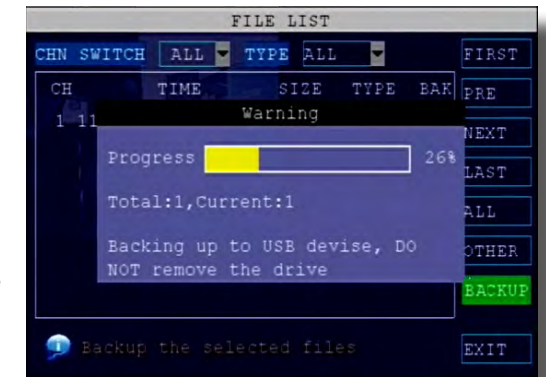

Backup Menu & Warning Notice

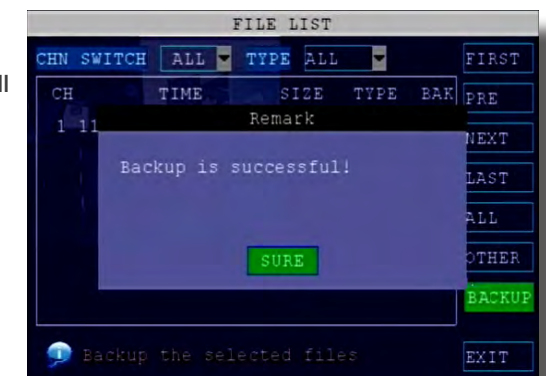

Backup Successful Notice

HDD MANAGEMENT

Hard Drive and USB Options:

The HDD button displays essential information about the system’s internal hard drive, and lets you format the internal HDD and external USB flash drive (not included). If there is no hard drive in DVR, or the DVR cannot read the hard drive, or the hard drive is not formatted, it will display a red “H” in the video preview interface. To access this menu, from the MAIN MENU click HDD.

The HDD menu displays the following:

1. HDD STATUS: The system will display “OK” for normal operation
2. SIZE: The size (in gigabytes) of the internal hard disk drive. The size of your system’s internal hard drive will vary by model
3. FREE SPACE: The space (in gigabytes) remaining on the system’s internal HDD
4. AVAILABLE TIME: The recording time (in hours) remaining on the HDD based on your current record settings
5. OVERWRITE: Select ENABLE or DISABLE. If Overwrite is enabled, the system will record over the oldest video data once the HDD is full. If Overwrite is disabled, the system will stop recording once the HDD is full and the “FULL” LED on the front panel of the system will light up.



Formatting the Internal Hard Drive

If you installed a new hard drive, you must format the hard drive in the DVR before it can be used. Clicking on the HDD FORMAT button will begin the formatting process. After formatting, the system will restart. ATTENTION: Formatting the internal HDD erases all video data. This step cannot be Undone.

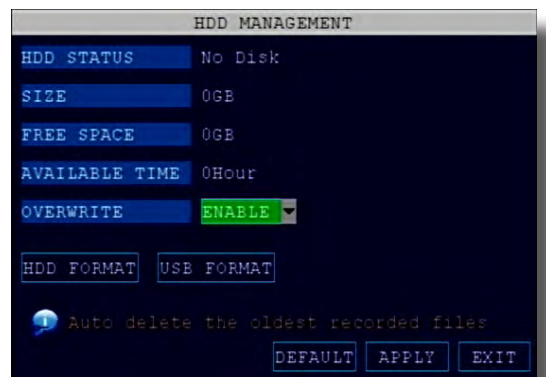

HDD Management



Hard Drive Format Warning

Hard Drive and USB Options continued:

Formatting the USB Flash Drive

Use a USB flash drive to backup recorded video and upgrade the system's firmware. You should always format the USB flash drive you intend to use with the system.

NOTE: Not formatting the USB flash drive may result in improper functionality.



USB Flash Drives

The system is compatible with most major brands of USB flash drives, with capacities from 256 MB to 4 GB. If you need to reformat your flash drive then click on the USB FORMAT button while the USB drive is connected to the USB port on the front of the DVR. Be aware that this button is not for use with any external USB hard drive you may connect to the DVR for backup. External hard drives will need to be formatted using the FAT32 format and this can be done by connecting the drive to the USB port on a PC and reformatting it from there.

ADVANCED SETUP

Use the ADVANCED SETUP menu to configure alarm settings, motion detection, mobile surveillance, PTZ settings and network settings. The Advanced Setup menu contains the following sub-menus: Alarm, Info, MD (Motion Detect), Mobile, System, PTZ, and Network



Advance Setup Menu

ALARM

Alarm and E-mail Options:

Use the Alarm menu to configure alarm and e-mail settings. NOTE: External alarm devices must be connected to the alarm block on the rear panel of the DVR in order to use the I/O (input/ output) alarms of the system. See next section "Alarm Inputs" and "Alarm Inputs Diagram" for details on attaching alarm inputs. To access this menu, from the MAIN MENU click ALARM.

To configure alarm settings:

- Under I/O CHANNEL, select NO (Normal Open), NC (Normal Closed), or OFF for Alarm input. Alarm Input 1 on Alarm Block controls CH1 1 (Camera 1). Note: If in the RECORD screen, a Channel is set to OFF, ALARM is also disabled for that Channel.
- To activate Loss Alarms use drop down menu and select ON/OFF:
 - HDD LOSS: The alarm will sound if the internal HDD is damaged
 - HDD SPACE: The alarm will sound when the HDD is full (overwrite must be disabled)
 - VIDEO LOSS: The alarm will sound when a camera is disconnected
- Under ALARM MANAGE, configure the following:
 - OUTPUT: Set the output time (in seconds) on the spot monitor from 0s, 10s, 20s, 40s, or 60s.
 - BUZZER: Set the time (in seconds) for the DVR buzzer to sound when an alarm is triggered—0s, 10s, 20s, 40s, or 60s NOTE: Set the buzzer to 0s if you want to disable the alarm during motion detection.
 - POST REC: Set the time (in seconds) for the system to record after a triggered alarm—30s, 1MIN, 2MIN, 5MIN



Alarm Manage Screen

- Use TAMPER ALARM to set the system to notify you when a camera has been blocked by something. When a Tamper Alarm is triggered, in the Live View Screen you will see a red **[B]** in the Channel with an alarm warning. Configure the following for each channel:
 - SWITCH: Turn feature ON/OFF
 - SENSITIVITY: Configure LOW/MEDIUM/HIGH
- Click APPLY. Click CLOSE in the confirmation window.



Tamper Alarm Setup

Alarm Inputs:

Alarm inputs are devices or switches that activate when a door, window, cabinet etc. is opened or accessed. For example, you might want to only have the camera record when someone opens a tool cabinet or when a door opens vs. recording when motion occurs around those areas. There may be people moving by those areas frequently but you are only concerned about when those areas are accessed. This saves hard drive space and makes it easier to find an event that was recorded to the hard drive.

To configure alarm inputs for devices without their own voltage you will use the +5V input supplied on the alarm block. See Alarm Inputs Configuration diagram at the right.

Note: If Alarm Input Device has its own power supply make sure:

- Voltage rating is between 5V and 12V. Do not use the +5V connection on the Alarm Block.
- Ground must be connected to GND in Alarm Block for device to operate properly

When an alarm is triggered, in the Live View Screen you will see a red **[I]** in the Channel with an alarm input warning. You may also see a **[R]** if you set up the channel to record when an alarm is triggered.

Alarm Inputs Configuration (for devices without voltage)

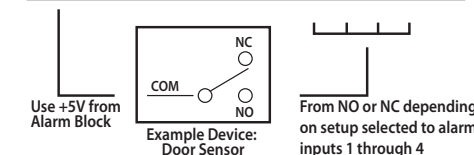
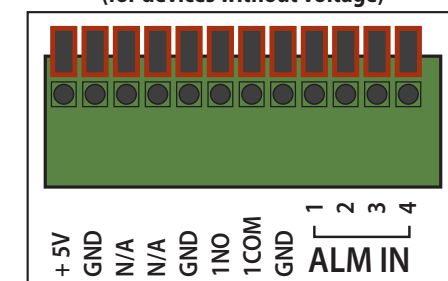

Alarm Output:

Alarm output is used to activate an external device such as a horn or light after an alarm is triggered. To do this the DVR uses a dry contact normally open relay. To configure alarm outputs, connect the external device to the NO (Normally Open) and COM (Common) connections on the alarm block as required by the device. Use the ground (GND) input if required. The maximum contact rating is 3A 24VDC.

| Alarm Block Voltage | |
|-----------------------|-------------|
| Max Switching Voltage | up to 24VDC |
| Max Switching Current | up to 3A |

E-mail Setup:

The system can send an e-mail notification with a JPEG snapshot for triggered events on the system. To setup e-mail notification:

- Under EMAIL, select ON.
- Under SSL, select OFF. NOTE: SSL deals with encryption. Only advanced users should enable this option.
- Under SMTP PORT, enter the SMTP port of your e-mail server.
- Under SMTP, enter the SMTP address of your e-mail server. For example, smtp.gmail.com
- Under SEND EMAIL, enter the sender e-mail address.
- Under SEND PW, enter the password of your e-mail server.
- Under RECV EMAIL, enter the e-mail address that will receive the e-mail notification.
- Click APPLY. Click SURE in the confirmation window.
- Click EXIT in all menus until all windows are closed.

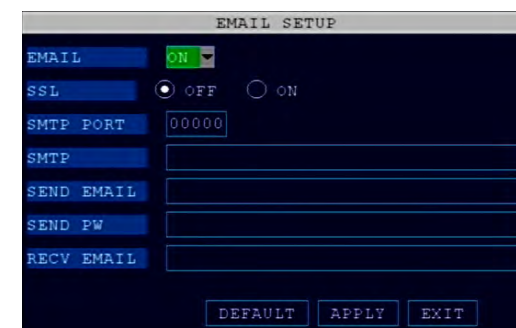

E-mail Setup Screen



E-mail Tip

Depending upon your settings, the system can generate a lot of e-mail alerts. For that reason, we recommend setting up a dedicated e-mail address specifically for the Security System alert notices. Also to better manage your alerts, you will want the alert e-mails to go to a different account than the one sending them.

SYSTEM INFO AND SYSTEM UPDATE

System Information:

View system information, including the firmware version, MAC address, and serial number of the system. To access this menu, from the MAIN MENU click ADVANCED then click INFO.

System Maintain

Use the SYSTEM MAINTAIN menu to update system firmware and set an automatic system reset schedule. To access this menu, from the MAIN MENU click ADVANCED then click MAINTAIN.

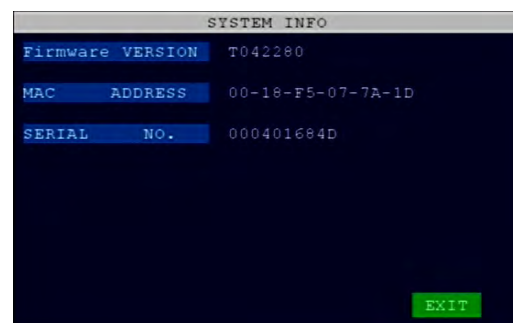

System Info

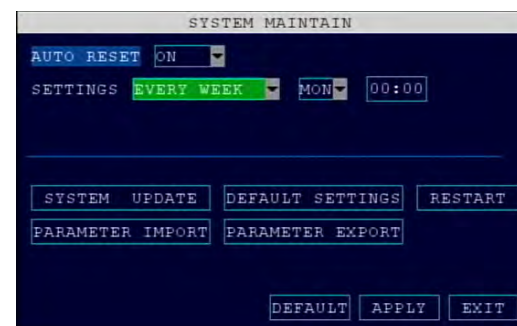

System Maintain

To enable AUTO RESET:

- Under AUTO RESET, select ON. The Settings option appears.
- Under SETTINGS, select EVERY DAY, then set the time of day using the Virtual Keyboard EVERY WEEK, then set the day from the drop down menu and time of day EVERY MONTH, then set the month from the drop down menu and the time of day.
- Click APPLY. Click SURE in the confirmation window

To restore factory settings:

- Click DEFAULT SETTINGS. Click SURE in the prompt. This will restore all or selected items to the original factory settings. NOTE: Recorded video on the HDD will not be erased.

To restart the machine (soft-reset):

- Click RESTART.
- Click SURE in the prompt. The system will perform a soft-reset and load to a live split-screen view.

To upgrade firmware:

- Copy the firmware file to an empty USB flash drive. The firmware file should not be in a folder.
- Connect the USB flash drive to the top USB port on the front panel of your system.
- Open the SYSTEM MAINTAIN (MAIN MENU>ADVANCED>MAINTAIN).
- Click SYSTEM UPDATE. The system will scan the USB flash drive and begin updating the firmware. Do not remove the USB flash drive while the upgrade is taking place.
- PARAMETER EXPORT: Copies the system settings of the device to an empty USB flash drive.
- PARAMETER IMPORT: Imports system settings from another device.

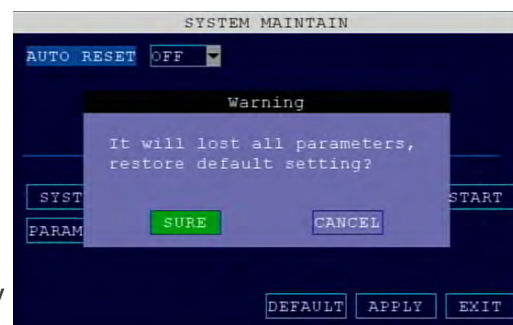

System Update Warning Message



Restore Factory Defaults

Warning! Restoring factory defaults will cause any settings you've made to the system to be deleted. This includes recording and network setups along with passwords. This step cannot be undone. NOTE: Recorded video on the HDD will not be erased.

PAN/TILT/ZOOM...PTZ

Pan/Tilt/Zoom (PTZ) Setup:

NOTE: Consult the instruction manual of your PTZ camera for complete information about your camera, including protocol, baud rate, data bit, stop bit and parity settings before beginning setup. Enter these settings in the DVR.

Step 1: Connect your PTZ Camera to this DVR

Connect a PTZ camera to the BNC and DC power cables. Also, connect the communication cable from the PTZ camera to the 485A (TX, +) and 485B (RX, -) control inputs to the Alarm/PTZ block on the back of the DVR. Note there is only one set of PTZ control inputs (485A & 485B), however multiple PTZ cameras can be set up by making parallel connections. See diagram for details and see "PTZ Camera Setup" Info box for additional information.

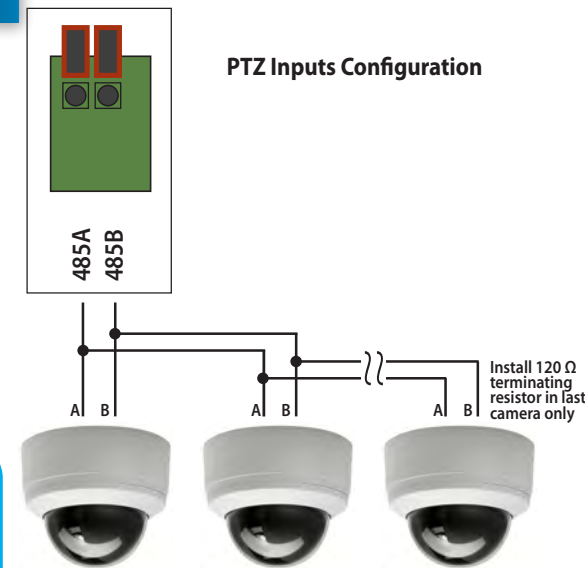

PTZ Camera Setup

NOTE: It is recommended for best results to use 120Ω shielded twisted pair cable of a sufficient gauge to meet your application length. 18 to 22 gauge is usually sufficient. In addition, be sure to only install the 120Ω terminating resistor in the last parallel connected camera. Keeping that resistor in all cameras can possibly degrade the signal and can cause unexpected or loss of operation and control.

Step 2: Configure PTZ Communication Settings:

To access this menu, from the MAIN MENU click ADVANCED then PTZ (see PTZ Setup image). The PTZ setting options for each camera can be selected independently and are available under each camera's channel number.

- Under PROTOCOL, select PELCO-D or PELCO-P for the selected channel.
- Under BAUD RATE, select 1200, 2400, 4800, or 9600.
- Under DATA BIT select 5, 6, 7, or 8.
- Under STOP BIT, select 1 or 2.
- Under VERIFY, select ODD, EVEN, MARK, SPACE, or NONE parity bits. Note: Mark = 1, Space = 0 parity bits.
- Under ADDRESS, provide an address from 001~255 using the Virtual Keyboard for each PTZ camera.
- Click APPLY. Click OK in the confirmation window.
- Click EXIT in all menus until all windows are closed.

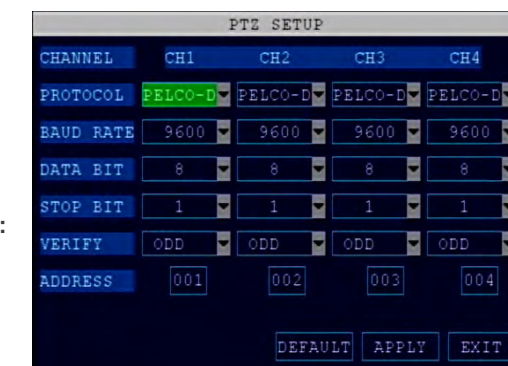

PTZ Setup

Step 3: Configure the Operation & Control of your PTZ Camera(s):

After your PTZ camera(s) are set up you can control their operation from your DVR. Note: Individual features must be available on your camera to operate.

- In Live View, double click on the Channel with the connected PTZ Camera to open to full screen view. This selects the channel to configure and control.
- From the Quick Access Menu select PTZ. (See image at left)
- From the PTZ Setup screen you can adjust:
 - Pan Speed: Adjusts the speed the camera will move.
 - Zoom: "+" Zooms in and "-" zooms out
 - Focus: "+" and "-" focuses the picture.
 - Iris: "+" lets more light in and "-" removes light from the picture. This is useful to correct backlight issues.



PTZ Setup - Sub Menu



Select PTZ from the Quick Access Menu

- Directional keys: Left and Right Arrows control the pan; Up and Down arrows control the tilt. Tip: Hold the mouse button down while clicking on an Arrow Key and drag the cursor away from the key to initiate the Auto Movement feature. The camera will pan continuously 360 degrees from the position it is in or tilt up or down to the limit of the camera until you click OK. This is useful if you want to manually operate the camera without continuously holding or clicking the arrows.

Pan/Tilt/Zoom (PTZ) Setup Continued:

In the PTZ Senior Control screen you can set or control the following for each PRESET defined:

1. SET PRESET: Saves any PRESET functions changed with this screen.
2. CLEAN PRESET: Clears a defined PRESET without going to the SET CRUISE screen.
3. CALL PRESET: Calls a defined PRESET without going to the SET CRUISE screen.
4. AUTO SCAN: Enables AUTO SCAN feature without going through Quick Access Menu.
5. STOP SCAN: Enables AUTO SCAN feature without going through Quick Access Menu.
6. CRUISE SETTING: Configures the Cruise Setting. See next step for details.

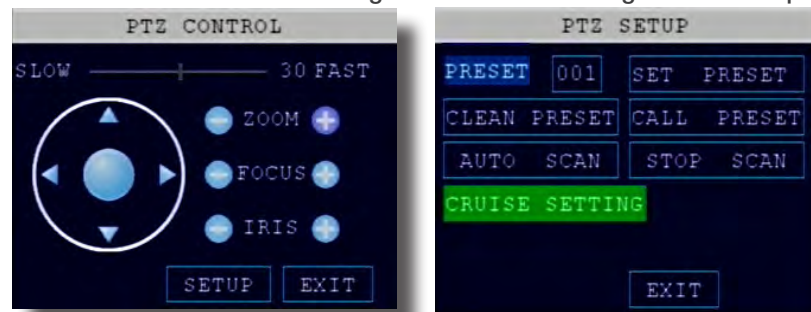

PTZ Setup - Sub Menu

PTZ Setup

Step 4: Configure the CRUISE SETTING of your PTZ Camera.

This feature allows you to set up a series of Pan, Tilt and Hold camera sequences and then execute those operations in a continuous loop. This is useful when you want to record or view the same set of pre-determined areas. You can customize these settings for each PTZ camera connected to your DVR.

Understanding the CRUISE SETTING Options:

To access this menu In Live View, double click on the Channel with the connected PTZ Camera to open to full screen view. From the Quick Access Menu select PTZ. Click SETUP from the PTZ SETUP screen and you will see the PTZ SENIOR CONTROL Menu. Click SET CRUISE to configure the cruise settings for your PTZ Camera.

1. TOTAL: The total number of PRESET's defined
2. PRESET: A defined pan, tilt and hold sequence. You can enter up to 128 PRESET's for a channel depending on how many areas you want to view or record.
3. STOP TIME: The total time in seconds for the camera to move through its defined operation. Note: This includes travel time from the previous set point completion plus the length of time you want the camera to hold on a position. For example, if the STOP TIME is set to 10 seconds and the travel time from the previous set point is 6 seconds, then the camera will hold on the position for only 4 seconds. It can take some trial and error to get the timing you want. To help fine tune your timing after a set point is defined, selecting CALL will travel through the complete cruise setting for the PRESET allowing you to adjust your timing.
4. SET: Stores the PRESET in memory
5. CLEAR: Removes the defined pan, tilt and hold sequence for a PRESET.
6. APPLY: Saves all PRESETS defined.

How to define a Cruise Setting PRESET

1. With your PTZ Channel selected and the CRUISE SETTING menu open as explained in the previous sections, be sure TOTAL is 0 and you are on PRESET 001. If not click CLEAR to reset the PRESET's.
2. Using the Arrow Keys adjust the camera to the first position you want to monitor.
3. Set the STOP TIME setting using the Virtual Keypad. (See STOP TIME explanation above for important information)
4. Click SET to save. The TOTAL and PRESET numbers move to the next number.
5. Repeat steps 2 through 4 for each PRESET you want to define.
6. Click APPLY to save all PRESETS for this CRUISE SETTING.
7. Follow the same steps above to configure other PTZ cameras on other Channels.
8. Click EXIT several times to get to the Live View screen
9. Use the Quick Access Menu to select START CRUISE and STOP CRUISE to begin or end Cruise operation for all defined PTZ channels.



PTZ Cruise Setting

NETWORK SETUP - REMOTE ACCESS

Use the NETWORK SETUP menu to configure your network and DNS settings for remote access. If you are only going to access the DVR locally from a computer attached to the same router as the DVR, you only need to configure settings using either the DHCP or STATIC IP. Because you are on the same network, port forwarding and knowing the public IP address are not necessary. You will just access the DVR by entering the IP address of the DVR from the NETWORK setup into the Internet Explorer browser window. If you are going to take advantage of the Remote Surveillance feature, such as for a smart phone or to view your system outside of your network over the internet you will need to review and set up Port Forwarding and the DDNS. After you setup the NETWORK settings using DHCP, STATIC IP or DDNS, see the REMOTE SURVEILLANCE section for further instructions.

There are five options for configuring the DVR to be accessed remotely: DHCP, Static IP, UPnP, PPOE, and DDNS. To access this menu, from the MAIN MENU click ADVANCED then NETWORK SETUP. Be sure your router or network is connected to the LAN port on the back of the DVR.

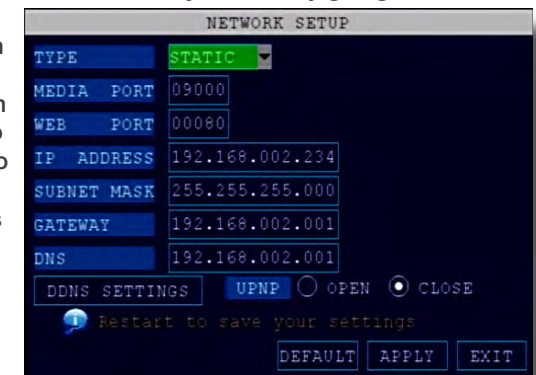

Network Setup

DHCP (Dynamic Host Configuration Protocol)

DHCP is a protocol used by networked devices (clients) to obtain various parameters necessary for the clients to operate in an Internet Protocol (IP) network. It allows you to quickly connect to your network and obtain an IP address from the router. After the initial setup, we recommend that you disable DHCP, then select STATIC from the TYPE drop down box and set the IP address between 1-100. For example, if your IP address is 192.168.0.107, change the last digits to 90 (i.e. 192.163.0.90). This ensures that port forwarding will not change in the event of power failure or resetting of your network.

To configure DHCP settings:

1. Select DHCP from the TYPE drop down box in the NETWORK SETUP Menu. You should see the message "Getting IP..." The router will assign an IP address. This is the IP address you will forward port 80 to on the router so you can access the DVR from remote computers See comment above to configure a static IP.
2. Click APPLY. Click OK in the confirmation window.
3. If necessary, change the Media and Web Port settings

Static IP

You will need to setup the network settings on the DVR to match the settings of the router to which your DVR is connected. This information can be obtained through your computer. Windows 7, Vista or XP all have similar ways to access this data.

To get the router settings:

1. To access the router's settings you will need to enter the Command (CMD) panel on your computer. It must be connected to the same router as your DVR.
 - In Windows 7 or Vista, from the "START" menu type "CMD" in the field that says, "Search programs and files" and hit ENTER or click on the magnifying glass icon.
 - In Windows XP select "Run" from the "START" menu. Type "CMD" after the prompt
2. Type "ipconfig" at the prompt and hit enter
3. You will get a screen that contains information similar to what is shown below. Within all of the information shown, locate the IPv4, Subnet Mask and Gateway addresses. These you will enter into the STATIC IP screen in the NETWORK SETTINGS menu in your DVR. See next step.

```
C:\Users\your id>ipconfig

Windows IP Configuration

Ethernet adaptor Local Area Connection:
    Connection-specific DNS Suffix. . . . . : yourdomain.com
    Link-local IPv6 Address . . . . . : fe80::e743:c4ae:fd28:cb3e%15
    IPv4 Address. . . . . : 192.168.1.10
    Subnet Mask . . . . . : 255.255.255.0
    Default Gateway. . . . . : 192.168.1.1
```

Windows "ipconfig" Info Example

To configure Static IP settings in the DVR:

1. Select STATIC IP from the TYPE drop down box in the NETWORK SETUP Menu.
2. Enter your IP Address, Subnet mask, and Gateway info you obtained from your computer through the previous step in the respective fields using the Virtual Keyboard.
3. Click APPLY. Click OK in the confirmation window.
4. If necessary, change the Media and Web Port settings

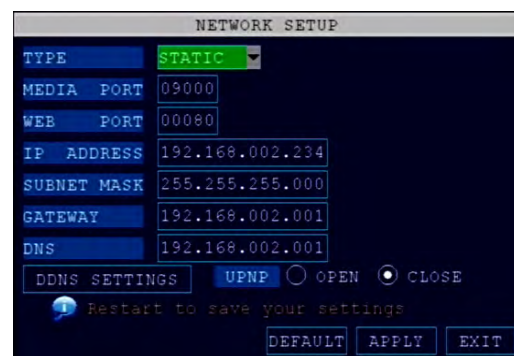

Network Setup Options

UPnP (Universal Plug and Play)

UPnP Forum is an industry initiative designed to enable simple and robust connectivity among consumer electronics, intelligent appliances and mobile devices from many different vendors. This protocol is designed to allow networked devices, such as computers, printers, mobile devices to automatically discover each other's presence on a network and to connect seamlessly for data sharing and communications. NOTE: Your Router must support UPnP function to use this protocol.

To configure UPnP settings:

1. Enable the UPnP function in your Router.
2. In this DVR, Open the MAIN MENU and click ADVANCE.
3. From the Advanced Setup menu, click NETWORK.
4. Under UPnP, select ON.
5. Click APPLY to save your settings and then click OK in the confirmation window.
6. Using a remote PC, open Internet Explorer.
7. In the address bar, enter your Router WAN IP address immediately followed by WEB PORT (no spaces). Example: http://XXX.XXX.XXX.XXX(Router WAN IP):XXX(WEB PORT)
8. Enter your system ADMIN password and select INTERNET. NOTE: If you have not enabled passwords on the system, leave the password field blank.
9. Click LOGIN.

PPPoE (Point-to-Point Protocol over Ethernet)

The Point-to-Point Protocol over Ethernet (PPPoE) is a network protocol for encapsulating Point-to-Point Protocol (PPP) frames inside Ethernet frames. It is used mainly with DSL services where individual users connect to the DSL modem over Ethernet and in plain Metro Ethernet networks. Use this option if you are going to attach the DVR directly to a DSL or Cable modem instead of a router.

To configure PPPoE settings:

1. Select PPPOE from the TYPE drop down box in the NETWORK SETUP Menu.
2. You will need to contact your ISP provider for the user name and password need to enter into the PPPOE NAME and PASSWORD fields.
3. Click APPLY. Click OK in the confirmation window.
4. If necessary, change the Media and Web Port settings.

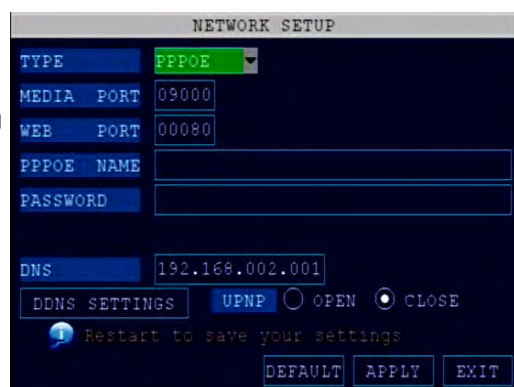

PPPoE Setup



Web Port 80

NOTE: For added security, we strongly recommend changing Web port 80 on the system to any desired port not blocked by your Internet service provider (ISP). Please note however, that you will also need to update the Web port in your browser and open this new port in your router.

DDNS (Dynamic Domain Name Service)

A DDNS account allows you to set up a web site address that points back to your Local Network so you can access the DVR over the Internet using a static or dynamic IP address. One problem with a dynamic address is your internet service provider (ISP) changes this address from time to time. When it changes you need to re-configure your DVR with the new address. To do so you will have to get the new IP address. Although you can go to www.myipaddress.com to get the new IP address, you still have to make the changes manually.

So what are your choices? The first would be to obtain a static IP address from your ISP. This can get expensive due to setup fees and monthly rates. Fortunately there is an easier – and free – option. That is to use a dynamic domain name service (DDNS) to get a domain name that can be linked to your dynamic IP address. While there are multiple free DDNS services available, we recommend www.dyndns.com as the DVR has been already configured to accept account information from this service.

How DynDNS.com works:

1. You install the DynDNS® Updater software on your network
2. When your Internet Service Provider changes the your IP address, the DynDNS Updater detects that the network's IP address has changed
3. The DynDNS Updater sends the new IP address to DynDNS.com
4. The DynDNS.com update server receives the information, and assigns the new IP address to your Dynamic DNS hostname you created.

In addition to automatically keeping up with the changes in the address, you will now be able to enter a domain name rather than a string of digits when accessing the DVR in Internet Explorer.

How to obtain your Domain Name from www.dyndns.com

1. Using a computer that is connected to the same router as the DVR, use Internet Explorer to go to www.dyndns.com
2. Decide whether you only need one domain name which is free or require multiple names for a fee.
3. Follow the instructions for completing the required information to register
4. You will receive a confirmation e-mail with your new domain name. An example domain name might be adam@dyndns.com. You will need it to configure the DVR.

First obtain your Router DNS

You need to get your DNS manually from your router. You will need the Primary or Secondary DNS from your router for DDNS to function properly.

To obtain your Primary or Secondary DNS:

1. In your web browser, log in to your router using its Default Gateway address. NOTE: Refer to your router's manual or software for login information. You can also get the Default Gateway on your PC by selecting Start>Run. Type CMD and press Enter. In the Command Prompt window type ipconfig and press Enter.
2. View its WAN settings. Write down the Primary or Secondary DNS address for use in the next step.

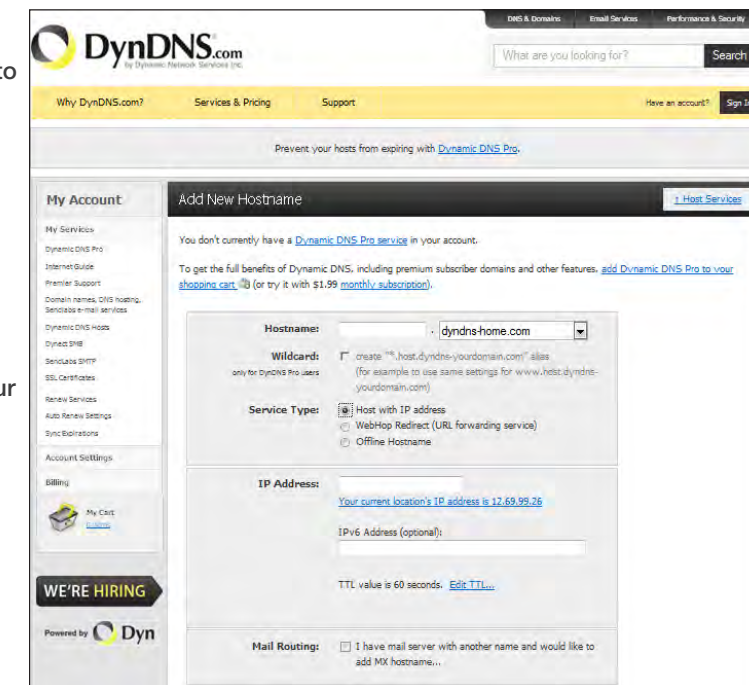

DynDNS.com Setup Screen

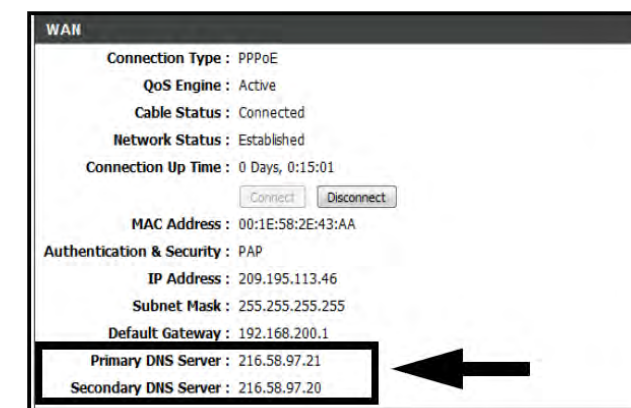

WAN Settings Example

Next configure DDNS settings in the DVR

From the Network Setup menu, enter Primary or Secondary DNS from the WAN settings of your router in the DNS field

1. Click DDNS SETTINGS.
2. Under DDNS, select ON.
3. Under SERVICE, select DYNDNS if you obtained your domain name from DynDNS.com.
4. Under DOMAIN NAME, enter your DDNS domain name you received from the confirmation email. For example, if your domain name is adam@dyndns.com, you need to enter adam@dyndns.com, in the text field using the Virtual Keyboard.
5. Enter your DDNS user name and password in the respective fields.
6. Click APPLY. Click OK in the confirmation window.
7. Click EXIT. The system will prompt you that it must restart. Click OK.

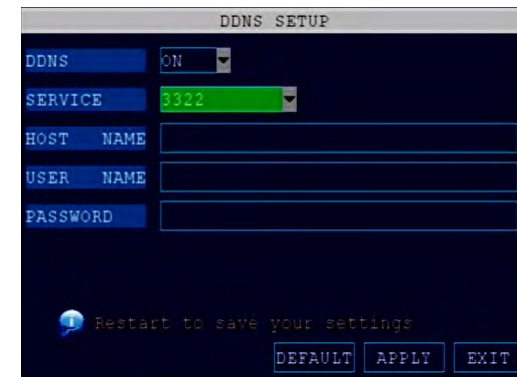

DDNS Setup

Port Forwarding

Port Forwarding allows computers and devices outside of your network to communicate with the DVR. You will need to forward ports 80, 100 and 9000 from the attached router to the IP address of the DVR. Gather the make, model and IP address of the router. If you changed the default router login, then you will need to know the user name and password for that router. There are 3 Steps to follow:

Step 1: How to Determine the IP Address of the DVR

NOTE! The DVR and PC must be connected to the same router and both must be powered up before proceeding.

1. Select DHCP from the TYPE drop down box in the NETWORK SETUP Menu. You should see the message "Getting IP..." The router will assign an IP address.
2. Restart the DVR.
3. Once the DVR has restarted, reopen the Network Setup window and the IP address of the DVR will now be listed. This is the address to which you will forward ports 80 and 9000. If you plan to access your DVR via a smartphone, you will need to forward port 100 as well.

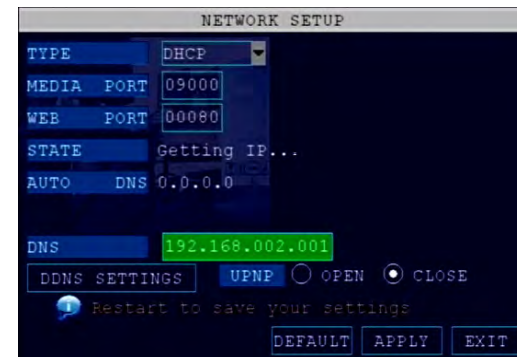

Network Setup-Getting IP Address

Step 2: Download and Install a simple port forwarding program

1. Download the FREE Simple Port Forwarding program from: <http://www.simpleportforwarding.com/download>
2. Click on "Direct Download" and Save the file to your hard drive.



Simple Port Forwarding Download from Website

3. Install the program and launch it.
4. Once Simple Port Forwarding has launched, select your router from the list. The default Router IP and Login information will automatically come up. If you have previously changed the login information, then you will have to enter it manually. Click on "+" at the bottom to open the window allowing you to set your ports. (See "Simple Port Forwarding Initial Screen")
5. Select "Add Custom" button. Enter your information:
 - Name: (You can name your DVR if you wish)
 - Type: TCP
 - Start Port: 80
 - End Port: 80
 - IP Address: IP of DVR obtained in Step 1.
6. Click on ADD
7. Repeat for port 9000. If you are adding a Smartphone then also repeat for port 100.



Simple Port Forwarding Initial Screen

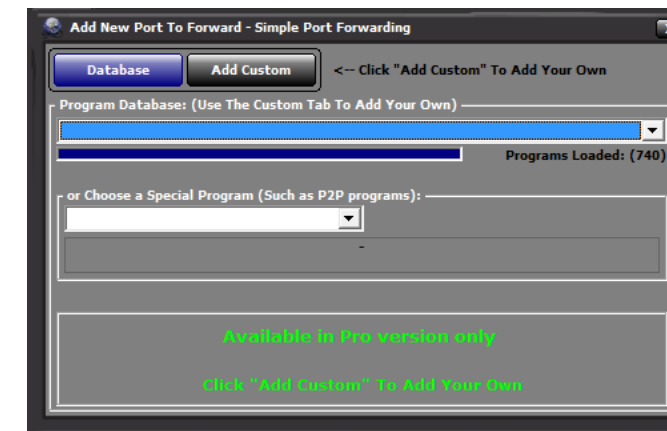

Select "Add Custom" Button

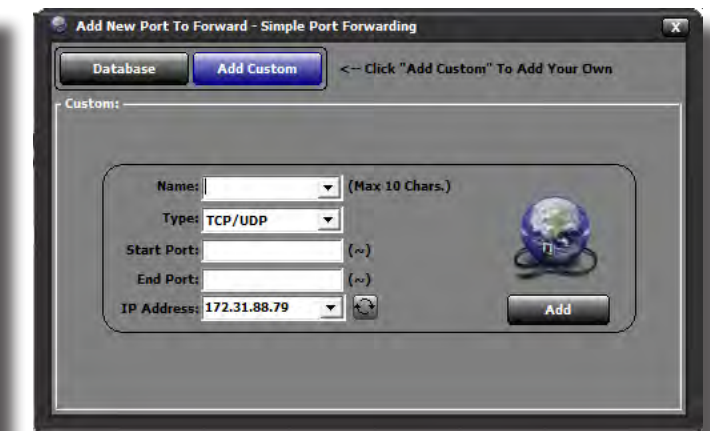

"Add Custom" Data Entry Screen

8. You will now be returned to the main window of the program. The ports you added will now show on the list. Click on "Update Router" at the bottom of the screen.
9. The "Updating is in progress" message now shows. Wait until "Done" is displayed. If for some reason, a port or ports that you forwarded are not listed in the Router or if you see a message in the Scripts list stating that the port already exists, then you will need to change the Port 80 to 85 in the DVR and start over again. Once you receive the DONE message that the ports have been successfully forwarded, test if the ports are working. See next step.

Step 3: Test Port Forwarding

1. In the Checklist Screen, test if the ports are working by clicking on the "Do it now" button in item "(7) Test that the ports now work.". (See "Checklist Screen" below).
2. You should receive a message in the right side of the "Test Your Port Screen" screen, "Port Status Tool" stating that the port is online and can be reached, then you have set it up correctly. You will also receive an IP Address.
3. To connect to your DVR from the Internet, you will need to put the Internet IP address you received in the message into the browser or access program window. If you had to change your port from Port 80, then you need to put that port at the end of the address preceded by a colon (":"). Example: if you used port 85, you will need to enter: <http://75.14.251.43:85>



Checklist Screen

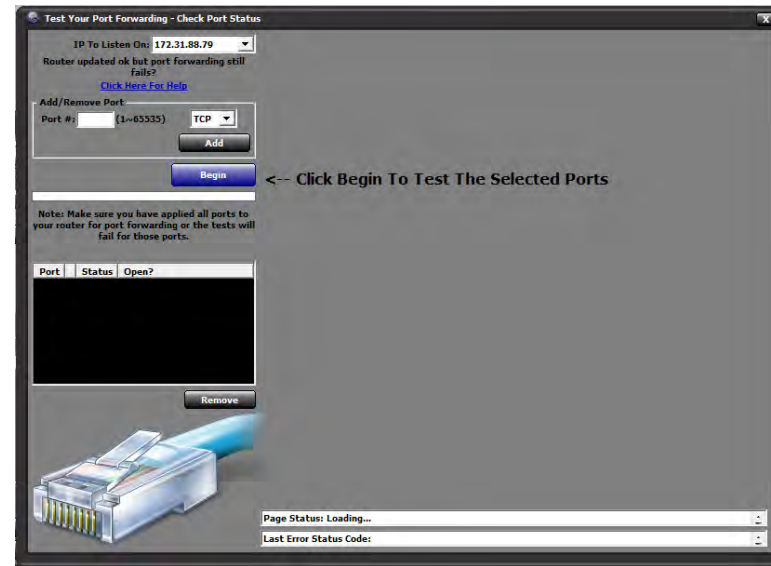

Test Your Port Screen

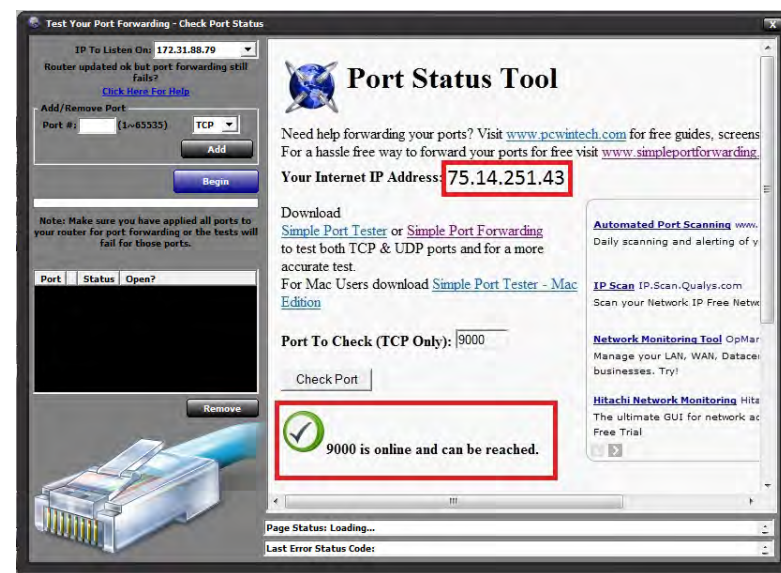

Test Your Port Screen with Results

REMOTE SURVEILLANCE

Remote Surveillance using Internet Explorer 8:

The DVR features built-in browser-based software that allows you to access your system remotely over your local area network (LAN) or over the Internet using Internet Explorer®. Once you have configured the network settings on the DVR to match those on your router and forwarded the ports needed by the DVR to enable remote access over the Internet, you will be ready to remotely view your cameras using a webcam program based on an ActiveX control. For this to work, you will have to enable the ActiveX control options that are built into Internet Explorer. You will also need to check your "User Account Control" setting. It is strongly suggested that you be running the latest version of Internet Explorer (currently IE8).

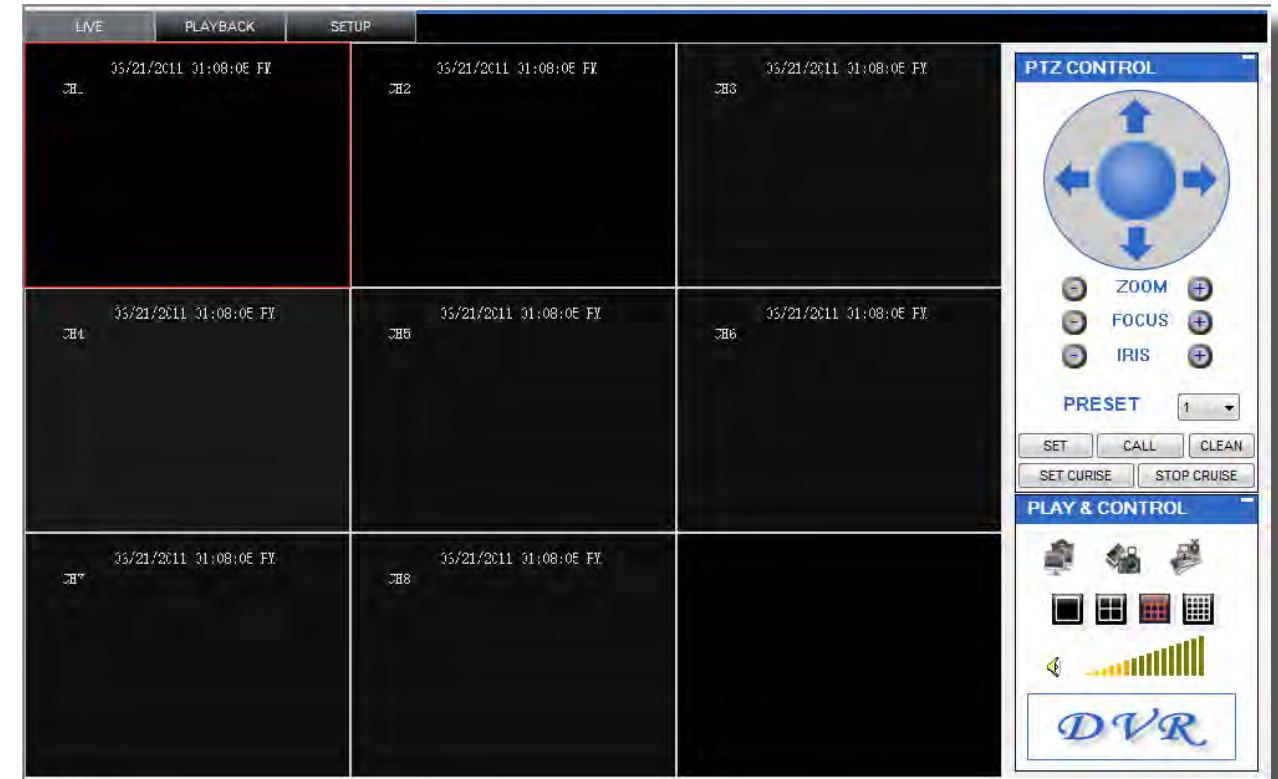

Configuring Windows "User Account Control":

Check the "User Account Control" setting in Windows Vista or Windows 7 to be sure the setting is configured as shown below. If not you might receive an error message informing of a codec that is missing or not installed.

Windows Vista

1. Open the Control Panel
2. Select "User Accounts and Family Safety"
3. Select "Add or Remove User Account"
4. Select user account to change
5. Select Turn User Account Control on or off". Note: Depending on your version of Vista, this screen might be accessible on the bottom of the "Select User Account to Change" screen under "Additional things you can do" > "Go to main user account page".
6. Uncheck the box next to "Use User Account Control (UAC) to help protect your computer."
7. You will need to re-start your computer for the change to take effect.

Windows 7

1. Open the Control Panel
2. Select "User Accounts"
3. Select "Change User Account Control Settings"
4. In the "Choose to be notified about changes to your computer" screen, move the slider to the lowest setting "Never notify".

Configuring ActiveX Control in Internet Explorer 8:

1. Open Internet Explorer 8
2. Click on Tools
3. Select Internet Options in the pull-down menu
4. Click on the Security Tab
5. Select Trusted Sites
6. Click on the Sites button
7. Uncheck the "Require server verification (https:) for all sites in this zone" button.
8. Type the DVR's IP address (obtained during Network Setup) or DDNS domain name (obtained through DynDNS.com setup) into the "Add this website to the zone:" box.
9. Click the Add button
10. Close the window.
11. Back in the "Security Tab" screen, click the "Custom level..." button.
12. Pull down the "Reset to:" menu and select "Low"
13. Click the "Reset..." button
14. Click "Yes" when asked, "Are you sure you want to change the setting for this zone?"
15. Click OK
16. Click Apply
17. Click OK
18. Close Internet Explorer. You are now ready to access the DVR using Internet Explorer 8.

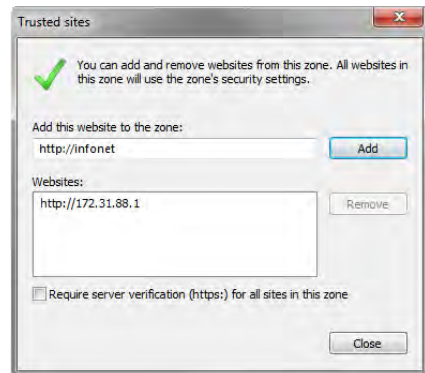

Trusted Sites

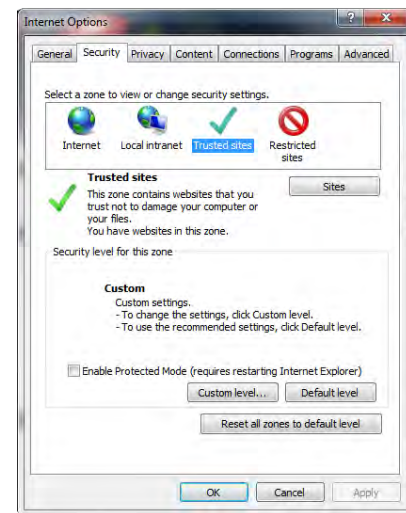

Internet Options-Security Screen

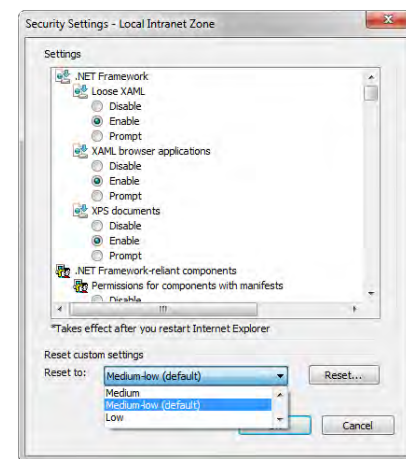

Security Settings

Using Remote Surveillance:

With your system connected to your local area network, you can now log in to your system using Internet Explorer.



Setup Required Prior to Remote Access

NOTE: Your system must be connected to your LAN or WAN, Windows and Internet Explorer must be configured as described in the previous sections *Configuring Windows "User Account Control"* and *Configuring Active X Control in Internet Explorer 8* and the DVR settings must have been setup properly as described in the *Network Setup for Remote Access* section before attempting remote access.

The software from the DVR will install the first time you access the DVR through Internet Explorer and will allow you to operate the network remotely. The DVR supports access over LAN and WAN, also supports IP and domain name access.

Logging Into Your System Remotely

With your IP address, you can now log in to your system over your local or wide area network.

1. Open Internet Explorer. In the address bar, enter the IP address of your system (i.e. 192.168.3.97).
2. You must install the ActiveX® in order to access your system. Click the attention bar at the top of the main page and select Install ActiveX Control. DVR Net viewer will reset.
3. In the warning box click Install. The login page appears. Leave the password field blank (default). **NOTE:** If you have enabled passwords on your system, enter your USER or ADMIN password. However, only the ADMIN can change settings and options on the system.
4. Select LAN or INTERNET from the drop-down menu and click LOGIN.



Remote Surveillance-Login Screen

Remote Surveillance Main Screen:

Upon login, the Remote Surveillance main screen appears in your browser.

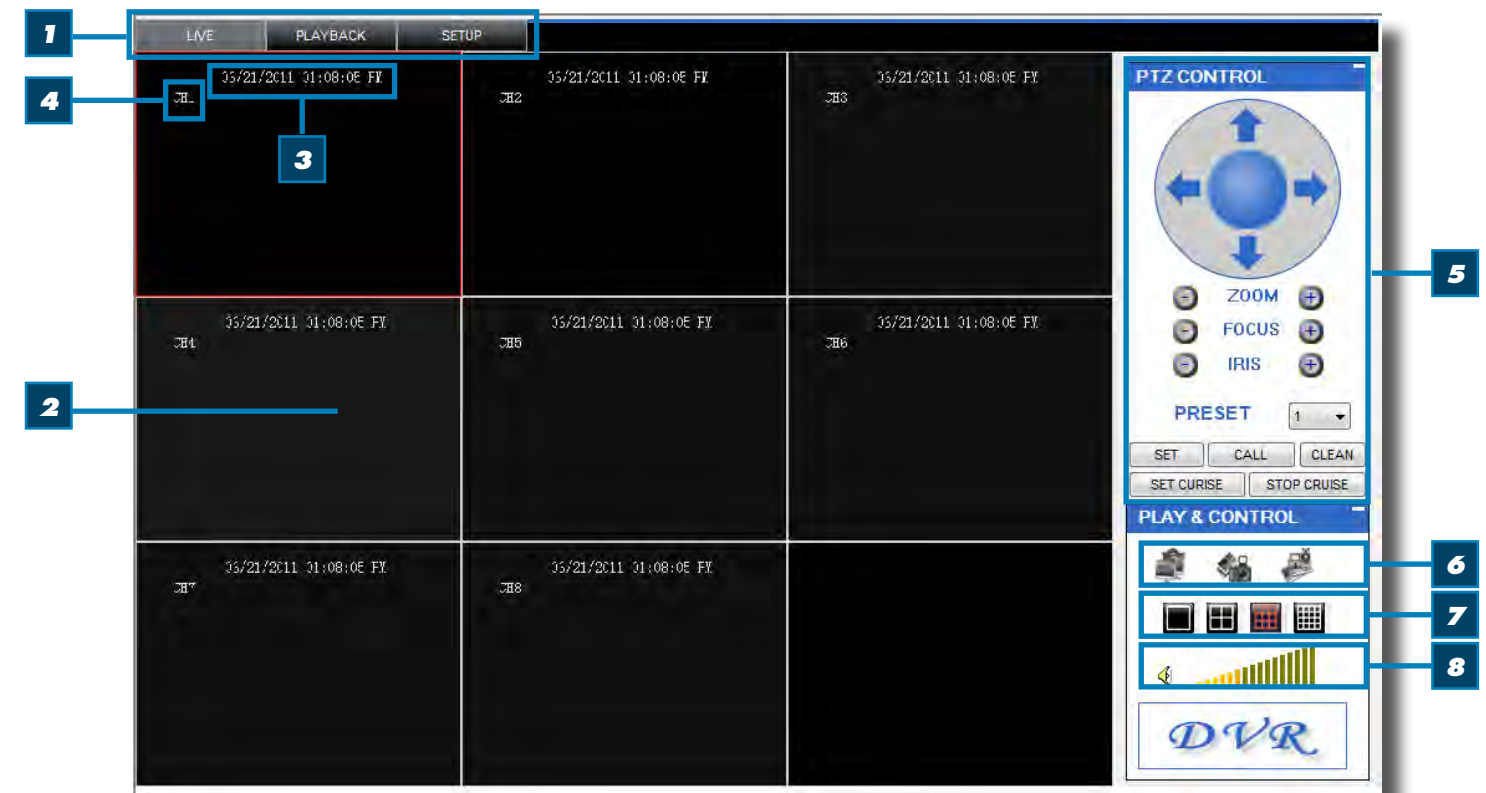



| ITEM | FUNCTION | DESCRIPTION |
|------|---------------|---|
| 1 | Modes | Click LIVE, PLAYBACK, and SETUP |
| 2 | Main Screen | Main display screen for live viewing and playback |
| 3 | Time Stamp | Time stamp appears on each channel |
| 4 | Channel | Channel number appears in the top left corner |
| 5 | PTZ Control | PTZ control for any connected PTZ cameras (not included). |
| 6 | Functions | Click the icons to show/hide channels, take screen captures, and record |
| 7 | Display Modes | Click the icons to view channels in single-channel full-screen, quad, and split-screen configurations |
| 8 | Volume/Mute | Select a channel (outlined in red) and then click the bars to increase/decrease volume; click the icon to mute/ unmute volume.* |

*Note: Audio capable cameras (not included) are required for audio recording on the system.

Live Viewing Tab:

By default, Remote Surveillance opens in Live Viewing mode (split-screen).

To use Live Viewing:

1. Click LIVE at the top of the main screen.
2. Click the display mode icons to view the main screen in single-channel, quad, or split-screen configurations. You can also double-click a channel at any time to view it in single-channel.
3. Click  to show or hide all the channel windows.
4. Click  to start/stop manual recording to your PC on ALL channels. For more details see RECORDING.
5. Select a channel (outlined in red) and then click the audio bars to increase or decrease listen-in volume. Click the icon to mute/unmute.



Live Viewing Talk Function

NOTE: The Talk function is not supported.



Recording

NOTE: You will record video to your PC regardless of the recording mode on the system itself. By default, recorded files are saved in C:\DVR\[ip_address]\Record.

Recording

You can record video directly to your PC using the remote surveillance software.

To record video to your PC, from Live viewing, click to start/stop manual recording to your PC on ALL channels

Quick Access Menu

Right-click any channel to open the sub-menu.

The sub-menu contains the following options:

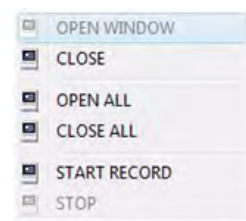

Remote Viewing-
Quick Access Menu

PTZ Control

You must have a PTZ camera (not included) connected to the system in order to use the PTZ controls.

To control a PTZ camera:

1. Select the channel of the connected PTZ camera(s).
2. Click the navigation arrows to pan and tilt the camera.
3. Click +/- to control zoom, focus, and iris.
4. Enter presets.
5. Click SETTING, HAND, and CLEAR to further control presets.



Remote Viewing -
PTZ Control

Screen Captures

Use the remote surveillance software to take a snapshot of the channels on the main display screen. Screen Captures can be useful for your own records, or may be needed by authorities in case of a security incident.

To take a screen capture:

1. From Live Viewing, select the channel you want to capture. The selected channel will be highlighted in a red frame.

2. Click .

3. Click OK in the confirmation window. Screen captures are saved as BMP files to the default save location (C:\DVR\...).

Playback Tab

Use the Replay menu to search and playback recorded video on your system.

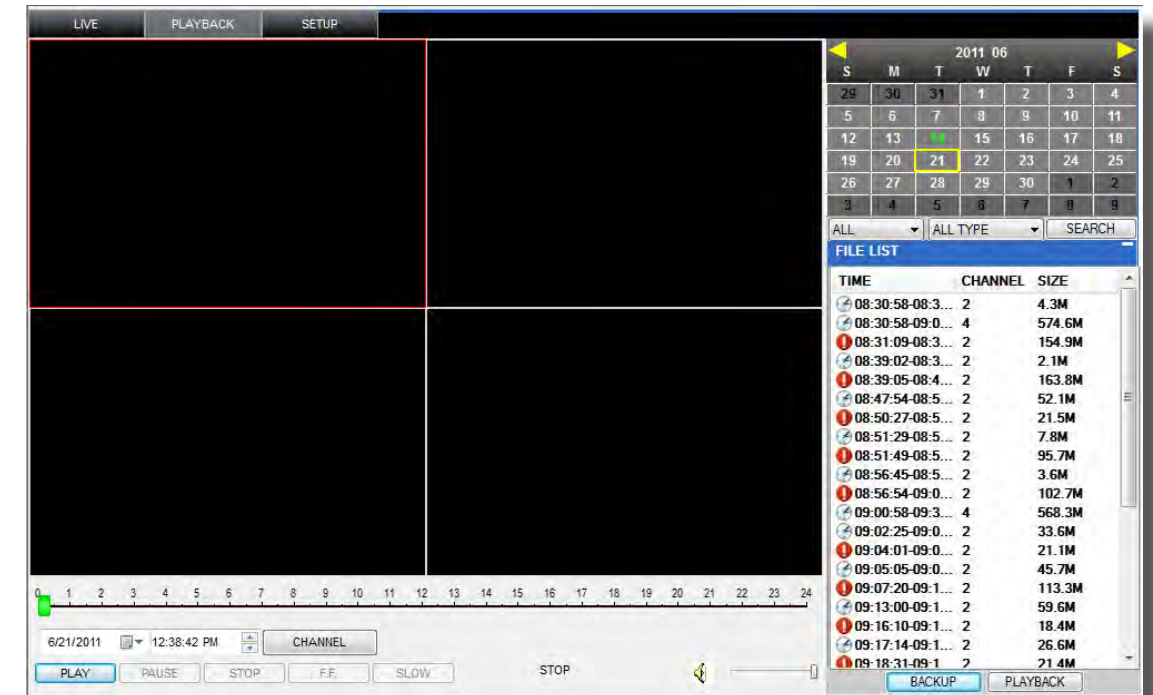

Remote Viewing-Playback Screen

To use the replay menu:

1. Click REPLAY at the top of the main screen. The main screen will be grey.
2. Click REFRESH below the calendar to view the recorded files for the current month. NOTE: Normal recording is indicated by a clock icon; alarm recording (alarm, loss, and motion events) are indicated by an exclamation mark icon.
3. Double-click a file from the File List to playback the file in the main screen. The icon in the file list changes to "▶". Control playback using the buttons at the bottom of the main screen.



Remote Viewing-Progress Bar

The purple bar indicates the download progress. The green marker indicates playback progress. You can click and drag the playback marker (will turn from green to orange) to advance or rewind playback as needed. Click Play, Pause, Stop, Fast Forward, Slow and Next Frame to perform those functions.

Search

Use the calendar and drop-down menus to search for recorded video on your system.

1. Click < > to change the month on the calendar. Dates with recorded video data will appear in bold.
2. Click the date. Recorded video files will populate the File List.
3. From the Channel drop-down menu, select a specific channel or select ALL CHANNEL and then click SEARCH.
4. From the Type drop-down menu, select COMMON (normal recording), ALARM, or ALL TYPE and then click SEARCH.
5. Double-click the file from the File List to playback the file in the main screen.

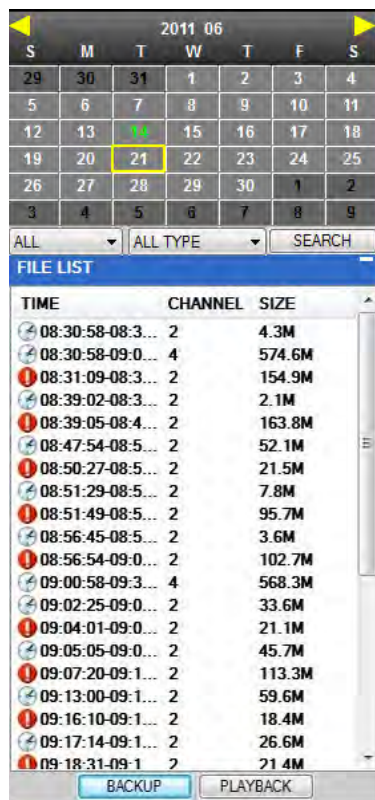

Remote Viewing-Search Calendar

Remote Backup

You can backup recorded video files from your system to your PC using the Replay menu in the remote surveillance software.

To backup files remotely:

1. Click PLAYBACK at the top of the main screen.
2. Double-click a file from the File List to begin playback.
3. Click BACKUP. Backup begins to C:\DVR/[ip_address]/Backup NOTE: If you playback a file, you must wait for the file to load before backing it up otherwise you may receive an error message



Remote Viewing-Error Message

4. When file backup is complete, click OK in the confirmation window. The confirmation window show the save path of the backup file. NOTE: Backup files are saved as .264 files.

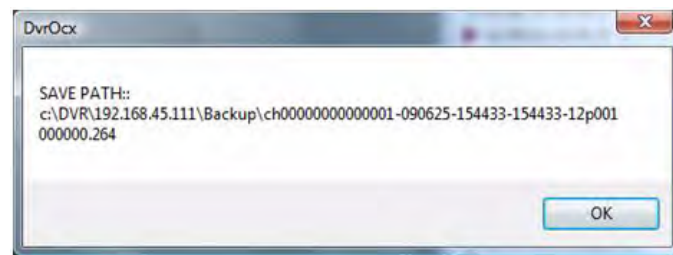

Remote Viewing-File backup Location



Player Software

NOTE: Use the Player Software included on the software CD to playback backed up video.

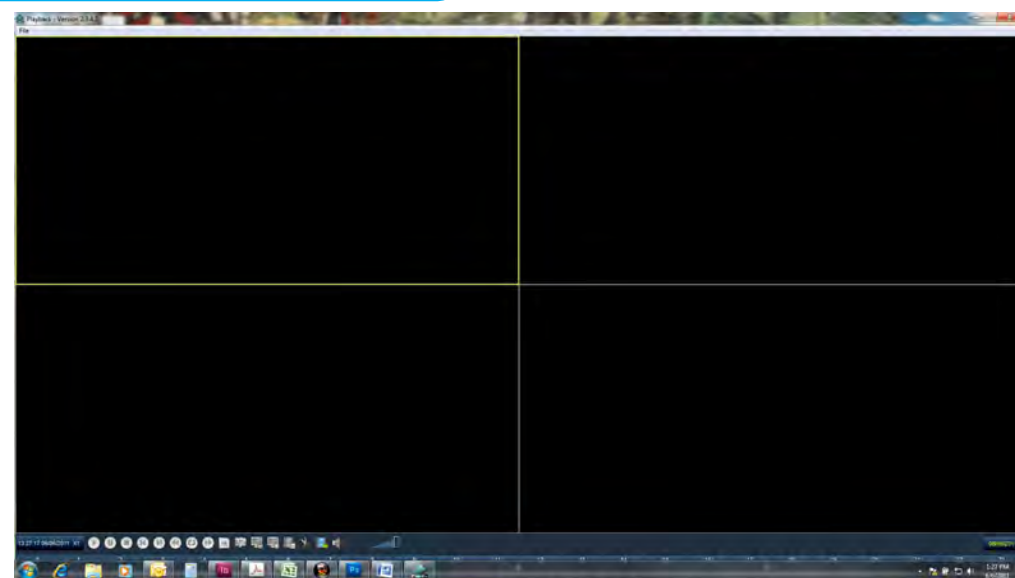

Remote Viewing-Playback Software

Setup Tab

Use the SETUP tab to configure the settings of your system from a remote location. NOTE: If the Main Menu is open on the system, you will not be able to make changes to the system from the remote location.

To open remote setup:

Click SETUP at the top of the main screen. The Remote Setup menu features the following tabbed options:

- RECORD
- ALARM
- PTZ
- NETWORK
- SETTING
- MAINTENANCE
- HOST INFO

RECORD

You can check and change the parameter settings as configured in the DVR.



Remote Setup - Record Screen

ALARM

You can check and change the parameter settings as configured in the DVR.



Remote Setup - Alarm Screen

PTZ

You can check and change the parameter settings as configured in the DVR.



Remote Setup - PTZ Screen

NETWORK

You can check and change the parameter settings as configured in the DVR.



Remote Setup - Network Screen

SETTING

You can check and change the parameter settings as configured in the DVR

- BANDWIDTH:** Set the bandwidth in kbps (128k, 192k, 256k, 384k, 512k, 1024k) that you want to allocate for traffic based on internet bandwidth available. This bandwidth does not include audio.
- FILE SAVE PATH:** The path where you want to save captured picture and recording video.

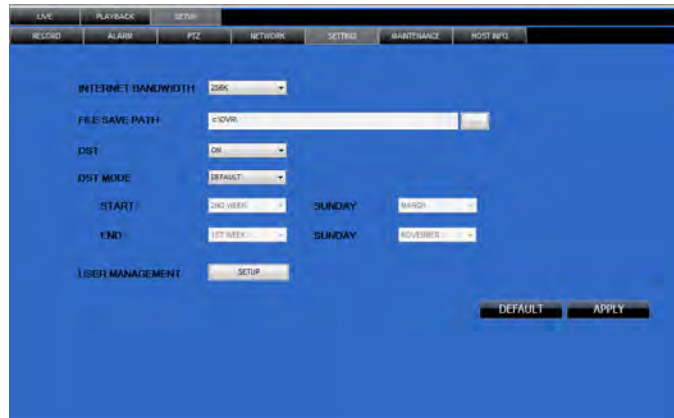

Remote Setup - Setting Screen

MAINTENANCE

You can check and change the parameter settings as configured in the DVR along with rebooting the system and upgrading firmware.

- TELECONTROL:** Remote reboot DVR or format HDD.
- REMOTE UPGRADE:** Remote upgrade DVR firmware.

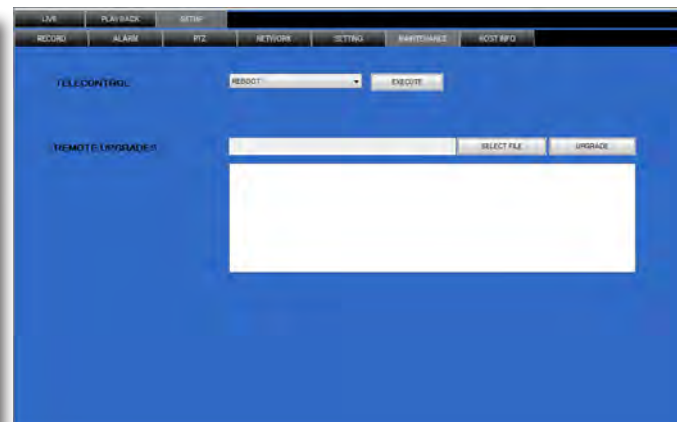

Remote Setup - Maintenance Screen

HOST INFO

This interface allows you to view system information such as HDD status, remain record time, firmware version and MAC Address. All the information is for viewing only and cannot be changed remotely.



Remote Setup - Host Info Screen

MOBILE PHONE

Mobile Setup

Mobile allows you to send alerts to your cellular phone running Windows Mobile Pro (6.0 or later), Symbian (S60 3rd or later), Android, Blackberry (Curve 8900, Bold 9700, Tour 9630), or iPhone on 3G networks. The instructions on how to install and use the software for the different phone operating systems are shown below. This installation CD includes the software needed for Windows Mobile Pro, Symbian, Android, and Blackberry. To use with an iPhone you need to download the software from the iTunes app store.

For all phones configure **MOBILE** settings as follows:

- From the **MAIN** Menu click **ADVANCED** then **MOBILE**.
- Under **MOBILE NETWORK**, select 3G, 2.75G, or 2.5G. **NOTE:** Contact your cellular provider if you are unsure about the network of your cellular phone.
- Under **MOBILE PORT**, enter your mobile port number. **Note:** this port can't be the same with any other port and different DVR's should have different sever ports.
- Click **APPLY**. Click **OK** in the confirmation window.
- Click **EXIT** in all menus until all windows are closed.

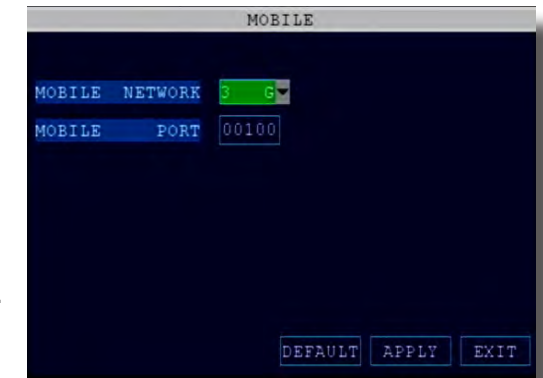

Mobile Setup



Mobile Access

NOTE! Before you can use Mobile Access you need to setup the network configuration on the DVR and forward port 100 as described in the "Port Forwarding" section of this manual.

Windows Mobile Pro (6.0 or later) OS Phones

Step 1: Program Download

Copy the installation program "Meyesetup.CAB" from the Installation CD to the "My Documents" folder on your mobile phone.

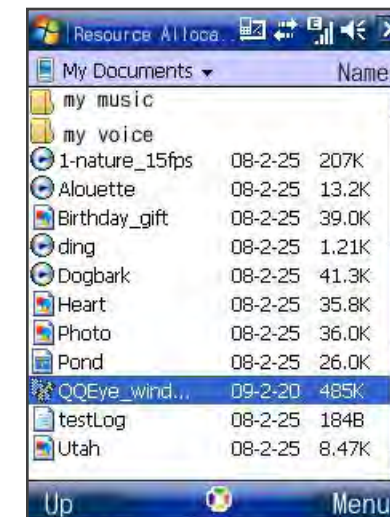

Download Software

Step 2: Select Install Path

Click the program and start to install it, just select default path when it ask you to select install path.



Select Install Path

Step 3: Install Program

Click the Install button to begin installation.

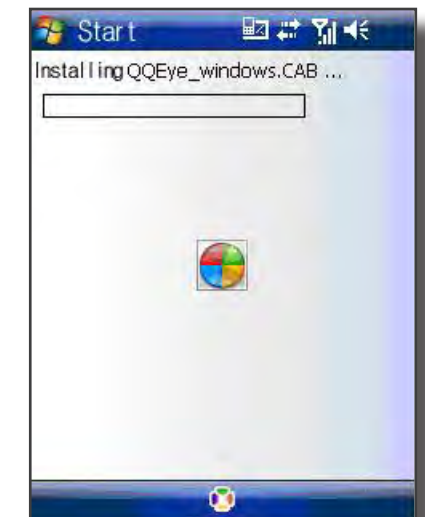

Install Software

Step 4: Launch Program

After installed, click the QQeye icon to run the program.



Click QQeye Icon to Launch

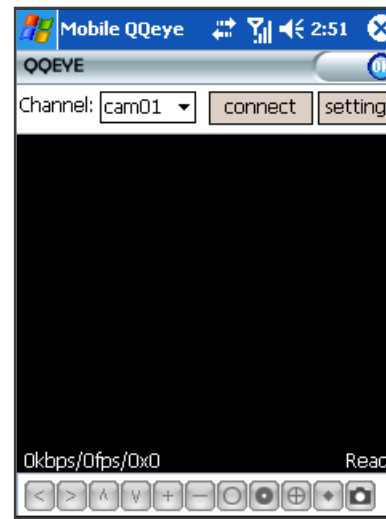

Main Screen

Step 5: Network Parameters

When you login for the first time, go to the "Settings" tab and configure the network parameters first. These should be the same as on the DVR.

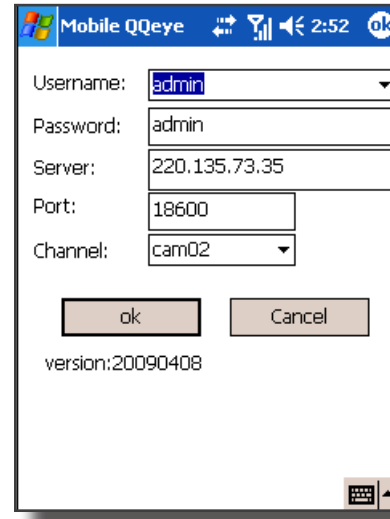

Setup Network Parameters

Symbian (S60 3rd or later) OS Phones

Your DVR can be configured to be viewed remotely on your smartphone running the Symbian OS using the MEye software.

Step 1: Program Download

Copy the install program MEye.3rd.sisx for third edition or MEye.5th.sisx for fifth edition appropriate to your version of the Symbian operating system from the CD included with your DVR to your mobile phone. The default save path is memory card.

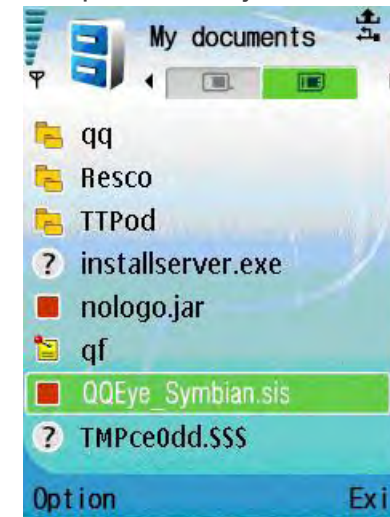

Download Software

Step 2: Program Install

Click the program and install it.

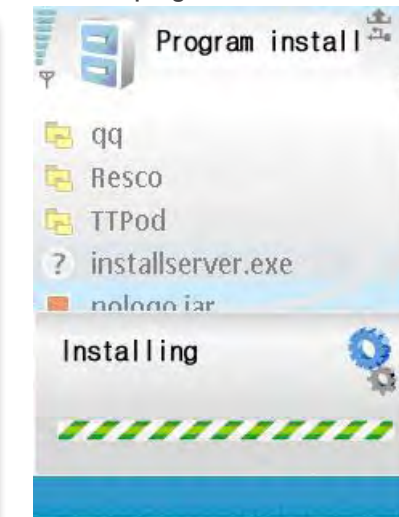

Program Install

Step 3: Install Location

Choose to install the program to the phone's internal memory or onto an SD card.

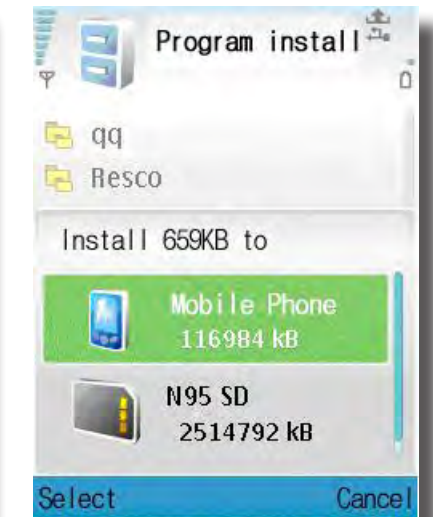

Confirm Install Location



Step 6: Main Interface and Controls

- Channel: Select the channel you want to monitor. When you select a channel, it will connect to DVR automatically.
- Connect: Connects and Disconnects to the DVR.
- Settings: You will need to enter the Settings menu when you first access this program in order to configure the phone to access the DVR.
- Snapshot default save path is: Program\QQeye\photo.
- Button Definitions: Note, you must have a PTZ camera(s) connected for these functions to operate.

| ITEM | FUNCTION |
|------|--------------------------|
| 1 | PTZ Directional Controls |
| 2 | PTZ Zoom |
| 3 | PTZ Focus |
| 4 | PTZ Iris Controls |
| 5 | Snapshot |

Display Mode

1 2 3 4 5

Step 4: Internet Connection

Confirm the program can connect to the internet.

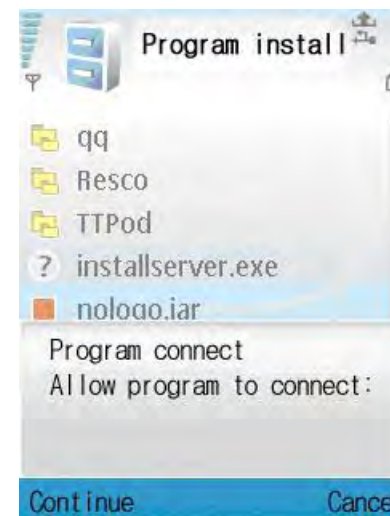

Allow Program to Connect

Step 5: Install Successful

The message, "Install successful" will display after the program is finished installing.

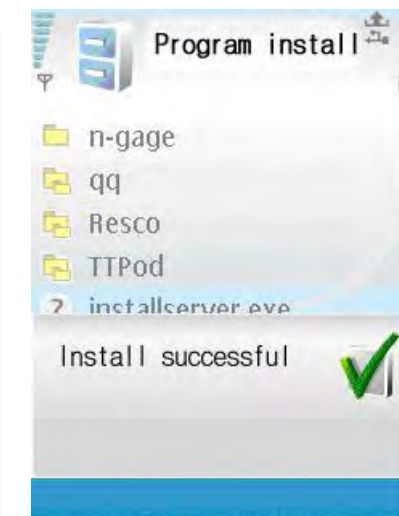

Install Successful

Step 6: Launch Program

After installed, click the QQeye icon to run the program.



Launch QQeye Program

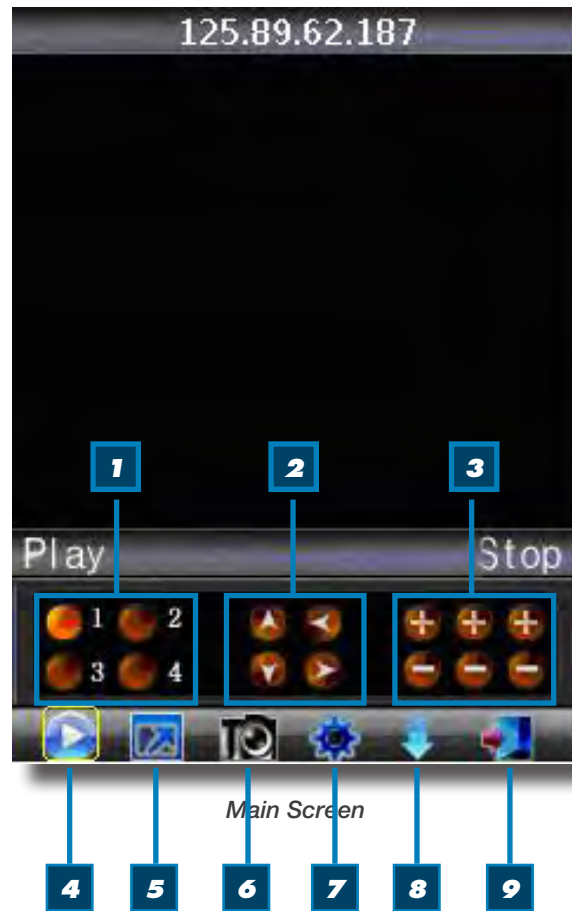

Step 7: Main Interface and Controls

- Snapshot default save path is: C:\Data\Images.
- Button Definitions: Note, you must have a PTZ camera(s) connected for PTZ functions to operate.
- The "NextGroup" button switches the camera displays in groups of 4, i.e. 1-4; 5-8, etc. depending on how many channels your system can support and how many cameras you have connected.

| ITEM | FUNCTION |
|------|-----------------------------------|
| 1 | Channel Selection |
| 2 | PTZ Directional Control |
| 3 | PTZ Zoom, Focus and Iris Controls |
| 4 | Play/Pause |
| 5 | Full/Normal Screen View |
| 6 | Snapshot |
| 7 | Settings |
| 8 | Next Channel Group |
| 9 | Exit |

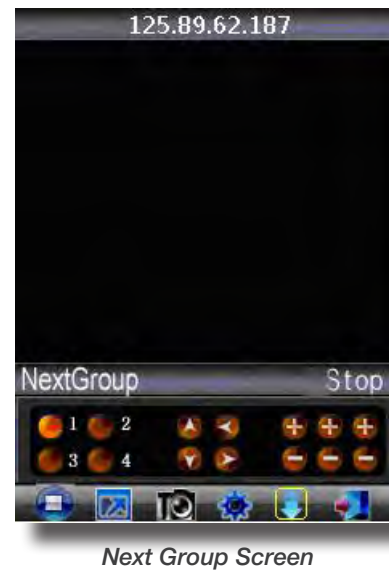

Android 1.5 Mobile OS Phones

Your DVR can be configured to be viewed remotely using a smartphone running the Android mobile OS using the MEye software.

Step 1: Program Download

Copy the installation program "Meye.apk" from the Installation CD to your mobile phone. The default save path is My Documents.

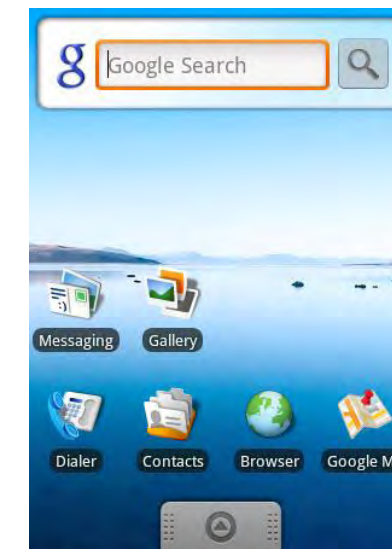

Program Download

Step 2: Install Program

Go to your phone and install Meye by clicking on the Install button on the screen. Once installed, click on Open to launch the program.

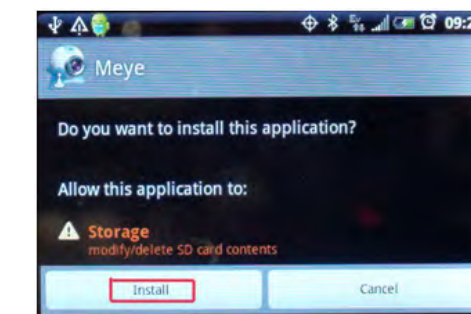

Install Application

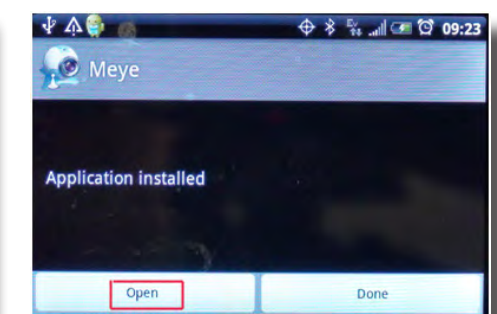

Install Complete

Step 8: Network Parameters

When you login for the first time, go to the "Settings" tab and configure the network parameters first. These should be the same as on the DVR.



Network Settings - Screen 1



Network Settings - Screen 2

Display Mode

Normal/Full Screen. Clicking the screen can switch the display mode between normal and full screen.



Display Mode

Step 3: Main Interface and Controls

- Snapshot default save path is phone's default gallery directory.
- Button Definitions:
- The "Next Channel Group" button switches the camera displays in groups of 8, i.e. 1-8; 9-16, etc. depending on how many channels your system can support and how many cameras you have connected.

| ITEM | FUNCTION |
|------|----------------------------|
| 1 | Channel Buttons |
| 2 | Start/Stop |
| 3 | Normal View/Magnified View |
| 4 | Snapshot |
| 5 | Settings |
| 6 | Next Channel Group |
| 7 | Program Information |

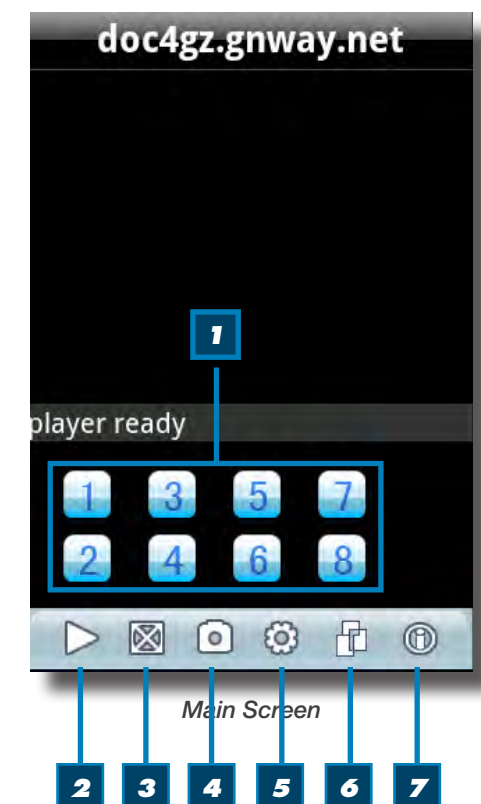

Step 4: Network Parameters

When you login for the first time, go to the "Settings" tab and configure the network parameters first. These should be the same as on the DVR.

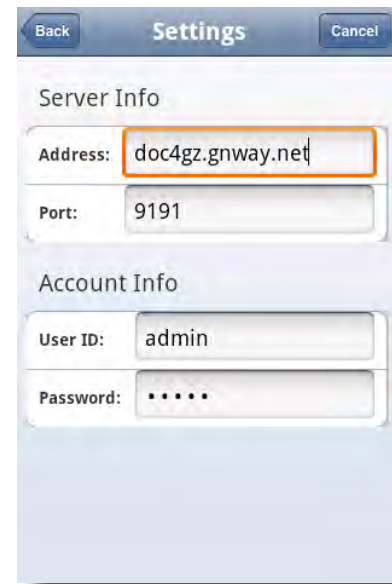

Settings Screen

Apple iPhone on 3G Networks

Your DVR can be configured to be viewed remotely on your iPhone or iPad using the MEye software. System requirements: iPhone or iPad 2.0 or greater with at least 800KB of free space. iTunes is optional.

1. Open your iPhone and click App Store.
2. Under the search bar type "Meye" and click search button. Download the Mobile Viewing Application for free, the file name is Meye.
3. Click the Meye icon, the application will install on your iPhone.

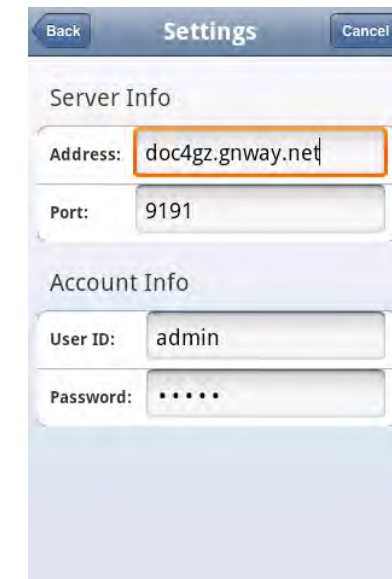

Settings Screen

Step 4: Network Parameters

When you login for the first time, go to the "Settings" tab and configure the network parameters first. These should be the same as on the DVR.



iPhone App screen

View Modes

You can switch between normal mode and magnify mode. When you revolve your phone, it automatically switches to full screen mode.

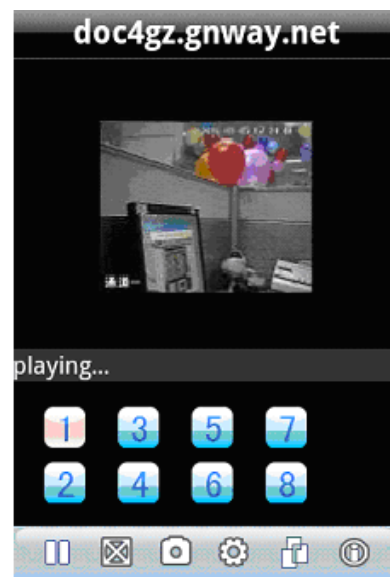

Normal Mode

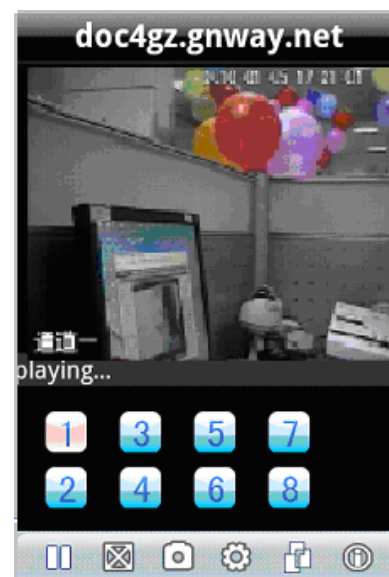

Magnify Mode



Full Screen Mode

Step 5: Main Interface and Controls

- Snapshot default save path is phone's default gallery directory.
- Button Definitions:
- The "Next Channel Group" button switches the camera displays in groups of 8, i.e. 1-8; 9-16, etc. depending on how many channels your system can support and how many cameras you have connected.

| ITEM | FUNCTION |
|------|----------------------------|
| 1 | Channel Buttons |
| 2 | Start/Stop |
| 3 | Normal View/Magnified View |
| 4 | Snapshot |
| 5 | Settings |
| 6 | Next Channel Group |
| 7 | Program Information |

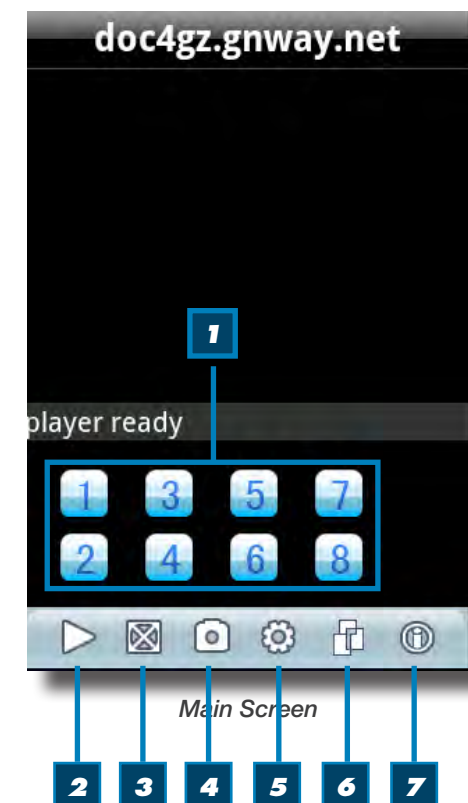

Main Screen

Blackberry OS 5.0 Phones (Curve 8900, Bold 9700, Tour 9630)

Your DVR can be configured to be viewed remotely using a smartphone running the BlackBerry mobile OS version 5.0 using the MEye software.

1. Connect the BlackBerry to your PC via USB Cable.
2. Launch BlackBerry Desktop Manager and run select Import Files.
3. Locate MEye.cod and MEye.alx (it may be easier to copy the two files to your hard drive) and click on OPEN.
4. The files will be imported to your phone.
5. Desktop Manager will show that MEye is now installed on your phone.

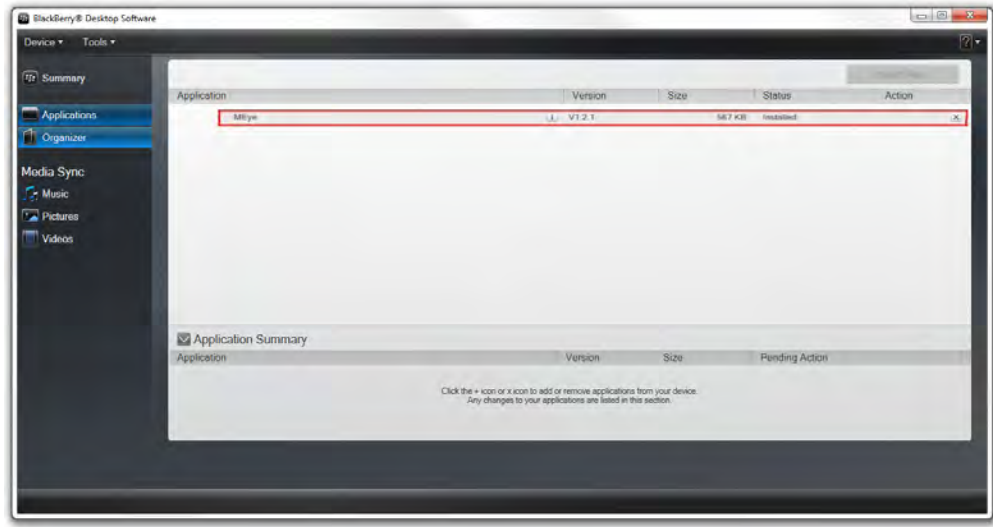

Blackberry Desktop Manager Install Menu

Step 6: Icon

Remove the USB Cable and go the Download Menu on your phone to launch the application

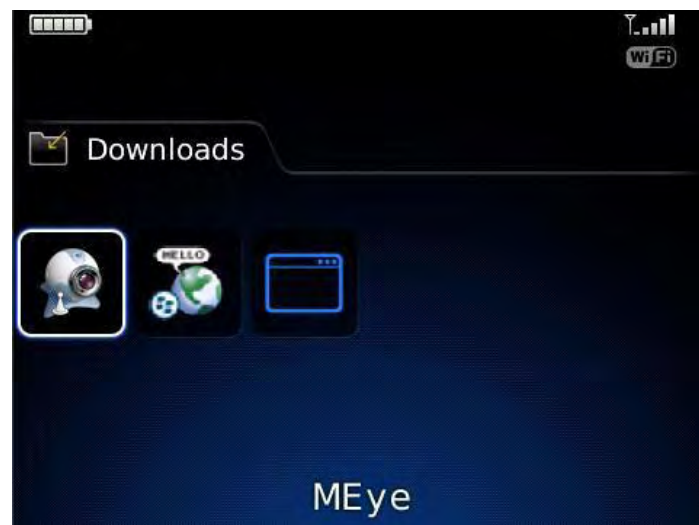

Blackberry Download Menu

Step 7: Main Interface and Controls

- Snapshot default save path is phone's default gallery directory.
- Button Definitions:
- The "Next Channel Group" button switches the camera displays in groups of 4, i.e. 1-4; 5-8, etc. depending on how many channels your system can support and how many cameras you have connected. The icons which are not defined are non-functional.

| ITEM | FUNCTION |
|------|----------------------------|
| 1 | Channel Buttons |
| 2 | Start/Stop |
| 3 | Normal View/Magnified View |
| 4 | Snapshot |
| 5 | Settings |
| 6 | Next Channel Group |
| 7 | Program Information |



Main Screen

Step 8: Network Parameters

When you login for the first time, go to the "Settings" tab and configure the network parameters first. These should be the same as on the DVR.



Blackberry Settings Screen

Main Screen - Video Display Mode

You can switch between full screen and regular screen mode.



Blackberry Operational Screen Mode

HARD DRIVE REMOVAL AND INSTALLATION

HDD Installation

To install or replace the hard drive in the DVR:

1. CAUTION: TO REDUCE THE RISK OF ELECTRIC SHOCK. UNPLUG ALL POWER SOURCES, INCLUDING CAMERAS FROM THE DVR BEFORE REMOVING COVER. FAILURE TO DO SO CAN RESULT IN DAMAGE TO THE DVR OR ITS COMPONENTS AS WELL AS INJURY OR DEATH
2. Remove screws securing the cover of the DVR and remove cover
3. Disconnect the hard drive power and data cables
4. Remove the screws securing the hard drive rails to the chassis. (See image at right)
5. Remove screws securing hard drive rails to hard drive
6. Remove old hard drive and replace with the new one.
7. Re-install the screws securing the hard drive to the rails and rails to the chassis.
8. Re-connect the hard drive power and data cables.
9. Replace the cover and screws. Note: Format hard drive per instructions in HDD MANAGEMENT section.

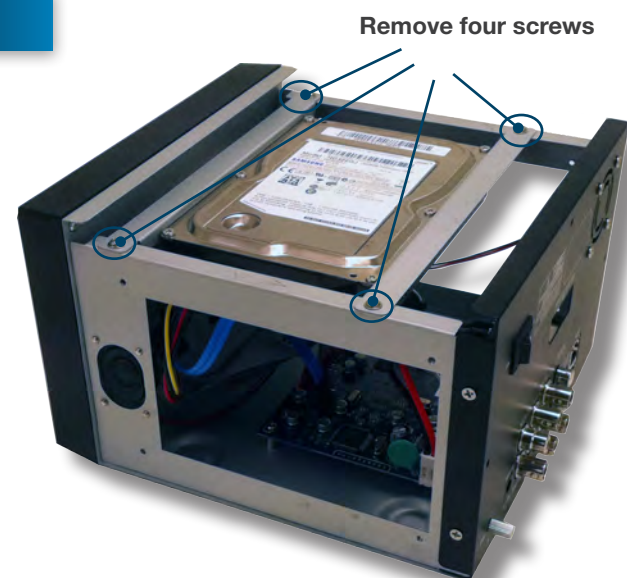

Remove Screws Securing Rails to Chassis

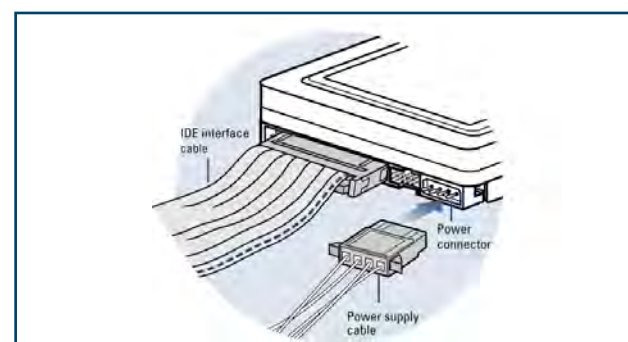

Hard Drive - Remove/Connect Cables

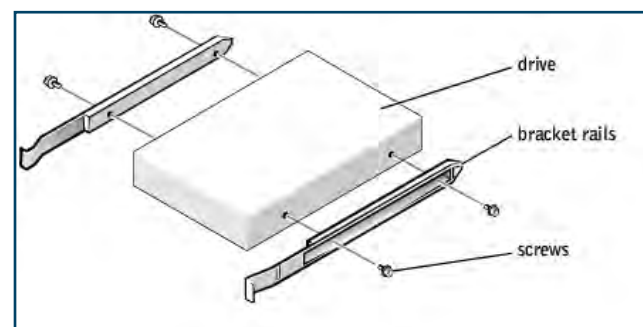

Hard Drive - Remove/Install Rails



Caution!

When working with electrostatic sensitive devices such as hard disk or DVR unit, make sure you use a static-free workstation. Any electrostatic energy coming in contact with the hard disk or DVR can damage it permanently.



Hard Drive Format

NOTE: A new hard drive must be formatted after installation. Format per instructions in the HDD MANAGEMENT section of this manual.



CAUTION!

RISK OF ELECTRIC SHOCK



CAUTION: TO REDUCE THE RISK OF ELECTRIC SHOCK. UNPLUG ALL POWER SOURCES, INCLUDING CAMERAS FROM THE DVR BEFORE REMOVING COVER. FAILURE TO DO SO CAN RESULT IN DAMAGE TO THE DVR OR ITS COMPONENTS AS WELL AS INJURY OR DEATH.



The lightning flash with arrowhead symbol, within an equilateral triangle, is intended to alert the user to the presence of un-insulated "dangerous voltage" within the product's enclosure that may be of sufficient magnitude to constitute a risk of electric shock.



The exclamation point within an equilateral triangle, is intended to alert the user to the presence of important operating and maintenance (servicing) instructions in the literature accompanying the appliance.

TECHNICAL SPECIFICATIONS

| ITEM | DEVICE PARAMETER | SPECIFICATION |
|--------------------------------|-----------------------|--|
| SYSTEM | Language | English/ Chinese |
| | GUI | 16 Bit Graphic menu (OSD Menu) |
| | Password | User password, Administrator password |
| VIDEO | Video in | 4 ch composite video input 1.0Vp-p, impedance 75Ω, BNC |
| | Video out | 1 ch composite video output, BNC |
| | Video display | 4-channel: 1/4 channel switch |
| AUDIO | Video standard | PAL, 25 f/s, CCIR 625line, 50 scene NTSC, 30 f/s, CCIR 525 line, 60 scene |
| | Audio input | 2-ch audio input, impedance 600Ω, RCA |
| | Audio output | 1-ch audio output, impedance 600Ω, RCA |
| | Record style | Audio video recorded simultaneously |
| PICTURE PROCESSING AND STORAGE | Audio compression | ADPCM |
| | Picture compression | H.264 |
| | Picture resolution | CIF/HD1/D1 |
| | Audio style | ADPCM |
| | Video code rate | CIF: 384~768 Kbps HD1: 512~1024 Kbps D1: 512~1024 Kbps |
| | Audio code rate | 32 KB/s |
| ALARM | Data storage | One 500GB SATA HDD included, up to 2 TB capable |
| | Alarm input | 4 alarm inputs |
| CONNECTIONS | Alarm output | 1 alarm output |
| | PTZ interface | Supports PELCO-D, PELCO-P |
| | Mouse | Mouse USB 1.1 |
| | Data | USB 2.0 |
| VGA | Network interface | RJ45, 10M/100M |
| | VGA output | None |
| SOFTWARE UPGRADE | USB | Supports USB firmware upgrade |
| | Voltage input | AC:110~240V, DC 12V |
| OTHER | Power Consumption | 8.7W without HDD |
| | Working temperature | 14 °F to 122 °F (-10 °C to 50°C) |
| | Video impedance input | 75Ω each channel |
| | Video output | 1Vp-p CVBS signal |

FAQ's

If your problem is not listed below, please call our toll-free number for more support. Tech Services: 800-323-9005.

Question: Why is the DVR not working after starting?

Answer:

- Check the power adaptor input
- Check the on-off power line, is it well-connected?
- Check the power on-off switch on the back of the unit
- Check the main board of DVR is connected properly

Question: Why is the DVR rebooting automatically or stopping for several minutes after starting?

Answer:

- Instability or low input voltage
- Bad track on hard drive or the hard drive is bad
- Insufficient power supply
- Instability of the front-end video signal
- High temperature, too much dust, bad DVR operating environment
- Check to make sure the main board connector is secure
- The hardware of DVR is defective

Question: Why is there no video output on single, multi or all channels?

Answer:

- Please check the adaptor of camera whether to see if it is well-connected
- Please check the cable for connecting video input/output in the back panel of DVR
- Please insert the video source directly into the display device and check if they are causing the problem.
- Check the brightness of the picture and bring it back to its original default setting
- No video input signal or too weak
- In Display Setup, Preview is set to OFF for a particular channel
- The DVR hardware is defective

Question: Why can't the DVR record after startup and why is there an "H" showing on the screen?

Answer:

- Make sure power adaptor is DC 12V
- Make sure hard drive is formatted
- Check the power and data connection cables of the hard drive
- The hard drive is defective
- The SATA port is not working

Question: What is the meaning of the letters "R", "M", "I", "H" and "B" showing on the screen?

Answer:

- "R" means the channel is recording
- "M" means motion detection on the channel
- "I" means alarm on the channel
- "H" means either the hard drive is not installed, it is bad or full or needs formatting
- "B" means Tamper Alarm has been activated

Question: Why is the DVR having a problem with real-time images, such as bad image color or serious brightness distortion?

Answer:

- If PAL and NTSC are not correctly selected, the images will be in black and white and rolling
- DVR is not compatible with external monitor (if connected through Video Out BNC Connection)
- The video transmission distance (cable run) is too long. You may need to upgrade to RG59 Coax BNC/DC Power cables for runs longer than 60 feet.
- The setting of DVR color settings need to be adjusted

Question: Why is there no audio sound when monitoring?

Answer:

- Check sound box or speaker functions. Also check possible short circuit.
- Audio source may be connected to the video channel. You can click to full-screen to check.
- The hardware of DVR is defective
- Cameras are not audio capable or no powered microphone is connected.

Question: Why is there no audio when playing back?

Answer:

- Audio settings not correct: open audio-video item and check the audio to see if it is closed in playback interface

Question: Why is my system time not correct?

Answer:

- Wrong setting or user did not click "Edit" to confirm
- Circuit Board battery is not connected properly
- Circuit Board battery is dead. Please change.

Question: Why does the "Stop recording" by the right mouse button not work?

Answer:

- The "Stop recording" by the right mouse button is only suitable for Manual recording.

Question: Why does the "Stop recording" function (Main Menu with right mouse button) not work?

Answer:

- The "Stop recording" by the right mouse button is for Manual Recording only. It can not stop recording when it is on a set schedule or on motion recording. If you want to stop a scheduled recording, please make changes in the RECORD menu.

Question: Why is motion detection not working?

Answer:

- The setting of motion detection area is not correct
- Sensitivity is too low

Question: Why do I have a USB device error?

Answer:

- The data exceeds the capacity of backup device
- The backup device is incompatible
- The backup device is damaged

Question: Why does the Remote Control not work?

Answer:

- The remote control is not for this DVR
- The distance of remote control is too far or the angle is too great
- Remote control batteries are dead or low
- Remote control is damaged or the receiver port on the front panel of DVR is damaged or blocked

Question: Why can't I log in over the Internet?

Answer:

- Please check the network to see if it is connected. Check if LINK or 100M LED is displayed normally on the panel; use ping xxx.xxx.xxx.xxx (DVR IP) to check if the Internet is linked properly.
- Make sure you are running Windows 7, Vista or XP operating system and Internet Explorer 6.0 - 8.0
- ActiveX control has been blocked. Please manually install ActiveX control again.
- Please install DX8.1 and upgrade your video card driver

Question: Why is there is no picture or picture is not clear when I preview the recording or playback the recording via Internet Explorer?

Answer:

- Please choose "WAN" in "web environment"
- Try opening and closing windows again by right clicking the mouse button

Question: Why am I receiving a message indicating "other members are setting....." when accessing my DVR settings through Internet Explorer

Answer:

- Someone else is setting the DVR or the Main Menu is open on the DVR. Close the DVR configuration interface or exit the DVR.

Question: Why do I get a message stating "Not Enough Resources" when I have not exceeded the 480 frame rate total for NTSC recording?

Answer:

- Although the chipset is the standard NTSC 480, part of the resources are used for other internal functions and cannot be allocated to recording resources. A frame rate of 420 fps is the maximum that can be allocated.

TROUBLESHOOTING

| ERROR | POSSIBLE CAUSE | SOLUTIONS |
|--|--|--|
| System is not receiving power or is not powering up | Cable from power adapter is loose or is unplugged | <ul style="list-style-type: none"> Confirm that all cables are connected correctly Confirm that the power adapter is securely connected to the back of the unit |
| | Cables are connected, but system is not receiving sufficient power | <ul style="list-style-type: none"> Confirm that the system is powered on (LED indicators on the front should be ON) If the unit is connected through a power bar or surge protector, try bypassing the bar and connecting the power directly to the wall outlet Confirm that there is power at the outlet <ul style="list-style-type: none"> Connect the power cable to another outlet Test the outlet with another plugged device |
| Remote control not detected by the system | Battery in the remote control is drained or is missing | <ul style="list-style-type: none"> Install two fresh AAA alkaline batteries in the remote control |
| Hard drive is not detected by the system | Hard Drive is not formatted | <ul style="list-style-type: none"> Format the hard drive per instructions |
| | Hard drive cables are loose or not properly connected | <ul style="list-style-type: none"> Remove the housing and check that hard drive cables are firmly connected |
| | There is no hard drive in the system | <ul style="list-style-type: none"> Open the housing and install a 3.5 SATA hard drive |
| Hard drive is full (10% remaining) and the unit is no longer recording | Overwrite is not enabled | <ul style="list-style-type: none"> From the Main Menu, select HDD>Overwrite>Enable and click Apply |
| Mouse not detected by system | Mouse cable is not connected or is not firmly connected to the system | <ul style="list-style-type: none"> Firmly connect the mouse cable to the USB Mouse port (not the USB Data port) on the back panel. |
| | System needs to be reset | <ul style="list-style-type: none"> Power off the system (Turn power switch off position on back of unit). Firmly connect a USB mouse to the USB Mouse port on the back panel of the system. Power on the system (Turn power switch to on position on back of unit). |
| There is no picture on selected channels/camera picture is not being displayed | Camera cables are loose or have become disconnected | <ul style="list-style-type: none"> Check the camera video cable and connections Disconnect and reconnect the cable at the system and at the camera Try moving the camera to another channel or use another cable |
| The image on the DVR appears but does not have sound | Audio cables are loose or have been disconnected | <ul style="list-style-type: none"> Check the AUDIO connections to the DVR |
| | Audio channels are disabled the system menu | <ul style="list-style-type: none"> Check the Configurations: Main Menu>Record>Audio |
| | Volume on external speakers (not included) is low or off | <ul style="list-style-type: none"> Increase volume on external speakers (not included) |
| | Cameras are not audio capable or a powered microphone is not attached | <ul style="list-style-type: none"> Add audio capable cameras or a powered microphone (not included with this kit) |
| The system beeps at startup | The beep at startup is normal | <ul style="list-style-type: none"> Speakers must be connected to hear beep |
| I am not receiving e-mail notifications | E-mail notification is disabled | <ul style="list-style-type: none"> Open Main Menu>Advance>Alarm; click E-MAIL SETUP; under E-MAIL select ON |
| | Default setting is disabled and /or you have not entered your own SMTP information | <ul style="list-style-type: none"> If you want to use your own SMTP server, deselect the Default box, and enter your SMTP Server Address, Port, User name, and Password in their respective fields |

WARRANTY

PRODUCT LIMITED WARRANTY

BRK Brands, Inc., ("BRK") the maker of First Alert® brand products warrants that for a period of one year from the date of purchase (the "Warranty Period"), this product will be free from defects in material and workmanship. BRK, at its sole option, will repair or replace this product or any component of the product found to be defective during the Warranty Period. Replacement or repair will be made with a new or remanufactured product or component. If the product is no longer available, replacement may be made with a similar product of equal or greater value. This is your exclusive warranty.

This warranty is valid for the original retail purchaser only from the date of initial retail purchase and is not transferable. In order to obtain warranty service, you must keep the original sales receipt and proof of purchase in the form of the UPC code from the package. BRK dealers, service centers, or retail stores selling BRK products do not have the right to alter, modify or any way change the terms and conditions of this warranty.

WARRANTY EXCLUSIONS

Parts and Labor: 1 year limited (warranted parts do not include bulbs, LEDs, and batteries)

This warranty does not apply to bulbs, LEDs, and batteries supplied with or forming part of the product.

This warranty is invalidated if non- BRK accessories are or have been used in or in connection with the product or in any modification or repair is made to the product.

This warranty does not apply to defects or damages arising by use of the product in other than normal (including normal atmospheric, moisture and humidity) conditions or by installation or use of the product other than in strict accordance with the instructions contained in the product owner's manual.

This warranty does not apply to defects in or damages to the product caused by (i) negligent use of the product, (ii) misuse, abuse, neglect, alteration, repair or improper installation of the product, (iii) electrical short circuits or transients, (iv) usage not in accordance with product installation, (v) use of replacement parts not supplied by BRK, (vi) improper product maintenance, or (vii) accident, fire, flood or other Acts of God.

This warranty does not cover the performance or functionality of any computer software included in the package with the product. BRK makes no warranty that the software provided with the product will function without interruption or otherwise be free of anomalies, errors, or "Bugs." This warranty does not cover any costs relating to removal or replacement of any product or software installed on your computer.

BRK reserves the right to make changes in design or to make additions to or improvements in its products without incurring any obligations to modify any product which has already been manufactured. BRK will make every effort to provide updates and fixes to its software via its website. This warranty does not cover any alteration or damage to any other software that may be or may become resident on the users system as a result of installing the software provided. This warranty is in lieu of other warranties, expressed or implied, and BRK neither assumes nor authorizes any person to assume for it any other obligation or liability in connection with the sale or service of the product. In no event shall BRK be liable for any special or consequential damages arising from the use of the product or arising from the malfunctioning or non-functioning of the product, or for any delay in the performance of this warranty due to any cause beyond its control.

BRK does not make any claims or warranties of any kind whatsoever regarding the product's potential, ability, or effectiveness to prevent, minimize, or in any way affect personal or property damage or injury. BRK is not responsible for any personal damage, loss, or theft related to the product or to its use for any harm, whether physical or mental related thereto. Any and all claims or statements, whether written or verbal, by salespeople, retailers, dealers, or distributors to the contrary are not authorized by BRK, and do not affect this provision of this warranty.

BRK's responsibility under this, or any other warranty, implied or expressed, is limited to repair, replacement or refund, as set forth above. These remedies are the sole and exclusive remedies for any breach of warranty. BRK is not responsible for direct, special, incidental, or consequential damages resulting from any breach of warranty or under any other legal theory including but not limited to, loss profits, downtime, goodwill, damage to or replacement of equipment and property and any costs of recovering, reprogramming or reproducing any program or data stored in or used with a system containing the product accompanying software. BRK does not warrant the software will operate with any other software except that which is indicated. BRK cannot be responsible for characteristics of their party hardware or software which may effect the operation of the software included.

Except to the extent prohibited by applicable law, any implied warranty of merchantability or fitness for a particular purpose is limited in duration to the duration of the above Warranty Period. Some states, provinces, or jurisdictions do not allow the exclusion or limitation of incidental or consequential damages or limitations on how long an implied warranty lasts, so the above limitations or exclusion may not apply to you. This warranty gives you specific legal rights, and you may also have other rights that vary from state to state, or province to province, or jurisdiction to jurisdiction.

OBTAINING SERVICE

If service is required, do not return the product to your place of purchase. In order to obtain warranty service, contact the Consumer Affairs Division at 1-800-323-9005, 7:30 a.m. – 5:00 a.m. Central Standard Time, Monday through Friday. To assist us in serving you, please have the model number and date of purchase available when calling.

After contacting the Consumer Affairs Division and it is determined that the product should be returned for Warranty Service, please mail the product to: BRK Brands, Inc., 3901 Liberty Street Road, Aurora, IL 60504-8122.

First Alert[®]

©2012 BRK Brands, Inc.
a Jarden Corporation Company (NYSE:JAH)
3901 Liberty Street Road, Aurora, IL 60504-8122
Phone: 630-851-7330 Tech Services: 800-323-9005
www.brkelectronics.com
M08-0399-002

Free Manuals Download Website

<http://myh66.com>

<http://usermanuals.us>

<http://www.somanuals.com>

<http://www.4manuals.cc>

<http://www.manual-lib.com>

<http://www.404manual.com>

<http://www.luxmanual.com>

<http://aubethermostatmanual.com>

Golf course search by state

<http://golfingnear.com>

Email search by domain

<http://emailbydomain.com>

Auto manuals search

<http://auto.somanuals.com>

TV manuals search

<http://tv.somanuals.com>