

Gaming

Imaging

3D

Video

Entertainment

Photos

Graphics

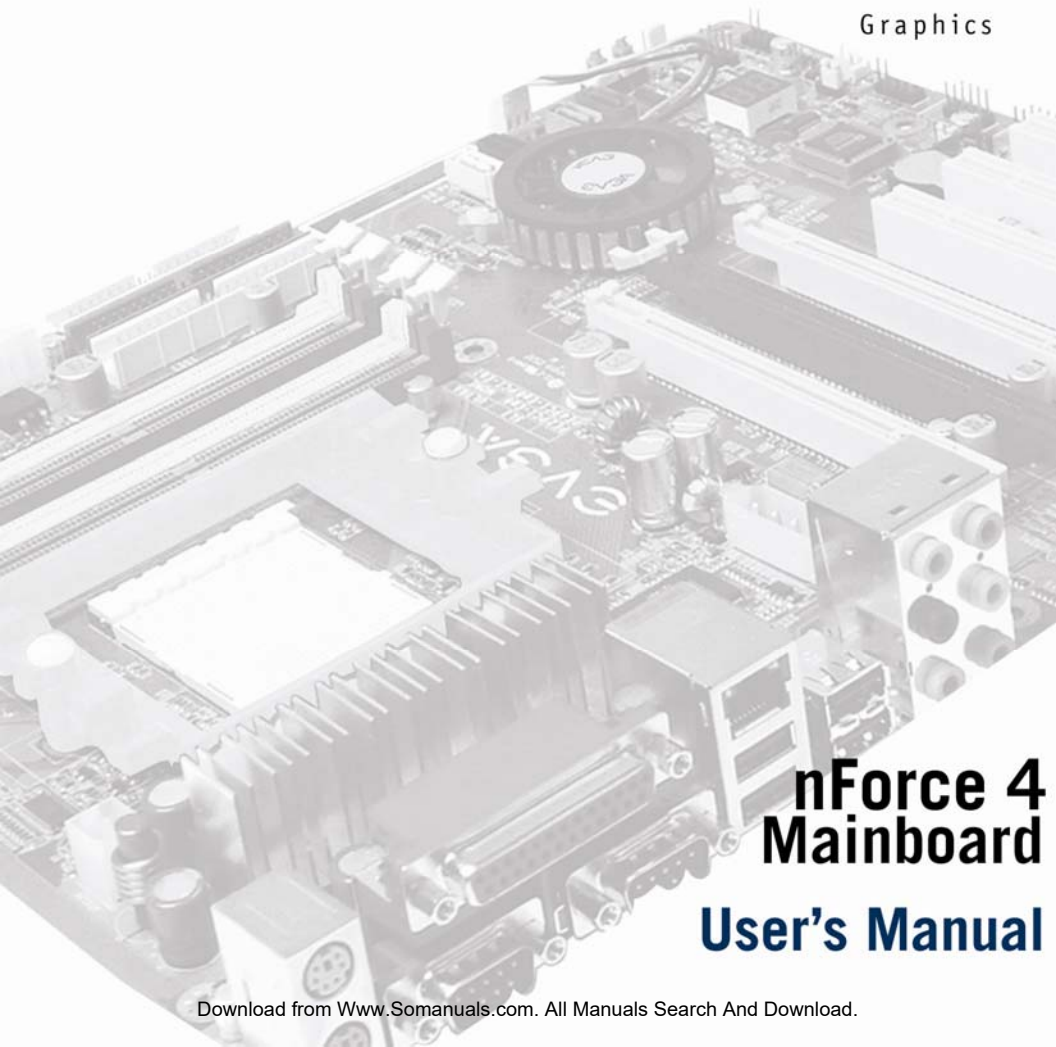

nForce 4 Mainboard

User's Manual

USER'S MANUAL

FOR

EVGA NFORCE4 MOTHERBOARD



MODELS: 131-K8-NF44-XX

131-K8-NF44 MANUAL - REV 1.0 - REV DATE 11 JAN 2006

Notice:

Specifications and information contained in this documentation are furnished for informational use only, and are subject to change at any time without notice, and should not be construed as a commitment by the manufacturer.

This manual covers the following motherboards from EVGA CORP.

131-K8-NF44-XX

CPU SUPPORT

The 131-K8-NF44-XX motherboard will support the following AMD 939 pin CPUs:

- Athlon FX 64 (FX55, FX57, FX60)
- Athlon 64 X2 (Dual Core)
- Athlon 64
- Sempron (when available in 939 pin)



TABLE OF CONTENTS

CHAPTER 1 - Introduction to nForce Motherboards	4
1-1 Motherboard Features	4
1-1.1 Special Features of the Motherboard	5
1-2 Specifications	6
1-3 Layout Diagram and Jumper Settings	7
1-3.1 Jumpers, Connectors, Headers, and Sockets	8
CHAPTER 2 - Hardware Installation	10
2-1 Hardware Installation Steps	10
2-2 Checking The Motherboard Jumper Settings	10
Clearing the CMOS RAM	10
Keyboard Power On Function	11
USB Power On Function	11
2-3 Installing The CPU	11
Glossary of Terms	11
2-3-2 About AMD Athlon64 939-pin CPUs	12
2-4 Installing Memory	13
Memory Installation Diagrams	14
2-5 Expansion Cards	15
2-5-1 Procedure For Expansion Card Installation	15
2-5-2 Assigning IRQs For Expansion Cards	15
2-5-3 Interrupt Request Table	16
2-5-4 PCI-Express Slots	16
Diagram of PCI-Express Slot Locations and Functions	16
Table of Standard IRQ Assignments	17
2-5-5 SLI Bridge Installation For NVIDIA SLI Cards (SLI Version Only)	18
2-6 Connectors and Headers	20
2-6-1 Connector Locations	20
2-7 Starting Up Your Computer	29
Beep Code Table	29
CHAPTER 3 - BIOS	30
3-0 Introducing BIOS	30
3-1 Entering BIOS Setup	30
CHAPTER 4 - DRIVER INSTALLATION	31
4-0 Driver Installation	31
4-1 RAID Installation	32
APPENDIX 1 - POST CODES	33
Quick Debug POST Codes	33
Boot Block POST Codes	34
APPENDIX 2 - TRADEMARKS AND NOTICES	35
Copyrights, Trademarks, and Notices	35
FCC Compliance Statement	35
APPENDIX 3 - WARRANTY INFORMATION	36
APPENDIX 4 - CONTACTING SUPPORT AND OTHER USEFUL INFORMATION	37

Chapter 1

Introduction of nForce4 Motherboards

1-1 Motherboard Features

Motherboards based on NVIDIA nForce4 single chip technology support the innovative 64-bit AMD Athlon64 FX and dual core multi-tasking Athlon64 X2 processors with HyperTransport Technology. The motherboard delivers leading-edge performance with both of the benefits from 64-bit multi-tasking dual core AMD processors and NVIDIA Scalable Link Interface (SLI) Technology. Utilizing the 64-bit multi-tasking socket 939 solution and the dual channel PC3200 DDR memory size expandable to 4.0GB, this motherboard series meets the demands of computing in the future.

These motherboards carry the advanced NVIDIA nForce4 single chip with 1000 MHz HyperTransport system bus of data transferring and provided with 133MHz / 166MHz / 200MHz memory clock frequency for DDR266/DDR333/DDR400 DDR Module with dual channel capability. The NVIDIA nForce4 single chipset offers **ULTRA ATA 133** and **Serial ATA RAID 0, 1, 0+1** functions to accelerate hard disk drives and guarantee data security without failure in advanced computing applications.

The motherboard provides Gigabit LAN by using the NVIDIA Giga-LAN controller which supports 10M/100M/1Gbps data transfer rate and full duplex or half duplex transportation. The embedded 8-channel AC'97 CODEC is fully compatible with Sound Blaster Pro™ standards and offers you home cinema quality and complete software compatibility.

Two 8X PCI-Express graphics slots deliver up to 2Gbyte/sec data transfer rate at each relative direction which is fully compatible with the latest NVIDIA SLI Technology. And, one PCI-Express x16 slot offers full function at speeds of up to 4Gbyte/sec.

The embedded USB controller has the capability of supporting up to 8 USB 2.0 ports, delivering 480Mb/s bandwidth each.

And the embedded Firewire controller allows connection and use of IEEE1394 compliant devices.

1-1.1 Special Features of the Motherboard

CPU Thermal Throttling Technology

To prevent increasing heat from damaging the CPU or causing accidental shutdown while under high workloads, the CPU Thermal Throttling Technology will force the CPU to enter an idle mode from 87.5% to 12.5% according to preset CPU operating temperatures in the BIOS (from 40° to 90°). When the system senses the CPU operating temperature reaching the preset value, the CPU operating bandwidth will be decreased to the preset idle percentage allowing the processor to cool down. When in throttling mode, a beeper sound can be optionally selected to indicate it has reduced the CPU performance. *(for detailed settings, please read the BIOS PDF located on the CD)*



1-2 Specifications

Spec	Description
Design	ATX form factor 4 layers PCB size: 24.5x24.5 cm
Chipset	NVIDIA nForce4 SLI Technology
CPU Socket 939	Supports 64bit AMD Athlon64 939-Pin package processors Support up to 4000+ processor & Dual-Core, Including: Athlon FX 64/64 X2/64/and 939 Sempron
Memory Sockets	184-pin DDR Module socket x 4 Support 4pcs DDR266/DDR33/DDR400 DDR Modules Expandable to 4.0GB Support Dual channel function
Expansion Slots	PCI-Express x16 slot x 1 PCI-Express x8 slot x 2 32 bit PCI slots x 1
Integrated IDE and Serial ATA II RAID	One PCI IDE controller supporting PCI Bus Mastering, ATA PIO/DMA and the ULTRA DMA 33/66/100/133 functions that deliver the data transfer rate up to 133 MB/s; Four Serial ATA II ports provide 300 MB/sec data transfer rate for Four Serial ATA Devices and offer RAID 0, 1, 0+1 functions
LAN	Integrated Gigabit LAN provides 10Mb/100Mb/1Gb /s data transfer rates
8CH-Audio	8-channel AC'97 Digital Audio controller integrated Audio driver and utility included SPDIF-Out Optical support (Cable optional)
BIOS	Award 4MB Flash ROM
Multi I/O	PS/2 keyboard and PS/2 mouse connectors Floppy disk drive connector x1 Parallel port x1 Serial port x1 USB2.0 port x 4 and headers x 4 (connecting cable optional) Audio connector (Line-in, Line-out, MIC/ 8CH Audio) IEEE 1394 Firewire Support Game Port Connector

1-3 Layout Diagram & Jumper Settings

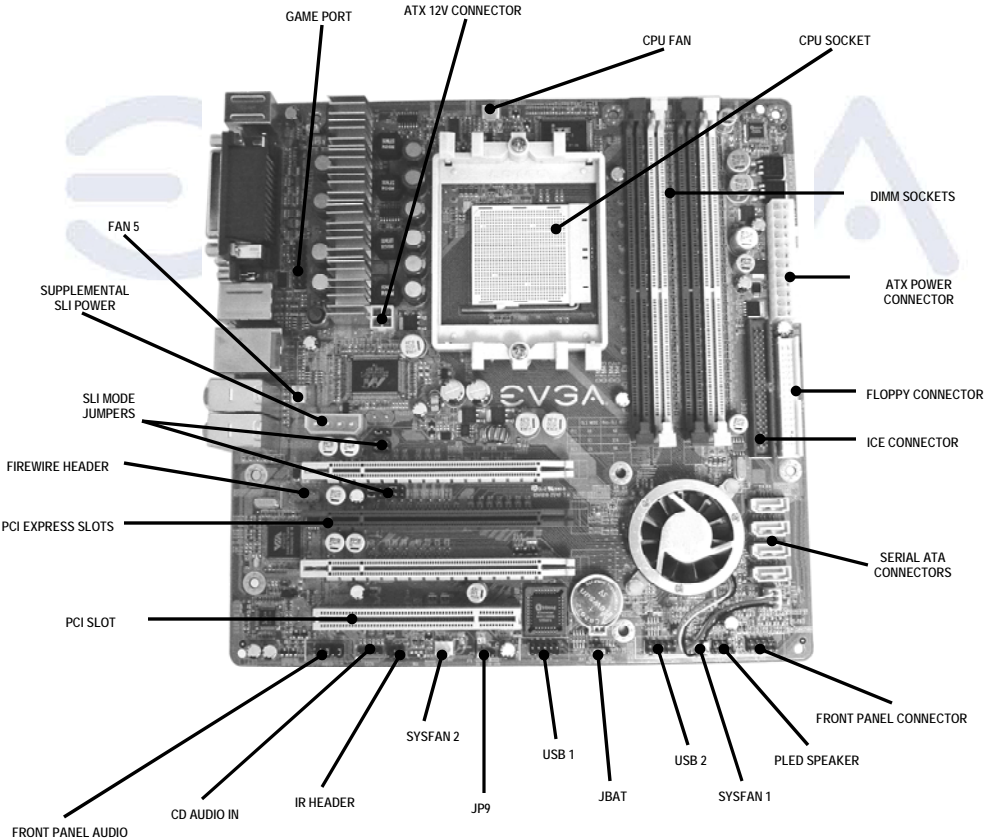
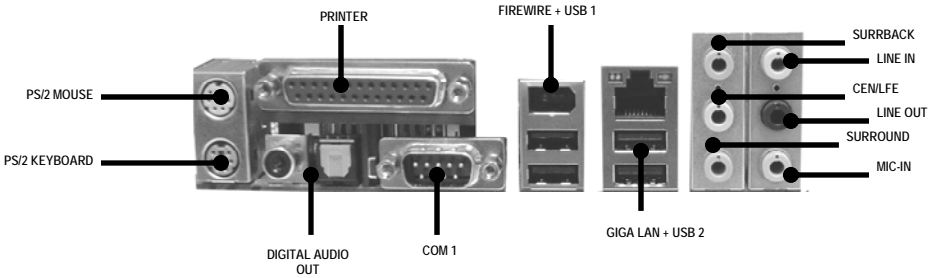

1-3.1 JUMPERS, CONNECTORS, HEADERS, AND SOCKETS

Jumper	Name	Description
JBAT	CMOS ROM Clear	3-pin Block
JP1	Keyboard/USB0,1 Power On Enabled/Disabled	3-pin Block
JP9	USB Power On Enabled/Disabled	3-pin Block
JP2, JP3, JP4, JP5, JP6, JP7, JP8	SLI Selection Mode Jumpers	3-pin Block

Connector	Name	Description
ATXPWR	ATX Power Connector	24-pin Block
ATX12V	ATX 12V Power Connector	4-pin Block
KB	PS/2 Mouse & PS/2 Keyboard Connector	6-pin Female
CN1	Fire Wire and USB Port Connectors	1x Fire Wire/2x USB
UL1	GIGALAN and USB Port Connectors	RJ-45 Connector/2x USB
PARALLEL	Parallel Port Connector	25-pin Female
CN3	8-CH Audio Connector	6 jack Connector
COM1	Serial Port COM1 Connector	9-pin Connector
FDD	Floppy Driver Connector	34-pin Block
IDE1	Primary IDE Connector	40-pin Block
SATA1-4	Serial ATA IDE Connector	7-pin Connector
SPDIF_RX1-1	SPDIF Outputs	TOSLINK and RCA
J1	Supplemental SLI Power Connector	4-pin Molex Type

Header	Name	Description
AUDIO	SPEAKER, MIC header	9-pin Block
USB1-2	USB Port Headers	9-pin Block
SPEAK1	PC Speaker connector	4-pin Block
PWR LED	Power LED	3-pin Block
JW_FP (Power LED/Reset/ IDE LED/Power Button)	Front Panel Header (including Power LED/ IDE activity LED/Reset switch / Power On Button lead)	9-pin Block
CHAFAN, SYSFAN1-2, CPUFAN, FAN5	FAN Headers	3-pin Block
CDIN	CD Audio-In Header	4-pin Block
IR	Ir Header	5-pin Block
GAME1	Game Port Header	15-pin Block
IEEE1	Firewire Header	9-pin Block

1-3.1 JUMPERS, CONNECTORS, HEADERS, AND SOCKETS CONT.

Socket/Slot	Name	Description
ZIF Socket 939	CPU Socket	939-pin mPGAB Athlon64 CPU Socket
DIMM1-4	DDR Module Socket	184-pin DDR Module Socket
PCI1	PCI Slot	32-bit PCI Local Bus Expansion slots
PE1, PE3	PCI-Express x8 Slot	PCI-Express x8 Expansion Slot
PE2	PCI-Express x16 Slot	PCI-Express x16 Expansion Slot



Chapter 2

Hardware Installation

2-1 Hardware Installation Steps

Before using your computer, please complete the following steps:

1. Check motherboard jumper settings
2. Install CPU and Fan
3. Install System Memory (DIMM)
4. Install Expansion cards
5. Connect IDE and Floppy cables, Front /Back Panel cables
6. Connect ATX Power cable
7. Power-On and Load Standard Default BIOS Settings
8. Reboot
9. Install Operating System
10. Install Motherboard Drivers and Utilities

2-2 Checking the Motherboard's Jumper Settings

CMOS RAM Clear (3-pin) : JBAT

A battery must be used to retain the motherboard configuration in CMOS RAM short 1-2 pins of JBAT to store the CMOS data.

To clear the CMOS, follow the procedure below:

1. Turn off the system and unplug the AC power
2. Remove the ATX power cable from the ATX power connector
3. Locate JBAT and short pins 2-3 for a few seconds
4. Return JBAT to its normal setting by shorting pins 1-2
5. Connect the ATX power cable back to the ATX power connector

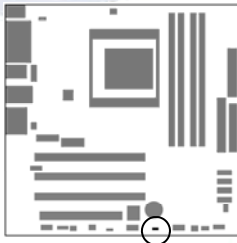

1-2 closed Normal

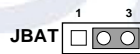

2-3 closed Clear CMOS

CMOS RAM Clear Setting

Keyboard Function Enabled/Disabled: JP1

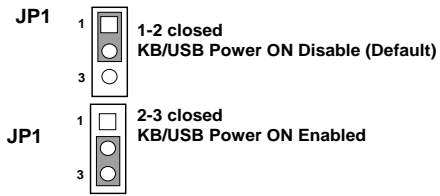
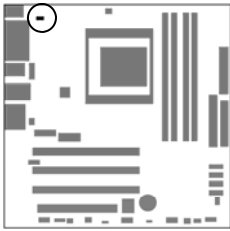

Keyboard/Mouse & USB Power On Setting

USB Power On function Enabled/Disabled: JP9

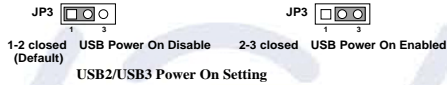
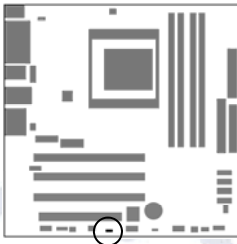

2-3 Install CPU

2-3-1 Glossary

Chipset (or core logic) - one or more integrated circuits which control the interfaces between the system processor, RAM, I/O devices, and adapter cards.

Processor slot/socket - the slot or socket used to mount the system processor on the motherboard.

Slot (PCI-E, PCI, RAM) - the slots used to mount adapter cards and system RAM.

PCI - Peripheral Component Interconnect - a high speed interface for video cards, sound cards, network interface cards, and modems; runs at 33MHz.

PCI-Express- Peripheral Component Interconnect Express- a high speed interface for video cards, sound cards, network interface cards, and modems.

Serial Port - a low speed interface typically used for mouse and external modems.

Parallel Port - a low speed interface typically used for printers.

PS/2 - a low speed interface used for mouse and keyboards.

USB - Universal Serial Bus - a medium speed interface typically used for mouse, keyboards, scanners, and some digital cameras.

Sound (interface) - the interface between the sound card or integrated sound connectors and speakers, MIC, game controllers, and MIDI sound devices.

LAN (interface) - Local Area Network - the interface to your local area network.

BIOS (Basic Input/Output System) - the program logic used to boot up a computer and establish the relationship between the various components.

Driver - software, which defines the characteristics of a device for use by another device or other software.

Processor - the "central processing unit" (CPU); the principal integrated circuit used for doing the "computing" in "personal computer".

Front Side Bus Frequency - the working frequency of the motherboard, which is generated by the clock generator for CPU, DRAM and PCI BUS.

CPU L2 Cache - the flash memory inside the CPU, normal it depend on CPU type.

2-3-2 About AMD Athlon64 939-pin CPUs

This motherboard provides a 939-pin surface mount, Zero Insertion Force (ZIF) socket, referred to as the mPGA939 socket supporting AMD Athlon64 processors in the 939 Pin package utilizing Flip-Chip Pin Grid Array technology.

The CPU that you use with the motherboard should have a cooling FAN attached to prevent overheating. If this is not the case, then purchase the correct cooling FAN before you turn on your system.

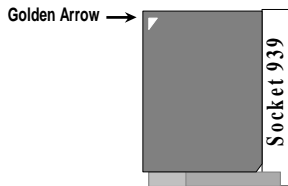
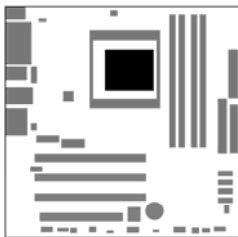

CPU ZIF mPGA939 Socket

WARNING!

Be sure that there is sufficient air circulation across the processor's heatsink and CPU cooling FAN is working correctly, otherwise it may cause the processor and motherboard to overheat and damage your system, you may install an auxiliary cooling FAN, if necessary.

To install a CPU, locate the ZIF socket and open it by first pulling the lever sideways away from the socket then upward to a 90-degree angle. Insert the CPU with the correct orientation as shown on the previous page. The notched corner should point toward the end of the lever. Because the CPU has a corner pin for two of the four corners, the CPU will only fit in the orientation as shown.

When you put the CPU into the ZIF socket. No force is required to insert the CPU. Press the lever to Locate position slightly without any extra force.

2-4 Install Memory

This motherboard provides **four** 184-pin DDR DUAL INLINE MEMORY MODULES (DIMM) slots for DDR memory expansion available from minimum memory size of 64MB to maximum memory size of 4.0GB DDR SDRAM.

Valid Memory Configurations

Bank	184-Pin DIMM	PCS	Total Memory
Bank 0, 1 (DIMM1)	DDRDDR266/DDR333/DDR400 DDR SDRAM Module	X1	128MB-1.0GB
Bank 2, 3 (DIMM2)	DDRDDR266/DDR333/DDR400 DDR SDRAM Module	X1	128MB-1.0GB
Bank 4, 5 (DIMM3)	DDRDDR266/DDR333/DDR400 DDR SDRAM Module	X1	128MB-1.0GB
Bank 6,7 (DIMM4)	DDRDDR266/DDR333/DDR400 DDR SDRAM Module	X1	128MB-1.0GB
Total	System Memory (Max. 4.0GB)	4	128MB-4.0GB

For Dual Channel Memory

Dual channel only operates when 2 DIMM Modules are plugged into either DIMM1 & DIMM3 or DIMM2 & DIMM4, or four DIMM Modules are plugged into DIMM1~DIMM4.

DIMM1 & DIMM3, or DIMM2 & DIMM4 must be the same type, same size, and same frequency for dual channel to function.

Note: Computer will not boot if RAM is in 3 and 4 only.

Generally, installing DDR SDRAM modules to your motherboard is very easy, you can refer to the following page to see what a 184-Pin DDR266/DDR333/DDR400 DDR SDRAM module looks like.

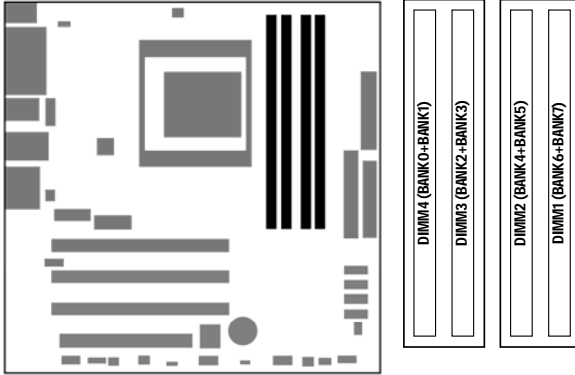

DIMM1 & DIMM3: Dual Channel 1

DIMM2 & DIMM4: Dual Channel 2

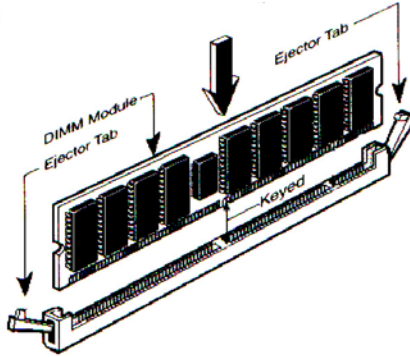

NOTE!

When you install the DIMM modules fully into the DIMM socket the eject tab should be locked into the DIMM module very firmly and fit into its indentation on both sides.

WARNING!

When the DDR SDRAM CLOCK is set at 200MHz, use only DDR400 compliant DDR Modules. When this motherboard operates at 200MHz, most systems will not even boot if non-compliant modules are used because of the strict timing issues involved, if your DDR Modules are not DDR400-compliant, set the SDRAM clock to 133MHz to ensure system stability.

2-5 Expansion Cards

WARNING!

Turn off your system power when adding or removing expansion cards or other system components. Failure to do so may cause severe damage to both your motherboard and expansion cards.

2-5-1 Procedure For Expansion Card Installation

Read the documentation for your expansion card and make any necessary hardware or software setting for your expansion card such as jumpers.

Remove your computer's cover and the bracket plate on the slot you intend to use.

- Align the card's connectors and press firmly.
- Secure the card on the slot with the screen you remove above.
- Replace the computer system's cover.
- Set up the BIOS if necessary.
- Install the necessary software driver for your expansion card.

2-5-2 Assigning IRQs For Expansion Card

Some expansion cards need an IRQ to operate. Generally, an IRQ must be exclusively assigned. In a standard design, there are 16 IRQs available but most of them are already in use. The following table will show you the default assignment of IRQs.

It should be noted that in most modern Plug and Play Operating Systems, that IRQ assignment is handled by the computer itself automatically. This automatic assignment is generally very effective and you should only have to resort to manual assignment in the most extreme cases.

2-5-3 Interrupt Request Table For This Motherboard

Interrupt requests are shared as shown in the table below:

	INT A	INT B	INT C	INT D	INT E	INT F	INT G	INT H
Slot 1		X						
Slot 2			X					
Slot 3				X				
Onboard USB 1	X							
Onboard USB 2		X						
AC97/MC97			X					

IMPORTANT!

If using PCI cards on shared slots, make sure that the drivers support "Shared IRQ" or that the cards don't need IRQ assignments. Conflicts will arise between the two PCI groups that will make the system unstable or cards inoperable.

2-5-4 PCI-Express Slots

This motherboard provides three PCI-Express slots intended for Graphics (Two symmetrical PCI-Express x8 graphics slots deliver up to 2Gbyte/sec data transfer rate at each relative direction which is fully compatible with the latest NVIDIA SLI Technology [SLI version only]). And one x16 PCI-Express Slot intended for single video card solutions. Fully compliant to the *PCI-Express Base Specification revision 1.0a*, supporting PCI-Express VGA cards, and other PCI-Express devices.

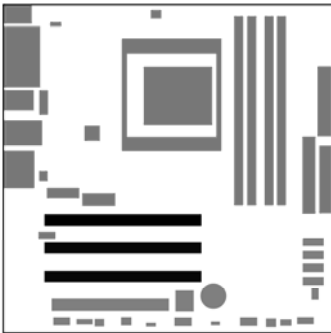

FROM TOP TO BOTTOM

8x PCI-E (In 16X slot, for SLI)

16x PCI-E

8x PCI-E (In 16X slot, for SLI)

Standard Interrupt Assignments

IRQ	Priority	Standard function
0	N/A	System Timer
1	N/A	Keyboard Controller
2	N/A	Programmable Interrupt
3 *	8	Communications Port (COM2)
4 *	9	Communications Port (COM1)
5 *	6	Sound Card (sometimes LPT2)
6 *	11	Floppy Disk Controller
7 *	7	Printer Port (LPT1)
8	N/A	System CMOS/Real Time Clock
9 *	10	ACPI Mode when enabled
10 *	3	IRQ Holder for PCI Steering
11 *	2	IRQ Holder for PCI Steering
12 *	4	PS/2 Compatible Mouse Port
13	N/A	Numeric Data Processor
14 *	5	Primary IDE Channel
15 *	1	Secondary IDE Channel

** These IRQs are usually available for PCI devices.*

2-5-5 SLI Bridge for NVIDIA SLI Supported VGA Cards

In order to activate the NVIDIA SLI technology (SLI version only), you have to install the included SLI Bridge for your NVIDIA SLI Supported VGA Cards before you can activate the advanced multi-GPU functions.

STEP 1 - Install your NVIDIA SLI Supported VGA Cards in the PCI-E x8 slots located on the left and right, leaving the center PCI-E slot vacant.



STEP 2 - Prepare to install the SLI Bridge with your NVIDIA SLI Supported VGA Cards

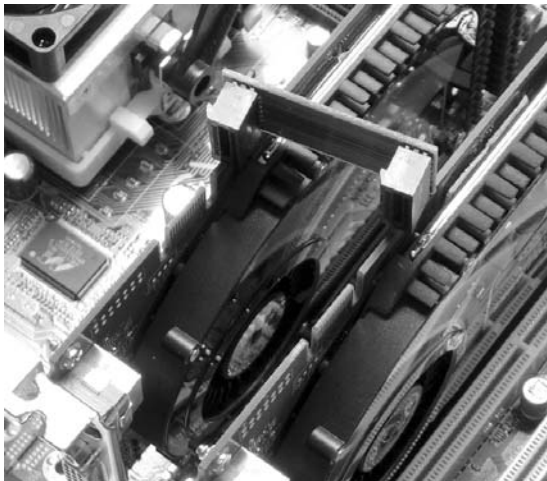

STEP 3 - Be careful with the pins as to not damage the adapter or graphics cards during installation.

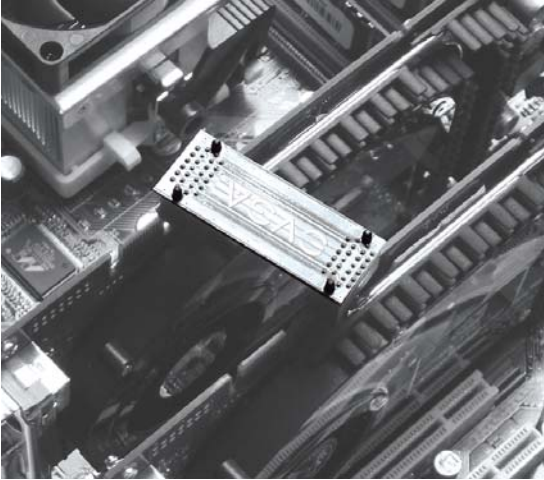

STEP 4 - Plug the SLI Bridge adapter onto both of the NVIDIA SLI Supported VGA Cards

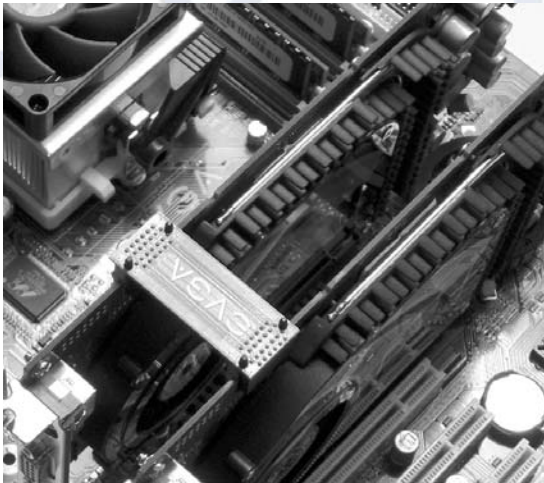

2-6 Connectors and Headers

2-6-1 Connectors

Power Connector (24-pin block) : ATXPWR

ATX Power Supply connector. This is a newly defined 24-pin connector that usually comes with an ATX case. The ATX Power Supply allows you to use soft power on momentary switch that connects from the front panel switch to 2-pins Power On jumper pole on the motherboard. When the power switch on the back of the ATX power supply is turned on, the full power will not come into the system board until the front panel switch is momentarily pressed. Press this switch again to turn off the power to the system board.

We recommend that you use an ATX 12V Specification 2.0-compliant power supply unit (PSU) with a minimum of 350W power rating. This type has both 24-pin and the 4-pin power plugs needed.

If you intend to use a PSU with 20-pin and 4-pin power plugs, make sure that the 20-pin power plug can provide at least 15A on +12V and the power supply unit has a minimum power rating of 350W. The system may become unstable or may not boot up if the power is inadequate.

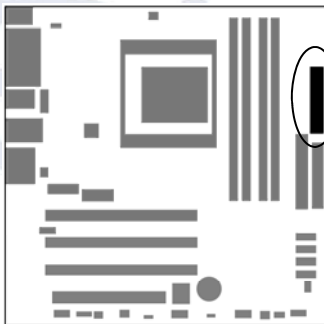

PIN	ROW1	ROW2
1	3.3V	3.3V
2	3.3V	-12V
3	GND	GND
4	5V	Soft Power On
5	GND	GND
6	5V	GND
7	GND	GND
8	Power OK	-5V
9	+5V (for Soft Logic)	+5V
10	+12V	+5V
11	+12V	+5V
12	+3V	GND

ATX 12V Power Connector (4-pin block) : ATX12V

This is a newly defined 4-pin connector that usually comes with the ATX Power Supply. The ATX Power Supply which fully supports the extra 12V voltage to maintain system power consumption. Without this connector the system will become unstable because the power supply can not provide sufficient current for all the system components

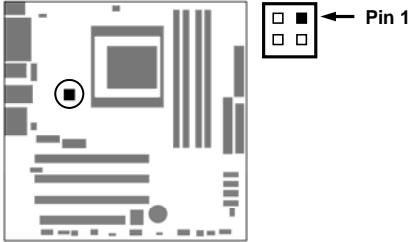
**PS/2 Mouse & PS/2 Keyboard Connector: KB**

The connectors for PS/2 keyboard and PS/2 Mouse.

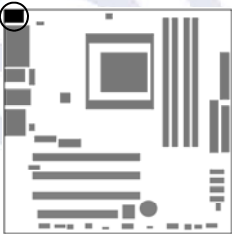
**FireWire/USB connector: CN1**

This connector supports a single standard FireWire connection and USB header 0 (USB 0&1)

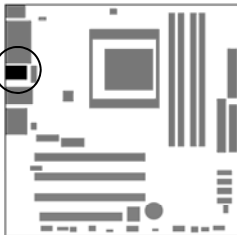

LAN Port/USB connector: UL1

This connector is standard RJ45 connector for Ethernet connections and USB header 1 (USB 2&3)

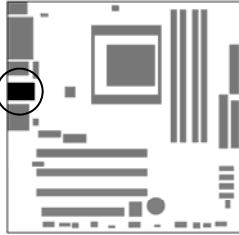
**Audio Line-In, Lin-Out, MIC, Surrback, Surround, CEN/LEF Connector : J1**

This Connector has 6 audio jacks for LINE-OUT, LINE-IN, MIC, Surrback, Surround, CEN/LEF

Line-in (BLUE)

Line-out (GREEN)

MIC (PINK)

Surrback (ORANGE)

CEN/LEF (BLACKNESS)

Surround (GRAY)

Audio input to sound chip

Audio output to speaker

Microphone Connector

Rear speaker out

Center/Subwoofer speaker out

Side speaker out

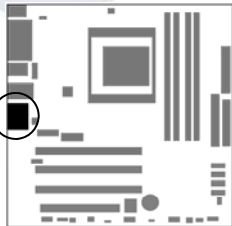

COM2/PARALLEL/SPDIF OUT

This block area includes the 9 pin connector for COM2, a standard Parallel port and SPDIF Out connectors for both RCA connector type or TOSLINK.



Floppy drive Connector (34-pin block): FDD

This connector supports the provided floppy drive ribbon cable. After connecting the single plug end to motherboard, connect the two plugs at other end to the floppy drives.

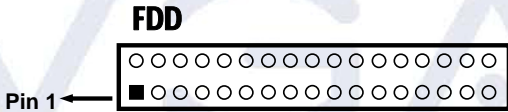

Floppy Drive Connector

Primary IDE Connector (40-pin block): IDE1

This connector supports the provided IDE hard disk ribbon cable. After connecting the single plug end to motherboard, connect the two plugs at the other end to your hard disk(s). If you install two hard disks, you must configure the second drive to Slave mode by setting its jumpers accordingly. Please refer to the documentation of your hard disk for the jumper settings.

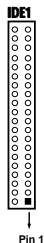

Primary IDE Connector

Serial-ATA Port connector: SATA1 / SATA2 / SATA3/ SATA4

This connector support the provided Serial ATA IDE hard disk cable to connecting the motherboard and serial ATA hard disk. The motherboard will support both SATA 150 and 300 standards.

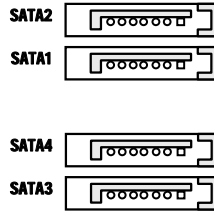
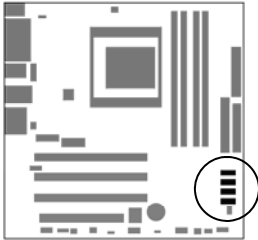

Serial-ATA Port Connector

SLI Select Mode Jumpers: JP2, JP3, JP4, JP5, JP6, JP7, JP8

These jumpers determine if SLI is enabled or not on the motherboard. If the jumpers are in the 1-2 position, then SLI is disabled, and you should only use your video card in the BLUE PCI-Express (PE2) slot at 16X. If the jumpers are set to 2-3, then SLI is enabled and you can use two video cards in SLI mode in the two YELLOW PCI-Express (PE1 and PE3) slots at 8X speed.

Please see the attached diagrams for more detailed information on the jumper locations and settings.

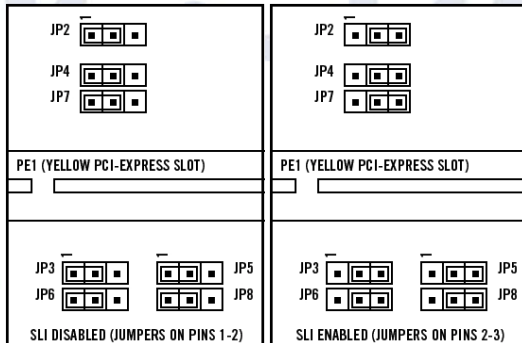
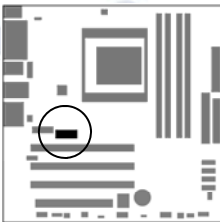

2-6-2 Headers

Line-Out/MIC Header for Front Panel (9-pin): AUDIO

This header connects to Front Panel Line-out, MIC connector with cable. Without installing this cable, this header default setting is 5-6 short, 9-10 short. When you install the cable you have take off these jumpers.

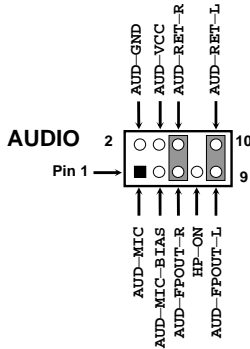
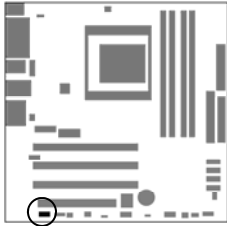

Line-Out, MIC Headers

USB Port Headers (9-pin) : USB1/USB2/USB3

These headers are used for connecting the additional USB port plug. By attaching an optional USB cable, your can be provided with two additional USB plugs affixed to the back panel.

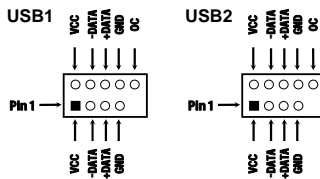
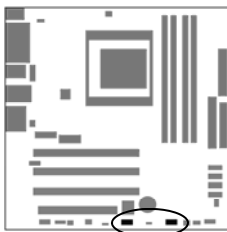

USB Port Headers

Speaker connector: SPEAK

This 4-pin connector connects to the case-mounted speaker. See the figure below.

Power LED: PWR LED

The Power LED is light on while the system power is on. Connect the Power LED from the system case to this pin.

IDE Activity LED: HD LED

This connector connects to the hard disk activity indicator light on the case.

Reset Switch : RESET

This 2-pin connector connects to the case-mounted reset switch for rebooting your computer without having to turn off your power switch. This is a preferred method of rebooting in order to prolong the life of the system's power supply. See the figure below.

Power Switch: PWR BTN

This 2-pin connector connects to the case-mounted power switch to power ON/OFF the system.

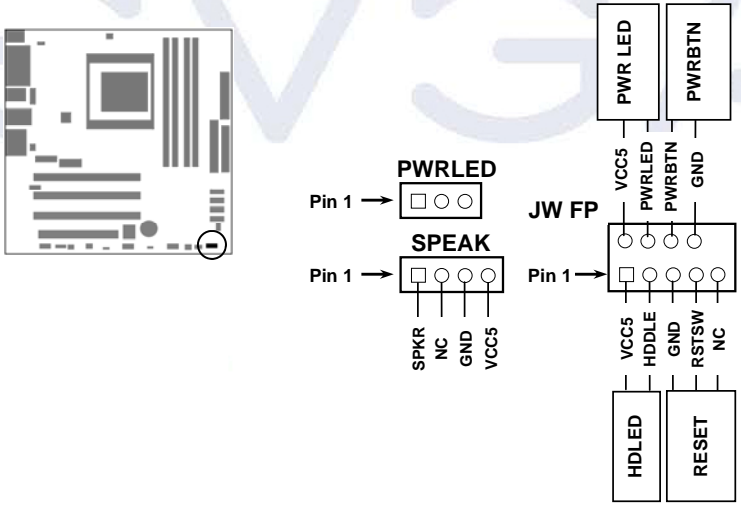

System Case Connections

FAN Headers (3-pin) : CPUFAN, CHAFAN1, SYSFAN1~2, FAN5

These connectors support cooling fans of 350mA (4.2 Watts) or less, depending on the fan manufacturer, the wire and plug may be different. The red wire should be positive, while the black should be ground. Connect the fan's plug to the board taking into consideration the polarity of connector.

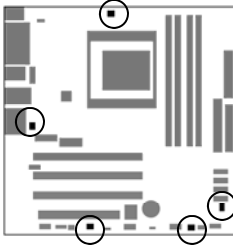

CD Audio-In Headers (4-pin) : CDIN

CDIN are the connectors for CD-Audio Input signal. Please connect it to CD-ROM CD-Audio output connector.

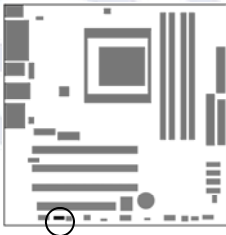

1394 FireWire Header: IEEE1_1394

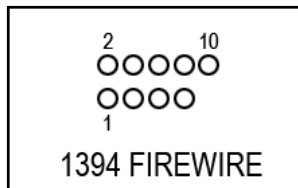
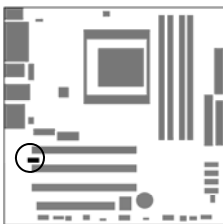

Supplemental SLI Power: J1

This 4-pin Molex type power connector is only required when running the system in an SLI configuration. This allows additional power to be channeled to the video cards in order to better maintain stability.

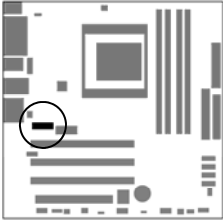

EVGA

2-7 Starting Up Your Computer

After all connections are made, close your computer case cover.

Be sure all the switches are off, and check that the power supply input voltage is set to proper position, usually input voltage is 110V~120V or 220V~240V depending on your country's voltage used. In the United States, this is 110V~120V - typically the switch on a computer power supply will be marked with 115V to indicate this setting.

Connect the power supply cord into the power supply located on the back of your system case according to your system user's manual.

Turn on your peripherals in the following order:

- Your monitor.
- Other external peripheral (Printer, Scanner, External Modem etc...)
- Your system power. For ATX power supplies, you need to turn on the power supply and press the ATX power switch on the front side of the case.

The power LED on the front panel of the system case will light up. The LED on the monitor may light up or switch between orange and green after the system is on, if it complies with green standards or if it has a power standby feature. The system will then run power-on test.

If you do not see any thing within 30 seconds from the time you turn on the power. The system may have failed on power-on test. Recheck your jumper settings and connections or call your retailer for assistance.

If there are any errors during start up, your computer will issue a series of beep codes in addition to displaying the last BIOS operation on the POST code diagnostic LED. A list of common beep codes follows:

Beep	Meaning
One short beep when displaying logo	No error during POST
Long beeps in an endless loop	No DRAM install or detected
One long beep followed by three short beeps	Video card not found or video card memory bad
High frequency beeps when system is working	CPU overheated System running at a lower frequency

During power-on, press **<Delete>** key to enter BIOS setup. Follow the instructions in the BIOS PDF located in the Manuals Section of the Installation CD.

Chapter 3

3-0 Introducing BIOS

The BIOS is a program located on a Flash Memory on the motherboard. This program is a bridge between motherboard and operating system. When you start the computer, the BIOS program gains control. The BIOS first operates an auto-diagnostic test called POST (power on self test) for all the necessary hardware, it detects the entire hardware device and configures the parameters of the hardware synchronization. Only when these tasks are completed does it give up control of the computer to the operating system (OS). Since the BIOS is the only channel for hardware and software to communicate, it is the key factor for system stability, and in ensuring that your system performance is at its best.

The details of each section of the BIOS are explained in the BIOS PDF supplemental that is located in the Manuals Section of the Installation CD.

3-1 Entering Setup

Power on the computer and by pressing **<Delete>** immediately allows you to enter Setup.

If the message disappears before your respond and you still wish to enter Setup, restart the system to try again by turning it OFF then ON or pressing the "RESET" button on the system case. You may also restart by simultaneously pressing **<Ctrl>**, **<Alt>** and **<Delete>** keys. If you do not press the keys at the correct time and the system does not boot, an error message will be displayed and you will again be asked to

Press **<F1>** to continue, **<Ctrl-Alt-Esc>** or **<Delete>** to enter Setup

For complete BIOS setup and descriptions please see the BIOS PDF located in the Manuals Section of the Installation CD.

Chapter 4

4-0 DRIVER INSTALLATION

After your computer's Operating System is installed, you will need to install drivers for your motherboard in order to gain full operation. Insert the Driver Installation CD into your computer's CD or DVD ROM drive and allow the autorun function to bring up the installation menu.

If the autorun function is disabled on your computer, simply navigate to the CD or DVD ROM drive that the Driver Installation CD is located in and double-click the autorun.exe file.

From Driver installation menu choose from driver options that will allow you to install the following drivers:

- NVIDIA Chipset Drivers
- ALC850 AC97' Codec Audio Drivers

After your computer finishes this installation, it will need to reboot in order for the new drivers to take effect.

NOTE: If you are installing drivers under the Windows XP x64 operating system, please be warned that the drivers have not yet been certified by Microsoft. As a result, you will see repeated warnings to this effect. Simply answer each in the affirmative to allow driver installation to proceed. Windows certified drivers are currently in development and will be released as a free download from our website as soon as they have passed Microsoft certification testing.

4-1 RAID INSTALLATION

The drivers for the NVIDIA RAID controller are located on the included RAID DRIVER floppy disk. They can be installed either at the time of Operating System installation or after the operating system has already been installed on a conventional IDE drive.

It is important to note that before you install and configure a RAID system, either after OS installation or during, you will need to enable RAID in your motherboard BIOS. To do this, reboot the computer and press the **<Delete>** key as it starts, this will take you to the BIOS configuration screens. From there you will need to make changes as indicated in the BIOS PDF that you can find in the Manuals Section of the Installation CD.

If you wish to install the SATA/RAID drivers at the same time you are installing the Operating System, simply wait for the Windows Installer to display **“Press F6 if you need to install a third party SCSI or RAID driver...”** - and press F6 at that time. Then insert the floppy disk and follow all of the on-screen instructions.

NOTE: The included floppy disk with RAID drivers supports Windows XP (32 bit version) and Windows 2000 only. If you are installing RAID under Windows XP x64, you will need to make a RAID driver disk. We have made this very easy to do, simply follow the instructions listed below:

Requirements: Windows (95/98/ME/NT/2K/XP) based computer with both a CD ROM drive and a 3.5 inch 1.44MB floppy, and one blank 3.5 inch 1.44MB floppy disk.

- Insert the Driver CD into the computer. If the autorun menu appears, close it.
- Browse to the Driver CD and open the folder named “RAID”
- Browse to the folder for the operating system that you wish to make the driver disk for: XP2K for Windows XP or Windows 2000, or XPx64 for Windows XP x64
- Execute by double-clicking the executable file in that directory: XP2KRAID.EXE for Windows XP and Windows 2000, or XPX64RAID.EXE for Windows XP x64
- This program will prompt you to insert your floppy disk and click on the Create Floppy button. Follow these instructions and it will automatically create the SATA RAID driver disk for you to use during installation.
- If the executable program does not work for some reason, the Files folder that is located in the same place contains the individual driver files that can be manually copied to a blank floppy instead.

NOTE: If you intend to use the onboard SATA controller for your primary hard drive, even if you do not intend on using RAID, you will need to use these drivers when you first install Windows.

APPENDIX 1

Quick Debug Port Post Codes

Please refer to the following Quick Debug table to assist in troubleshooting problems that are revealed through the motherboard's Debug Port. If you need more detailed information, you can refer to the Detailed Debug tables in the following pages.

Code(hex)	Name	Description
65	Init onboard device	Early Initialized the super IO, Reset Video controller, Keyboard controller init, Test the Keyboard Initialized the mouse Onboard audio controller initialize if exist. Check the integrity of the ROM, BIOS and message Check Flash type and copy flash write/erase routines to 0F000h segments, Check Cmos Circuitry and reset CMOS Program the chipset registers with CMOS values Init onboard clock generator
66	Early System setup	Check the CPU ID and init L1/L2 cache, Initialize first 120 interrupt vectors with SPURIOUS_INT_HDLR and initialize INT 00h-1Fh according to INT_TBL First step initialize if single CPU onboard. Re-init KB if support HPM, HPM get initialized here
67	KBC and CMOS Init	Verifies CMOS is working correctly, detects bad battery. If failed, load CMOS defaults and load into chipset Final Initial KBC and setup BIOS data area.
68	Video Init	Read CMOS location 14h to find out type of video in use. Detect and initialize Video Adapter. Test video memory, write sign-on message to screen. Setup shadow RAM - Enable shadow according to Setup.
69	8259 Init	Init 8259 channel 1 and mask IRQ 9
6A	Memory test	Quick Memory Test
6B	CPU Detect and IO Init	Detect CPU speed and display CPU vendor specific version string and turn on all necessary CPU features. Display PnP logo and PnP early init Setup virus protect according to Setup. If required, will auto load Awdflash.exe in POST Initializing onboard superIO
6C	Reserved	
6D	Reserved	
6E	Reserved	
6F	Reserved	
70	Setup Init	Display setup message and enable setup functions. Detect if mouse is present, initialize mouse, install interrupt vectors. Special treatment to PS2 Mouse port ACPI sub-system initializing
71	Setup Cache Controller	Initialize cache controller.
72	Install FDD	Enter setup check and auto-configuration check up Initialize floppy disk drive controller and any drives. Install FDD and setup BIOS data area parameters
73	Install HDD	Initialize hard drive controller and any drives. IDE device detection and install Initialize any serial and parallel ports (also game port).

74	Detect & Initialize Math Coprocessor	Initialize math coprocessor.
75	HDD Check for Write protection	HDD check out
76	Reserved	
77	Display POST error	Check POST error and display them and ask for user intervention - Ask password security (optional).
78	CMOS and Option ROM Init	Write all CMOS values back to RAM and clear screen. Enable parity checker Enable NMI, Enable cache before boot. Initialize any option ROMs present from C8000h to EFFFFh.
79	Reserved	
7A	Reserved	
7B	Reserved	
7C	Reserved	
7D	Boot Medium detection	Read and store boot partition head and cylinders values in RAM
7E	Final Init	Final init for last micro details before boot
7F	Special KBC patch	Set system speed for boot, Setup NumLock status according to Setup
80	Boot Attempt	Set low slack Boot via INT 19h.
FF	Boot	

BOOT BLOCK POST CODES

Code(hex)	Name	Description
1	Base memory test	Clear base memory area (0000:0000-9000:ffffh)
5	KB init	Initialized KBC
12	Install interrupt vectors	Install int. vector (0-77), and initialized 00-1fh to their proper place
0D	Init Video	Video initializing
41	Init FDD	Scan floppy and media capacity for onboard superIO
FF	Boot	Load boot sector

For a more detailed treatment of POST CODES, please see the POST CODES PDF document that is located on your driver CD in the Manuals section.

APPENDIX 2

COPYRIGHTS, TRADEMARKS, NOTICES

FCC Compliance Information

This device complies with FCC Rules Part 15, Operation is subject to the following two conditions: This device may not cause harmful interference, and this device must accept any interference received, including interference that may cause undesired operation. This equipment has been tested and found to comply with the limits for a Class B digital device, pursuant to Part 15 of the FCC Rules. These limits are designed to provide reasonable protection against harmful interference in a residential installation. This equipment generates, uses and can radiate radio frequency energy and, if not installed and used in accordance with the manufacturer's instructions, may cause harmful interference to radio communications. However, there is no guarantee that interference will not occur in a particular installation. If this equipment does cause harmful interference to radio or television reception, which can be determined by turning the equipment off and on, the user is encouraged to try to correct the interference by one or more of the following measures: 1) Increase the separation between the equipment and signal source, 2) Connect the equipment to an outlet on a circuit different from that to which the signal source is connected, 3) Consult the dealer or an experienced computer technician for help. The use of shielded cables for connection of the monitor to the graphics card is required to ensure compliance with FCC regulations. Changes or modifications to this unit not expressly approved by the party responsible for compliance could void the user's authority to operate this equipment.

CE Compliance Information

EMC Directive 89/336/EEC And Amendment 92/31/EEC, Class B Digital Device EN 50081-14, Generic Emissions Standard for Residential, Commercial and Light Industrial Products (EN 55022/CISPR 22, Limits and Methods of measurement of Radio). (EN 55022/CISPR 22, Limits and Method of Measurement of Radio Interference Characteristics Information Technology Equipment) Warning: This is a Class B product. In a domestic environment this product may cause radio interference in which case the user may be required to take adequate measure. EN 50082-1, Generic Immunity Standard for Residential, Commercial and Light Industrial Products (IEC 801-2, IEC 801-3, IEC 801-4)

Software License Agreement

This EVGA software (the "software") is copyrighted by EVGA.com CORP and is protected by US law. All rights reserved. The purchaser is granted a license to use the software only, subject to the following restrictions and limitations:

1. The license is for the original purchaser only, it is transferable so long as all items bundled with the software are transferred to the same individual as a sale (e.g. all software, manuals, hardware, etc.)
2. The original purchaser may use the software on a single computer owned or leased by the original purchaser. You may not use the software on more than a single machine, even if you own or lease more than one machine, without the written consent of EVGA
3. The original purchaser may make backup copies of the software for his or her own use only, subject to the use limitations of this license.
4. The original purchaser may not engage in, nor permit third parties to engage in, any of the following:

- Providing or disclosing the software to third parties
- Providing use of the software in a computer service business, network, time-sharing network
- Making alterations or copies of any kind in the software (except as permitted above)
- Attempting to un-assemble, de-compile or reverse engineer the software in any way
- Granting sublicenses, leases, or rights in the software to others
- Making copies, or verbal or media translations, of the user's guide
- Making telecommunication data transmissions of the software

Trademark Information

2001-2005 EVGA.com CORP. EVGA, the EVGA logo and combinations thereof are trademarks of EVGA.com CORP. NVIDIA, NVIDIA logo, nForce are registered trademarks and/or trademarks of NVIDIA Corporation in the United States and other countries and are used under license to EVGA.com CORP from NVIDIA Corporation. AMD is a registered trademark of Advanced Micro Devices. All brands and companies are trademarks or registered trademarks of their respective companies. EVGA reserves the right to terminate this license if there is a violation of its terms or default by the Original Purchaser. Upon termination, for any reason, all copies of Software and materials, must be immediately returned to EVGA and the Original Purchaser shall be liable to EVGA.com CORP for any and all damages suffered as a result of the violation or default.

APPENDIX 3

WARRANTY INFORMATION

LIMITED WARRANTY

1. Labor: For a period of one (1) year from the date of purchase (or two years if you register the product), if this product is determined to be defective, EVGA will repair or replace, at its option, at no charge to the original buyer. After the expiration of the warranty period, you must pay for all labor and or replacement charges.
2. To obtain warranty service, you must take the product, or deliver to product freight prepaid, in either its original packaging or packaging affording an equal degree of protection, to an EVGA authorized return facility.
3. This warranty does not cover consumer instruction, installation, set-up adjustment or any other implementation service.
4. This warranty does not cover cosmetic damage due to acts of God, accident, misuse, abuse, negligence, commercial use, or modification of , or to any part of the product. This warranty does not cover damage due to improper installation, operation or maintenance, connection to improper voltage supply, or attempting to repair by anyone other than a facility authorized by EVGA to service this product. This warranty does not cover products sold AS IS. This warranty is only valid in the United States of America.
5. Proof of purchase in the form of a bill of sale or receipted invoice which by itself is evidence that the unit is within the warranty period must be presented in order to obtain warranty service.
6. This warranty is invalid if the factory applied serial number has been altered or removed from the product.

REPAIR OR REPLACEMENT AS PROVIDED UNDER THIS WARRANTY IS THE EXCLUSIVE REMEDY OF THE CONSUMER. EVGA SHALL NOT BE LIABLE FOR AN INCIDENTAL OR CONSEQUENTIAL DAMAGE FOR BREACH OF ANY EXPRESSED OR IMPLIED WARRANTY ON THIS PRODUCT. EXCEPT TO THE EXTENT PROHIBITED BY APPLICABLE LAW, ANY IMPLIED WARRANTY OF MERCHANTABILITY OR FITNESS FOR A PARTICULAR PURPOSE ON THIS PRODUCT IS LIMITED IN DURATION TO THE DURATION OF THE WARRANTY

Some states do not allow the exclusion or limitations of incidental or consequential damages, or allow limitation on how long an implied warranty last, so the above limitations may not apply to you. In addition, this warranty gives you specific legal rights, and you may have other rights which vary from state to state.

To locate the dealer nearest you or for service assistance and resolution of a service problem or for general product information, please call:

888-881-EVGA or write to EVGA CORP - 2900 Saturn Street, Suite B - Brea, CA 92821

APPENDIX 4

USEFUL INFORMATION

Contacting Customer Service

EVGA is dedicated to supporting our products. Contacting EVGA Customer Service is easy! We can be reached by phone, fax, and on the web. Before contacting Customer Service, please review this manual. If you need to contact Customer Service, please have your system configuration as well as your motherboard's model number and serial number ready. You will need to register your product before a support technician can assist you. You may register your product online at <http://www.evga.com/register>, or when you call for support, a staff member will register it for you.

- Hours of Operation: 9 AM to 5:30 PM Monday to Friday, PST
- Phone Support: 888-881-EVGA (3842)
- Fax Support: 714-528-4501
- Tech Support Web Site: <http://www.evga.com/support>

Information to Keep Handy Before Calling

Motherboard Model Number _____

Motherboard Chipset _____

Processor Type and Speed _____

Operating System _____

Installed Service Packs _____

Other Installed Hardware _____



EVGA.com Corp. • 2900 Saturn Street, Suite B • Brea, CA 92821 • www.evga.com

Free Manuals Download Website

<http://myh66.com>

<http://usermanuals.us>

<http://www.somanuals.com>

<http://www.4manuals.cc>

<http://www.manual-lib.com>

<http://www.404manual.com>

<http://www.luxmanual.com>

<http://aubethermostatmanual.com>

Golf course search by state

<http://golfingnear.com>

Email search by domain

<http://emailbydomain.com>

Auto manuals search

<http://auto.somanuals.com>

TV manuals search

<http://tv.somanuals.com>