

EmbeddedDNA[®]

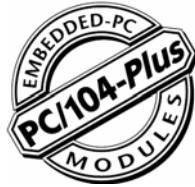

CPU-1461

User's Manual

Rev. 1.0

Jul. 2005

COPYRIGHT 1994-2005 Eurotech S.p.A. All Rights Reserved.

This manual is intended for engineers and programmers. It contains technical specifications, as well as describes the connectors and how to properly use and configure the product.



Via J. Linussio 1
33020 AMARO (UD)
ITALY

Phone: +39 0433 485 411
Fax: +39 0433 485 499

Web: <http://www.eurotech.it>
e-mail: sales@eurotech.it

NOTICE



Although all the information contained herein has been carefully verified, Eurotech S.p.A. assumes no responsibility for errors that might appear in this document, or for damage to property or persons resulting from an improper use of this manual and of the related software. Eurotech S.p.A. reserves the right to change the contents and form of this document, as well as the features and specifications of its products at any time, without notice.

Trademarks and registered trademarks appearing in this document are the property of their respective owners



Conventions

The following table lists conventions that are used throughout this guide.

Icon	Notice Type	Description
	Information note	Important features or instructions
	Warning	Information to alert you to potential damage to a program, system or device or potential personal injury

Environmental safety



When disposing the equipment, we suggest separating all of its components when possible, and disposing of them in accordance with local waste disposal legislations.

Be sure to dispose of used batteries as required by local waste disposal legislation. Never throw batteries into a fire (risk of explosion) or household garbage can.

Contents

Conventions	3
Environmental safety.....	3
Contents	5
Chapter 1 Product Overview	7
Product Definition.....	8
Chapter 2 Jumper Description	9
Jumper Layout and Configuration.....	10
Chapter 3 Connectors Description	11
Connectors Layout.....	12
How to connect the CPU-1461 to other PC/104 & PC/104-Plus devices: the stack assembly	13
J4 for Multifunction and VGA	14
<i>Multifunction Connector Section.....</i>	<i>15</i>
<i>The Eurotech Multifunction Adapter.....</i>	<i>16</i>
<i>VGA Section.....</i>	<i>17</i>
J5 IDE Connector.....	18
J7 for USB 2.0 (Ports 5 and 6).....	19
J9 Auxiliary Power Connector	20
J14 for USB 1.1 (Ports 7 and 8) and Audio-CODEC	21
<i>The Eurotech USB & AC97-Audio Codec Adapter</i>	<i>21</i>
J16 for USB 2.0 (Ports 1 to 4).....	23
J17 for SERIAL1 and SERIAL2	24
J20 for Ethernet.....	25
<i>The Eurotech Ethernet Transceiver</i>	<i>26</i>

Chapter 4 The Set-up Program.....	27
The Set-up pages.....	30
<i>General Page</i>	30
<i>Devices Page</i>	32
<i>Communications Page</i>	34
<i>Primary and Secondary ATAPI Page</i>	36
<i>Advanced page</i>	38
<i>PCI Advanced Page</i>	39
<i>ISA Bus</i>	40
<i>Error Handling Page</i>	40
Chapter 5 Watch Dog Timer	43
What is a Watch Dog?	44
How to use the Watch Dog	44
<i>Use the System BIOS INT 52h functions</i>	44
<i>Directly accessing Watch Dog I/O mapped registers</i>	45
Chapter 6 Troubleshooting.....	47
Common Problems and Solutions	48
Troubleshooting a PC/104 System	48
Technical/Sales Assistance	48
Returning For Service	49
Appendix	53
A.1 Electrical and Environmental Specifications	54
<i>Operating Characteristics</i>	54
<i>Absolute Maximum Ratings</i>	55
<i>MTBF (Mean Time Between Failures)</i>	55
A.2 Mechanical Dimensions	56
<i>USB Audio Codec Dimensions</i>	57
<i>Ethernet Adapter Dimensions</i>	57
<i>Multifunction Adapter Dimensions</i>	58
A.3 Safety Summary.....	58
<i>Ground the Instrument</i>	59
<i>Do Not Operate in an Explosive Atmosphere</i>	59
<i>Keep Away From Live Circuits</i>	59
<i>Use Caution When Exposing or Handling the CRT</i>	59
<i>Do Not Substitute Parts or Modify Equipment</i>	59
<i>Observe Dangerous Procedure Warnings</i>	59
<i>Flammability</i>	59
<i>EMI Caution</i>	59
<i>CE Notice</i>	59
<i>Disclaimer of Warranty</i>	60
<i>Notice</i>	60
<i>Reliability</i>	60
<i>Life Support Policy</i>	60
Glossary	61
Acronyms and Abbreviations.....	67

Chapter 1 Product Overview

The CPU-1461 is a reliable Celeron PC/104-Plus embedded module with 6 fast USB 2.0 ports

For a complete list of related accessories, as well as latest BIOS and drivers, please go to our web site:
www.eurotech.it

In the following paragraphs you will find a description of the CPU-1461 characteristics.

Product Definition

Architecture:	PC/104-Plus 2.0 compliant
Processor:	PentiumIII® 800MHz, 256KB L2 cache, 133MHz PSB
Chipset:	Intel® 815E
Memory:	256MB SDRAM soldered on board
Operating Systems:	WinCE®, VxWorks®, Linux®, QNX®
BIOS Flash:	1MB Flash EPROM
Interfaces:	IDE Controller UltraDMA 2x Serial: 1 RS232, 1 RS232/422/485 2x USB 1.1 6x USB 2.0 Ethernet (10/100 Mbps) VGA Video Controller Auxiliary Power AC97 Keyboard and Mouse
Bus:	PC/104-Plus (PCI) PC/104 (ISA)
Watchdog:	2-255 sec./min.
Power Supply:	+5V DC

Chapter 2 Jumper Description

This chapter shows the layout of the jumpers and explains how to set them up.

Jumper Layout and Configuration

Figure 1 shows the jumper layout of the CPU-1461.
The jumpers are indicated as **JP** followed by the jumper's number.

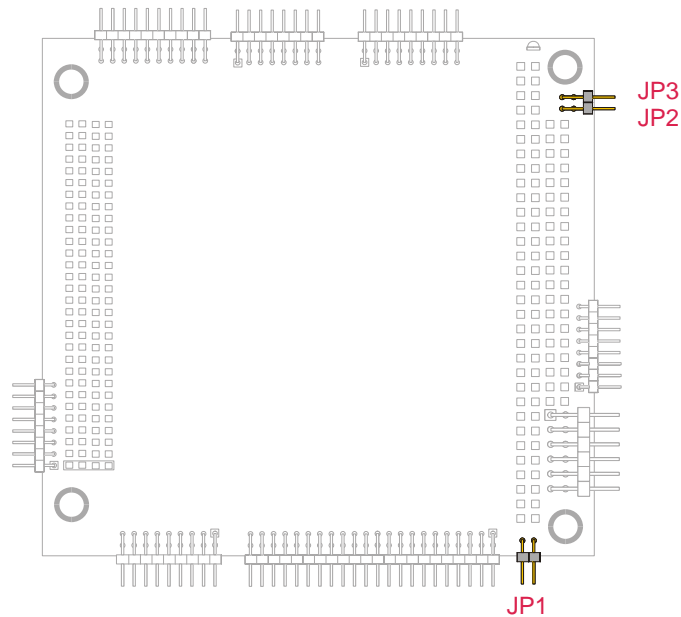

Figure 1. Jumpers on the CPU-1461 module

Three 2-pin jumpers (JP1, JP2 & JP3) are located on the module. They can be set as follows:

- Pins connected together (which will be indicated as 'Closed')
- Pins not connected (which will be indicated as 'Open')

Table 1 gives a quick cross-reference for them.

Table 1. Jumper Functions

Jumper #	Type	Function	Default
JP1	2 pin jumper	IDE LED Pin 1 (-): cathode LED Pin 2 (+): anode LED	Open
JP2	2 pin jumper	Reserved	Open
JP3	2 pin jumper	Reserved	Open

Chapter 3 **Connectors Description**

This chapter provides a brief description of the CPU-1461 module's connectors, their positions and functions.

Connectors Layout

Figure 2 shows the connectors with their layout and function(s).

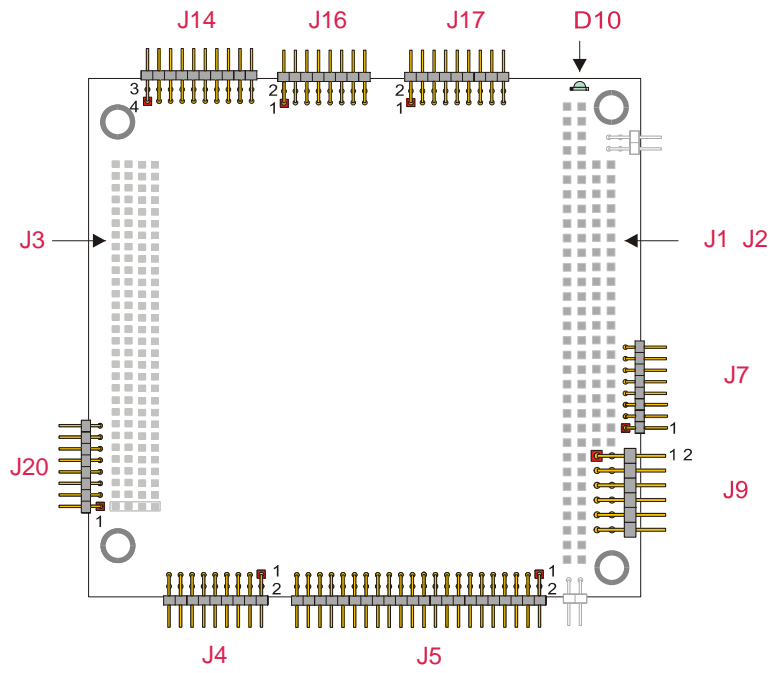

Figure 2. Connector layout



Note: in figure 2, a red square pad indicates pin 1 of each connector.

Table 2 lists the name of the connectors with their function:

Table 2. Connector Functions

Connector	Function	Qty of pins	Format	Pitch (mm)
J1-J2	ISA BUS (Bottom Side Only)	-	-	-
J3	PCI BUS (Bottom Side Only)	-	-	-
J4	Multifunction, VGA	18	9x2	2.00
J5	IDE/DOM	44	22x2	2.00
J7	USB 2.0 (Ports 5 and 6)	8	8x1	2.00
J9	Aux. power	12	6x2	2.54
J14	USB 1.1 (Ports 1 and 2), AUDIO CODEC	20	10x2	2.00
J16	USB 2.0 (Ports 1..4)	16	8x2	2.00
J17	Serial Ports 1and 2	18	9x2	2.00
J20	Fast Ethernet (10/100Mbps)	8	8x1	2.00

How to connect the CPU-1461 to other PC/104 & PC/104-Plus devices: the stack assembly

The ISA and PCI Bus connectors of the CPU-1461 are located on the bottom side of the module only, and are designed to allow the connection on the top position of the stack formed by other PC/104 and/or PC/104-Plus devices.

We recommend you to follow the procedure below ensuring that stacking of the modules does not damage connectors or electronics parts.



Always use appropriate antistatic precautions when handling boards

1. Turn off all power to the PC/104 computer and its peripheral devices.
2. Select and install standoffs to properly position the module on the PC/104 stack.
3. Remove the module from its antistatic bag.
4. Check that keying pins in the bus connector are properly positioned.
5. Check the stacking order; make sure an XT bus card are not placed between two AT bus cards as this will interrupt the AT bus signals.
6. Hold the module by its edges and orient it so that the bus connector pins line up with the matching connector on the stack.
7. Using even pressure press the module onto the PC/104 stack.

Figure 3 shows a module stack with the CPU-1461 on the top of two PC/104-Plus modules. If standard PC/104 modules are used in the stack, they must be the lowest modules because they will normally not include the PCI bus. An adapter module must be used.

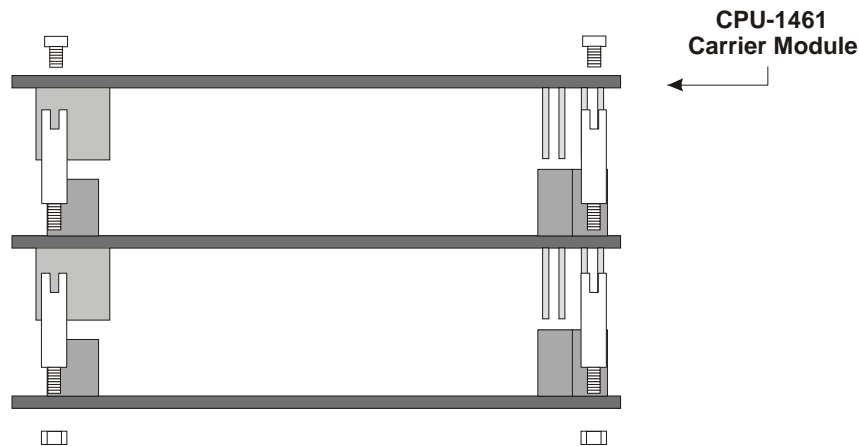

Figure 3. The Module Stack



Do not force the module onto the stack! Wiggling the module or applying too much pressure may damage it. If the module does not readily press into place, remove it, check for bent pins or out-of-place keying pins, and try again.

J4 for Multifunction and VGA

This connector enables the connection of a speaker, keyboard, mouse, battery and VGA monitor to the CPU-1461.

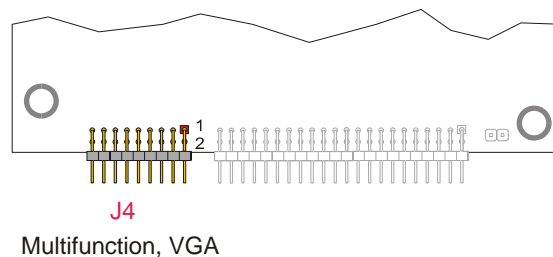

Figure 4. J4 Connector Layout

The connector implements the following functions:

- MULTIFUNCTION SECTION (from pin 1 to pin 9)
 - Keyboard
 - PS/2 Mouse

- System reset
 - External battery
 - Speaker
 - Power button
- VGA monitor (from pin 10 to pin 18)

Table 3 shows the connector pin out.

Table 3. J4 Multifunction/VGA connector

PIN	SIGNAL	SIGNAL	PIN	FUNCTION
1	GND_SRV	VDD_SRV (+5V)	2	MULTIF.
3	KBDAT	KBCLK	4	
5	MSDAT	MSCLK	6	
7	BAT_IN	SPKR	8	
9	RES_PB_IN	GND_VGA	10	
11	HSYNC	VSYNC	12	VGA
13	RED_VGA	GREEN_VGA	14	
15	DDC1_SCL	DDC0_SDA	16	
17	GND_VGA	BLUE_VGA	18	

Multifunction Connector Section

This section of the connector implements the following functions:

- **Keyboard**

An AT compatible keyboard can be connected to the module through connector J4. Table 4 lists the pin-out of connector J4.

Table 4. Keyboard connector table

Pin #	Signal	Function
1	GND	Ground signal
2	+5V	Power supply
3	KBDAT	Keyboard data
4	KBCLK	Keyboard clock

- **Mouse Connector Section**

A PS/2 compatible mouse can be connected to the J4 connector. Table 5 shows the pin-out for the mouse

Table 5. J4 for Mouse connector

Pin #	Signal	Function
1	GND	Ground signal
2	+5V	Power supply
5	MSDAT	Mouse data
6	MSCLK	Mouse clock

- **System reset**
The connection of the multifunction connector pin 9 to ground performs a hardware reset of the module. It is possible to use an external push-button (normally open) to manually reset the system. The reset signal is “de-bounced” on the board.
- **External Battery**
Pin 7 of the multifunction connector allows the connection of an external backup battery. If you connect a battery, then the voltage must be between 3.0V and 3.9V. This battery is used when the system is powered down to preserve the Real Time Clock data. The typical battery consumption with the module off is 7uA.
- **Speaker**
A transistor that supplies 0.1W to an external speaker controls these outputs. A transistor amplifier buffers the speaker signal. Use a small general-purpose 2” or 3” permanent magnet speaker with an 8Ω voice coil. The audio output is based on two signals: one come from the output of Timer 2, and the other come from I/O port 61h compliant with the AT Standard.

The Eurotech Multifunction Adapter

The Eurotech Multifunction Adapter simplifies the connection of mouse and keyboard with two PS/2 connectors, a speaker, battery and a reset pushbutton.

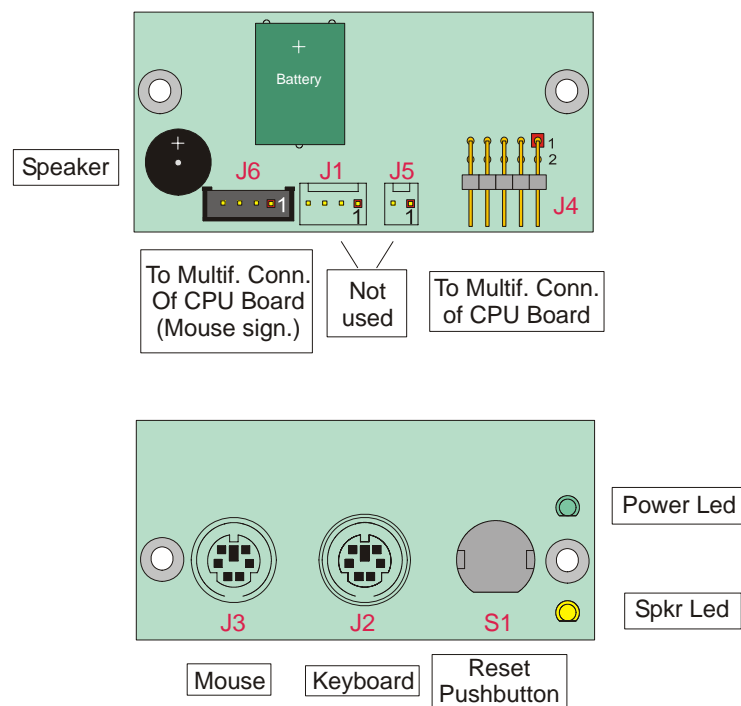

Figure 5. Multifunction Adapter (both sides)

9	BATT_IN (to J4 PIN 7)
----------	-----------------------

Table 6. J4 To CPU J4 Connector

PIN #	SIGNAL
1	SPKR (to J4 PIN 8)
2-8	+5V (to J4 PIN 2)
3	RES_PB_IN (to J4 PIN 9)
4-10	N.C.
5	KBDAT (to J4 PIN 3)
6	KBCLK (to J4 PIN 4)
7	GND (to J4 PIN 1)

Table 7. J6 To CPU J4 Connector (Mouse signals)

PIN #	SIGNAL
1	+5V (to J4 PIN 2)
2	MSCLK (to J4 PIN 6)
3	GND. (to J4 PIN 1)
4	MSDAT (to J4 PIN 5)

VGA Section

The CPU-1461 integrates a high-performance 2D graphics accelerator

Supported CRT-VGA Video Resolutions

Table 8 shows supported CRT Display Modes¹

Table 8. Partial list of Display Modes Supported

Resolution 640x480	Bits Per Pixel (frequency in Hz)		
	8-bitIndexed	16-bit	24-bit
320x200	70	70	70
320x240	70	70	70
352x480	70	70	70
352x576	70	70	70
400x300	70	70	70
512x384	70	70	70
640x400	70	70	70
640x480	60, 70, 72, 75, 85	60, 70, 72, 75, 85	60, 70, 72, 75, 85
720x480	75, 85	75, 85	75, 85
720x576	60, 75, 85	60, 75, 85	60, 75, 85
800x600	60, 70, 72, 75, 85	60, 70, 72, 75, 85	60, 70, 72, 75, 85
1024x768	60, 70, 72, 75, 85	60, 70, 72, 75, 85	60, 70, 72, 75, 85
1152x864	60, 70, 72, 75, 85	60, 70, 72, 75, 85	60, 70, 72, 75, 85
1280x720	60, 75, 85	60, 75, 85	60, 75, 85
1280x960	60, 75, 85	60, 75, 85	60, 75, 85
1280x1024	60, 70, 72, 75, 85	60, 70, 72, 75, 85	60, 70, 72, 75, 85

J5 IDE Connector

The CPU-1461 module provides an interface for up to two Integrated Device Electronics (IDE) hard disk drives on connector J5.

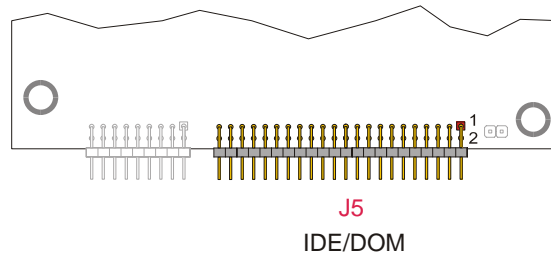

Figure 6. J5 Connector layout

To install the hard disk, perform the following operations:

- *Hardware installation.* Connect the hard disk to the module using a data cable, and then connect the hard disk to the power supply according to the device's specifications. Make sure that pin 1 of connector J5 and pin 1 of the drive or drives are correctly connected. Pin 1 of the interface cable is usually indicated by a stripe along the edge of the cable. If two hard disks need to be connected, they must be configured for common operation (i.e. master/slave or cable select connection).
- *IDE BIOS Setup.* The hard disk parameters can be configured using the Setup program. If the hard disk is connected to the module without setup configuration or with a wrong setup configuration, a time-out of a few minutes occurs.
- *Software initialization for specific operating systems.* Refer to the OS documentation.

J7 for USB 2.0 (Ports 5 and 6)

J7 is used for USB 2.0, ports 5 & 6. Each port can supply up to 2A

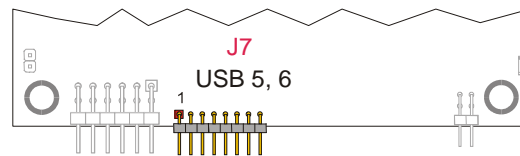

Figure 7. J7 Connector Layout

Table 9. J7 Connector pin out

PIN#	SIGNAL	FUNCTION
1	VDD_USB5	USB 5
2	USB5-	
3	USB5+	
4	GND_USB_5	
5	VDD_USB_6	USB 6
6	USB6-	
7	USB6+	
8	GND_USB_6	



Note: To establish a USB connection, no transceiver is required.

J9 Auxiliary Power Connector

J9 is an auxiliary power connector and can be used to power the module as an alternative to the PC/104-Plus bus.

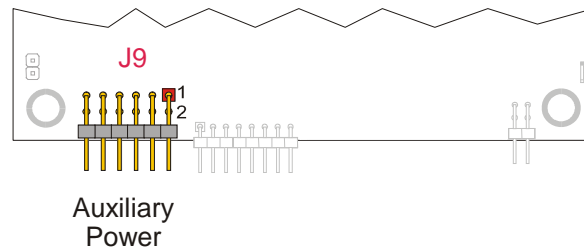

Figure 8. J9 Connector layout

Table 10 shows the pin out for J9.

Table 10. J9 Auxiliary Power Connector

PIN #	SIGNAL	SIGNAL	PIN #
1	GND	VDD	2
3	N.C.	+12v	4
5	-5V	-12V	6
7	GND	VDD	8
9	N.C.	PWRBTN#	10
11	+5VSB ⁽¹⁾	PSON# ⁽²⁾	12

⁽¹⁾ +5VSB: +5 Volts-Always from the ATX Power supply

⁽²⁾ PSON#: Power-On command to ATX Power supply

Power button (input)

If the soft power management is enabled, a low signal in this pin turns the system on or off.



Note. The VSB (Volt Stand-By) voltage is useful for Power management applications only.



Note. The +12VDC and -5VDC voltages are neither used nor generated by the CPU-1461 module: they are only conveyed on the PC/104-Plus bus (connector J1) and can be used by other devices or modules that are stacked onto the CPU module.



WARNING! IMPROPER CONNECTION OF THE POWER SUPPLY WILL RESULT IN SERIOUS DAMAGE TO THE MODULE.

J14 for USB 1.1 (Ports 7 and 8) and Audio-CODEC

J14 is used for USB 1.1, ports 7 & 8 and the Audio CODEC.

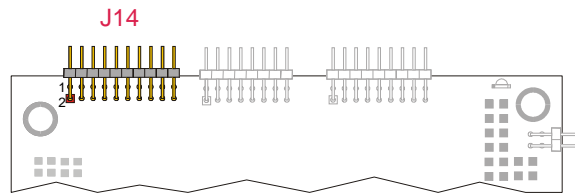

Figure 9. J14 Connector Layout

It implements the following functions:

- CODEC Audio port
- USB 1.1 port 7
- USB 1.1 port 8

Table 11 shows the J14 connector pin out.

Table 11. J14 Connector pin out

PIN #	SIGNAL	SIGNAL	PIN #	PORT
1	SPKR	SDIN1	2	Audio Codec
3	SDOUT	CDC_EN#	4	
5	GND	GND	6	
7	SDIN0	BITCLK	8	
9	RST	SYNC	10	
11	GND	USB Over Current1#	12	USB 7, 8
13	USB7-	USB8-	14	
15	USB7+	USB8+	16	
17	GND	VDD	18	
19	GND	VDD	20	

The Eurotech USB & AC97-Audio Codec Adapter

Before using a USB and/or an Audio Device, the Eurotech USB/AC97-Audio Codec Adapter must be connected to the CPU board. The connection between the Eurotech adapter and the CPU board is established by a cable set provided with the adapter.

Figure 10 shows this adaptor.

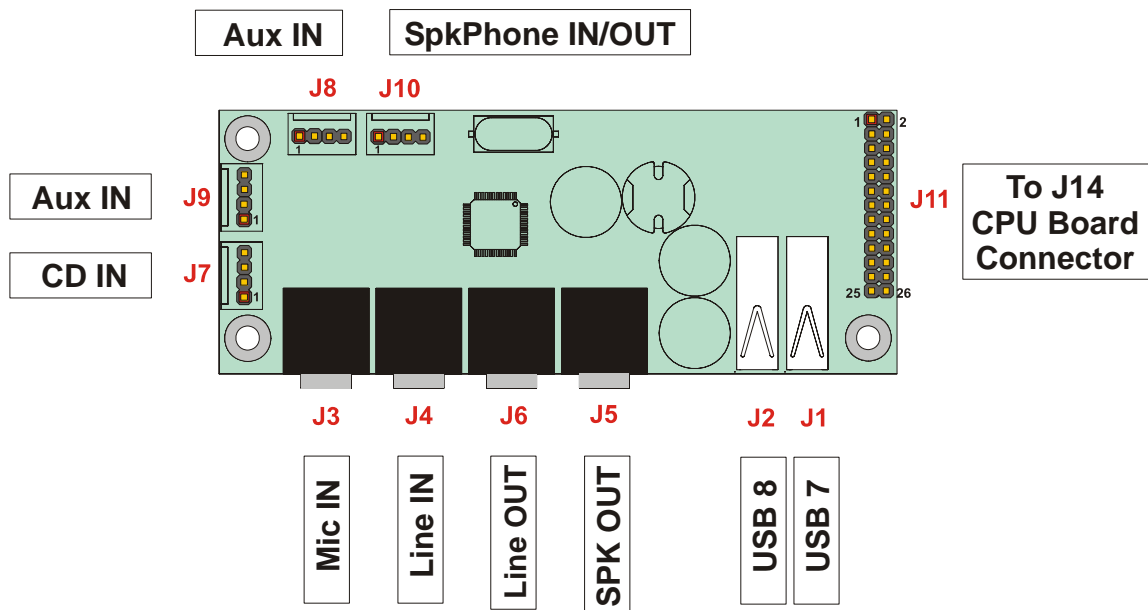

Figure 10. USB/AC97-AudioCODEC Adapter

Table 12 shows the adapter connectors description.

Table 12. USB/AC97-AudioCODEC Connectors

Connector#	Function
J1	USB0
J2	USB1
J3	Microphone IN
J4	Line IN
J5	Speaker OUT
J6	Line OUT
J7	CD IN
J8	Aux IN
J9	Aux IN
J10	Speakerphone IN/OUT
J11	To CPU Board Connector (J4)

This adapter is composed of 2 functional sections:

- USB section, with 2 USB ports which are EMI protected and filtered, and can also supply power to the peripheral device connected (5V, 500mA);
- Audio section, which is equipped with the LM4549 National, an AC97 compliant I.C. The AC97 architecture separates the analog and digital functions of the PC audio system allowing both for system design flexibility and increased performance. The LM4549 is an Audio CODEC for PC systems, which is fully PC98 compliant and performs the analog intensive functions of the AC97 Rev2.1 architecture. Using 18-bit Sigma-Delta A/D's and D/A's, the LM4549 provides 90dB of Dynamic Range.

The Audio section of this board provides 4 stereo inputs, 1 microphone input, 1 stereo line input, 1 stereo earphone output (200mW) and 1 speakerphone.

J16 for USB 2.0 (Ports 1 to 4)

J16 implements USB 2.0 ports 1, 2, 3 and 4. Each port can supply current according to the following scheme:

The total amount of power available for use is 2A distributed between the four ports



WARNING: The total amount of power must not exceed 2 Amperes

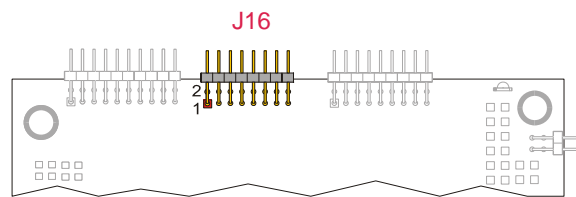

Figure 11. J16 Connector Layout

Table 13. J16 Connector pinout

PIN #	SIGNAL	SIGNAL	PIN #
1	VDD	GND	2
3	USB4-	USB4+	4
5	VDD_USB 3, 4	GND	6
7	USB3-	USB3+	8
9	VDD	GND	10
11	USB2-	USB2+	12
13	VDD	GND	14
15	USB1-	USB1+	16

J17 for SERIAL1 and SERIAL2

J17 is used for Serial ports 1 and 2.

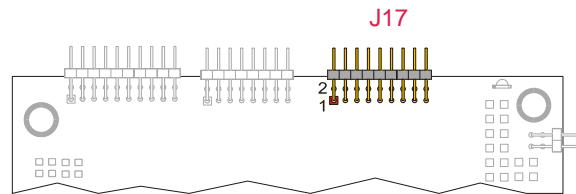

Figure 12. J17 Connector Layout

Table 14 shows the connector pin out.

Table 14. J17 Connector pin out

PIN #	SIGNAL	SIGNAL	PIN #	FUNCTION
1	DCD1	DSR1	2	Serial 1
3	RX1	RTS1	4	
5	TX1	CTS1	6	
7	DTR1	RI1	8	
9	GND	DCD2	10	
11	DSR2	RX2	12	Serial 2
13	RTS2	TX2	14	
15	CTS2	DTR2	16	
17	RI2	GND	18	

J20 for Ethernet

J20 is used the Ethernet connection.

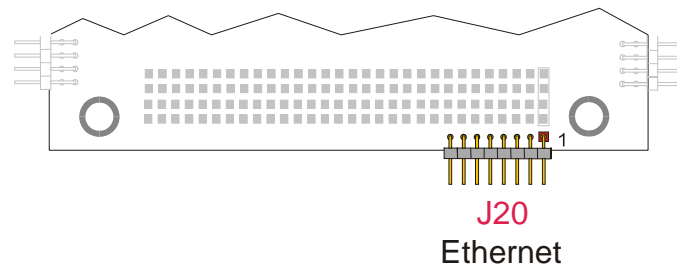

Figure 13. J20 Connector Layout

Table 15 shows the J20 connector pin out.

Table 15. J20 Connector pin out

PIN #	SIGNAL
1	+3.3V
2	ACTIVITY LED
3	RX+
4	RX-
5	LINK LED
6	GND
7	TX+
8	TX-

The Eurotech Ethernet Transceiver

To establish an Ethernet connection an Ethernet Transceiver must be used. Eurotech supplies a Transceiver that can be placed between the J20 connector of the CPU board and the network cable.

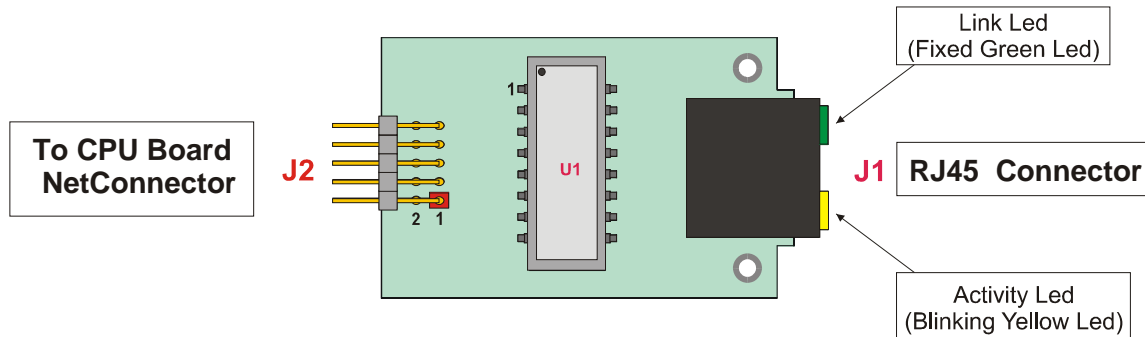

Figure 14. The Eurotech Ethernet Adapter

The green led is fixed, and signals the correct connection of the module. The yellow led blinks when there is activity (data IN/OUT) on the net connection.

With RJ45 connectors, only twisted pair cables can be used.



Important Note. Connection to a 100BASE-TX hub for 100 Mbps operation requires the use of Cat.5 Unshielded Twisted-Pair (UTP) cable or Cat.5 Shielded Twisted-Pair (STP) cable. The maximum length between the 100BASE-TX hub and the adapter is 100 meters. Connection to a 10BASE-T hub for 10 Mbps operation requires a Cat.3, 4 or 5 UTP cable or Cat.5 STP cable. The preferred maximum cable length between the CPU module and the Ethernet adapter is 10 cm (4")

Chapter 4 The Set-up Program

This chapter explains how to use and modify the setup options. These options allow configuring properly the CPU board.



Note. The Setup Program can be improved to match the technical requirements.

To enter in the Setup Program reboot or switch-on your module and then press the “F2” key. After waiting a few seconds the main menu will appear.

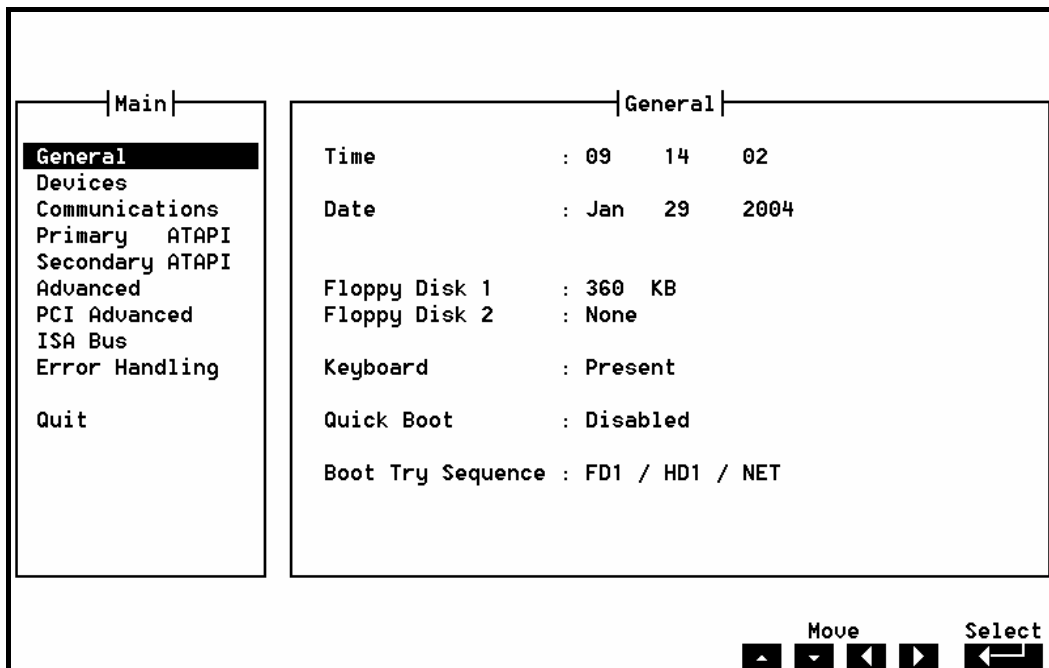

The Main menu of the set-up program shows a list of options that are available. A highlight illustrates which option is currently selected.

Use the cursor arrow keys to move the highlight to other options.
When an option (i.e.: *General*) is highlighted, it is possible to execute it by pressing the “**Enter**” key.
A table of items will be displayed on the right side of the screen.

Main		General	
General	Time	: 14	45 21
Devices	Date	: Feb	03 2004
Communications	Floppy Disk 1	: 360	KB
Primary ATAPI	Floppy Disk 2	: None	
Secondary ATAPI	Keyboard	: Present	
Advanced	Quick Boot	: Disabled	
PCI Advanced	Boot Try Sequence	: FD1 / HD1 / NET	
ISA Bus			
Error Handling			
Quit			

Move Change Back
 ← ↓ ← → 0..9 Esc

Now it is possible to select among several items (i.e.: *Time*, *Date*, *Floppy Disk 1*,...) using the arrow keys and the “**Enter**” key. When an item is highlighted, it is possible to change its value by pressing the “**PageUp**” and “**PageDown**” keys. *Time* and *Date* items are set using the keys “**PageUp**” and “**PageDown**” and the keys from “**0**” to “**9**”; press “**Enter**” to confirm. To correct errors press the “**BackSpace**” key.

Main		General	
General	Time	: 14	45 1
Devices	Date	: Feb	03 2004
Communications	Floppy Disk 1	: 360	KB
Primary ATAPI	Floppy Disk 2	: None	
Secondary ATAPI	Keyboard	: Present	
Advanced	Quick Boot	: Disabled	
PCI Advanced	Boot Try Sequence	: FD1 / HD1 / NET	
ISA Bus			
Error Handling			
Quit			

Change Correct Enter Back
 0..9 BackSpace ← Esc

Press the “**ESC**” key to return to the items of the Main menu.
Select “*Quit*” to exit from the Setup program.

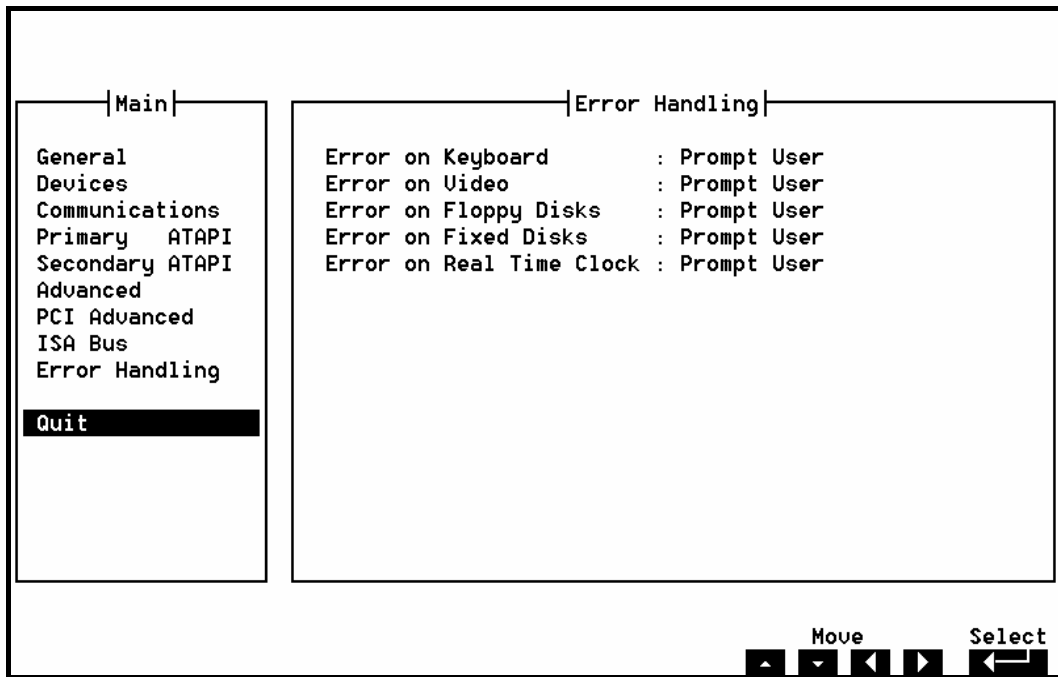

The follow screen will be displayed:



Select with the "ENTER" key the first option "Save data to Flash" to store the parameters into the EEPROM. Select *Discard changes* to leave unaltered the previous stored parameters.

The Set-up pages

The Set-up Program is composed of several pages. They are listed below:

- General
- Devices
- Communications
- Primary ATAPI
- Secondary ATAPI
- Advanced
- PCI Advanced
- ISA Bus
- Error Handling

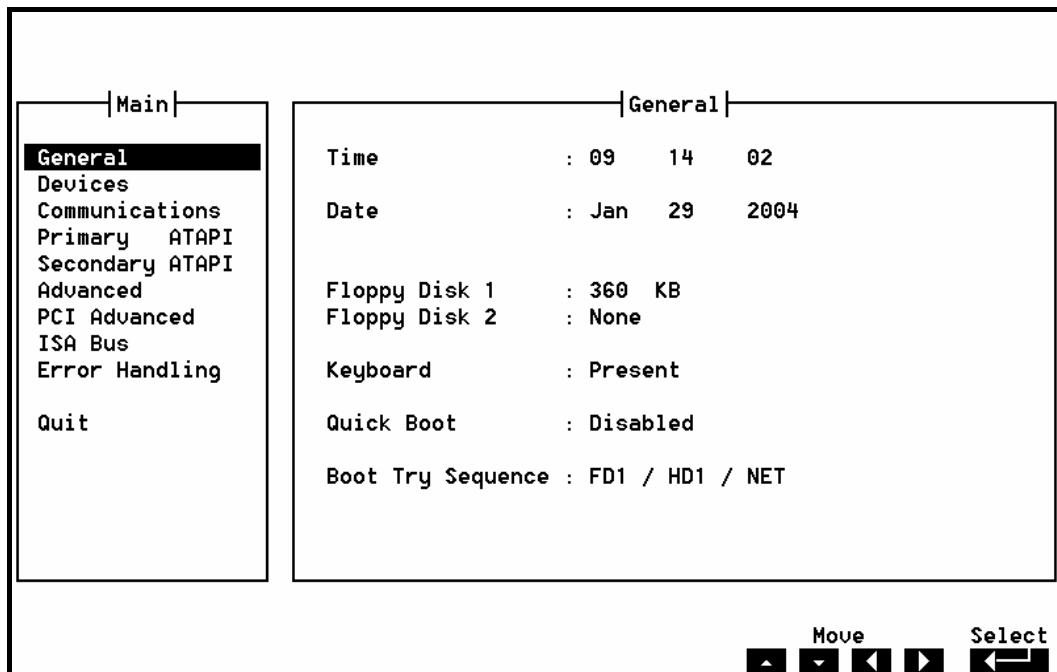

General Page

This page contain settings for the following devices:

- Time
- Date (for the Real Time Clock)
- Floppy Disk 1(*)
- Floppy Disk 2(*)
- Keyboard
- Quick Boot
- Boot Try Sequence

(*) The CPU-1461 Module can perform Floppy Disk 1 and 2 options only if used together with an Add-on module where floppy disk ports are available.

Time

The *time* is displayed in standard format: *hh mm ss* (hours - minutes - seconds).

Date

The *date* is display in standard format: MMM DD YYYY (month - day - year).

Floppy disks

The floppy disks are numbered starting from *one* and the BIOS maps these drivers starting form the letter "A".

Note: when the *boot sequence* starts from floppy disk number one (DOS letter "A"), any device selected as *floppy disk 1* can be a bootable disk. Obviously this device must represent a real bootable disk, with a proper boot sector and containing a valid O.S.

All the *floppy disks* can be configured with the same options. The CPU-1461 Module can perform floppy disk options only if used together with an Add-on module where floppy disk ports are available:

Option	Description	Note
None	No floppy disk selected	
360 KB	Floppy disk 5 ¼ - size 360 Kbytes	
1.2 MB	Floppy disk 5 ¼ - size 1.2 Mbytes	
720 KB	Floppy disk 3 ½ - size 720 Kbytes	
1.44 MB	Floppy disk 3 ½ - size 1.44 Mbytes	Common used size
Integrated SSD	On-board Flash EEPROM	Always available on all boards

Keyboard

If the *keyboard* is not really necessary in the system, you can disable it. In this way the system can bootstrap without error.

Option	Description	Note
Not Present	Keyboard presence ignored	Useful for embedded systems
Present	BIOS look for keyboard	

Quick Boot

With quick boot enabled, the system takes less than 5 seconds for a bootstrapping. This improvement is obtained to the disadvantage of BIOS tests (the setup must be correct and the peripheral must be connected to the module and ready at the boot); in particular the following test are skipped:

- System memory pattern test
- Keyboard detection
- Floppy disk presence (seek test)
- RTC time test

Option	Description	Note
Disabled	Normal BIOS test are used	
Enabled	Reduce set of BIOS test are used	

Boot Try Sequence

The *Boot Try Sequence* allows exchanging the boot disk order among Floppy Disk 1, Hard Disk 1, CD-ROM and NET.

Option	Description	Note
FD1 / HD1 / NET	Bootstrap order: FD1, HD1, NET	
NET / FD1 / HD1	Bootstrap order: NET, FD1, HD1	
HD1 / FD1 / NET	Bootstrap order: HD1, FD1, NET	
CD-ROM / FD1 / HD1	Bootstrap order: CD-ROM, FD1, HD1	

Devices Page

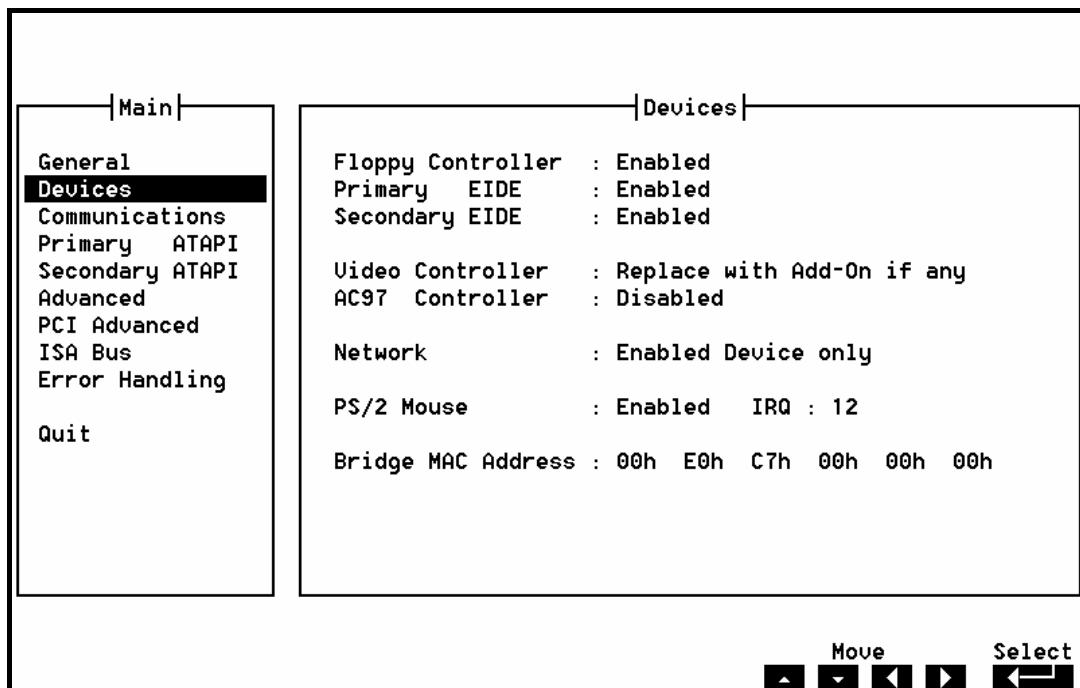

This page controls all the *on-board system-devices*; in particular:

- Floppy Disk Controller
- Primary EIDE
- Secondary EIDE
- Video Controller
- AC97 Controllers
- Network
- PS/2 Mouse
- Bridge MAC Address

Floppy Controller

The Floppy controller can be enabled or disabled

Primary and secondary EIDE

This option enables or disables the *on-board EIDE hard disk controllers*. For example, if an external hard disk controller needs to be used, the internal one must be disabled.

Option	Description	Note
Disabled	Disable the on-board hard disk controller	An external controller can be used
Enabled	Enable the on-board hard disk controller	

Video Controller

The on-board *Video Controller* can be automatically disabled if another one is found in the system; otherwise the on-board video controller can be forced anyway, even if another controller is present.

Option	Description	Note
Replace with Add-On if any	If an external controller is found, it is used	
Always use Integrated	In any case the on-board controller is used	

AC97 Controller

The on board AC97 controller can be enabled or disabled

Network

In PCI system the user can manually enable or disable the *on-board network adapter*.

Option	Description	Note
Disabled	Disable the on-board network controller	
Enabled Device only	Enable the on-board network controller	
Enabled device and Firmware	Enable the on-board network controller and the Firmware in order to allow the boot from network	

PS/2 Mouse

If not used, the PS/2 mouse can be disabled. In this way the interrupt *IRQ 12*, normally reserved for mouse, is free for PCI bus or other devices.

- **Note:** the interrupt reserved for mouse is fixed (IRQ 12); it is displayed for information only.

Option	Description	Note
Disabled	Disable the on-board mouse controller	
Enabled	Enable the on-board mouse controller	

Bridge MAC Address

This option allows configuring the hexadecimal values of the Bridge MAC Address.

Communications Page

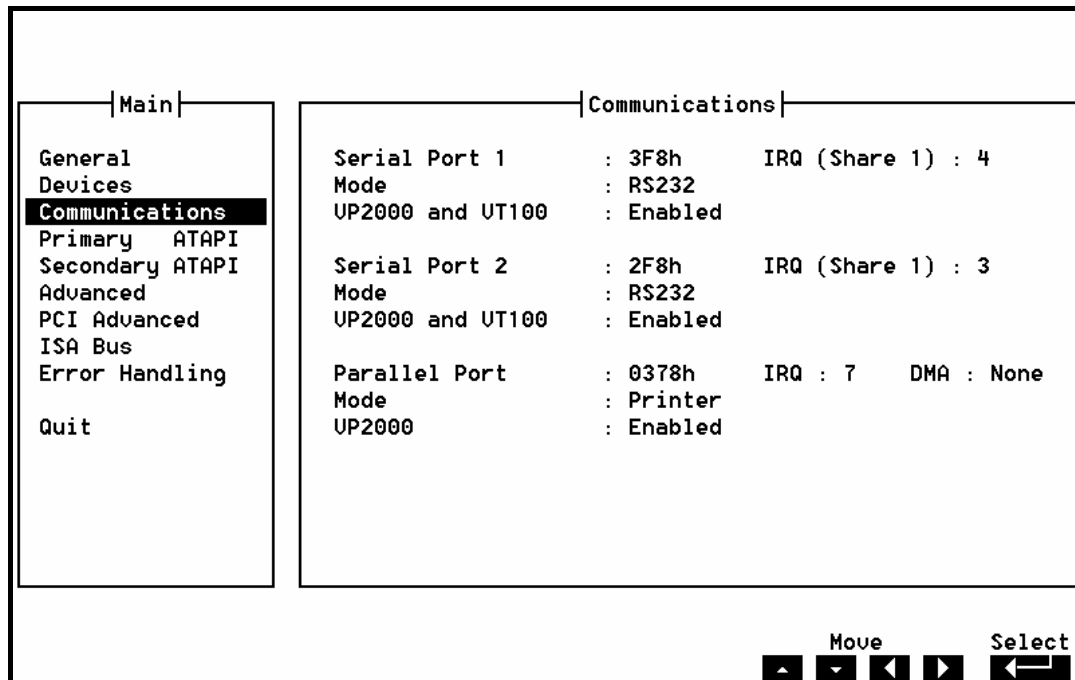

This page concerns all the on-board communication interfaces:

- Serial Port1
 - Mode
 - VP2000 and VT100
- Serial Port2
 - Mode
 - VP2000 and VT100
- Parallel Port
 - Mode
 - VP2000 and VT100

Serial Ports 1 and 2

Serial Port 1 is RS232 only. Serial Port 2 is RS232/422/485.

Serial Port Address (the same options for both Serial Ports)

Option	Description	Note
<i>Disabled</i>	Disable the serial port	
<i>3F8h</i>	Serial Port address selected at 3F8h	
<i>2F8h</i>	Serial Port address selected at 2F8h	
<i>3E8h</i>	Serial Port address selected at 3E8h	
<i>2E8h</i>	Serial Port address selected at 2E8h	

- **Note:** not all consecutive IRQ numbers from 3 to 15 can be used; to help the selection, the Setup program displays legal IRQ numbers only.
- **Note:** the IRQ is *shared*: the ports can use the *same IRQ number*.

VP2000 and VT100

With this option the user can enable or disable the VP2000 and VT100 functionality serial ports.

Parallel Port**Parallel Port Address**

Option	Description	Note
Disabled	Disable the serial port	
0378h	Parallel Port address selected at 378h	
0278h	Parallel Port address selected at 278h	

Parallel Port IRQ Number

Option	Description	Note
None	No IRQ selected for the Parallel Port	
3	IRQ 3 selected	
4	IRQ 4 selected	
...	...	
12	IRQ 12 selected	

- **Note:** not all consecutive IRQ numbers from 3 to 12 can be used; to help the selection, the Setup program displays legal IRQ numbers only.

Parallel DMA Channel

Option	Description	Note
None	No DMA selected for the Parallel Port	
0	DMA Channel 0 selected	
1	DMA Channel 1 selected	
3	DMA Channel 3 selected	

Parallel Port Mode

The user, according the parallel device connected to the interface, can choose The Parallel Port Mode. The default mode is *Bidirectional*.

Option	Description	Note
Printer	Standard mono-directional printer interface	
Bi-directional	Bi-directional printer interface	
PP FIFO	EPP and SPP mode	
ECP	ECP mode	
EPP	EPP mode	

VP2000

With this option the user can enable or disable the VP2000 functionality on the parallel port.

Primary and Secondary ATAPI Page

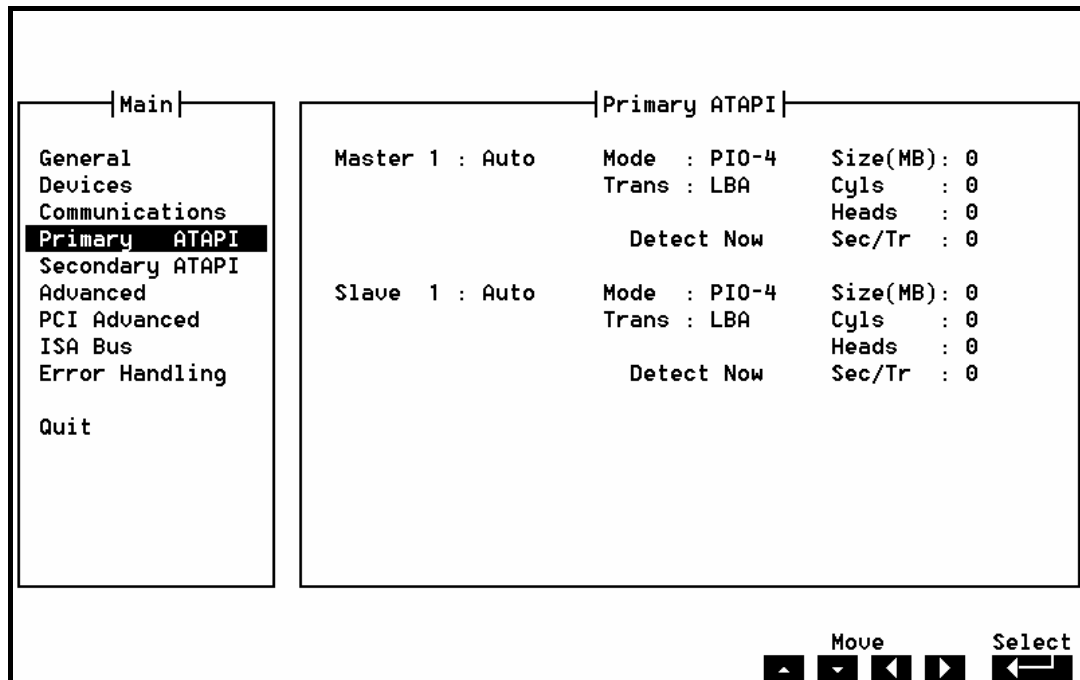

This option concerns mass storage devices using a standard *EIDE* interface.

The CPU board has two EIDE controllers, so the *ATAPI Units* can be separated in two parts: *ATAPI Primary* and *ATAPI Secondary*. In any case the options are the same.

- **Note:** ATAPI (or EIDE) devices can be both *hard disks* and *CD_ROM* devices or, sometimes, storage *tape-units*.
- **Note:** each EIDE interface supports two peripherals, called *master* unit and *slave* unit. Remember to select as *master unit* a bootable disk (containing any valid O.S.).

ATAPI unit type

Option	Description	Note
None	No unit selected	
Auto	Unit auto-detection	
LBA	LBA unit selected	
CHS	CHS unit selected	
CD-ROM	CD-ROM unit selected	
Other	Other unit selected	

- **Note:** when the *Auto* feature is selected, the BIOS ignores any other data (like Mode, Cyls, Head, etc.). Use this option for the most of hard disks or other ATAPI devices.
- **Note:** *LBA* and *CHS* are two different types of ATAPI units addressing mode. The first one is normally used with modern hard disks, from 512 Kbytes to above 8 Gbytes in size. For both modes, the user should know the *physical hard-disk structure* in terms of Cylinders, Heads and Sectors. For easy use of any kind of disk, the *Auto* option is preferable.
- **Note:** to speed-up the *bootstrap* select the option *None* for unused ATAPI devices.

PIO Mode

PIO is a special data-transfer system between two or more EIDE devices, where all the data pass through the processor. There are five transfer rates, called *PIO mode n* (with n=0..4). If the *Auto* (autodetect) option is disabled, the PIO mode must be specified.

Option	Description	Note
PIO-0	Transfer Rate of 3.3 MBps	
PIO-1	Transfer Rate of 5.2 MBps	
PIO-2	Transfer Rate of 8.3 MBps	
PIO-3	Transfer Rate of 11.1 MBps	
PIO-4	Transfer Rate of 16.6 MBps	

Translation Mode

Modern hard-disks have more cylinders than maximum number of cylinders permitted by DOS, so, theoretically, a DOS machine couldn't use a modern big-sized hard disk. This problem is solved using a special addressing mechanism. This "mechanism" is called *translation*. The most common translation method are *LBA* (*Logical Block Addressing*) and *ECHS* (*Enhanced Cylinders - Heads - Sectors*).

Option	Description	Note
LBA	LBA translation	
ECHS	Extended CHS translation	

Cylinders

Number of *hard-disk cylinders* (normally written on the disk label). If the auto-detection is used (suggested method!), the cylinders value is ignored by the BIOS.

Option	Description	Note
0..65536	Number of cylinders	

Heads

Number of *hard-disk heads* (normally written on the disk label). If the auto-detection is used (suggested method!), the heads value is ignored by the BIOS.

Option	Description	Note
0..64	Number of heads	

Sect/Tr

Number of *sectors per track* (normally written on the disk label). If the auto-detection is used (suggested method!), the sectors value is ignored by the BIOS.

Option	Description	Note
0..255	Number of sectors per track	

Size (MB)

This is the *hard-disk size*, in Mbytes, calculated by the BIOS, using either the autodetect method or the user hand-written values (for cylinders, heads and sectors).

- **Note:** the size cannot be changed directly by the user.

PCI Advanced Page

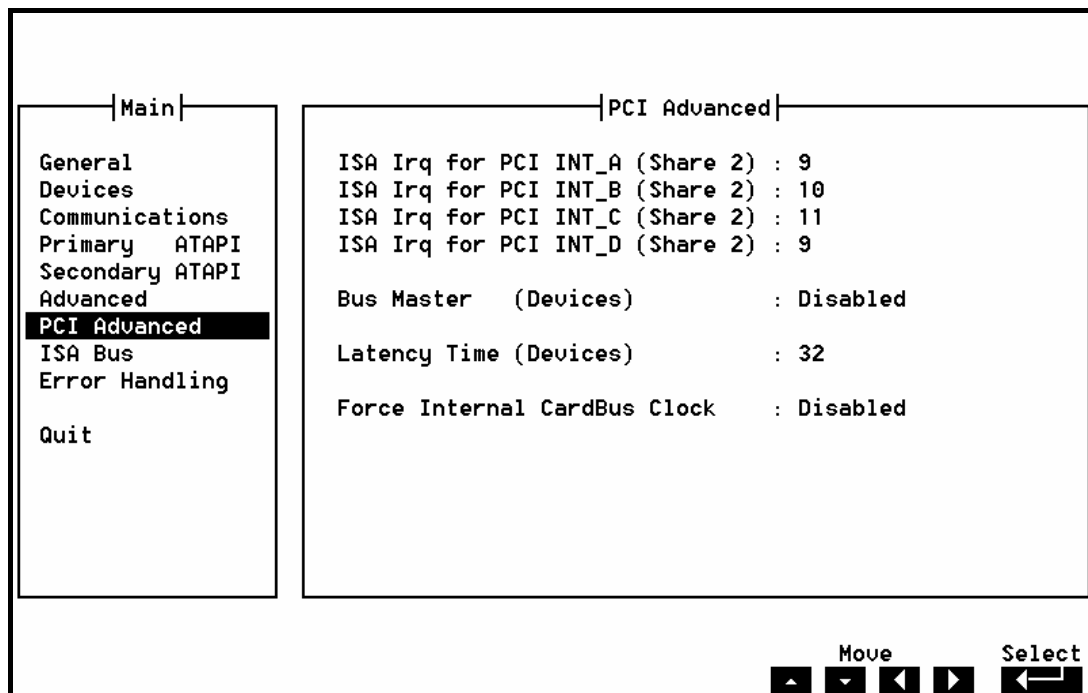

This page can be used to specify some *advanced PCI options* like:

- ISA IRQ
- Latency Time (both for CPU and devices)

ISA IRQ

This option makes possible any assignment between an *ISA IRQ* (for the Interrupt Controller) and the four *PCI IRQ lines A, B, C and D*. Obviously not all the assignments are legal, but the Setup programs shows only the available ISA interrupts.

Option	Description	Note
9	Routes PCI INT_n (n = A, B, C or D) to ISA IRQ 9	The IRQ# can be shared
10	Routes PCI INT_n (n = A, B, C or D) to ISA IRQ 10	The IRQ# can be shared
11	Routes PCI INT_n (n = A, B, C or D) to ISA IRQ 11	The IRQ# can be shared
12	Routes PCI INT_n (n = A, B, C or D) to ISA IRQ 12	The IRQ# can be shared

- **Note:** the ISA IRQ number can be shared among the PCI IRQ lines A, B, C and D.

Latency Time (Devices)

This *Latency Time* is the maximum time, expressed in clock cycle unit, that a generic PCI Device (like PCI bus master) can hold the control of the PCI bus. The default value, generally, is 32.

Option	Description	Note
0..255	Latency time expressed in clock cycle units	

ISA Bus

This page allows configuring for the I/O spaces and the memory address windows:

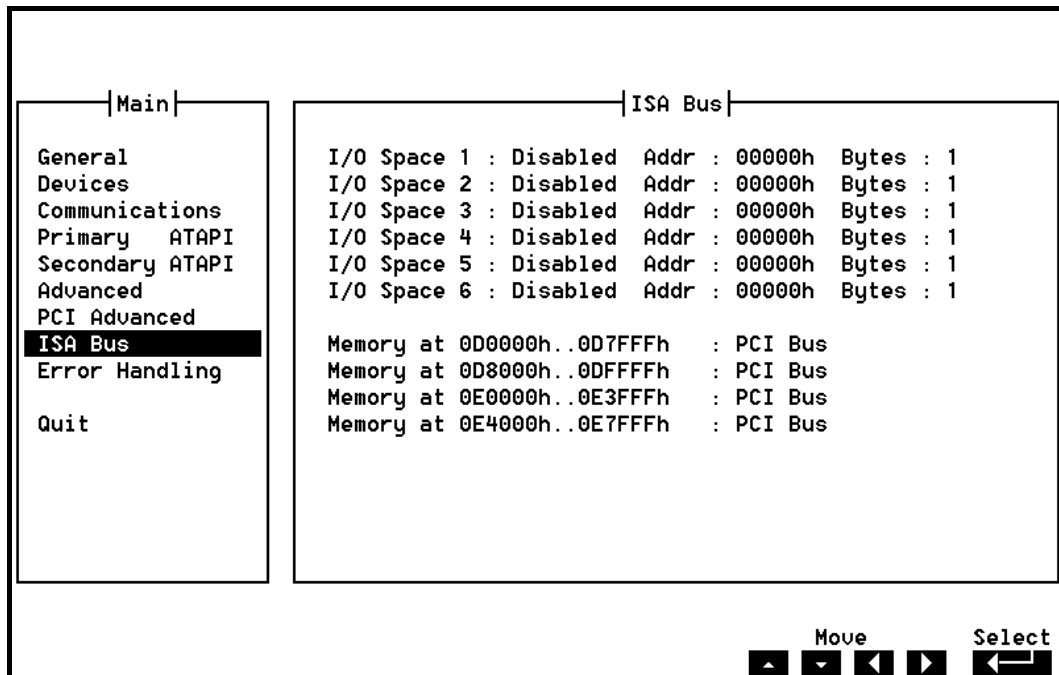

Error Handling Page

Generally, in a normal desktop BIOS, when an error is encountered by the POST sequence, the bootstrap stops and waits for a reboot. For example, a simple keyboard absence represents an irrecoverable error. This can be a serious problem in embedded systems. Using the *Error Handling* page, the user can decide to ignore one or more of errors that could be encountered during the boot.

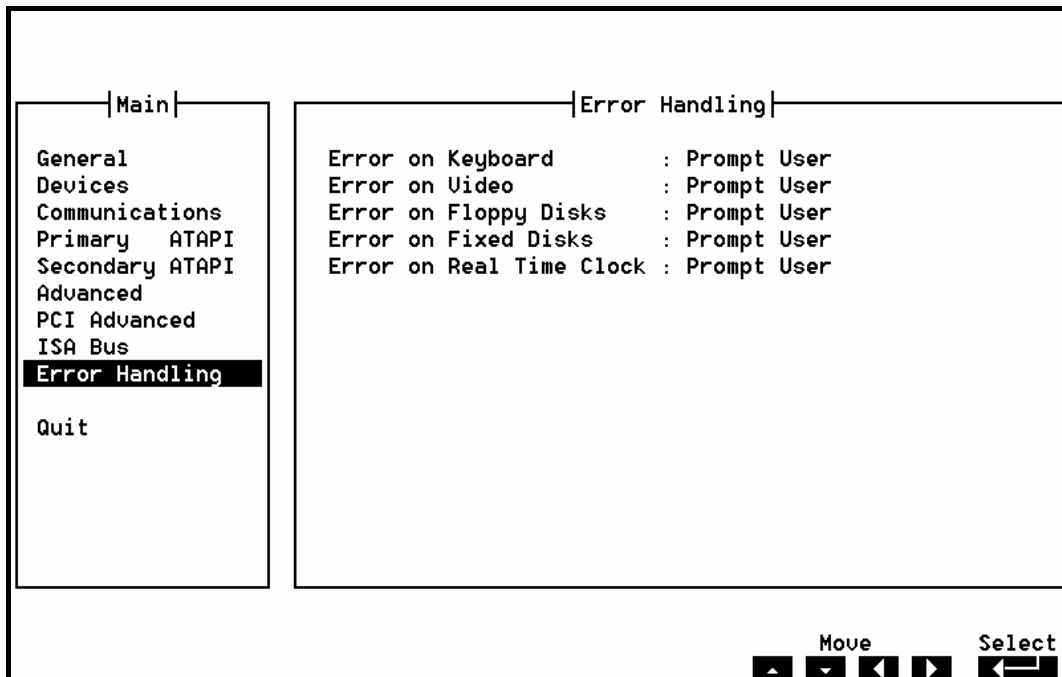

Error on Keyboard

The user can decide for himself if a *keyboard error* must stop the boot process or not.

Option	Description	Note
Ignore	The keyboard error is ignored	
Prompt User	When a keyboard error occurs, the system stops and waits for the user	

Error on Video

The user can decide for himself if a *video error* must stop the boot process or not.

Option	Description	Note
Ignore	The video error is ignored	
Prompt User	When a video error occurs, the system stops and waits for the user	

Error on Floppy Disks

The user can decide for himself if a *floppy disks error* must stop the boot process or not.

Option	Description	Note
Ignore	The floppy disks error is ignored	
Prompt User	When a floppy disks error occurs, the system stops and waits for the user	

Error on Fixed Disks

The user can decide for himself if a *floppy disks error* must stop the boot process or not.

Option	Description	Note
Ignore	The fixed disks error is ignored	
Prompt User	When a fixed disks error occurs, the system stops and waits for the user	

Error on Real Time Clock

The user can decide for himself if a *Real Time Clock (RTC) error* must stop the boot process or not.

Option	Description	Note
Ignore	The RTC error is ignored	
Prompt User	When a RTC error occurs, the system stops and waits for the user	

Chapter 5 Watch Dog Timer

This chapter explains how to use the Watch Dog timer.

You can also find information about how to use it through the System BIOS or directly by I/O mapped registers.

What is a Watch Dog?

The Watch Dog is a hardware countdown timer (2-255 sec./min.) that can be used to automatically restart the system in case of system or program execution failure.

Once enabled the Watch Dog must be refreshed (reloaded with the starting timeout value) by the application software before the timeout expires.

If the program execution stops, the application software will not refresh the Watch Dog anymore. A hardware reset will be generated when the timeout expires.

The Watch Dog is implemented using the National PC87364 SPIO Watch Dog feature.

How to use the Watch Dog

To enable, disable and refresh the Watch Dog you can:

- Use the System BIOS INT52h functions.
- Directly access Watch Dog I/O mapped registers.

Use the System BIOS INT 52h functions

This method can be used only with operating systems that preserve BIOS functions after boot (like DOS). Watch Dog timeout is fixed at 2 seconds.

How to turn the Watch Dog ON

Make a call to INT52h with AH=00Ch. The Watch Dog will be enabled to a fixed timeout of 2 seconds. Then the Watch Dog must be periodically (before 2 seconds) refreshed to avoid a hardware reset.

Assembler code example:

```
MOV  AH,00Ch
INT  052h
```

How to refresh Watch Dog

Make a call to INT52h with AH=00Eh. The Watch Dog counter will be reloaded with a fixed timeout of 2 seconds.

Assembler code example:

```
MOV  AH,00Eh
INT  052h
```

How to turn the Watch Dog OFF

Make a call to INT52h with AH=00Dh. The Watch Dog will be disabled. Then the Watch Dog doesn't need to be periodically refreshed anymore.

Assembler code example:

```
MOV  AH,00Dh
INT  052h
```

Directly accessing Watch Dog I/O mapped registers

This method must be used when the operating system you are using doesn't allow you to use the System BIOS calls, or when you need a different timeout than 2 seconds.

The following assembler code examples explain how to handle the Super I/O (SPIO) National PC87364 Watch Dog:

```
IO_SPIO_WDT_BASE EQU 7030h ; National PC87364 SPIO Watch Dog
```

Use the following code to Enable Watch Dog :

; Configure Watch Dog Mask Register ...

```
MOV  DX,IO_SPIO_WDT_BASE+00001h ; Mask Register
IN   AL,DX
AND  AL,11110000b ; No IRQs refresh
OUT  DX,AL
```

; Set Time Unit ...

```
MOV  DX,IO_SPIO_WDT_BASE+002h ; Status Register
IN   AL,DX
AND  AL,NOT 10000100b ; Clear Time Unit
OUT  DX,AL ; Update Register
```

; Watch Dog in minutes now

```
IFDEF TIME_IN_SECONDS
```

; Add this code to set Watch Dog in seconds ...

```
OR   AL,10000000b ; Set Seconds 1st step
OUT  DX,AL ; Update Register
OR   AL,00000100b ; Set Seconds 2nd step
OUT  DX,AL ; Update Register
```

```
ENDIF
```

; Set Timeout ...

```
MOV DX,IO_SPIO_WDT_BASE ; Timeout Period Register
MOV AL,DesideredTimeout ; 2..255 seconds/minutes
OUT DX,AL
```

Use following code to refresh the Watch Dog :

; Reload original Timeout...

```
MOV DX,IO_SPIO_WDT_BASE
MOV AL,DesideredTimeout ; 2..255 seconds/minutes
OUT DX,AL
```

Use the following code to disable the Watch Dog (no additional refresh required):

; Set Timeout to 0 Seconds ...

```
MOV DX,IO_SPIO_WDT_BASE ; Timeout Period Register
MOV AL,0
OUT DX,AL
```

- **Note:** for further information about the Watch Dog programming, refer to “PC87364 128-Pin LPC SuperI/O” manual by National Semiconductor.

Chapter 6 Troubleshooting

Many problems that you may encounter with your CPU are due to common errors like bad (cable) connections or misaligned pins.



Warning! Inserting the connectors backwards or misaligning pins may be result in serious damage for the (CPU) modules connected in the Development Kit!

This chapter will help you get your system operating properly.

It contains:

- Common problems and solutions
- Troubleshooting a PC/104 system
- How to obtain technical support
- How to return a product

Common Problems and Solutions

The following table lists some of the common problems that you may encounter using your CPU module, and suggests possible solutions. If you have problems with your CPU module, please review this table *before* contacting technical support.

Table 16. Common problems and solutions

CPU Module doesn't work	
No power or wrong polarity	Check for correct power on PC/104 bus connectors
Defective or misconnected device on bus	Check for misaligned bus connectors, remove other cards from stack
Cable connected backwards	Verify all cables are connected properly

Troubleshooting a PC/104 System

If you have reviewed the preceding table and still cannot isolate the problem with your CPU module, please try the following troubleshooting steps. Even if the resulting information does not help you find the problem, it will be very helpful if you contact technical support.

- **Simplify the system.** Remove items one at a time and see if one particular item seems to cause the problem.
- **Swap components.** Try replacing items in the system one-at-a-time with similar items.

Technical/Sales Assistance

If you have a technical question, please call Eurotech Customer Support Service at one of the numbers below, or e-mail our technical support team at:

- [email: techsupp@eurotech.it](mailto:techsupp@eurotech.it)
- Phone: +39.0433.485.411
- Fax: +39.0433.485.499

If you have a sales question, please contact your local Eurotech Sales Representative or the Regional Sales Office for your area.

Current information is available at the Eurotech website, located at:



<http://www.eurotech.it>

Manuals, application notes, patches, drivers and BIOS can be found at:

<ftp://ftp.eurotech.it/>

Returning For Service

Before returning any of Eurotech's products, you must call Eurotech Technical Support at +39.0433.485.411 or fill in and send (by **Fax: +39.0433.485.499** or [e-mail: techsupp@eurotech.it](mailto:techsupp@eurotech.it)) the **"Repair Order Module"** to obtain a Returned Material Authorization (RMA) number. The Module will be returned to you with the RMA number for enclosure with the returned products.



Note. You must have the RMA number in order to return any product for any reason!

The following information is needed to expedite the shipment of a replacement to you:

- Your company name and address for invoice
- Shipping address and phone number
- Product I.D. number
- The name of a technically qualified individual at your company familiar with the mode of failure on the module
- A detailed description of the problem and of the current configuration including OS and software loaded.

If the unit is out of warranty, service is available at a pre-established service charge. Contact Eurotech for pricing and please supply a purchase order number for invoicing the repair. Pack the module in an anti-static material and ship it in a sturdy cardboard box with enough packing material to adequately cushion it.



Warning! Any product returned to Eurotech improperly packed will immediately void the warranty for that particular product!

Appendix



A.1 Electrical and Environmental Specifications

The following section provides tables and illustrations showing the electrical, mechanical and environmental specifications.

You will find:

- Operating Characteristics
 - Electrical operating characteristics
 - Backup Battery characteristics
 - Operating temperature Range
- Absolute maximum ratings
- MTBF

Operating Characteristics

Electrical Operating Characteristics

Recommended power supply: VDD= +5V (with tolerance +/-5%)

Power consumption: 13.0 W typical (Pentium III 800MHz, 256MB).

Battery current draw (board off without any device on the SSD): 7 μ A.



Note. This module is not warranted against damage caused by overheating due to improper or insufficient cooling or airflow.

Backup Battery Characteristics

There is no configuration data saved by the BIOS into the CMOS Real Time Clock. Therefore, the CPU module does not need a battery, except in the case of applications needing to retain the date and time at power-off.

Battery Voltage: VBAT= 3.6V (range = 3V to 3.9V)



Note. Setup data is stored into the BIOS Flash EPROM; it is therefore impossible to lose the setup data due to a lack of backup-battery supply.

Operating Temperature Range

For proper operation of the module, the ambient air temperature must remain inside this range: 0°C to +50°C (+32°F to +122°F).

The +50°C test was made at a constant temperature in a climatic chamber.

Absolute Maximum Ratings

Table 17. Absolute Maximum Ratings

Supply Voltage:	V _{cc} : 0.00 to 7.00V
Storage Temperature Range:	-50°C to +85°C (-58°F to +185°F)
Non-Condensing Relative Humidity:	<95% at 40°C (+104°F)

This module is available also in Extended Temperature Ranges.



Warning! Stressing the device beyond the “Absolute Maximum Ratings” may cause permanent damage. These are stress ratings only. Operation beyond the “Operating Conditions” is not recommended. Extended exposure beyond the “Operating Conditions” may affect device reliability.

MTBF (Mean Time Between Failures)

Hours: 555000

Condition: GB-25

A.2 Mechanical Dimensions

The CPU-1461 mechanical dimensions are shown in the following picture:

- Dimensions: 90 X 96 mm (3.6"X3.8");
Height 18.6 mm (0.7"), pins and components on the bottom side not included

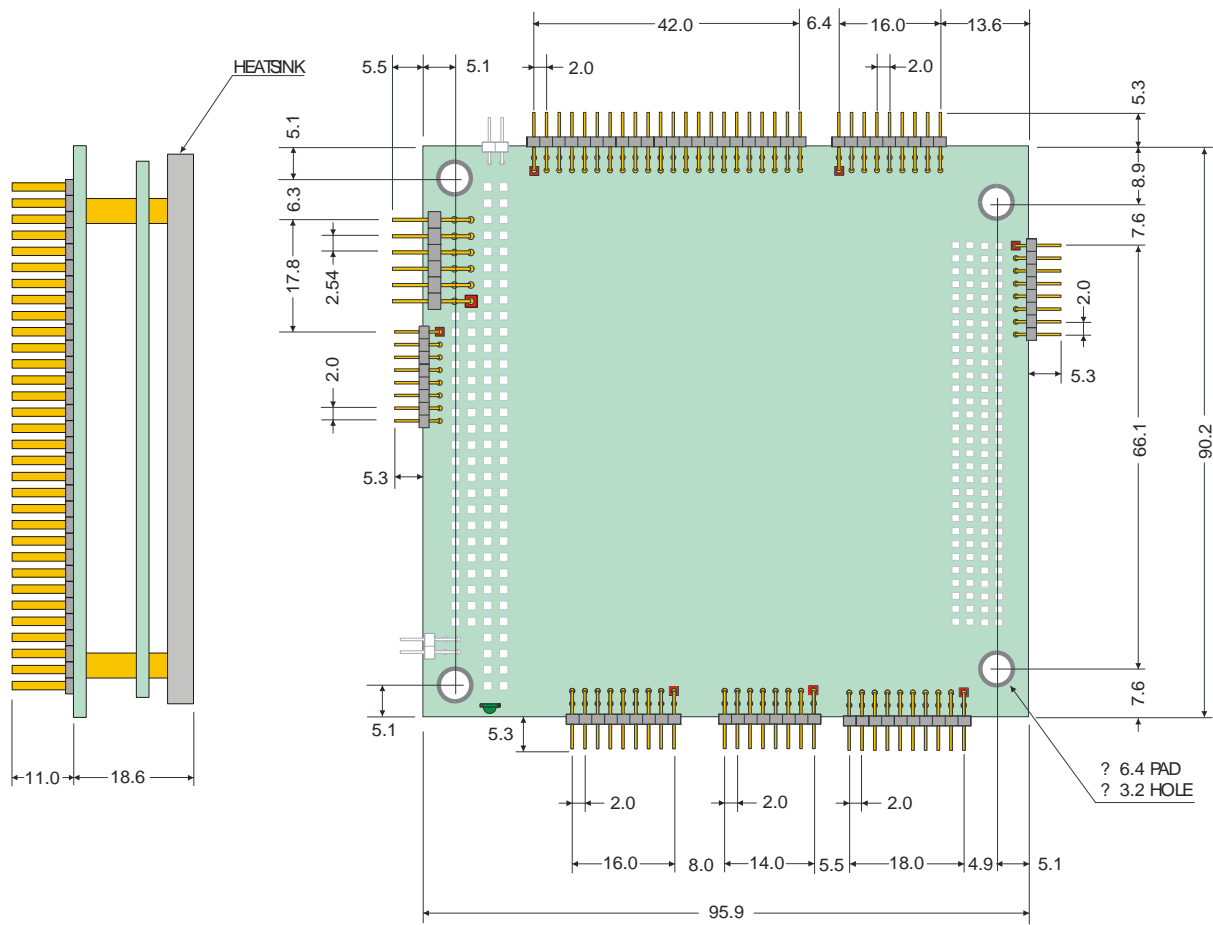

Dimensions are in millimeters

Figure 15. CPU-1461 Board dimensions



Note: For further information about the mechanical dimensions of ISA and PCI buses please refer to the PC/104 Consortium site (www.pc104.org)

USB Audio Codec Dimensions

In the following picture are shown the USB Audio Codec mechanical dimensions:

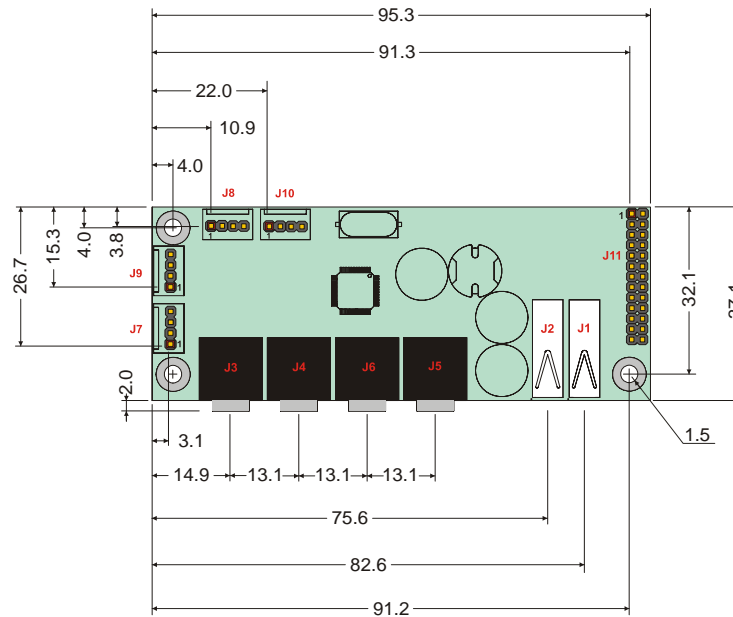

Dimensions are in millimeters

Figure 16. USB Audio Codec Dimensions

Ethernet Adapter Dimensions

In the following picture are shown the Ethernet Adapter mechanical dimensions:

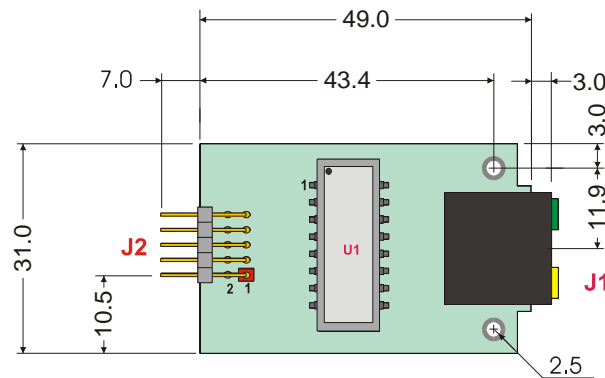

Dimensions are in millimeters

Figure 17. Ethernet Adapter Dimensions

Multifunction Adapter Dimensions

In the following picture are shown the Multifunction Adapter mechanical dimensions:

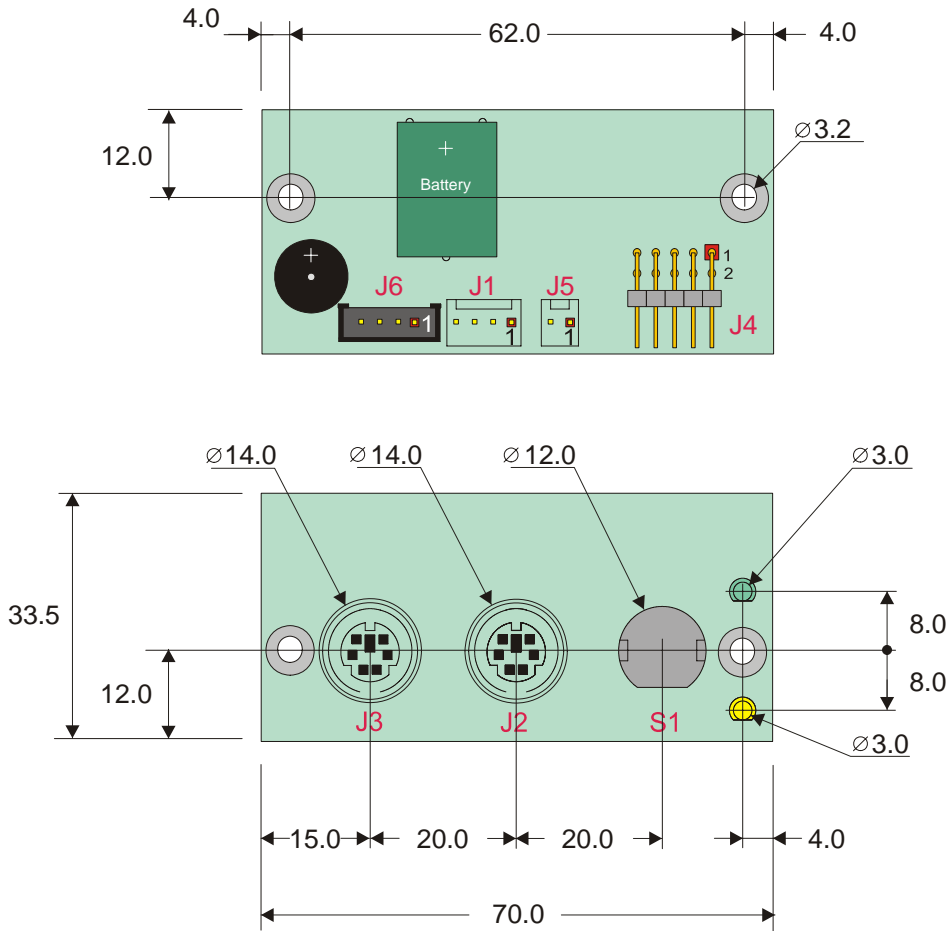

Dimensions are in millimeters

Figure 18. Multifunction Adapter Dimensions

A.3 Safety Summary

The following general safety precautions must be observed during all phases of operation, service, and repair of this equipment. Failure to comply with these precautions or with specific warnings elsewhere in this manual violates safety standards of design, manufacture, and intended use of the equipment. Eurotech SpA assumes no liability for the customer's failure to comply with these requirements.

The safety precautions listed below represent warnings of certain dangers of which Eurotech is aware. You, as the user of the product, should follow these warnings and all other safety precautions necessary for the safe operation of the equipment in your operating environment.

Ground the Instrument

To minimize shock hazard, the equipment chassis and enclosure must be connected to an electrical ground. The equipment is supplied with a three-conductor ac power cable; the power cable must be plugged into an approved three-contact electrical outlet, with the grounding wire (green) firmly connected to an electrical ground (safety ground) at the power outlet. The power jack and mating plug of the power cable meet International Electro technical Commission (IEC) safety standards.

Do Not Operate in an Explosive Atmosphere

Do not operate the equipment in the presence of flammable gases or fumes. Operation of any electrical equipment in such an environment constitutes a definite safety hazard.

Keep Away From Live Circuits

Operating personnel must not remove equipment covers. Only Factory Authorized Service Personnel or other qualified maintenance personnel may remove equipment covers for internal subassembly or component replacement or any internal adjustment. Do not replace components with power cable connected. Under certain conditions, dangerous voltages may exist even with the power cable removed. To avoid injuries, always disconnect power and discharge circuits before touching them.

Use Caution When Exposing or Handling the CRT

Breakage of the Cathode-Ray Tube (CRT) causes a high-velocity scattering of glass fragments (implosion). To prevent CRT implosion, avoid rough handling or jarring of the equipment. Only qualified maintenance personnel using approved safety mask and gloves should do handling of the CRT.

Do Not Substitute Parts or Modify Equipment

Because of the danger of introducing additional hazards, do not install substitute parts or perform any unauthorized modification of the equipment. Contact Eurotech technical staff or your local representative for service and repair to ensure that safety features are maintained.

Observe Dangerous Procedure Warnings

Warnings, such as the example below, precede potentially dangerous procedures throughout this manual. Instructions contained in the warnings must be followed. You should also employ all other safety precautions, which you deem necessary for the operation of the equipment in your operating environment.

Flammability

All Eurotech printed circuit boards (PCB) are manufactured by UL recognized manufacturers and have a flammability rating of UL-V0.

EMI Caution

This equipment generates, uses and can radiate electromagnetic energy. It may cause or be susceptible to electromagnetic interference (EMI) if not installed and used in a cabinet with adequate EMI protection.

CE Notice

This product complies with the EMC Directive (89/336/EEC). Compliance with this directive implies conformity to the following European Norms:

- EN55022 (CISPR 22) Radio Frequency Interference
- EN50082-1 (IEC801-2, IEC801-3, IEC801-4) Electromagnetic Immunity

The product also fulfills EN60950 (product safety), which is essentially the requirement for the Low Voltage Directive (73/23/EEC). This product was tested in a representative system to show compliance with the above-mentioned requirements. A proper installation in a CE-marked system will maintain the required EMC/safety performance.

Disclaimer of Warranty

THIS MANUAL IS PROVIDED 'AS IS' WITHOUT WARRANTY OF ANY KIND, EITHER EXPRESS OR IMPLIED, INCLUDING, BUT NOT LIMITED TO, THE IMPLIED WARRANTIES OF MERCHANTABILITY AND FITNESS FOR A PARTICULAR PURPOSE. The laws of some states and countries do not allow the disclaimer of express or implied warranties in certain transactions; therefore, this statement may not apply to you. As such, the above warranty disclaimer shall only apply to the extent permitted by law.

Notice

While reasonable efforts have been made to assure the accuracy of this document, Eurotech S.p.A. assumes no liability resulting from any omissions in this document, or from the use of the information contained therein. It is not warranted that the contents of this publication or any accompanying source code examples, whether individually or as one or more groups, will meet your requirements or that the publication or the accompanying source code examples are error-free. This publication could include technical inaccuracies or typographical errors.

Eurotech reserves the right to revise this document and to change its contents at any time without obligation to notify any person of such revision or changes. Any reference to a licensed program in this publication is not intended to state or imply that you can use only that licensed program. You can use any functionally equivalent program instead. No part of this material may be reproduced or copied in any tangible medium, or stored in a retrieval system, or transmitted in any form or by any means, radio, electronic, mechanical, photocopying, recording or facsimile, or otherwise, without the prior written permission of Eurotech S.p.A.

Reliability

Eurotech has taken extra care of product design in order to ensure reliability. The two major ways in which reliability is achieved are:

- The product is designed in top-down fashion, utilizing the latest in hardware and software techniques, so unwanted side effects and unclear interactions between parts of the system are eliminated.
- Eurotech tests each board by exercising its functions, burns it in under power, and retests it to ensure that the infant mortality phase is passed before the product is shipped.

Life Support Policy

Eurotech products are not authorized for use as critical components in life support devices or systems without the express written approval of the president of Eurotech S.p.A.

Glossary

A

ATA

Advanced Technology Attachment, is a disk drive implementation integrating the controller on the disk drive. There are several versions of ATA:

- **ATA:** Known also as IDE, supports one or two hard drives, a 16-bit interface and PIO modes 0, 1 and 2.
- **ATA-2:** Supports faster PIO modes (3 and 4) and multiword DMA modes (1 and 2). Also supports Logical Block Addressing (LBA) and block transfers. ATA-2 is marketed as Fast ATA and Enhanced IDE (EIDE).
- **ATA-3:** Minor revision to ATA-2.
- **Ultra-ATA:** Also called Ultra-DMA, ATA-33, and DMA-33, supports multiword DMA mode 3 running at 33 MBps.
- **ATA/66:** A new version of ATA, that will double ATA throughput to 66 MBps

ATAPI

Short for **AT Attachment Packet Interface**, an extension to EIDE that enables the interface to support CD-ROM players

B

BIOS

Basic I/O system. A set of routines that works closely with the hardware to support the transfer of information between elements of the system, such as memory, disks, and the monitor. Although critical to performance, the BIOS is usually invisible to the end user; however, programmers can access it.

C**CELLULAR**

Refers to communications systems where a geographic region is divided into sectors, called cells.

CPU

CPU (Central Processing Unit) is the heart (computational and control unit) of a computer. This device interprets and executes instructions.

D**DMA**

The Direct Memory Access is a technique for transferring data from the memory to a device. Data doesn't pass through the CPU.

DEVICE

It is any circuit performing a specific function.

E**ECP**

Extended Capabilities Port. An asynchronous, 8-bit-wide parallel channel defined by IEEE 1284-1944 that provides PC-to-peripheral and peripheral-to-PC data transfers.

EEPROM

EEPROM (also known as E²PROM) stands for Electronic Erasable Programmable ROM. This type of memory can be re-programmed by electronic signals.

EPROM

EPROM stands for Erasable Programmable ROM. This type of memory can only be erased by ultra-violet (UV) light.

ETHERNET

It is a type of Local Area Network (LAN) architecture. Ethernet supports data transfer rates of 10Mbps. A newer version of Ethernet, called Fast Ethernet (or 100Base-T), supports data transfer rates of 100 Mbps. And the newest version, Gigabit Ethernet supports data rates of 1 Gbit (1000 megabits) per second.

F**FDC**

Floppy Disk Controller. A special-purpose chip and associated circuitry that directs and controls reading from and writing to a computer's disk drive.

FIFO

First in/first out. A method for processing a queue in which items are removed in the same order in which they were added.

Flash ROM

Flash ROM (like EEPROM) can be re-programmed by electronic signals. Usually a Flash ROM has a capacity of 1MB. Into this memory usually resides BIOS and other useful programs or instructions.

G**GPS**

Global Positioning System is a worldwide satellite navigational system formed by satellites orbiting the earth and their corresponding receivers on the earth.

GSM

Global System for Mobile communications, is one of the leading digital cellular systems, and uses narrowband Time Division Multiple Access that allows eight simultaneous calls on the same radio frequency.

H**HDC**

Hard Disk Controller is a special-purpose chip and circuitry that directs and controls reading from and writing to a computer's disk drive.

I**IDE**

Integrated Device Electronics is a disk drive interface where the controller electronics reside on the drive itself. This allows elimination of the need for a separate adapter card.

IEEE

IEEE stands for Institute of Electrical and Electronics Engineers, pronounced "I-triple-E." Founded in 1963, IEEE is an organization composed of engineers, scientists, and students. IEEE is best known for developing standards for the computer and electronics industry.

I/O

I/O (Input/output). Two of the three activities that characterize a computer (input, processing, and output). Refers to the complementary tasks of gathering data for the microprocessor to work with and making the results available to the user through a device such as the display, disk drive, or printer.

IRQ

IRQ (Interrupt ReQuest). A method by which a device can request to be serviced by the device's software driver. The system board uses a PIC to monitor the priority of the requests from all devices. When a request occurs, a microprocessor suspends the current operation and gives control to the device driver associated with the interrupt.

ISA

ISA (Industry Standard Architecture) is an 8-bit / 16-bit bus that provides a buffered interface from devices on expansion cards to the PC internal bus.

L**LAN**

LAN (Local Area Network). A group of computers and other devices spanned over a relatively limited area (i.e. a single building).

LBA

LBA (Logical Block Address). A unit of data supplied or requested by a host computer.

M**MIDI**

MIDI (Musical Instrument Digital Interface). An industry-standard connection for computer control of musical instruments and devices. A hardware and data standard for communicating between hardware. Most references involve only the data standard, which is a byte stream used for controlling musical instruments and storing the output of such instruments.

MPEG

MPEG (Moving Picture Expert Group). Refers to one of several standard video-compression schemes. A CODEC for squeezing full-screen, VHS-quality digital video into a small data stream so that it can be played from a CD-ROM drive.

N**NDIS**

NDIS (Network Driver Interface Specification). The interface for network drivers used in Windows and Windows NT operating systems. NDIS provides a common mechanism by which any given NDIS-compatible transport driver can communicate with any NDIS-compatible network adapter driver. Moreover, it provides for multiple transports to work over multiple network adapters by supporting multiplexing between transports and drivers.

NMI

NMI (Nonmaskable Interrupt). An interrupt that cannot be overruled by another service request. A hardware interrupt is called nonmaskable if it cannot be masked by the processor interrupt flag.

NTSC

NTSC (National Television System Committee) of the Electronics Industries Association (EIA). The standards-setting body for television and video in the United States. Sponsor of the NTSC standard for encoding colour, a coding system compatible with black-and-white signals and the first system used for colour broadcasting in the United States. The broadcast standard for the United States and Japan. *See also* PAL format *and* SECAM.

O**OEM**

OEM stands for Original Equipment Manufacturer. This acronym is used primarily to refer to PC systems manufacturers.

P**PCI**

PCI (Peripheral Component Interconnect) is a standard high-performance, 32-bit / 64-bit bus, designed to be used with devices that have high bandwidth requirements.

PCMCIA

PCMCIA (Personal Computer Memory Card International Association). Sometimes used to refer to a controller for a type of expansion card documented in the PCMCIA standards.

PIO

The Programmed Input/Output is a method of transferring data over the IDE interface. The other way is the Direct Memory Access (DMA)

R**RAM**

RAM (Random Access Memory). Semiconductor-based memory that can be read-from and written-to by the microprocessor or other hardware devices.

ROM

ROM stands for Read Only Memory. This memory can only be read-from but not written-to.

S**SCSI**

SCSI stands for Small Computer System Interface. It is an I/O bus designed as a method for connecting several classes of peripherals to a host system without requiring modifications to generic hardware and software.

SECAM

SECAM (Sequential Couleur a Memoire; Sequential Colour with Memory). The television standard for France, Russia, and most of Eastern Europe. As with PAL, SECAM is based on a 50-Hz power system, but it uses a different encoding process and displays 819 horizontal lines per frame at a scan rate of 25 frames per second (50 fields per second). See also NTSC and PAL format.

SMBus

SMBus (System Management Bus). A two-wire interface based on the I²C protocol. The SMBus is a low-speed bus that provides positive addressing for devices, as well as bus arbitration.

SSD

SSD stands for Solid State Disk (i.e. Disk on Chip, Disk on Module, Flash ROM,). In fact this is not a real disk but a silicon support memory without mechanical parts that are in movement.

TDMA

Time Division Multiple Access is a technology for delivering digital wireless service using time division multiplexing, that is a type of multiplexing combining data streams by assigning each stream a different time slot in a set.

U**UART**

UART (Universal Asynchronous Receiver/Transmitter), is a module composed of a circuit that contains both the receiving and transmitting circuits required for asynchronous serial communication.

USB

USB (Universal Serial Bus) is a 4-pin bi-directional, isochronous, dynamically attachable serial peripheral bus that is capable of cascading low/medium speed peripherals (less than 10 Mbit/s)

V**VGA**

VGA Video graphics array. A video adapter that supports 640 × 480-pixel colour resolution. A video display standard for boot devices under Windows operating systems.

W**WAN**

WAN stands for a wide-area network and it is a system of LANs (in geographically separated areas) connected together via telephone lines and/or radio waves.

Acronyms and Abbreviations

A	Ampere	LCD	Liquid Crystal Display
APM	Advanced Power Management	LPT	Line Printer
ATA	AT Attachment	LVD	Low Voltage Differential
ATAPI	ATA Packet Interface	MB	Megabyte
BIOS	Basic I/O System	Mbps	Megabits per second
DMA	Direct Memory Access	MHZ	Megahertz
DOC	Disk On Chip	NIDS	Network Driver Interface Specification
DOM	Disk On Module	NTSC	National Television System Committee
ECC	Error Correction Code	OEM	Original Equipment Manufacturer
ECP	Enhanced Capabilities Port	PAL	Phase Alternation Line
FDC	Floppy Disk Drive Controller	PCI	Peripheral Component Interconnect
FDD	Floppy Disk Drive	PCMCIA	Personal Computer Memory Card International Association
HDC	Hard Disk Drive controller	PIC	Programmable Interrupt Controller
HDD	Hard Disk Drive	PIO	Programmed I/O
IDE	Integrated Device Electronics	POST	Power-On Self Test
IEEE	Institute for Electrical and Electronics Engineers, Inc.	RAM	Random Access Memory
I/O	Input/Output	RAMDAC	RAM digital-to-analog converter
IP	Internet Protocol	SCSI	Small Computer System Interface
IRQ	Interrupt Request	SMBus	System Management Bus
ISA	Industry Standard Architecture	TCP/IP	Transmission Control Protocol/Internet Protocol
KB	Kilobyte	USB	Universal Serial Bus
Kbps	Kilobits per Second	V	Volt
KHz	Kilohertz	W	Watt
LAN	Local Area Network	WAN	Wide Area Network
LBA	Logical Block Addressing		

Technical & Sales Assistance

If you have a technical question, please contact the Eurotech Customer Support Service

techsupp@eurotech.it

Old and new versions of manuals, application notes, patches, drivers and BIOS can be found at:

<ftp://ftp.eurotech.it/>

If you have a sales question, please contact your local Eurotech Sales Representative or the Regional Sales Office for your area.

Additional and latest information is available at Eurotech website, located at :

<http://www.eurotech.it>

Free Manuals Download Website

<http://myh66.com>

<http://usermanuals.us>

<http://www.somanuals.com>

<http://www.4manuals.cc>

<http://www.manual-lib.com>

<http://www.404manual.com>

<http://www.luxmanual.com>

<http://aubethermostatmanual.com>

Golf course search by state

<http://golfingnear.com>

Email search by domain

<http://emailbydomain.com>

Auto manuals search

<http://auto.somanuals.com>

TV manuals search

<http://tv.somanuals.com>