

Users Guide & Installation Handbook



Belling FSE 60 I

belling[®]

think of everything

Thank you for choosing this British built appliance from Belling.
We hope you enjoy many years of trouble free cooking with this oven. Should you need to contact us however, please call the number below and our Customer Care Centre staff will be pleased to help in any way they can.

0844 815 3746

When you dial this number you will hear a recorded message and be given a number of options. This indicates that your call has been accepted and is being held in a queue. Calls are answered in strict rotation as our Customer Care Representatives become available.

When calling please have to hand you appliances model an serial numbers. These numbers help us to quickly identify your product and enable our Customer Care team to provide you with the most up to date advice and support.

Alternatively spares and service call outs can be requested via our website:

www.belling.co.uk

Outside the UK and Northern Ireland, refer to your local supplier.

IMPORTANT NOTICE

Please note the cooling fan fitted to this appliance is an integral part of its safety and functionality.

When the appliance is installed care must be taken that the cooling fans performance is not impeded by any objects coming into contact with it. (Installation pipes, leads etc)

Care must also be taken that there is sufficient air flow at the rear of the appliance for the cooling fan to run at its optimum efficiency. (Particularly Built In appliances) See clearance dimensions in the installation section of the booklet.

During use the Appliance must never be disconnected from the Mains supply as this will seriously affect the safety and performance of the appliance, particularly in relation to surface temperatures becoming hot and gas operated parts not working efficiently.

The cooling fan is designed to run on after the control knob has been switched off to keep the front of the appliance and the controls cool until the appliance has naturally cooled itself.

CONTENTS

User Section	2 - 42
Introduction	2
Be Safe - Not Sorry.	4
Using the induction hob.	7
Oven & Grill functions.	16
Using the grills	17
Using the top oven	20
Using the multi-function main oven	23
Using the main oven	24
Using the ovens	31
Programmer/Clock	35
Care & cleaning.	40
Installation Instructions	43
Technical Data	45
Belling Customer Care	Back page

Please keep this handbook for future reference, or for anyone else who may use the appliance.

INTRODUCTION

Thank you for choosing a British built appliance by Belling.

We hope that the following information will help you to quickly familiarise yourself with the features of the appliance, and to use it successfully and safely.

Our policy is one of constant development and improvement. Strict accuracy of illustrations and specifications is not guaranteed. Modification to design and materials may be necessary subsequent to publication.

This cooker may be sited with cabinets on both sides, or it may be free standing. Sufficient space should be allowed at either side of the cooker to enable it to be pulled out for cleaning and servicing.

Please read the instructions in this handbook before using or installing this appliance. All installation and servicing work must be carried out by a competent person.

Your 1st Year Guarantee

To fulfil the conditions of your guarantee, this appliance must be correctly installed and operated, in accordance with these instructions, and only be used for normal domestic purposes.

Please note that the guarantee, and Service availability, are only available in the UK and Republic of Ireland.

Moving the cooker

Do not attempt to move the cooker by pulling on the doors or handles. Open the oven or grill door and grasp the frame of the cooker, taking care that the door does not shut on your fingers.

Take care to avoid damage to soft or uneven floor coverings when moving the appliance. Some cushioned vinyl floor coverings may not be designed to withstand sliding appliances without marking or damage.

Before using the appliance for the first time, remove any protective polythene film and wash the oven shelves and shelf runners in hot soapy water to remove their protective coating of oil. Even so, when you first turn on the oven or grill you may notice a smell and some smoke.

Glass door panels

To meet the relevant Standards of Domestic cooking appliances, all the glass panels on this appliance are toughened to meet the fragmentation requirements of BS3193. This ensures that, in the unlikely event that a panel breaks, it does so into small fragments to minimise the risk of injury.

Please take care when handling, using or cleaning all glass panels, as any damage to the surfaces or edges may result in the glass breaking without warning or apparent cause at a later date. Should any glass panel be damaged, we strongly recommend that it is replaced immediately.

INTRODUCTION

The cooling fan

When the appliance is operated, the cooling fans will automatically operate. This keeps the fascia, control knobs and components cool during cooking.

The cooling fan may continue to operate for a period of time after the controls have been switched off.

When hot and cold air meet, condensation forms. Some condensation may form on doors or on the fascia glass. This is normal and will disappear within 10 - 15 minutes.

Environmental Protection

We are committed to protecting the environment and operate an Environmental Management System which complies with BS EN ISO 14001.

Disposal of packaging

- All our packaging materials are recyclable and environmentally friendly.
- Please help us to protect our environment by disposing of all packaging in an environmentally friendly manner.
- Please contact your local authority for the nearest recycling centre.

Caution: Packaging materials can pose a risk of suffocation - keep away from children.

Electrical connection

Please refer to installation instructions for electrical connection.

In your own interest, and that of safety, make sure that the installation is carried out by a competent person.

Disconnection of electric appliances should always be carried out by a competent person.

Warning: This appliance must be earthed.

To replace an oven light bulb

Caution: Switch off the electricity supply to the cooker at the socket, to avoid the risk of electric shock.

Wait until the oven is cool, then remove the shelves.

The oven light is at the rear of the oven cavity.

Remove the loose oven back - unscrew the 4 securing screws (one at each corner).

Unscrew the lens cover (turn anticlockwise). Unscrew the bulb and replace. Replace lens cover.

Replace oven back.

Please note that the oven light bulb is not covered by the guarantee. Replacement bulbs can be ordered from your local supplier, or bought from a hardware store.

BE SAFE - NOT SORRY

When you are cooking, keep children away from the vicinity of the appliance.

This product is designed as a domestic cooking appliance for the preparation and cooking of domestic food products, and should not be used for any other purpose.

- Make sure you read and understand the instructions before using the appliance.
- Remove all packaging, protective films and oils from the appliance before using for the first time.
- Before using the hob for the first time, remove all packaging, protective films, oils and stickers from the glass ceramic.
- Apply a thin coating of cleaner conditioner and polish the surface with a clean dry cloth.
- The conditioner gives a protective covering to the ceramic glass which not only makes the hob easier to clean, but also ensures you will gain maximum life out of this product.
- Risk of burns - do not place objects made of steel, such as knives, forks, spoons and saucepan lids on the cooking surface, as they can get very hot.
- **Warning!** do not clean the appliance with a steam jet or high-pressure cleaning equipment.
- Keep electrical leads short so they do not drape over the appliance or the edge of the worktop.
- Keep all flammable materials (such as curtains, furnishings & clothing) away from the appliance.
- Never use the appliance for heating a room.
- Parts of the appliance may be hot during or immediately after use. Care should be taken to avoid touching heating elements inside the oven. Allow sufficient time for the appliance to cool after switching off.
- Do not use the oven with the door inner glass panel removed.
- Do not drape tea towels over the flue vents or doors, as this creates a fire hazard.
- Switch off the electricity supply before replacing the oven light bulb, to avoid the risk of electric shock.
- Do not use aluminium foil to cover the grill pan, or put items wrapped in foil under the grill, as this creates a fire hazard. The high reflectivity can also damage the element.
- Do not use foil on oven shelves, or allow it to block the oven flue, as this creates a fire hazard, and prevents heat circulation.

BE SAFE - NOT SORRY

- When cooking heavy items - eg; turkeys - do not pull the oven shelf out with the item still on the shelf.
 - When opening the appliance door, take care to avoid skin contact with any steam which may escape from the cooking.
 - Use oven gloves when removing hot food / dishes from the oven or grill. The oven / grill and utensils will be very hot when in use.
 - The glass ceramic can get hot whilst cooking; the cook zone itself does not generate heat. The heat generated is conducted back from the hot pans.
 - This induction hob complies with the applicable EMC and EMF standards. Therefore it should not interfere with other electronic units. Persons fitted with a pacemaker or any other electrical implant should clarify with their doctor or the producer of the implant, whether there implant is adequate and fail-safe, the pacemaker must be designed in compliance with the appropriate regulations.
 - It's important that good quality flat bottomed pans are used, if a pan creates a large air gap over the middle of the cooking zone, the accuracy of the temperature sensing can be affected.
 - If you use a griddle plate ensure it is completely cool before attempting to lift it from the hob as residual heat may cause burns. Always use oven gloves to protect your hands.
 - Don't leave pans on the hob when you're not around - take them off the cook zone if you have to leave the kitchen (even if you think it will only be for a moment)
 - If you're called away from the cooker - by the phone or someone at the door, either take pans off the heat or switch off your hob.
- Warning!** Do not use the hob if the ceramic glass surface is cracked or broken, as electrical parts are immediately beneath. Switch of the appliance at the supply and contact your supplier
- Warning:** This appliance must be earthed.
- All installation, servicing and maintenance work should be carried out by a competent person who will comply with current Regulations, Standards and Requirements.
 - **When you have finished cooking check that all controls are in the off position.**

BE SAFE - NOT SORRY

Smoke alarm - buy a smoke alarm fitted with a 'hush button' which can silence the alarm instantly should it activate accidentally & does not necessitate the removal of the battery (except to change for a new one).

Fire Blanket - consider having a fire blanket in your kitchen, mounted on the wall where you can get to it easily & quickly.

Deep-fat Frying - never fill a chip pan (or other deep-fat fryer) more than one-third full of oil. If you do have a chip pan fire:

- 1) call 999 immediately
- 2) never move the pan
- 3) turn off the heat but only if it is safe do so
- 4) never use water on a chip pan fire as this will create a fireball.

Kitchen Fire - if you have a fire in the kitchen, do not take risks - get everybody out of the house & call 999. If a pan catches fire:

- 1) do not move it - it is likely to be very hot
- 2) turn off the heat but only if safe to do so & never lean over a pan to reach the controls
- 3) if you have a fire blanket, put it over the pan
- 4) do not use a fire extinguisher on a pan of oil - the force of the extinguisher can spread the fire
- 5) if you have managed to extin-

guish the fire, allow the pan to cool completely.

Electrical Fire - if you have an electrical fire in the kitchen:

- 1) pull the plug out or switch off the power at the fuse box - this may be enough to extinguish the fire immediately
- 2) smother the fire with a fire blanket or use a dry powder or carbon dioxide extinguisher
- 3) remember: never use water on an electrical fire.









REMEMBER - if you have a fire in the kitchen, DO NOT take risks - get everybody out of the house and dial 999.

USING THE HOB

Using the hotplate

- Commercial simmering aids should not be used as they create excessive temperatures that can damage the surface and may cause a hazard.
- Do not place aluminium foil or plastic utensils on the ceramic glass, as they may melt and damage the surface.
- Do not use the ceramic glass hotplate surface for storage.
- When cooking with fat or oil, never leave unattended.
- Turn pan handles to a safe position, so they are out of reach of children, not overhanging the appliance, and cannot be caught accidentally.
- Position pans over the centre of the hotplate elements.
- Do not use the hob as a chopping board or a storage area, as this increases the likelihood of it being damaged - eg; plastic utensils placed on a warm hob may melt onto it, and damage the ceramic glass surface.
- Be careful when cooking foods in salted water, or foods containing large amounts of sugar, syrup or jam - if they are spilt onto hot areas of the hob they may damage it.
- Lift pans onto and off the surface, rather than sliding them across the surface, to avoid marks and scratches.
- If you use a wet paper towel to remove spills from a warm heating area of the hob, be careful to avoid steam burns.
- Do not use abrasive powder cleaners, metal wire wool pads, impregnated plastic pads, detergents, bleaches, bath stain removers, or chemical oven cleaners; all these types of products will damage the ceramic glass.

INDUCTION HOB FUNCTIONS

Feature	Symbol	Description
Eco Power		Induction Power is the most energy efficient means of cooking food on a hob, provides fast heat up and boiling times
Rotary Controls		Simple knob control with all the benefits of induction technology
Digital Display		Secret till "lit" hob display
No. of power levels	11	Precise and repeatable control settings
Keep Warm/ Low Temperature		Holds the pan temperature at approximately, ideal for melting chocolate "mmmm choc-ol-ateee"
Auto Heat Up (4 Zones)		Automatically heats up and turns down the power to a lower setting. Helps to take the worry out of pans boiling over and burning food
Power Boost		Temporarily boost the power to a cook zone by a massive 60%
Griddle zone	Yes	Flexibility is what counts. Place pans across the LH cook zones. This is ideal for large griddle plates and pans
Pan Detection		Lets you know if the correct pans are being used and helps to save energy. When a pan is lifted off the zone, the power is automatically cut.
Overheat Pan Detection	Yes	Helps prevent cookware from overheating providing an additional level of safety not available on other types of hobs
Child lock	L	Prevents unintentional operation of the hob
Residual Heat Indicators		Warns you against hot surfaces but also indicates that there is residual heat which can be used as a temporary warm zone
Holiday Shutdown	Yes	Rest assured this hob will eventually turn it self off if left

USING THE INDUCTION HOB

About the induction hob

The induction hob provides the most energy efficient hob technology available.

The induction system provides superior heat up and cool down times for pans - you get fast, precise, repeatable power control.

As induction only heats up the pan, there is no lost heat from the cooking process, which in turn, limits the heat generated in the kitchen.

Auto Power Tuning

Induction hobs have a unique power tuning systems that automatically tunes the power to the size of the pan base this ensures energy isn't wasted.

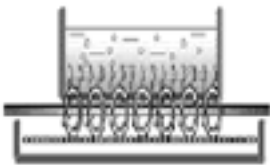

Small Pan

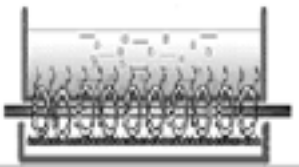

Large Pan

USING THE INDUCTION HOB

Induction controls

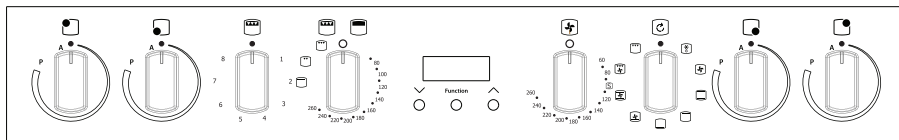

To turn the hob 'ON' / 'OFF'

To turn the hob 'ON' turn the control knob clockwise to set the cook zone to the desired power setting (1 to 9). The power display will automatically light up.

To turn the hob 'OFF' turn the control knob anti-clockwise to the 'OFF' position.

Auto Heat Up *A*

Helps to take the worry out of pans boiling over and burning food! No need to stand over the pan, allows you to do other tasks whilst maintaining control over the pan.

The Auto Heat Up is activated by rotating the control knob anti-clockwise and holding for a couple of seconds until the *A* symbol lights up in the display area, then by rotating the control knob to the required turn down setting.

The Auto Heat Up delivers full power (9) to the zone for a fixed period of time before automatically turning back down to the desired setting.

The Auto Heat Up has been tuned to provide the best boost period for each setting.

Average Auto Heat up time is 3 minutes.

Power Setting	Suggested food type	Auto Heat Up time (mins)
Low temp U °C	Melting chocolate	n/a
1	Milk, Soup Stews, Vegetables	1
2		2.5
3		4
4	Rice, Potatoes, Pasta	5
5		7
6	Frying, fish fingers Pancakes, Steaks	2
7		3
8		4
9	Full power	n/a
Boost	Full power +60%	n/a

USING THE INDUCTION HOB

Power Boost

Rev up your hob with this feature, temporarily boost the power to a cook zone by a massive 60%.

The power boost is a function that can be used to temporarily boost the normal maximum power for a cook zone by borrowing the available power from a "paired zone".

All the cook zones have this function apart from the "Griddle Zone" function.

The Power Boost is activated by rotating the control knob clockwise past power setting 9 and holding for a couple of seconds until  lights up in the display area. Power Boost is now activated.

The hob is split into "two paired areas".

LH Area (LHF and LHR Cook Zone) and RH Area (RHF and RHR Cook Zone).

Only one cook zone per area can be boosted at anyone time.

Note The Power Boost function will only operate for a limited time and is also under thermal control. This means the power boost will deactivate automatically if the product is hot, to protect the internal electronic components of the hob and to prevent the cookware from overheating.

Cook Zone	Normal Max Power (9) kW	Boosted Power kW	Maximum Permissible Setting on Paired Zone
LHF	1.85	3.00	8 (LHR)
LHR	1.85	3.00	8 (LHF)
RHF	1.40	2.20	8 (RHR)
RHR	2.30	3.70	6 (RHF)

USING THE INDUCTION HOB

Griddle Zone

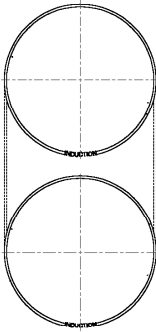

Flexibility is what counts.

The LH zones can be used as two separate round cooking zones which can be controlled individually creating a hot and cold zones on a griddle or the power settings can be matched to provide an even heat.

Large pans and griddle plates can be placed across the two zones.

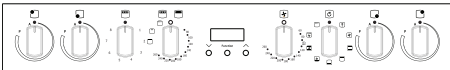

Keep Warm

The Keep Warm setting is found between power setting 0 and 1. Rotate the control knob clockwise until the  symbol appears on the display.

Pan detection



When a zone has been activated but no pan has been placed on the cook zone, this means the hob only uses power when a suitable pan is placed on the zone, this reduces the energy used during the cooking process, i.e. when you take your pan off the zone the hob automatically reduces the power, and only switches back on when you replace the pan.

Note If the  symbol does not disappear when a pan is placed on the zone it indicates that the pan is not suitable for induction cooking.

Get a magnet to check the pans.

Pan Sizes

Cook Zone	Smallest Recommended Pan Diameter
LHF	145 mm
LHR	145 mm
RHF	120 mm
RHR	180 mm

USING THE INDUCTION HOB

Cookware for induction hobs

Cookware for induction cooking zones must be made of metal and have magnetic properties. The base must also be the correct diameter.

Suitable Cookware for Induction Hobs	Unsuitable Cookware
Enameled steel pots with a thick base	Pots made of copper, stainless steel, aluminium, oven-proof glass, wood ceramic and terracotta
Cast Iron pots with an enameled base	
Pots made of multilayer stainless steel, rustproof ferrite steel or aluminium with a special base	
Pans marked for use with induction	

How to establish the suitability of a pan

Check your pans with a magnet. If it sticks and it's the correct diameter, it's suitable for use with induction. Also with pans that bear the symbol for suitability for cooking with induction.



Note - when using certain pans, you may get various noises from the pans. This is due to the design of the pans and does not effect the performance or safety of the hob.

USING THE INDUCTION HOB

Child Lock

Stops the “kids” messing with your lovely induction hob.

This feature is to help prevent accidental switching on of the hob, especially by young children.

To activate/deactivate, simultaneously rotate the Left Hand Rear and Right Hand Rear control knobs to the Auto Heat Up setting for a couple of seconds.  will light up in the display area for all cook zones to show activation. Follow the same procedure to deactivate and the  symbol will disappear from the display area.

Residual Heat indicators

If when the cook zone is switched off the glass surface is above 60°C, H will be displayed in the cook zone display until the glass surface drops below approx 55°C.

This feature not only warns you against hot surfaces but also indicates that there is residual heat which can be used as temporary warm zone.

Note - The cook zone itself does not heat up, but the ceramic glass does get hot because of the hot pan conducting heat back onto the hob glass.

Overheat Pan Protection

The hob is equipped with additional safety systems that help to prevent cookware from overheating, provid

ing an additional level of safety not available on conventional hobs (such as gas and ceramic hobs).

Approx. Glass Surface Temperature (Approx °C)	Intelligent hob safety system
200	Reduces Power Boost setting to Power Level 9
250	Reduces power to 60% of power level setting
270	Switches cook zone off
300	Switches whole appliance off

Note - The safety temperature control of the pans is only possible with quality flat bottomed pans suitable for induction cooking. Poor quality pans can create air gaps between the glass and the pan, which affects the accuracy of the temperature control.

Auto Stand by (Holiday Shut Down)











Have you ever gone on holiday and wondered if you have switched off the hob? No need to worry about leaving your hob on with the most advanced cooking system available - the hob will automatically switch itself off if left unattended.

USING THE INDUCTION HOB

Troubleshooting with the Induction Hob

Code	Problem	Possible Cause	Solution
	Hob is not working L in display	Child lock is activated	Deactivate child lock
	Power boost not working	The appliance is hot, power boost is deactivated when the appliance is hot to protect the electronics and prevents pans from overheating	Allow the appliance to cool
ER21	Control unit cuts off after program setting	Electronics overheating	Allow the appliance to cool
ER400			Check mains cable connection and terminals at the terminal block are wired correctly
E2	Overheating of induction coil	Pan overheating	Remove pans and allow to cool
E8	Fan blocked or faulty	Fan inlets are blocked or faulty fans	Clean fan inlet at the rear of the appliance

OVEN & GRILL FUNCTIONS

Function		Recommended Uses
	Base Heat Only	Used to finish off the bases of food following cooking using the conventional or fanned modes. The base heat can be used to provide additional browning for pizzas, pies and quiche. Use this function towards the end of cooking.
	Top Heat Only	The heat is ideal for browning off the tops of food as it is not as fierce as the grill following conventional or fanned cooking. Provides additional browning for dishes like lasagne or cauliflower cheese. Use this function towards the end of cooking.
	Conventional Oven	This function is ideal for traditional roasting. The meat is placed in the middle of the oven, roast potatoes towards the top.
	Intensive Bake (Pizza Setting)	Ideal for pizzas and also suitable for food with a high moisture content, such as quiche, bread and cheesecake. It also eliminates the need for baking pastry blind.
	Fanned Grill	The fan allows the heat to circulate around the food. Ideal for thinner foods such as bacon, fish and gammon steaks. Foods do not require turning. Use with the oven door closed.
	Fanned Oven	The even temperature in the oven makes this function suitable for batch baking or batch cooking foods.
	Defrost	To defrost foods, such as cream cakes/gateaux, use with the oven door closed. For cooling dishes prior to refrigeration, leave the door open.
	Dual Grill	This function cooks food from the top and is ideal for a range of food from toast to steaks. As the whole grill is working, you can cook larger quantities of food.
	Single Grill	For smaller quantities of food, but is still ideal for anything from toast to steaks.
	Base Heat with Fan	Used to cook open pies (such as mince pies) the base element ensures that the base is cooked while the fan allows the air to circulate around the filling - without being too intensive.

USING THE GRILLS

Caution: Accessible parts may be hot when the grill is used, young children should be kept away.

Using the grills

This appliance has a grill in both oven cavities.

The top oven grill is a fully variable dual element grill.

The main oven features variable grilling - with a single element conventional grill, and a fanned grill function.

Follow the instructions given on the next page when operating these grills.

Preheating

For best results, preheat the grill for 3 - 5 minutes.

Aluminium foil

Using aluminium foil to cover the grill pan, or putting items wrapped in foil under the grill can create a fire hazard, and the high reflectivity can damage the grill element.

Detachable grill pan handle

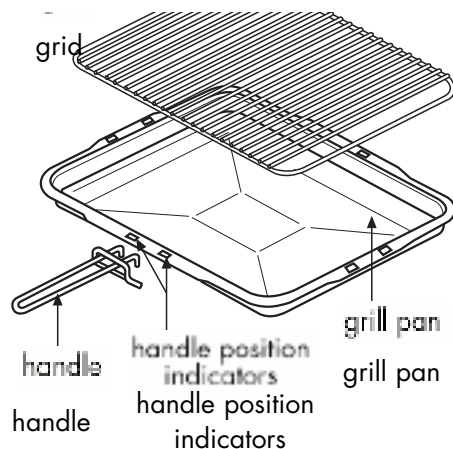

Place the handle over the edge of the grill pan, at the narrow side edges. Slide the handle to the centre, and locate between the handle position indicators.

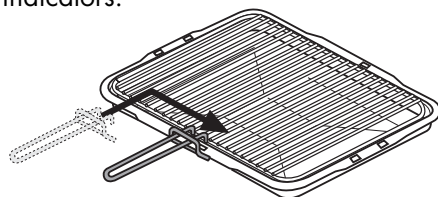

The handle should be removed from the pan during grilling, to prevent overheating.

The handle is designed for removing / inserting the grill pan under the grill when grilling.

If cleaning the grill pan when it is hot, use oven gloves to move it. *Do not* use the handle to pour hot fats from the grill pan.

Food for grilling should be positioned centrally on the trivet.

USING THE GRILLS



Grilling in the top oven

Caution: Accessible parts may be hot when the grill is used, young children should be kept away.

The top oven grill is a fully variable dual element grill.

To switch on the grill

Open the top oven / grill door.

Turn the top oven control knob past the oven temperature markings to either the single economy grill  symbol, or the dual grill  symbol.

The grill regulator - to the left of the top oven control - must then be switched on. This enables variation of the heat output from the grill on either the single grill or dual grill settings.

The dual grill uses all of the top element, and the single economy grill setting uses the inner part of the element only.

Important: The door must be kept open when the grill is used.

To switch off, return the control knob to the "off" position.

Note that the grill will not operate if the top oven is switched on.

Using the top oven grill

For grilling smaller quantities of food the (single element) economy grill can be utilised. This grill function can be controlled between settings 1 and 8.

For grilling larger quantities of food, the (dual element) full grill can be utilised. The full grill can also be controlled between settings 1 and 8.

When using the grill in the top oven, the speed of grilling can be controlled by use of either the variable control or by selecting higher or lower shelf position.

For toasting, and for grilling foods such as bacon, sausages or steaks, use a higher shelf position.

For thicker foods such as chops or chicken joint pieces, use a middle to low shelf position.

The cooling fan

When the grill is switched on, you will hear the cooling fan come on - this keeps the fascia and control knobs of the appliance cool during grilling. The fan may continue to operate for a period after the grill control has been switched off.

USING THE GRILLS

Grilling in the main oven

Caution: Accessible parts may be hot when the grill is used - young children should be kept away.

The grill / fanned grill settings use the inner element only.

Conventional grill



The door must be closed when the grill is used for conventional grilling.

When opening the door, take care to avoid skin contact with any steam which may escape from the cooking.

- (i) Turn the selector control knob to the conventional grill setting.
- (ii) Turn the temperature control knob to the desired temperature for grilling, similar to oven function. However, do not set to a temperature greater than 230°C.

Fanned grill



The door must be closed when the fanned grill is used.

When opening the door, take care to avoid skin contact with any steam which may escape from the cooking.

- (i) Turn the selector control knob to the fan grill setting.
- (ii) Turn the temperature control knob to the desired temperature up to 230°C.

Fanned grilling may be faster than conventional grilling because air is being circulated around the food. Thin portions of food, such as bacon or fish fillets, may not need turning.

For best results, preheat the grill for 3 - 5 minutes.

Note that when grilling, the door must remain closed before and after grilling, and the temperature control must not exceed 230°C.

Grilling in the main oven

The speed of grilling can be controlled by selecting a higher or lower shelf position.

For toasting, and for grilling foods such as bacon, sausages or steaks, use a higher shelf position.

For thicker foods such as chops or chicken joint pieces, use a middle to low shelf position.

USING THE TOP OVEN

When you are cooking keep children away from the vicinity of the oven.

Caution: The top element gets extremely hot when in use, so take extra care to avoid touching it.

The top oven is a conventional oven

Note: The top oven is not controlled by the programmer.

To turn on the top oven

Turn the temperature control knob clockwise until the required temperature is selected.

The red thermostat indicator will come on until the selected temperature is reached, and then go off; it will turn on and off periodically as the thermostat operates to maintain the selected temperature.

To switch off, return the top oven control knob to the off position.

Important: Never put items directly on the base of the oven, or cover the oven base with foil, as this may cause the element to overheat. Always position items on the shelf.

Top heat only

Turn the top oven selector past the oven temperature markings to the top heat symbol. This fixed heat setting can be used to brown the top of dishes such as cauliflower cheese or baked alaska.

The cooling fan

When the top oven is switched on, you will hear the cooling fan come on - this keeps the fascia and control knobs of the appliance cool during cooking. The fan will continue to operate for a period after the oven control has been switched off.

Preheating

The oven must be preheated when cooking frozen or chilled foods, and we recommend preheating for yeast mixtures, batters, soufflés, and whisked sponges.

Preheat the oven until the indicator light switches off for the first time, this will take up to 20 minutes depending on the temperature selected.

If you are not preheating the oven, the cooking times in the following guide may need to be extended, as they are based on a preheated oven.

USING THE TOP OVEN

Shelf positions

There are 2 shelf positions which are counted from the bottom of the oven upwards, so shelf position 1 is the lowest.

When cooking frozen or chilled food, use the highest possible shelf position, while allowing some clearance between the food and the top element.

The oven shelf must be positioned with the upstand at the rear of the oven and facing up. Position baking trays and roasting tins on the middle of the shelves, and leave one clear shelf position between shelves, to allow for circulation of heat.

When using the top oven

As part of the cooking process, hot air is expelled through a vent at the top of the oven(s). When opening the oven door, care should be taken to avoid any possible contact with potentially hot air, since this may cause discomfort to people with sensitive skin. We recommend that you hold the underneath of the oven door handle.

Using the Top Oven

Top oven baking guide

Cooking times

These times are based on cooking in a preheated oven.

These cooking times are approximate, because the size and type of cooking dish will influence time as well as personal preferences.

Shelf positions

As a general guide, when cooking frozen or chilled food, use the highest possible shelf position, while allowing some clearance between the food and the top element. Follow the instructions given on packaging.

Cooking temperatures

The temperature settings and time given in the Baking Guides are based on dishes made with block margarine. If soft tub margarine is used, it may be necessary to reduce the temperature setting. If a recipe gives a different temperature setting to that shown in the guide, the recipe instruction should be followed.

Because the top oven is more compact, it may be necessary to reduce cooking temperatures specified in recipes by up to 20°C.

Use the baking guide as a reference for determining which temperatures to use.

Item	Temperature °C	Shelf position	Approximate cooking time
Small cakes	180	1	15 - 20 mins
Victoria sandwich (2 x 180mm / 7")	160	1	20 - 25 mins
Swiss roll	200	1	8 - 12 mins
Semi rich fruit cake (180mm x 7")	140	1	2¼ - 2¾ hours
Scones	215	1	10 - 15 mins
Meringues	90 - 100	1	2 - 3 hours
Shortcrust pastry	200 - 210	1	Depends on size & type of cooking dish & also the filling
Puff / flaky pastry	200 - 210	1	
Choux pastry	200 - 210	1	
Biscuits	160 - 200	2	10 - 20 mins
Sponge pudding	150	1	30 - 45 mins
Milk pudding	140	1	2 - 2½ hours

USING THE MULTI-FUNCTION MAIN OVEN

Caution: Accessible parts may be hot when the oven is used, young children should be kept away.

The main oven is a multi-function oven, and may be used as a conventional oven or a fanned oven. It may also be used as a grill, or with one of the other oven functions.

Manual operation

The programmer must be set to manual operation before the main oven or grill functions can be used. If **A** (Auto) is on the programmer display, return the oven to manual operation by pressing the plus and minus buttons simultaneously. Any programme which has been set is cancelled.

Baking tray and roasting tins

For best cooked results and even browning, the maximum size baking trays and roasting tins that should be used are as follows;

Baking tray 350mm x 280mm

This size of baking tray will hold up to 16 small cakes.

Roasting tin 370mm x 320mm

We recommend that you use good quality cookware. Poor quality trays and tins may warp when heated, leading to uneven baking results.

To turn on the main oven

Step 1 - Select the function

Turn the selector control knob in either direction, until the function you require is selected.

Step 2 - Set the main oven control

If you have selected an oven cooking function, then simply turn the main oven control knob clockwise to the required temperature - this brings on the neon indicator light, which will stay on until the oven reaches the required temperature.

If you have selected defrost, do not turn the thermostat control on.

To switch off the main oven, return the control knobs to the 'off' position.

Automatic operation

See 'Programmer / Clock' section.

USING THE MAIN OVEN

Oven cooking

Caution: Accessible parts may be hot when the appliance is in use - keep children away from the vicinity of the oven.

Never put items directly on the base of the oven or cover the oven base with foil, as this can cause the base element to overheat.

Manual operation

Set the programmer to manual operation. See 'Programmer / Clock' section.

Turn the selector control knob until the symbol for the desired oven function is selected.

Turn the main oven control knob to the desired temperature.

The red thermostat indicator neon will come on until the selected temperature is reached, then go off. It will cycle on and off as the thermostat operates to maintain the selected temperature.

To switch off the main oven, return the main oven control knob to the "off" position.

Automatic operation

See 'Programmer / Clock' section.

Oven shelves

The oven shelf must be positioned with the upstand at the rear of the oven and facing up.

Position baking trays and roasting tins on the middle of the shelves, and leave one clear shelf position between shelves, to allow for circulation of heat.

Preheating (conventional mode)

When using the conventional mode to cook sensitive items such as soufflé's and Yorkshire puddings or, when cooking bread, we recommend that the oven is pre-heated until the neon switches off for the first time. For any other types of cooking, a pre-heat is not required.

Always use the fan oven setting for preheating to save time and electricity. After the oven has been preheated on the fan oven setting, turn the selector control knob to the oven setting you require.

Preheat the oven until the indicator neon switches off for the first time; this will take between 5 - 15 minutes, depending on the temperature selected.

When using the oven

As part of the cooking process, hot air is expelled through a vent at the rear of the oven. When opening the oven door, care should be taken to avoid any possible contact with potentially hot air, since this may cause discomfort to people with sensitive skin. We recommend that you hold the underneath of the oven door handle.

The cooling fan

The cooling fan may operate when the main oven is on and may continue to operate for a period after the oven has been switched off.

USING THE MAIN OVEN

Fan oven

- (i) Turn the selector control knob to the fan oven symbol.
- (ii) Turn the temperature control knob to the required temperature.

The fan oven comes on when the oven is switched on and circulates the air around the oven to give a fairly even temperature throughout the oven.

Conventional oven

- (i) Turn the selector control knob to the conventional oven symbol.
- (ii) Turn the temperature control knob to the required temperature.

The temperature you select corresponds to the temperature in the middle of the oven.

The top heat comes from the outer element of the grill, and the base heat is under the oven base.

Top heat only

- (i) Turn the selector control knob to the top heat symbol.
- (ii) Turn the temperature control to the required temperature.

This setting can be used to brown the top of dishes such as cauliflower cheese or baked alaska etc.

Base heat only

- (i) Turn the selector control knob to the base heat symbol.
- (ii) Turn the temperature control knob to the required temperature.

This setting can be used to finish cooking pastry bases, pies or pizzas etc.

Fan and base heat only

- (i) Turn the selector control to the fan and base heat symbol.
- (ii) Turn the temperature control knob to the required temperature.

This setting can be used to finish items without a top crust - eg; jam tarts, open mince pies and flans.

Intensive bake (Pizza setting)



- (i) Turn the selector control to the intensive bake symbol.
- (ii) Turn the temperature control to the required temperature.

This setting is ideal for pizzas and also for items with a high moisture content - eg; fruit flans, quiches and cheese cake.

USING THE MAIN OVEN

Cooking with a fanned oven

As this is a high efficiency oven, you may notice the emission of steam from the oven when the door is opened. Please take care when opening the door.

If you have been used to cooking with a conventional oven, you will find a number of differences to cooking with a fanned oven, which will require a different approach:

There are no zones of heat in a fanned oven, the convection fan at the back of the oven ensures an even temperature throughout the oven. This makes it ideal for batch baking - eg; when planning a party or stocking the freezer, as all items will be cooked within the same length of time.

Foods are cooked at a lower temperature than a conventional oven, so conventional recipe temperatures may have to be reduced. Please refer to the conversion chart.

Pre-heating is generally not necessary as a fan oven warms up quickly.

There is no flavour transference in a fan oven, which means you can cook strong smelling foods such as fish at the same time as mild foods - eg; milk puddings.

When batch baking foods that will rise during cooking - eg; bread - always ensure that enough space has been left between shelves to allow for the rise.

Notes:

When 2 or more shelves are being used, it may be necessary to increase the cooking time slightly.

Because the 2 oven shelves are wider than in many ovens, it is possible to cook 2 items per shelf - eg; 2 victoria sandwiches or 2 casseroles. Although you need to keep in mind the point from the previous page 'To help the air circulate freely' with careful choice of dishes and tins, it is possible to cook a complete meal and perhaps something else for the freezer in the oven at the same time.

When roasting meats, you may notice that fat splashing is reduced, which is due in part to the lower oven temperatures, and will help keep cleaning of the oven to a minimum.

Because a fan oven has an even temperature throughout the oven, no shelf positions have been given in the following baking guide, and there is no need to interchange dishes onto different shelves part way through cooking, as with a conventional oven.

USING THE MAIN OVEN

To help the air circulate freely

- Position the shelves evenly within the oven and maintain a clearance from the oven roof and base.
- If more than one cooking dish or baking tray is to be used on a shelf, leave a gap of at least 25mm between the items themselves and the oven interior.
- Allow enough space between shelves for food that will rise during cooking.
- Do not place items on the oven base as this will prevent air from circulating freely.

Main oven baking guide

Cooking times

These times are based on cooking in a preheated oven.

The cooking times given are only approximate because the size and type of cooking dish will influence cooking time, as will personal preference.

Cooking temperatures

- The temperature settings and times given in the baking guide are based on dishes made with block margarine.
- If soft tub margarine is used it may be necessary to reduce the temperature setting.
- If a recipe gives a different temperature setting to that shown in the guide, the recipe instruction should be followed.

MAIN OVEN CONVERSION GUIDE

Note: this is a high efficiency oven, therefore some adjustment will have to be made to **conventional** cooking temperatures when using the fanned oven. The table below shows conventional cooking temperatures, fanned oven temperatures and gas marks. For optimum results, conventional temperatures need to be converted to fanned temperatures.

For example, an item which would normally cook at a conventional temperature of 180 °C, will now cook at the fanned temperature of 160°C.

Conventional temperature (°C)	Fanned Oven (°C)	Gas Mark
100	100	1/4
110	110	1/4
130	120	1/2
140	130	1
150	140	2
160	150	3
180-190	160	4-5
200	170	6
220	180	7
230	190	8
250	200	9

USING THE OVENS

Baking guide

Dish	Recommended temperature °C		Suggested shelf position (counted from bottom up)	Approximate cooking time (preheated oven)
	Fanned	Conventional		
Scones	180	220	3 & 5	8 - 15
Meringues	110	110	1	2 - 3 hrs
Cakes				
Small cakes	160	190	2 & 4	15 - 25 mins
Whisked sponge	160	190	3	15 - 20 mins
Swiss roll	170	200	3	10 - 12 mins
Victoria sandwich (2 x 180mm / 7")	160	180	3	20 - 30 mins
Genoise sponge	160	180	3	20 - 25 mins
Madeira (180mm / 7")	160	180	2	1 hr - 1¼ hrs
Semi rich fruit cake (205mm / 8")	130	150	2	2½ - 3hrs
Christmas cake (205mm / 8")	depending on recipe		2	depending on recipe
Dundee cake (205mm / 8")	130	150	2	2½ - 3hrs
Pastry				
Flaky / Puff	180	220	top - middle	depending on recipe and type of filling
Shortcrust	170	200	top - middle	
Choux	170	200	top - middle	
Plate tarts (2 x 180mm / 7")	170	200	top - middle	
Biscuits				
Shortbread rounds	160	190	top - middle	20 - 25 mins
Nut brownies	170	200	top - middle	20 - 25 mins
Brandy snaps	160	180	top - middle	10 - 12 mins
Flapjacks	160	180	top - middle	20 - 25 mins
Ginger nuts	160	180	top - middle	10 - 20 mins

USING THE MAIN OVEN

Cooling and defrosting in the main oven

To **cool** foods after cooking prior to refrigerating or freezing, turn the oven control to the defrost position, and **open** the door.

To **defrost** frozen foods, turn the oven control to the defrost position, place the food in the centre of the oven and **close** the door.

Defrosting times

Small or thin pieces of frozen fish or meat - eg; fish fillets, prawns, and mince will take approximately 1 - 2 hours. Placing the food in a single layer will reduce the thawing time.

A medium sized casserole or stew will take approximately 3 - 4 hours.

A 1½kg / 3lb oven ready chicken will take approximately 5 hours, remove the giblets as soon as possible.

Always check foods are thoroughly defrosted before cooking.

Be safe

- Do not defrost stuffed poultry using this method.
- Do not defrost larger joints of meat and poultry over 2kg / 4lb using this method.
- Never place uncooked food for defrosting next to cooked food which is to be cooled, as this can lead to cross contamination.

- Defrosting meat, poultry and fish can be accelerated using this method, but make sure they are completely thawed before cooking thoroughly.

Place meat and poultry on a trivet in a meat tin, to catch the juices from the defrosting process.

Slow cooking (Setting)

- Make sure that frozen foods are thoroughly THAWED before cooking.
- Do not slow cook joints of meat or poultry weighing more than 2½kg / 4½lb.
- Only use the fanned oven function for slow cooking.
- Preheat the oven to 170°C and cook for 30 minutes, then adjust the oven control to  (slow cook setting) for the remainder of the cooking time.
- Slow cooking times will be about 3 times as long as conventional cooking times.
- Do not open the oven door unnecessarily during slow cooking, as this will result in heat loss at low temperatures.
- Always use dishes with tightly fitting lids. To rectify badly fitting lids, place foil over the dish underneath the lid.

USING THE OVENS

Roasting guide

The times given in the roasting guide are only approximate, because the size and age of the bird will influence cooking times as will the shape of a joint and the proportion of the bone.

Frozen meat should be thoroughly thawed before cooking. For large joints it is advisable to thaw overnight.

Frozen poultry should be thoroughly thawed before cooking. The time required depends on the size of the bird - eg; a large turkey may take up to 48 hours to thaw.

Use of a trivet with a roasting tin will reduce fat splashing and will help to keep the oven interior clean. Alternatively, to help reduce fat splashing, potatoes or other vegetables can be roasted around the meat / poultry.

Notes:

- When cooking stuffed meat or poultry calculate the cooking time from the total weight of the meat plus the stuffing.
- For joints cooked in foil or covered roasters, and for lidded casseroles, add 5 minutes per 450g (1lb) to the calculated cooking time.
- Smaller joints weighing less than 1.25kg (2½lb) may require 5 minutes per 450g (1lb) extra cooking time.
- Position the oven shelf so that the meat or poultry is positioned in the centre of the oven.
- It is recommended that the appliance is cleaned after open roasting.

Cook in oven at: 160 - 180°C Main Oven Fanned 180 - 200°C - Top Oven Conventional 180 - 200°C - Main Oven Conventional		Approximate Cooking Time (preheated oven) (preheated oven)
Beef	Rare Medium Well done	20 minutes per 450g (1lb), plus 20 minutes 25 minutes per 450g (1lb), plus 20 minutes 30 minutes per 450g (1lb), plus 30 minutes
Lamb	Medium Well done	25 minutes per 450g (1lb), plus 25 minutes 30 minutes per 450g (1lb), plus 30 minutes
Pork		35 minutes per 450g (1lb), plus 35 minutes
Poultry		20 minutes per 450g (1lb), plus 20 minutes

USING THE OVENS

Traditional fruit cakes

It should be remembered that ovens can vary over time, therefore cooking times can vary, making it difficult to be precise when baking fruit cakes.

It is necessary therefore, to test the cake before removal from the oven. Use a fine warmed skewer inserted into the centre of the cake. If the skewer comes out clean, then the cake is cooked.

- Follow the temperatures recommended in the recipe and then adjust according to the conversion guide on page 14.
- Do not attempt to make Christmas cakes larger than the oven can cope with, you should allow at least 25mm (1 inch) space between the oven walls and the tin.
- To protect a very rich fruit cake during cooking, tie 2 layers of brown paper around the tin.
- We recommend that the cake tin is not stood on layers of brown paper, as this can hinder effective circulation of air.
- Do not use soft tub margarine for rich fruit cakes, unless specified in the recipe.
- Always use the correct size and shape of tin for the recipe quantities.

Roast turkey

Roasting turkey perfectly can prove difficult, as you are cooking two different types of meat - the delicate light breast meat, which must not be allowed to dry out, and the darker leg meat, which takes longer to cook.

The turkey must be roasted long enough for the legs to cook, so frequent basting is necessary. The breast meat can be covered once browned.

- Turkey should be roasted at 180°C (conventional) 160°C (fanned) for 20 minutes per 1lb, plus 20 minutes, unless packaging advises otherwise.
- The turkey can be open roasted, breast side down, for half of the cook time, and then turned over for the remainder of the cooking time.
- If the turkey is stuffed, add 5 minutes per 1lb to cook time.
- If roasting turkey covered with foil, add 5 minutes per 1lb to cook time.

To test if the turkey is cooked, push a fine skewer into the thickest part of the thigh. If the juices run clear, the turkey is cooked. If the juices are still pink, the turkey will need longer cooking.

USING THE OVENS

Automatic cooking

The automatic cooking facility is controlled by the programmer (see 'Programmer / Clock' section) and allows complete meals or individual dishes to be cooked while you are out of the house, to be ready for when you return. The 'READY TIME' should be set as close as possible to, or just after, your anticipated return, so food is not left standing in a warm oven.

Do

- Select foods which are as fresh as possible, and as cold as possible - ie; preferably straight from the refrigerator.
- Choose foods which are suitable for cooking from a cold start, as some dishes will be affected by being left uncooked, at room temperature, perhaps for several hours - eg; a wet filling on a pastry base.
- Make sure that meat and poultry are thoroughly thawed (but still cold from the refrigerator) before placing them in the oven, and avoid using rolled joints of meat, which can be more susceptible to the growth of food poisoning organisms.
- Cover dishes with lids or foil to keep the food moist, and protect from possible contamination; the food can be uncovered towards the end of cooking to crisp and brown.

Do not

- Warm food should never be placed in the oven if there is a delay period.
- Stews prepared by frying the meat and vegetables first should be cooked as soon as possible, or refrigerated prior to placing in the oven.
- Some dishes are not suitable for cooking on automatic - eg; dishes containing left over meat or poultry, dishes containing eggs, cooked rice, or seafood.
- Do not put food items (intended for automatic cooking) into a warm oven; allow the oven to cool before setting for automatic cooking.
- Do not over fill dishes containing liquids, as they might boil over.
- Never leave food in the oven to cool slowly after cooking; serve immediately or refrigerate.
- Never use the automatic facility to reheat 'cook chill' foods, as they should go straight from the refrigerator into a preheated oven.

USING THE OVENS

Important:

Food is more susceptible to the growth of food poisoning organisms in warm conditions. If the weather is hot, either take care to ensure that food is not left standing in a warm oven, or avoid using the automatic cooking facility.

Hints for automatic cooking

- Food is placed in a cold oven so you will need to add about 10 - 15 minutes onto the cooking time to allow for the oven to reach the selected temperature.
- Wine or beer may ferment, and cream may curdle during the delay period, so it is best to add these ingredients just before serving.
- Potatoes should be parboiled or brushed with oil to prevent discolouration during the delay period.
- Meat can be brushed with oil to prevent it drying.
- Lemon juice can be added to certain fruits and vegetables such as apples, pears, turnips and parsnips to prevent discolouration during the delay period.

PROGRAMMER / CLOCK

Automatic cooking is only available in the main oven.

The programmer buttons

∇ down - reduce

▲ up - increase

The 'function' button in the centre is used for setting the minute minder and setting up the automatic cooking. See below for details.

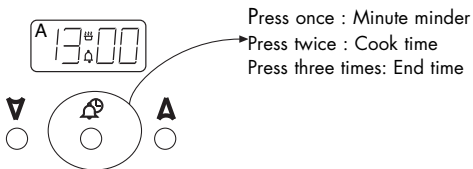

Symbols on the LED display.

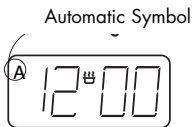

This 'A' symbol appears when either a semi, or fully automatic program is selected. This symbol will flash while a program is being set. Once a program is set the symbol will light up, and remain lit until the alarm sounds, or the program is cancelled

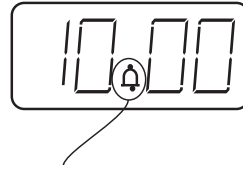

Minute Minder Symbol

This Bell symbol appears when the Minute Minder function has been selected. While the Minute Minder is being set, the Bell symbol flashes. Once the length of time is set, the Bell symbol remains lit until the time runs down, or the function is cancelled.



This message and 'A' symbol appear when you are asked to set the length of time you require the oven to cook automatically for. Using the Up and Down buttons adjusts this accordingly.



This message and 'A' symbol appear when you are asked to enter in an end time, or when you would like the oven to switch itself off.

PROGRAMMER / CLOCK

To set the time of day

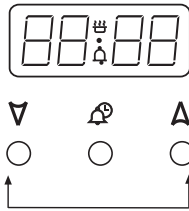

- ◆ Press the Up and Down buttons together for a few seconds, and release.
- ◆ The '●' in between the numbers on the LED Display will begin to flash.
- ◆ While the '●' is flashing it is possible to adjust the time using the Up and Down buttons. Once the time has been set, allow approximately 30 seconds before using any of the other timer functions. This ensures that the time will remain correct.

To select an alarm tone

There are three tones to chose from.

- ◆ Press and hold the *down* button to listen to the first tone.
- ◆ Release the *down* button and press it again to listen to the second tone etc.
- ◆ Releasing the *down* button after the tone has sounded will automatically select that tone

Setting the minute minder

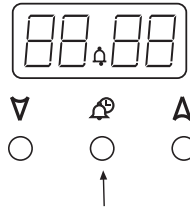

- ◆ To set the Minute Minder, press the Function button once. The bell symbol will appear and start flashing. The flashing only lasts for 5 seconds so the time must be set within this time frame.
- ◆ Use the Up and Down button to set the length of time required. Once this has been done, the Minute Minder is set.
- ◆ When the desired length of time has counted down the alarm will sound.
- ◆ To cancel the tone, press any of the buttons.
- ◆ To cancel the Minute Minder at any time, press the Up and Down buttons together.

PROGRAMMER / CLOCK

Semi-automatic cooking

There are two types of semi automatic cooking available on this appliance.

The oven must be switched on, and in use to use either of these functions successfully.

The Duration method allows you to set the oven for a specific length of time. If a dish needed 2 hours to cook, then it would be possible for you to set the oven to turn off 2 hours later. This allows you to be sure that your food will be cooked for a set length of time and no longer.

The End Time method allows you to enter a specific time when you would like the oven to switch off. If you wish to leave the oven unattended, then it offers peace of mind that the oven will have turned itself off at the set time.

However, once the program is set then it cannot be adjusted. Extra time cannot be added, nor can the end time be extended.

To cancel the semi automatic programs, press both the Plus and Minus buttons together. This can be done at any time during the cooking process. Then if necessary, re program.

For the instructions on how to use both of these functions, please see the following page.

Fully automatic cooking

This function incorporates both a duration and an end time and is meant to be used when you wish to delay the start time.

We recommend that the first few times this function is used you are in the house, this will familiarise you with your oven and prevents food from being over cooked or under cooked.

Care must be taken when selecting foods for this function, it is not recommended for certain food items which may spoil, or are sensitive to being left.

It is also advisable to set the end time to be as close to your return as possible to prevent food being left standing.

PROGRAMMER / CLOCK

Semi-automatic cooking

The Duration method

- ◆ Press the Function button twice, **(1)** which will skip past the Minute Minder.
- ◆ The LED display will flash the word 'dur', **(2)** and the 'A' will flash on the left hand side of the display.
- ◆ Use the Plus and Minus buttons to set the length of time you want to cook for. **(3)** This must be done within 5 seconds or the time of day will show again.

Once this is done the oven will automatically switch off once the time has elapsed, and the alarm will sound. To switch off the alarm, press any button. To view any remaining time press the function button twice

The End Time method

- ◆ Press the Function button three times, which will skip past the Minute Minder and the Duration programmer. **(4)**
- ◆ The LED display will flash the word 'End' and the 'A' will flash on the left hand side of the display. **(5)**
- ◆ Use the Plus and Minus buttons to select the time the oven is required to turn off. **(6)**

Once this is done the oven will turn itself off at the time you have selected. To switch off the alarm, press any button.

1. The Duration method

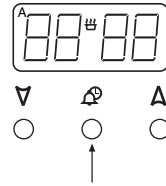

2.



3.

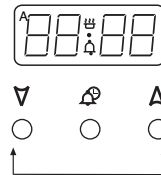

4. The End Time method

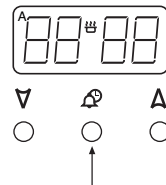

5.



6.

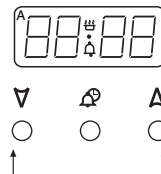

PROGRAMMER / CLOCK

Fully automatic cooking (example)

This programming method is best suited for when a delayed start time is required. Unlike the semi automatic methods this requires both the duration and the end time to be entered. The timer will work out the start time and begin cooking.

◆ Press the function button twice to select the length of time your food will need. **(7)**

◆ The 'A' on the left hand side will flash and the 'dur' message will flash up. **(8)**

◆ Using the Plus and Minus buttons set the time you require within 5 seconds of the 'dur' message. **(9)**

◆ Press the function button three times until the 'A' flashes again and the 'End' messages appears. **(10) & (11)**

◆ Using the Plus and Minus buttons, set the time you would like the oven to switch off. **(12)**

◆ Set the temperature of the oven and place the food inside.

While the automatic function is running, the 'A' will appear statically on the display, with the time.

Try to keep the end time as close to when you expect to return, this will prevent cooked food from being left standing in a warm oven.

The timer will calculate the appropriate start time.

To switch off the alarm, press any button

7

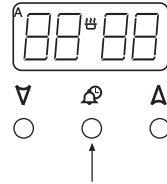

8



9

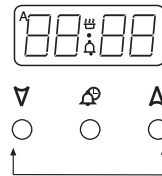

10

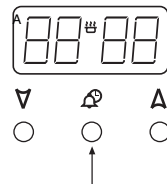

11



12

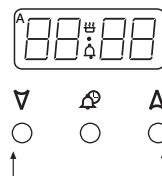

CARE & CLEANING

Caution: Any cleaning agent used incorrectly may damage the appliance.

Always let the appliance cool before cleaning.

Do not use a steam cleaner on this appliance.

Some cooking operations generate considerable amount of grease, this combined with spillage can become a hazard if allowed to accumulate on the appliance through lack of cleaning. In extreme cases this may amount to misuse of the appliance and could invalidate your guarantee.

It is recommended that the appliance is cleaned after open roasting.

Do not use caustic, corrosive or abrasive cleaning products, products containing bleach, coarse wire wool or any hard implements, as they will damage the surfaces.

All parts of the appliance can be safely cleaned with a cloth wrung out in hot soapy water.

Vitreous enamel parts

GRILL PAN, TOP OVEN / GRILL COMPARTMENT,
MAIN OVEN COMPARTMENT

Use a mild cream cleaner - eg; "Cif".

Look for one which has the Vitreous Enamel Development Council's recommendation seal.

Stubborn marks may be removed with a moistened "Brillo" pad.

The grill pan may be cleaned in a

dishwasher, or with a nylon brush in hot soapy water.

CARE & CLEANING

Glass parts

FACIA PANEL, DOOR PANELS

Use a mild cream cleaner - eg; "Cif". Rinse thoroughly and dry with a soft cloth.

Important: The inner door glass panel(s) can be removed for cleaning, but they must be replaced the right way (so the reflective side faces inwards) and also pushed fully in to the stop position. To remove the glass panel, open the door wide, hold the edges of the glass and slide out.

Painted, plastic and metal finish parts (if fitted)

CONTROL KNOBS, DOOR HANDLES

Only use a clean cloth wrung out in hot soapy water.

Chrome plated parts

OVEN SHELVES & OVEN SHELF RUNNERS, GRILL PAN TRIVET

Do not use abrasives or polishes, use a moist soap pad - eg; "Brillo".

Note: Oven shelf runners can be removed for cleaning. Grasp the runners, and slide out of the hanging holes as shown.

Note: These items may also be cleaned in a dishwasher.

Stainless Steel surfaces (stainless steel finish models only)

HANDLES, DOOR PANELS

Only use a clean cloth wrung out in hot soapy water, and dry with a soft cloth.

Do not use undiluted bleach or any products containing chlorides as they can permanently damage the steel.

Extra care should be taken when cooking food in salted water. Some foods are corrosive - eg; vinegar, fruit juices and especially **salt** - they can mark or damage stainless steel if they are left on the surface. Turn off and wipe any spillage immediately, taking care to avoid skin contact with any hot surface or spillage.

Sharp objects can mark the surface of stainless steel, but marks will become less noticeable with time.

To maintain the finish of the stainless steel, or to remove any greasy marks, wipe the stainless steel surface sparingly with a *minimum* amount of Baby Oil and kitchen paper.

Do not use cooking oils, as these may contain salt, which can damage the stainless steel surface.

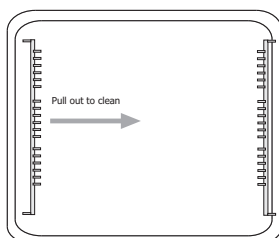

CARE & CLEANING

Cleaning the hob

Ceramic glass surface

Do not use abrasive powder cleaners, "Brillo" pads, metal wire, detergents, bleaches, bath stain removers, or chemical oven cleaners; all these product types will damage the ceramic glass.

The following recommendations will help to keep the ceramic glass surface bright and clean.

Allow the hob to cool.

Use a dampened paper towel or clean damp cloth to apply a small dab of cleaner conditioner to clean each heating area.

Use another paper towel or a clean dry soft cloth to wipe dry, and then polish the whole glass surface.

To remove any stubborn marks or heavy soiling, a non scratching, mild cream cleaner may be used - eg; "Cif".

Important: If you use a wet paper towel or clean damp cloth to remove spillage from a warm heating area of the hob, be careful to avoid steam burns.

Care and maintenance

Before using the hob for the first time, apply a thin coating of cleaner conditioner (eg; "Hob Brite", by Homecare*) to the ceramic glass only, and polish the surface with a clean cloth.

The conditioner gives a protective covering to the ceramic glass which not only makes the hob easier to clean, but also ensures that you will

gain maximum life out of this product. Occasional use will help prevent the build up of mineral deposits which can cause discolouration of the hob surface.

Discolouration of the hob

Do not use a dishcloth or dish sponge to wipe the hob - this can leave a film of detergent on the surface which will discolour the hob next time a heating area is used. Clean cloths kept for the cleaning of the hob can be used.

Do not use too much cleaner conditioner - only a thin coating is required, any excess may burn on and discolour the hob when it is next in use.

If persistent stains or marks remain on the ceramic glass surface, it can be cleaned using a mild cream cleaner - eg; "Cif", or a ceramic hob scraper. This will also remove any accumulated salts or minerals before they have an opportunity to discolour the ceramic glass.

Wipe clean with a damp paper towel or clean damp cloth and re-apply cleaner conditioner.

INSTALLATION INSTRUCTIONS

Whilst every care is taken to eliminate burrs and raw edges from this product, please take care when handling - we recommend the use of protective gloves during installation.

Moving the cooker

Please note that the weight of this appliance is approximately **60kg** (unpacked). Take care if the appliance needs to be lifted during installation - always use an appropriate method of lifting.

Do not attempt to move the cooker by pulling on the doors or handles. Open the door and grasp the frame of the cooker, taking care that the door does not shut on your fingers.

Take care to avoid damage to soft or uneven floor coverings when moving the appliance. Some cushioned vinyl floor coverings may not be designed to withstand sliding appliances without marking or damage.

Important: Ensure that you route all mains cables well clear of any adjacent heat source.

Clearances

This cooker may be fitted flush to base units. However, for models with side opening doors, we recommend a side clearance of 60mm between the cooker and any side wall to allow the door to be opened fully.

The cooker should not be placed on a base.

No shelf or overhang or cooker hood shall be closer than a minimum of 650mm, but check with cooker hood manufacturer's recommendations.

The cooker must have a side clearance above hob level of 90mm up to a height of 400mm.

Dimensions

All sizes are nominal, and some variation is to be expected. The 'depth' of the cooker, as given below, is to the front of the door and excluding knobs and handles.

Width: 600mm

Depth: 600mm

Height (adjustable): 900 - 930mm

Levelling the cooker

Turn the feet by hand to adjust the height of the cooker.

INSTALLATION INSTRUCTIONS

Connect to the electricity supply

Warning: This appliance must be earthed.

The appliance must be installed by a competent electrician using a double pole control unit of 32 ampere minimum capacity with 3mm minimum contact separation at all poles.

We recommend that the appliance is connected by a qualified electrician who is a member of the N.I.C.E.I.C. and who will comply with the I.E.E. and local regulation.

1. Access to the mains terminal is gained by opening the terminal block cover at the rear of the appliance (use a small flat-bladed screwdriver).
2. Connection should be made with 6.0mm² flexible twin and earth cable.
3. First strip the wires, then push the cable through the cable clamp in the terminal block cover.
4. Connect the cable to the terminal block using an 8mm socket and tighten the cable clamp screw (see diagram).
5. Close the terminal box, ensuring that the cover is engaged on the locking tabs.

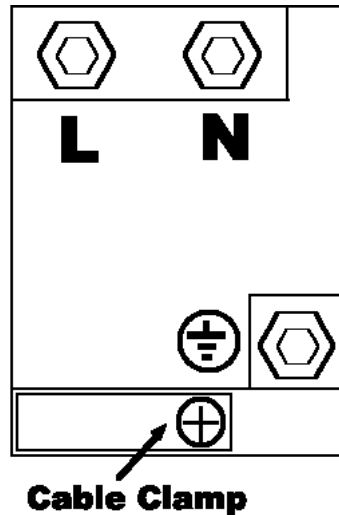

TECHNICAL DATA

Electrical supply/Load

220 - 240V ~ 50Hz

10466 - 12455 W

Warning: This appliance must be earthed.

Dimensions

All sizes are nominal so some variation is to be expected.

Height (adjustable) 895 - 930mm

Width 600mm

Depth (not including handle) 600mm

Databadge is located at the bottom of the front frame, behind the door.

Countries of destination

GB - Great Britain, IE - Ireland

Belling Customer Care

Please keep this handbook in a safe place as the information inside may be of use should you sell, or pass on the appliance. Please fill in the model number and serial number in the spaces provided below as they will assist us should you need to call.

0844 815 3746

When you dial this number you will hear a recorded message and be given a number of options. This indicates that your call has been accepted and is being held in a queue. Calls are answered in strict rotation as our Customer Care Representatives become available.

Enter appliance numbers here for future reference:

Model No									
4	4	4							
Serial No									

These numbers can be found on your appliances data badge.
Outside the UK and Northern Ireland, refer to your local supplier.

Stoney Lane, Prescot, Merseyside. L35 2XW.

Free Manuals Download Website

<http://myh66.com>

<http://usermanuals.us>

<http://www.somanuals.com>

<http://www.4manuals.cc>

<http://www.manual-lib.com>

<http://www.404manual.com>

<http://www.luxmanual.com>

<http://aubethermostatmanual.com>

Golf course search by state

<http://golfingnear.com>

Email search by domain

<http://emailbydomain.com>

Auto manuals search

<http://auto.somanuals.com>

TV manuals search

<http://tv.somanuals.com>