

GA-K8VM800M

AMD Socket 754 Processor Motherboard

User's Manual

Rev. 1001

12ME-K8VM800M-1001

Copyright

© 2004 GIGABYTE TECHNOLOGY CO., LTD

Copyright by GIGA-BYTE TECHNOLOGY CO., LTD. ("GBT"). No part of this manual may be reproduced or transmitted in any form without the expressed, written permission of GBT.

Trademarks

Third-party brands and names are the property of their respective owners.

Notice

Please do not remove any labels on motherboard, this may void the warranty of this motherboard.

Due to rapid change in technology, some of the specifications might be out of date before publication of this booklet.

The author assumes no responsibility for any errors or omissions that may appear in this document nor does the author make a commitment to update the information contained herein.

Declaration of Conformity

We, Manufacturer/Importer
(full address)

G.B.T. Technology Trading GmbH
Ausschläger Weg 41, 1F 20537 Hamburg, Germany

declare that the product
(description of the apparatus, system, installation to which it refers)

Mother Board
GA-K8VM800M

is in conformity with
(reference to the specification under which conformity is declared)
in accordance with 89/336 EEC-EMC Directive

- | | | | |
|---|--|---|---|
| <input type="checkbox"/> EN 55011 | Limits and methods of measurement of radio disturbance characteristics of industrial, scientific and medical (ISM) high frequency equipment | <input checked="" type="checkbox"/> EN 61000-3-2 | Disturbances in supply systems caused |
| <input type="checkbox"/> EN 55013 | Limits and methods of measurement of radio disturbance characteristics of broadcast receivers and associated equipment | <input checked="" type="checkbox"/> EN 61000-3-3 | Disturbances in supply systems caused by household appliances and similar electrical equipment "Voltage fluctuations" |
| <input type="checkbox"/> EN 55014-1 | Limits and methods of measurement of radio disturbance characteristics of household electrical appliances, portable tools and similar electrical apparatus | <input checked="" type="checkbox"/> EN 55024 | Information Technology equipment-Immunity characteristics Limits and methods of measurement |
| <input type="checkbox"/> EN 55015 | Limits and methods of measurement of radio disturbance characteristics of fluorescent lamps and luminaires | <input type="checkbox"/> EN 50082-1 | Generic immunity standard Part 1: Residential, commercial and light industry |
| <input type="checkbox"/> EN 55020 | Immunity from radio interference of broadcast receivers and associated equipment | <input type="checkbox"/> EN 50082-2 | Generic immunity standard Part 2: Industrial environment; |
| <input checked="" type="checkbox"/> EN 55022 | Limits and methods of measurement of radio disturbance characteristics of information technology equipment | <input type="checkbox"/> EN 55014-2 | Immunity requirements for household appliances tools and similar apparatus |
| <input type="checkbox"/> DIN VDE 0855 | Cabled distribution systems. Equipment for receiving and/or distribution from sound and television signals | <input type="checkbox"/> EN 50091-2 | EMC requirements for uninterruptible power systems (UPS) |
| <input type="checkbox"/> part 10 | | | |
| <input type="checkbox"/> part 12 | | | |

CE marking



(EC conformity marking)

The manufacturer also declares the conformity of above mentioned product with the actual required safety standards in accordance with LVD 73/23 EEC

- | | | | |
|--|---|--|---|
| <input type="checkbox"/> EN 60065 | Safety requirements for mains operated electronic and related apparatus for household and similar general use | <input type="checkbox"/> EN 60950 | Safety for information technology equipment including electrical business equipment |
| <input type="checkbox"/> EN 60335 | Safety of household and similar electrical appliances | <input type="checkbox"/> EN 50091-1 | General and Safety requirements for uninterruptible power systems (UPS) |

Manufacturer/Importer

Signature: Timmy Huang

(Stamp)

Date Apr. 14, 2004

Name: Timmy Huang

DECLARATION OF CONFORMITY

Per FCC Part 2 Section 2.1077(a)



Responsible Party Name: G.B.T. INC. (U.S.A.)

**Address: 17358 Railroad Street
City of Industry, CA 91748**

Phone/Fax No: (818) 854-9338/ (818) 854-9339

hereby declares that the product

Product Name: Motherboard

Model Number: GA-K8VM800M

Conforms to the following specifications:

FCC Part 15, Subpart B, Section 15.107(a) and Section 15.109
(a), Class B Digital Device

Supplementary Information:

This device complies with part 15 of the FCC Rules. Operation is subject to the following two conditions: (1) This device may not cause harmful and (2) this device must accept any interference received, including that may cause undesired operation.

Representative Person's Name: ERIC LU

Signature: Eric Lu

Date: Apr. 14, 2004



Read Me First!

When you installing AGP card, please make sure the following notice is fully understood and practiced. If your AGP card has "AGP 4X/8X (1.5V) notch" (show below), please make sure your AGP card is AGP 4X/8X.



Caution: AGP 2X card is not supported by VIA K8M800. You might experience system unable to boot up normally. Please insert an AGP 4X/8X card.

WARNING: Never run the processor without the heatsink properly and firmly attached. PERMANENT DAMAGE WILL RESULT!

Mise en garde : Ne faites jamais tourner le processeur sans que le dissipateur de chaleur soit fixé correctement et fermement. UN DOMMAGE PERMANENT EN RÉSULTERA !

Achtung: Der Prozessor darf nur in Betrieb genommen werden, wenn der Wärmeleiter ordnungsgemäß und fest angebracht ist. DIES HAT EINEN PERMANENTEN SCHADEN ZUR FOLGE!

Advertencia: Nunca haga funcionar el procesador sin el dissipador de calor instalado correcta y firmemente. ¡SE PRODUCIRÁ UN DAÑO PERMANENTE!

Aviso: Nunca execute o processador sem o dissipador de calor estar adequado e firmemente conectado. O RESULTADO SERÁ UM DANO PERMANENTE!

警告: 將散熱板牢固地安裝到處理器上之前，不要運行處理器。過熱將永遠損壞處理器！

警告: 將散熱器牢固地安裝到處理器上之前，不要運行處理器。過熱將永遠損壞處理器！

경고: 히트싱크를 제대로 또 단단히 부착시키지 않은 채 프로세서를 구동시키지 마십시오. 영구적 고장이 발생합니다!

警告: 永久的な損傷を防ぐため、ヒートシンクを正しくしっかりと取り付けるまでは、プロセッサを動作させないようにしてください。

Prepare your computer...

Computer motherboards and expansion cards contain very delicate Integrated Circuit (IC) chips. To protect them against damage from static electricity, you should follow some precautions whenever you work on your computer.

1. Unplug your computer when working on the inside.
2. Use a grounded wrist strap before handling computer components. If you do not have one, touch both of your hands to a safely grounded object or to a metal object, such as the power supply case.
3. Hold components by the edges and try not touch the IC chips, leads or connectors, or other components.
4. Place components on a grounded antistatic pad or on the bag that came with the components whenever the components are separated from the system.
5. Ensure that the ATX power supply is switched off before you plug in or remove the ATX power connector on the motherboard.

Installing the motherboard to the chassis...

If the motherboard has mounting holes, but they don't line up with the holes on the base and there are no slots to attach the spacers, do not become alarmed you can still attach the spacers to the mounting holes. Just cut the bottom portion of the spacers (the spacer may be a little hard to cut off, so be careful of your hands). In this way you can still attach the motherboard to the base without worrying about short circuits. Sometimes you may need to use the plastic springs to isolate the screw from the motherboard PCB surface, because the circuit wire may be near by the hole. Be careful, don't let the screw contact any printed circuit write or parts on the PCB that are near the fixing hole, otherwise it may damage the board or cause board malfunctioning.

Table of Content

Read Me First!	4
Chapter 1 Introduction	8
Features Summary	8
GA-K8VM800M Motherboard Layout	11
Block Diagram	12
Chapter 2 Hardware Installation Process	13
Step 1: Install the Central Processing Unit (CPU)	14
Step 2: Install Memory Modules	16
Step 3: Install expansion cards	17
Step 4: Connect ribbon cables, cabinet wires and power supply	18
Step 4-1: I/O Back Panel Introduction	18
Step 4-2: Connectors Introduction	20
Chapter 3 BIOS Setup	35
The Main Menu (For example: BIOS Ver. : D8)	36
Standard CMOS Features	38
Advanced BIOS Features	40
Integrated Peripherals	41
Power Management Setup	44
PnP/PCI Configurations	45
PC Health Status	46
Frequency/Voltage Control	47
Load Fail-Safe Defaults	48
Load Optimized Defaults	48

Set Supervisor/User Password	49
Save & Exit Setup	50
Exit Without Saving	50
Chapter 4 Technical Reference	53
@BIOS™ Introduction	53
Flash BIOS Method Introduction	54
2-/4-/6-Channel Audio Function Introduction	58
Jack-Sensing Introduction	64
Xpress Recovery Introduction	66
Serial ATA RAID BIOS Utility Introduction	71
Chapter 5 Appendix	79

Chapter 1 Introduction

Features Summary

CPU	<ul style="list-style-type: none"> • Socket 754 for AMD Athlon™ 64 processor (K8) 128K L1& 256K / 512K / 1M L2 cache on die , 800MHz FSB • Support core frequencies in excess of 1.6 GHz(2800+) and faster
Chipset	<ul style="list-style-type: none"> • Northbridge:VIA K8M800 • Southbridge:VIA VT8237
Memory	<ul style="list-style-type: none"> • 2 184-pin DDR DIMM sockets, supports up to 2GB DRAM (Max) • Supports DDR400/333/266/200 DIMM • Supports 128MB/256MB/512MB/1GB unbuffered DRAM • Supports only 2.5V DDR DIMM
Slots	<ul style="list-style-type: none"> • 1 AGP slot supports 8X/4X(1.5V) mode • 3 PCI slots
On-Board IDE	<ul style="list-style-type: none"> • 2 IDE bus master (UDMA33/ATA66/ATA100/ATA133) IDE ports for up to 4 ATAPI devices
On-Board Floppy	<ul style="list-style-type: none"> • 1 Floppy port supports 2 FDD
On-Board Serial ATA	<ul style="list-style-type: none"> • 2 Serial ATA connectors
On-Board Peripherals	<ul style="list-style-type: none"> • 1 Parallel port • 1 Serial port (COMA), 1 VGA port, COMB on board • 8 USB 2.0/1.1 ports (4 x Rear, 4 xFront by cable) • 1 Front Audio connector • 1 IrDA connector for IR • 1 PS/2 keyboard • 1 PS/2 mouse
On-Board VGA	<ul style="list-style-type: none"> • Build in VIA K8M800 Chipset
On-Board LAN	<ul style="list-style-type: none"> • Built-in RTL8100C (10/100 Mbit) • 1 RJ45 port
On-Board Sound	<ul style="list-style-type: none"> • ALC655 CODEC • Supports Jack Sensing function • Support 2 / 4 / 6 channel • Line In / Line Out / Mic In • SPDIF In / Out • CD In / Game connector
On-Board SATA RAID	<ul style="list-style-type: none"> • Built-in VIA VT8237 • Supports disk striping (RAID 0) or disk mirroring (RAID 1) • Supports UDMA up to 150 MB/sec • Up to 2 SATA devices
I/O Control	<ul style="list-style-type: none"> • IT8705F

to be continued...

Hardware Monitor	<ul style="list-style-type: none">• CPU/System fan revolution detect• CPU temperature detect• System voltage detect• CPU/System fan fail warning
BIOS	<ul style="list-style-type: none">• Licensed AWARD BIOS• Supports Q-Flash
Additional Features	<ul style="list-style-type: none">• Supports Thermal Shutdown function• Supports @BIOS• Supports EasyTune
Overclocking	<ul style="list-style-type: none">• Over Clock (CPU/DDR/AGP/PCI) by BIOS
Form Factor	<ul style="list-style-type: none">• Micro ATX size form factor 24.4cm x 24.4cm

GA-K8VM800M Motherboard Layout

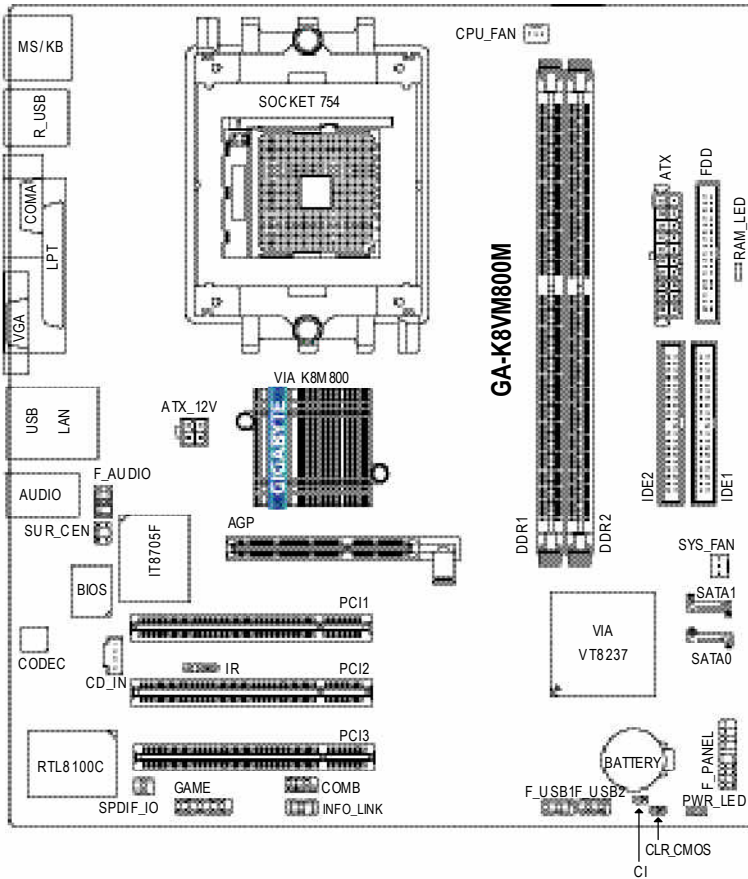

Block Diagram

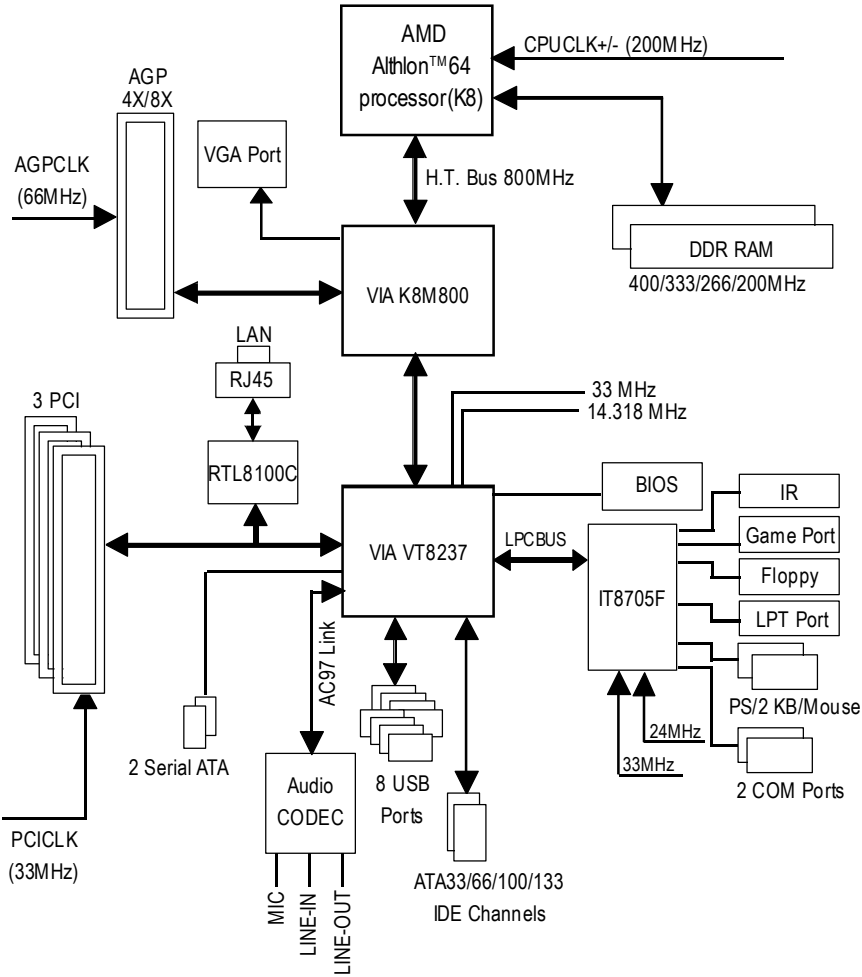

Chapter 2 Hardware Installation Process

To set up your computer, you must complete the following steps:

- Step 1 - Install the Central Processing Unit (CPU)
- Step 2 - Install memory modules
- Step 3 - Install expansion cards
- Step 4 - Install I/O Peripherals Cables

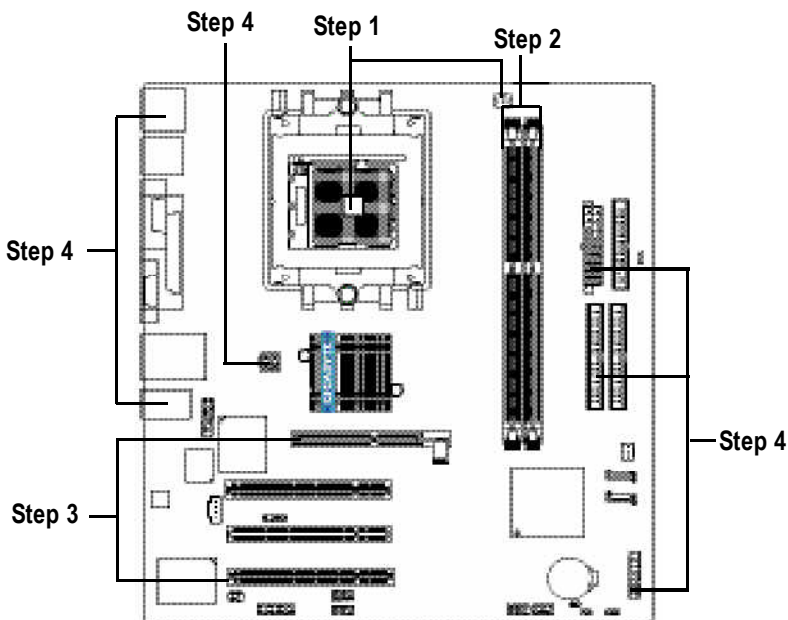

Congratulations! You have accomplished the hardware installation!

Turn on the power supply or connect the power cable to the power outlet. Continue with the BIOS/software installation.

Step 1: Install the Central Processing Unit (CPU)

Before installing the processor and cooling fan, adhere to the following warning:



1. Please make sure the CPU type is supported by the motherboard.
2. The processor will overheat without the heatsink and/or fan, resulting in permanent irreparable damage.
3. If you do not match the CPU socket Pin 1 and CPU cut edge well, it will cause improper installation. Please change the insert orientation.
4. Apply thermal grease between the processor and cooling fan.
5. Never run the processor without the heatsink properly and firmly attached. Permanent damage will result.
6. Please set the CPU host frequency in accordance with your processor's specifications. We don't recommend you to set the system bus frequency over the CPU's specification because these specific bus frequencies are not the standard specifications for CPU, chipset and most of the peripherals. Whether your system can run under these specific bus frequencies properly will depend on your hardware configurations, including CPU, Memory, Cards...etc.

The installation of the processor and cooling fan is performed in four main steps:

Step1-1. First, check the processor pins to see that none are bent. Move the socket lever to the unlocked position as shown in Figure 1. (90° to the plane of the motherboard) prior to inserting the processor. The pin 1 location is designated on the processor by a copper triangle that matches up to a triangle on the socket as shown in Figure 2. Align the processor to the socket and gently lower it into place. Do not force the processor into the socket.

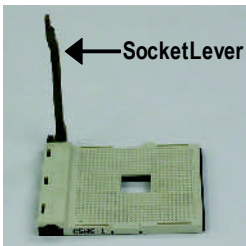

Figure 1.
Pull the lever to the 90-degree directly.



Figure 2.
Pin 1 location on the Socket and Processor. Move the socket lever to the locked position while holding pressure on the center of the processor.

Step1-2. When the processor is installed in the socket, apply thermal grease to the processor(as shown in Figure 3) prior to installing the heatsink. Phase change materials develop strong adhesive forces between the heatsink and processor. **Removing the heatsink under such conditions can cause the processor to be removed from the socket without moving the socket lever to the unlocked position and then damage the processor pins or socket contacts.**

** We recommend you to apply the thermal tape to provide better heat conduction between your CPU and heatsink. (The CPU cooling fan might stick to the CPU due to the hardening of the thermal paste. During this condition if you try to remove the cooling fan, you might pull the processor out of the CPU socket along with the cooling fan, and might damage the processor. To avoid this from happening, we suggest you to either use thermal tape instead of thermal paste, or remove the cooling fan with extreme caution.)

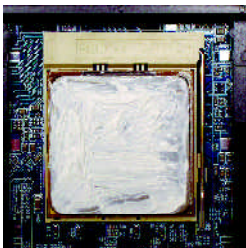

Figure 3.
Application of thermal grease to the processor.

Step 1-3. Once the thermal grease has been applied to the processor, the heatsink can be attached to the processor. Align the heatsink assembly with the support frame mating with the backer plate standoffs as shown in Figure 4 & 5.

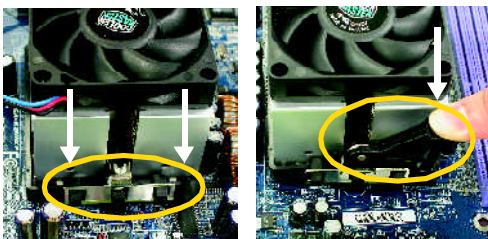

Figure 4 & 5.
Alignment of heatsink assembly with standoffs.

Step 1-4. Connect the fan power wires to the header on the motherboard as shown in Figure 6.

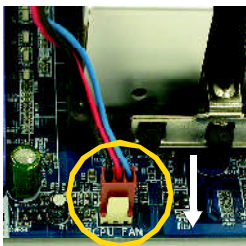

Figure 6.
Connecting the fan power wires.

Step 2: Install Memory Modules



Before installing the memory modules, adhere to the following warning:

1. When RAM_LED is ON, do not install / remove DIMM from socket.
2. Please note that the DIMM module can only fit in one direction due to the one notch. Wrong orientation will cause improper installation. Please change the insert orientation.

The motherboard has 2 dual inline memory module (DIMM) sockets. The BIOS will automatically detects memory type and size. To install the memory module, just push it vertically into the DIMM socket. The DIMM module can only fit in one direction due to the notch. Memory size can vary between sockets.

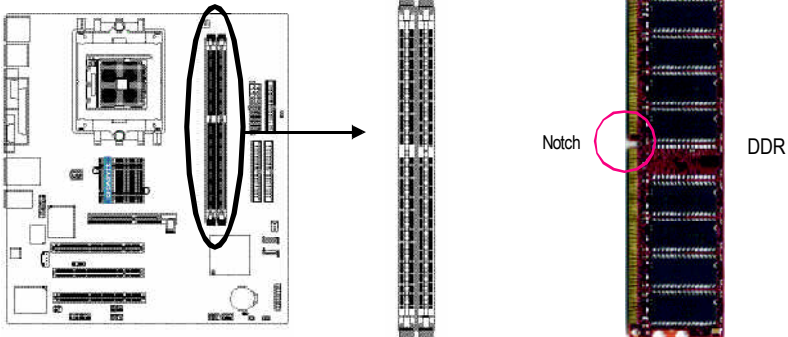

1. The DIMM socket has a notch, so the DIMM memory module can only fit in one direction.



2. Insert the DIMM memory module vertically into the DIMM socket. Then push it down.



3. Close the plastic clip at both edges of the DIMM sockets to lock the DIMM module. Reverse the installation steps when you wish to remove the DIMM module.

Step 3: Install expansion cards

1. Read the related expansion card's instruction document before install the expansion card into the computer.
2. Remove your computer's chassis cover, screws and slotbracket from the computer.
3. Press the expansion card firmly into expansion slot in motherboard.
4. Be sure the metal contacts on the card are indeed seated in the slot.
5. Replace the screw to secure the slotbracket of the expansion card.
6. Replace your computer's chassis cover.
7. Power on the computer, if necessary, setup BIOS utility of expansion card from BIOS.
8. Install related driver from the operating system.

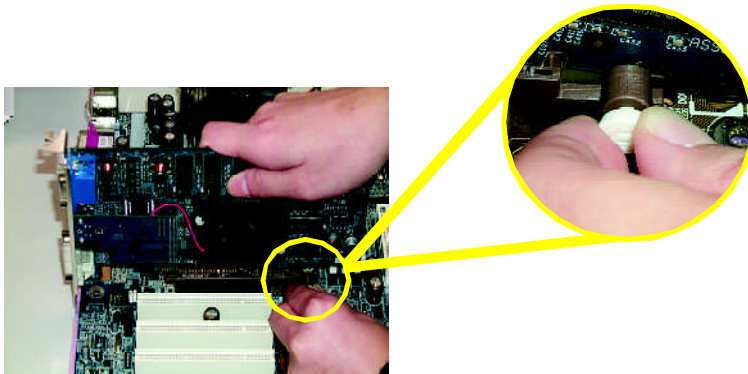

AGP Card

Please carefully pull out the small white-drawable bar at the end of the AGP slot when you try to install / uninstall the AGP card. Please align the AGP card to the onboard AGP slot and press firmly down on the slot. Make sure your AGP card is locked by the small white-drawable bar.

Step 4: Install I/O Peripherals Cables

Step 4-1: I/O Back Panel Introduction

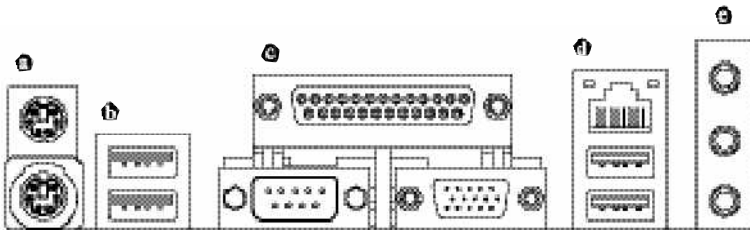

a PS/2 Keyboard and PS/2 Mouse Connector



PS/2 Mouse Connector
(6 pin Female)

PS/2 Keyboard Connector
(6 pin Female)

- This connector supports standard PS/2 keyboard and PS/2 mouse.

e / **f** USB/LAN Connector

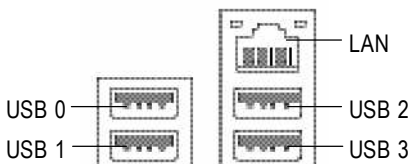

- Before you connect your device(s) into USB connector(s), please make sure your device (s) such as USB keyboard, mouse, scanner, zip, speaker...etc. Have a standard USB interface. Also make sure your OS supports USB controller. If your OS does not support USB controller, please contact OS vendor for possible patch or driver upgrade. For more information please contact your OS or device (s) vendors.
- LAN connector is fast Ethernet with 10/100 Mbps speed.

⊕ Parallel Port , Serial Port and VGA Port (LPT/COMA/VGA)

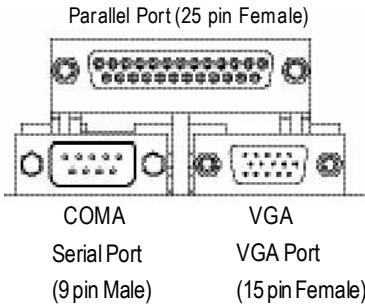

- This connector supports 1 standard COM port, 1 Parallel port and 1 VGA port. Device like printer can be connected to Parallel port; mouse and modem etc can be connected to Serialports.

⊕ Audio Connectors

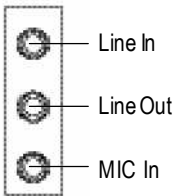

- After install onboard audio driver, you may connect speaker to Line Out jack, microphone to MIC In jack. Device like CD-ROM, walkman etc. can be connected to Line-In jack.

Please note:

You are able to use 2-/4-/6-channel audio feature by S/W selection.

If you want to enable 6-channel function, you have 2 choose for hardware connection.

Method1:

Connect "Front Speaker" to "Line Out"

Connect "Rear Speaker" to "Line In"

Connect "Center and Subwoofer" to "MIC In".

Method2:

You can refer to page 27, and contact your nearest dealer for optional SUR_CEN cable.



If you want the detail information for 2-/4-/6-channel audio setup installation, please refer to page 65.

Step 4-2: Connectors Introduction

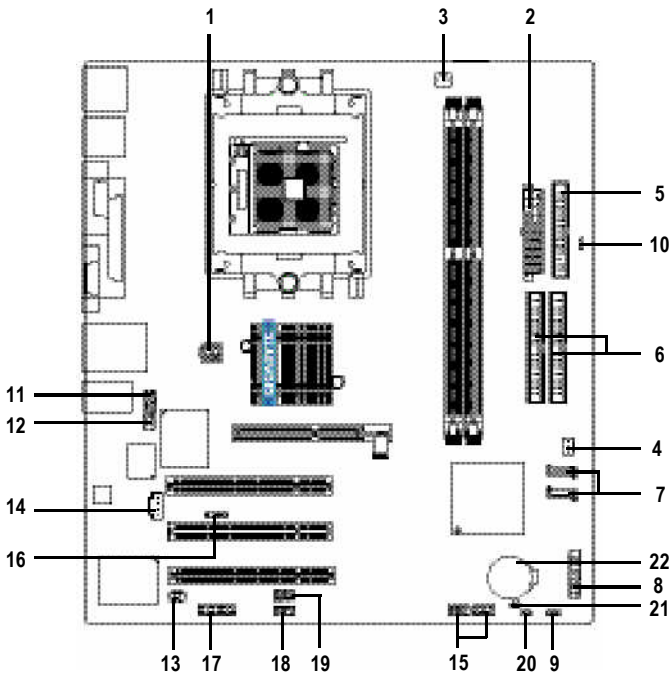

1) ATX_12V	12) SUR_CEN
2) ATX(Power Connector)	13) SPDIF_IO
3) CPU_FAN	14) CD_IN
4) SYS_FAN	15) F_USB1 / F_USB2
5) FDD	16) IR
6) IDE1 / IDE2	17) GAME
7) SATA0 / SATA1	18) INFO_LINK
8) F_PANEL	19) COMB
9) PWR_LED	20) CLR_CMOS
10) RAM_LED	21) C1
11) F_AUDIO	22) BAT

1) ATX_12V (+12V Power Connector)

This connector (ATX_12V) supplies the CPU operation voltage (V_{core}).
 If this "ATX_12V connector" is not connected, system cannot boot.

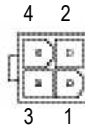
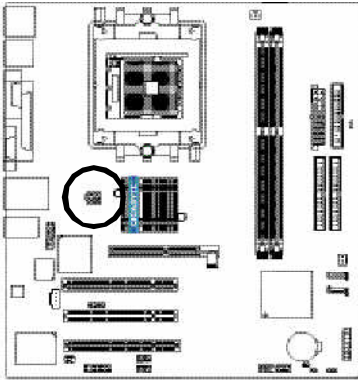

Pin No.	Definition
1	GND
2	GND
3	+12V
4	+12V

2) ATX (ATX Power Connector)

AC power cord should only be connected to your power supply unit after ATX power cable and other related devices are firmly connected to the motherboard.

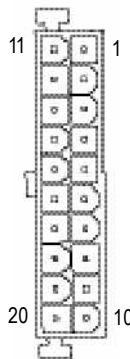
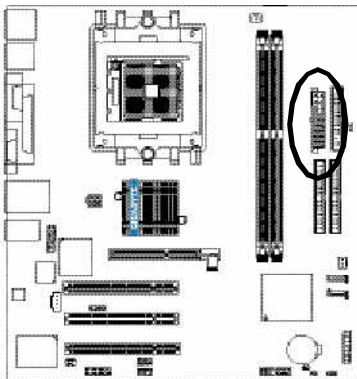

Pin No.	Definition
1	3.3V
2	3.3V
3	GND
4	VCC
5	GND
6	VCC
7	GND
8	Power Good
9	5V SB (stand by +5V)
10	+12V
11	3.3V
12	-12V
13	GND
14	PS_ON(soft on/off)
15	GND
16	GND
17	GND
18	-5V
19	VCC
20	VCC

3) CPU_FAN (CPU Fan Connector)

Please note, a proper installation of the CPU cooler is essential to prevent the CPU from running under abnormal condition or damaged by overheating. The CPU fan connector supports Max. current up to 600 mA.

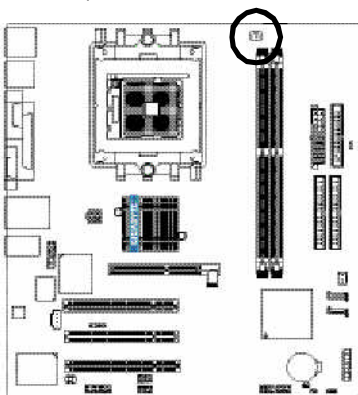

Pin No.	Definition
1	GND
2	+12V
3	Sense

4) SYS_FAN (System Fan Connector)

This connector allows you to link with the cooling fan on the system case to lower the system temperature.

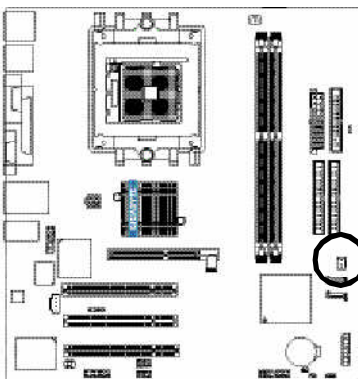

Pin No.	Definition
1	GND
2	+12V
3	Sense

5) FDD (Floppy Connector)

Please connect the floppy drive ribbon cables to FDD. It supports 360K, 1.2M, 720K, 1.44M and 2.88M bytes floppy disk types.

The red stripe of the ribbon cable must be the same side with the Pin1.

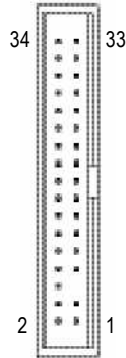
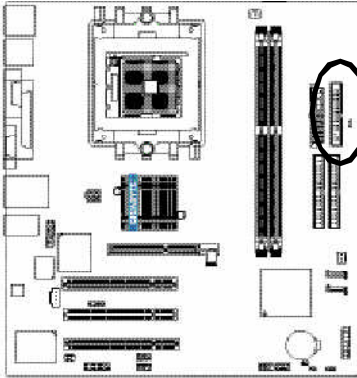

6) IDE1 / IDE2 (IDE1 / IDE2 Connector)

Important Notice:

Please connect first hard disk to IDE1 and connect CD-ROM to IDE2.

The red stripe of the ribbon cable must be the same side with the Pin1.

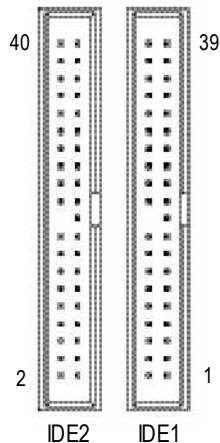
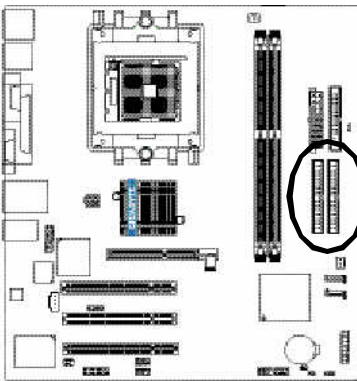

7) SATA0 / SATA1 (Serial ATA Connector)

You can connect the Serial ATA device to this connector. If you wish to use RAID function, please use it in unity with BIOS and install the correct driver to have proper operation.

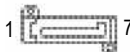
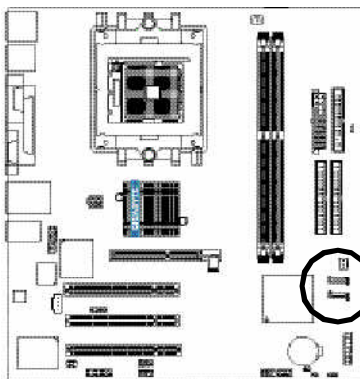

Pin No.	Definition
1	GND
2	TXP
3	TXN
4	GND
5	RXN
6	RXP
7	GND

8) PWR_LED

PWR_LED is connect with the system power indicator to indicate whether the system is on/off. It will blink when the system enters suspend mode. If you use dual color LED, power LED will turn to another color.

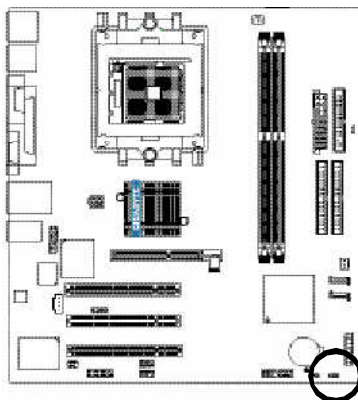

Pin No.	Definition
1	MPD+
2	MPD-
3	MPD-

9) F_PANEL (2 x 10 pins Connector)

Please connect the power LED, PC speaker, reset switch and power switch etc. of your chassis front panel to the F_PANEL connector according to the pin assignment below.

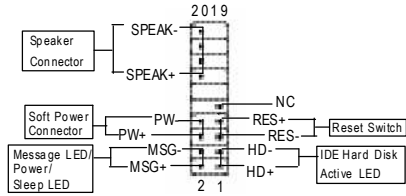
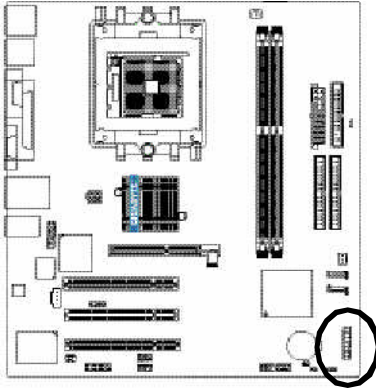

HD (IDE Hard Disk Active LED)	Pin 1: LED anode(+) Pin 2: LED cathode(-)
SPEAK (Speaker Connector)	Pin 1: VCC(+) Pin 2- Pin 3: NC Pin 4: Data(-)
RES (Reset Switch)	Open: Normal Operation Close: Reset Hardware System
PW (Soft Power Connector)	Open: Normal Operation Close: Power On/Off
MSG (Message LED/ Power/ Sleep LED)	Pin 1: LED anode(+) Pin 2: LED cathode(-)
NC	NC

10) RAM_LED

Do not remove memory modules while RAM_LED is on. It might cause short or other unexpected damages due to the stand by voltage. Remove memory modules only when AC power cord is disconnected.

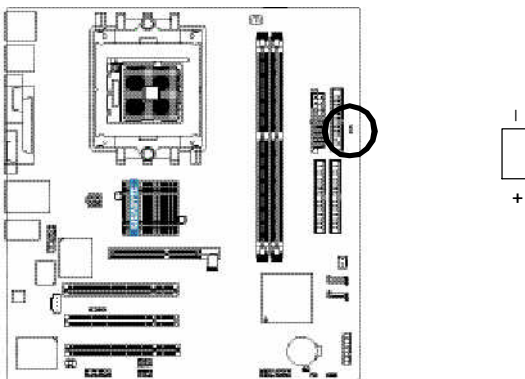

11) F_AUDIO (Front Audio Connector)

If you want to use Front Audio connector, you must remove 5-6, 9-10 Jumper.

In order to utilize the front audio header, your chassis must have front audio connector. Also please make sure the pin assignment on the cable is the same as the pin assignment on the MB header. To find out if the chassis you are buying support front audio connector, please contact your dealer. Please note, you can have the alternative of using front audio connector or of using rear audio connector to play sound.

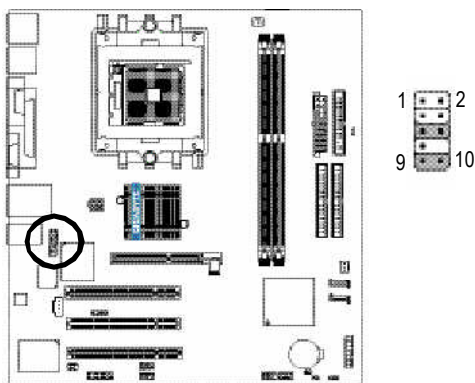

Pin No.	Definition
1	MIC
2	GND
3	MIC_BIAS
4	Power
5	FrontAudio (R)
6	RearAudio (R)
7	Reserved
8	No Pin
9	FrontAudio (L)
10	RearAudio (L)

12) SUR_CEN (Surround Center Connector)

Please contact your nearest dealer for optional SUR_CEN cable.

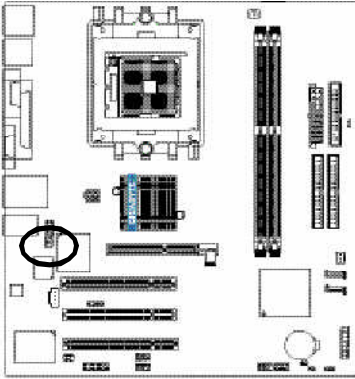

Pin No.	Definiton
1	SUROUTL
2	SUROUTR
3	GND
4	No Pin
5	CENTER_OUT
6	BASS_OUT

13) SPDIF_IO (SPDIF In / Out Connector)

The SPDIF output is capable of providing digital audio to external speakers or compressed AC3 data to an external Dolby Digital Decoder. Use this feature only when your stereo system has digital input function. Be careful with the polarity of the SPDIF_IO connector. Check the pin assignment carefully while you connect the SPDIF cable, incorrect connection between the cable and connector will make the device unable to work or even damage it. For optional SPDIF cable, please contact your local dealer.

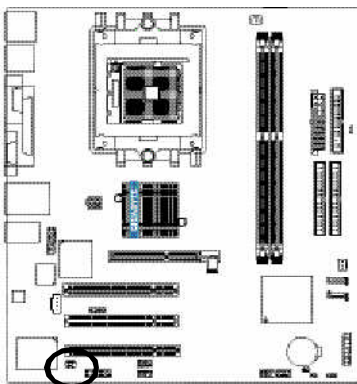

Pin No.	Definiton
1	VCC
2	No Pin
3	SPDIF
4	SPDIFI
5	GND
6	GND

14) CD_IN (CD In Connector)

Connect CD-ROM or DVD-ROM audio out to the connector.

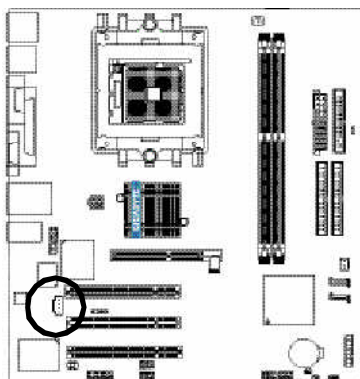

Pin No.	Definition
1	CD-L
2	GND
3	GND
4	CD-R

15) F_USB1 / F_USB2 (Front USB Connector)

Be careful with the polarity of the front USB connector. Check the pin assignment carefully while you connect the front USB cable, incorrect connection between the cable and connector will make the device unable to work or even damage it. For optional front USB cable, please contact your local dealer.

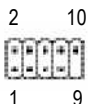
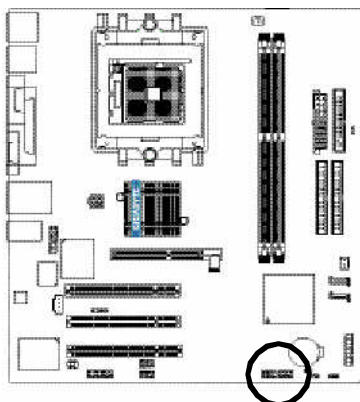

Pin No.	Definition
1	Power
2	Power
3	USB Dx-
4	USB Dy-
5	USB Dx+
6	USB Dy+
7	GND
8	GND
9	No Pin
10	NC

16) IR

Make sure the pin 1 on the IR device is along with pin one the connector. To enable the IR function on the board, you are required to purchase an option IR module. Be careful with the polarity of the IR/CIR or IR connector. Check the pin assignment carefully while you connect the IR cable, incorrect connection between the cable and connector will make the device unable to work or even damage it. For optional IR cable, please contact your local dealer.

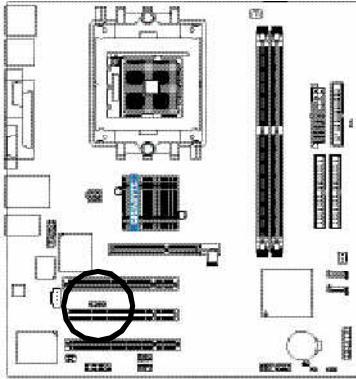

Pin No.	Definition
1	VCC(+5V)
2	No Pin
3	IRData Input
4	GND
5	IRData Output

17) GAME(Game Connector)

This connector supports joystick, MIDI keyboard and other relate audio devices. Check the pin assignment while you connect the game cables. Please contact your nearest dealer for optional game cables.

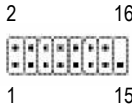
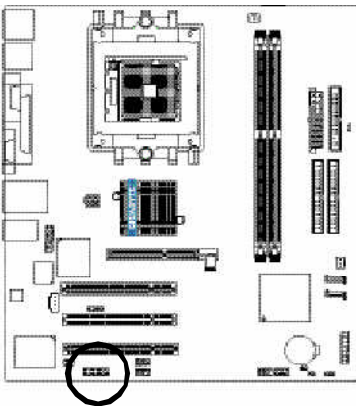

Pin No.	Definition
1	VCC
2	GRX1_R
3	GND
4	GPSA2
5	VCC
6	GPX2_R
7	GPY2_R
8	MSL_R
9	GPSA1
10	GND
11	GPY1_R
12	VCC
13	GPSB1
14	MSO_R
15	GPSB2
16	No Pin

18) INFO_LINK

This connector allows you to connect some external devices to provide you extra function. Check the pin assignment while you connect the external device cable. Please contact your nearest dealer for optional external device cable.

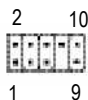
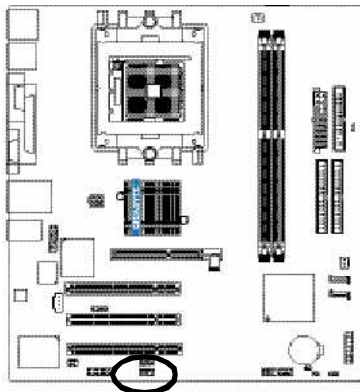

Pin No.	Definiton
1	SMBCLK
2	VCC
3	SMBDATA
4	GPIO
5	GND
6	GND
7	No Pin
8	NC
9	+12V
10	+12V

19) COMB (COM B Connector)

Be careful with the polarity of the COMB connector. Check the pin assignment carefully while you connect the COMB cable, incorrect connection between the cable and connector will make the device unable to work or even damage it. For optional COMB cable, please contact your local dealer.

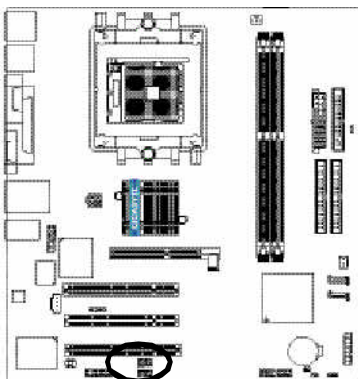



Pin No.	Definiton
1	NDCDB-
2	NSINB
3	NSOUTB
4	NDTRB-
5	GND
6	NDSRB-
7	NRTSB-
8	NCTSB-
9	NRIB-
10	No Pin

20) CLR_CMOS (Clear CMOS)

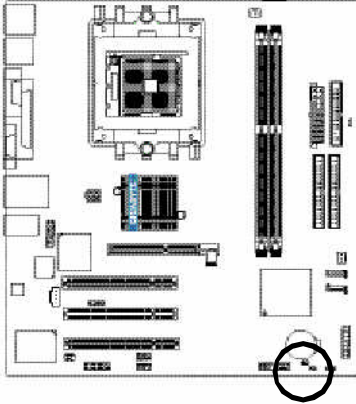
You may clear the CMOS data to its default values by this jumper. To clear CMOS, temporarily short 1-2 pin. Default doesn't include the "Shunter" to prevent from improper use this jumper.



1  Open: Normal

1  Short: Clear CMOS

21) CI (Chassis Intrusion, Case Open)

This 2-pin connector allows your system to enable or disable the "case open" item in BIOS if the system case begin remove.

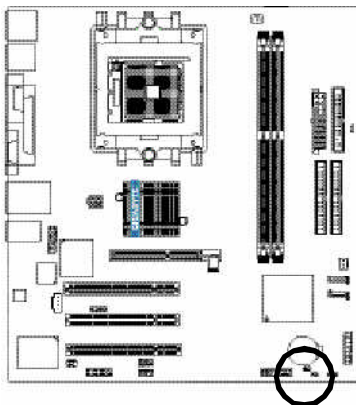

1 

Pin No.	Definiton
1	Signal
2	GND

22) BATTERY

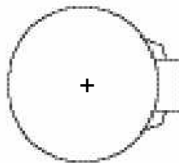
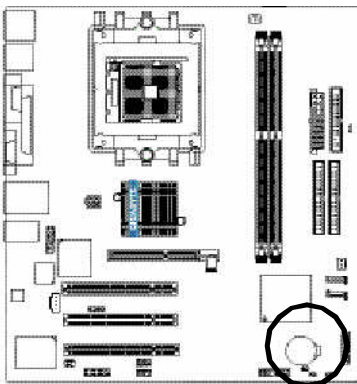

CAUTION

- ❖ Danger of explosion if battery is incorrectly replaced.
- ❖ Replace only with the same or equivalent type recommended by the manufacturer.
- ❖ Dispose of used batteries according to the manufacturer's instructions.

If you want to erase CMOS...

1. Turn OFF the computer and unplug the power cord.
2. Remove the battery, wait for 30 second.
3. Re-install the battery.
4. Plug the power cord and turn ON the computer.

Chapter 3 BIOS Setup

BIOS Setup is an overview of the BIOS Setup Program. The program that allows users to modify the basic system configuration. This type of information is stored in battery-backed CMOS RAM so that it retains the Setup information when the power is turned off.

ENTERING SETUP

Powering ON the computer and pressing immediately will allow you to enter Setup. If you require more advanced BIOS settings, please go to "Advanced BIOS" setting menu. To enter Advanced BIOS setting menu, press "Ctrl+F1" key on the BIOS screen.

When setting up BIOS for the first time, it is recommended that you save the current BIOS to a disk in the event that BIOS needs to be reset to its original settings. If you wish to upgrade to a new BIOS, either Gigabyte's Q-Flash or @BIOS utility can be used.

Q-Flash allows the user to quickly and easily update or backup BIOS without entering the operating system.

@BIOS is a Windows-based utility that does not require users to boot to DOS before upgrading BIOS but directly download and update BIOS from the Internet.

CONTROL KEYS

<↑>	Move to previous item
<↓>	Move to next item
<←>	Move to the item in the left hand
<→>	Move to the item in the right hand
<Enter>	Select Item
<Esc>	Main Menu - Quit and not save changes into CMOS Status Page Setup Menu and Option Page Setup Menu - Exit current page and return to Main Menu
<+/PgUp>	Increase the numeric value or make changes
<-/PgDn>	Decrease the numeric value or make changes
<F1>	General help, only for Status Page Setup Menu and Option Page Setup Menu
<F2>	Item Help
<F3>	Reserved
<F4>	Reserved
<F5>	Restore the previous CMOS value from CMOS, only for Option Page Setup Menu
<F6>	Load the file-safe default CMOS value from BIOS default table
<F7>	Load the Optimized Defaults
<F8>	Q-Flash utility
<F9>	System Information
<F10>	Save all the CMOS changes, only for Main Menu

Main Menu

The on-line description of the highlighted setup function is displayed at the bottom of the screen.

Status Page Setup Menu / Option Page Setup Menu

Press F1 to pop up a small help window that describes the appropriate keys to use and the possible selections for the highlighted item. To exit the Help Window press <Esc>.

The Main Menu (For example: BIOS Ver. : D8)

Once you enter Award BIOS CMOS Setup Utility, the Main Menu (as figure below) will appear on the screen. The Main Menu allows you to select from eight setup functions and two exit choices. Use arrow keys to select among the items and press <Enter> to accept or enter the sub-menu.

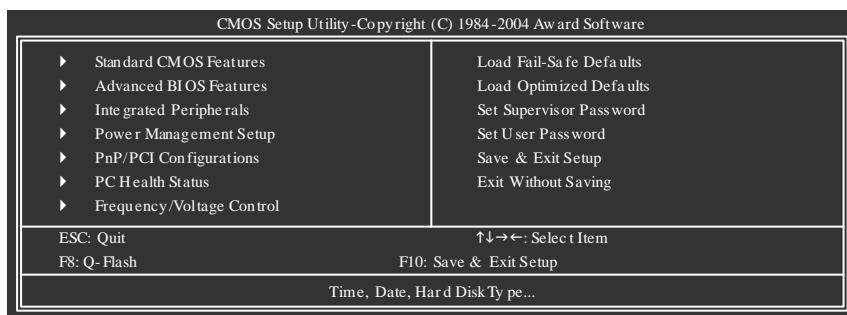

If you can't find the setting you want, please press "Ctrl + F1" to search the advanced option hidden.

- **Standard CMOS Features**

This setup page includes all the items in standard compatible BIOS.

- **Advanced BIOS Features**

This setup page includes all the items of Award special enhanced features.

- **Integrated Peripherals**

This setup page includes all onboard peripherals.

- **Power Management Setup**

This setup page includes all the items of Green function features.

- **PnP/PCI Configurations**

This setup page includes all the configurations of PCI & PnP ISA resources.

- **PC Health Status**

This setup page is the System auto detect Temperature, voltage, fan, speed.

- **Frequency/Voltage Control**

This setup page is control CPU's clock and frequency ratio.

- **Load Fail-Safe Defaults**

Fail-Safe Defaults indicates the value of the system parameters which the system would be in safe configuration.

- **Load Optimized Defaults**

Optimized Defaults indicates the value of the system parameters which the system would be in best performance configuration.

- **Set Supervisor Password**

Change, set, or disable password. It allows you to limit access to the system and Setup, or just to Setup.

- **Set User Password**

Change, set, or disable password. It allows you to limit access to the system.

- **Save & Exit Setup**

Save CMOS value settings to CMOS and exit setup.

- **Exit Without Saving**

Abandon all CMOS value changes and exit setup.

Standard CMOS Features

CMOS Setup Utility - Copyright (C) 1984-2004 Award Software
Standard CMOS Features

		Item Help
Date (mm:dd:yy)	Tue, Jan 27 2004	Menu Level▶
Time (hh:mm:ss)	22:31:24	Change the day, month, year
▶ IDE Primary Master	[None]	<Week>
▶ IDE Primary Slave	[None]	Sun. to Sat.
▶ IDE Secondary Master	[None]	<Month>
▶ IDE Secondary Slave	[None]	Jan. to Dec.
Drive A	[1.44M, 3.5"]	<Day>
Drive B	[None]	1 to 31 (or maximum allowed in the month)
Floppy 3 Mode Support	[Disabled]	<Year>
Holt On	[All, But Keyboard]	1999 to 2098
Base Memory	640K	
Extended Memory	127M	
Total Memory	128M	

↑↓→←: Move Enter: Select +/-/PU/PD: Value F10: Save ESC: Exit F1: General Help
F5: Previous Values F6: Fail-Save Default F7: Optimized Defaults

☛ Date

The date format is <week>, <month>, <day>, <year>.

- ▶ Week The week, from Sun to Sat, determined by the BIOS and is displayed only
- ▶ Month The month, Jan. Through Dec.
- ▶ Day The day, from 1 to 31 (or the maximum allowed in the month)
- ▶ Year The year, from 1999 through 2098

☛ Time

The times format in <hour> <minute> <second>. The time is calculated base on the 24-hour military-time clock. For example, 1 p.m. is 13:00:00.

☛ IDE Primary Master, Slave / IDE Secondary Master, Slave

The category identifies the types of hard disk from drive C to F that has been installed in the computer. There are two types: auto type, and manual type. Manual type is user-definable; Auto type which will automatically detect HDD type.

Note that the specifications of your drive must match with the drive table. The hard disk will not work properly if you enter improper information for this category.

If you select User Type, related information will be asked to enter to the following items. Enter the information directly from the keyboard and press <Enter>. Such information should be provided in the documentation from your hard disk vendor or the system manufacturer.

- ▶ Cylinder Number of cylinders
- ▶ Head Number of heads
- ▶ Precomp Write precomp
- ▶ Landing Zone Landing zone
- ▶ Sector Number of sectors

If a hard disk has not been installed, select NONE and press <Enter>.

☛ Drive A / Drive B

The category identifies the types of floppy disk drive A or drive B that has been installed in the computer.

- ▶▶ None No floppy drive installed
- ▶▶ 360K, 5.25" 5.25 inch PC-type standard drive; 360K byte capacity.
- ▶▶ 1.2M, 5.25" 5.25 inch AT-type high-density drive; 1.2M byte capacity (3.5 inch when 3 Mode is Enabled).
- ▶▶ 720K, 3.5" 3.5 inch double-sided drive; 720K byte capacity
- ▶▶ 1.44M, 3.5" 3.5 inch double-sided drive; 1.44M byte capacity.
- ▶▶ 2.88M, 3.5" 3.5 inch double-sided drive; 2.88M byte capacity.

☛ Floppy 3 Mode Support (for Japan Area)

- ▶▶ Disabled Normal Floppy Drive. (Default value)
- ▶▶ Drive A Drive A is 3 mode Floppy Drive.
- ▶▶ Drive B Drive B is 3 mode Floppy Drive.
- ▶▶ Both Drive A & B are 3 mode Floppy Drives.

☛ Halt on

The category determines whether the computer will stop if an error is detected during power up.

- ▶▶ No Errors The system boot will not stop for any error that may be detected and you will be prompted.
- ▶▶ All Errors Whenever the BIOS detects a non-fatal error the system will be stopped.
- ▶▶ All, But Keyboard The system boot will not stop for a keyboard error; it will stop for all other errors. (Default value)
- ▶▶ All, But Diskette The system boot will not stop for a disk error; it will stop for all other errors.
- ▶▶ All, But Disk/Key The system boot will not stop for a keyboard or disk error; it will stop for all other errors.

☛ Memory

The category is display-only which is determined by POST (Power On Self Test) of the BIOS.

▶▶ Base Memory

The POST of the BIOS will determine the amount of base (or conventional) memory installed in the system.

The value of the base memory is typically 512K for systems with 512K memory installed on the motherboard, or 640K for systems with 640K or more memory installed on the motherboard.

▶▶ Extended Memory

The BIOS determines how much extended memory is present during the POST.

This is the amount of memory located above 1 MB in the CPU's memory address map.

Advanced BIOS Features

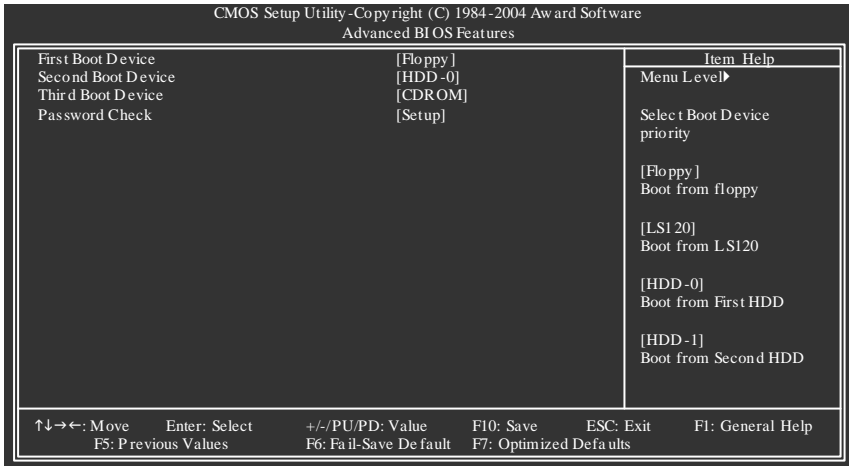

First / Second / Third Boot Device

- ▶▶ Floppy Select your boot device priority by Floppy.
- ▶▶ LS120 Select your boot device priority by LS120.
- ▶▶ HDD-0~3 Select your boot device priority by HDD-0~3.
- ▶▶ SCSI Select your boot device priority by SCSI.
- ▶▶ CDROM Select your boot device priority by CDROM.
- ▶▶ ZIP Select your boot device priority by ZIP.
- ▶▶ USB-FDD Select your boot device priority by USB-FDD.
- ▶▶ USB-ZIP Select your boot device priority by USB-ZIP.
- ▶▶ USB-CDROM Select your boot device priority by USB-CDROM.
- ▶▶ USB-HDD Select your boot device priority by USB-HDD.
- ▶▶ LAN Select your boot device priority by LAN.
- ▶▶ Disabled Select your boot device priority by Disabled.

Password Check

- ▶▶ System The system can not boot and can not access to Setup page will be denied if the correct password is not entered at the prompt.
- ▶▶ Setup The system will boot, but access to Setup will be denied if the correct password is not entered at the prompt. (Default value)

Integrated Peripherals

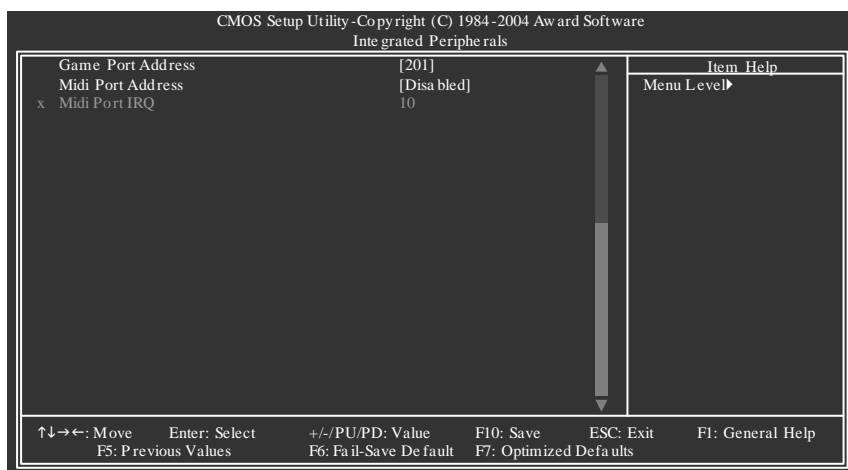
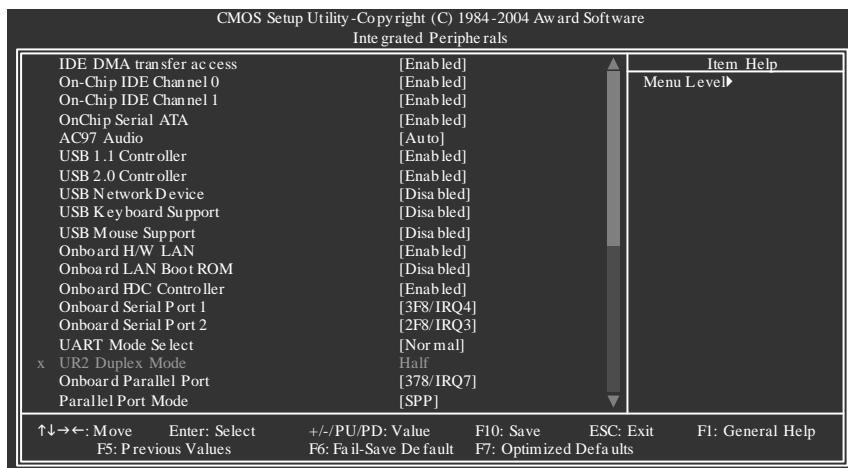

☛ IDE DMA transfer access

- ▶▶ Enabled Enable IDE DMA transfer access. (Default value)
- ▶▶ Disabled Disable this function.

☛ On-Chip IDE Channel0

- ▶▶ Enabled Enable onboard 1st channel IDE port. (Default value)
- ▶▶ Disabled Disable onboard 1st channel IDE port.

☛ On-Chip IDE Channel1

- ▶▶ Enabled Enable onboard 2nd channel IDE port. (Default value)
- ▶▶ Disabled Disable onboard 2nd channel IDE port.

- ⚙ **OnChip Serial ATA**
 - ▶ Enabled Enable VT8237 Serial ATA supported. (Default v alue)
 - ▶ Disabled Disable VT8237 Serial ATA supported.
- ⚙ **AC97 Audio**
 - ▶ Auto Enable onboard AC'97 audio function. (Default v alue)
 - ▶ Disabled Disable this function.
- ⚙ **USB 1.1 Controller**

Disable USB 1.1 host controller if you are not using USB dev ices.

 - ▶ Enabled Enable USB 1.1 controller. (Default v alue)
 - ▶ Disabled Disable USB 1.1 controller.
- ⚙ **USB 2.0 Controller**

Disable USB 2.0 host controller if you are not using high speed USB dev ices.

 - ▶ Enabled Enable USB 2.0 controller. (Default v alue)
 - ▶ Disabled Disable USB 2.0 controller.
- ⚙ **USB Network Device**
 - ▶ Enabled Enable USB network device.
 - ▶ Disabled Disable USB network device. (Default v alue)
- ⚙ **USB Keyboard Support**
 - ▶ Enabled Enable USB keyboard support. (Default v alue)
 - ▶ Disabled Disable USB keyboard support.
- ⚙ **USB Mouse Support**
 - ▶ Enabled Enable USB mouse support. (Default v alue)
 - ▶ Disabled Disable USB mouse support.
- ⚙ **Onboard H/W LAN**
 - ▶ Enabled Enable onboard LAN function. (Default v alue)
 - ▶ Disabled Disable onboard LAN function.
- ⚙ **Onboard LAN Boot ROM**

This function decide whether to invoke the boot ROM of the onboard LAN chip.

 - ▶ Enabled Enable this function.
 - ▶ Disabled Disable this function. (Default v alue)
- ⚙ **Onboard FDC Controller**
 - ▶ Enabled Enable onboard FDC Controller. (Default v alue)
 - ▶ Disabled Disable onboard FDC Controller.
- ⚙ **Onboard Serial Port 1**
 - ▶ Auto BIOS will automatically setup the port 1 address.
 - ▶ 3F8/IRQ4 Enable onboard Serial port 1 and address is 3F8. (Default v alue)
 - ▶ 2F8/IRQ3 Enable onboard Serial port 1 and address is 2F8.
 - ▶ 3E8/IRQ4 Enable onboard Serial port 1 and address is 3E8.
 - ▶ 2E8/IRQ3 Enable onboard Serial port 1 and address is 2E8.
 - ▶ Disabled Disable onboard Serial port 1.

☛ Onboard Serial Port 2

- ▶▶ Auto BIOS will automatically setup the port 2 address.
- ▶▶ 3F8/IRQ4 Enable onboard Serial port 2 and address is 3F8.
- ▶▶ 2F8/IRQ3 Enable onboard Serial port 2 and address is 2F8. (Default value)
- ▶▶ 3E8/IRQ4 Enable onboard Serial port 2 and address is 3E8.
- ▶▶ 2E8/IRQ3 Enable onboard Serial port 2 and address is 2E8.
- ▶▶ Disabled Disable onboard Serial port 2.

☛ UART Mode Select

This item allows you to determine which infrared(IR) function of onboard I/O chip.

- ▶▶ Normal Set onboard I/O chip using as standard serial port. (Default value)
- ▶▶ IrDA Set onboard I/O chip UART to IrDA Mode.
- ▶▶ ASKIR Set onboard I/O chip UART to ASKIR Mode.

☛ UR2 Duplex Mode

This function will available when "UART Mode Select" doesn't set at Normal.

- ▶▶ Half IR Function Duplex Half. (Default value)
- ▶▶ Full IR Function Duplex Full.

☛ Onboard Parallel Port

- ▶▶ 378/IRQ7 Enable onboard LPT port and address is 378/IRQ7. (Default value)
- ▶▶ 278/IRQ5 Enable onboard LPT port and address is 278/IRQ5.
- ▶▶ Disabled Disable onboard LPT port.
- ▶▶ 3BC/IRQ7 Enable onboard LPT port and address is 3BC/IRQ7.

☛ Parallel Port Mode

- ▶▶ SPP Using Parallel port as Standard Parallel Port. (Default value)
- ▶▶ EPP Using Parallel port as Enhanced Parallel Port.
- ▶▶ ECP Using Parallel port as Extended Capabilities Port.
- ▶▶ ECP+EPP Using Parallel port as ECP & EPP mode.

☛ Game Port Address

- ▶▶ 201 Set Game Port Address to 201. (Default value)
- ▶▶ 209 Set Game Port Address to 209.
- ▶▶ Disabled Disable this function.

☛ Midi Port Address

- ▶▶ 300 Set Midi Port Address to 300.
- ▶▶ 330 Set Midi Port Address to 330
- ▶▶ Disabled Disable this function. (Default value)

☛ Midi Port IRQ

- ▶▶ 5 Set Midi Port IRQ to 5.
- ▶▶ 10 Set Midi Port IRQ to 10. (Default value)

Power Management Setup

CMOS Setup Utility - Copyright (C) 1984-2004 Award Software
Power Management Setup

		Item Help
	ACPI Suspend Type	[S1(POS)]
x	USB Device Wake-Up From S3	Disabled
	Soft-Off by PWRBTN	[Instant-Off]
	AC Back Function	[Soft-Off]
	Keyboard Power On	[Disabled]
	Mouse Power On	[Disabled]
	PME Event Wake Up	[Enabled]
	Modem Ring Resume	[Enabled]
	Resume by Alarm	[Disabled]
x	Date (of Month) Alarm	Everyday
x	Time (hh:mm:ss) Alarm	0:0:0

Menu Level ▶

[S1]
Set suspend type to Power On Suspend under ACPI OS

[S3]
Set suspend type to Suspend to RAM under ACPI OS

↑↓→←: Move Enter: Select +/-/PU/PD: Value F10: Save ESC: Exit F1: General Help
F5: Previous Values F6: Fail-Save Default F7: Optimized Defaults

ACPI Suspend Type

- ▶▶ S1(POS) Set ACPI suspend type to S1/POS (Power On Suspend). (Default value)
- ▶▶ S3(STR) Set ACPI suspend type to S3/STR (Suspend To RAM).

USB Device Wake-Up From S3

- ▶▶ Disabled Disable this function.
- ▶▶ Enable Enable USB device wake up system from S3 suspend type. (Default value)

Soft-Off by PWRBTN

- ▶▶ Instant-off Press power button then power off instantly. (Default value)
- ▶▶ Delay 4 Sec. Press power button 4 seconds to power off. Enter suspend if button is pressed less than 4 seconds.

AC Back Function

- ▶▶ Soft-Off Always in off state when AC back. (Default value)
- ▶▶ Memory System power on depends on the status before AC lost.
- ▶▶ Full-On Always power on the system when AC back.

Keyboard Power On

- ▶▶ Disabled Disabled this function. (Default value)
- ▶▶ Password Enter from 1 to 5 characters to set the keyboard power on password.
- ▶▶ Keyboard 98 If there is a "POWER" button on your keyboard, you can press the key to power on your system.

Mouse Power On

- ▶▶ Disabled Disabled this function. (Default value)
- ▶▶ Enabled Power on system by mouse event.

PME Event Wake Up

- ▶▶ Disabled Disable this function.
- ▶▶ Enabled Enable PME as wake up event. (Default value)

☛ Modem Ring On

An incoming call via modem can awake the system from any suspend state.

- ▶ Disabled Disable Modem Ring on function.
- ▶ Enabled Enable Modem Ring on function. (Default value)

☛ Resume by Alarm

You can set "Resume by Alarm" item at "Enabled" and key in date/time to power on system.

- ▶ Disabled Disable this function. (Default value)
- ▶ Enabled Enable alarm function to POWER ON system.

If RTC Alarm Lead To Power On is Enabled.

Date (of Month) Alarm : Every day, 1~31

Time (hh: mm: ss) Alarm : (0~23) : (0~59) : (0~59)

PnP/PCI Configurations

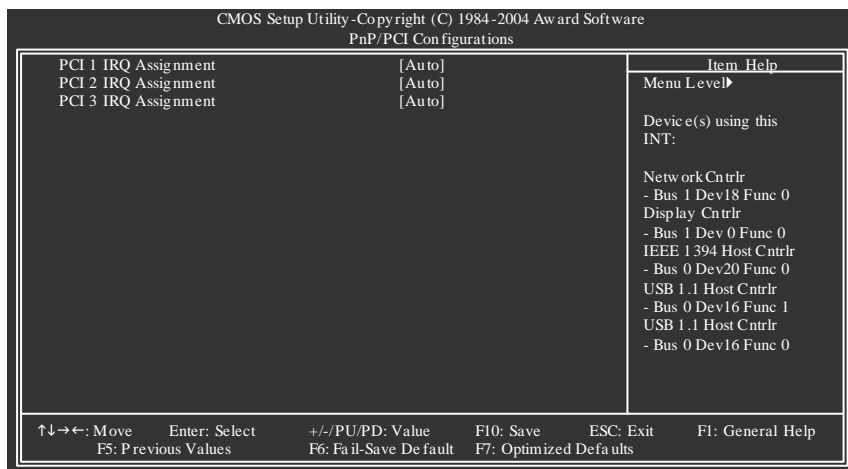

☛ PCI 1 IRQ Assignment

- ▶ Auto Auto assign IRQ to PCI 1. (Default value)
- ▶ 3,4,5,7,9,10,11,12,14,15 Set IRQ 3,4,5,7,9,10,11,12,14,15 to PCI 1.

☛ PCI 2 IRQ Assignment

- ▶ Auto Auto assign IRQ to PCI 2. (Default value)
- ▶ 3,4,5,7,9,10,11,12,14,15 Set IRQ 3,4,5,7,9,10,11,12,14,15 to PCI 2.

☛ PCI 3 IRQ Assignment

- ▶ Auto Auto assign IRQ to PCI 3. (Default value)
- ▶ 3,4,5,7,9,10,11,12,14,15 Set IRQ 3,4,5,7,9,10,11,12,14,15 to PCI 3.

PC Health Status

CMOS Setup Utility - Copyright (C) 1984-2004 Award Software		
PC Health Status		
Reset Case Open Status	[Disa bled]	Item Help
Case Opened	No	Menu Level▶
Vcore	OK	
DDR25V	OK	
+3.3V	OK	[Disa bled]
+12V	OK	Don't m onitor curre nt fan speed
Current CPU Temperature	35°C	
Current CPU FAN Speed	3125 RPM	
Current SYSTEM FAN Speed	0 RPM	[Enabled]
CPU FAN Fail Warning	[Disa bled]	Alarm when FAN stops
SYSTEM FAN Fail Warning	[Disa bled]	

↑↓→←: Move Enter: Select +/-/PU/PD: Value F10: Save ESC: Exit F1: General Help
 F5: P revious Values F6: Fa il-Save De fault F7: Opt imized Defaul ts

☛ Reset Case Open Status

☛ Case Opened

If the case is closed, "Case Opened" will show "No".

If the case have been opened, "Case Opened" will show "Yes".

If you want to reset "Case Opened" value, set "Reset Case Open Status" to "Enabled" and save CMOS, your computer will restart.

☛ Current Voltage (V) Vcore / DDR25V / +3.3V / +12V

▶▶ Detect system's voltage status automatically.

☛ Current CPU Temperature

▶▶ Detect CPU temperature automatically.

☛ Current CPU/SYSTEM FAN Speed (RPM)

▶▶ Detect CPU/system fan speed status automatically.

☛ CPU FAN Fail Warning

▶▶ Disabled Fan warning function disable. (Default value)

▶▶ Enabled Fan warning function enable.

☛ SYSTEM FAN Fail Warning

▶▶ Disabled Fan warning function disable. (Default value)

▶▶ Enabled Fan warning function enable.

Frequency/Voltage Control

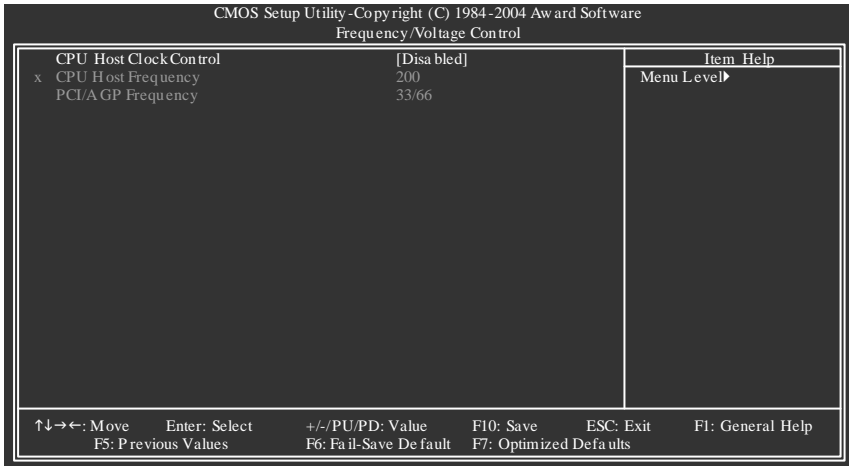

Incorrect using these features may cause your system broken. For power End-User use only!

o CPU Host Clock Control

Note:

Please note that if your system is overclocked and cannot restart, please wait 20secs. for automatic system restart or clear the CMOS setup data and perform a safe restart.

- ▶ Disabled Disable CPU Host Clock Control.(Default v alue)
- ▶ Enabled Enable CPU Host Clock Control.

o CPU Host Frequency (Mhz)

- ▶ 200MHz ~455MHz Set CPU Host F requency from 200MHz to 455MHz.

o PCI /AGP Frequency(Mhz)

- ▶ The v alues depend on Fixed PCI/AGP Frequency .

Load Fail-Safe Defaults

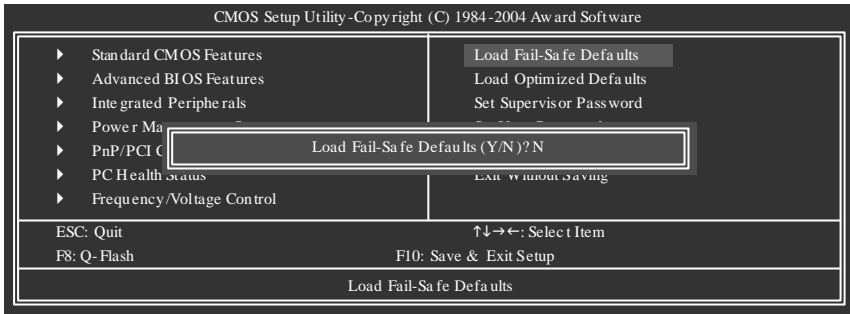

Fail-Safe defaults contain the most appropriate values of the system parameters that allow minimum system performance.

Load Optimized Defaults

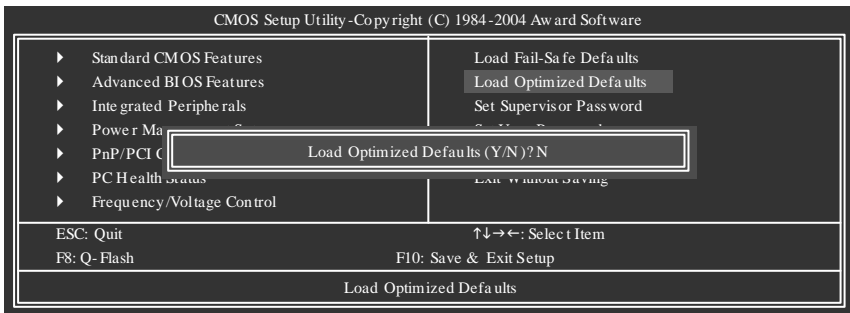

Selecting this field loads the factory defaults for BIOS and Chipset Features which the system automatically detects.

Set Supervisor/User Password

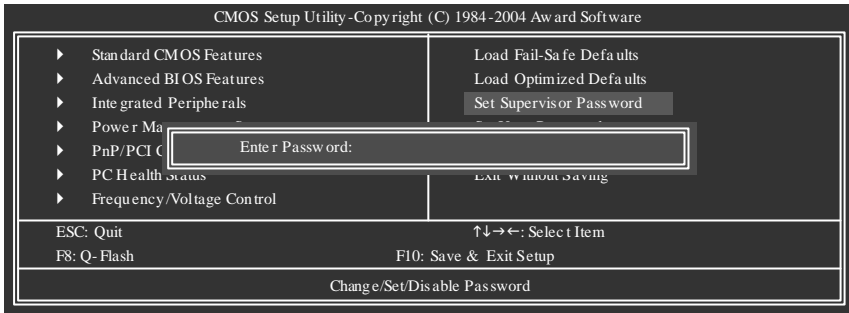

When you select this function, the following message will appear at the center of the screen to assist you in creating a password.

Type the password, up to eight characters, and press <Enter>. You will be asked to confirm the password. Type the password again and press <Enter>. You may also press <Esc> to abort the selection and not enter a password.

To disable password, just press <Enter> when you are prompted to enter password. A message "PASSWORD DISABLED" will appear to confirm the password being disabled. Once the password is disabled, the system will boot and you can enter Setup freely.

The BIOS Setup program allows you to specify two separate passwords: SUPERVISOR PASSWORD and a USER PASSWORD. When disabled, anyone may access all BIOS Setup program function. When enabled, the Supervisor password is required for entering the BIOS Setup program and having full configuration fields, the User password is required to access only basic items.

If you select "System" at "Password Check" in Advance BIOS Features Menu, you will be prompted for the password every time the system is rebooted or any time you try to enter Setup Menu.

If you select "Setup" at "Password Check" in Advance BIOS Features Menu, you will be prompted only when you try to enter Setup.

Save & Exit Setup

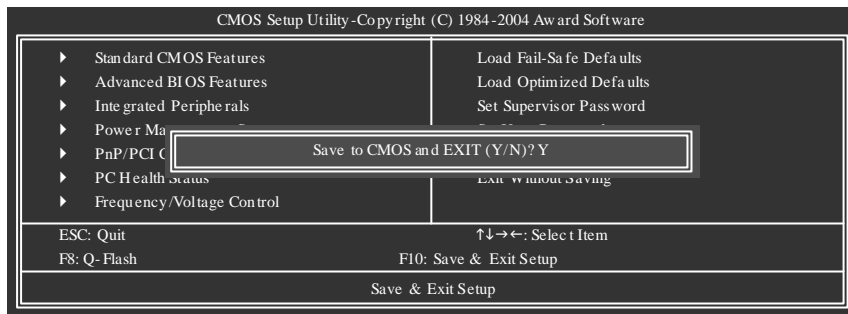

Type "Y" will quit the Setup Utility and save the user setup value to RTC CMOS.
Type "N" will return to Setup Utility.

Exit Without Saving

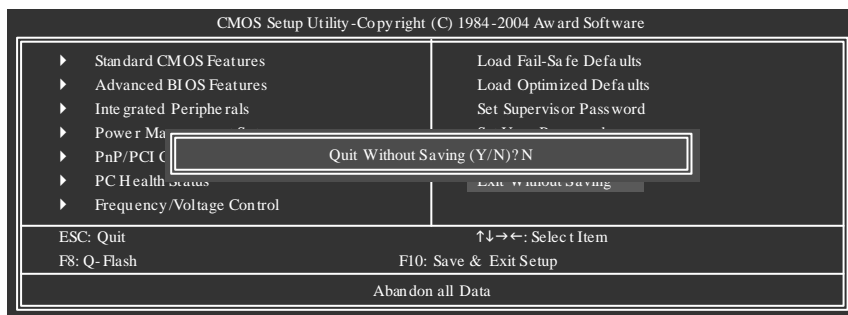

Type "Y" will quit the Setup Utility without saving to RTC CMOS.
Type "N" will return to Setup Utility.

Chapter 4 Technical Reference

@BIOS™ Introduction

Gigabyte announces @BIOS Windows BIOS Live Update Utility



Have you ever updated BIOS by yourself? Or like many other people, you just know what BIOS is, but always hesitate to update it? Because you think updating newest BIOS is unnecessary and actually you don't know how to update it.

Maybe not like others, you are very experienced in BIOS updating and spend quite a lot of time to do it. But of course you don't like to do it too much. First, download different BIOS from website and then switch the operating system to DOS mode. Secondly, use different flash utility to update BIOS. The above process is not a interesting job. Besides, always be carefully to store the BIOS source code correctly in your disks as if you update the wrong BIOS, it will be a nightmare.

Certainly, you wonder why motherboard vendors could not just do something right to save your time and effort and save you from the lousy BIOS updating work? Here it comes! Now Gigabyte announces @BIOS -- the first Windows BIOS live update utility. This is a smart BIOS update software. It could help you to download the BIOS from internet and update it. Not like the other BIOS update software, it's a Windows utility. With the help of "@BIOS", BIOS updating is no more than a click.

Besides, no matter which mainboard you are using, if it's a Gigabyte's product*, @BIOS help you to maintain the BIOS. This utility could detect your correct mainboard model and help you to choose the BIOS accordingly. It then downloads the BIOS from the nearest Gigabyte ftp site automatically. There are several different choices; you could use "Internet Update" to download and update your BIOS directly. Or you may want to keep a backup for your current BIOS, just choose "Save Current BIOS" to save it first. You make a wise choice to use Gigabyte, and @BIOS update your BIOS smartly. You are now worry free from updating wrong BIOS, and capable to maintain and manage your BIOS easily. Again, Gigabyte's innovative product erects a milestone in motherboard industries.

For such a wonderful software, how much it costs? Impossible! It's free! Now, if you buy a Gigabyte's motherboard, you could find this amazing software in the attached driver CD. But please remember, connected to internet at first, then you could have a internet BIOS update from your Gigabyte @BIOS.

Flash BIOS Method Introduction

Method 1 : Q-Flash™ Utility



Q-Flash™ is a BIOS flash utility embedded in Flash ROM. With this utility, users only have to stay in the BIOS menu when they want to update BIOS. Q-Flash™ allows users to flash BIOS without any utility in DOS or Windows. Using Q-Flash™ indicating no more fooling around with any

complicated instructions and operating system since it is in the BIOS menu.



Please note that because updating BIOS has potential risk, please do it with caution!! We are sorry that Gigabyte Technology Co., Ltd is not responsible for damages of system because of incorrect manipulation of updating BIOS to avoid any claims from end-users.

Before You Begin:

Before you start updating BIOS with the Q-Flash™ utility, please follow the steps below first.

1. Download the latest BIOS for your motherboard from Gigabyte's website.
2. Extract the BIOS file downloaded and save the BIOS file (the one with model name.Fxx. For example, 8KNXPU.Fba) to a floppy disk.
3. Reboot your PC and press **Del** to enter BIOS menu.

The BIOS upgrading guides below are separated into two parts.

If your motherboard has dual-BIOS, please refer to **Part One**.

If your motherboard has single-BIOS, please refer to **Part Two**.

Part One:

Updating BIOS with Q-Flash™ Utility on Dual BIOS Motherboards.

Some of Gigabyte motherboards are equipped with dual BIOS. In the BIOS menu of the motherboards supporting Q-Flash and Dual BIOS, the Q-Flash utility and Dual BIOS utility are combined in the same screen. This section only deals with how to use Q-Flash utility.

In the following sections, we take GA-8KNXP Ultra as the example to guide you how to flash BIOS from an older version to the latest version. For example, from Fa3 to Fba.

The BIOS file is Fa3 before updating

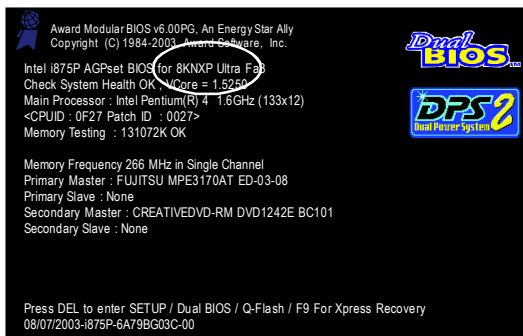

Entering the Q-Flash™ utility:

Step1: To use Q-Flash utility, you must press **Del** in the boot screen to enter BIOS menu.

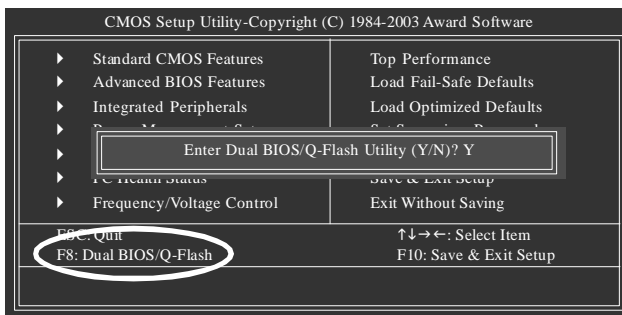

Step 2: Press **F8** button on your keyboard and then **Y** button to enter the Dual BIOS/Q-Flash utility.

Exploring the Q-Flash™ / Dual BIOS utility screen

The Q-Flash / Dual BIOS utility screen consists of the following key components.

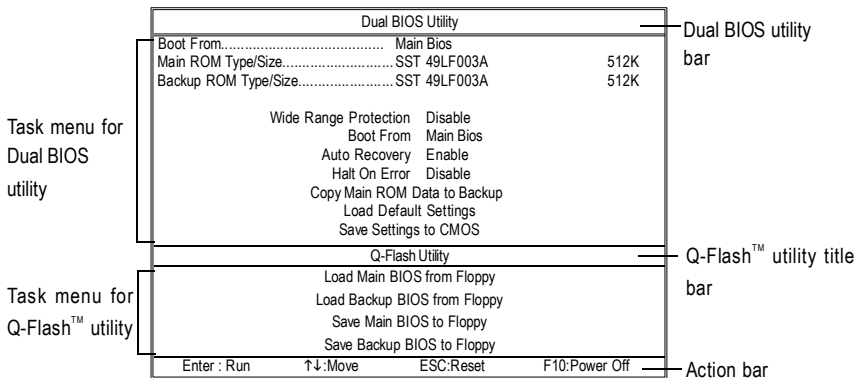

Task menu for Dual BIOS utility:

Contains the names of eight tasks and two item showing information about the BIOS ROM type. Blocking a task and pressing **Enter** key on your keyboard to enable execution of the task.

Task menu for Q-Flash utility:

Contains the names of four tasks. Blocking a task and pressing **Enter** key on your keyboard to enable execution of the task.

Action bar:

Contains the names of four actions needed to operate the Q-Flash/Dual BIOS utility. Pressing the buttons mentioned on your keyboards to perform these actions.

Using the Q-Flash™ utility:

This section tells you how to update BIOS using the Q-Flash utility. As described in the "Before you begin" section above, you must prepare a floppy disk having the BIOS file for your motherboard and insert it to your computer. If you have already put the floppy disk into your system and have entered the Q-Flash utility, please follow the steps below to flash BIOS.

Steps:

1. Press arrow buttons on your keyboard to move the light bar to "Load Main BIOS from Floppy" item in the Q-Flash menu and press **Enter** button.

Later, you will see a box pop up showing the BIOS files you previously downloaded to the floppy disk.



If you want to save the current BIOS for backup purpose, you can begin Step 1 with "Save Main BIOS to Floppy" item.

2. Move to the BIOS file you want to flash and press **Enter**.

In this example, we only download one BIOS file to the floppy disk so only one BIOS file, **8KNXPU.Fba**, is listed.



Please confirm again you have the correct BIOS file for your motherboard.

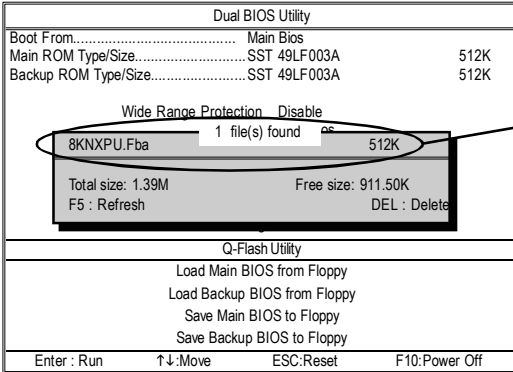

BIOS file in the floppy disk.

After pressing **Enter**, you'll then see the progress of reading the BIOS file from the floppy disk.

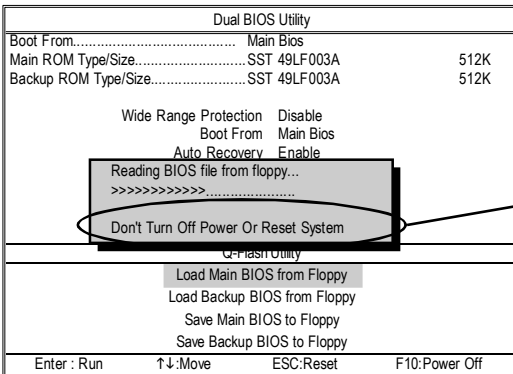

Do not turn off power or reset your system at this stage!!

After BIOS file is read, you'll see a confirmation dialog box asking you "Are you sure to update BIOS?"

3. Press **Y** button on your keyboard after you are sure to update BIOS.

Then it will begin to update BIOS. The progress of updating BIOS will be displayed.



Please do not take out the floppy disk when it begins flashing BIOS.

4. Press any keys to return to the Q-Flash menu when the BIOS updating procedure is completed.

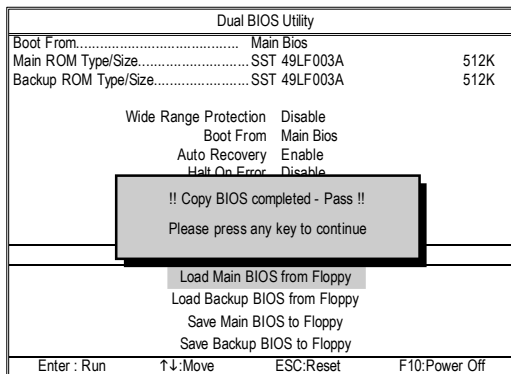

You can repeat Step 1 to 4 to flash the backup BIOS, too.

5. Press **Esc** and then **Y** button to exit the Q-Flash utility. The computer will restart automatically after you exit Q-Flash.

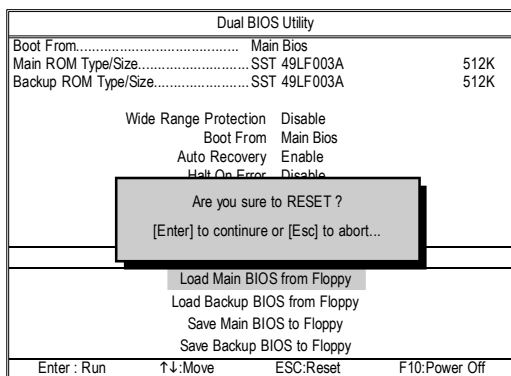

After system reboots, you may find the BIOS version on your boot screen becomes the one you flashed.

The BIOS file becomes
Fab after updating

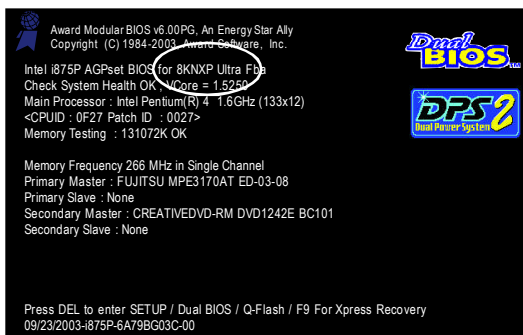

6. Press **Del** to enter BIOS menu after system reboots. When you are in BIOS menu, move to **Load Fail-Safe Defaults** item and press **Enter** to load BIOS Fail-Safe Defaults. Normally the system redetects all devices after BIOS has been upgraded. Therefore, we highly recommend reloading the BIOS defaults after BIOS has been upgraded.

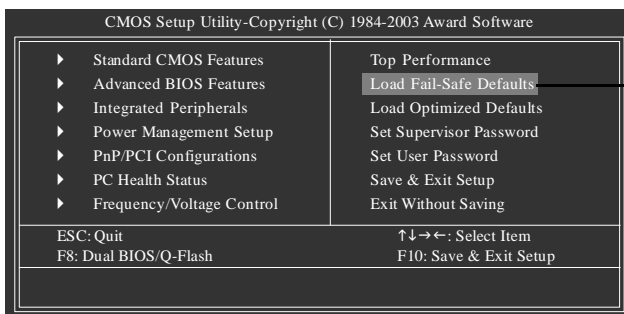

Press **Enter** on your keyboard

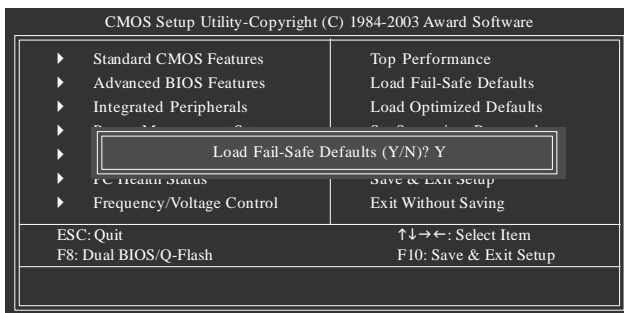

Press **Y** on your keyboard to load defaults.

7. Select **Save & Exit Setup** item to save the settings to CMOS and exit the BIOS menu. System will reboot after you exit the BIOS menu. The procedure is completed.

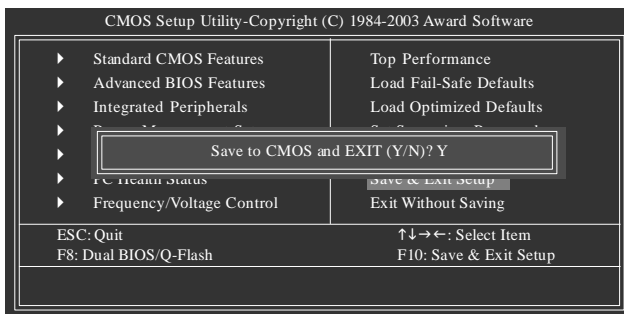

Press **Y** on your keyboard to save and exit.

Part Two:

Updating BIOS with Q-Flash™ Utility on Single-BIOS Motherboards.

This part guides users of single-BIOS motherboards how to update BIOS using the Q-Flash™ utility.

Entering the Q-Flash™ utility:

Step1: To use the Q-Flash utility, you must press **Del** in the boot screen to enter BIOS menu.

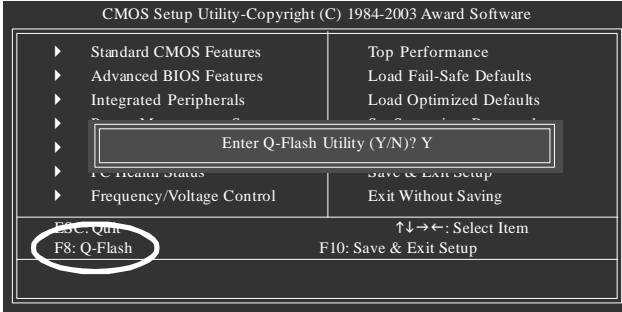

Step 2: Press **F8** button on your keyboard and then **Y** button to enter the Q-Flash utility.

Exploring the Q-Flash™ utility screen

The Q-FlashBIOS utility screen consists of the following key components.

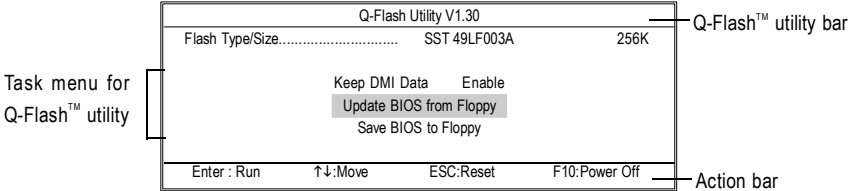

Task menu for Q-Flash utility:

Contains the names of three tasks. Blocking a task and pressing **Enter** key on your keyboard to enable execution of the task.

Action bar:

Contains the names of four actions needed to operate the Q-Flash utility. Pressing the buttons mentioned on your keyboards to perform these actions.

Using the Q-Flash™ utility:

This section tells you how to update BIOS using the Q-Flash utility. As described in the "Before you begin" section above, you must prepare a floppy disk having the BIOS file for your motherboard and insert it to your computer. If you have already put the floppy disk into your system and have entered the Q-Flash utility, please follow the steps below to flash BIOS.

Steps:

1. Press arrow buttons on your keyboard to move the light bar to "Update BIOS from Floppy" item in the Q-Flash menu and press Enter button.

Later, you will see a box pop up showing the BIOS files you previously downloaded to the floppy disk.



If you want to save the current BIOS for backup purpose, you can begin Step 1 with "Save BIOS to Floppy" item.

2. Move to the BIOS file you want to flash and press Enter.

In this example, we only download one BIOS file to the floppy disk so only one BIOS file, 8GE800.F4, is listed.



Please confirm again you have the correct BIOS file for your motherboard.

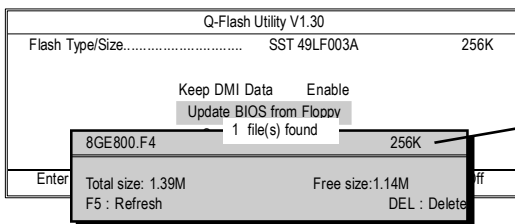

BIOS file in the floppy disk.

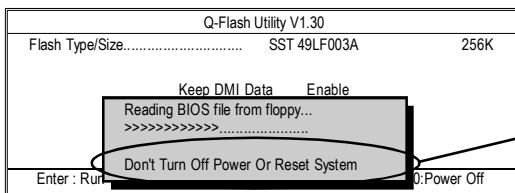

Do not turn off power or reset your system at this stage!!

After BIOS file is read, you'll see a confirmation dialog box asking you "Are you sure to update BIOS?"



Please do not take out the floppy disk when it begins flashing BIOS.

3. Press **Y** button on your keyboard after you are sure to update BIOS.

Then it will begin to update BIOS. The progress of updating BIOS will be shown at the same time.

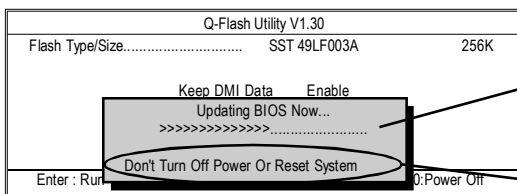

The process of updating BIOS



Do not turn off power or reset your system at this stage!!

4. Press any keys to return to the Q-Flash menu when the BIOS updating procedure is completed.

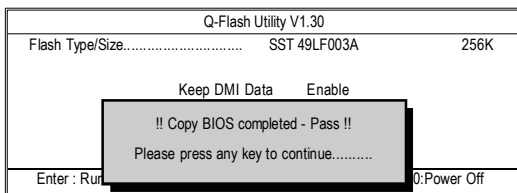

5. Press **Esc** and then **Y** button to exit the Q-Flash utility. The computer will restart automatically after you exit Q-Flash.

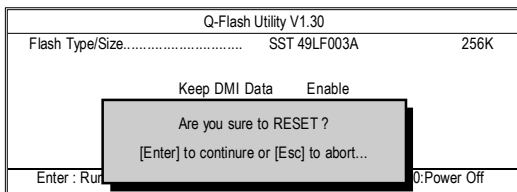

After system reboots, you may find the BIOS version on your boot screen becomes the one you flashed.

The BIOS file becomes Fab after updating

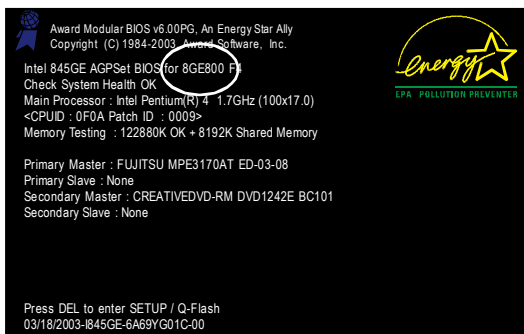

6. Press **Del** to enter BIOS menu after system reboots and "Load BIOS Fail-Safe Defaults". See how to Load BIOS Fail-Safe Defaults, please kindly refer to Step 6 to 7 in **Part One**.

Congratulation!! You have updated BIOS successfully!!

Method 2 : @BIOS™ Utility

If you don't have DOS boot disk, we recommend that you used Gigabyte @BIOS™ program to flash BIOS.

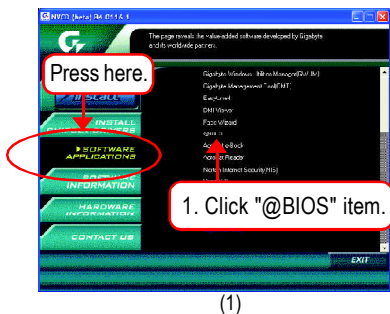

(1)

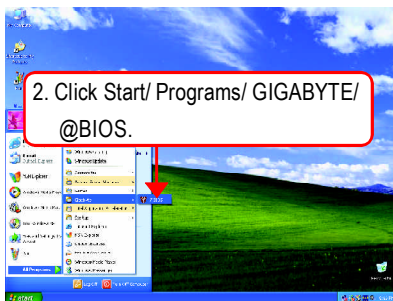

(2)

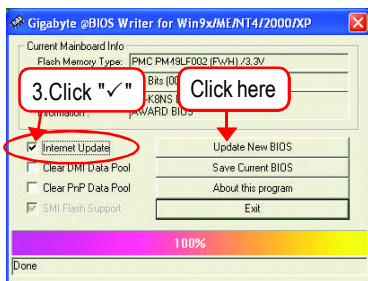

(3)

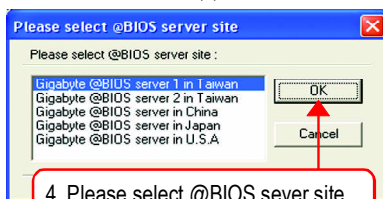

(4)

Methods and steps:

1. Update BIOS through Internet:
 - a. Click "Internet Update" icon
 - b. Click "Update New BIOS" icon
 - c. Select @BIOS™ sever
 - d. Select the exact model name on your motherboard
 - e. System will automatically download and update the BIOS.
2. Update BIOS NOT through Internet:
 - a. Do not click "Internet Update" icon
 - b. Click "Update New BIOS"
 - c. Please select "All Files" in dialog box while opening the old file.
 - d. Please search for BIOS unzip file, downloading from internet or any other methods. (such as: K8VM800M.D8).
 - e. Complete update process following the instruction.

3. Save BIOS

In the very beginning, there is "Save Current BIOS" icon shown in dialog box. It means to save the current BIOS version.

4. Check out supported motherboard and Flash ROM:

In the very beginning, there is "About this program" icon shown in dialog box. It can help you check out which kind of motherboard and which brand of Flash ROM are supported.

Note:

- a. In method I, if it shows two or more motherboard's model names to be selected, please make sure your motherboard's model name again. Selecting wrong model name will cause the system unbooted.
- b. In method II, be sure that motherboard's model name in BIOS unzip file are the same as your motherboard's. Otherwise, your system won't boot.
- c. In method I, if the BIOS file you need cannot be found in @BIOS™ server, please go onto Gigabyte's web site for downloading and updating it according to method II.
- d. Please note that any interruption during updating will cause system unbooted.

2-/4-/6-Channel Audio Function Introduction

The installation of windows 98SE/2K/ME/XP is very simple. Please follow next step to install the function!

Stereo Speakers Connection and Settings:

We recommend that you use the speaker with amplifier to acquire the best sound effect if the stereo output is applied.

STEP 1:

Connect the stereo speakers or earphone to "Line Out".



Line Out

STEP 2 :

After installation of the audio driver, you'll find an  icon on the taskbar's status area. Click the audio icon "Sound Effect" from the windows tray at the bottom of the screen.

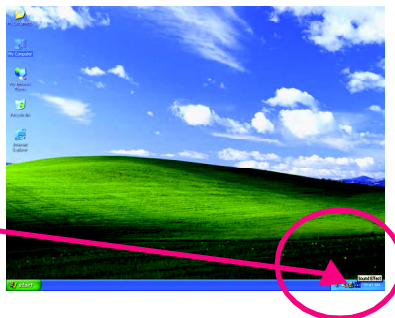

STEP 3:

Select "Speaker Configuration", and choose the "2 channel for stereo speakers out put".

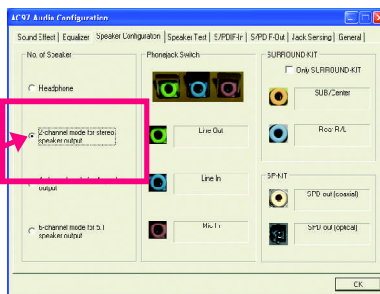
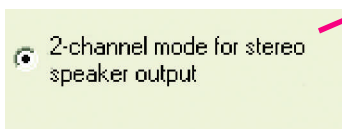

4 Channel Analog Audio Output Mode

STEP 1 :

Connect the front channels to "Line Out",
the rear channels to "Line In".

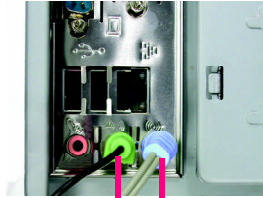

Line Out Line In

STEP 2 :

After installation of the audio driver, you'll find an  icon on the taskbar's status area. Click the audio icon "Sound Effect" from the windows tray at the bottom of the screen.

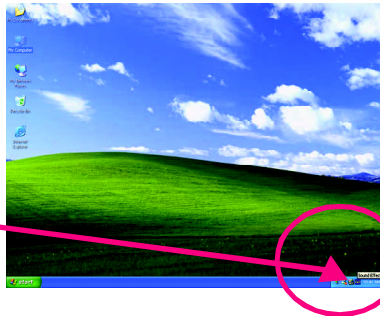

STEP 3 :

Select "Speaker Configuration", and choose the "4 channel for 4 speakers out put".
Disable "Only SURROUND-KIT", and press "OK".

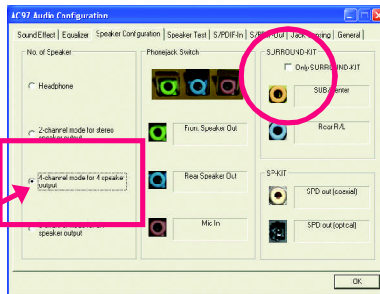
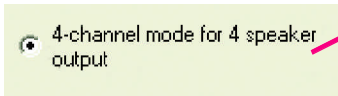

When the "Environment settings" is "None", the sound would be performed as stereo mode (2 channels output). Please select the other settings for 4 channels output.

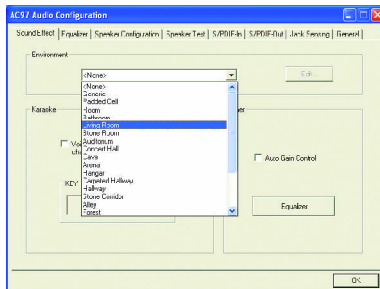

Basic 6 Channel Analog Audio Output Mode

Use the back audio panel to connect the audio output without any additional module.

STEP 1 :

Connect the front channels to "Line Out", the rear channels to "Line In", and the Center/Subwoofer channels to "MIC In".

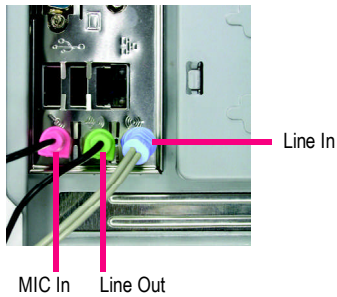

STEP 2 :

After installation of the audio driver, you'll find an  icon on the taskbar's status area. Click the audio icon "Sound Effect" from the windows tray at the bottom of the screen.

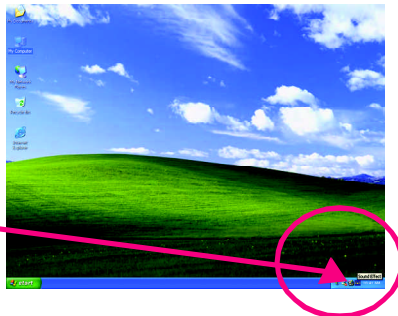

STEP 3 :

Select "Speaker Configuration", and choose the "6 channel for 5.1 speakers out put".

Disable "Only SURROUND-KIT" and press "OK".

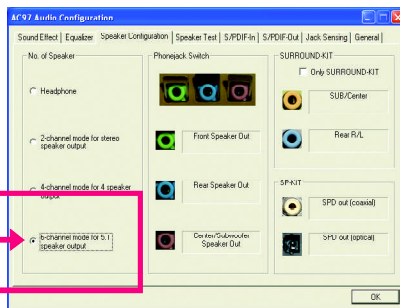
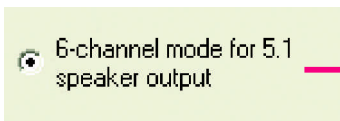

Advanced 6 Channel Analog Audio Output Mode (using Audio Combo Kit,Optional Device):

(Audio Combo Kit provides SPDIF output port : optical & coaxial and SURROUND-KIT : Rear R/L & CEN /Subwoofer)

SURROUND-KIT access analog output to rear channels and Center/Subwoofer channels. It is the best solution if you need 6 channel output, Line In and MIC at the same time. "SURROUND-KIT" is included in the GIGABYTE unique "Audio Combo Kit" as picture.

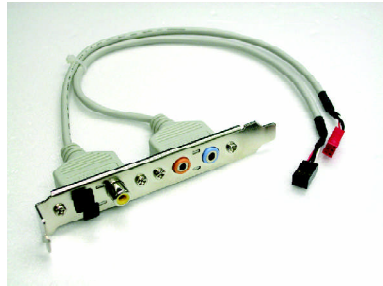
**STEP 1 :**

Insert the "SURROUND-KIT" in the back of the case ,and fix it with the screw.

**STEP 2 :**

Connect the "SURROUND-KIT" to SUR_CEN on the M/B.

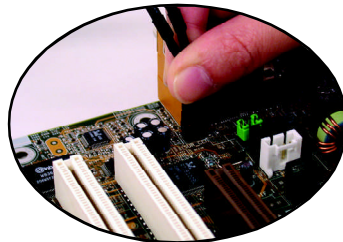
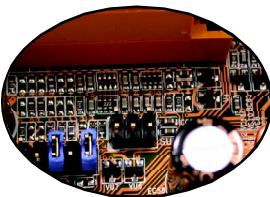

STEP 3 :

Connect the front channels to back audio panel's "Line Out", the rear channels to SURROUND-KIT's REAR R/L, and the Center/Subwoofer channels to SURROUND-KIT's SUB CENTER.

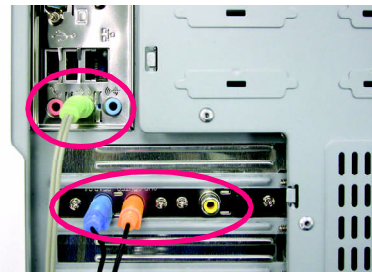

STEP 4 :

Click the audio icon "Sound Effect" from the windows tray at the bottom of the screen.

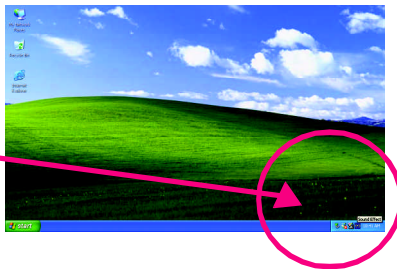

STEP 5 :

Select "Speaker Configuration", and choose the "6 channel for 5.1 speakers out put". Enable "Only SURROUND-KIT" and press "OK".

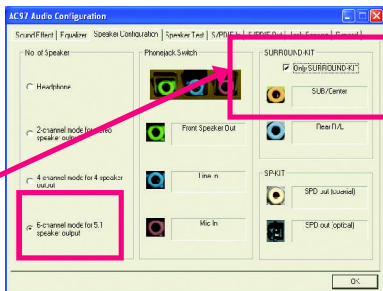
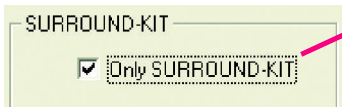

Basic & Advanced 6 Channel Analog Audio Output ModeNotes:

When the "Environment settings" is "None", the sound would be performed as stereo mode(2 channels output). Please select the other settings for 6 channels output.

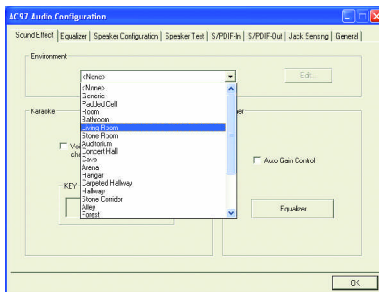

SPDIF Output Device (Optional Device)

A "SPDIF output" device is available on the motherboard. Cable with rear bracket is provided and could link to the "SPDIF output" connector (As picture.) For the further linkage to decoder, rear bracket provides coaxial cable and Fiber connecting port.

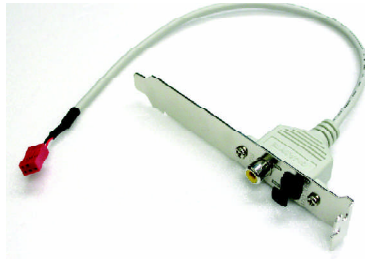

1. Connect the SPDIF output device to the rear bracket of PC, and fix it with screw.

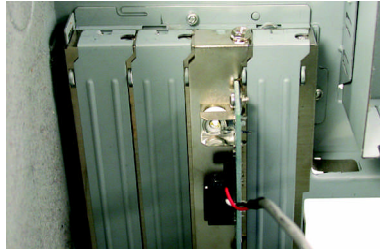

2. Connect SPDIF device to the motherboard.

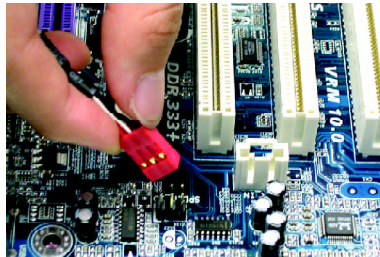

3. Connect SPDIF to the SPDIF decoder.



Jack-Sensing Introduction



Jack-Sensing provides audio connectors error-detection function.



Install Microsoft DirectX8.1 before to enable Jack-Sensing support for Windows 98/98SE/2000

/ME.

Jack-Sensing includes 2 parts: AUTO and MANUAL. Following is an example for 2 channels (Windows XP):

Introduction of audio connectors

You may connect CDROM, Walkman or others audio input devices to Line In jack, speakers, earphone or others output devices to Line Out jack, and microphone to MIC In jack.

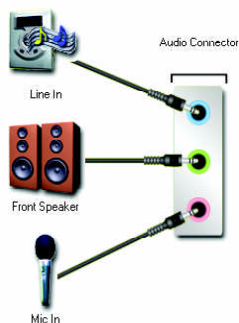

Auto-detecting:

Please connect the devices to the right jacks as above. A window will appear as right picture if you setup the devices properly.

Please note that 3D audio function will only appear when 3D audio inputs.

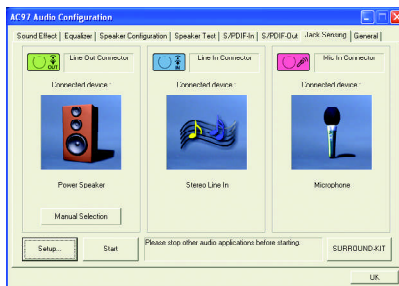

If you set wrong with the connectors, the warning message will come out as right picture.

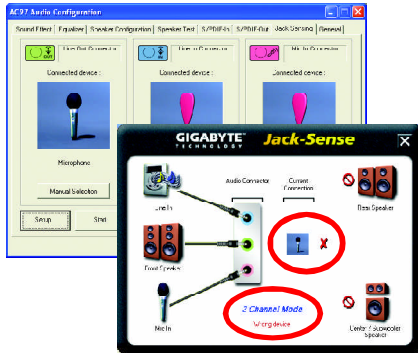

Manual setting:

If the device picture shows different from what you set, please press "Manual Selection" to set.

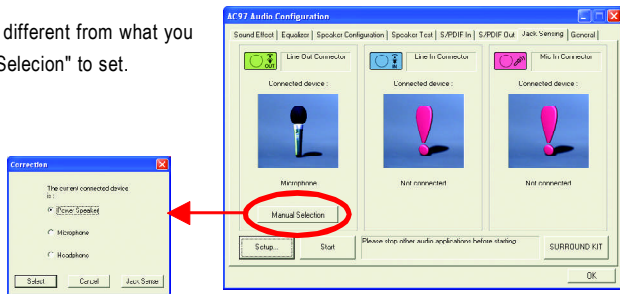

Xpress Recovery Introduction

What is Xpress Recovery ?

Xpress Recovery is a utility used to back up and restore an OS partition. If the hard drive is not working properly, the user can restore the drive to its original state.



1. Supports FAT16, FAT32, and NTFS formats
2. Must be connected to the IDE1 Master
3. Allows installation of only one OS
4. Must be used with an IDE hard disk supporting HPA
5. The first partition must be set as the boot partition. When the boot partition is backed up, please do not alter its size.
6. Xpress Recovery is recommended when using Ghost to return boot manager to NTFS format.

How to use the Xpress Recovery

1. Boot from CD-ROM (BMP Mode)

Enter the BIOS menu, select "Advanced BIOS Feature" and set to boot from CD-ROM. Insert the provided driver CD into your CD drive, then save and exit the BIOS menu. Once the computer has restarted, the phrase "Boot from CD:" will appear at the bottom left-hand corner of the screen. When "Boot from CD:" appears, press any key to enter Xpress Recovery. Once you have completed this step, subsequent access to Xpress Recovery can also function by pressing the F9 key during computer power on.

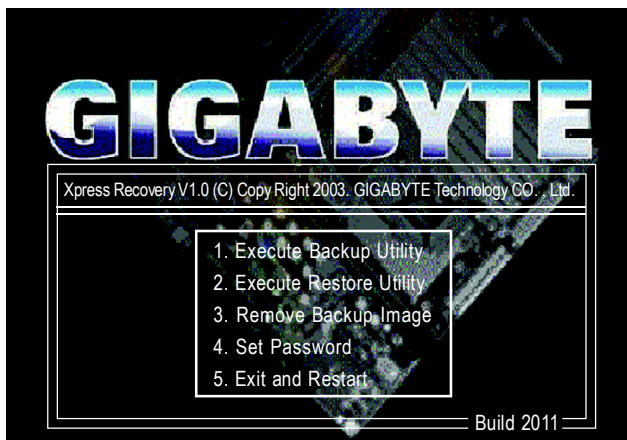

2. Press F9 during powering on the computer. (Text Mode)

Press F9 during powering on the computer.

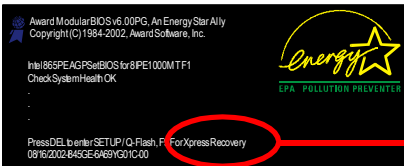

F9 For Xpress Recovery

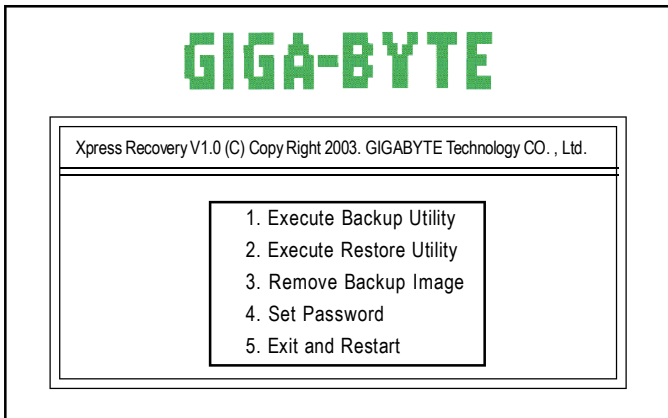

1. If you have already entered Xpress Recovery by booting from the CD-ROM, you can enter Xpress Recovery in the future by pressing the F9 key.
2. System storage capacity as well as drive reading/writing speed will affect backup speed.
3. It is recommended that Xpress Recovery be immediately installed after OS and all required driver and software installations are complete.

1. Execute Backup Utility:

Press B to Backup your System or Esc to Exit

The backup utility will automatically scan your system and back up data as a backup image in your hard drive.



Not all systems support access to Xpress Recovery by pressing the F9 key during computer power on. If this is the case, please use the boot from CD-ROM method to enter Xpress Recovery.

2. Execute Restore Utility:

This program will recover your system to factory default.

Press R to restore your system back to factory default or press Esc to exit

Restores backup image to original state.

3. Remove Backup Image:

Remove backup image. Are you sure? (Y/N)

Remove the backup image.

4. Set Password:

Please input a 4-16 character long password (a-z or 0-9) or press Esc to exit

You can set a password to enter Xpress Recovery to protect your hard disk data. Once this is done, password input will be required to enter Xpress Recovery during the next as well as subsequent system restarts. If you wish to remove the need for password entry, please select "Set Password" and under "New Password/Confirm Password", make sure there is no entry and then press "Enter" to remove password requirement.

5. Exit and Restart:

Exit and restart your computer.

Serial ATA BIOS Setting Utility Introduction

RAID Levels

RAID (Redundant Array of Independent Disks) is a method of combining two hard disk drives into one logical unit. The advantage of an Array is to provide better performance or data fault tolerance. Fault tolerance is achieved through data redundant operation, where if one drives fails, a mirrored copy of the data can be found on another drive. This can prevent data loss if the operating system fails or hangs. The individual disk drives in an array are called .members. The configuration information of each member is recorded in the .reserved sector. that identifies the drive as a member. All disk members in a formed disk array are recognized as a single physical drive to the operating system.

Hard disk drives can be combined together through a few different methods. The different methods are referred to as different RAID levels. Different RAID levels represent different performance levels, security levels and implementation costs. The RAID levels which the VIA VT8237 southbridge chipset supports are RAID 0, 1, and JBOD.

RAID 0 (Striping)

RAID 0 reads and writes sectors of data interleaved between multiple drives. If any disk member fails, it affects the entire array. The disk array data capacity is equal to the number of drive members times the capacity of the smallest member. The striping block size can be set from 4KB to 64KB. RAID 0 does not support fault tolerance.

RAID 1 (Mirroring)

RAID 1 writes duplicate data onto a pair of drives and reads both sets of data in parallel. If one of the mirrored drives suffers a mechanical failure or does not respond, the remaining drive will continue to function. Due to redundancy, the drive capacity of the array is the capacity of the smallest drive. Under a RAID 1 setup, an extra drive called the .spare drive. can be attached. Such a drive will be activated to replace a failed drive that is part of a mirrored array. Due to the fault tolerance, if any RAID 1 drive fails, data access will not be affected as long as there are other working drives in the array.

JBOD (Spanning)

A spanning disk array is equal to the sum of the all drives when the drives used are having different capacities. Spanning stores data onto a drive until it is full, then proceeds to store files onto the next drive in the array. When any disk member fails, the failure affects the entire array. JBOD is not really a RAID and does not support fault tolerance.

Please follow the steps below to construct a complete RAID array:

- 1) Have ready your hard drives for RAID construction.
Note: To achieve best performance, it is recommended that the hard drives used are of similar make and storage capacity.
- 2) Please attach the hard drive connectors to their appropriate location on the motherboard i.e. IDE, SCSI, or SATA.
- 3) Enter the motherboard BIOS and locate RAID setup (Please refer to the section on Integrated Peripherals).
- 4) Enter RAID setup in the BIOS and select the RAID type (For instance, enter <Tab> to select VIA RAID).
- 5) Complete driver installation.
- 6) Complete RAID utility installation.

More information on steps 4 and 5 is provided. (For more detailed setup information, please visit our website at <http://www.gigabyte.com.tw>)

Enter BIOS Configuration Utility

When the system powers on, the following information will appear on screen. Press the <Tab> key to enter BIOS configuration utility.

```
VIA Technologies,Inc. VIA VT8237 Serial ATA BIOS Setting Utility V1.20
Copyright (C) VIA Technologies, Inc. All Right reserved.
```

```
Scan Devices, Please wait...
Press <Tab> key into User Windows
Serial_Ch0 Master: ST380013AS
Serial_Ch1 Master: ST3120023AS
```

The main interface of BIOS configuration utility is as below:

VIA Technologies,Inc. VIA VT8237 Serial ATA BIOS Setting Utility V1.20

<ul style="list-style-type: none"> ▶ Create Array ▶ Delete Array ▶ Create/Delete Spare ▶ Select Boot Array ▶ SerialNumber View 	<p>Create a RAID array with the hard disks attached to VIA IDE controller</p> <p>F1 : View Array/disk Status</p> <p>↑,↓ : Move to next item</p> <p>Enter : Confirm the selection</p> <p>ESC : Exit</p>																		
<table border="1" style="width: 100%; border-collapse: collapse;"> <thead> <tr> <th>Channel</th> <th>Driver Name</th> <th>ArrayName</th> <th>Mode</th> <th>Size(GB)</th> <th>Status</th> </tr> </thead> <tbody> <tr> <td>Serial_Ch0 Master</td> <td>ST380013AS</td> <td></td> <td>SATA</td> <td>74.53</td> <td>Hdd</td> </tr> <tr> <td>Serial_Ch1 Master</td> <td>ST9120023AS</td> <td></td> <td>SATA</td> <td>111.79</td> <td>Hdd</td> </tr> </tbody> </table>		Channel	Driver Name	ArrayName	Mode	Size(GB)	Status	Serial_Ch0 Master	ST380013AS		SATA	74.53	Hdd	Serial_Ch1 Master	ST9120023AS		SATA	111.79	Hdd
Channel	Driver Name	ArrayName	Mode	Size(GB)	Status														
Serial_Ch0 Master	ST380013AS		SATA	74.53	Hdd														
Serial_Ch1 Master	ST9120023AS		SATA	111.79	Hdd														

Create Disk Array

1. Use the arrow keys to navigate the main menu. Use the up and down arrow keys to select the Create Array command and press <Enter> to call out the list of creation steps.

VIA Technologies,Inc. VIA VT8237 Serial ATA BIOS Setting Utility V1.20

▶ Auto Setup For Data Security	Create a RAID array with the hard disks attached to VIA IDE controller				
▶ Array Mode RAID 0 (Striping)	F1 : View Array/disk Status				
▶ Select Disk Drives	↑,↓ : Move to next item				
▶ Start Create Process	Enter : Confirm the selection				
	ESC : Exit				
Channel	Driver Name	ArrayName	Mode	Size(GB)	Status
Serial_Ch0 Master	ST380013AS		SATA	74.53	Hdd
Serial_Ch1 Master	ST9120023AS		SATA	111.79	Hdd

2. Select Array Mode and press <Enter>, a list of array modes will appear. Highlight the target array mode that you want to create, and press <Enter> to confirm the selection. If RAID 1 is selected, an option list will popup and enable the users to select **Create only** or **Create and duplicate**. **Create only** will allow BIOS to only create an array. The data on the mirroring drive may be different from the source drive. **Create and duplicate** lets BIOS copy the data from the source to the mirroring drive.

VIA Technologies,Inc. VIA VT8237 Serial ATA BIOS Setting Utility V1.20

▶ RAID 0 for performance	Create a RAID array with the hard disks attached to VIA IDE controller				
▶ RAID 1 for data protection	F1 : View Array/disk Status				
▶ RAID 0/1	↑,↓ : Move to next item				
▶ RAID SPAN for capacity	Enter : Confirm the selection				
	ESC : Exit				
Channel	Driver Name	ArrayName	Mode	Size(GB)	Status
Serial_Ch0 Master	ST380013AS		SATA	74.53	Hdd
Serial_Ch1 Master	ST9120023AS		SATA	111.79	Hdd

3. After array mode is selected, there are two methods to create a disk array. One method is **Auto Setup** and the other one is **Select Disk Drives**. **Auto Setup** allows BIOS to select the disk drives and create arrays automatically, but it does not duplicate the mirroring drives even if the user selected **Create and duplicate** for RAID 1. It is recommended all disk drives are new ones when wanting to create an array. **Select Disk Drives** lets the user select the array drives by their requirements. When using **Select Disk Drives**, the channel column will be activated. Highlight the target drives that you want to use and press <Enter> to select them. After all drives have been selected, press <Esc> to go back to the creation steps menu.

VIA Technologies,Inc. VIA VT8237 Serial ATA BIOS Setting Utility V1.20

<ul style="list-style-type: none"> ▶ Auto Setup For Performance ▶ Array Mode RAID 0 (Striping) ▶ Select Disk Drives ▶ Block Size 64K ▶ Start Create Process 	<p>Create a RAID array with the hard disks attached to VIA IDE controller</p> <p>F1 : View Array/disk Status</p> <p>↑,↓ : Move to next item</p> <p>Enter : Confirm the selection</p> <p>ESC : Exit</p>																		
<table border="1"> <thead> <tr> <th>Channel</th> <th>Driver Name</th> <th>ArrayName</th> <th>Mode</th> <th>Size(GB)</th> <th>Status</th> </tr> </thead> <tbody> <tr> <td>[*]Serial_Ch0 Master</td> <td>ST380013AS</td> <td></td> <td>SATA</td> <td>74.53</td> <td>Stripe0</td> </tr> <tr> <td>[*]Serial_Ch1 Master</td> <td>ST9120023AS</td> <td></td> <td>SATA</td> <td>111.79</td> <td>Stripe1</td> </tr> </tbody> </table>		Channel	Driver Name	ArrayName	Mode	Size(GB)	Status	[*]Serial_Ch0 Master	ST380013AS		SATA	74.53	Stripe0	[*]Serial_Ch1 Master	ST9120023AS		SATA	111.79	Stripe1
Channel	Driver Name	ArrayName	Mode	Size(GB)	Status														
[*]Serial_Ch0 Master	ST380013AS		SATA	74.53	Stripe0														
[*]Serial_Ch1 Master	ST9120023AS		SATA	111.79	Stripe1														

4. If user selects a RAID 0 array in step 2, the block size of the array can also be selected. Use the arrow key to highlight **Block Size** and press <Enter>, then select a block size from the popup menu. The block size can be 4KB to 64KB.

VIA Technologies,Inc. VIA VT8237 Serial ATA BIOS Setting Utility V1.20

<ul style="list-style-type: none"> ▶ Auto Setup For Performance ▶ Array Mode RAID 0 (Striping) ▶ Select Disk Drives ▶ Block Size 64K ▶ Start Create Process 	<p>4K</p> <p>8K</p> <p>16K</p> <p>32K</p> <p>64K</p>	<p>Create a RAID array with the hard disks attached to VIA IDE controller</p> <p>F1 : View Array/disk Status</p> <p>↑,↓ : Move to next item</p> <p>Enter : Confirm the selection</p> <p>ESC : Exit</p>																		
<table border="1"> <thead> <tr> <th>Channel</th> <th>Driver Name</th> <th>ArrayName</th> <th>Mode</th> <th>Size(GB)</th> <th>Status</th> </tr> </thead> <tbody> <tr> <td>[*]Serial_Ch0 Master</td> <td>ST380013AS</td> <td></td> <td>SATA</td> <td>74.53</td> <td>Stripe0</td> </tr> <tr> <td>[*]Serial_Ch1 Master</td> <td>ST9120023AS</td> <td></td> <td>SATA</td> <td>111.79</td> <td>Stripe1</td> </tr> </tbody> </table>			Channel	Driver Name	ArrayName	Mode	Size(GB)	Status	[*]Serial_Ch0 Master	ST380013AS		SATA	74.53	Stripe0	[*]Serial_Ch1 Master	ST9120023AS		SATA	111.79	Stripe1
Channel	Driver Name	ArrayName	Mode	Size(GB)	Status															
[*]Serial_Ch0 Master	ST380013AS		SATA	74.53	Stripe0															
[*]Serial_Ch1 Master	ST9120023AS		SATA	111.79	Stripe1															

5. Use the arrow key to highlight **Start Create Process** and press <Enter>. A warning message will appear, press **Y** to finish the creation, or press **N** to cancel the creation.
6. Important note: All existing content in the hard drive will be destroyed after array creation.

Delete Disk Array

A RAID can be deleted after it has been created. To delete a RAID, use the following steps:

1. Select **Delete Array** in the main menu and press <Enter>. The channel column will be activated.
2. Select the member of an array that is to be deleted and press <Enter>. A warning message will show up, press **Y** to delete or press **N** to cancel.

VIA Technologies, Inc. VIA VT8237 Serial ATA BIOS Setting Utility V1.20

▶ Create Array	Delete a RAID array contain the hard disks attached to VIA IDE controller
▶ Delete Array	F1 : View Array/disk Status
▶ Create/Delete Spare	↑,↓ : Move to next item
▶ Select Boot Array	Enter : Confirm the selection
▶ SerialNumber View	ESC : Exit

The selected array will be destoried.
Are you sure? Continue? Press Y/N

Channel	Driver Name	ArrayName	Mode	Size(GB)	Status
[*]Serial_Ch0 Master	ST380013AS		SATA	74.53	Stripe0
[*]Serial_Ch1 Master	ST9120023AS		SATA	111.79	Stripe1

Deleting a disk array will destroy all the data on the disk array except RAID 1 arrays. When a RAID is deleted, the data on these two hard disk drives will be reserved and become two normal disk drives.

Select Boot Array

User can select a disk array as boot device if user wants to boot operating system from an array. Boot disk array cannot be selected if the operating system does not boot from the disk array. Highlight the **Select Boot Array** item; press <Enter> and the channel column will be activated. Then highlight the target disk array and press <Enter>. If user selects a disk array that has a boot mark and press <Enter>, its boot setting will be canceled.

VIA Technologies, Inc. VIA VT8237 Serial ATA BIOS Setting Utility V1.20

▶ Create Array	Set/Clear bootable array
▶ Delete Array	F1 : View Array/disk Status
▶ Create/Delete Spare	↑,↓ : Move to next item
▶ Select Boot Array	Enter : Confirm the selection
▶ SerialNumber View	ESC : Exit

Channel	Driver Name	ArrayName	Mode	Size(GB)	Status
[*]Serial_Ch0 Master	ST380013AS		SATA	74.53	Stripe0
[*]Serial_Ch1 Master	ST9120023AS		SATA	111.79	Stripe1

View Serial Number of Hard Drive

Highlight **Serial Number View** and press <Enter>. Use arrow key to select a drive, the selected drive's serial number can be viewed in the last column. The serial number is assigned by the disk drive manufacturer.

View Array Status

Press the **F1** key to show the array status on the lower screen. If there are no disk arrays then nothing will be displayed on the screen.

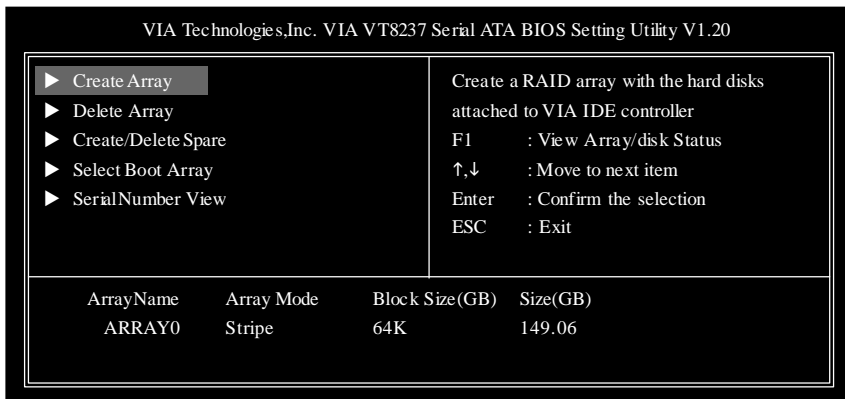

C. Installing the RAID drivers

For the Windows operating system (Win NT, WinXP, Win2000), for IDE RAID/SCSI/SerialATA functioning, the driver must first be transferred to a floppy disk. Please follow the steps below to complete driver transfer to a floppy disk:

- 1) Please insert the provided driver CD into the hard disk drive eg. Drive D:
- 2) Insert a blank formatted floppy disk into the floppy disk drive.
- 3) Either from "Command Prompt" or DOS, please type in "D:\BootDrv\menu.exe"(Refer to Fig.1)
- 4) Information on all chipsets should be listed on the screen (Refer to Fig.2), please select the proper chipset model.

Fig.1

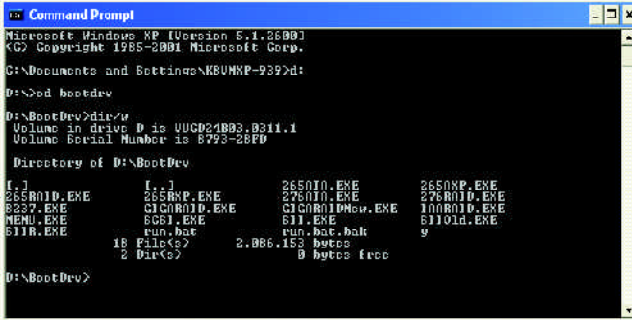

```

Microsoft Windows XP [Version 5.1.2600]
(C) Copyright 1985-2001 Microsoft Corp.
C:\Documents and Settings\KBUMWP-939>d:
D:\>cd bootdev
D:\BootDev>dir /v
Volume in drive D is UUGD24B03.B311.1
Volume Serial Number is 8793-28FD

Directory of D:\BootDev

[.]           [.]           265010.EXE       2650NP.EXE
8237.EXE     CIGAR10D.EXE   276010.EXE       276010D.EXE
MENU.EXE     C031.EXE       3111.EXE         311010D.EXE
511b.EXE     run.bat        run.bat.bak     y
             18 File(s)     2,086,153 bytes
             2 Dir(s)     0 bytes free

D:\BootDev>

```

Fig.2

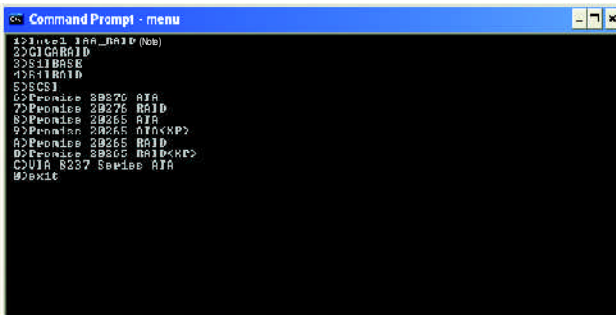

```

Microsoft Windows XP [Version 5.1.2600]
(C) Copyright 1985-2001 Microsoft Corp.
C:\Documents and Settings\KBUMWP-939>cd bootdev
D:\BootDev>menu.exe
I:\>cd I:\IAA_RAID (nob)
2)GIGAR10
3)SILIBASE
4)S11RA10
5)SCSI
6)Pentium 26570 ATA
7)Pentium 26276 RAID
8)Pentium 26265 ATA
9)Pentium 26265 ATA<XP>
A)Pentium 26265 RAID
B)Pentium 26265 RAID<XP>
C)UIA 5237 Serial ATA
D)exit

```

Your system will then automatically zip and transfer this driver file to the floppy disk.

After you complete the steps, boot from the Windows CD to install the RAID drivers.

When install Windows 2000 or Windows XP from HDDs in serial ATA controller, press **F6** as Win2000 or XP boots up, then supply serial ATA controller driver by this floppy disk. Follow on-screen instructions to complete installation.

(Each time you add a new hard drive to a RAID array, the RAID driver will have to be installed under Windows once for that hard drive. After that, the driver will not have to be installed.)

Note: In the menu list, IAA_RAID is Intel ICH5R chipset.



Driver installation finished !
You have to reboot system !

Item Description

- VIA 4IN1 Driver
VIA Chipset Driver
- VIA K8M800 VGA Driver
VIA VGA Driver
- USB Patch for WinXP
This patch driver can help you to resolve the USB device wake up S3 hang up issue in XP.
- Realtek Lan Driver
RealTek 10/100 LAN driver
- RealTek AC97 Codec Driver
Realtek Audio Driver
- VIA 8237 Serial ATA Driver
For VIA 8237 SATA Driver
- VIA USB 2.0 Controller
VIA USB 2.0 Host Controller use the inbox driver in Service Pack 1
Please upgrade to Windows XP Service Pack 1 and rescan for hardware change in Device Manage.



For USB2.0 driver support under Windows XP operating system, please use Windows Service Pack. After install Windows Service Pack, it will show a question mark "?" in "Universal Serial Bus controller" under "Device Manager". Please remove the question mark and restart the system (System will auto-detect the right USB2.0 driver).

SOFTWARE APPLICATION

This page reveals the value-added software developed by Gigabyte and its worldwide partners.

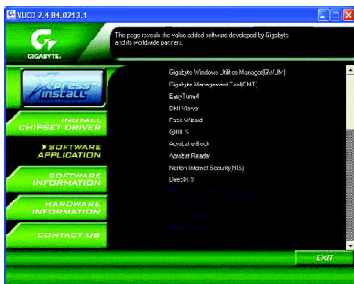

- **Gigabyte Windows Utilities Manager (GWUM)**
This utility can integrate the Gigabyte's applications in the system tray
- **Gigabyte Management Tool (GMT)**
A useful tool which can manage the computer via the network
- **EasyTune 4**
Powerful utility that integrates the overclocking and hardware monitoring functions
- **DMI Viewer**
Windows based utility which is used to browse the DMI/SMBIOS information of the system
- **Face-Wizard**
New utility for adding BIOS logo
- **@BIOS**
Gigabyte windows flash BIOS utility
- **Acrobat e-Book**
Useful utility from Adobe
- **Acrobat Reader**
Popular utility from Adobe for reading .PDF file format documents
- **Norton Internet Security (NIS)**
Integrated utility which includes anti-virus, ads, etc.
- **DirectX 9.0**
Install Microsoft DirectX 9 to enable 3D hardware acceleration that support for operating system to achieve better 3D performance.

FAQ

Below is a collection of general asked questions. To check general asked questions based on a specific motherboard model, please log on to <http://tw.giga-byte.com/faq/faq.htm>

Question 1: I cannot see some options that were included in previous BIOS after updating BIOS. Why?

Answer: Some advanced options are hidden in new BIOS version. Please press Ctrl and F1 keys after entering BIOS menu and you will be able to see these options.

Questions 2: Why is the light of my keyboard/optical mouse still on after computer shuts down?

Answer: In some boards, a small amount of electricity is kept on standby after computer shuts down and that's why the light is still on.

Question 3: Why cannot I use all functions in EasyTune™ 4?

Answer: The availability of the listed functions in EasyTune™ 4 depends on the MB chipset. If the chipset doesn't support certain functions in EasyTune™ 4, these functions will be locked automatically and you will not be able to use them.

Question 4: Why do I fail to install RAID and ATA drivers under Win 2000 and XP on boards that support RAID function after I connect the boot HDD to IDE3 or IDE4 ?

Answer: First of all, you need to save some files in the CD-ROM to a floppy disk before installing drivers. You also need to go through some rather different steps in the installation process. Therefore, we suggest that you refer to the installation steps in the RAID manual at our website.

(Please download it at http://tw.giga-byte.com/support/user_pdf/raid_manual.pdf)

Question 5: How do I clear CMOS?

Answer: If your board has a Clear CMOS jumper, please refer to the Clear CMOS steps in the manual. If your board doesn't have such jumper, you can take off the on-board battery to leak voltage to clear CMOS. Please refer to the steps below:

Steps:

1. Turn off power.
2. Disconnect the power cord from MB.
3. Take out the battery gently and put it aside for about 10 minutes (Or you can use a metal object to connect the positive and negative pins in the battery holder to make them short for one minute).
4. Re-insert the battery to the battery holder.
5. Connect power cord to MB again and turn on power.
6. Press Del to enter BIOS and load Fail-Safe Defaults.
7. Save changes and reboot the system.

Question 6: Why does system seem unstable after updating BIOS?

Answer: Please remember to load Fail-Safe Defaults (Or Load BIOS Defaults) after flashing BIOS. However, if the system instability still remains, please clear CMOS to solve the problem.

Question 7: Why do I still get a weak sound after turning up the speaker to the maximum volume?

Answer: Please make sure the speaker you are using is equipped with an internal amplifier. If not, please change another speaker with power/amplifier and try again later.

Question 8: How do I disable onboard VGA card in order to add an external VGA card?

Answer: Gigabyte motherboards will auto-detect the external VGA card after it is plugged in, so you don't need to change any setting manually to disable the onboard VGA.

Question 9: Why cannot I use the IDE 2?

Answer: Please refer to the user manual and check whether you have connected any cable that is not provided with the motherboard package to the USB Over Current pin in the Front USB Panel. If the cable is your own cable, please remove it from this pin and do not connect any of your own cables to it.

Question 10: Sometimes I hear different continuous beeps from computer after system boots up. What do these beeps usually stand for?

Answer: The beep codes below may help you identify the possible computer problems. However, they are only for reference purposes. The situations might differ from case to case.

→ AMI BIOS Beep Codes

*Computer gives 1 short beep when system boots successfully.

*Except for beep code 8, these codes are always fatal.

- 1 beep Refresh failure
- 2 beeps Parity error
- 3 beeps Base 64K memory failure
- 4 beeps Timer not operational
- 5 beeps Processor error
- 6 beeps 8042 - gate A20 failure
- 7 beeps Processor exception interrupt error
- 8 beeps Display memory read/write failure
- 9 beeps ROM checksum error
- 10 beeps CMOS shutdown register read/write error
- 11 beeps Cache memory bad

→ AWARD BIOS Beep Codes

- 1 short: System boots successfully
- 2 short: CMOS setting error
- 1 long 1 short: DRAM or M/B error
- 1 long 2 short: Monitor or display card error
- 1 long 3 short: Keyboard error
- 1 long 9 short: BIOS ROM error
- Continuous long beeps: DRAM error
- Continuous short beeps: Power error

Question 11: How to set in the BIOS in order to bootup from SATA HDDs by either RAID or ATA mode?

Answer: Please set in the BIOS as follow:

1. Advanced BIOS features--> SATA/RAID/SCSI boot order: "SATA"
2. Advanced BIOS features--> First boot device: "SCSI"
3. Integrated Peripherals--> Onboard H/W Serial ATA: "enable"

Then it depends on the SATA mode that you need to set "RAID" to RAID mode or "BASE" to normal ATA mode in the item named Serial ATA function.

Question 12: For the M/B which have RAID function, how to set in the BIOS in order to bootup from IDE3, 4 by either RAID or ATA mode?

Answer: Please set in the BIOS as follow:

1. Advanced BIOS features-->(SATA)/RAID/SCSI boot order: "SATA"
2. Advanced BIOS features--> First boot device: "SCSI"
3. Integrated Peripherals--> Onboard H/W ATA/RAID: "enable"

Then it depends on the RAID mode that you need to set "RAID" to RAID mode or "ATA" to normal ATA mode in the item named RAID controller function.

Question 13: How to set in the BIOS to bootup from the IDE/ SCSI/ RAID card ?

Answer: Please set in the BIOS as follow:

1. Advanced BIOS features-->(SATA)/RAID/SCSI boot order: "SCSI"
2. Advanced BIOS features--> First boot device: "SCSI"

Then it depends on the mode(RAID or ATA) that you need to set in RAID/ SCSI BIOS.

Troubleshooting



If you encounter any trouble during boot up, please follow the troubleshooting procedures.

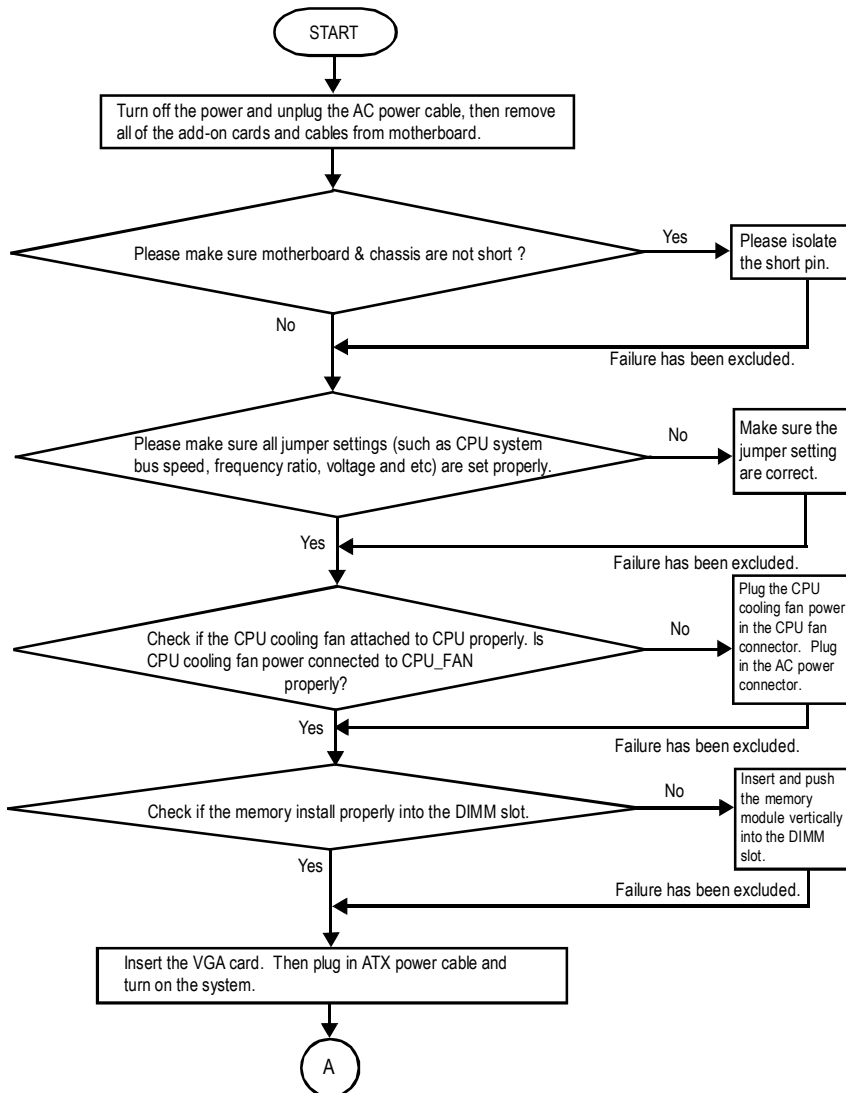

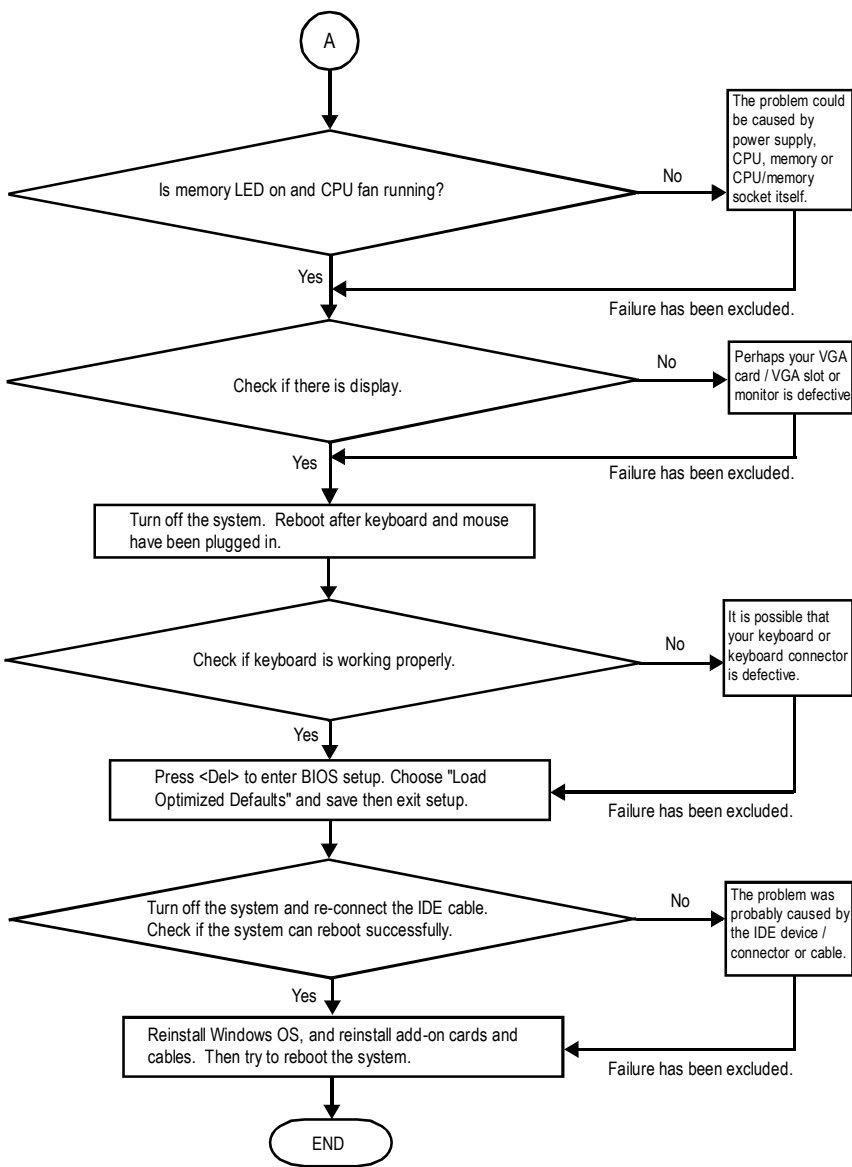

If the above procedure unable to solve your problem, please contact with your local retailer or national distributor for help. Or, you could submit your question to the service mail via Gigabyte website technical support zone (<http://www.gigabyte.com.tw>). The appropriate response will be provided ASAP.

Technical Support/RMA Sheet

Customer/Country:	Company:	Phone No.:
Contact Person:	E-mail Add. :	

Model name/Lot Number:	PCB revision:
BIOS version:	O.S./A.S.:

Hardware Configuration	Mfs.	Model name	Size:	Driver/Utility:
CPU				
Memory				
Brand				
Video Card				
Audio Card				
HDD				
CD-ROM / DVD-ROM				
Modem				
Network				
AMR / CNR				
Keyboard				
Mouse				
Power supply				
Other Device				

Problem Description:

Acronyms

Acronyms	Meaning
ACPI	Advanced Configuration and Power Interface
APM	Advanced Power Management
AGP	Accelerated Graphics Port
AMR	Audio Modem Riser
ACR	Advanced Communications Riser
BIOS	Basic Input / Output System
CPU	Central Processing Unit
CMOS	Complementary Metal Oxide Semiconductor
CRIMM	Continuity RIMM
CNR	Communication and Networking Riser
DMA	Direct Memory Access
DMI	Desktop Management Interface
DIMM	Dual Inline Memory Module
DRM	Dual Retention Mechanism
DRAM	Dynamic Random Access Memory
DDR	Double Data Rate
ECP	Extended Capabilities Port
ESCD	Extended System Configuration Data
ECC	Error Checking and Correcting
EMC	Electromagnetic Compatibility
EPP	Enhanced Parallel Port
ESD	Electrostatic Discharge
FDD	Floppy Disk Device
FSB	Front Side Bus
HDD	Hard Disk Device
IDE	Integrated Dual Channel Enhanced
IRQ	Interrupt Request

to be continued.....

Acronyms	Meaning
IOAPIC	Input Output Advanced Programmable Input Controller
ISA	Industry Standard Architecture
LAN	Local Area Network
I/O	Input / Output
LBA	Logical Block Addressing
LED	Light Emitting Diode
MHz	Megahertz
MIDI	Musical Instrument Digital Interface
MTH	Memory Translator Hub
MPT	Memory Protocol Translator
NIC	Network Interface Card
OS	Operating System
OEM	Original Equipment Manufacturer
PAC	PCI A.G.P. Controller
POST	Power-On Self Test
PCI	Peripheral Component Interconnect
RIMM	Rambus in-line Memory Module
SCI	Special Circumstance Instructions
SECC	Single Edge Contact Cartridge
SRAM	Static Random Access Memory

CONTACT US

Contact us via the information in this page all over the world.

• Taiwan

Gigabyte Technology Co., Ltd.
 Address: No.6, Bau Chiang Road, Hsin-Tien, Taipei Hsien, Taiwan, R.O.C.
 Tel: 886 (2) 8912-4888
 Fax: 886 (2) 8912-4003
 Tech. Support:
<http://tw.giga-byte.com/TechSupport/ServiceCenter.htm>
 Non-Tech. Support (Sales/Marketing issues):
<http://ggts.gigabyte.com.tw/nontech.asp>
 Website: <http://www.gigabyte.com.tw>

• USA

G.B.T. INC.
 Address: 17358 Railroad St, City of Industry, CA 91748.
 Tel: 1 (626) 854-9338
 Fax: 1 (626) 854-9339
 Tech. Support:
<http://www.giga-byte.com/TechSupport/ServiceCenter.htm>
 Non-Tech. Support (Sales/Marketing issues):
<http://ggts.gigabyte.com.tw/nontech.asp>
 Website: <http://www.giga-byte.com>

• Germany

G.B.T. Technology Trading GmbH
 Tel: 49-40-2533040
 49-01803-428468 (Tech.)
 Fax: 49-40-25492343 (Sales)
 49-01803-428329 (Tech.)
 Tech. Support:
<http://de.giga-byte.com/TechSupport/ServiceCenter.htm>
 Non-Tech. Support (Sales/Marketing issues):
<http://ggts.gigabyte.com.tw/nontech.asp>
 Website: <http://www.gigabyte.de>

• Japan

Nippon Giga-Byte Corporation
 Website: <http://www.gigabyte.co.jp>

• U.K

G.B.T. TECH. CO. LTD.
 Tel: 44-1908-362700
 Fax: 44-1908-362709
 Tech. Support:
<http://uk.giga-byte.com/TechSupport/ServiceCenter.htm>
 Non-Tech. Support (Sales/Marketing issues):
<http://ggts.gigabyte.com.tw/nontech.asp>
 Website: <http://uk.giga-byte.com>

• The Netherlands

Giga-Byte Technology B.V.
 Address: Verdunplein 8 5627 SZ, Eindhoven, The Netherlands
 Tel: +31 40 290 2088
 NL Tech.Support: 0900-GIGABYTE (0900-44422983, ☎ 0.2M)
 BE Tech.Support: 0900-84034 (☎ 0.4/M)
 Fax: +31 40 290 2089
 Tech. Support:
<http://nz.giga-byte.com/TechSupport/ServiceCenter.htm>
 Non-Tech. Support (Sales/Marketing issues):
<http://ggts.gigabyte.com.tw/nontech.asp>
 Website: <http://www.giga-byte.nl>

• China

NINGBO G.B.T. Tech. Trading CO., Ltd.
 Tech. Support:
<http://cn.giga-byte.com/TechSupport/ServiceCenter.htm>
 Non-Tech. Support (Sales/Marketing issues):
<http://ggts.gigabyte.com.tw/nontech.asp>
 Website: <http://www.gigabyte.com.cn>
Beijing
 Tel: 86-10-82856054, 86-10-82856064, 86-10-82856094
 Fax: 86-10-82856575
Chengdu
 Tel: 86-28-85236930
 Fax: 86-28-85256822
GuangZhou
 Tel: 86-20-87586273
 Fax: 86-20-87544306
Shanghai
 Tel: 86-21-64737410
 Fax: 86-21-64453227
Shenyang
 Tel: 86-24-23960918, 86-24-23960893
Wuhan
 Tel: 86-27-87854385, 86-27-87854802
 Fax: 86-27-87854031
Xian
 Tel: 86-29-5531943
 Fax: 86-29-5539821

Free Manuals Download Website

<http://myh66.com>

<http://usermanuals.us>

<http://www.somanuals.com>

<http://www.4manuals.cc>

<http://www.manual-lib.com>

<http://www.404manual.com>

<http://www.luxmanual.com>

<http://aubethermostatmanual.com>

Golf course search by state

<http://golfingnear.com>

Email search by domain

<http://emailbydomain.com>

Auto manuals search

<http://auto.somanuals.com>

TV manuals search

<http://tv.somanuals.com>