

GA-K8NS Ultra-939

AMD Socket 939 Processor Motherboard

User's Manual

Rev. 1002

12ME-K8NSU939-1002

Copyright

© 2004 GIGABYTE TECHNOLOGY CO., LTD

Copyright by **GIGA-BYTE TECHNOLOGY CO., LTD. ("GBT")**. No part of this manual may be reproduced or transmitted in any form without the expressed, written permission of **GBT**.

Trademarks

Third-party brands and names are the property of their respective owners.

Notice

Please do not remove any labels on motherboard, this may void the warranty of this motherboard.

Due to rapid change in technology, some of the specifications might be out of date before publication of this booklet.

The author assumes no responsibility for any errors or omissions that may appear in this document nor does the author make a commitment to update the information contained herein.

Declaration of Conformity

We, Manufacturer/Importer
(full address)

G.B.T. Technology Trading GmbH
Ausschlagler Weg 41, 1F 20537 Hamburg, Germany

declare that the product
(description of the apparatus, system, installation to which it refers)

Mother Board

GA-K8NS Ultra-939

is in conformity with
(reference to the specification under which conformity is declared)
in accordance with 89/336 EEC-EMC Directive

- | | | | |
|--|--|---|---|
| <input type="checkbox"/> EN 55011 | Limits and methods of measurement of radio disturbance characteristics of industrial, scientific and medical (ISM) high frequency equipment | <input checked="" type="checkbox"/> EN 61000-3-2 | Disturbances in supply systems caused |
| <input type="checkbox"/> EN 55013 | Limits and methods of measurement of radio disturbance characteristics of broadcast receivers and associated equipment | <input checked="" type="checkbox"/> EN 61000-3-3 | Disturbances in supply systems caused by household appliances and similar electrical equipment "Voltage fluctuations" |
| <input type="checkbox"/> EN 55014-1 | Limits and methods of measurement of radio disturbance characteristics of household electrical appliances, portable tools and similar electrical apparatus | <input type="checkbox"/> EN 55024 | Information Technology equipment-Immunity characteristics-Limits and methods of measurement |
| <input type="checkbox"/> EN 55015 | Limits and methods of measurement of radio disturbance characteristics of fluorescent lamps and luminaires | <input type="checkbox"/> EN 50082-1 | Generic immunity standard Part 1: Residual, commercial and light industry |
| <input type="checkbox"/> EN 55020 | Immunity from radio interference of broadcast receivers and associated equipment | <input type="checkbox"/> EN 50082-2 | Generic immunity standard Part 2: Industrial environment |
| <input checked="" type="checkbox"/> EN 55022 | Limits and methods of measurement of radio disturbance characteristics of information technology equipment | <input type="checkbox"/> EN 55014-2 | Immunity requirements for household appliances tools and similar apparatus |
| <input type="checkbox"/> DIN VDE 0855 part 10 | Cabled distribution systems; Equipment for receiving and/or distribution from sound and television signals | <input type="checkbox"/> EN 50091-2 | EMC requirements for uninterruptible power systems (UPS) |
| <input type="checkbox"/> part 12 | | | |

CE marking



(EC conformity marking)

The manufacturer also declares the conformity of above mentioned product with the actual required safety standards in accordance with LVD 73/23 EEC

- | | | | |
|--|---|--|---|
| <input type="checkbox"/> EN 60065 | Safety requirements for mains operated electronic and related apparatus for household and similar general use | <input type="checkbox"/> EN 60950 | Safety for information technology equipment including electrical business equipment |
| <input type="checkbox"/> EN 60335 | Safety of household and similar electrical appliances | <input type="checkbox"/> EN 50091-1 | General and Safety requirements for uninterruptible power systems (UPS) |

Manufacturer/Importer

Signature : Timmy Huang

(Stamp)

Date : Oct. 7, 2004

Name : Timmy Huang

DECLARATION OF CONFORMITY

Per FCC Part 2 Section 2.1077(a)



Responsible Party Name: G.B.T. INC. (U.S.A.)

**Address: 17358 Railroad Street
City of Industry, CA 91748**

Phone/Fax No: (818) 854-9338/ (818) 854-9339

hereby declares that the product

Product Name: Motherboard

Model Number: GA-K8NS Ultra-939

Conforms to the following specifications:

FCC Part 15, Subpart B, Section 15.107(a) and Section 15.109
(a), Class B Digital Device

Supplementary Information:

This device complies with part 15 of the FCC Rules. Operation is subject to the following two conditions: (1) This device may not cause harmful and (2) this device must accept any interference received, including that may cause undesired operation.

Representative Person's Name: ERIC LU

Signature: Eric Lu

Date: Oct. 7, 2004



Read Me First!

When you installing AGP card, please make sure the following notice is fully understood and practiced. If your AGP card has "AGP 4X/8X (1.5V) notch" (show below), please make sure your AGP card is AGP 4X/8X.



Caution: AGP 2X card is not supported by nVIDIA® nForce3™ Ultra. You might experience system unable to boot up normally. Please insert an AGP 4X/8X card.

WARNING: *Never run the processor without the heatsink properly and firmly attached. PERMANENT DAMAGE WILL RESULT!*

Mise en garde : *Ne faites jamais tourner le processeur sans que le dissipateur de chaleur soit fixé correctement et fermement. UN DOMMAGE PERMANENT EN RÉSULTERA !*

Achtung: *Der Prozessor darf nur in Betrieb genommen werden, wenn der Wärmeableiter ordnungsgemäß und fest angebracht ist. DIES HAT EINEN PERMANENTEN SCHADEN ZUR FOLGE!*

Advertencia: *Nunca haga funcionar el procesador sin el disipador de calor instalado correctamente y firmemente. ¡SE PRODUCIRÁ UN DAÑO PERMANENTE!*

Aviso: *Nunca execute o processador sem o dissipador de calor estar adequado e firmemente conectado. O RESULTADO SERÁ UM DANO PERMANENTE!*

警告: 將散熱板牢固地安裝到處理器上之前，不要運行處理器。過熱將永遠損壞處理器！

警告: 將散熱器牢固地安裝到處理器上之前，不要運行處理器。過熱將永遠損壞處理器！

경고: 히트싱크를 제대로 또 단단히 부착시키지 않은 채 프로세서를 구동시키지 마십시오. 영구적 고장이 발생합니다!

警告: 永久的な損傷を防ぐため、ヒートシンクを正しくしっかりと取り付けるまでは、プロセッサを動作させないようにしてください。

Prepare your computer...

Computer motherboards and expansion cards contain very delicate Integrated Circuit (IC) chips. To protect them against damage from static electricity, you should follow some precautions whenever you work on your computer.

1. Unplug your computer when working on the inside.
2. Use a grounded wrist strap before handling computer components. If you do not have one, touch both of your hands to a safely grounded object or to a metal object, such as the power supply case.
3. Hold components by the edges and try not touch the IC chips, leads or connectors, or other components.
4. Place components on a grounded antistatic pad or on the bag that came with the components whenever the components are separated from the system.
5. Ensure that the ATX power supply is switched off before you plug in or remove the ATX power connector on the motherboard.

Installing the motherboard to the chassis...

If the motherboard has mounting holes, but they don't line up with the holes on the base and there are no slots to attach the spacers, do not become alarmed you can still attach the spacers to the mounting holes. Just cut the bottom portion of the spacers (the spacer may be a little hard to cut off, so be careful of your hands). In this way you can still attach the motherboard to the base without worrying about short circuits. Sometimes you may need to use the plastic springs to isolate the screw from the motherboard PCB surface, because the circuit wire may be near by the hole. Be careful, don't let the screw contact any printed circuit write or parts on the PCB that are near the fixing hole, otherwise it may damage the board or cause board malfunctioning.

Table of Contents

Read Me First!	4
Chapter 1 Introduction	8
Features Summary	8
GA-K8NS Ultra-939 Motherboard Layout	10
Block Diagram	11
Chapter 2 Hardware Installation Process	13
Step 1: Install the Central Processing Unit (CPU)	14
Step 2: Install Memory Modules	16
Step 3: Install Expansion Cards	18
Step 4: Install I/O Peripherals Cables	19
Step 4-1: I/O Back Panel Introduction	19
Step 4-2: Connectors Introduction	21
Chapter 3 BIOS Setup	35
The Main Menu (For example: BIOS Ver. : E1)	36
Standard CMOS Features	38
Advanced BIOS Features	40
Integrated Peripherals	42
Power Management Setup	46
PnP/PCI Configurations	48
PC Health Status	49
MB Intelligent Tweaker(M.I.T.)	50

Top Performance	51
Select Language	51
Load Optimized Defaults	52
Set Supervisor/User Password	52
Exit Without Saving	53
Save & Exit Setup	53
Chapter 4 Technical Reference	55
@BIOS™ Introduction	55
Flash BIOS Method Introduction	56
2- / 4- / 6- / 8- Channel Audio Function Introduction	63
Jack-Sensing and UAJ Introduction	69
Xpress Recovery Introduction	71
Serial ATA BIOS Setting Utility Introduction	74
Chapter 5 Appendix	81

Chapter 1 Introduction

Features Summary

CPU	<ul style="list-style-type: none"> • Socket 939 for AMD Althlon™ 64 / 64FX processor (K8) • 2000MHz system bus • Supports core frequencies in excess of 3000+ and faster
Chipset	<ul style="list-style-type: none"> • nVIDIA® nForce3™ Ultra
Memory	<ul style="list-style-type: none"> • 4 184-pin DDR DIMM sockets, support up to 4GB DRAM (Max.)^(Note 1) • Supports Dual Channel DDR400/333/266/200 DIMM
Slots	<ul style="list-style-type: none"> • 1 AGP slot supports 8X/4X(1.5V) mode • 5 PCI slots
IDE Connections	<ul style="list-style-type: none"> • 2 IDE connection (UDMA 33/ATA 66/ATA 100/ATA 133), allows connection of 4 IDE devices
FDD Connections	<ul style="list-style-type: none"> • 1 FDD connection, allows connection of 2 FDD devices
Onboard SATA	<ul style="list-style-type: none"> • 4 Serial ATA connectors • 2 ports from nVIDIA® nForce3™ Ultra controller (SATA0_SB, SATA1_SB); 2 ports from SiI3512 controller (SATA0_SII, SATA1_SII)
Peripherals	<ul style="list-style-type: none"> • 1 parallel port supporting Normal/EPP/ECP mode • 2 Serial ports (COMA & COMB) • 8 USB 2.0/1.1 ports (rear x 4, front x 4 via cable) • 3 IEEE1394b ports (requires cable) • 1 front audio connector • 1 IrDA connector for IR/CIR • 1 PS/2 keyboard port • 1 PS/2 mouse port
Onboard LAN	<ul style="list-style-type: none"> • Onboard Marvell 8001 chip (10/100/1000 Mbit) (LAN1) • Onboard ICS 1883 chip (10/100 Mbit)(LAN2) • 2 RJ45 ports

to be continued...

(Note 1) Due to standard PC architecture, a certain amount of memory is reserved for system usage and therefore the actual memory size is less than the stated amount. For example, 4 GB of memory size will instead be shown as 3.xxGB memory during system startup.

Onboard Audio	<ul style="list-style-type: none"> • ALC850 CODEC (UAJ) • Supports Jack Sensing function • Supports 2 / 4 / 6 / 8 channel audio • Supports Line In/ Line Out/ MIC connection • Surround Back Speaker (by optional Surround-Kit) • SPDIF In / Out • CD In / Game connector
Onboard SATA RAID (SATA0_SB, SATA1_SB)	<ul style="list-style-type: none"> • Onboard nVIDIA® nForce3™ Ultra chipset • Supports data striping (RAID 0) or mirroring (RAID 1) function • Supports data transfer rate of up 150 MB • Supports a maximum of 2 SATA connections
On-Board SATA RAID (SATA0_SII, SATA1_SII)	<ul style="list-style-type: none"> • Onboard Silicon Image Sil3512 chipset • Supports data striping (RAID 0) or mirroring (RAID 1) function • Supports data transfer rate of up 150 MB • Supports hot plugging function • Supports a maximum of 2 SATA connections
I/O Control	<ul style="list-style-type: none"> • IT8712
Hardware Monitor	<ul style="list-style-type: none"> • CPU / System / Power fan speed detection • CPU / System / Power fan failure warning • CPU temperature detection • CPU warning temperature • System voltage detection • CPU smart fan control • Thermal shutdown function
BIOS	<ul style="list-style-type: none"> • Use of licensed AWARD BIOS • Supports Dual BIOS/Q-Flash, Multi-Language BIOS
Additional Features	<ul style="list-style-type: none"> • Supports @BIOS • Supports EasyTune
Overclocking	<ul style="list-style-type: none"> • Over voltage via BIOS (CPU/DDR/AGP/HT-Link) • Over clock via BIOS (CPU/AGP)
Form Factor	<ul style="list-style-type: none"> • ATX size form factor; 30.5cm x 24.4cm

GA-K8NS Ultra-939 Motherboard Layout

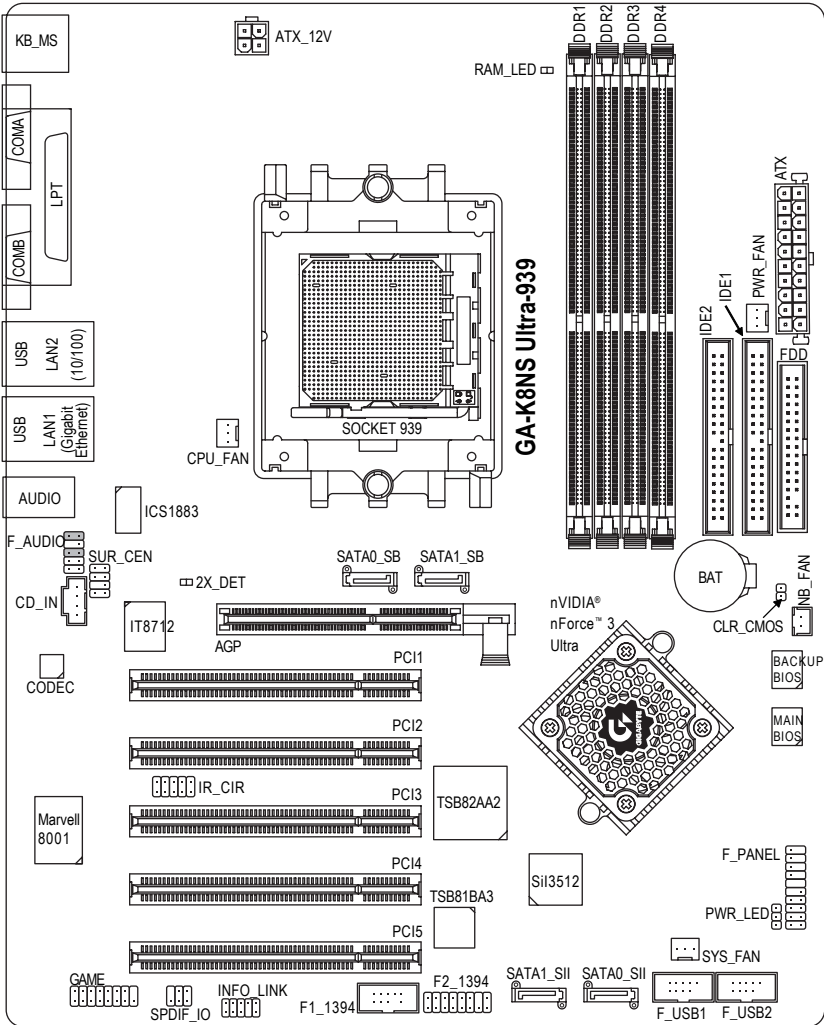

Block Diagram

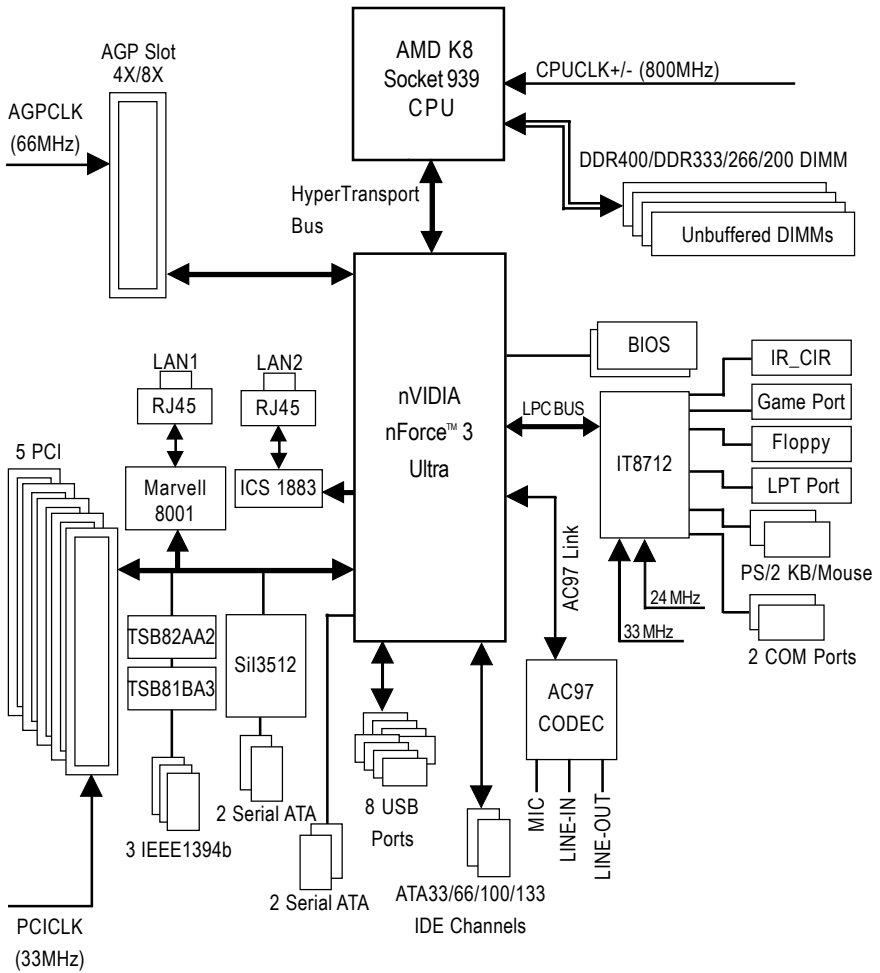

Lined writing area with 22 horizontal lines.

Chapter 2 Hardware Installation Process

To set up your computer, you must complete the following steps:

- Step 1 - Install the Central Processing Unit (CPU)
- Step 2 - Install Memory Modules
- Step 3 - Install Expansion Cards
- Step 4 - Install I/O Peripherals Cables

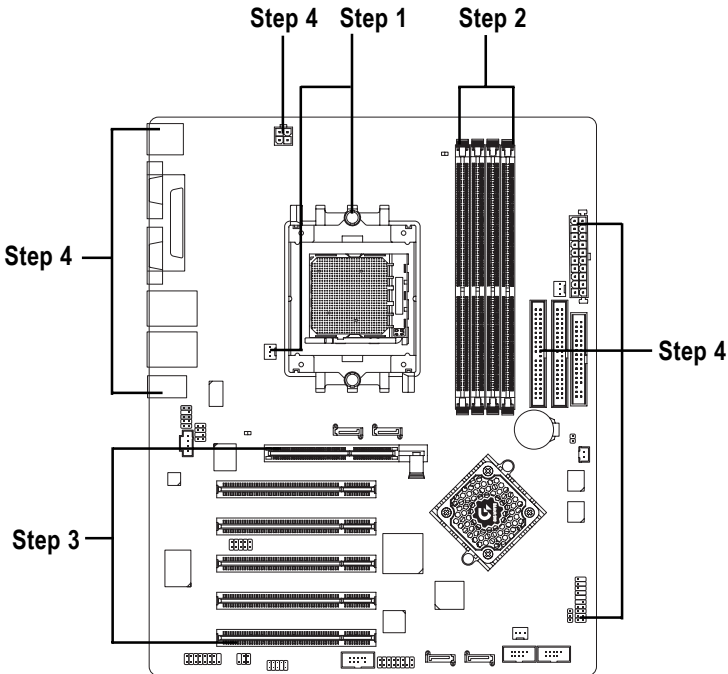

Congratulations! You have accomplished the hardware installation!

Turn on the power supply or connect the power cable to the power outlet. Continue with the BIOS/software installation.

Step 1: Install the Central Processing Unit (CPU)

Before installing the processor and cooling fan, adhere to the following warning:



1. Please make sure the CPU type is supported by the motherboard.
2. The processor will overheat without the heatsink and/or fan, resulting in permanent irreparable damage.
3. If you do not match the CPU socket Pin 1 and CPU cut edge well, it will cause improper installation. Please change the insert orientation.
4. Apply thermal grease between the processor and cooling fan.
5. Never run the processor without the heatsink properly and firmly attached. Permanent damage will result.
6. Please set the CPU host frequency in accordance with your processor's specifications. We don't recommend you to set the system bus frequency over the CPU's specification because these specific bus frequencies are not the standard specifications for CPU, chipset and most of the peripherals. Whether your system can run under these specific bus frequencies properly will depend on your hardware configurations, including CPU, Memory, Cards...etc.

The installation of the processor and cooling fan is performed in four main steps:

Step1-1. First, check the processor pins to see that none are bent. Move the socket lever to the unlocked position as shown in Figure 1.(90° to the plane of the motherboard) prior to inserting the processor. The pin 1 location is designated on the processor by a copper triangle that matches up to a triangle on the socket as shown in Figure 2. Align the processor to the socket and gently lower it into place. Do not force the processor into the socket.

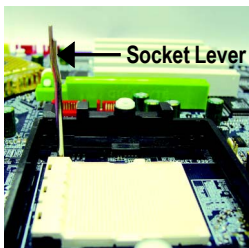

Figure 1.
Pull the lever to the 90-degree directly.

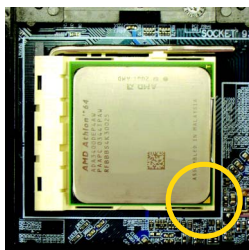

Figure 2.
Pin 1 location on the Socket and Processor. Move the socket lever to the locked position while holding pressure on the center of the processor.

Step1-2. When the processor is installed in the socket, apply thermal grease to the processor(as shown in Figure 3) prior to installing the heatsink. Phase change materials develop strong adhesive forces between the heatsink and processor. **Removing the heatsink under such conditions can cause the processor to be removed from the socket without moving the socket lever to the unlocked position and then damage the processor pins or socket contacts.**

** We recommend you to apply the thermal tape to provide better heat conduction between your CPU and heatsink. (The CPU cooling fan might stick to the CPU due to the hardening of the thermal paste. During this condition if you try to remove the cooling fan, you might pull the processor out of the CPU socket along with the cooling fan, and might damage the processor. To avoid this from happening, we suggest you to either use thermal tape instead of thermal paste, or remove the cooling fan with extreme caution.)



Figure 3.
Application of thermal grease to the processor.

Step 1-3. Once the thermal grease has been applied to the processor, the heatsink can be attached to the processor. Align the heatsink assembly with the support frame mating with the backer plate standoffs as shown in Figure 4 & 5.

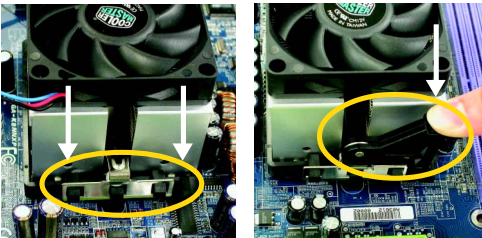

Figure 4 & 5.
Alignment of heatsink assembly with standoffs.

Step 1-4. Connect the fan power wires to the header on the motherboard as shown in Figure 6.

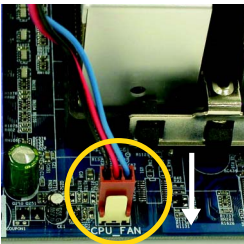

Figure 6.
Connecting the fan power wires.

Step 2: Install Memory Modules



CAUTION

Before installing the memory modules, adhere to the following warning:

1. When RAM LED is ON, do not install / remove DIMM from socket.
2. Please note that the DIMM module can only fit in one direction due to the notch. Wrong orientation will cause improper installation. Please change the insert orientation.

The motherboard has 4 dual inline memory module (DIMM) sockets. The BIOS will automatically detects memory type and size. To install the memory module, just push it vertically into the DIMM socket. The DIMM module can only fit in one direction due to the notch. Memory size can vary between sockets.

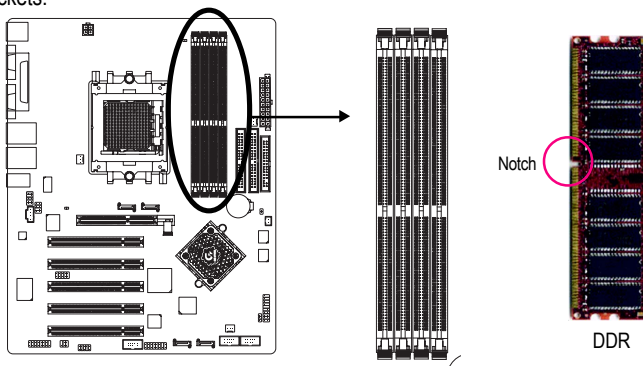

1. The DIMM socket has a notch, so the DIMM memory module can only fit in one direction.



2. Insert the DIMM memory module vertically into the DIMM socket. Then push it down.



3. Close the plastic clip at both edges of the DIMM sockets to lock the DIMM module. Reverse the installation steps when you wish to remove the DIMM module.

Dual Channel DDR:

GA-K8NS Ultra-939 supports Dual Channel Technology.

When Dual Channel Technology is activated, the bandwidth of memory bus will be double the original one, with the fastest speed at 6.4GB/s(DDR400) or 5.3GB/s(DDR333).

GA-K8NS Ultra-939 includes four DIMM slots, and each Channel has 2 DIMMs as following:

▶▶ Channel A : DDR 1, DDR 3

▶▶ Channel B : DDR 2, DDR 4



Below are the explanations:

1. One, DDR memory module is installed: The Dual Channel Technology will not operate when one, DDR memory modules is installed and it will only work as Single Channel.
2. Two DDR memory modules are installed (the same memory size and type): The Dual Channel Technology will operate when two DDR memory modules are inserted individually into Channel A and Channel B (DDR 1 pairs up with DDR 2 and DDR 3, 4). However, if the two DDR memory modules are inserted into the same Channel (DDR 1, 3 or DDR 2,4) then Dual Channel Technology will not operate.
3. If four DDR memory modules are installed (two pairs of DDR memory modules with the same memory size and type): The Dual Channel Technology will operate when a pair of DDR memory modules are inserted into DDR 1, 2 and another pair into DDR 3,4.

The following tables include all memory-installed combination types:

(Please note that those types not in the tables will not boot up.)

- Figure 1: Dual Channel Technology (DS: Double Side, SS: Single Side)

	DDR 1	DDR 2	DDR 3	DDR 4
2 memory modules	DS/SS	DS/SS	X	X
	X	X	DS/SS	DS/SS
4 memory modules	DS/SS	DS/SS	DS/SS	DS/SS

- Figure 2: Non Dual Channel Technology (DS: Double Side, SS: Single Side)

	DDR 1	DDR 3
1 memory module	DS/SS	X
	X	DS/SS
2 memory module	DS/SS	DS/SS



The GA-K8NS Ultra-939 doesn't support 3 memory modules. If 3 memory modules are inserted, the system will not boot.

Step 3: Install Expansion Cards

1. Read the related expansion card's instruction document before install the expansion card into the computer.
2. Remove your computer's chassis cover, screws and slot bracket from the computer.
3. Press the expansion card firmly into expansion slot in motherboard.
4. Be sure the metal contacts on the card are indeed seated in the slot.
5. Replace the screw to secure the slot bracket of the expansion card.
6. Replace your computer's chassis cover.
7. Power on the computer, if necessary, setup BIOS utility of expansion card from BIOS.
8. Install related driver from the operating system.

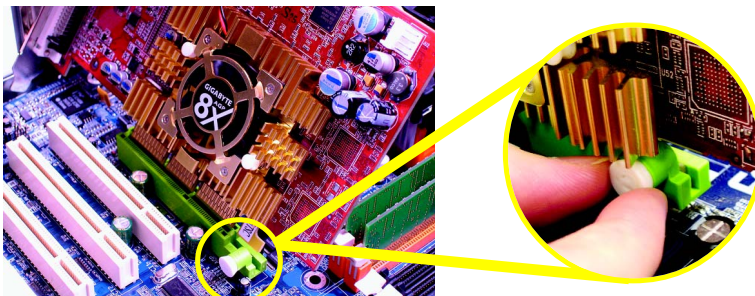

AGP Card

Please carefully pull out the small white-drawable bar at the end of the AGP slot when you try to install /uninstall the AGP card. Please align the AGP card to the onboard AGP slot and press firmly down on the slot. Make sure your AGP card is locked by the small white-drawable bar.



When an AGP 2X (3.3V) card is installed the 2X_DET will light up, indicating a non-supported graphics card is inserted. Informing users that system might not boot up normally due to AGP 2X (3.3V) is not supported by the chipset.

Step 4: Install I/O Peripherals Cables

Step 4-1: I/O Back Panel Introduction

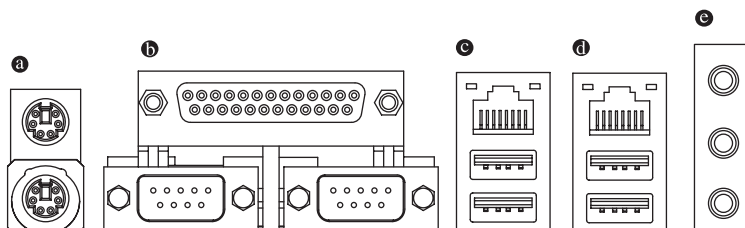

a PS/2 Keyboard and PS/2 Mouse Connector



PS/2 Mouse Connector
(6 pin Female)

PS/2 Keyboard Connector
(6 pin Female)

- This connector supports standard PS/2 keyboard and PS/2 mouse.

b Parallel Port, Serial Ports (COMA / COMB)

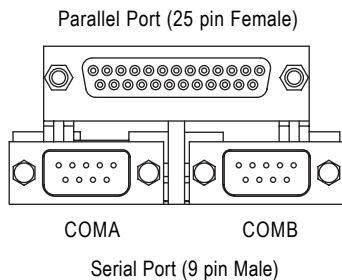

Parallel Port (25 pin Female)

COMA

COMB

Serial Port (9 pin Male)

- This connector supports 2 standard COM ports and 1 Parallel port. Devices like printer can be connected to Parallel port; mouse and modem etc. can be connected to Serial ports.

④ / ⑤ USB/LAN Connector

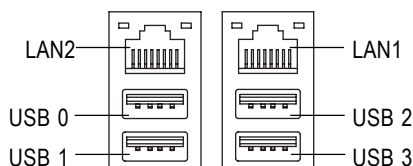

- Before you connect your device(s) into USB connector(s), please make sure your device(s) such as USB keyboard, mouse, scanner, zip, speaker...etc. Have a standard USB interface. Also make sure your OS supports USB controller. If your OS does not support USB controller, please contact OS vendor for possible patch or driver upgrade. For more information please contact your OS or device(s) vendors.
- LAN1 connector is fast Ethernet with 10/100/1000 Mbps speed.
- LAN2 connector is fast Ethernet with 10/100 Mbps speed.

⑥ Audio Connectors

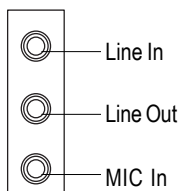

- After install onboard audio driver, you may connect speaker to Line Out jack, microphone to MIC In jack. Devices like CD-ROM, walkman etc. can be connected to Line-In jack.

Please note:

You are able to use 2-/4-/6-/8-channel audio feature by S/W selection.

If you want to enable 8-channel function you can refer to page 30, and contact your nearest dealer for optional SUR_CEN cable.



If you want the detail information for 2-/4-/6-/8-channel audio setup installation, please refer to page 66.

Step 4-2: Connectors Introduction

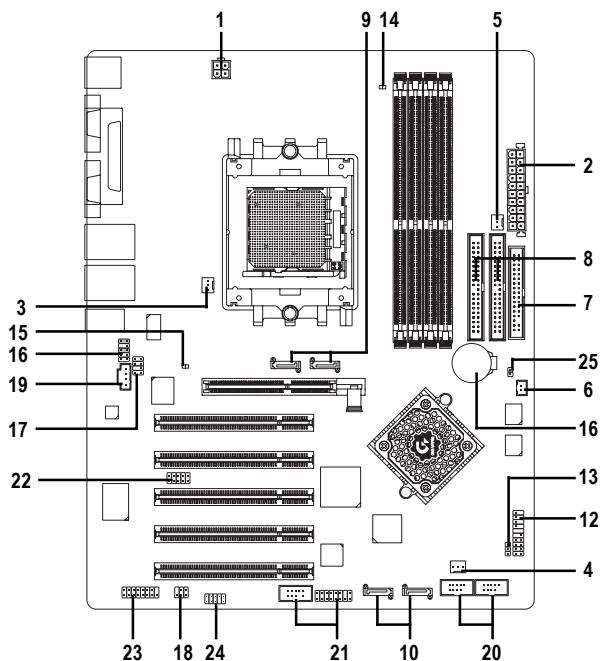

1) ATX_12V	14) RAM_LED
2) ATX (Power Connector)	15) 2X_DET
3) CPU_FAN	16) F_AUDIO
4) SYS_FAN	17) SUR_CEN
5) PWR_FAN	18) SPDIF_IO
6) NB_FAN	19) CD_IN
7) FDD	20) F_USB1 / F_USB2
8) IDE1 / IDE2	21) F1_1394 / F2_1394
9) SATA0_SB / SATA1_SB;	22) IR_CIR
10) SATA0_SII / SATA1_SII	23) GAME
11) BATTERY	24) INFO_LINK
12) F_PANEL	25) CLR_CMOS
13) PWR_LED	

1/2) ATX_12V / ATX (Power Connector)

With the use of the power connector, the power supply can supply enough stable power to all the components on the motherboard. Before connecting the power connector, please make sure that all components and devices are properly installed. Align the power connector with its proper location on the motherboard and connect tightly. The ATX_12V power connector mainly supplies power to the CPU. If the ATX_12V power connector is not connected, the system will not start.

Caution!

Please use a power supply that is able to handle the system voltage requirements. It is recommended that a power supply that can withstand high power consumption be used (300W or greater). If a power supply is used that does not provide the required power, the result can lead to an unstable system or a system that is unable to start.

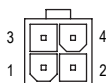
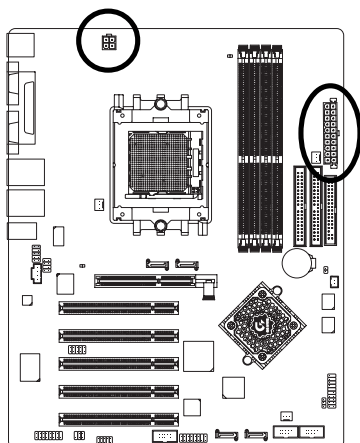

Pin No.	Definition
1	GND
2	GND
3	+12V
4	+12V

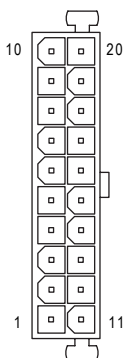

Pin No.	Definition
1	3.3V
2	3.3V
3	GND
4	VCC
5	GND
6	VCC
7	GND
8	Power Good
9	5V SB (stand by +5V)
10	+12V
11	3.3V
12	-12V
13	GND
14	PS_ON(soft on/off)
15	GND
16	GND
17	GND
18	-5V
19	VCC
20	VCC

3/4/5) CPU_FAN / SYS_FAN / PWR_FAN (Cooler Fan Power Connector)

The cooler fan power connector supplies a +12V power voltage via a 3-pin power connector and possesses a foolproof connection design.

Most coolers are designed with color-coded power connector wires. A red power connector wire indicates a positive connection and requires a +12V power voltage. The black connector wire is the ground wire(GND).

Please remember to connect the power to the cooler to prevent system overheating and failure.

Caution!

Please remember to connect the power to the CPU fan to prevent CPU overheating and failure.

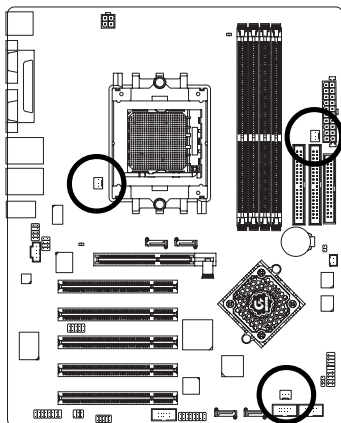

1
CPU_FAN / PWR_FAN

Pin No.	Definition
1	GND
2	+12V
3	Sense



1
SYS_FAN

6) NB_FAN (Chip Fan Connector)

If you installed wrong direction, the chip fan will not work. Sometimes will damage the chip fan. (Usually black cable is GND)

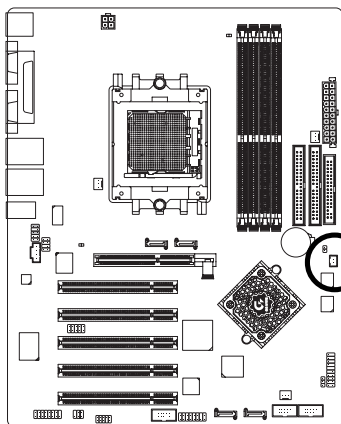

1

Pin No.	Definition
1	+12V
2	GND

7) FDD (Floppy Connector)

The FDD connector is used to connect the FDD cable while the other end of the cable connects to the FDD drive. The types of FDD drives supported are: 360KB, 720KB, 1.2MB, 1.44MB and 2.88MB.

Please connect the red power connector wire to the pin1 position.

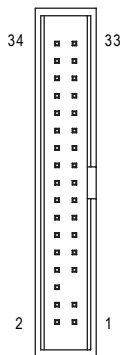
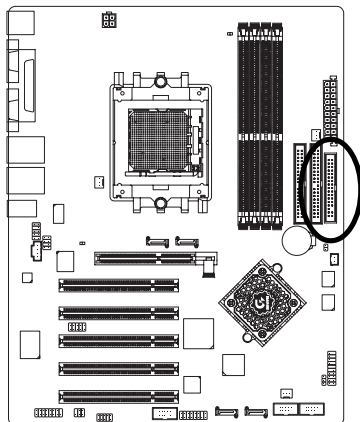

8) IDE1 / IDE2 (IDE Connector)

An IDE device connects to the computer via an IDE connector. One IDE connector can connect to one IDE cable, and the single IDE cable can then connect to two IDE devices (hard drive or optical drive). If you wish to connect two IDE devices, please set the jumper on one IDE device as Master and the other as Slave (for information on settings, please refer to the instructions located on the IDE device).

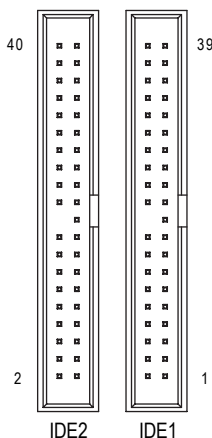
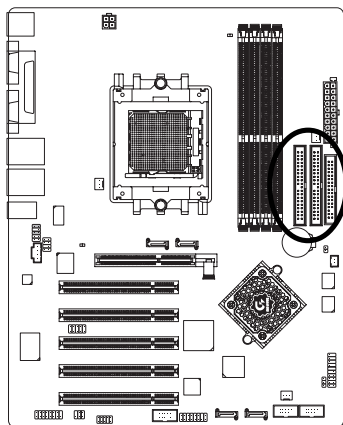

9/10) SATA0_SB / SATA1_SB; SATA0_SII / SATA1_SII (Serial ATA Connector)

Serial ATA can provide 150MB/s transfer rate. Please refer to the BIOS setting for the Serial ATA and install the proper driver in order to work properly.

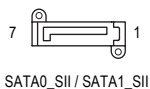
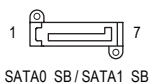
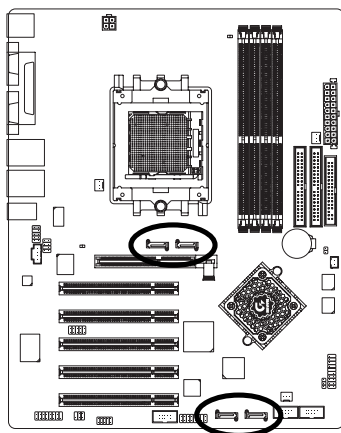

Pin No.	Definition
1	GND
2	TXP
3	TXN
4	GND
5	RXN
6	RXP
7	GND



NOTE

The SATA0_SII / SATA1_SII connectors support hot plug function.

11) BATTERY

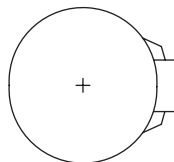
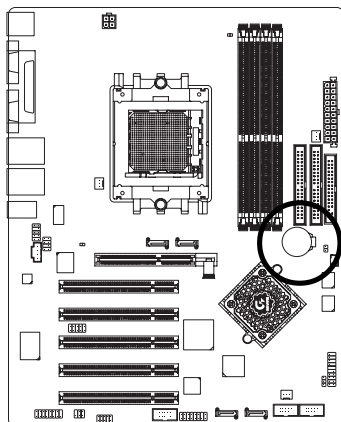

CAUTION

- ❖ Danger of explosion if battery is incorrectly replaced.
- ❖ Replace only with the same or equivalent type recommended by the manufacturer.
- ❖ Dispose of used batteries according to the manufacturer's instructions.

If you want to erase CMOS...

1. Turn OFF the computer and unplug the power cord.
2. Remove the battery, wait for 30 second.
3. Re-install the battery.
4. Plug the power cord and turn ON the computer.

12) F_PANEL (Front Panel Jumper)

Please connect the power LED, PC speaker, reset switch and power switch etc. of your chassis front panel to the F_PANEL connector according to the pin assignment below.

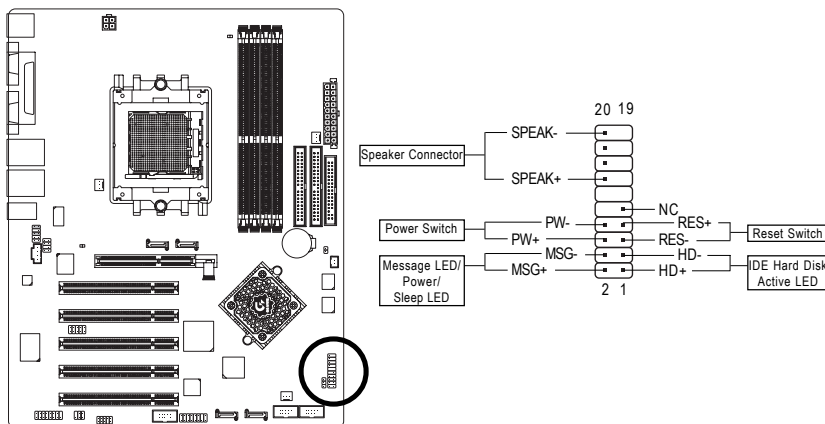

HD (IDE Hard Disk Active LED) (Blue)	Pin 1: LED anode(+) Pin 2: LED cathode(-)
SPK (Speaker Connector) (Amber)	Pin 1: VCC(+) Pin 2- Pin 3: NC Pin 4: Data(-)
RES (Reset Switch) (Green)	Open: Normal Operation Close: Reset Hardware System
PW (Power Switch) (Red)	Open: Normal Operation Close: Power On/Off
MSG (Message LED/ Power/ Sleep LED) (Yellow)	Pin 1: LED anode(+) Pin 2: LED cathode(-)
NC (Purple)	NC

13) PWR_LED

PWR_LED is connect with the system power indicator to indicate whether the system is on/off. It will blink when the system enters suspend mode. If you use dual color LED, power LED will turn to another color.

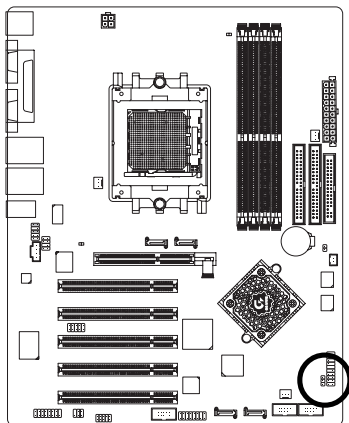

Pin No.	Definition
1	MPD+
2	MPD-
3	MPD-

14) RAM_LED

Do not remove memory modules while RAM_LED is on. It might cause short or other unexpected damages due to the stand by voltage. Remove memory modules only when AC power cord is disconnected.

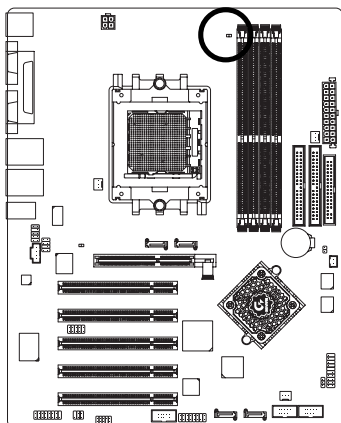

15) 2X_LED

When an AGP 2X (3.3V) card is installed the 2X_DET will light up, indicating a non-supported graphics card is inserted. Informing users that system might not boot up normally due to AGP 2X (3.3V) is not supported by the chipset.

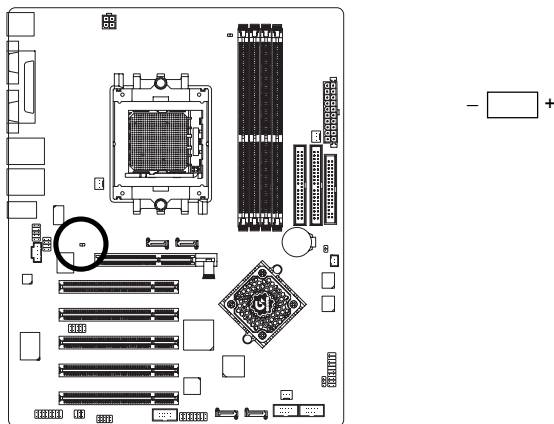

16) F_AUDIO (Front Audio Connector)

If you want to use Front Audio connector, you must remove 5-6, 9-10 Jumper.

In order to utilize the front audio header, your chassis must have front audio connector. Also please make sure the pin assignment on the cable is the same as the pin assignment on the MB header. To find out if the chassis you are buying support front audio connector, please contact your dealer. Please note, you can have the alternative of using front audio connector or of using rear audio connector to play sound.

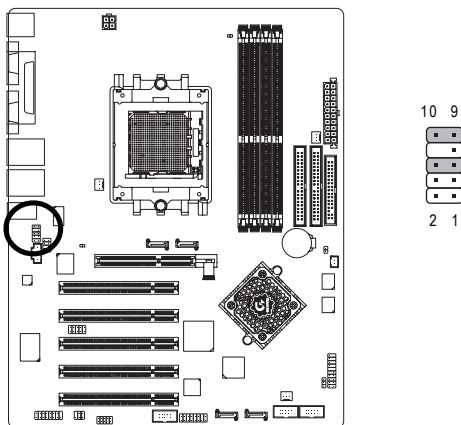

Pin No.	Definition
1	MIC
2	GND
3	MIC_BIAS
4	Power
5	Front Audio (R)
6	Rear Audio (R)
7	Reserved
8	No Pin
9	Front Audio (L)
10	Rear Audio (L)

17) SUR_CEN (Surround Center Connector)

Please contact your nearest dealer for optional SUR_CEN cable.

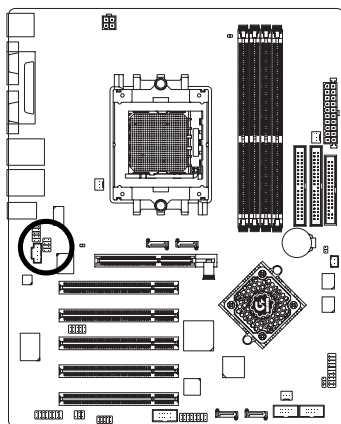

Pin No.	Definition
1	SUR OUTL
2	SUR OUTR
3	GND
4	No Pin
5	CENTER_OUT
6	BASS_OUT
7	AUX_L
8	AUX_R

18) SPDIF_IO (SPDIF In / Out Connector)

The SPDIF output is capable of providing digital audio to external speakers or compressed AC3 data to an external Dolby Digital Decoder. Use this feature only when your stereo system has digital input and output function. Use SPDIF in feature only when your device has digital output function. Be careful with the polarity of the SPDIF_IO connector. Check the pin assignment carefully while you connect the SPDIF cable, incorrect connection between the cable and connector will make the device unable to work or even damage it. For optional SPDIF cable, please contact your local dealer.

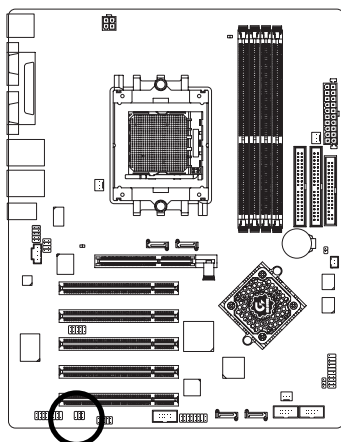

Pin No.	Definition
1	VCC
2	No Pin
3	SPDIF
4	SPDIFI
5	GND
6	GND

19) CD_IN (CD In Connector)

Connect CD-ROM or DVD-ROM audio out to the CD_IN connector.

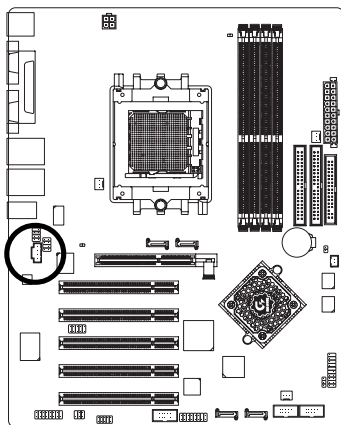

Pin No.	Definition
1	CD-L
2	GND
3	GND
4	CD-R

20) F_USB1 / F_USB2 (Front USB Connector)

Be careful with the polarity of the front USB connector. Check the pin assignment carefully while you connect the front USB cable, incorrect connection between the cable and connector will make the device unable to work or even damage it. For optional front USB cable, please contact your local dealer.

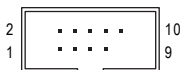
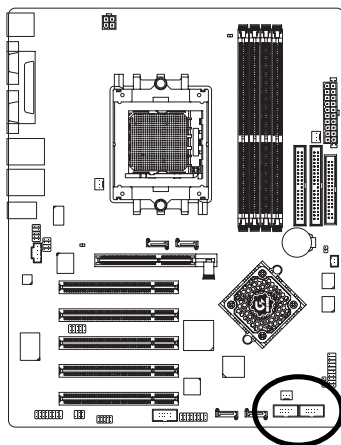

Pin No.	Definition
1	Power
2	Power
3	USB Dx-
4	USB Dy-
5	USB Dx+
6	USB Dy+
7	GND
8	GND
9	No Pin
10	NC

21) F1_1394 / F2_1394 (Front IEEE1394 Connector)

Serial interface standard set by Institute of Electrical and Electronics Engineers, which has features like high speed, highbandwidth and hot plug. Be careful with the polarity of the IEEE1394 connector. Check the pin assignment carefully while you connect the IEEE1394 cable, incorrect connection between the cable and connector will make the device unable to work or even damage it. For optional IEEE1394 cable, please contact your local dealer.

Pin No.	Definition
1	TPA2+
2	TPA2-
3	GND
4	GND
5	TPB2+
6	TPB2-
7	No Pin
8	Power
9	Power
10	GND

Pin No.	Definition
1	Power
2	Power
3	TPA0+
4	TPA0-
5	GND
6	GND
7	TPB0+
8	TPB0-
9	Power
10	Power
11	TPA1+
12	TPA1-
13	GND
14	No Pin
15	TPB1+
16	TPB1-

22) IR_CIR

Make sure the pin 1 on the IR device is along with pin one the connector. To enable the IR/CIR function, you are required to purchase an optional IR/CIR module. To use IR function only, please connect IR module to Pin1 to Pin5. Be careful with the polarity of the IR/CIR connector. Check the pin assignment carefully while you connect the IR/CIR cable, incorrect connection between the cable and connector will make the device unable to work or even damage it. For optional IR/CIR cable, please contact your local dealer.

Pin No.	Definition
1	VCC
2	NC
3	IRRX
4	GND
5	IRTX
6	NC
7	CIRRX
8	+5VSB
9	CIRTX
10	NC

23) GAME (Game Connector)

This connector supports joystick, MIDI keyboard and other relate audio devices. Check the pin assignment while you connect the game cables. Please contact your nearest dealer for optional game cables.

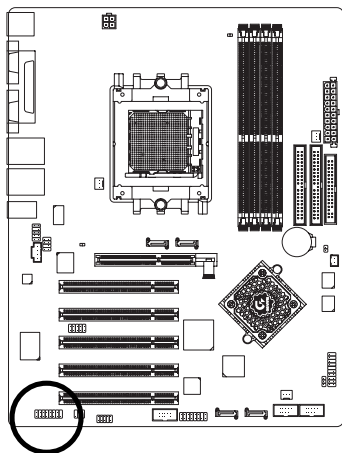

Pin No.	Definition
1	VCC
2	GRX1_R
3	GND
4	GPSA2
5	VCC
6	GPX2_R
7	GPY2_R
8	MSL_R
9	GPSA1
10	GND
11	GPY1_R
12	VCC
13	GPSB1
14	MSO_R
15	GPSB2
16	No Pin

24) INFO_LINK

This connector allows you to connect some external devices to provide you extra function. Check the pin assignment while you connect the external device cable. Please contact your nearest dealer for optional external device cable.

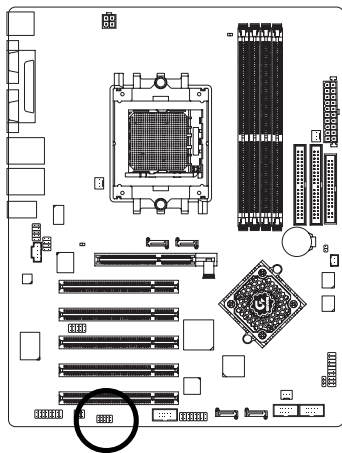

Pin No.	Definition
1	SMBCLK
2	VCC
3	SMBDATA
4	GPIO
5	GND
6	GND
7	No Pin
8	NC
9	+12V
10	+12V

25) CLR_CMOS (Clear CMOS)

You may clear the CMOS data to its default values by this jumper. To clear CMOS, temporarily short 1-2 pin. Default doesn't include the "Shunter" to prevent from improper use this jumper.

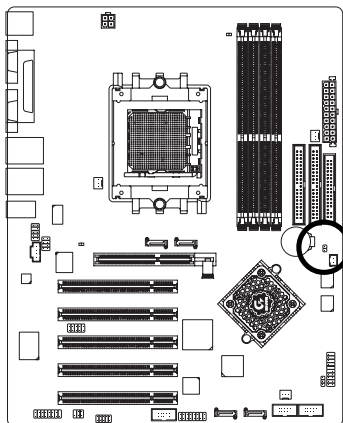

Open: Normal



Close: Clear CMOS

Chapter 3 BIOS Setup

BIOS Setup is an overview of the BIOS Setup Program. The program that allows users to modify the basic system configuration. This type of information is stored in battery-backed CMOS RAM so that it retains the Setup information when the power is turned off.

ENTERING SETUP

Powering ON the computer and pressing immediately will allow you to enter Setup. If you require more advanced BIOS settings, please go to "Advanced BIOS" setting menu. To enter Advanced BIOS setting menu, press "Ctrl+F1" key on the BIOS screen.

CONTROL KEYS

<↑>	Move to previous item
<↓>	Move to next item
<←>	Move to the item in the left hand
<→>	Move to the item in the right hand
<Enter>	Select Item
<Esc>	Main Menu - Quit and not save changes into CMOS Status Page Setup Menu and Option Page Setup Menu - Exit current page and return to Main Menu
<+/PgUp>	Increase the numeric value or make changes
<-/PgDn>	Decrease the numeric value or make changes
<F1>	General help, only for Status Page Setup Menu and Option Page Setup Menu
<F2>	Item Help
<F3>	Reserved
<F4>	Reserved
<F5>	Restore the previous CMOS value from CMOS, only for Option Page Setup Menu
<F6>	Load the file-safe default CMOS value from BIOS default table
<F7>	Load the Optimized Defaults
<F8>	Dual BIOS/Q-Flash utility
<F9>	System Information
<F10>	Save all the CMOS changes, only for Main Menu

Main Menu

The on-line description of the highlighted setup function is displayed at the bottom of the screen.

Status Page Setup Menu / Option Page Setup Menu

Press F1 to pop up a small help window that describes the appropriate keys to use and the possible selections for the highlighted item. To exit the Help Window press <Esc>.

The Main Menu (For example: BIOS Ver. : E1)

Once you enter Award BIOS CMOS Setup Utility, the Main Menu (as figure below) will appear on the screen. The Main Menu allows you to select from eight setup functions and two exit choices. Use arrow keys to select among the items and press <Enter> to accept or enter the sub-menu.

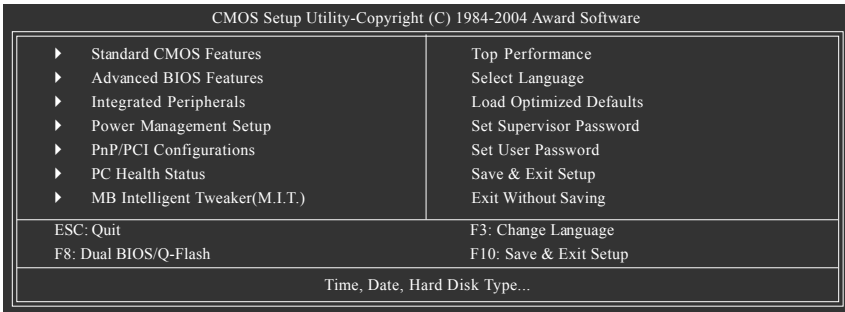

If you can't find the setting you want, please press "Ctrl + F1" to search the advanced option hidden.

- **Standard CMOS Features**

This setup page includes all the items in standard compatible BIOS.

- **Advanced BIOS Features**

This setup page includes all the items of Award special enhanced features.

- **Integrated Peripherals**

This setup page includes all onboard peripherals.

- **Power Management Setup**

This setup page includes all the items of Green function features.

- **PnP/PCI Configurations**

This setup page includes all the configurations of PCI & PnP ISA resources.

- **PC Health Status**

This setup page is the System auto detect Temperature, voltage, fan, speed.

- **MB Intelligent Tweaker(M.I.T.)**

This setup page is control CPU's clock and frequency ratio.

- **Top Performance**

If you wish to maximize the performance of your system, set "Top Performance" as "Enabled".

- **Select Language**

This setup page is select multi-language.

- **Load Optimized Defaults**

Optimized Defaults indicates the value of the system parameters which the system would be in best performance configuration.

- **Set Supervisor Password**

Change, set, or disable password. It allows you to limit access to the system and Setup, or just to Setup.

- **Set User Password**

Change, set, or disable password. It allows you to limit access to the system.

- **Save & Exit Setup**

Save CMOS value settings to CMOS and exit setup.

- **Exit Without Saving**

Abandon all CMOS value changes and exit setup.

Standard CMOS Features

CMOS Setup Utility-Copyright (C) 1984-2004 Award Software Standard CMOS Features		
		Item Help
Date (mm:dd:yy)	Wed, May 19 2004	Menu Level▶
Time (hh:mm:ss)	22:31:24	Change the day, month, year
▶ IDE Channel 0 Master	[None]	<Week>
▶ IDE Channel 0 Slave	[None]	Sun. to Sat.
▶ IDE Channel 1 Master	[None]	<Month>
▶ IDE Channel 1 Slave	[None]	Jan. to Dec.
▶ IDE Channel 2 Master	[None]	<Day>
▶ IDE Channel 3 Master	[None]	1 to 31 (or maximum allowed in the month)
Drive A	[1.44M, 3.5"]	<Year>
Drive B	[None]	1999 to 2098
Floppy 3 Mode Suport	[Disabled]	
Halt On	[All, But Keyboard]	
Base Memory	640K	
Extended Memory	127M	
Total Memory	128M	
↑↓→←: Move Enter: Select +/-/PU/PD: Value F10: Save ESC: Exit F1: General Help F3: Language F5: Previous Values F6: Fail-Save Defaults F7: Optimized Defaults		

☞ Date

The date format is <week>, <month>, <day>, <year>.

- ▶▶ Week The week, from Sun to Sat, determined by the BIOS and is displayed only.
- ▶▶ Month The month, Jan. Through Dec.
- ▶▶ Day The day, from 1 to 31 (or the maximum allowed in the month)
- ▶▶ Year The year, from 1999 through 2098.

☞ Time

The times format in <hour> <minute> <second>. The time is calculated base on the 24-hour military-time clock. For example, 1 p.m. is 13:00:00.

☞ IDE Channel 0 Master, Slave / IDE Channel 1 Master, Slave / IDE Channel 2 Master / IDE Channel 3 Master

- ▶▶ IDE HDD Auto-Detection Press "Enter" to select this option for automatic device detection.
- ▶▶ IDE Channel 0 Master(Slave) / IDE Channel 1 Master(Slave) / IDE Channel 2 Master / IDE Channel 3 Master Device Setup. You can use one of three methods:
 - Auto Allows BIOS to automatically detect IDE devices during POST(default)
 - None Select this if no IDE devices are used and the system will skip the automatic detection step and allow for faster system start up.
 - Manual User can manually input the correct settings
- ▶▶ Access Mode Use this to set the access mode for the hard drive. The four options are: CHS/LBA/Large/Auto(default:Auto)

Hard drive information should be labeled on the outside drive casing. Enter the appropriate option based on this information.

- ▶▶ Cylinder Number of cylinders
- ▶▶ Head Number of heads
- ▶▶ Precomp Write precomp
- ▶▶ Landing Zone Landing zone
- ▶▶ Sector Number of sectors

If a hard disk has not been installed, select NONE and press <Enter>.

☞ Drive A / Drive B

The category identifies the types of floppy disk drive A or drive B that has been installed in the computer.

- ▶▶ None No floppy drive installed
- ▶▶ 360K, 5.25" 5.25 inch PC-type standard drive; 360K byte capacity.
- ▶▶ 1.2M, 5.25" 5.25 inch AT-type high-density drive; 1.2M byte capacity
(3.5 inch when 3 Mode is Enabled).
- ▶▶ 720K, 3.5" 3.5 inch double-sided drive; 720K byte capacity
- ▶▶ 1.44M, 3.5" 3.5 inch double-sided drive; 1.44M byte capacity.
- ▶▶ 2.88M, 3.5" 3.5 inch double-sided drive; 2.88M byte capacity.

☞ Floppy 3 Mode Support (for Japan Area)

- ▶▶ Disabled Normal Floppy Drive. (Default value)
- ▶▶ Drive A Drive A is 3 mode Floppy Drive.
- ▶▶ Drive B Drive B is 3 mode Floppy Drive.
- ▶▶ Both Drive A & B are 3 mode Floppy Drives.

☞ Halt on

The category determines whether the computer will stop if an error is detected during power up.

- ▶▶ No Errors The system boot will not stop for any error that may be detected and you will be prompted.
- ▶▶ All Errors Whenever the BIOS detects a non-fatal error the system will be stopped.
- ▶▶ All, But Keyboard The system boot will not stop for a keyboard error; it will stop for all other errors. (Default value)
- ▶▶ All, But Diskette The system boot will not stop for a disk error; it will stop for all other errors.
- ▶▶ All, But Disk/Key The system boot will not stop for a keyboard or disk error; it will stop for all other errors.

☞ Memory

The category is display-only which is determined by POST (Power On Self Test) of the BIOS.

▶▶ Base Memory

The POST of the BIOS will determine the amount of base (or conventional) memory installed in the system.

The value of the base memory is typically 512K for systems with 512K memory installed on the motherboard, or 640K for systems with 640K or more memory installed on the motherboard.

▶▶ Extended Memory

The BIOS determines how much extended memory is present during the POST.

This is the amount of memory located above 1 MB in the CPU's memory address map.

▶▶ Total Memory

This item displays the memory size that used.

Advanced BIOS Features

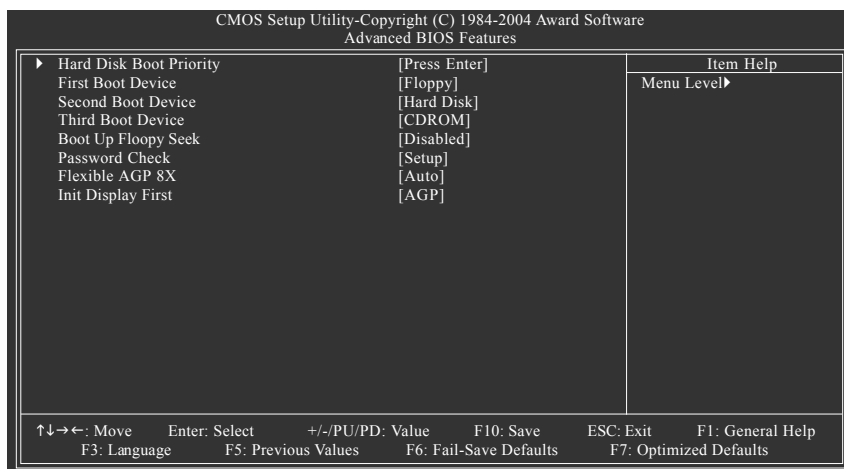

Hard Disk Boot Priority

Select boot sequence for onboard(or add-on cards) SCSI, RAID, etc.

Use <↑> or <↓> to select a device, then press<+> to move it up, or <-> to move it down the list. Press <ESC> to exit this menu.

First / Second / Third Boot Device

- ▶ Floppy Select your boot device priority by Floppy.
- ▶ LS120 Select your boot device priority by LS120.
- ▶ Hard Disk Select your boot device priority by Hard Disk.
- ▶ CDROM Select your boot device priority by CDROM.
- ▶ ZIP Select your boot device priority by ZIP.
- ▶ USB-FDD Select your boot device priority by USB-FDD.
- ▶ USB-ZIP Select your boot device priority by USB-ZIP.
- ▶ USB-CDROM Select your boot device priority by USB-CDROM.
- ▶ USB-HDD Select your boot device priority by USB-HDD.
- ▶ LAN Select your boot device priority by LAN.
- ▶ Disabled Select your boot device priority by Disabled.

Boot Up Floppy Seek

During POST, BIOS will determine the floppy disk drive installed is 40 or 80 tracks. 360K type is 40 tracks 720K, 1.2M and 1.44M are all 80 tracks.

- ▶ Enabled BIOS searches for floppy disk drive to determine it is 40 or 80 tracks. Note that BIOS can not tell from 720K, 1.2M or 1.44M drive type as they are all 80 tracks.
- ▶ Disabled BIOS will not search for the type of floppy disk drive by track number. Note that there will not be any warning message if the drive installed is 360K. (Default value)

☞ Password Check

- ▶▶ System The system can not boot and can not access to Setup page will be denied if the correct password is not entered at the prompt.
- ▶▶ Setup The system will boot, but access to Setup will be denied if the correct password is not entered at the prompt. (Default value)

☞ Felxible AGP 8X

- ▶▶ Auto Automatically set AGP transfer rate according to AGP compatibility and stability. (Default value)
- ▶▶ 8X Always set AGP transfer rate to 8X mode if the 8X mode supported by the AGP card.
- ▶▶ 4X Set AGP transfer rate to 4X mode no matter what the AGP transfer rate the card is.

☞ Init Display First

This feature allows you to select the first initiation of the monitor display from which card when you install an AGP card and a PCI VGA card on the motherboard.

- ▶▶ AGP Set Init display first to AGP. (Default value)
- ▶▶ PCI slot Set Init display first to PCI.

Integrated Peripherals

CMOS Setup Utility-Copyright (C) 1984-2004 Award Software
Integrated Peripherals

		Item Help
IDE Function Setup	[Press Enter]	
On-Chip Primary PCI IDE	[Enabled]	Menu Level▶
On-Chip Secondary PCI IDE	[Enabled]	
USB Host Controller	[V1.1+V2.0]	
USB Keyboard Support	[Disabled]	
USB Mouse Support	[Disabled]	
Serial-ATA 2 (Internal PHY)	[Enabled]	
AC97 Audio	[Auto]	
On-Chip LAN (nVIDIA)	[Auto]	
Onboard Serial ATA	[Enabled]	
Serial ATA Function	[RAID]	
Onboard I394	[Enabled]	
Onboard LAN Control	[Enabled]	
Onboard LAN Boot ROM	[Disabled]	
Onboard Serial Port 1	[3F8/IRQ4]	
Onboard Serial Port 2	[2F8/IRQ3]	
Onboard Parallel Port	[378/IRQ7]	
Parallel Port Mode	[SPP]	
x ECP Mode Use DMA	3	

↑↓→←: Move Enter: Select +/-/PU/PD: Value F10: Save ESC: Exit F1: General Help
F3: Language F5: Previous Values F6: Fail-Save Defaults F7: Optimized Defaults

CMOS Setup Utility-Copyright (C) 1984-2004 Award Software
Integrated Peripherals

		Item Help
Game Port Address	[201]	
Midi Port Address	[Disabled]	Menu Level▶
x Midi Port IRQ	10	
CIR Port Address	[Disabled]	
x CIR Port IRQ	11	
IDE DMA transfer	[Enabled]	

↑↓→←: Move Enter: Select +/-/PU/PD: Value F10: Save ESC: Exit F1: General Help
F3: Language F5: Previous Values F6: Fail-Save Defaults F7: Optimized Defaults

IDE Function Setup

CMOS Setup Utility-Copyright (C) 1984-2004 Award Software
IDE Function Setup

		Item Help
IDE RAID	[Enabled]	Menu Level▶
IDE Channel 0 Master RAID	[Disabled]	
IDE Channel 0 Slave RAID	[Disabled]	
IDE Channel 1 Master RAID	[Disabled]	
IDE Channel 1 Slave RAID	[Disabled]	
SATA Primary Master RAID	[Disabled]	
SATA Secndry Master RAID	[Disabled]	

↑↓→←: Move Enter: Select +/-/PU/PD: Value F10: Save ESC: Exit F1: General Help
F3: Language F5: Previous Values F6: Fail-Save Defaults F7: Optimized Defaults

- ☞ **IDE RAID**
 - ▶▶ Enabled Enable IDE RAID function.
 - ▶▶ Disabled Disable this function. (Default value)
- ☞ **IDE Channel 0 Master RAID**
 - ▶▶ Enabled Enable 1st master channel IDE RAID function.
 - ▶▶ Disabled Disable this function. (Default value)
- ☞ **IDE Channel 0 Slave RAID**
 - ▶▶ Enabled Enable 1st slave channel IDE RAID function.
 - ▶▶ Disabled Disable this function. (Default value)
- ☞ **IDE Channel 1 Master RAID**
 - ▶▶ Enabled Enable 2nd master channel IDE RAID function.
 - ▶▶ Disabled Disable this function. (Default value)
- ☞ **IDE Channel 1 Slave RAID**
 - ▶▶ Enabled Enable 2nd slave channel IDE RAID function.
 - ▶▶ Disabled Disable this function. (Default value)
- ☞ **SATA Primary Master RAID**
 - ▶▶ Enabled Enable 1st SATA RAID function.
 - ▶▶ Disabled Disable this function. (Default value)
- ☞ **SATA Secndry Master RAID**
 - ▶▶ Enabled Enable 2nd SATA RAID function.
 - ▶▶ Disabled Disable this function. (Default value)
- ☞ **On-Chip Primary PCI IDE**
 - ▶▶ Enabled Enable onboard 1st channel IDE port. (Default value)
 - ▶▶ Disabled Disable onboard 1st channel IDE port.
- ☞ **On-Chip Secondary PCI IDE**
 - ▶▶ Enabled Enable onboard 2nd channel IDE port. (Default value)
 - ▶▶ Disabled Disable onboard 2nd channel IDE port.
- ☞ **USB Host Controller**
 - ▶▶ Disabled Disable this function if you are not using onboard USB function.
 - ▶▶ V1.1+V2.0 Enable USB 1.1 and USB 2.0 controller. (Default value)
 - ▶▶ V1.1 Only enable USB 1.1 controller.
- ☞ **USB Keyboard Support**
 - ▶▶ Enabled Enable USB keyboard support.
 - ▶▶ Disabled Disable USB keyboard support. (Default value)
- ☞ **USB Mouse Support**
 - ▶▶ Enabled Enable USB mouse support.
 - ▶▶ Disabled Disable USB mouse support. (Default value)
- ☞ **Serial-ATA 2 (Internal PHY) (Onboard nVIDIA nForce3 Ultra chipset)**
 - ▶▶ Enabled Enable Serial ATA supported. (Default value)
 - ▶▶ Disabled Disable Serial ATA supported.
- ☞ **AC97 Audio**
 - ▶▶ Auto Enable onboard AC'97 audio function. (Default value)
 - ▶▶ Disabled Disable this function.

☞ VIA On-Chip LAN (nVIDIA)

- ▶▶ Auto Auto-detect onboard LAN function. (Default value)
- ▶▶ Disabled Disable onboard LAN function.

☞ Onboard Serial ATA (Onboard Sil3512 chipset)

- ▶▶ Enabled Enable onboard Serial ATA chip function. (Default value)
- ▶▶ Disabled Disable this function.

☞ Serial ATA Function

- ▶▶ RAID Select onboard Serial ATA chip function as RAID. (Default value)
- ▶▶ BASE Select onboard Serial ATA chip function as base.

☞ Onboard 1394

- ▶▶ Enabled Enable onboard IEEE1394 function. (Default value)
- ▶▶ Disabled Disable onboard IEEE1394 function.

☞ Onboard LAN Control

- ▶▶ Enabled Enable onboard LAN chip function. (Default value)
- ▶▶ Disabled Disable onboard LAN chip function.

☞ Onboard LAN Boot ROM

This function decide whether to invoke the boot ROM of the onboard LAN chip.

- ▶▶ Enabled Enable this function.
- ▶▶ Disabled Disable this function. (Default value)

☞ Onboard Serial Port 1

- ▶▶ Auto BIOS will automatically setup the port 1 address.
- ▶▶ 3F8/IRQ4 Enable onboard Serial port 1 and address is 3F8. (Default value)
- ▶▶ 2F8/IRQ3 Enable onboard Serial port 1 and address is 2F8.
- ▶▶ 3E8/IRQ4 Enable onboard Serial port 1 and address is 3E8.
- ▶▶ 2E8/IRQ3 Enable onboard Serial port 1 and address is 2E8.
- ▶▶ Disabled Disable onboard Serial port 1.

☞ Onboard Serial Port 2

- ▶▶ Auto BIOS will automatically setup the port 2 address.
- ▶▶ 3F8/IRQ4 Enable onboard Serial port 2 and address is 3F8.
- ▶▶ 2F8/IRQ3 Enable onboard Serial port 2 and address is 2F8. (Default value)
- ▶▶ 3E8/IRQ4 Enable onboard Serial port 2 and address is 3E8.
- ▶▶ 2E8/IRQ3 Enable onboard Serial port 2 and address is 2E8.
- ▶▶ Disabled Disable onboard Serial port 2.

☞ Onboard Parallel Port

- ▶▶ 378/IRQ7 Enable onboard LPT port and address is 378/IRQ7. (Default value)
- ▶▶ 278/IRQ5 Enable onboard LPT port and address is 278/IRQ5.
- ▶▶ Disabled Disable onboard LPT port.
- ▶▶ 3BC/IRQ7 Enable onboard LPT port and address is 3BC/IRQ7.

☞ Parallel Port Mode

- ▶▶ SPP Using Parallel port as Standard Parallel Port. (Default value)
- ▶▶ EPP Using Parallel port as Enhanced Parallel Port.
- ▶▶ ECP Using Parallel port as Extended Capabilities Port.
- ▶▶ ECP+EPP Using Parallel port as ECP & EPP mode.

☞ **ECP Mode Use DMA**

- ▶▶ 3 Set ECP Mode Use DMA to 3. (Default value)
- ▶▶ 1 Set ECP Mode Use DMA to 1.

☞ **Game Port Address**

- ▶▶ 201 Set Game Port Address to 201. (Default value)
- ▶▶ 209 Set Game Port Address to 209.
- ▶▶ Disabled Disable this function.

☞ **Midi Port Address**

- ▶▶ 300 Set Midi Port Address to 300.
- ▶▶ 330 Set Midi Port Address to 330.
- ▶▶ Disabled Disable this function. (Default value)

☞ **Midi Port IRQ**

- ▶▶ 5 Set Midi Port IRQ to 5.
- ▶▶ 10 Set Midi Port IRQ to 10. (Default value)

☞ **CIR Port Address**

- ▶▶ 310 Set CIR Port Address to 310.
- ▶▶ 320 Set CIR Port Address to 320.
- ▶▶ Disabled Disable this function. (Default value)

☞ **CIR Port IRQ**

- ▶▶ 5 Set CIR Port IRQ to 5.
- ▶▶ 11 Set CIR Port IRQ to 11. (Default value)

☞ **IDE DMA transfer access**

- ▶▶ Enabled Enable IDE DMA transfer access. (Default value)
- ▶▶ Disabled Disable this function.

Power Management Setup

CMOS Setup Utility-Copyright (C) 1984-2004 Award Software Power Management Setup		
		Item Help
ACPI Suspend Type	[S1(POS)]	Menu Level▶
Soft-Off by PWR-BTTN	[Instant-Off]	
PME Event Wake Up	[Disabled]	[S1] Set suspend type to Power On Suspend under ACPI OS
Modem Ring On	[Disabled]	
S3 Resume by USB device	[Disabled]	
Resume by Alarm	[Disabled]	[S3] Set suspend type to Suspend to RAM under ACPI OS
x Day of Month Alarm	Everyday	
x Time (hh:mm:ss) Alarm	0 : 0 : 0	
Power On by Mouse	[Disabled]	
Power On by Keyboard	[Disabled]	
x KB Power ON Password	Enter	
AC Back Function	[Soft-Off]	

↑↓→←: Move Enter: Select +/-/PU/PD: Value F10: Save ESC: Exit F1: General Help
 F3: Language F5: Previous Values F6: Fail-Save Defaults F7: Optimized Defaults

ACPI Suspend Type

- ▶▶ S1(POS) Set ACPI suspend type to S1/POS (Power On Suspend). (Default value)
- ▶▶ S3(STR) Set ACPI suspend type to S3/STR (Suspend To RAM).

Soft-Off by PWR-BTTN

- ▶▶ Instant-off Press power button then power off instantly. (Default value)
- ▶▶ Delay 4 Sec. Press power button 4 seconds to power off. Enter suspend if button is pressed less than 4 seconds.

PME Event Wake Up

This feature requires an ATX power supply that provides at least 1A on the 5VSB lead.

- ▶▶ Disabled Disable this function. (Default value)
- ▶▶ Enabled Enable PME as wake up event.

Modem Ring On

An incoming call via modem can awake the system from any suspend state.

- ▶▶ Disabled Disable Modem Ring on function. (Default value)
- ▶▶ Enabled Enable Modem Ring on function.

S3 Resume by USB Device

- ▶▶ Disabled Disable this function. (Default value)
- ▶▶ Enable Enable USB device wake up system from S3 suspend type.

Resume by Alarm

You can set "Resume by Alarm" item at "Enabled" and key in date/time to power on system.

- ▶▶ Disabled Disable this function. (Default value)
- ▶▶ Enabled Enable alarm function to POWER ON system.

If RTC Alarm Lead To Power On is Enabled.

Day of Month Alarm : Everyday, 1~31

Time (hh: mm: ss) Alarm : (0~23) : (0~59) : (0~59)

☞ **Power On by Mouse**

- ▶▶ Disabled Disabled this function. (Default value)
- ▶▶ Double Click Double click on PS/2 mouse left button to power on system.

☞ **Power On by Keyboard**

- ▶▶ Disabled Disabled this function. (Default value)
- ▶▶ Password Enter from 1 to 5 characters to set the keyboard power on password.
- ▶▶ Keyboard 98 If there is a "POWER" button on your keyboard, you can press the key to power on your system.

☞ **KB Power ON Password**

When "Power On by Keyboard" set at Password, you can set the password here.

- ▶▶ Enter Input password(from 1 to 5 characters) and press Enter to set the password.

☞ **AC Back Function**

- ▶▶ Soft-Off Always in off state when AC back. (Default value)
- ▶▶ Full-On Always power on the system when AC back.

PnP/PCI Configurations

CMOS Setup Utility-Copyright (C) 1984-2004 Award Software		Item Help
PnP/PCI Configurations		Menu Level▶
PCI 3 IRQ Assignment	[Auto]	
PCI 4 IRQ Assignment	[Auto]	
PCI 1/5 IRQ Assignment	[Auto]	
PCI 2 IRQ Assignment	[Auto]	
		Device(s) using this INT:
		RAID Cntrlr
		- Bus 0 Dev12 Func 0
↑↓→←: Move Enter: Select +/-/PU/PD: Value F10: Save ESC: Exit F1: General Help F3: Language F5: Previous Values F6: Fail-Save Defaults F7: Optimized Defaults		

PCI 3 IRQ Assignment

- ▶ Auto Auto assign IRQ to PCI 3. (Default value)
- ▶ 3,4,5,7,9,10,11,12,14,15 Set IRQ 3,4,5,7,9,10,11,12,14,15 to PCI 3.

PCI 4 IRQ Assignment

- ▶ Auto Auto assign IRQ to PCI 4. (Default value)
- ▶ 3,4,5,7,9,10,11,12,14,15 Set IRQ 3,4,5,7,9,10,11,12,14,15 to PCI 4.

PCI 1/5 IRQ Assignment

- ▶ Auto Auto assign IRQ to PCI 1/5. (Default value)
- ▶ 3,4,5,7,9,10,11,12,14,15 Set IRQ 3,4,5,7,9,10,11,12,14,15 to PCI 1/PCI5.

PCI 2 IRQ Assignment

- ▶ Auto Auto assign IRQ to PCI 2. (Default value)
- ▶ 3,4,5,7,9,10,11,12,14,15 Set IRQ 3,4,5,7,9,10,11,12,14,15 to PCI 2.

PC Health Status

CMOS Setup Utility-Copyright (C) 1984-2004 Award Software		Item Help
PC Health Status		Menu Level▶
Vcore	OK	
DDR25V	OK	
+3.3V	OK	
+12V	OK	
Current CPU Temperature	51°C	
Current CPU FAN Speed	3125 RPM	
Current POWER FAN Speed	0 RPM	
Current SYSTEM FAN Speed	0 RPM	
CPU Warning Temperature	[Disabled]	
CPU FAN Fail Warning	[Disabled]	
POWER FAN Fail Warning	[Disabled]	
SYSTEM FAN Fail Warning	[Disabled]	
CPU Smart FAN Control	[Enabled]	

↑↓→←: Move Enter: Select +/-/PU/PD: Value F10: Save ESC: Exit F1: General Help
 F3: Language F5: Previous Values F6: Fail-Save Defaults F7: Optimized Defaults

☞ **Current Voltage (V) Vcore / DDR25V / +3.3V / +12V**

▶▶ Detect system's voltage status automatically.

☞ **Current CPU Temperature**

▶▶ Detect CPU temperature automatically.

☞ **Current CPU/POWER/SYSTEM FAN Speed (RPM)**

▶▶ Detect CPU/power/system fan speed status automatically.

☞ **CPU Warning Temperature**

- ▶▶ Disabled Don't monitor current temperature.
- ▶▶ 60°C / 140°F Monitor CPU temperature at 60°C / 140°F.
- ▶▶ 70°C / 158°F Monitor CPU temperature at 70°C / 158°F.
- ▶▶ 80°C / 176°F Monitor CPU temperature at 80°C / 176°F.
- ▶▶ 90°C / 194°F Monitor CPU temperature at 90°C / 194°F.

☞ **CPU/POWER/SYSTEM FAN Fail Warning**

- ▶▶ Disabled Fan warning function disable. (Default value)
- ▶▶ Enabled Fan warning function enable.

☞ **CPU Smart FAN Control**

- ▶▶ Disabled Disable this function.
- ▶▶ Enabled Enable CPU Smart Fan control function. (Default value)
 - a. When the CPU temperature is higher than 60 degrees Celsius, CPU fan will run at full speed.
 - b. When the CPU temperature is between 50 and 60 degrees Celsius, CPU fan will run at high speed.
 - c. When the CPU temperature is between 40 and 50 degrees Celsius, CPU fan will run at medium speed.
 - d. When the CPU temperature is lower than 40 degrees Celsius, CPU fan will run at low speed.

MB Intelligent Tweaker(M.I.T.)

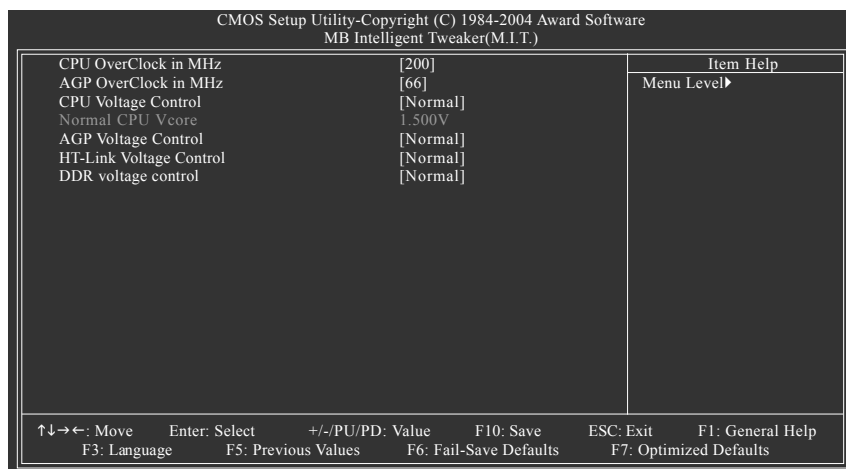

CAUTION

Incorrect using these features may cause your system broken. For power End-User use only!

- ☞ **CPU OverClock in MHz**
 - ▶▶ 200MHz ~ 300MHz Increase CPU frequency as user selected.
- ☞ **AGP OverClock in MHz**
 - ▶▶ 66MHz ~ 100MHz Increase AGP frequency as user selected.
- ☞ **CPU Voltage Control**
 - ▶▶ Supports adjustable CPU Vcore from 0.800V to 1.700V by 0.025V step.
(Default value: Normal)
- ☞ **Normal CPU Vcore**
 - ▶▶ Display your CPU Vcore voltage.
- ☞ **AGP Voltage Control**
 - ▶▶ Normal Set AGP voltage as AGP required. (Default value)
 - ▶▶ +0.1v Increase AGP voltage +0.1V.
 - ▶▶ +0.2v Increase AGP voltage +0.2V.
 - ▶▶ +0.3v Increase AGP voltage +0.3V.
- ☞ **HT-Link Voltage Control**
 - ▶▶ Normal Supply HT-Link voltage as HT-Link required. (Default value)
 - ▶▶ +0.1v Increase HT-Link voltage +0.1V.
 - ▶▶ +0.2v Increase HT-Link voltage +0.2V.
 - ▶▶ +0.3v Increase HT-Link voltage +0.3V.
- ☞ **DDR voltage control**
 - ▶▶ Normal Supply DDR voltage as DDR required. (Default value)
 - ▶▶ +0.1v Increase DDR voltage +0.1V.
 - ▶▶ +0.2v Increase DDR voltage +0.2V.

Top Performance

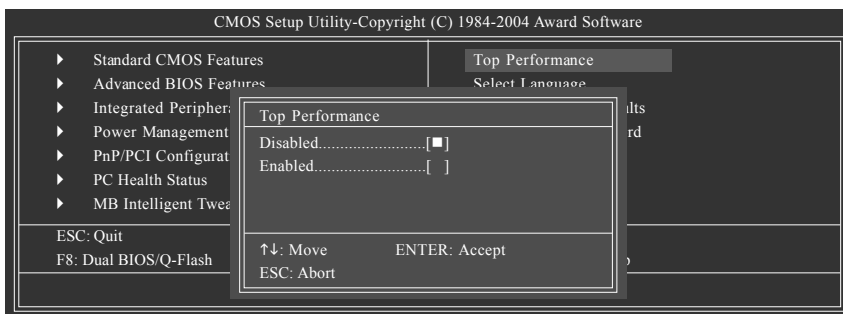

If you wish to maximize the performance of your system, set "Top Performance" as "Enabled".

▶▶ Disabled Disable this function. (Default Value)

▶▶ Enabled Enable Top Performance function.

⚠* "Top Performance" will increase H/W working speed. Different system configuration (both H/W component and OS) will effect the result. For example, the same H/W configuration might not run properly with Windows XP, but works smoothly with Windows NT. Therefore, if your system is not perform enough, the reliability or stability problem will appear sometimes, and we will recommend you disabling the option to avoid the problem as mentioned above.

Select Language

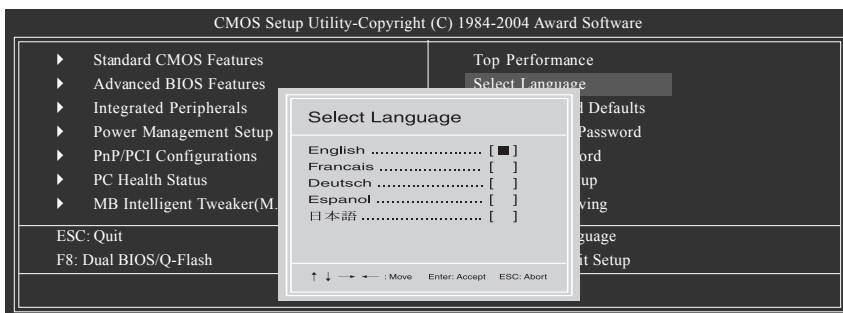

Multi-Language BIOS supports 5 languages. There are English, French, German, Spanish, Japanese.

Load Optimized Defaults

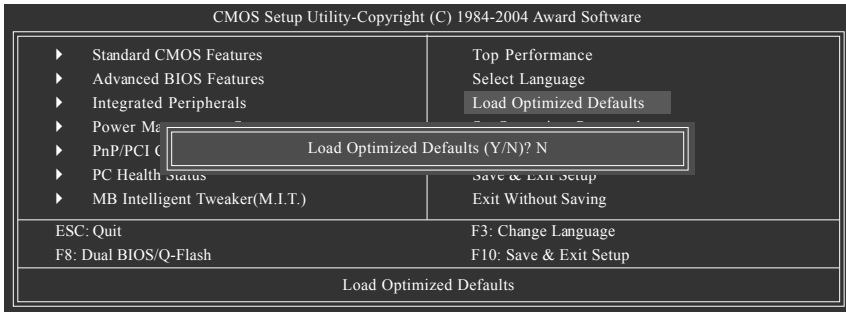

Selecting this field loads the factory defaults for BIOS and Chipset Features which the system automatically detects.

Set Supervisor/User Password

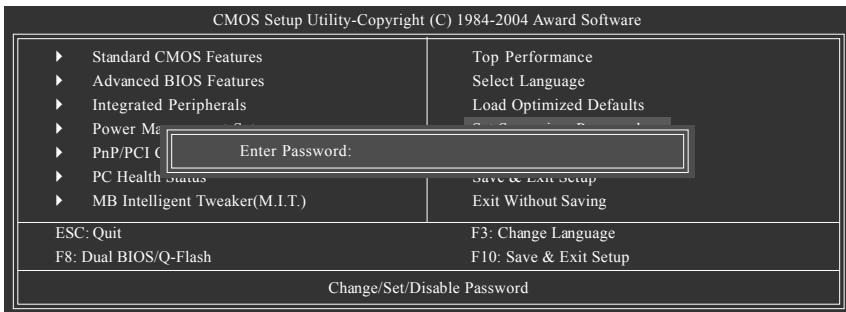

When you select this function, the following message will appear at the center of the screen to assist you in creating a password.

Type the password, up to eight characters, and press <Enter>. You will be asked to confirm the password. Type the password again and press <Enter>. You may also press <Esc> to abort the selection and not enter a password.

To disable password, just press <Enter> when you are prompted to enter password. A message "PASSWORD DISABLED" will appear to confirm the password being disabled. Once the password is disabled, the system will boot and you can enter Setup freely.

The BIOS Setup program allows you to specify two separate passwords: SUPERVISOR PASSWORD and a USER PASSWORD. When disabled, anyone may access all BIOS Setup program function. When enabled, the Supervisor password is required for entering the BIOS Setup program and having full configuration fields, the User password is required to access only basic items.

If you select "System" at "Password Check" in Advance BIOS Features Menu, you will be prompted for the password every time the system is rebooted or any time you try to enter Setup Menu.

If you select "Setup" at "Password Check" in Advance BIOS Features Menu, you will be prompted only when you try to enter Setup.

Save & Exit Setup

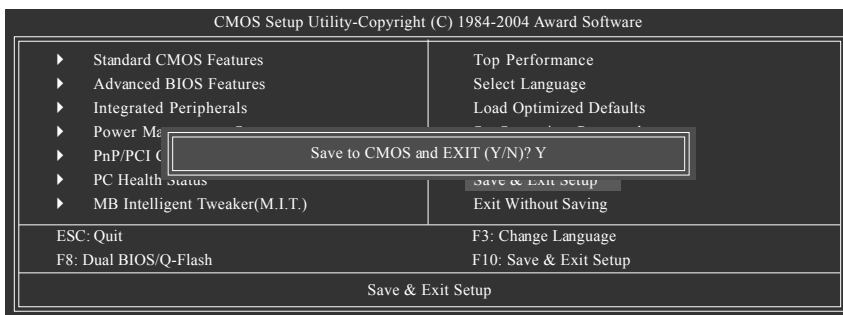

Type "Y" will quit the Setup Utility and save the user setup value to RTC CMOS.
Type "N" will return to Setup Utility.

Exit Without Saving

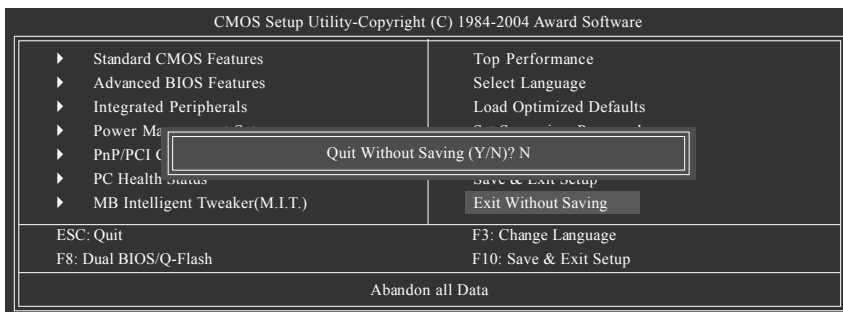

Type "Y" will quit the Setup Utility without saving to RTC CMOS.
Type "N" will return to Setup Utility.

Chapter 4 Technical Reference

@BIOS™ Introduction

Gigabyte announces @BIOS Windows BIOS Live Update Utility



Have you ever updated BIOS by yourself? Or like many other people, you just know what BIOS is, but always hesitate to update it? Because you think updating newest BIOS is unnecessary and actually you don't know how to update it.

Maybe not like others, you are very experienced in BIOS updating and spend quite a lot of time to do it. But of course you don't like to do it too much. First, download different BIOS from website and then switch the operating system to DOS mode. Secondly, use different flash utility to update BIOS. The above process is not a interesting job. Besides, always be carefully to store the BIOS source code correctly in your disks as if you update the wrong BIOS, it will be a nightmare.

Certainly, you wonder why motherboard vendors could not just do something right to save your time and effort and save you from the lousy BIOS updating work? Here it comes! Now Gigabyte announces @BIOS - the first Windows BIOS live update utility. This is a smart BIOS update software. It could help you to download the BIOS from internet and update it. Not like the other BIOS update software, it's a Windows utility. With the help of "@BIOS", BIOS updating is no more than a click.

Besides, no matter which mainboard you are using, if it's a Gigabyte's product, @BIOS help you to maintain the BIOS. This utility could detect your correct mainboard model and help you to choose the BIOS accordingly. It then downloads the BIOS from the nearest Gigabyte ftp site automatically. There are several different choices; you could use "Internet Update" to download and update your BIOS directly. Or you may want to keep a backup for your current BIOS, just choose "Save Current BIOS" to save it first. You make a wise choice to use Gigabyte, and @BIOS update your BIOS smartly. You are now worry free from updating wrong BIOS, and capable to maintain and manage your BIOS easily. Again, Gigabyte's innovative product erects a milestone in motherboard industries.

For such a wonderful software, how much it costs? Impossible! It's free! Now, if you buy a Gigabyte's motherboard, you could find this amazing software in the attached driver CD. But please remember, connected to internet at first, then you could have a internet BIOS update from your Gigabyte @BIOS.

Flash BIOS Method Introduction

Method 1 : Dual BIOS / Q-Flash

A. What is Dual BIOS Technology?

Dual BIOS means that there are two system BIOS (ROM) on the motherboard, one is the Main BIOS and the other is Backup BIOS. Under the normal circumstances, the system works on the Main BIOS. If the Main BIOS is corrupted or damaged, the Backup BIOS can take over while the system is powered on. This means that your PC will still be able to run stably as if nothing has happened in your BIOS.

B. How to use Dual BIOS and Q-Flash Utility?

- 1.) After power on the computer, pressing immediately during POST (Power On Self Test) it will allow you to enter Award BIOS CMOS SETUP, then press <F8> to enter Flash utility.

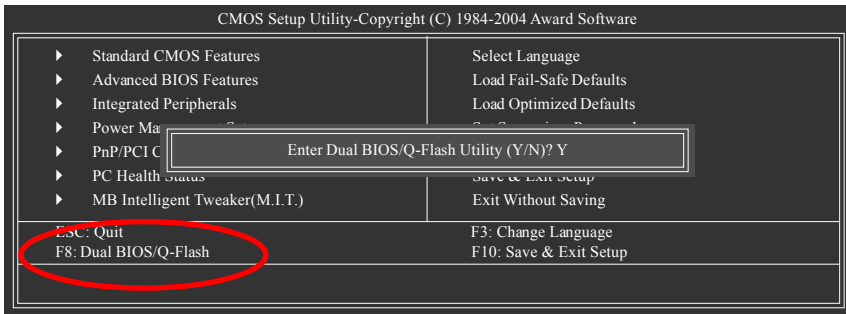

- 2.) Award Dual BIOS Flash ROM Programming Utility

Dual BIOS Utility V1.33		
Boot From.....	Main Bios	
Main ROM Type/Size.....	SST 39SF040	512K
Backup ROM Type/Size.....	SST 39SF040	512K
	Wide Range Protection	Disable
	Boot From	Main Bios
	Auto Recovery	Enable
	Halt On Error	Disable
	Keep DMI Data	Enable
	Copy Main ROM Data to Backup	
	Load Default Settings	
	Save Settings to CMOS	
	Q-Flash Utility	
	Update Main BIOS from Floppy	
	Update Backup BIOS from Floppy	
	Save Main BIOS to Floppy	
	Save Backup BIOS to Floppy	
PgDn/PgUp: Modify	↑↓: Move	ESC: Reset F10: Power Off

3.) Dual BIOS Item explanation:

- **Wide Range Protection: Disable(Default), Enable**

Status 1:

If any failure (ex. Update ESCD failure, checksum error or reset...) occurs in the Main BIOS, just before the Operating System is loaded and after the power is on, and that the Wide Range Protection is set to "Enable", the PC will boot from Backup BIOS automatically.

Status 2:

If the ROM BIOS on peripherals cards(ex. SCSI Cards, LAN Cards...) emits signals to request restart of the system after the user make any alteration on it, the boot up BIOS will not be changed to the Backup BIOS.

- **Boot From : Main BIOS(Default), Backup BIOS**

Status 1: The user can set to boot from main BIOS or Backup BIOS.

Status 2: If one of the main BIOS or the Backup BIOS fails, this item "*Boot From : Main BIOS(Default)*" will become gray and will not be changed by user.

- **Auto Recovery : Enable(Default), Disable**

When one of the Main BIOS or Backup BIOS occurs checksum failure, the working BIOS will automatically recover the BIOS of checksum failure.

(In the Power Management Setup of the BIOS Setting, if ACPI Suspend Type is set to Suspend to RAM, the Auto Recovery will be set to Enable automatically.)

(If you want to enter the BIOS setting, please press "Del" key when the boot screen appears.)

- **Halt On Error : Disable(Default), Enable**

If the BIOS occurs a checksum error or the Main BIOS occurs a WIDE RANGE PROTECTION error and Halt On Error set to Enable, the PC will show messages on the boot screen, and the system will pause and wait for the user's instruction.

If Auto Recovery : **Disable**, it will show *<or the other key to continue.>*

If Auto Recovery : **Enable**, it will show *<or the other key to Auto Recover.>*

- **Keep DMI Data : Enable(Default), Disable**

Enable: The DMI data won't be replaced by flashing new BIOS. (recommend)

Disable: The DMI data will be replaced by flashing new BIOS.

- **Copy Main ROM Data to Backup**

(If you boot from Backup ROM, this item will change to "Copy Backup ROM Data to Main")

Auto recovery message:

BIOS Recovery: Main to Backup

The means that the Main BIOS works normally and could automatically recover the Backup BIOS.

BIOS Recovery: Backup to Main

The means that the Backup BIOS works normally and could automatically recover the Main BIOS. (This auto recovery utility is set by system automatically and can't be changed by user.)

- **Load Default Settings**

Load dual BIOS default value.

- **Save Settings to CMOS**

Save revised setting.

C. What is Q-Flash Utility?

Q-Flash utility is a pre-O.S. BIOS flash utility enables users to update its BIOS within BIOS mode, no more fooling around any OS.

D. How to use Q-Flash?

Update Main BIOS from Floppy / Update Backup BIOS from Floppy

 In the A: drive, insert the "BIOS" diskette, then Press Enter to Run.

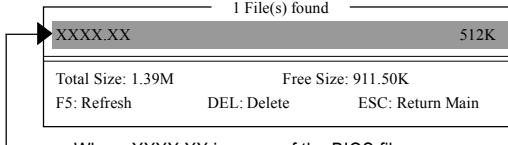

Where XXXX.XX is name of the BIOS file.

 Press Enter to Run.

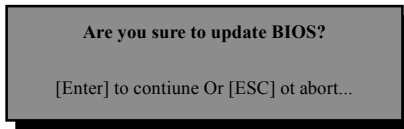

 Press Enter to Run.

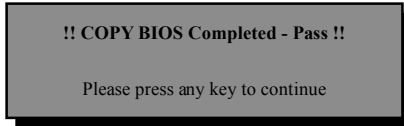

Congratulation! You have completed the flashed and now can restart system.

Save Main BIOS to Floppy / Save Backup BIOS to Floppy

 In the A:drive, insert the floppy disk, then Press Enter to Run.

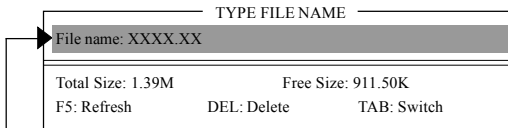

To name the file.

Congratulate you have accomplished the saving.

CONTROL KEYS

<PgDn/PgUp>	Make changes
<↑>	Move to previous item
<↓>	Move to next item
<Enter>	Run
<Esc>	Reset
<F10>	Power Off



DualBIOS™ Technology FAQ

GIGABYTE Technology is pleased to introduce DualBIOS technology, a hot spare for your system BIOS. This newest "Value-added" feature, in a long series of innovations from GIGABYTE, is available on this motherboard. Future GIGABYTE motherboards will also incorporate this innovation.

What's DualBIOS™?

On GIGABYTE motherboards with DualBIOS there are physically two BIOS chips. For simplicity we'll call one your "Main BIOS" and the other we'll call your "Backup BIOS" (your "hot spare"). If your Main BIOS fails, the Backup BIOS almost automatically takes over on your next system boot. Almost automatically and with virtually zero down time! Whether the problem is a failure in flashing your BIOS or a virus or a catastrophic failure of the Main BIOS chip, the result is the same - the Backup BIOS backs you up, almost automatically.

I. Q: What is DualBIOS™ technology?

Answer:

DualBIOS technology is a patented technology from Giga-Byte Technology. The concept of this technology is based on the redundancy and fault tolerance theory. DualBIOS™ technology simply means there are two system BIOSes (ROM) integrated onto the motherboard. One is a main BIOS, and the other is a backup BIOS. The mainboard will operate normally with the main BIOS, however, if the main BIOS is corrupt or damaged for various reasons, the backup BIOS will be automatically used when the system powered-On. Your PC will operate as before the main BIOS was damaged, and is completely transparent to the user.

II. Q: Why does anyone need a motherboard with DualBIOS™ technology?

Answer:

In today's systems there are more and more BIOS failures. The most common reasons are virus attacks, BIOS upgrade failures, and/or deterioration of the BIOS (ROM) chip itself.

1. New computer viruses are being found that attack and destroy the system BIOS. They may corrupt your BIOS code, causing your PC to be unstable or even not boot normally.
2. BIOS data will be corrupted if a power loss/surge occurs, or if a user resets the system, or if the power button is pressed during the process of performing a system BIOS upgrade.
3. If a user mistakenly updates their mainboard with the incorrect BIOS file, then the system may not be able to boot correctly. This may cause the PC system hang in operation or during boot.
4. A flash ROM's life cycle is limited according to electronic characteristics. The modern PC utilizes the Plug and Play BIOS, and is updated regularly. If a user changes peripherals often, there is a slight chance of damage to the flash ROM.

With Giga-Byte Technology's patented DualBIOS™ technology you can reduce the possibility of hangs during system boot up, and/or loss BIOS data due to above reasons.

This new technology will eliminate valuable system down time and costly repair bills cause by BIOS failures.

III. Q: How does DualBIOS™ technology work?

Answer:

This new technology will eliminate valuable system down time and costly repair bills cause by BIOS failures.

1. DualBIOS™ technology provides a wide range of protection during the boot up procedure. It protects your BIOS during system POST, ESCD update, and even all the way to PNP detection/assignment.
2. DualBIOS™ provides automatic recovery for the BIOS. When the first BIOS used during boot up does not complete or if a BIOS checksum error occurs, boot-up is still possible. In the DualBIOS™ utility, the "Auto Recovery" option will guarantee that if either the main BIOS or backup BIOS is corrupted, the DualBIOS™ technology will use the good BIOS and correct the wrong BIOS automatically.
3. DualBIOS™ provides manual recovery for the BIOS. DualBIOS™ technology contains a built-in flash utility, which can flash your system BIOS from backup to main and/or visa versa. There is no need for an OS-dependent flash utility program.
4. DualBIOS™ contains a one-way flash utility. The built-in one-way flash utility will ensure that the corrupt BIOS is not mistaken as the good BIOS during recovery and that the correct BIOS (main vs. backup) will be flashed. This will prevent the good BIOS from being flashed.

IV. Q: Who Needs DualBIOS™ technology?

Answer:

This new technology will eliminate valuable system down time and costly repair bills cause by BIOS failures.

1. Every user should have DualBIOS™ technology due to the advancement of computer viruses. Everyday, there are new BIOS-type viruses discovered that will destroy your system BIOS. Most commercial products on the market do not have solutions to guard against this type of virus intrusion. The DualBIOS™ technology will provide a state-of-the-art solution to protect your PC:

Case I.) Vicious computer viruses may wipe out your entire system BIOS. With a conventional single system BIOS PC, the PC will not be functional until it is sent for repairs.

Case II.) If the "Auto Recovery" option is enabled in the DualBIOS™ utility, and if a virus corrupts your system BIOS, the backup BIOS will automatically reboot the system and correct the main BIOS.

Case III.) A user may override booting from the main system BIOS. The DualBIOS™ utility may be entered to manually change the boot sequence to boot from the backup BIOS.

2. During or after a BIOS upgrade, if DualBIOS™ detects that the main BIOS is corrupt, the backup BIOS will take over the boot-up process automatically. Moreover, it will verify the main and backup BIOS checksums when booting-up. DualBIOS™ technology examines the checksum of the main and backup BIOS while the system is powered on to guarantee your BIOS operates properly.
3. Power Users will have the advantage of having two BIOS versions on their mainboard. The benefit is being able to select either version BIOS to suit the performance system needs.
4. Flexibility for high-end desktop PCs and workstation/servers. In the DualBIOS™ utility, the option can be set, "Halt On When BIOS Defects" to be enabled to halt your system with awarning message that the main BIOS has been corrupted. Most workstation/servers require constant operation to guarantee services have not been interrupted. In this situation, the "Halt On When BIOS Defects" message may be disabled to avoid system pauses during normal booting. Another advantage you gain from Giga-Byte's DualBIOS™ technology is the ability to upgrade from

Method 2 : @BIOS™ Utility

If you don't have DOS boot disk, we recommend that you used Gigabyte @BIOS™ program to flash BIOS.

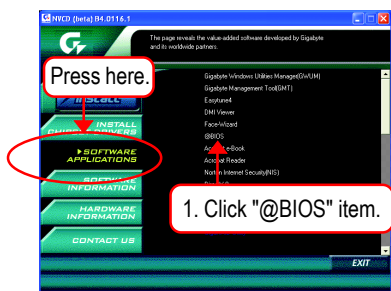

(1)

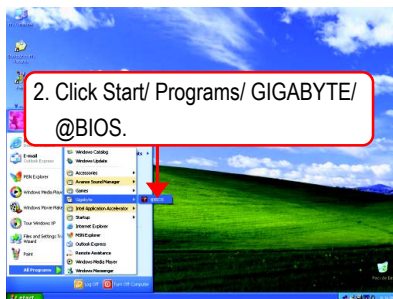

(2)

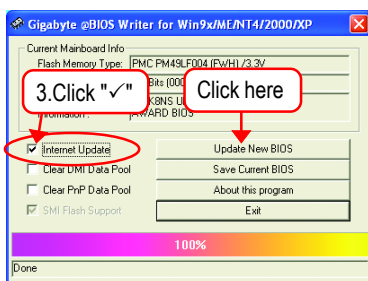

(3)

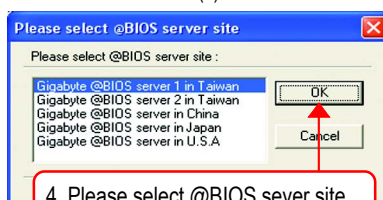

(4)

Methods and steps:

1. Update BIOS through Internet:
 - a. Click "Internet Update" icon
 - b. Click "Update New BIOS" icon
 - c. Select @BIOS™ sever
 - d. Select the exact model name on your motherboard
 - e. System will automatically download and update the BIOS.
2. Update BIOS NOT through Internet:
 - a. Do not click "Internet Update" icon
 - b. Click "Update New BIOS"
 - c. Please select "All Files" in dialog box while opening the old file.
 - d. Please search for BIOS unzip file, downloading from internet or any other methods.
(such as: K8NSU939.E1).
 - e. Complete update process following the instruction.

3. Save BIOS

In the very beginning, there is "Save Current BIOS" icon shown in dialog box. It means to save the current BIOS version.

4. Check out supported motherboard and Flash ROM:

In the very beginning, there is "About this program" icon shown in dialog box. It can help you check out which kind of motherboard and which brand of Flash ROM are supported.

Note:

- a. In method I, if it shows two or more motherboard's model names to be selected, please make sure your motherboard's model name again. Selecting wrong model name will cause the system unbooted.
- b. In method II, be sure that motherboard's model name in BIOS unzip file are the same as your motherboard's. Otherwise, your system won't boot.
- c. In method I, if the BIOS file you need cannot be found in @BIOS™ server, please go onto Gigabyte's web site for downloading and updating it according to method II.
- d. Please note that any interruption during updating will cause system unbooted.

The installation of windows 98SE/2K/ME/XP is very simple. Please follow next step to install the function!

Stereo Speakers Connection and Settings:

We recommend that you use the speaker with amplifier to acquire the best sound effect if the stereo output is applied.

STEP 1:

Connect the stereo speakers or earphone to "Line Out".



Line Out

STEP 2 :

Following installation of the audio driver, you find a icon a Sound Effect  on the lower right hand taskbar. Click the icon to select the function.

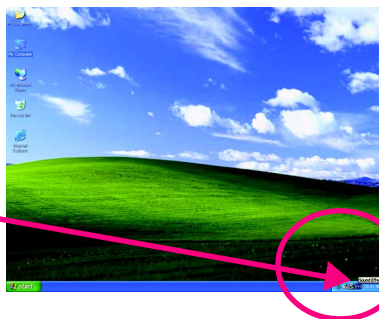
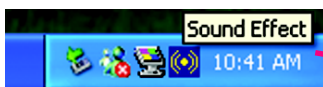

STEP 3:

Click "Speaker Configuration" then click on the left selection bar and select "2CH Speaker" to complete 2 channel audio configuration.

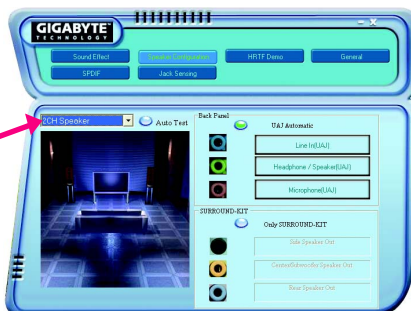
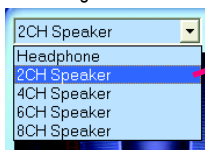

4 Channel Analog Audio Output Mode

STEP 1 :

Connect the front channels to "Line Out", the rear channels to "Line In".



Line Out Line In

STEP 2 :

Following installation of the audio driver, you find a icon a Sound Effect  on the lower right hand taskbar. Click the icon to select the function.

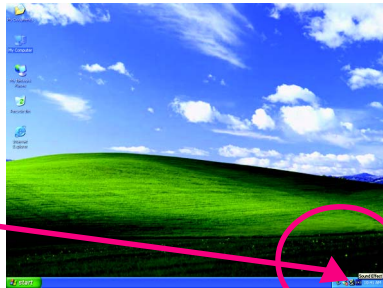

STEP 3 :

Click "Speaker Configuration" and select the "UAJ Function". Then click on the left selection bar and select "4CH Speaker" to complete 4 channel audio configuration.

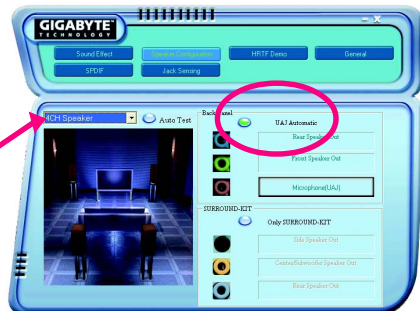

6 Channel Analog Audio Output Mode

Use the back audio panel to connect the audio output without any additional module.

STEP 1 :

Connect the front channels to "Line Out", the rear channels to "Line In", and the Center/Subwoofer channels to "MIC In".

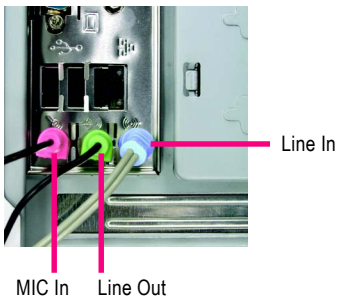

STEP 2 :

Following installation of the audio driver, you find a Sound Effect icon on the lower right hand taskbar. Click the icon to select the function.



STEP 3 :

Click "Speaker Configuration" and select the "UAJ Function". Then click on the left selection bar and select "6CH Speaker" to complete 6 channel audio configuration.

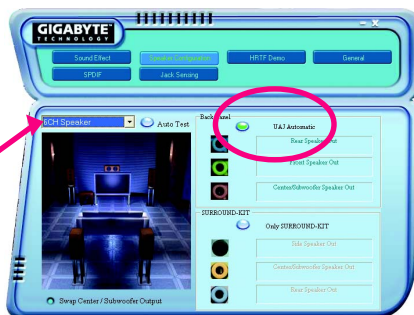

8 Channel Audio Setup (using Audio Combo Kit, Optional Device):

Audio Combo Kit offers SPDIF output, an optical and coaxial cable and a Surround-Kit. The Surround-Kit offers R/L surround, center/subwoofer output and rear surround.



STEP 1 :

Secure the Audio Combo Kit at the panel on the back of the case.



STEP 2 :

Connect the Surround-Kit to the SUR_CEN connector located on the motherboard.

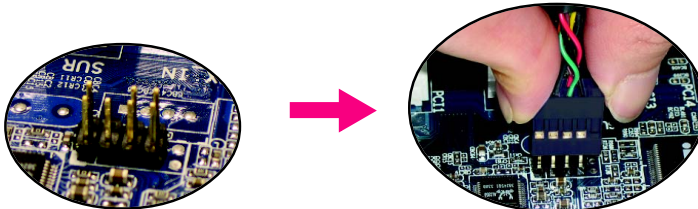

STEP 3 :

There are two methods of 8 channel audio configuration:

Method 1:

Connect the front channels to the "LINE OUT" port located on the audio panel and the rear channels to the Surround-Kit "REAR R/L" port. Connect the center/subwoofer channels to the Surround-Kit "SUB CENTER" and the R/L channels to the Surround-Kit "SUR BACK" port.

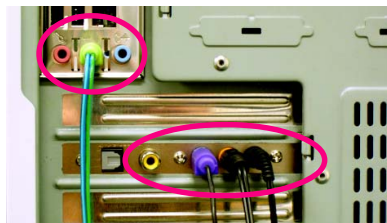

Method 2:

Connect the front channels to the "LINE OUT" port located on the audio panel and the rear channels to the "LINE IN" port. Connect the center/subwoofer channels to the "MIC IN" port located on the audio panel and the R/L channels to the Surround-Kit "SUR BACK" port. (This method requires UAJ function)

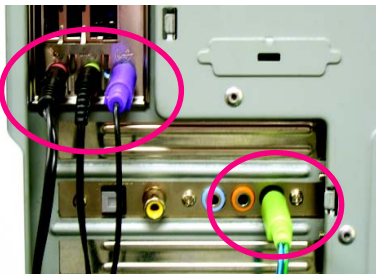

STEP 4 :

Following installation of the audio driver, you find a icon a Sound Effect  icon on the lower right hand taskbar. Click the icon to select the function.

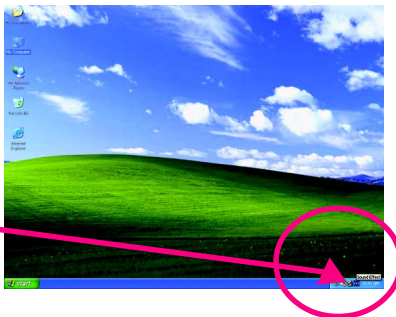

STEP 5 :

Click "Speaker Configuration" and select both the "UAJ Function" and "Only Surround-Kit". Then click on the left selection bar and select "8CH Speaker" to complete 8 channel audio configuration.



Sound Effect Configuration:

At the sound effect menu, users can adjust sound option settings as desired.



SPDIF Output Device (Optional Device)

A "SPDIF output" device is available on the motherboard. Cable with rear bracket is provided and could link to the "SPDIF output" connector (As picture.) For the further linkage to decoder, rear bracket provides coaxial cable and Fiber connecting port.

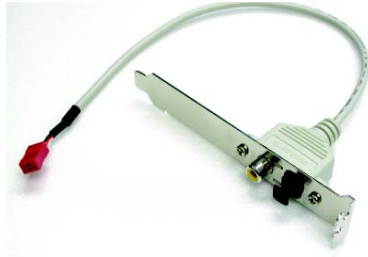

1. Connect the SPDIF output device to the rear bracket of PC, and fix it with screw.



2. Connect SPDIF device to the motherboard.

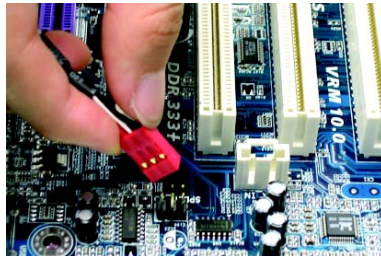

3. Connect SPDIF to the SPDIF decoder.



Jack-Sensing and UAJ Introduction

Jack-Sensing provides audio connectors error-detection function.



Install Microsoft DirectX8.1 or later version before to enable Jack-Sensing support for Windows 98/98SE/2000/ME.

Jack-Sensing includes 2 parts: AUTO and MANUAL. Following is an example for 2 channels (Windows XP):

Introduction of audio connectors

You may connect CDROM, Walkman or others audio input devices to Line In jack, speakers, earphone or others output devices to Line Out jack, and microphone to MIC In jack.

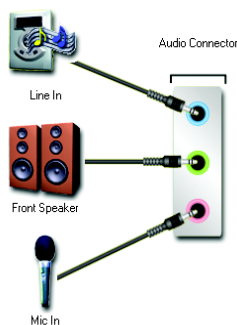

Auto-detecting:

Please connect the devices to the right jacks as above. A window will appear as right picture if you setup the devices properly.

Please note that 3D audio function will only appear when 3D audio inputs.



If you set wrong with the connectors, the warning message will come out as right picture.

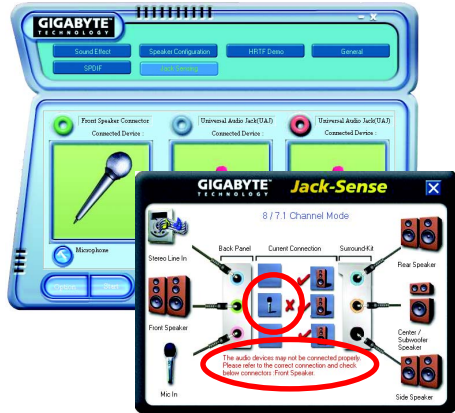

Manual setting:

If the device picture shows different from what you set, please press "Manual Selection" to set.

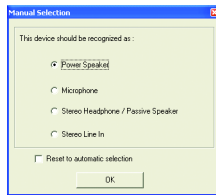

UAJ Introduction

UAJ (Universal Audio Jack) has a very smart feature: It will switch signal automatically when user plugs his audio device to the wrong jack (Line-in/ Line-out). That means users do not need to worry the audio device should be plug in Line-in or Line-out jack, the device will work perfectly after UAJ is activated.

Enable UAJ function:

You can click "UAJ Automatic" button to enable UAJ function.

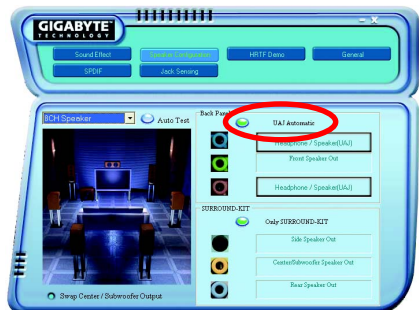

Xpress Recovery Introduction

What is Xpress Recovery ?

Xpress Recovery is a utility used to back up and restore an OS partition. If the hard drive is not working properly, the user can restore the drive to its original state.



1. Supports FAT16, FAT32, and NTFS formats
2. Must be connected to the IDE1 Master
3. Allows installation of only one OS
4. Must be used with an IDE hard disk supporting HPA
5. The first partition must be set as the boot partition. When the boot partition is backed up, please do not alter its size.
6. Xpress Recovery is recommended when using Ghost to return boot manager to NTFS format.

How to use the Xpress Recovery

1. Boot from CD-ROM (BMP Mode)

Enter the BIOS menu, select "Advanced BIOS Feature" and set to boot from CD-ROM. Insert the provided driver CD into your CD drive, then save and exit the BIOS menu. Once the computer has restarted, the phrase "Boot from CD:" will appear at the bottom left-hand corner of the screen. When "Boot from CD:" appears, press any key to enter Xpress Recovery. Once you have completed this step, subsequent access to Xpress Recovery can also function by pressing the F9 key during computer power on.

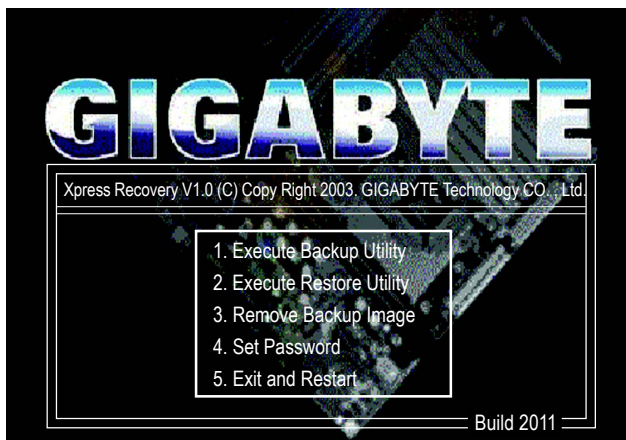

2. Press F9 during powering on the computer. (Text Mode)

Press F9 during powering on the computer.

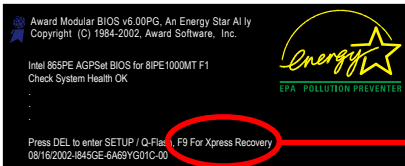

F9 For Xpress Recovery

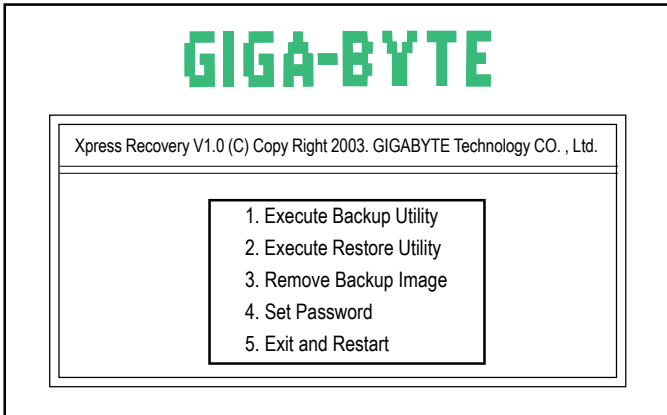

NOTE

1. If you have already entered Xpress Recovery by booting from the CD-ROM, you can enter Xpress Recovery in the future by pressing the F9 key.
2. System storage capacity as well as drive reading/writing speed will affect backup speed.
3. It is recommended that Xpress Recovery be immediately installed after OS and all required driver and software installations are complete.

1. Execute Backup Utility:

Press B to Backup your System or Esc to Exit

The backup utility will automatically scan your system and back up data as a backup image in your hard drive.



Not all systems support access to Xpress Recovery by pressing the F9 key during computer power on. If this is the case, please use the boot from CD-ROM method to enter Xpress Recovery.

2. Execute Restore Utility:

This program will recover your system to factory default.

Press R to restore your system back to factory default or press Esc to exit

Restores backup image to original state.

3. Remove Backup Image:

Remove backup image. Are you sure? (Y/N)

Remove the backup image.

4. Set Password:

Please input a 4-16 character long password (a-z or 0-9) or press Esc to exit

You can set a password to enter Xpress Recovery to protect your hard disk data. Once this is done, password input will be required to enter Xpress Recovery during the next as well as subsequent system restarts. If you wish to remove the need for password entry, please select "Set Password" and under "New Password/Confirm Password", make sure there is no entry and then press "Enter" to remove password requirement.

5. Exit and Restart:

Exit and restart your computer.

Serial ATA BIOS Setting Utility Introduction

RAID Levels

RAID (Redundant Array of Independent Disks) is a method of combining two hard disk drives into one logical unit. The advantage of an Array is to provide better performance or data fault tolerance. Fault tolerance is achieved through data redundant operation, where if one drives fails, a mirrored copy of the data can be found on another drive. This can prevent data loss if the operating system fails or hangs. The individual disk drives in an array are called members. The configuration information of each member is recorded in the reserved sector that identifies the drive as a member. All disk members in a formed disk array are recognized as a single physical drive to the operating system.

Hard disk drives can be combined together through a few different methods. The different methods are referred to as different RAID levels. Different RAID levels represent different performance levels, security levels and implementation costs. The RAID levels which the nVIDIA nForce3 Ultra chipset supports are RAID 0, RAID 1, RAID 0+1 and JBOD.

RAID 0 (Striping)

RAID 0 reads and writes sectors of data interleaved between multiple drives. If any disk member fails, it affects the entire array. The disk array data capacity is equal to the number of drive members times the capacity of the smallest member. The striping block size can be set from 4KB to 64KB. RAID 0 does not support fault tolerance.

RAID 1 (Mirroring)

RAID 1 writes duplicate data onto a pair of drives and reads both sets of data in parallel. If one of the mirrored drives suffers a mechanical failure or does not respond, the remaining drive will continue to function. Due to redundancy, the drive capacity of the array is the capacity of the smallest drive. Under a RAID 1 setup, an extra drive called the spare drive can be attached. Such a drive will be activated to replace a failed drive that is part of a mirrored array. Due to the fault tolerance, if any RAID 1 drive fails, data access will not be affected as long as there are other working drives in the array.

RAID 0+1 (Striping + Mirroring)

RAID 0+1 combines the performance of data striping (RAID 0) and the fault tolerance of disk mirroring (RAID 1). Data is striped across multiple drives and duplicated on another set of drives.

JBOD (Spanning)

A spanning disk array is equal to the sum of the all drives when the drives used are having different capacities. Spanning stores data onto a drive until it is full, then proceeds to store files onto the next drive in the array. When any disk member fails, the failure affects the entire array. JBOD is not really a RAID and does not support fault tolerance.

Please follow the steps below to construct a complete RAID array:

- 1) Have ready your hard drives for RAID construction.
Note: To achieve best performance, it is recommended that the hard drives used are of similar make and storage capacity.
- 2) Please attach the hard drive connectors to their appropriate location on the motherboard ie. IDE, SCSI, or SATA.
- 3) Enter the motherboard BIOS and locate RAID setup (Please refer to the section on Integrated Peripherals).
- 4) Enter RAID setup in the BIOS and select the RAID type (For instance, enter F10 to select NVIDIA RAID; Ctrl + S to select Silicon Image).
- 5) Complete driver installation.
- 6) Complete RAID utility installation.

More information on steps 4 and 5 is provided. (For more detailed setup information, please visit our website at <http://www.gigabyte.com.tw>)

Configuring the NVIDIA RAID BIOS

The NVRAID BIOS setup lets you choose the RAID array type and which hard drives you want to make part of the array.

Entering the RAID BIOS Setup

1. After rebooting your computer, wait until you see the RAID software prompting you to press **F10**. The RAID prompt appears as part of the system POST and boot process prior to loading the OS. You have a few seconds to press F10 before the window disappears.

```
NVIDIA RAID IDE ROM BIOS 4.22
Copyright (C) 2003 NVIDIA Corp.

Detecting array ...

Press F10 to enter RAID setup utility ...
```

2. Press F10.

The NVIDIA RAID Utility - **Define a New Array** window appears (as Figure below).

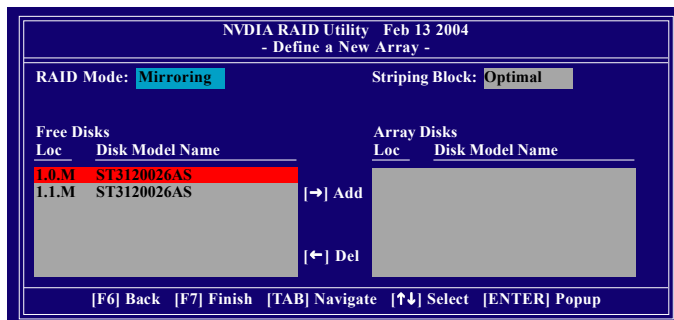

Using the "Define a New Array" Window

If necessary, press the tab key to move from field to field until the appropriate field is highlighted.

Selecting the RAID Mode

By default, this is set to Mirroring. To change to a different RAID mode, press the down arrow key until the mode that you want appears in the RAID Mode box - either Mirroring, Striping, Spanning, or Stripe Mirroring.

Selecting the Striping Block Size

Striping block size is given in kilobytes, and affects how data is arranged on the disk. It is recommended to leave this value at the default Optimal, which is 32KB, but the values can be between 4 KB and 128 KB.

Assigning the Disks

The disks that you enabled from the RAID Config BIOS setup page appear in the Free Disks block. These are the drives that are available for use as RAID array disks. To designate a free disk to be used as a RAID array disk,

1. Tab to the Free Disks section. The first disk in the list is selected.
2. Move it from the Free Disks block to the Array Disks block by pressing the rightarrow key (→). The first disk in the list is moved, and the next disk in the list is selected and ready to be moved.
3. Continue pressing the right-arrow key (→) until all the disks that you want to use as RAID array disks appear in the Array Disks block.

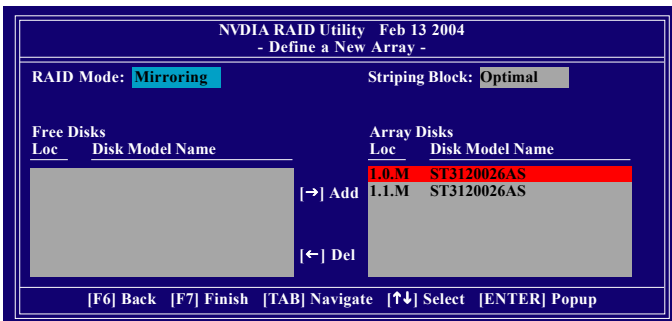

Completing the RAID BIOS Setup

After assigning your RAID array disks, press F7. The **Clear disk data** prompt appears.

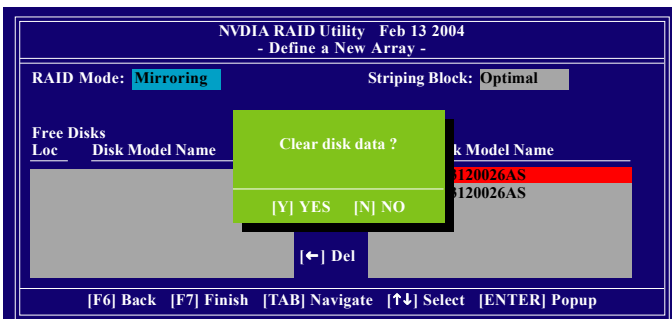

Press **Y** if you want to wipe out all the data from the RAID array, otherwise press **N**. You must choose **Yes** if the drives were previously used as RAID drives. The **Array List** window appears, where you can review the RAID arrays that you have set up.

You can select a disk array as boot device if you want to boot operating system from an array. Use the arrow keys to select the array, then press **B** to specify the array as bootable.

NVIDIA RAID Utility Feb 13 2004					
- Array List -					
Boot	Id	Status	Vendor	Array Model Name	
BBS	2	Health	NVIDIA	MIRROR 111.79G	

[Ctrl-X] Exit [↑↓] Select [B] Set Boot [N] New Array [ENTER] Detail

Press **Enter** to view and verify details. The **Array Detail** screen appears.

The Array Detail screen shows various information about the array that you selected, such as Striping Block used, RAID Mode, Striping Width, Disk Model Name, and disk capacity.

Array 2 : NVIDIA MIRROR 111.79G					
- Array Detail -					
RAID Mode: Mirroring			Striping Block 32K		
Striping Width : 1					
Adapt	Channel	M/S	Index	Disk Model Name	Capacity
1	0	Master	0	ST3120026AS	111.79GB
1	1	Master	1	ST3120026AS	111.79GB

[R] Rebuild [D] Delete [C] Clear Disk [ENTER] Return

If you want to mark this disk as empty and wipe out all its contents, press **C**.

At the prompt, press **Y** to wipe out all the data, otherwise press **N**.

Press **Enter** again to go back to the previous screen and then press **Ctrl + X** to exit the RAID setup.

Now that the RAID setup has been configured from the RAID BIOS, the next step is to configure and load drivers under Windows.

Installing the RAID drivers

For the Windows operating system (Win NT, WinXP, Win2000), for IDE RAID/SCSI/Serial ATA functioning, the driver must first be transferred to a floppy disk. Please follow the steps below to complete driver transfer to a floppy disk:

- 1) Please insert the provided driver CD into the hard disk drive eg. Drive D:
- 2) Insert a blank formatted floppy disk into the floppy disk drive.
- 3) Either from "Command Prompt" or DOS, please type in "D:\BootDrv\menu.exe"(Refer to Fig.1)
- 4) Information on all chipsets should be listed on the screen (Refer to Fig.2), please select the proper chipset model.

Fig.1

```

Microsoft Windows XP [Version 5.1.2600]
(C) Copyright 1985-2001 Microsoft Corp.

C:\Documents and Settings\Administrator>d:

D:>cd bootdrv

D:\BootDrv>dir/w
Volume in drive D is NUCD
Volume Serial Number is 10D1-6061

Directory of D:\BootDrv

[.]          [..]          265ATA.EXE    265A0P.EXE    265RAID.EXE
265R0P.EXE   276ATA.EXE   276RAID.EXE  8237.EXE     9648ATA.exe
GIGARAID.EXE IAAARAID.EXE MENU.EXE     NUSATA2K.exe NUSATAXP.EXE
SCSI.EXE     S11.EXE       run.bat      3,009,467 bytes free
              17 File(s)
              2 Dir(s)
  
```

Fig.2

```

Microsoft Windows XP [Version 5.1.2600]
(C) Copyright 1985-2001 Microsoft Corp.

C:\Documents and Settings\Administrator>d:

D:>cd bootdrv

D:\BootDrv>dir/w
Volume in drive D is NUCD
Volume Serial Number is 10D1-6061

Directory of D:\BootDrv

[.]          [..]          265ATA.EXE    265A0P.EXE    265RAID.EXE
265R0P.EXE   276ATA.EXE   276RAID.EXE  8237.EXE     9648ATA.exe
GIGARAID.EXE IAAARAID.EXE MENU.EXE     NUSATA2K.exe NUSATAXP.EXE
SCSI.EXE     S11.EXE       run.bat      3,009,467 bytes free
              17 File(s)
              2 Dir(s)

D:\BootDrv>menu
1)IAA_RAID (Note)
2)GIGARAID
3)S11
4)S11RAID
5)SCSI
6)Promise 20276 ATA
7)Promise 20276 RAID
8)Promise 20265 ATA
9)Promise 20265 ATA<XP>
0)Promise 20265 RAID
1)Promise 20265 RAID<XP>
C)UIA 8237 Series ATA
D)SIS 964 SATA
E)NVIDIA Series ATA<XP>
F)NVIDIA Series ATA<2K>
0)exit
  
```

Your system will then automatically zip and transfer this driver file to the floppy disk.

After you complete the steps, boot from the Windows CD to install the RAID drivers.

When install Windows 2000 or Windows XP from HDDs in serial ATA controller, press **F6** as Win2000 or XP boots up, then supply serial ATA controller driver by this floppy disk. Follow on-screen instructions to complete installation.

(Each time you add a new hard drive to a RAID array, the RAID driver will have to be installed under Windows once for that hard drive. After that, the driver will not have to be installed.)

Note: In the menu list, IAA_RAID is Intel ICH5R chipset.

Chapter 5 Appendix

Install Drivers





Pictures below are shown in Windows XP

Insert the driver CD-title that came with your motherboard into your CD-ROM drive, the driver CD-title will auto start and show the installation guide. If not, please double click the CD-ROM device icon in "My computer", and execute the setup.exe.

INSTALL CHIPSET DRIVER

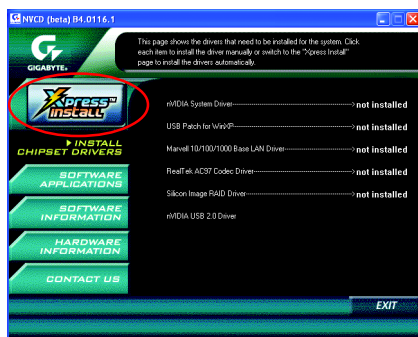
This page shows the drivers that need to be installed for the system. Click each item to install the driver manually or switch to the  to install the drivers automatically.



The "Xpress Install" uses the "Click and Go" technology to install the drivers automatically. Just select the drivers you want then click the "GO" button. The  will execute the installation for you automatically.

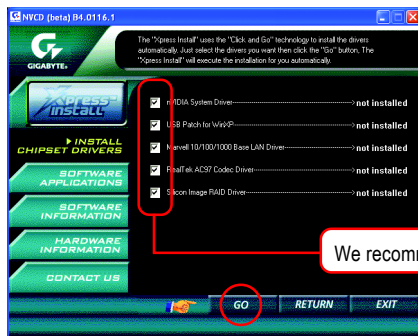

Message: Some device drivers will restart your system automatically. After restarting your system the "Xpress Install" will continue to install other drivers.

We recommend that you install all components in the list.

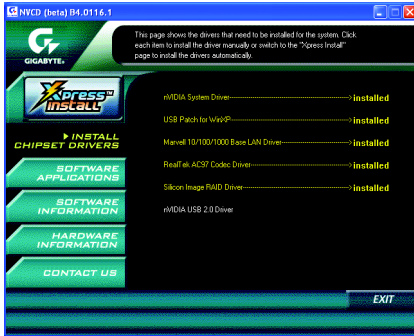

Driver installation finished !
You have to reboot system !

Item Description

- nVIDIA System Driver
For nVIDIA chipset driver.
- USB Patch for WinXP
This patch driver can help you to resolve the USB device wake up S3 hang up issue in XP.
- Marvell 10/100/1000 Base LAN Driver
For Marvell 10/100/1000 LAN chip driver.
- RealTek AC97 Codec Driver
Realtek audio driver.
- Silicon Image RAID Driver
Serial-ATA RAID driver for Silicon Image.
- nVIDIA USB 2.0 Driver
For nVIDIA USB 2.0 enhanced host controller.



For USB2.0 driver support under Windows XP operating system, please use Windows Service Pack. After install Windows Service Pack, it will show a question mark "?" in "Universal Serial Bus controller" under "Device Manager". Please remove the question mark and restart the system (System will auto-detect the right USB2.0 driver).

SOFTWARE APPLICATION

This page reveals the value-added software developed by Gigabyte and its worldwide partners.

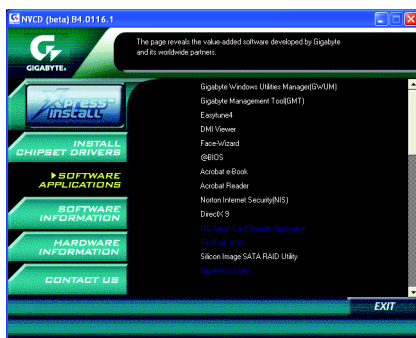

- **Gigabyte Windows Utilities Manager (GWUM)**
This utility can integrate the Gigabyte's applications in the system tray.
- **Gigabyte Management Tool (GMT)**
A useful tool which can manage the computer via the network.
- **EasyTune 4**
Powerful utility that integrates the overclocking and hardware monitoring functions.
- **DMI Viewer**
Windows based utility which is used to browse the DMI/SMBIOS information of the system.
- **Face-Wizard**
New utility for adding BIOS logo.
- **@BIOS**
Gigabyte windows flash BIOS utility.
- **Acrobat e-Book**
Useful utility from Adobe.
- **Acrobat Reader**
Popular utility from Adobe for reading .PDF file format documents.
- **Norton Internet Security (NIS)**
Integrated utility which includes anti-virus, ads, etc.
- **DirectX 9**
Install Microsoft DirectX 9 to enable 3D hardware acceleration that support for operating system to achieve better 3D performance.
- **Silicon Image SATA RAID Utility**
RAID utility for Silicon Image Serial-ATA function.

SOFTWARE INFORMATION

This page list the contents of softwares and drivers in this CD title.

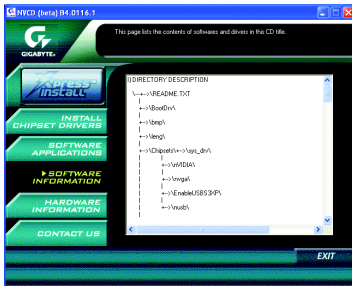

HARDWARE INFORMATION

This page lists all device you have for this motherboard.

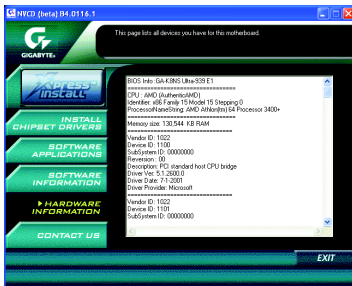

CONTACT US

Please see the last page for details.



FAQ

Below is a collection of general asked questions. To check general asked questions based on a specific motherboard model, please log on to <http://tw.giga-byte.com/faq/faq.htm>

Question 1: I cannot see some options that were included in previous BIOS after updating BIOS. Why?

Answer: Some advanced options are hidden in new BIOS version. Please press Ctrl and F1 keys after entering BIOS menu and you will be able to see these options.

Questions 2: Why is the light of my keyboard/optical mouse still on after computer shuts down?

Answer: In some boards, a small amount of electricity is kept on standby after computer shuts down and that's why the light is still on.

Question 3: Why cannot I use all functions in EasyTune 4?

Answer: The availability of the listed functions in EasyTune 4 depends on the MB chipset. If the chipset doesn't support certain functions in EasyTune 4, these functions will be locked automatically and you will not be able to use them.

Question 4: Why do I fail to install RAID and ATA drivers under Win 2000 and XP on boards that support RAID function after I connect the boot HDD to IDE3 or IDE4 ?

Answer: First of all, you need to save some files in the CD-ROM to a floppy disk before installing drivers. You also need to go through some rather different steps in the installation process. Therefore, we suggest that you refer to the installation steps in the RAID manual at our website.

(Please download it at http://tw.giga-byte.com/support/user_pdf/raid_manual.pdf)

Question 5: How do I clear CMOS?

Answer: If your board has a Clear CMOS jumper, please refer to the Clear CMOS steps in the manual. If your board doesn't have such jumper, you can take off the on-board battery to leak voltage to clear CMOS. Please refer to the steps below:

Steps:

1. Turn off power.
2. Disconnect the power cord from MB.
3. Take out the battery gently and put it aside for about 10 minutes (Or you can use a metal object to connect the positive and negative pins in the battery holder to make them short for one minute).
4. Re-insert the battery to the battery holder.
5. Connect power cord to MB again and turn on power.
6. Press Del to enter BIOS and load Fail-Safe Defaults.
7. Save changes and reboot the system.

Question 6: Why does system seem unstable after updating BIOS?

Answer: Please remember to load Fail-Safe Defaults (Or Load BIOS Defaults) after flashing BIOS. However, if the system instability still remains, please clear CMOS to solve the problem.

Question 7: Why do I still get a weak sound after turning up the speaker to the maximum volume?

Answer: Please make sure the speaker you are using is equipped with an internal amplifier. If not, please change another speaker with power/amplifier and try again later.

Question 8: How do I disable onboard VGA card in order to add an external VGA card?

Answer: Gigabyte motherboards will auto-detect the external VGA card after it is plugged in, so you don't need to change any setting manually to disable the onboard VGA.

Question 9: Why cannot I use the IDE 2?

Answer: Please refer to the user manual and check whether you have connected any cable that is not provided with the motherboard package to the USB Over Current pin in the Front USB Panel. If the cable is your own cable, please remove it from this pin and do not connect any of your own cables to it.

Question 10: Sometimes I hear different continuous beeps from computer after system boots up. What do these beeps usually stand for?

Answer: The beep codes below may help you identify the possible computer problems. However, they are only for reference purposes. The situations might differ from case to case.

→ AMI BIOS Beep Codes

*Computer gives 1 short beep when system boots successfully.

*Except for beep code 8, these codes are always fatal.

- 1 beep Refresh failure
- 2 beeps Parity error
- 3 beeps Base 64K memory failure
- 4 beeps Timer not operational
- 5 beeps Processor error
- 6 beeps 8042 - gate A20 failure
- 7 beeps Processor exception interrupt error
- 8 beeps Display memory read/write failure
- 9 beeps ROM checksum error
- 10 beeps CMOS shutdown register read/write error
- 11 beeps Cache memory bad

→ AWARD BIOS Beep Codes

1 short: System boots successfully

2 short: CMOS setting error

1 long 1 short: DRAM or M/B error

1 long 2 short: Monitor or display card error

1 long 3 short: Keyboard error

1 long 9 short: BIOS ROM error

Continuous long beeps: DRAM error

Continuous short beeps: Power error

Question 11: For the M/B which have RAID function, how to set in the BIOS in order to bootup from IDE3, 4 by either RAID or ATA mode?

Answer: Please set in the BIOS as follow:

1. Advanced BIOS features-->(SATA)/RAID/SCSI boot order: "SATA"
2. Advanced BIOS features--> First boot device: "SCSI"
3. Integrated Peripherals--> Onboard H/W ATA/RAID: "enable"

Then it depends on the RAID mode that you need to set "RAID" to RAID mode or "ATA" to normal ATA mode in the item named RAID controller function.

Question 12: How to set in the BIOS to bootup from the IDE/ SCSI/ RAID card ?

Answer: Please set in the BIOS as follow:

1. Advanced BIOS features-->(SATA)/RAID/SCSI boot order: "SCSI"
2. Advanced BIOS features--> First boot device: "SCSI"

Then it depends on the mode(RAID or ATA) that you need to set in RAID/ SCSI BIOS.

Troubleshooting



If you encounter any trouble during boot up, please follow the troubleshooting procedures.

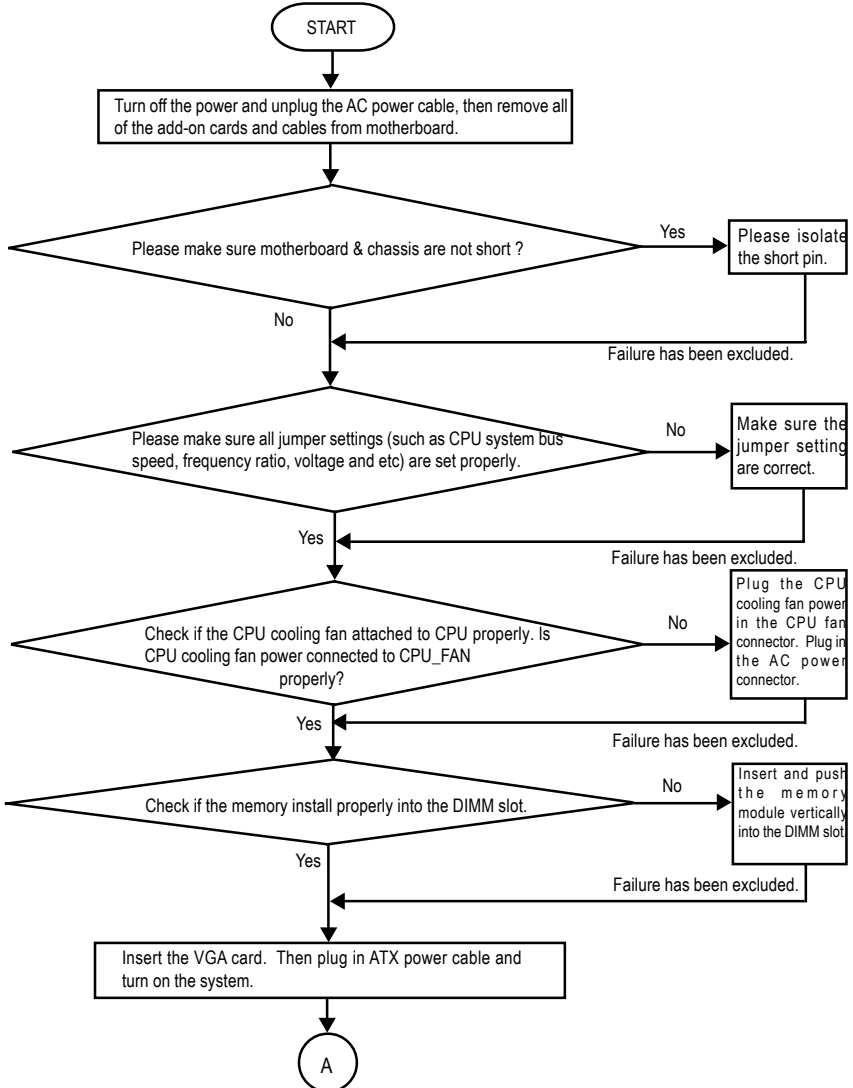

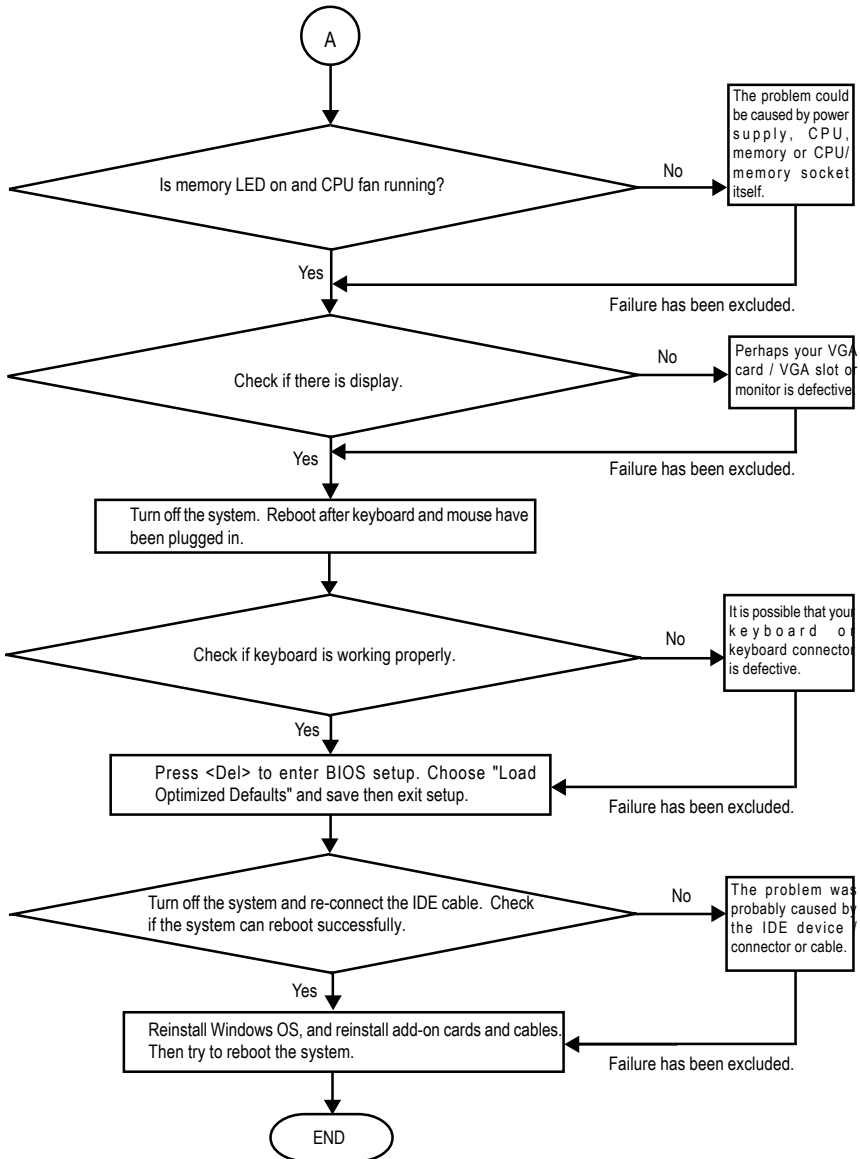

If the above procedure unable to solve your problem, please contact with your local retailer or national distributor for help. Or, you could submit your question to the service mail via Gigabyte website technical support zone (<http://www.gigabyte.com.tw>). The appropriate response will be provided ASAP.

Technical Support/RMA Sheet



Customer/Country:	Company:	Phone No.:
Contact Person:	E-mail Add. :	

Model name/Lot Number:	PCB revision:
BIOS version:	O.S./A.S.:

Hardware Configuration	Mfs.	Model name	Size:	Driver/Utility:
CPU				
Memory Brand				
Video Card				
Audio Card				
HDD				
CD-ROM / DVD-ROM				
Modem				
Network				
AMR / CNR				
Keyboard				
Mouse				
Power supply				
Other Device				

Problem Description:



Acronyms

Acronyms	Meaning
ACPI	Advanced Configuration and Power Interface
APM	Advanced Power Management
AGP	Accelerated Graphics Port
AMR	Audio Modem Riser
ACR	Advanced Communications Riser
BIOS	Basic Input / Output System
CPU	Central Processing Unit
CMOS	Complementary Metal Oxide Semiconductor
CRIMM	Continuity RIMM
CNR	Communication and Networking Riser
DMA	Direct Memory Access
DMI	Desktop Management Interface
DIMM	Dual Inline Memory Module
DRM	Dual Retention Mechanism
DRAM	Dynamic Random Access Memory
DDR	Double Data Rate
ECP	Extended Capabilities Port
ESCD	Extended System Configuration Data
ECC	Error Checking and Correcting
EMC	Electromagnetic Compatibility
EPP	Enhanced Parallel Port
ESD	Electrostatic Discharge
FDD	Floppy Disk Device
FSB	Front Side Bus
HDD	Hard Disk Device
IDE	Integrated Dual Channel Enhanced
IRQ	Interrupt Request

to be continued.....

Acronyms	Meaning
IOAPIC	Input Output Advanced Programmable Input Controller
ISA	Industry Standard Architecture
LAN	Local Area Network
I/O	Input / Output
LBA	Logical Block Addressing
LED	Light Emitting Diode
MHz	Megahertz
MIDI	Musical Instrument Digital Interface
MTH	Memory Translator Hub
MPT	Memory Protocol Translator
NIC	Network Interface Card
OS	Operating System
OEM	Original Equipment Manufacturer
PAC	PCI A.G.P. Controller
POST	Power-On Self Test
PCI	Peripheral Component Interconnect
RIMM	Rambus in-line Memory Module
SCI	Special Circumstance Instructions
SECC	Single Edge Contact Cartridge
SRAM	Static Random Access Memory



Contact Us

- **Taiwan (Headquarters)**

GIGA-BYTE TECHNOLOGY CO., LTD.

Address: No.6, Bau Chiang Road, Hsin-Tien, Taipei Hsien, Taiwan.

TEL: +886 (2) 8912-4888

FAX: +886 (2) 8912-4003

Tech. Support :

<http://tw.giga-byte.com/TechSupport/ServiceCenter.htm>

Non-Tech. Support(Sales/Marketing) :

<http://ggts.gigabyte.com.tw/nontech.asp>

WEB address (English): <http://www.gigabyte.com.tw>

WEB address (Chinese): <http://chinese.giga-byte.com>

- **U.S.A.**

G.B.T. INC.

Address: 17358 Railroad St, City of Industry, CA 91748.

TEL: +1 (626) 854-9338

FAX: +1 (626) 854-9339

Tech. Support :

<http://www.giga-byte.com/TechSupport/ServiceCenter.htm>

Non-Tech. Support(Sales/Marketing) :

<http://ggts.gigabyte.com.tw/nontech.asp>

WEB address : <http://www.giga-byte.com>

- **Germany**

G.B.T. TECHNOLOGY TRADING GMBH

Address: Friedrich-Ebert-Damm 112 22047 Hamburg Deutschland

TEL: +49-40-2533040 (Sales)

+49-1803-428468 (Tech.)

FAX: +49-40-25492343 (Sales)

+49-1803-428329 (Tech.)

Tech. Support :

<http://de.giga-byte.com/TechSupport/ServiceCenter.htm>

Non-Tech. Support(Sales/Marketing) :

<http://ggts.gigabyte.com.tw/nontech.asp>

WEB address : <http://www.gigabyte.de>

- **Japan**

NIPPON GIGA-BYTE CORPORATION

WEB address : <http://www.gigabyte.co.jp>

- **Singapore**

GIGA-BYTE SINGAPORE PTE. LTD.

Tech. Support :

<http://tw.giga-byte.com/TechSupport/ServiceCenter.htm>

Non-Tech. Support(Sales/Marketing) :

<http://ggts.gigabyte.com.tw/nontech.asp>

- **U.K.**

G.B.T. TECH. CO., LTD.

Address: GUnit 13 Avant Business Centre 3 Third Avenue, Denbigh West Blechley Milton Keynes, MK1 1DR, UK, England

TEL: +44-1908-362700

FAX: +44-1908-362709

Tech. Support :

<http://uk.giga-byte.com/TechSupport/ServiceCenter.htm>

Non-Tech. Support(Sales/Marketing) :

<http://ggts.gigabyte.com.tw/nontech.asp>

WEB address : <http://uk.giga-byte.com>

- **The Netherlands**

GIGA-BYTE TECHNOLOGY B.V.

TEL: +31 40 290 2088

NL Tech.Support: 0900-GIGABYTE (0900-44422983)

BE Tech.Support: 0900-84034

FAX: +31 40 290 2089

Tech. Support :

<http://nz.giga-byte.com/TechSupport/ServiceCenter.htm>

Non-Tech. Support(Sales/Marketing) :

<http://ggts.gigabyte.com.tw/nontech.asp>

WEB address : <http://www.giga-byte.nl>

- **China**

NINGBO G.B.T. TECH. TRADING CO., LTD.

Tech. Support :

<http://cn.giga-byte.com/TechSupport/ServiceCenter.htm>

Non-Tech. Support(Sales/Marketing) :

<http://ggts.gigabyte.com.tw/nontech.asp>

WEB address : <http://www.gigabyte.com.cn>

Shanghai

TEL: +86-021-63410999

FAX: +86-021-63410100

Beijing

TEL: +86-010-82886651

FAX: +86-010-82888013

Wuhan

TEL: +86-027-87851061

FAX: +86-027-87851330

GuangZhou

TEL: +86-020-87586074

FAX: +86-020-85517843

Chengdu

TEL: +86-028-85236930

FAX: +86-028-85256822

Xian

TEL: +86-029-85531943

FAX: +86-029-85539821

Shenyang

TEL: +86-024-23960918

FAX: +86-024-23960918-809

- **Australia**

GIGABYTE TECHNOLOGY PTY. LTD.

Address: 3/6 Garden Road, Clayton, VIC 3168 Australia

TEL: +61 3 85616288

FAX: +61 3 85616222

Tech. Support :

<http://www.giga-byte.com.au/TechSupport/ServiceCenter.htm>

Non-Tech. Support(Sales/Marketing) :

<http://ggts.gigabyte.com.tw/nontech.asp>

WEB address : <http://www.giga-byte.com.au>

- **France**

GIGABYTE TECHNOLOGY FRANCES S.A.R.L.

Tech. Support :

<http://tw.giga-byte.com/TechSupport/ServiceCenter.htm>

Non-Tech. Support(Sales/Marketing) :

<http://ggts.gigabyte.com.tw/nontech.asp>

WEB address : <http://www.gigabyte.fr>

- **Russia**

Moscow Representative Office Of Giga-Byte Technology Co., Ltd.

Tech. Support :

<http://tw.giga-byte.com/TechSupport/ServiceCenter.htm>

Non-Tech. Support(Sales/Marketing) :

<http://ggts.gigabyte.com.tw/nontech.asp>

WEB address : <http://www.gigabyte.ru>

- **Poland**

Representative Office Of Giga-Byte Technology Co., Ltd.

POLAND

Tech. Support :

<http://tw.giga-byte.com/TechSupport/ServiceCenter.htm>

Non-Tech. Support(Sales/Marketing) :

<http://ggts.gigabyte.com.tw/nontech.asp>

WEB address : <http://www.gigabyte.pl>

Free Manuals Download Website

<http://myh66.com>

<http://usermanuals.us>

<http://www.somanuals.com>

<http://www.4manuals.cc>

<http://www.manual-lib.com>

<http://www.404manual.com>

<http://www.luxmanual.com>

<http://aubethermostatmanual.com>

Golf course search by state

<http://golfingnear.com>

Email search by domain

<http://emailbydomain.com>

Auto manuals search

<http://auto.somanuals.com>

TV manuals search

<http://tv.somanuals.com>