

GA-945PLM-(D)S2 (rev. 2.1)

Intel® Core™ 2 Extreme dual-core / Core™ 2 Duo /

Intel® Pentium® D / Pentium® 4 / Celeron® D LGA775 Processor Motherboard

User's Manual

Rev. 2102

12ME-945PLMDR-2102R



* The WEEE marking on the product indicates this product must not be disposed of with user's other household waste and must be handed over to a designated collection point for the recycling of waste electrical and electronic equipment!!

■ * The WEEE marking applies only in European Union's member states.

Declaration of Conformity

G.B.T. Technology Trading GmbH
Veit, Maschinenimporteur
(full name)

Ausschlagweg 41, 1F 20337 Hamburg, Germany

declare that the product (description of the apparatus, system, installation to which it refers)

Motherboard

GA-945PLM-DS2/GA-945PLM-S2 (rev. 2.1)

(reference to the specification under which conformity is declared)
in accordance with 89/336 EEC/EMC Directive

- | | | | |
|--|--|--|--|
| <input type="checkbox"/> EN 55011 | Limits and methods of measurement of radio disturbance characteristics of industrial, scientific and medical (ISM) high frequency equipment | <input checked="" type="checkbox"/> EN 61000-3-2 | Disturbances in supply systems caused |
| <input type="checkbox"/> EN 55013 | Limits and methods of measurement of radio disturbance characteristics of broadcast receivers and associated equipment | <input checked="" type="checkbox"/> EN 61000-3-3 | Disturbances in supply systems caused by electrical equipment "Voltage fluctuations" |
| <input type="checkbox"/> EN 55014-1 | Limits and methods of measurement of radio disturbance characteristics of household electrical appliances, apparatus and similar electrical appliances | <input checked="" type="checkbox"/> EN 55024 | Information Technology equipment characteristics: Limits and methods of measurement |
| <input type="checkbox"/> EN 55015 | Limits and methods of measurement of radio disturbance characteristics of fluorescent lamps and luminaires | <input type="checkbox"/> EN 50082-1 | Generic immunity standard Part 1: Residential, commercial and light industry |
| <input type="checkbox"/> EN 55020 | Immunity from radio interference of broadcast receivers and associated equipment | <input type="checkbox"/> EN 50082-2 | Generic Immunity Standard Part 2: Industrial environment |
| <input checked="" type="checkbox"/> EN 55022 | Limits and methods of measurement of radio disturbance characteristics of information technology equipment | <input type="checkbox"/> EN 55014-2 | Immunity requirements for household appliances tools and similar apparatus |
| <input type="checkbox"/> DIN VDE 0885 | Called distribution systems; Equipment for receiving and/or distribution from sound and television signals | <input type="checkbox"/> EN 50091-2 | EMC requirements for uninterruptible power systems (UPS) |
| <input type="checkbox"/> part 10 | | | |
| <input type="checkbox"/> part 12 | | | |
| <input checked="" type="checkbox"/> CE marking | (EC conformity marking) | | |
| <input type="checkbox"/> EN 60906 | Safety requirements for mains operated electronic and related apparatus for household and similar general use | <input type="checkbox"/> EN 60950 | Safety for information technology equipment including electrical business equipment |
| <input type="checkbox"/> EN 60335 | Safety of household and similar electrical appliances | <input type="checkbox"/> EN 50091-1 | General and Safety requirements for uninterruptible power systems (UPS) |

The manufacturer also declares the conformity of above mentioned product with the actual required safety standards in accordance with IVD 7/23 BEC



(EC conformity marking)

(Stamp)

Date: Nov. 29, 2006

Manufacturer/importer

Signature: Jimmy Huang

Name: Timmy Huang

DECLARATION OF CONFORMITY

Per FCC Part 2 Section 2.1077(a)



Responsible Party Name: **G.B.T. INC. (U.S.A.)**

Address: **17358 Railroad Street**

City of Industry, CA 91748

Phone/Fax No: **(818) 854-9338 / (818) 854-9339**

hereby declares that the product

Product Name: Motherboard

Model Number: GA-945PLM-DS2/

GA-945PLM-S2 (rev. 2.1)

Conforms to the following specifications:

FCC Part 15, Subpart B, Section 15.107(a) and Section 15.109

(a), Class B Digital Device

Supplementary Information:

This device complies with part 15 of the FCC Rules. Operation is subject to the following two conditions: (1) This device may not cause harmful and (2) this device must accept any interference received, including that may cause undesired operation.

Representative Person's Name: ERIC LU

Signature: Eric Lu

Date: Nov. 29, 2006

Copyright

© 2006 GIGA-BYTE TECHNOLOGY CO., LTD. All rights reserved.

The trademarks mentioned in the manual are legally registered to their respective companies.

Notice

The written content provided with this product is the property of Gigabyte.

No part of this manual may be reproduced, copied, translated, or transmitted in any form or by any means without Gigabyte's prior written permission. Specifications and features are subject to change without prior notice.

Product Manual Classification

In order to assist in the use of this product, Gigabyte has categorized the user manual in the following:

- For detailed product information and specifications, please carefully read the "Product User Manual".
- For detailed information related to Gigabyte's unique features, please go to "Technology Guide" section on Gigabyte's website to read or download the information you need.

For more product details, please click onto Gigabyte's website at www.gigabyte.com.tw

Table of Contents

Item Checklist	6
Optional Accessories	6
GA-945PLM-DS2/GA-945PLM-S2 (rev. 2.1) Motherboard Layout	7
Block Diagram	8
Chapter 1 Hardware Installation	9
1-1 Considerations Prior to Installation	9
1-2 Feature Summary	10
1-3 Installation of the CPU and CPU Cooler	12
1-3-1 Installation of the CPU	12
1-3-2 Installation of the CPU Cooler	13
1-4 Installation of Memory	14
1-5 Installation of Expansion Cards	16
1-6 I/O Back Panel Introduction	17
1-7 Connectors Introduction	18
Chapter 2 BIOS Setup	29
The Main Menu (For example:GA-945PLM-DS2 BIOS Ver. : F1a)	30
2-1 Standard CMOS Features	32
2-2 Advanced BIOS Features	34
2-3 Integrated Peripherals	36
2-4 Power Management Setup	40
2-5 PnP/PCI Configurations	42
2-6 PC Health Status	43
2-7 Frequency/Voltage Control	45
2-8 Load Fail-Safe Defaults	47
2-9 Load Optimized Defaults	47
2-10 Set Supervisor/User Password	48
2-11 Save & Exit Setup	49
2-12 Exit Without Saving	49

Chapter 3	Install Drivers	51
3-1	Install Chipset Drivers	51
3-2	Software Applications	52
3-3	Driver CD Information	52
3-4	Hardware Information	53
3-5	Contact Us	53
Chapter 4	Appendix	55
4-1	Unique Software Utilities	55
4-1-1	EasyTune 5 Introduction	55
4-1-2	Xpress Recovery2 Introduction	56
4-1-3	Flash BIOS Method Introduction	58
4-1-4	2- / 4- / 6- / 8- Channel Audio Function Introduction	67
4-2	Troubleshooting	73

Item Checklist

- IDE Cable x 1, FDD Cable x 1
- SATA 3Gb/s Cable x 1
- I/O Shield

* The items listed above are for reference only, and are subject to change without notice.

Optional Accessories

- ◆ 2 Ports USB2.0 Cable (Part Number: 12CR1-1UB030-51/R)
- ◆ 4 Ports USB2.0 Cable (Part Number: 12CR1-1UB030-21/R)
- ◆ COM Port Cable (Part Number: 12CF1-1CM001-31/12CF1-1CM001-12R)
- ◆ S/PDIF In and Out Cable (Part Number: 12CR1-1SPINO-11/R)
- ◆ e-SATA Cable (Part Number: 12CF1-3SATPW-11R)

GA-945PLM-DS2/GA-945PLM-S2 (rev. 2.1) Motherboard Layout

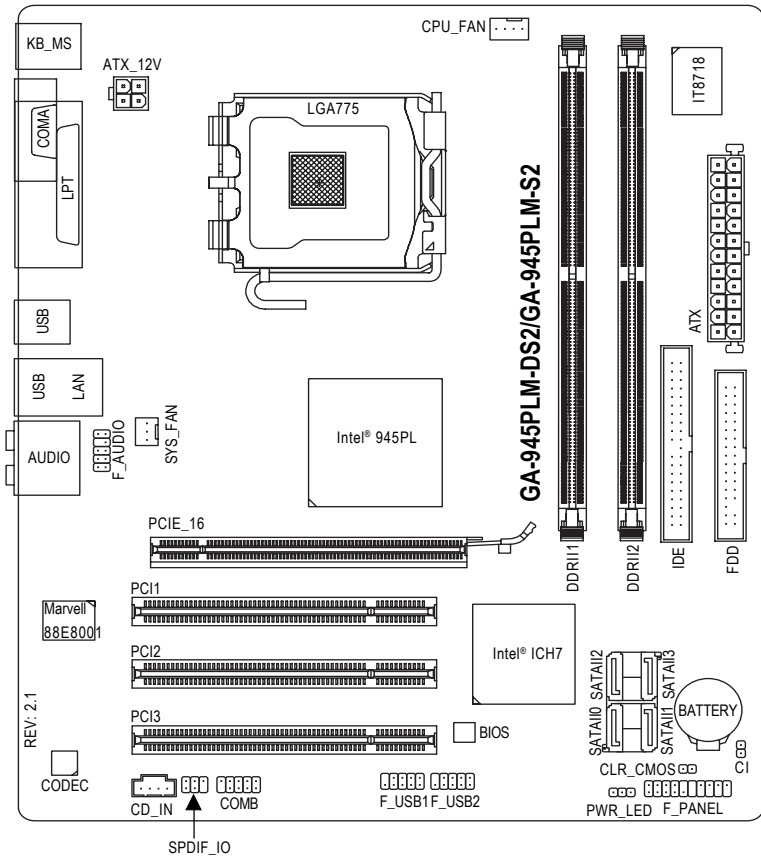

Block Diagram

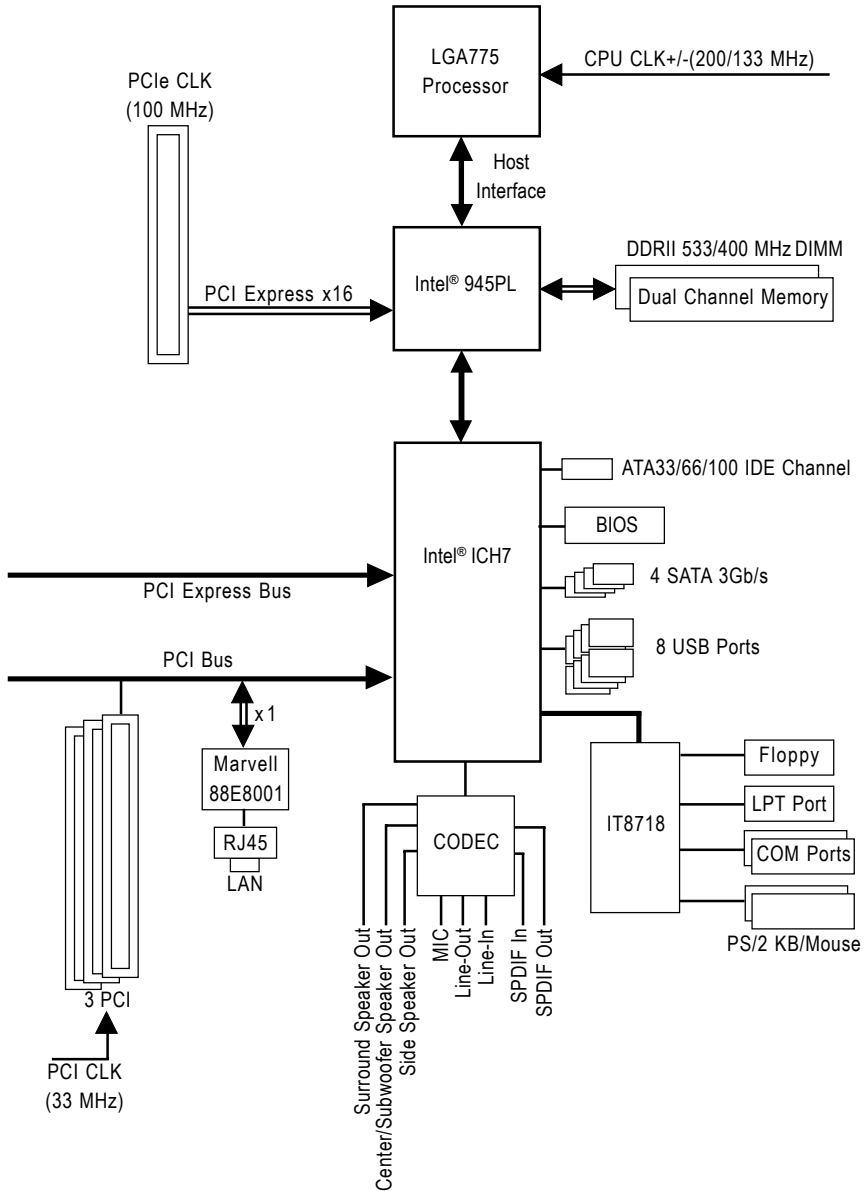

Chapter 1 Hardware Installation

1-1 Considerations Prior to Installation

Preparing Your Computer

The motherboard contains numerous delicate electronic circuits and components which can become damaged as a result of electrostatic discharge (ESD). Thus, prior to installation, please follow the instructions below:

1. Please turn off the computer and unplug its power cord.
2. When handling the motherboard, avoid touching any metal leads or connectors.
3. It is best to wear an electrostatic discharge (ESD) cuff when handling electronic components (CPU, RAM).
4. Prior to installing the electronic components, please have these items on top of an antistatic pad or within a electrostatic shielding container.
5. Please verify that the power supply is switched off before unplugging the power supply connector from the motherboard.

Installation Notices

1. Prior to installation, please do not remove the stickers on the motherboard. These stickers are required for warranty validation.
2. Prior to the installation of the motherboard or any hardware, please first carefully read the information in the provided manual.
3. Before using the product, please verify that all cables and power connectors are connected.
4. To prevent damage to the motherboard, please do not allow screws to come in contact with the motherboard circuit or its components.
5. Please make sure there are no leftover screws or metal components placed on the motherboard or within the computer casing.
6. Please do not place the computer system on an uneven surface.
7. Turning on the computer power during the installation process can lead to damage to system components as well as physical harm to the user.
8. If you are uncertain about any installation steps or have a problem related to the use of the product, please consult a certified computer technician.

Instances of Non-Warranty

1. Damage due to natural disaster, accident or human cause.
2. Damage as a result of violating the conditions recommended in the user manual.
3. Damage due to improper installation.
4. Damage due to use of uncertified components.
5. Damage due to use exceeding the permitted parameters.
6. Product determined to be an unofficial Gigabyte product.

1-2 Feature Summary

CPU	<ul style="list-style-type: none"> ◆ LGA775 for Intel® Core™ 2 Extreme dual-core / Core™ 2 Duo / Pentium® D / Pentium® 4 / Celeron® D ◆ L2 cache varies with CPU
Front Side Bus	<ul style="list-style-type: none"> ◆ Supports 800/533 MHz FSB
Chipset	<ul style="list-style-type: none"> ◆ Northbridge: Intel® 945PL Express Chipset ◆ Southbridge: Intel® ICH7
LAN	<ul style="list-style-type: none"> ◆ Onboard Marvell 88E8001 chip (10/100/1000 Mbit)
Audio	<ul style="list-style-type: none"> ◆ Onboard Realtek ALC888 CODEC chip ◆ Supports High Definition Audio ◆ Supports 2 / 4 / 6 / 8 channel audio ◆ Supports S/PDIF In/Out connection ◆ Supports CD In connection
Storage	<ul style="list-style-type: none"> ◆ Intel® ICH7 Southbridge <ul style="list-style-type: none"> - 1 FDD connector, allowing connection of 1 FDD device - 1 IDE connector with UDMA 33/ATA 66/ATA 100 support, allowing connection of 2 IDE devices - 4 SATA 3Gb/s connectors allowing connection of 4 SATA 3Gb/s devices
O.S Support	<ul style="list-style-type: none"> ◆ Microsoft Windows® 2000/XP
Memory	<ul style="list-style-type: none"> ◆ 2 DDRII DIMM memory slots (supports up to 2 GB memory) ◆ Supports dual channel DDRII 533/400 unbuffered DIMMs ◆ Supports 1.8V DDRII DIMMs
Expansion Slots	<ul style="list-style-type: none"> ◆ 1 PCI Express x16 slot ◆ 3 PCI slots
Internal Connectors	<ul style="list-style-type: none"> ◆ 1 24-pin ATX power connector ◆ 1 4-pin ATX 12V power connector ◆ 1 floppy connector ◆ 1 IDE connector ◆ 4 SATA 3Gb/s connectors ◆ 1 CPU fan connector ◆ 1 system fan connector ◆ 1 front panel connector ◆ 1 front audio connector ◆ 1 CD In connector ◆ 1 S/PDIF In/Out connector ◆ 2 USB 2.0/1.1 connectors for additional 4 ports by cables ◆ 1 COMB connector ◆ 1 Chassis Intrusion connector ◆ 1 power LED connector

*** Only the GA-945PLM-DS2 adopts All-Solid Capacitor design.

Rear Panel I/O	<ul style="list-style-type: none"> ◆ 1 PS/2 keyboard port ◆ 1 PS/2 mouse port ◆ 1 parallel port ◆ 1 serial port ◆ 4 USB 2.0/1.1 ports ◆ 1 RJ-45 port ◆ 6 audio jacks (Line In / Line Out / MIC In/Surround Speaker Out (Rear Speaker Out)/Center/Subwoofer Speaker Out/Side Speaker Out)
I/O Control	<ul style="list-style-type: none"> ◆ IT8718 chip
Hardware Monitor	<ul style="list-style-type: none"> ◆ System voltage detection ◆ CPU temperature detection ◆ CPU / System fan speed detection ◆ CPU warning temperature ◆ CPU / System fan failure warning ◆ CPU smart fan control
BIOS	<ul style="list-style-type: none"> ◆ 1 4 Mbit flash ROM ◆ Use of licensed AWARD BIOS
Additional Features	<ul style="list-style-type: none"> ◆ Supports @BIOS ◆ Supports Download Center ◆ Supports Q-Flash ◆ Supports EasyTune (only supports Hardware Monitor function)^(Note) ◆ Supports Xpress Install ◆ Supports Xpress Recovery2 ◆ Supports Xpress BIOS Rescue
Bundle Software	<ul style="list-style-type: none"> ◆ Norton Internet Security (OEM revision)
Form Factor	<ul style="list-style-type: none"> ◆ Micro ATX form factor; 22.0cm x 24.4cm

(Note) EasyTune functions may vary depending on different motherboards.

1-3 Installation of the CPU and CPU Cooler



CAUTION

Before installing the CPU, please comply with the following conditions:

1. Please make sure that the motherboard supports the CPU.
2. Please take note of the one indented corner of the CPU. If you install the CPU in the wrong direction, the CPU will not insert properly. If this occurs, please change the insert direction of the CPU.
3. Please add an even layer of heat sink paste between the CPU and CPU cooler.
4. Please make sure the CPU cooler is installed on the CPU prior to system use, otherwise overheating and permanent damage of the CPU may occur.
5. Please set the CPU host frequency in accordance with the processor specifications. It is not recommended that the system bus frequency be set beyond hardware specifications since it does not meet the required standards for the peripherals. If you wish to set the frequency beyond the proper specifications, please do so according to your hardware specifications including the CPU, graphics card, memory, hard drive, etc.



NOTE

HT functionality requirement content :

Enabling the functionality of Hyper-Threading Technology for your computer system requires all of the following platform components:

- CPU: An Intel® Pentium 4 Processor with HT Technology
- Chipset: An Intel® Chipset that supports HT Technology
- BIOS: A BIOS that supports HT Technology and has it enabled
- OS: An operation system that has optimizations for HT Technology

1-3-1 Installation of the CPU

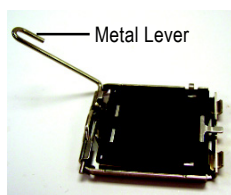

Fig. 1
Gently lift the metal lever located on the CPU socket to the upright position.

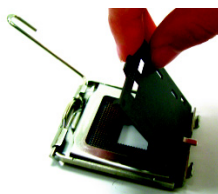

Fig. 2
Remove the plastic covering on the CPU socket.

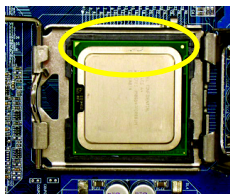

Fig. 3
Notice the small gold colored triangle located on the edge of the CPU socket. Align the indented corner of the



Fig. 4
Once the CPU is properly inserted, please replace the load plate and push the metal lever back into its original position.

CPU with the triangle and gently insert the CPU into position. (Grasping the CPU firmly between your thumb and forefinger, carefully place it into the socket in a straight and downwards motion. Avoid twisting or bending motions that might cause damage to the CPU during installation.)

1-3-2 Installation of the CPU Cooler



Fig. 1
Please apply an even layer of CPU cooler paste on the surface of the installed CPU.

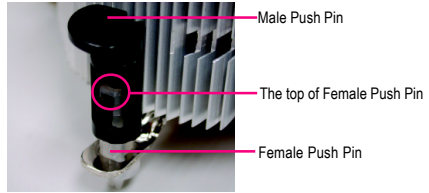

Fig. 2
(Turning the push pin along the direction of arrow is to remove the CPU cooler, on the contrary, is to install.) Please note the direction of arrow sign on the male push pin doesn't face inwards before installation. (This instruction is only for Intel boxed fan)

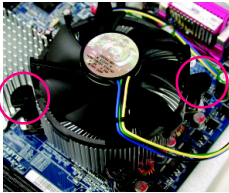

Fig. 3
Place the CPU cooler atop the CPU and make sure the push pins aim to the pin hole on the motherboard. Pressing down the push pins diagonally.

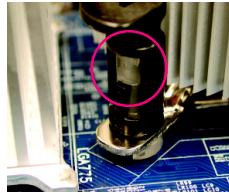

Fig. 4
Please make sure the Male and Female push pin are joined closely. (for detailed installation instructions, please refer to the CPU cooler installation section of the user manual)

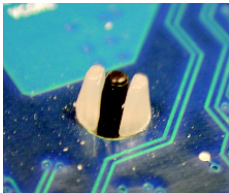

Fig. 5
Please check the back of motherboard after installing. If the push pin is inserted as the picture, the installation is complete.

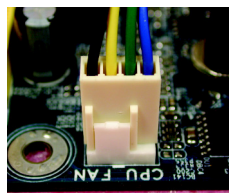

Fig. 6
Finally, please attach the power connector of the CPU cooler to the CPU fan header located on the motherboard.



The CPU cooler may adhere to the CPU as a result of hardening of the heat paste. To prevent such an occurrence, it is suggested that either thermal tape rather than heat paste be used for heat dissipation or using extreme care when removing the CPU cooler.

1-4 Installation of Memory



Before installing the memory modules, please comply with the following conditions:

1. Please make sure that the memory used is supported by the motherboard. It is recommended that memory of similar capacity, specifications and brand be used.
2. Before installing or removing memory modules, please make sure that the computer power is switched off to prevent hardware damage.
3. Memory modules have a foolproof insertion design. A memory module can be installed in only one direction. If you are unable to insert the module, please switch the direction.

The motherboard supports DDRII memory modules, whereby BIOS will automatically detect memory capacity and specifications. Memory modules are designed so that they can be inserted only in one direction. The memory capacity used can differ with each slot.

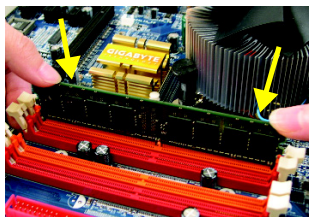
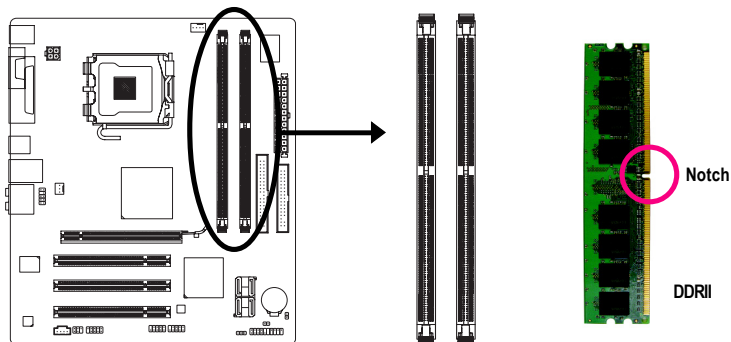

Fig.1

The DIMM socket has a notch, so the DIMM memory module can only fit in one direction. Insert the DIMM memory module vertically into the DIMM socket. Then push it down.

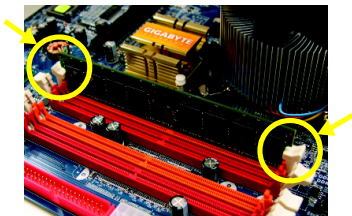

Fig.2

Close the plastic clip at both edges of the DIMM sockets to lock the DIMM module.

Reverse the installation steps when you wish to remove the DIMM module.



Dual Channel Memory Configuration

The GA-945PLM-DS2/GA-945PLM-S2 supports the Dual Channel Technology. After operating the Dual Channel Technology, the bandwidth of memory bus will double.

The GA-945PLM-DS2/GA-945PLM-S2 includes 2 DIMM sockets.

If you want to operate the Dual Channel Technology, please note the following explanations:

1. Dual Channel mode will not be enabled if only one DDRII memory module is installed.
2. To enable Dual Channel mode, please insert two DDRII memory modules (it is recommended to use memory modules of identical brand, size, chips, and speed) into DDRII1 and DDRII2 memory sockets.

1-5 Installation of Expansion Cards

You can install your expansion card by following the steps outlined below:

1. Read the related expansion card's instruction document before install the expansion card into the computer.
2. Remove your computer's chassis cover, screws and slot bracket from the computer.
3. Press the expansion card firmly into expansion slot in motherboard.
4. Be sure the metal contacts on the card are indeed seated in the slot.
5. Replace the screw to secure the slot bracket of the expansion card.
6. Replace your computer's chassis cover.
7. Power on the computer, if necessary, setup BIOS utility of expansion card from BIOS.
8. Install related driver from the operating system.

For example: Installing a PCI Express x16 VGA card:

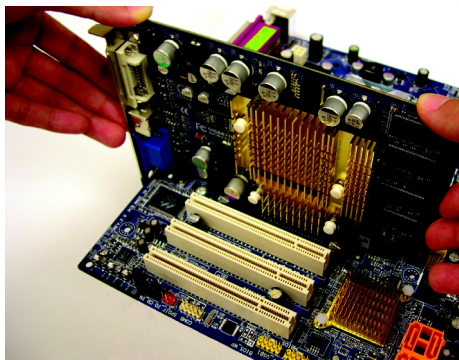

CAUTION

When installing the graphics card, push down on the top edge of the card until it is fully inserted into the PCI Express x16 slot. Make sure the card is securely seated in the slot and does not rock.

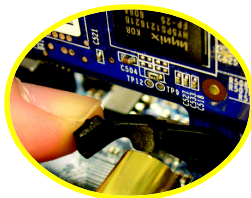

When removing the graphics card, gently push back on the black lever on the slot and then lift the card straight out from the slot.

1-6 I/O Back Panel Introduction

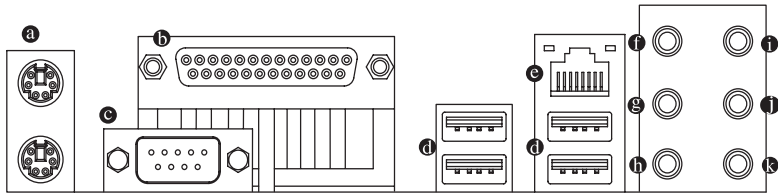

a PS/2 Keyboard and PS/2 Mouse Connector

To install a PS/2 port keyboard and mouse, plug the mouse to the upper port (green) and the keyboard to the lower port (purple).

b Parallel Port

The parallel port allows connection of a printer, scanner and other peripheral devices.

c COMA (Serial Port)

Connects to serial-based mouse or data processing devices.

d USB Port

Before you connect your device(s) into USB connector(s), please make sure your device(s) such as USB keyboard, mouse, scanner, zip, speaker...etc. have a standard USB interface. Also make sure your OS supports USB controller. If your OS does not support USB controller, please contact OS vendor for possible patch or driver upgrade. For more information please contact your OS or device(s) vendors.

e LAN Port

The provided Internet connection is Gigabit Ethernet, providing data transfer speeds of 10/100/1000 Mbps.

f Center/Subwoofer Speaker Out

The default Center/Subwoofer Speaker Out jack. Center/Subwoofer speakers can be connected to Center/Subwoofer Speaker Out jack.

g Surround Speaker Out (Rear Speaker Out)

The default Surround Speaker Out (Rear Speaker Out) jack. Rear surround speakers can be connected to Surround Speaker Out (Rear Speaker Out) jack.

h Side Speaker Out

The default Side Speaker Out jack. Surround side speakers can be connected to Side Speaker Out jack.

i Line In

The default Line In jack. Devices like CD-ROM, walkman etc. can be connected to Line In jack.

● Line Out (Front Speaker Out)

The default Line Out (Front Speaker Out) jack. Stereo speakers, earphone or front surround speakers can be connected to Line Out (Front Speaker Out) jack.

● MIC In

The default MIC In jack. Microphone must be connected to MIC In jack.



NOTE

In addition to the default speakers settings, the ●~● audio jacks can be reconfigured to perform different functions via the audio software. Only microphones still MUST be connected to the default Mic In jack (●). Please refer to the 2-/4-/6-/8- channel audio setup steps for detailed software configuration information.

1-7 Connectors Introduction

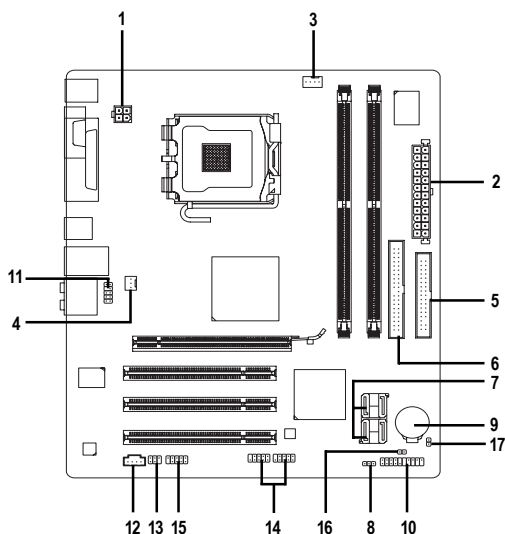

1) ATX_12V	10) F_PANEL
2) ATX (Power Connector)	11) F_AUDIO
3) CPU_FAN	12) CD_IN
4) SYS_FAN	13) SPDIF_IO
5) FDD	14) F_USB1 / F_USB2
6) IDE	15) COMB
7) SATAII0 / 1 / 2 / 3	16) CLR_CMOS
8) PWR_LED	17) CI
9) BATTERY	

1/2) ATX_12V / ATX (Power Connector)

With the use of the power connector, the power supply can supply enough stable power to all the components on the motherboard. Before connecting the power connector, please make sure that all components and devices are properly installed. Align the power connector with its proper location on the motherboard and connect tightly.

The ATX_12V power connector mainly supplies power to the CPU. If the ATX_12V power connector is not connected, the system will not start.

Caution!

Please use a power supply that is able to handle the system voltage requirements. It is recommended that a power supply that can withstand high power consumption be used (300W or greater). If a power supply is used that does not provide the required power, the result can lead to an unstable system or a system that is unable to start.

If you use a 24-pin ATX power supply, please remove the small cover on the power connector on the motherboard before plugging in the power cord; otherwise, please do not remove it.

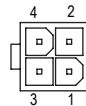
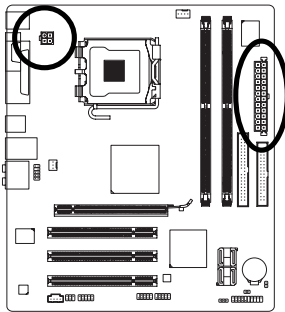

ATX_12V

Pin No.	Definition
1	GND
2	GND
3	+12V
4	+12V

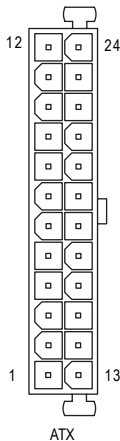

Pin No.	Definition	Pin No.	Definition
1	3.3V	13	3.3V
2	3.3V	14	-12V
3	GND	15	GND
4	+5V	16	PS_ON(soft On/Off)
5	GND	17	GND
6	+5V	18	GND
7	GND	19	GND
8	Power Good	20	-5V
9	5V SB(stand by +5V)	21	+5V
10	+12V	22	+5V
11	+12V(Only for 24-pin ATX)	23	+5V (Only for 24-pin ATX)
12	3.3V(Only for 24-pin ATX)	24	GND(Only for 24-pin ATX)

3/4) CPU_FAN / SYS_FAN (Cooler Fan Power Connector)

The cooler fan power connector supplies a +12V power voltage via a 3-pin/4-pin(CPU_FAN) power connector and possesses a foolproof connection design.

Most coolers are designed with color-coded power connector wires. A red power connector wire indicates a positive connection and requires a +12V power voltage. The black connector wire is the ground wire (GND).

Remember to connect the CPU/system fan cable to the CPU_FAN/SYS_FAN connector to prevent CPU damage or system hanging caused by overheating.

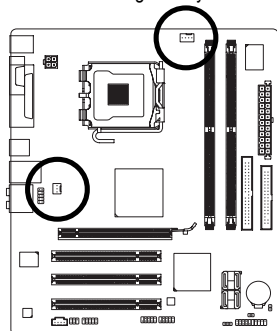

CPU_FAN



SYS_FAN

CPU_FAN :

Pin No.	Definition
1	GND
2	+12V / Speed Control
3	Sense
4	Speed Control

SYS_FAN :

Pin No.	Definition
1	GND
2	+12V
3	Sense

5) FDD (Floppy Connector)

The FDD connector is used to connect the FDD cable while the other end of the cable connects to the FDD drive. The types of FDD drives supported are: 360 KB, 720 KB, 1.2 MB, 1.44 MB and 2.88 MB. Before attaching the FDD cable, please take note of the foolproof groove in the FDD connector.

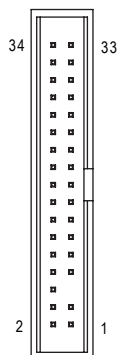
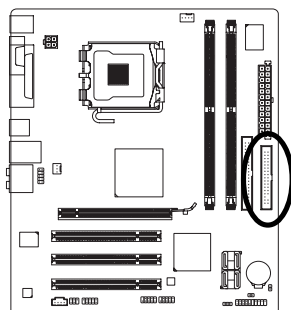

6) IDE (IDE Connector)

An IDE device connects to the computer via an IDE connector. One IDE connector can connect to one IDE cable, and the single IDE cable can then connect to two IDE devices (hard drive or optical drive). If you wish to connect two IDE devices, please set the jumper on one IDE device as Master and the other as Slave (for information on settings, please refer to the instructions located on the IDE device). Before attaching the IDE cable, please take note of the foolproof groove in the IDE connector.

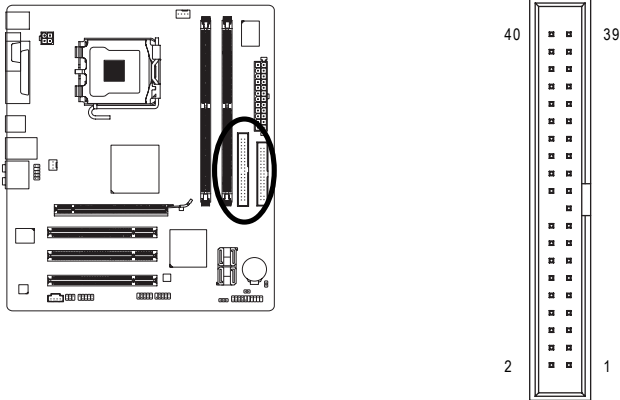

7) SATAII0 / 1 / 2 / 3 (SATA 3Gb/s Connector, Controlled by ICH7)

SATA 3Gb/s can provide up to 300 MB/s transfer rate. Please refer to the BIOS setting for the SATA 3Gb/s and install the proper driver in order to work properly.

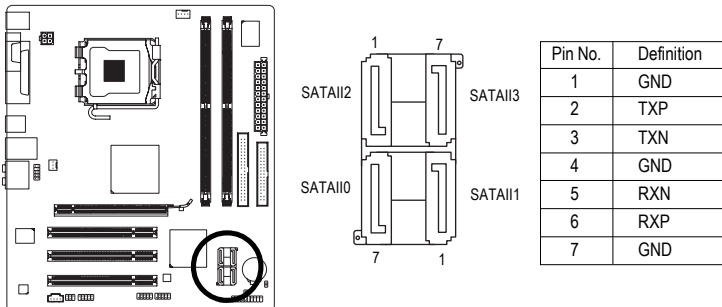

8) PWR_LED

The PWR_LED connector is connected with the system power indicator to indicate whether the system is on/off. It will blink when the system enters suspend mode (S1).

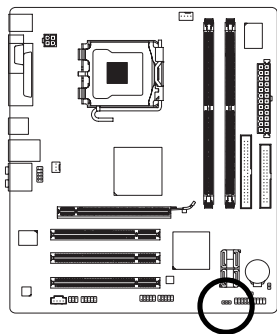

1 

Pin No.	Definition
1	MPD+
2	MPD-
3	MPD-

9) BATTERY

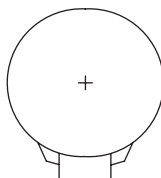
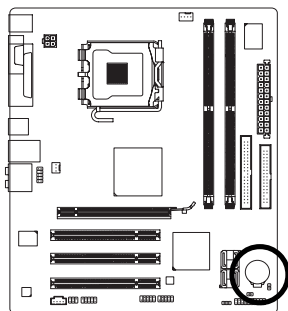

- ❖ Danger of explosion if battery is incorrectly replaced.
- ❖ Replace only with the same or equivalent type recommended by the manufacturer.
- ❖ Dispose of used batteries according to the manufacturer's instructions.

If you want to erase CMOS...

1. Turn off the computer and unplug the power cord.
2. Gently take out the battery and put it aside for about one minute.
(Or you can use a metal object to connect the positive and negative pins in the battery holder to make them short for five seconds.)
3. Re-install the battery.
4. Plug the power cord in and turn on the computer.

10) F_PANEL (Front Panel Jumper)

Please connect the power LED, PC speaker, reset switch and power switch etc. of your chassis to the F_PANEL connector according to the pin assignment below.

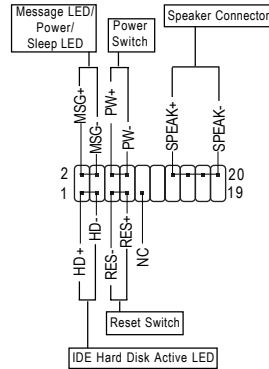
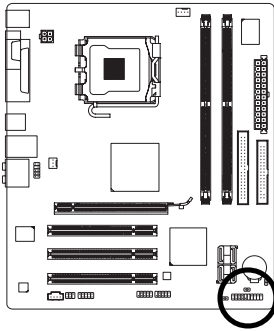

MSG (Message LED/Power/Sleep LED)	Pin 1: LED anode(+) Pin 2: LED cathode(-)
PW (Power Switch)	Open: Normal Close: Power On/Off
SPEAK (Speaker Connector)	Pin 1: Power Pin 2- Pin 3: NC Pin 4: Data(-)
HD (IDE Hard Disk Active LED)	Pin 1: LED anode(+) Pin 2: LED cathode(-)
RES (Reset Switch)	Open: Normal Close: Reset Hardware System
NC	NC

11) F_AUDIO (Front Audio Connector)

This connector supports either HD (High Definition) or AC97 front panel audio module. If you wish to use the front audio function, connect the front panel audio module to this connector. Check the pin assignments carefully while you connect the front panel audio module. Incorrect connection between the module and connector will make the audio device unable to work or even damage it. For optional front panel audio module, please contact your chassis manufacturer.

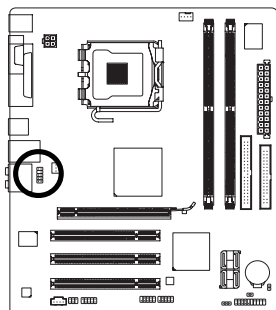

HD Audio:

Pin No.	Definition
1	MIC2_L
2	GND
3	MIC2_R
4	-ACZ_DET
5	LINE2_R
6	FSENSE1
7	FAUDIO_JD
8	No Pin
9	LINE2_L
10	FSENSE2

AC'97 Audio:

Pin No.	Definition
1	MIC
2	GND
3	MIC Power
4	NC
5	Line Out (R)
6	NC
7	NC
8	No Pin
9	Line Out (L)
10	NC



NOTE

By default, the audio driver is configured to support HD Audio. To connect an AC97 front panel audio module to this connector, please refer to the instructions on page 72 about the software settings.

12) CD_IN (CD IN Connector)

Connect CD-ROM or DVD-ROM audio out to the connector.

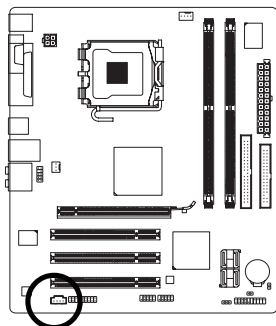

Pin No.	Definition
1	CD-L
2	GND
3	GND
4	CD-R

13) SPDIF_IO (S/PDIF In/Out Connector)

The S/PDIF output is capable of providing digital audio to external speakers or compressed AC3 data to an external Dolby Digital Decoder. Use this feature only when your stereo system has digital input function. Use S/PDIF IN feature only when your device has digital output function. Be careful with the polarity of the SPDIF_IO connector. Check the pin assignment carefully while you connect the S/PDIF cable, incorrect connection between the cable and connector will make the device unable to work or even damage it. For optional S/PDIF cable, please contact your local dealer.

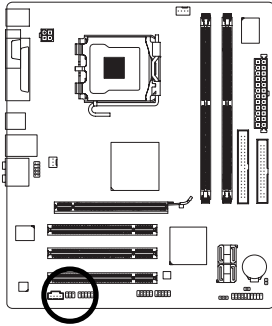

Pin No.	Definition
1	Power
2	No Pin
3	SPDIF
4	SPDIFI
5	GND
6	GND

14) F_USB1 / F_USB2 (Front USB Connector)

Be careful with the polarity of the front USB connector. Check the pin assignment carefully while you connect the front USB cable, incorrect connection between the cable and connector will make the device unable to work or even damage it. For optional front USB cable, please contact your local dealer.

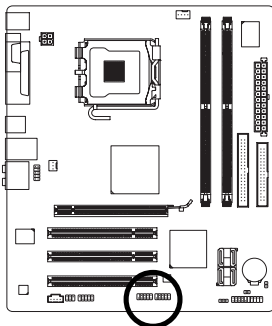

Pin No.	Definition
1	Power (5V)
2	Power (5V)
3	USB DX-
4	USB Dy-
5	USB DX+
6	USB Dy+
7	GND
8	GND
9	No Pin
10	NC

15) COMB (COMB Connector)

Be careful with the polarity of the COMB connector. Check the pin assignments while you connect the COMB cable. Please contact your nearest dealer for optional COMB cable.

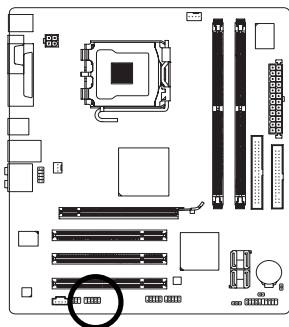

Pin No.	Definition
1	NDCDB-
2	NSINB
3	NSOUTB
4	NDTRB-
5	GND
6	NDSRB-
7	NRTSB-
8	NCTSB-
9	NRIB-
10	No Pin

16) CLR_CMOS (Clear CMOS)

You may clear the CMOS data to its default values by this header. To clear CMOS, temporarily short the two pins. Default doesn't include the jumper to avoid improper use of this header.

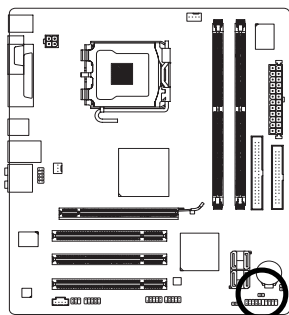

 Open: Normal

 Short: Clear CMOS

17) CI (Chassis Intrusion, Case Open)

This 2-pin connector allows your system to detect if the chassis cover is removed. You can check the "Case Opened" status in BIOS Setup.

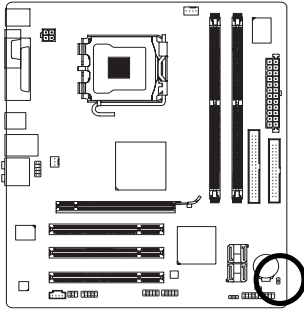

Pin No.	Definition
1	Signal
2	GND

Chapter 2 BIOS Setup

BIOS (Basic Input and Output System) includes a CMOS SETUP utility which allows user to configure required settings or to activate certain system features.

The CMOS SETUP saves the configuration in the CMOS SRAM of the motherboard.

When the power is turned off, the battery on the motherboard supplies the necessary power to the CMOS SRAM.

When the power is turned on, press the button during the BIOS POST (Power-On Self Test) will take you to the CMOS SETUP screen. You can enter the BIOS setup screen by pressing "Ctrl + F1".

If you wish to upgrade to a new BIOS, either GIGABYTE's Q-Flash or @BIOS utility can be used.

Q-Flash allows the user to quickly and easily update or backup BIOS without entering the operating system.

@BIOS is a Windows-based utility that does not require users to boot to DOS before upgrading BIOS but directly download and update BIOS from the Internet.

CONTROL KEYS

<↑><↓><←><→>	Move to select item
<Enter>	Select Item
<Esc>	Main Menu - Quit and not save changes into CMOS Status Page Setup Menu and Option Page Setup Menu - Exit current page and return to Main Menu
<Page Up>	Increase the numeric value or make changes
<Page Down>	Decrease the numeric value or make changes
<F1>	General help, only for Status Page Setup Menu and Option Page Setup Menu
<F2>	Item Help
<F5>	Restore the previous CMOS value from CMOS, only for Option Page Setup Menu
<F6>	Load the Fail-safe default CMOS value from BIOS default table
<F7>	Load the Optimized Defaults
<F8>	Q-Flash utility
<F9>	System Information
<F10>	Save all the CMOS changes, only for Main Menu

Main Menu

The on-line description of the highlighted setup function is displayed at the bottom of the screen.

Status Page Setup Menu / Option Page Setup Menu

Press <F1> to pop up a small help window that describes the appropriate keys to use and the possible selections for the highlighted item. To exit the Help Window press <Esc>.



Because BIOS flashing is potentially risky, please do it with caution and avoid inadequate operation that may result in system malfunction.

<F12> : Boot Menu

Select boot sequence for onboard (or add-on cards) device.

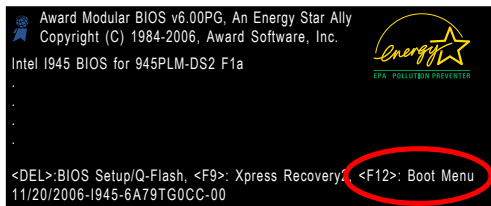

<F12>: Boot Menu

Use <↑> or <↓> to select a device, then press enter to accept . Press <ESC> to exit this menu.

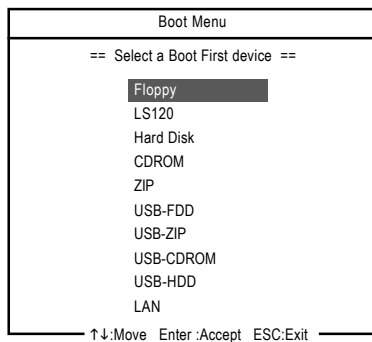

The Main Menu (For example:GA-945PLM-DS2 BIOS Ver. : F1a)

Once you enter Award BIOS CMOS Setup Utility, the Main Menu (as figure below) will appear on the screen. Use arrow keys to select among the items and press <Enter> to accept or enter the sub-menu.

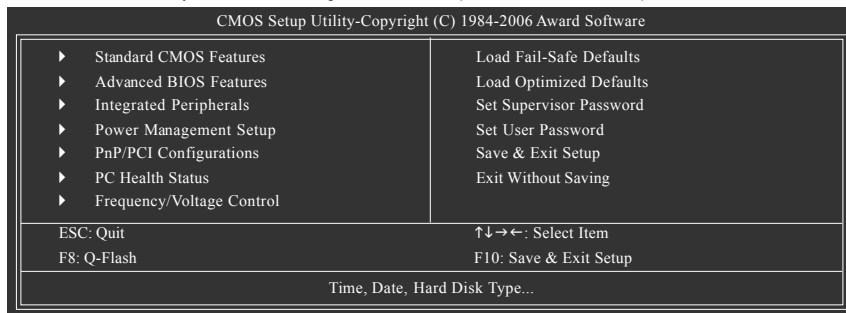

NOTE

1. If you don't find the settings you want, press "Ctrl+F1" to access advanced options.
2. Select the **Load Optimized Defaults** item in the BIOS Setup when somehow the system is not stable as usual. This action makes the system reset to the default settings for stability.
3. The BIOS Setup menus described in this chapter are for reference only and may differ from the exact settings for your motherboard.

■ Standard CMOS Features

This setup page includes all the items in standard compatible BIOS.

■ Advanced BIOS Features

This setup page includes all the items of Award special enhanced features.

■ Integrated Peripherals

This setup page includes all onboard peripherals.

■ Power Management Setup

This setup page includes all the items of Green function features.

■ PnP/PCI Configuration

This setup page includes all the configurations of PCI & PnP ISA resources.

■ PC Health Status

This setup page is the System auto detect Temperature, voltage, fan, speed.

■ Frequency/Voltage Control

This setup page is control CPU clock and frequency ratio.

■ Load Fail-Safe Defaults

Fail-Safe Defaults indicates the value of the system parameters which the system would be in safe configuration.

■ Load Optimized Defaults

Optimized Defaults indicates the value of the system parameters which the system would be in best performance configuration.

■ Set Supervisor Password

Change, set, or disable password. It allows you to limit access to the system and Setup, or just to Setup.

■ Set User Password

Change, set, or disable password. It allows you to limit access to the system.

■ Save & Exit Setup

Save CMOS value settings to CMOS and exit setup.

■ Exit Without Saving

Abandon all CMOS value changes and exit setup.

2-1 Standard CMOS Features

CMOS Setup Utility-Copyright (C) 1984-2006 Award Software Standard CMOS Features		
Date (mm:dd:yy)	Mon, Nov 20 2006	Item Help
Time (hh:mm:ss)	10:31:24	Menu Level▶
▶ IDE Channel 0 Master	[None]	
▶ IDE Channel 0 Slave	[None]	
▶ IDE Channel 2 Master	[None]	
▶ IDE Channel 2 Slave	[None]	
▶ IDE Channel 3 Master	[None]	
▶ IDE Channel 3 Slave	[None]	
Drive A	[1.44M, 3.5"]	
Floppy 3 Mode Support	[Disabled]	
Halt On	[All, But Keyboard]	
Base Memory	640K	
Extended Memory	239M	
↑↓→←: Move Enter: Select +/-/PU/PD: Value F10: Save ESC: Exit F1: General Help F5: Previous Values F6: Fail-Safe Defaults F7: Optimized Defaults		

☞ Date

The date format is <week>, <month>, <day>, <year>.

- ▶▶ Week The week, from Sun to Sat, determined by the BIOS and is display-only
- ▶▶ Month The month, Jan. Through Dec.
- ▶▶ Day The day, from 1 to 31 (or the maximum allowed in the month)
- ▶▶ Year The year, from 1999 through 2098

☞ Time

The times format in <hour> <minute> <second>. The time is calculated base on the 24-hour military-time clock. For example, 1 p.m. is 13:00:00.

☞ IDE Channel 0 Master/Slave

- ▶▶ IDE HDD Auto-Detection Press "Enter" to select this option for automatic device detection.
- ▶▶ IDE Channel 0 Master/Slave

IDE devices setup. You can use one of three methods:

- Auto Allows BIOS to automatically detect IDE/SATA devices during POST. (Default value)
- None Select this if no IDE/SATA devices are used and the system will skip the automatic detection step and allow for faster system start up.
- Manual User can manually input the correct settings.
- ▶▶ Access Mode Use this to set the access mode for the hard drive. The four options are: CHS/LBA/Large/Auto(default:Auto)
- ▶▶ Capacity Capacity of correctly installed hard drive.

☞ IDE Channel 2, 3 Master/Slave

- ▶▶ IDE HDD Auto-Detection Press "Enter" to select this option for automatic device detection.
- ▶▶ Extended IDE Drive

You can use one of the two methods:

- Auto Allows BIOS to automatically detect IDE/SATA devices during POST(default)
- None Select this if no IDE/SATA devices are used and the system will skip the automatic detection step and allow for faster system start up.

- ▶▶ Access Mode Use this to set the access mode for the hard drive. The two options are:
Large/Auto(default:Auto)
- ▶▶ Capacity Capacity of currently installed hard drive.
Hard drive information should be labeled on the outside drive casing. Enter the appropriate option based on this information.
- ▶▶ Cylinder Number of cylinders
- ▶▶ Head Number of heads
- ▶▶ Precomp Write precomp
- ▶▶ Landing Zone Landing zone
- ▶▶ Sector Number of sectors

☞ Drive A

The category identifies the types of floppy disk drive A that has been installed in the computer.

- ▶▶ None No floppy drive installed
- ▶▶ 360K, 5.25" 5.25 inch PC-type standard drive; 360K byte capacity.
- ▶▶ 1.2M, 5.25" 5.25 inch AT-type high-density drive; 1.2M byte capacity
(3.5 inch when 3 Mode is Enabled).
- ▶▶ 720K, 3.5" 3.5 inch double-sided drive; 720K byte capacity
- ▶▶ 1.44M, 3.5" 3.5 inch double-sided drive; 1.44M byte capacity.
- ▶▶ 2.88M, 3.5" 3.5 inch double-sided drive; 2.88M byte capacity.

☞ Floppy 3 Mode Support (for Japan Area)

- ▶▶ Disabled Normal Floppy Drive. (Default value)
- ▶▶ Drive A Drive A is 3 mode Floppy Drive.

☞ Halt on

The category determines whether the computer will stop if an error is detected during power up.

- ▶▶ No Errors The system boot will not stop for any error that may be detected and you will be prompted.
- ▶▶ All Errors Whenever the BIOS detects a non-fatal error the system will be stopped.
- ▶▶ All, But Keyboard The system boot will not stop for a keyboard error; it will stop for all other errors. (Default value)
- ▶▶ All, But Diskette The system boot will not stop for a disk error; it will stop for all other errors.
- ▶▶ All, But Disk/Key The system boot will not stop for a keyboard or disk error; it will stop for all other errors.

☞ Memory

The category is display-only which is determined by POST (Power On Self Test) of the BIOS.

▶▶ Base Memory

The POST of the BIOS will determine the amount of base (or conventional) memory installed in the system.

The value of the base memory is typically 512K for systems with 512K memory installed on the motherboard, or 640K for systems with 640K or more memory installed on the motherboard.

▶▶ Extended Memory

The BIOS determines how much extended memory is present during the POST.

This is the amount of memory located above 1 MB in the CPU's memory address map.

2-2 Advanced BIOS Features

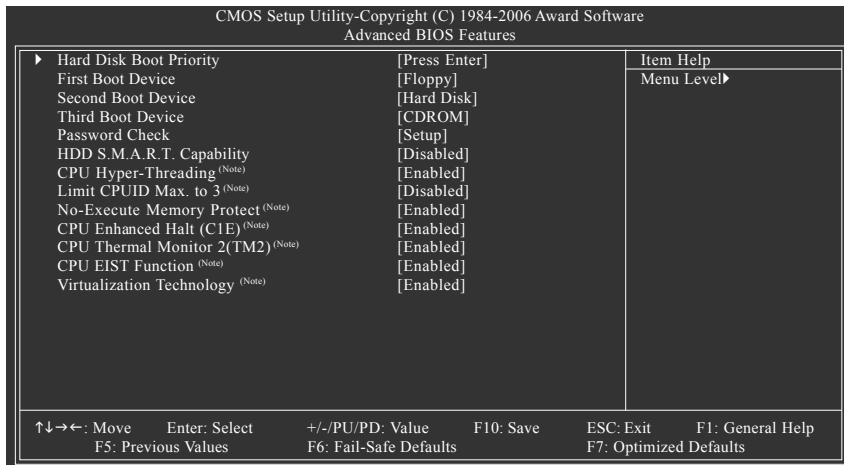

☞ Hard Disk Boot Priority

Select boot sequence for onboard(or add-on cards) SCSI, RAID, etc.

Use <↑> or <↓> to select a device, then press<+> to move it up, or <-> to move it down the list. Press <ESC> to exit this menu.

☞ First / Second / Third Boot Device

- ▶ Floppy Select your boot device priority by Floppy.
- ▶ LS120 Select your boot device priority by LS120.
- ▶ Hard Disk Select your boot device priority by Hard Disk.
- ▶ CDROM Select your boot device priority by CDROM.
- ▶ ZIP Select your boot device priority by ZIP.
- ▶ USB-FDD Select your boot device priority by USB-FDD.
- ▶ USB-ZIP Select your boot device priority by USB-ZIP.
- ▶ USB-CDROM Select your boot device priority by USB-CDROM.
- ▶ USB-HDD Select your boot device priority by USB-HDD.
- ▶ LAN Select your boot device priority by LAN.
- ▶ Disabled Disable this function.

☞ Password Check

- ▶ System The system can not boot and can not access to Setup page will be denied if the correct password is not entered at the prompt.
- ▶ Setup The system will boot, but access to Setup will be denied if the correct password is not entered at the prompt. (Default value)

(Note) This item will show up when you install a processor which supports this function.

☞ **HDD S.M.A.R.T. Capability**

This feature allows your hard disk to report read/write errors and to issue warnings when third-party hardware monitor utility is installed.

- ▶▶ Enabled Enable HDD S.M.A.R.T. capability.
- ▶▶ Disabled Disable HDD S.M.A.R.T. capability. (Default value)

☞ **CPU Hyper-Threading** ^(Note)

▶▶ Enabled Enable CPU Hyper Threading Feature. Please note that this feature is only working for operating system with multi processors mode supported. (Default value)

- ▶▶ Disabled Disable CPU Hyper Threading.

☞ **Limit CPUID Max. to 3** ^(Note)

- ▶▶ Enabled Limit CPUID Maximum value to 3 when use older OS like NT4.
- ▶▶ Disabled Disable CPUID Limit for windows XP. (Default value)

☞ **No-Execute Memory Protect** ^(Note)

- ▶▶ Enabled Enable No-Execute Memory Protect function. (Default value)
- ▶▶ Disabled Disable No-Execute Memory Protect function.

☞ **CPU Enhanced Halt (C1E)** ^(Note)

- ▶▶ Enabled Enable CPU Enhanced Halt (C1E) function. (Default value)
- ▶▶ Disabled Disable CPU Enhanced Halt (C1E) function.

☞ **CPU Thermal Monitor 2 (TM2)** ^(Note)

- ▶▶ Enabled Enable CPU Thermal Monitor 2 (TM2) function. (Default value)
- ▶▶ Disabled Disable CPU Thermal Monitor 2 (TM2) function.

☞ **CPU EIST Function** ^(Note)

- ▶▶ Enabled Enable CPU EIST function. (Default value)
- ▶▶ Disabled Disable EIST function.

☞ **Virtualization Technology** ^(Note)

- ▶▶ Enabled Enable Virtualization technology function. (Default value)
- ▶▶ Disabled Disable this function.

(Note) This item will show up when you install a processor which supports this function.

2-3 Integrated Peripherals

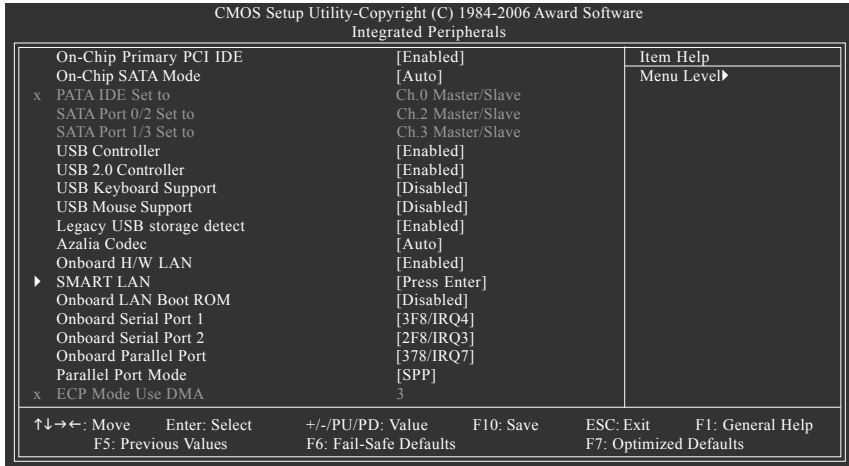

☞ **On-Chip Primary PCI IDE**

- ▶▶ Enabled Enable onboard 1st channel IDE port. (Default value)
- ▶▶ Disabled Disable onboard 1st channel IDE port.

☞ **On-Chip SATA Mode**

- ▶▶ Disabled Disable this function.
- ▶▶ Auto BIOS will auto detect. (Default value)
- ▶▶ Combined Set On-Chip SATA mode to Combined, you can use up to 4 HDDs on the motherboard; 2 for SATA and the other for PATA.
- ▶▶ Enhanced Set On-Chip SATA mode to Enhanced, the motherboard allows up to 6 HDDs to use; 4 for SATA and the other for PATA.
- ▶▶ Non-Combined Set On-Chip SATA mode to Non-Combined, SATA will be simulated to PATA mode. Support a maximum of 4 SATA devices. PATA devices will be ignored.

☞ **PATA IDE Set to**

- ▶▶ Ch.0 Master/Slave Set PATA IDE to Ch. 0 Master/Slave. (Default value)
- ▶▶ Ch.1 Master/Slave Set PATA IDE to Ch. 1 Master/Slave.

☞ **SATA Port 0/2 Set to**

- ▶▶ This value will auto make by the setting "On-Chip SATA Mode" and "PATA IDE Set to".
If PATA IDE were set to Ch. 1 Master/Slave, this function will auto set to Ch. 0 Master/Slave.

☞ **SATA Port 1/3 Set to**

- ▶▶ This value will auto make by the setting "On-Chip SATA Mode" and "PATA IDE Set to".
If PATA IDE were set to Ch. 0 Master/Slave, this function will auto set to Ch. 1 Master/Slave.

☞ **USB Controller**

- ▶▶ Enabled Enable USB controller. (Default value)
- ▶▶ Disabled Disable USB controller.

☞ **USB 2.0 Controller**

You can disable this function if you are not using onboard USB 2.0 feature.

- ▶▶ Enabled Enable USB 2.0 controller. (Default value)
- ▶▶ Disabled Disable USB 2.0 controller.

☞ **USB Keyboard Support**

▶▶ Enabled Enable USB keyboard support.

▶▶ Disabled Disable USB keyboard support. (Default value)

☞ **USB Mouse Support**

▶▶ Enabled Enable USB mouse support.

▶▶ Disabled Disable USB mouse support. (Default value)

☞ **Legacy USB storage detect**

This option allows users to decide whether to detect USB storage devices, including USB flash drives and USB hard drives during POST.

▶▶ Enabled BIOS will scan all USB storage devices. (Default value)

▶▶ Disabled Disable this function.

☞ **Azalia Codec**

▶▶ Auto Auto detect Azalia audio function. (Default value)

▶▶ Disabled Disable Azalia audio function.

☞ **Onboard H/W LAN**

▶▶ Enabled Enable onboard H/W LAN function. (Default value)

▶▶ Disabled Disable this function.

SMART LAN (LAN Cable Diagnostic Function)

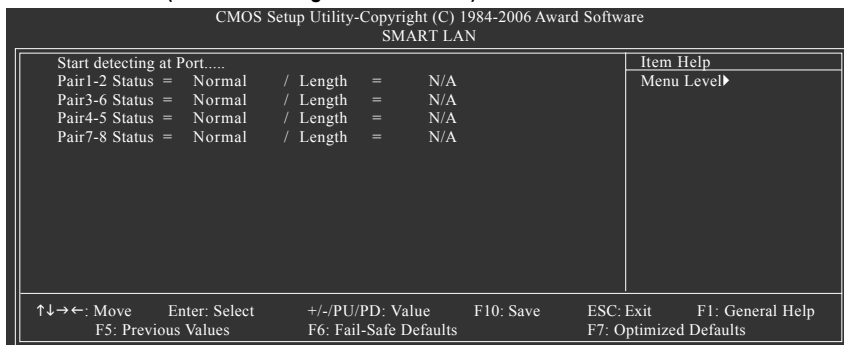

This motherboard incorporates cable diagnostic feature designed to detect the status of the attached LAN cable. This feature will detect cabling issue and report the approximate distance to the fault or short. Refer to the following information for diagnosing your LAN cable:

▶ When LAN Cable Is Functioning Normally...

1. If no cable problem is detected on the LAN cable connected to a Gigabit hub, the **Status** fields of Pair 1-2, Pair 3-6, Pair 4-5, and Pair 7-8 will show **Normal** and the **Length** fields will show **N/A**, as shown in the figure above.
2. If no cable problem is detected on the LAN cable connected to a 10/100 Mbps hub, the **Status** fields of Pair 1-2 and Pair 3-6 will show **Normal** and the **Length** fields will show **N/A**. However, because Pair 4-5 and Pair 7-8 are not used in a 10/100 Mbps environment, their **Status** fields will show **Short** or **Open**, and the length shown is the approximate length of the attached LAN cable.

▶ When a Cable Problem Occurs...

If a cable problem occurs on a specified pair of wires, the **Status** field will show **Short** or **Open** and the length shown will be the approximate distance to the fault or short. For example, if it shows `Pair1-2 Status = Short / Length = 1.6m`, it means that a fault or short might occur at about 1.6m on Pair 1-2.

▶ When No LAN Cable Is Attached...

If no LAN cable is attached to the motherboard, the **Status** fields of all four pairs of wires will show **Open** and the **Length** fields show **0.0m**.

☞ Onboard LAN Boot ROM

This function decide whether to invoke the boot ROM of the onboard LAN chip.

- ▶▶ Enabled Enable this function.
- ▶▶ Disabled Disable this function. (Default value)

☞ Onboard Serial Port 1

- ▶▶ Auto BIOS will automatically setup the port 1 address.
- ▶▶ 3F8/IRQ4 Enable onboard Serial port 1 and address is 3F8/IRQ4. (Default value)
- ▶▶ 2F8/IRQ3 Enable onboard Serial port 1 and address is 2F8/IRQ3.
- ▶▶ 3E8/IRQ4 Enable onboard Serial port 1 and address is 3E8/IRQ4.
- ▶▶ 2E8/IRQ3 Enable onboard Serial port 1 and address is 2E8/IRQ3.
- ▶▶ Disabled Disable onboard Serial port 1.

☞ Onboard Serial Port 2

- ▶▶ Auto BIOS will automatically setup the port 2 address.
- ▶▶ 3F8/IRQ4 Enable onboard Serial port 2 and address is 3F8/IRQ4.
- ▶▶ 2F8/IRQ3 Enable onboard Serial port 2 and address is 2F8/IRQ3. (Default value)
- ▶▶ 3E8/IRQ4 Enable onboard Serial port 2 and address is 3E8/IRQ4.
- ▶▶ 2E8/IRQ3 Enable onboard Serial port 2 and address is 2E8/IRQ3.
- ▶▶ Disabled Disable onboard Serial port 2.

☞ Onboard Parallel Port

- ▶▶ Disabled Disable onboard LPT port.
- ▶▶ 378/IRQ7 Enable onboard LPT port and address is 378/IRQ7. (Default value)
- ▶▶ 278/IRQ5 Enable onboard LPT port and address is 278/IRQ5.
- ▶▶ 3BC/IRQ7 Enable onboard LPT port and address is 3BC/IRQ7.

☞ Parallel Port Mode

- ▶▶ SPP Using Parallel port as Standard Parallel Port. (Default value)
- ▶▶ EPP Using Parallel port as Enhanced Parallel Port.
- ▶▶ ECP Using Parallel port as Extended Capabilities Port.
- ▶▶ ECP+EPP Using Parallel port as ECP & EPP mode.

☞ ECP Mode Use DMA

- ▶▶ 3 Set ECP Mode Use DMA to 3. (Default value)
- ▶▶ 1 Set ECP Mode Use DMA to 1.

2-4 Power Management Setup

CMOS Setup Utility-Copyright (C) 1984-2006 Award Software Power Management Setup		
ACPI Suspend Type	[S1(POS)]	Item Help
Soft-Off by PWR-BTTN	[Instant-Off]	Menu Level▶
PME Event Wake Up	[Enabled]	
Power On by Ring	[Enabled]	
Resume by Alarm	[Disabled]	
x Date (of Month) Alarm	Everyday	
x Time (hh:mm:ss) Alarm	0 : 0 : 0	
Power On By Mouse	[Disabled]	
Power On By Keyboard	[Disabled]	
x KB Power ON Password	Enter	
AC Back Function	[Soft-Off]	

↑↓←→: Move Enter: Select +/-/PU/PD: Value F10: Save ESC: Exit F1: General Help
 F5: Previous Values F6: Fail-Safe Defaults F7: Optimized Defaults

☞ ACPI Suspend Type

- ▶▶ S1(POS) Set ACPI suspend type to S1/POS(Power On Suspend). (Default value)
- ▶▶ S3(STR) Set ACPI suspend type to S3/STR(Suspend To RAM).

☞ Soft-Off by PWR-BTTN

- ▶▶ Instant-Off Press power button then Power off instantly. (Default value)
- ▶▶ Delay 4 Sec. Press power button 4 sec. to Power off. Enter suspend if button is pressed less than 4 sec.

☞ PME Event Wake Up

This feature requires an ATX power supply that provides at least 1A on the 5VSB lead.

- ▶▶ Disabled Disable this function.
- ▶▶ Enabled Enable PME as wake up event. (Default value)

☞ Power On by Ring

- ▶▶ Disabled Disable Power on by Ring function.
- ▶▶ Enabled Enable Power on by Ring function. (Default value)

☞ Resume by Alarm

You can set "Resume by Alarm" item to Enabled and key in Date/Time to power on system.

- ▶▶ Disabled Disable this function. (Default value)
- ▶▶ Enabled Enable alarm function to POWER ON system.

If Resume by Alarm is Enabled.

- ▶▶ Date (of Month) Alarm : Everyday, 1~31
- ▶▶ Time (hh: mm: ss) Alarm : (0~23) : (0~59) : (0~59)

☞ Power On By Mouse

- ▶▶ Disabled Disable this function. (Default value)
- ▶▶ Double Click Double click on PS/2 mouse left button to power on the system.

☞ **Power On By Keyboard**

- ▶▶ Disabled Disable this function. (Default value)
- ▶▶ Password Enter from 1 to 5 characters to set the keyboard power on password.
- ▶▶ Keyboard 98 If your keyboard have "POWER Key" button, you can press the key to power on the system.

☞ **KB Power ON Password**

When "Power On by Keyboard" set at Password, you can set the password here.

- ▶▶ Enter Input password(from 1 to 5 characters) and press Enter to set the password.

☞ **AC BACK Function**

- ▶▶ Soft-Off When AC-power back to the system, the system will be in "Off" state.
(Default value)
- ▶▶ Full-On When AC-power back to the system, the system always in "On" state.
- ▶▶ Memory When AC-power back to the system, the system will return to the Last state before AC-power off.

2-5 PnP/PCI Configurations

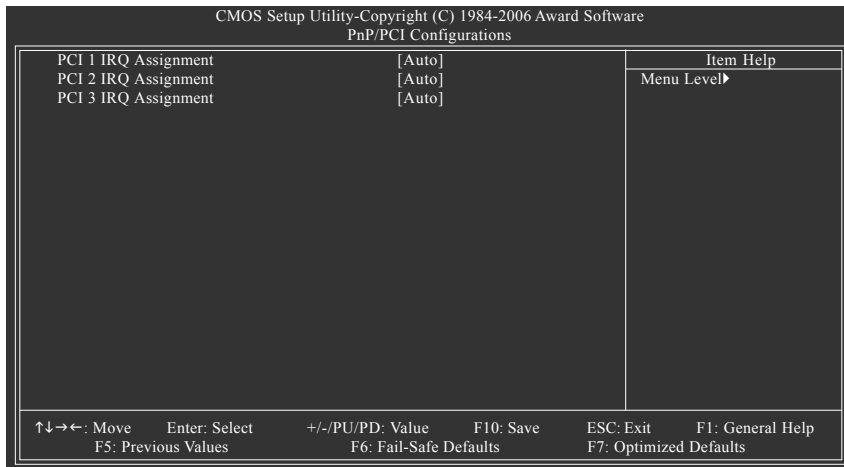

☞ PCI 1 IRQ Assignment

- ▶▶ Auto Auto assign IRQ to PCI 1. (Default value)
- ▶▶ 3,4,5,7,9,10,11,12,14,15 Set IRQ 3,4,5,7,9,10,11,12,14,15 to PCI 1.

☞ PCI 2 IRQ Assignment

- ▶▶ Auto Auto assign IRQ to PCI 2. (Default value)
- ▶▶ 3,4,5,7,9,10,11,12,14,15 Set IRQ 3,4,5,7,9,10,11,12,14,15 to PCI 2.

☞ PCI 3 IRQ Assignment

- ▶▶ Auto Auto assign IRQ to PCI 3. (Default value)
- ▶▶ 3,4,5,7,9,10,11,12,14,15 Set IRQ 3,4,5,7,9,10,11,12,14,15 to PCI 3.

2-6 PC Health Status

CMOS Setup Utility-Copyright (C) 1984-2006 Award Software		
PC Health Status		
		Item Help
Reset Case Open Status	[Disabled]	Menu Level▶
Case Opened	Yes	
Vcore	OK	
DDR18V	OK	
+3.3V	OK	
+12V	OK	
Current CPU Temperature	43°C	
Current CPU FAN Speed	2880 RPM	
Current SYSTEM FAN Speed	0 RPM	
CPU Warning Temperature	[Disabled]	
CPU FAN Fail Warning	[Disabled]	
SYSTEM FAN Fail Warning	[Disabled]	
CPU Smart FAN Control	[Enabled]	
CPU Smart FAN Mode	[Auto]	

↑↓←→: Move Enter: Select +/-/PU/PD: Value F10: Save ESC: Exit F1: General Help
F5: Previous Values F6: Fail-Safe Defaults F7: Optimized Defaults

Reset Case Open Status

- ▶▶ Disabled Don't reset case open status. (Default value)
- ▶▶ Enabled Clear case open status at next boot.

Case Opened

If the case is closed, "Case Opened" will show "No".

If the case have been opened, "Case Opened" will show "Yes".

If you want to reset "Case Opened" value, set "Reset Case Open Status" to "Enabled" and save CMOS, your computer will restart.

Current Voltage(V) Vcore / DDR18V / +3.3V / +12V

- ▶▶ Detect system's voltage status automatically.

Current CPU Temperature

- ▶▶ Detect CPU temperature automatically.

Current CPU / SYSTEM FAN Speed (RPM)

- ▶▶ Detect CPU/System fan speed status automatically.

CPU Warning Temperature

- ▶▶ 60°C / 140°F Monitor CPU temperature at 60°C / 140°F.
- ▶▶ 70°C / 158°F Monitor CPU temperature at 70°C / 158°F.
- ▶▶ 80°C / 176°F Monitor CPU temperature at 80°C / 176°F.
- ▶▶ 90°C / 194°F Monitor CPU temperature at 90°C / 194°F.
- ▶▶ Disabled Disable this function. (Default value)

CPU / System FAN Fail Warning

- ▶▶ Disabled Disable fan warning function. (Default value)
- ▶▶ Enabled Enable fan warning function.

☞ CPU Smart FAN Control

- ▶▶ Disabled Disable this function.
- ▶▶ Enabled When this function is enabled, CPU fan will run at different speed depending on CPU temperature. Users can adjust the fan speed with Easy Tune based on their requirements. (Default value)

☞ CPU Smart FAN Mode

This option is available only when CPU Smart FAN Control is enabled.

- ▶▶ Auto BIOS autodetects the type of CPU fan you installed and sets the optimal CPU Smart FAN control mode for it. (Default value)
- ▶▶ Voltage Set to Voltage when you use a CPU fan with a 3-pin fan power cable.
- ▶▶ PWM Set to PWM when you use a CPU fan with a 4-pin fan power cable.

Note: In fact, the Voltage option can be used for CPU fans with 3-pin or 4-pin power cables. However, some 4-pin CPU fan power cables are not designed following Intel 4-Wire fans PWM control specifications. With such CPU fans, selecting PWM will not effectively reduce the fan speed.

2-7 Frequency/Voltage Control

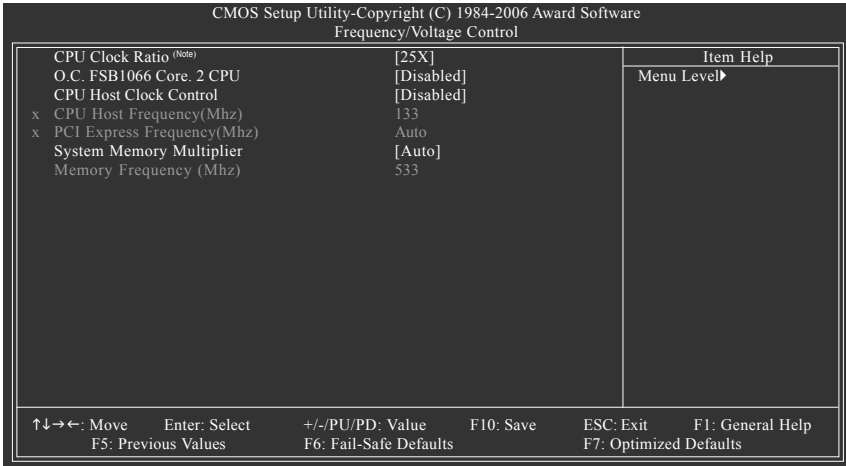

Incorrectly using these features may result in system instability or corruption.

Doing an overclock or overvoltage on CPU, chipsets and memory modules may result in damages or shortened life expectancy to these components.

Please be aware that the menu items are for power users only.

ⓘ CPU Clock Ratio (Note)

This setup option will automatically assign by CPU detection.

The option will display "Locked" and read only if the CPU ratio is not changeable.

ⓘ O.C. FSB1066 Core. 2 CPU

Enable use of Core™ 2 CPUs with 1066 MHz FSB through overclocking. To enable this feature, you must install DDRII 533 memory module(s) and a Core™ 2 CPU.

▶▶ Disabled Disable the use of Core™ 2 CPU (1066 MHz FSB). (Default value)

▶▶ Enabled Enable the use of Core™ 2 CPU (1066 MHz FSB).

ⓘ CPU Host Clock Control

Please note that if your system is overclocked and cannot restart, please wait 20secs. for automatic system restart or clear the CMOS setup data and perform a safe restart.

▶▶ Disabled Disable CPU Host Clock Control. (Default value)

▶▶ Enabled Enable CPU Host Clock Control.

ⓘ CPU Host Frequency(Mhz)

▶▶ 100 ~ 600 Set CPU Host Clock from 100MHz to 600MHz.

The actual range depends on the CPU you install.

If you use a 533 MHz FSB processor, please set **CPU Host Frequency to 133 MHz.**

If you use an 800 MHz FSB processor, please set **CPU Host Frequency to 200 MHz.**

(Note) This item will show up when you install a processor which supports this function.

☞ **PCI Express Frequency(Mhz)**

- ▶▶ Auto Set PCI Express frequency automatically. (Default value)
- ▶▶ 90 ~ 150 Set PCI Express frequency from 90 MHz to 150 MHz.

☞ **System Memory Multiplier**

The adjustable range will vary based on the CPU FSB. Default value: Auto (set memory frequency by DRAM SPD data). Wrong frequency settings may cause system unable to boot. Clear CMOS to overcome wrong frequency issue.

☞ **Memory Frequency (Mhz)**

The values depend on "System Memory Multiplier and CPU Host Frequency" item.

2-8 Load Fail-Safe Defaults

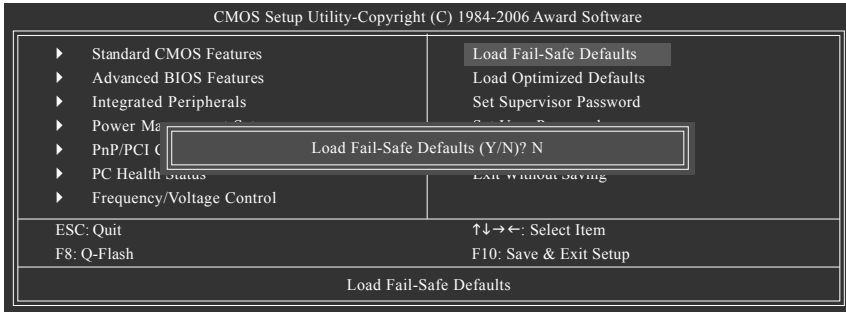

Fail-Safe defaults contain the most appropriate values of the system parameters that allow minimum system performance.

2-9 Load Optimized Defaults

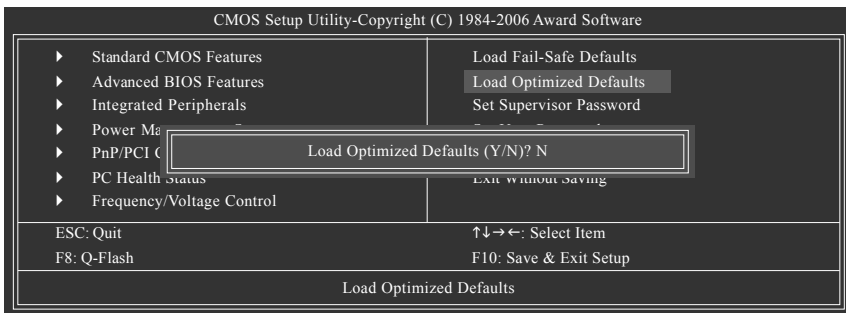

Selecting this field loads the factory defaults for BIOS and Chipset Features which the system automatically detects.

2-10 Set Supervisor/User Password

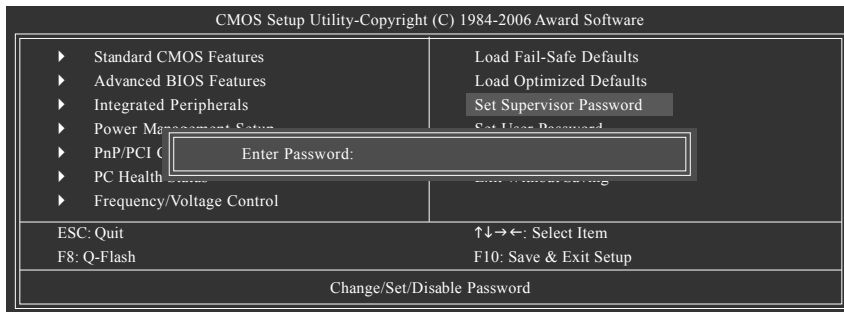

When you select this function, the following message will appear at the center of the screen to assist you in creating a password.

Type the password, up to eight characters, and press <Enter>. You will be asked to confirm the password. Type the password again and press <Enter>. You may also press <Esc> to abort the selection and not enter a password.

To disable password, just press <Enter> when you are prompted to enter password. A message "PASSWORD DISABLED" will appear to confirm the password being disabled. Once the password is disabled, the system will boot and you can enter Setup freely.

The BIOS Setup program allows you to specify two separate passwords:

SUPERVISOR PASSWORD and a USER PASSWORD. When disabled, anyone may access all BIOS Setup program function. When enabled, the Supervisor password is required for entering the BIOS Setup program and having full configuration fields, the User password is required to access only basic items.

If you select "System" at "Password Check" in Advance BIOS Features Menu, you will be prompted for the password every time the system is rebooted or any time you try to enter Setup Menu.

If you select "Setup" at "Password Check" in Advance BIOS Features Menu, you will be prompted only when you try to enter Setup.

2-11 Save & Exit Setup

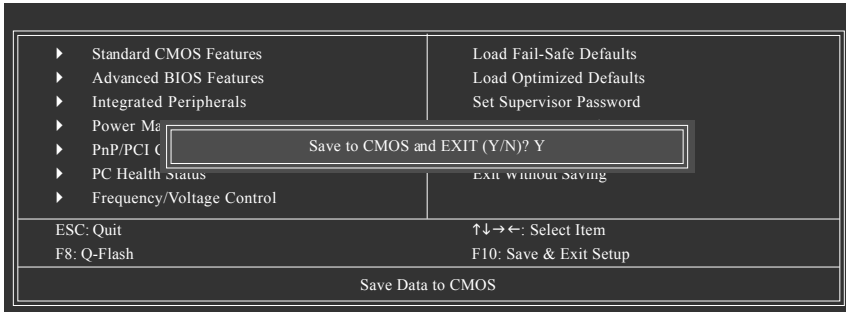

Type "Y" will quit the Setup Utility and save the user setup value to RTC CMOS.
Type "N" will return to Setup Utility.

2-12 Exit Without Saving

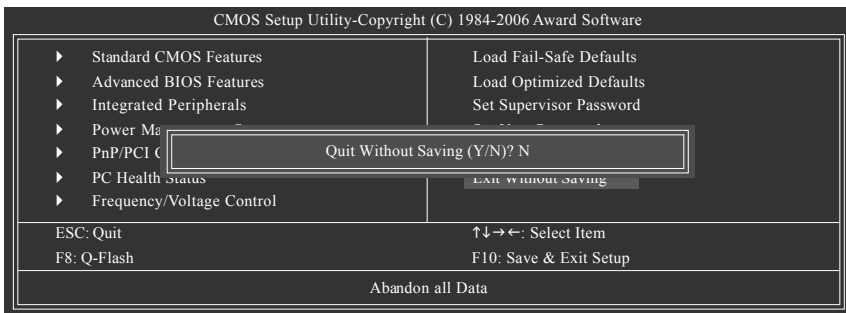

Type "Y" will quit the Setup Utility without saving to RTC CMOS.
Type "N" will return to Setup Utility.

Chapter 3 Install Drivers



Pictures below are shown in Windows XP.

Insert the driver CD-title that came with your motherboard into your CD-ROM drive, the driver CD-title will auto start and show the installation guide. If not, please double click the CD-ROM device icon in "My computer", and execute the Run.exe.

3-1 Install Chipset Drivers

"Xpress Install " is now analyzing your computer...99%

After insert the driver CD, "Xpress Install" will scan automatically the system and then list all the drivers that recommended to install. Please pick the item that you want and press "install" followed the item; or you can press "Xpress Install" to install all items defaulted.

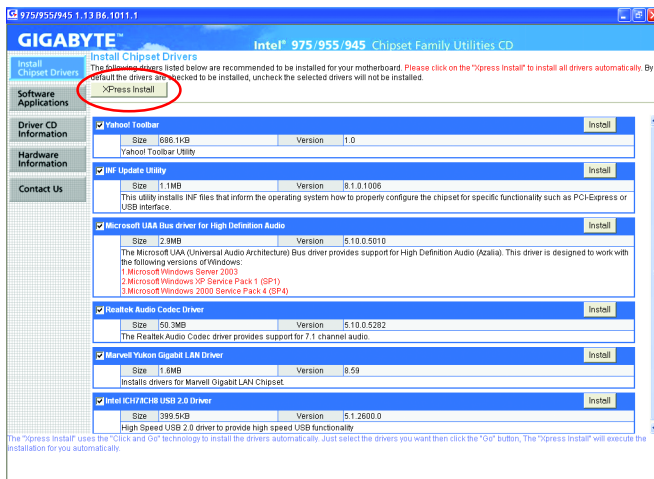

Some device drivers will restart your system automatically. After restarting your system the "Xpress Install" will continue to install other drivers.

System will reboot automatically after install the drivers, afterward you can install others application.



For USB2.0 driver support under Windows XP operating system, please use Windows Service Pack. After install Windows Service Pack, it will show a question mark "?" in "Universal Serial Bus controller" under "Device Manager". Please remove the question mark and restart the system (System will auto-detect the right USB2.0 driver).

3-2 Software Applications

This page displays all the tools that Gigabyte developed and some free software, you can choose anyone you want and press "install" to install them.

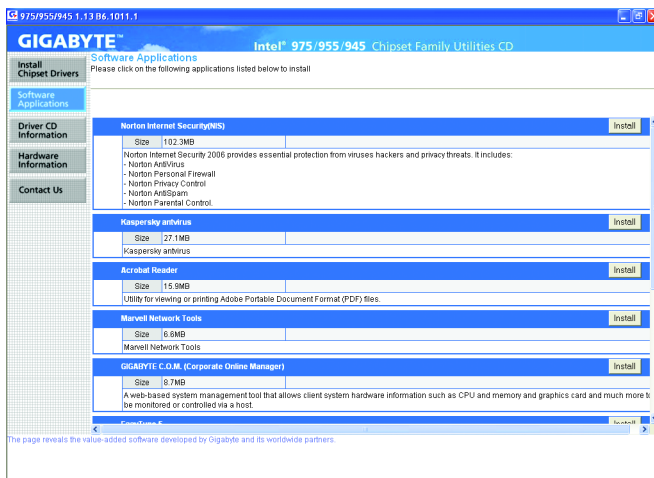

3-3 Driver CD Information

This page lists the contents of software and drivers in this CD-title.

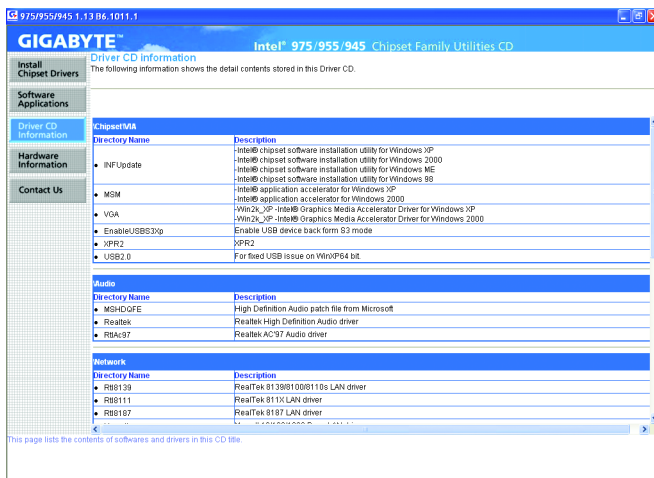

3-4 Hardware Information

This page lists all device you have for this motherboard.

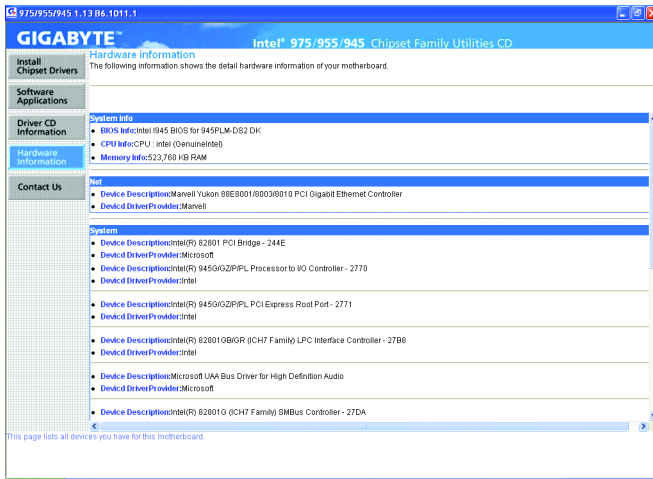

3-5 Contact Us

Please see the last page for details.



Chapter 4 Appendix

4-1 Unique Software Utilities

(Not all model support these Unique Software Utilities, please check your MB features.)

4-1-1 EasyTune 5 Introduction

EasyTune 5 presents the most convenient Windows based system performance enhancement and manageability utility. Featuring several powerful yet easy to use tools such as 1) Overclocking for enhancing system performance, 2) C.I.A. and M.I.B. for special enhancement for CPU and Memory, 3) Smart-Fan control for managing fan speed control of both CPU cooling fan and North-Bridge Chipset cooling fan, 4) PC health for monitoring system status.^(Note)

User Interface Overview



	Button / Display	Description
1.	Overclocking	Enters the Overclocking setting page
2.	C.I.A./C.I.A.2 and M.I.B.	Enters the C.I.A./2 and M.I.B. setting page
3.	Smart-Fan	Enters the Smart-Fan setting page
4.	PC Health	Enters the PC Health setting page
5.	GO	Confirmation and Execution button
6.	"Easy Mode" & "Advance Mode"	Toggles between Easy and Advance Mode
7.	Display screen	Display panel of CPU frequency
8.	Function display LEDs	Shows the current functions status
9.	GIGABYTE Logo	Log on to GIGABYTE website
10.	Help button	Display EasyTune™ 5 Help file
11.	Exit or Minimize button	Quit or Minimize EasyTune™ 5 software

(Note) EasyTune 5 functions may vary depending on different motherboards.

4-1-2 Xpress Recovery2 Introduction



Xpress Recovery2 is designed to provide quick backup and restoration of hard disk data. Supporting Microsoft operating systems including Windows XP/2000/NT/98/Me and DOS, and file systems including FAT16, FAT32, and NTFS, Xpress Recovery2 is able to back up data on hard disks on PATA and SATA IDE controllers. After Xpress Recovery2 is executed from CD-ROM for the first time, it will stay permanent in your hard disk. If you wish to run Xpress Recovery2 later, you can simply press F9 during system bootup to enter Xpress Recovery2 without the CD-ROM.

System requirements:

1. Intel x86 platforms
2. At least 64M bytes of system memory
3. VESA-supported VGA cards

How to use the Xpress Recovery2

Initial access by booting from CD-ROM and subsequent access by pressing the F9 key:

Steps: After entering BIOS Setup, go to **Advanced BIOS Feature** and set to boot from CD-ROM. Save the settings and exit the BIOS Setup. Insert the provided driver CD into your CD-ROM drive. Upon system restart, the message which says "Boot from CD/DVD:" will appear in the bottom left corner of the screen. Press any key to enter Xpress Recovery2.

After the steps above are completed, subsequent access to Xpress Recovery2 can be made by simply pressing the <F9> key during system power-on.



Boot from CD/DVD:

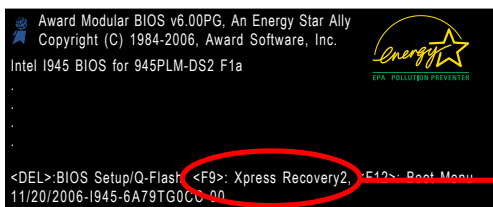

<F9>: Xpress Recovery2



NOTE

1. If you have already entered Xpress Recovery2 by booting from the CD-ROM, you can enter Xpress Recovery2 by pressing the <F9> key in the future.
2. System storage capacity and the reading/writing speed of the hard disk will affect the data backup speed.
3. It is recommended that Xpress Recovery2 be immediately installed once you complete installations of OS and all required drivers as well as software.

The Main Screen of Xpress Recovery2



1. RESTORE:

Restore the backed-up data to your hard disk. (This button will not appear if there is no backup file.)

2. BACKUP:

Back up data from hard disk.

3. REMOVE:

Remove previously-created backup files to release disk space. (This button will not appear if there is no backup file.)

4. REBOOT:

Exit the main screen and restart the system.

Limitations:

1. Not compatible to Xpress Recovery.
2. For the use of Xpress Recovery2, a primary partition must be reserved.
3. Xpress Recovery2 will store the backup file at the end of the hard disk, so free space available on the hard disk for the backup file must be allocated in advance. (A minimum 4GB is recommended but the actual space is dependent on the size of the data to be backed up)
4. Capable of backing up hard disks installed with Windows operating systems including DOS and Windows XP/2000/NT/9x/Me.
5. USB hard disks are currently not supported.
6. Does not support RAID/AHCI (class code 0104/0106) hard disks.
7. Capable of backing up and restoring only the first physical hard disk.

Hard disks detection sequence is as follows:

- a. PATA IDE primary channel
- b. PATA IDE secondary channel
- c. SATA IDE channel 1
- d. SATA IDE channel 2
- e. SATA IDE channel 3
- f. SATA IDE channel 4

Precautions:

1. When using hard disks with more than 128G under Windows 2000, be sure to execute the EnableBigLba.exe program from the driver CD before data backup.
2. It is normal that data backup takes longer time than data restoration.
3. Xpress Recovery2 is compliant with the GPL regulations.
4. On a few motherboards based on Nvidia chipsets, BIOS update is required for Xpress Recovery2 to correctly identify RAID and SATA IDE mode. Please contact your motherboard manufacturer.

4-1-3 Flash BIOS Method Introduction



Method 1 : Q-Flash™ Utility

Q-Flash™ is a BIOS flash utility embedded in Flash ROM. With this utility, users only have to stay in the BIOS menu when they want to update BIOS. Q-Flash™ allows users to flash BIOS without any utility in DOS or Windows. Using Q-Flash™ indicating no more fooling around with any complicated instructions and operating system since it is in the BIOS menu.



Please note that because updating BIOS has potential risk, please do it with caution!! We are sorry that Gigabyte Technology Co., Ltd is not responsible for damages of system because of incorrect manipulation of updating BIOS to avoid any claims from end-users.

Before You Begin:

Before you start updating BIOS with the Q-Flash™ utility, please follow the steps below first.

1. Download the latest BIOS for your motherboard from Gigabyte's website.
2. Extract the BIOS file downloaded and save the BIOS file (the one with model name.Fxx. For example, 8KNXPU.Fba) to a floppy disk.
3. Reboot your PC and press **Del** to enter BIOS menu.

The BIOS upgrading guides below are separated into two parts.

If your motherboard has dual-BIOS, please refer to **Part One**.

If your motherboard has single-BIOS, please refer to **Part Two**.

Part One:

Updating BIOS with Q-Flash™ Utility on Dual BIOS Motherboards.

Some of Gigabyte motherboards are equipped with dual BIOS. In the BIOS menu of the motherboards supporting Q-Flash and Dual BIOS, the Q-Flash utility and Dual BIOS utility are combined in the same screen. This section only deals with how to use Q-Flash utility.

In the following sections, we take GA-8KNXP Ultra as the example to guide you how to flash BIOS from an older version to the latest version. For example, from Fa3 to Fba.

The BIOS file is Fa3
before updating

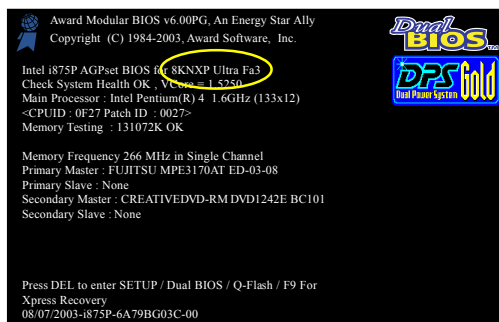

Entering the Q-Flash™ utility:

Step1: To use Q-Flash utility, you must press **Del** in the boot screen to enter BIOS menu.

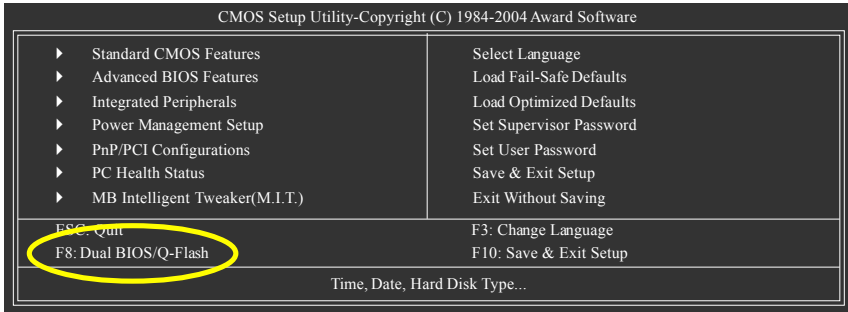

Step 2: Press **F8** button on your keyboard and then **Y** button to enter the Dual BIOS/Q-Flash utility.

Exploring the Q-Flash™ / Dual BIOS utility screen

The Q-Flash / Dual BIOS utility screen consists of the following key components.

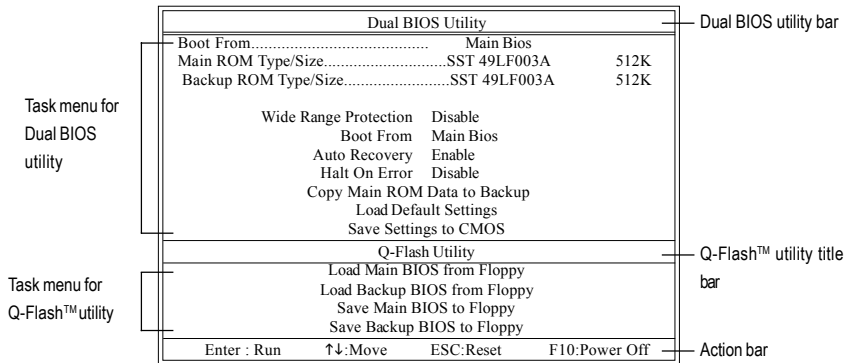

Task menu for Dual BIOS utility:

Contains the names of eight tasks and two item showing information about the BIOS ROM type. Blocking a task and pressing Enter key on your keyboard to enable execution of the task.

Task menu for Q-Flash utility:

Contains the names of four tasks. Blocking a task and pressing Enter key on your keyboard to enable execution of the task.

Action bar:

Contains the names of four actions needed to operate the Q-Flash/Dual BIOS utility. Pressing the buttons mentioned on your keyboards to perform these actions.

Using the Q-Flash™ utility:

This section tells you how to update BIOS using the Q-Flash utility. As described in the "Before you begin" section above, you must prepare a floppy disk having the BIOS file for your motherboard and insert it to your computer. If you have already put the floppy disk into your system and have entered the Q-Flash utility, please follow the steps below to flash BIOS.

Steps:

- 1. Press arrow buttons on your keyboard to move the light bar to "Load Main BIOS from Floppy" item in the Q-Flash menu and press Enter button.

Later, you will see a box pop up showing the BIOS files you previously downloaded to the floppy disk.



If you want to save the current BIOS for backup purpose, you can begin Step 1 with "Save Main BIOS to Floppy" item.

- 2. Move to the BIOS file you want to flash and press Enter.

In this example, we only download one BIOS file to the floppy disk so only one BIOS file, 8KNXPU.Fba, is listed.



Please confirm again you have the correct BIOS file for your motherboard.

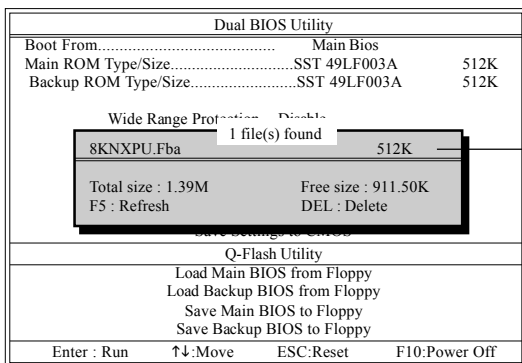

BIOS file in the floppy disk.

After pressing Enter, you'll then see the progress of reading the BIOS file from the floppy disk.

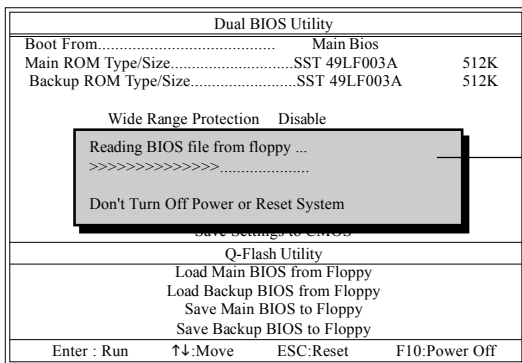

Do not turn off power or reset your system at this stage!!

After BIOS file is read, you'll see a confirmation dialog box asking you "Are you sure to update BIOS?"

3. Press Y button on your keyboard after you are sure to update BIOS.
Then it will begin to update BIOS. The progress of updating BIOS will be displayed.



Please do not take out the floppy disk when it begins flashing BIOS.

4. Press any keys to return to the Q-Flash menu when the BIOS updating procedure is completed.

Dual BIOS Utility		
Boot From.....	Main Bios	
Main ROM Type/Size.....	SST 49LF003A	512K
Backup ROM Type/Size.....	SST 49LF003A	512K
Wide Range Protection Disable		
<div style="border: 2px solid black; padding: 5px; background-color: #cccccc;"> <p>!! Copy BIOS completed - Pass !!</p> <p>Please press any key to continue</p> </div>		
Save Settings to CMOS		
Q-Flash Utility		
Load Main BIOS from Floppy Load Backup BIOS from Floppy Save Main BIOS to Floppy Save Backup BIOS to Floppy		
Enter : Run	↑↓:Move	ESC:Reset F10:Power Off



You can repeat Step 1 to 4 to flash the backup BIOS, too.

5. Press Esc and then Y button to exit the Q-Flash utility. The computer will restart automatically after you exit Q-Flash.

Dual BIOS Utility		
Boot From.....	Main Bios	
Main ROM Type/Size.....	SST 49LF003A	512K
Backup ROM Type/Size.....	SST 49LF003A	512K
Wide Range Protection Disable		
<div style="border: 2px solid black; padding: 5px; background-color: #cccccc;"> <p>Are you sure to RESET ?</p> <p>[Enter] to continue or [Esc] to abort...</p> </div>		
Save Settings to CMOS		
Q-Flash Utility		
Load Main BIOS from Floppy Load Backup BIOS from Floppy Save Main BIOS to Floppy Save Backup BIOS to Floppy		
Enter : Run	↑↓:Move	ESC:Reset F10:Power Off

After system reboots, you may find the BIOS version on your boot screen becomes the one you flashed.

The BIOS file becomes Fba after updating.

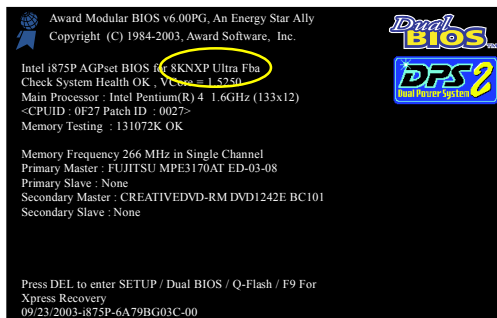

6. Press **Del** to enter BIOS menu after system reboots. When you are in BIOS menu, move to **Load Optimized Defaults** item and press **Enter** to load BIOS Optimized Defaults. Normally the system redetects all devices after BIOS has been upgraded. Therefore, we highly recommend reloading the BIOS defaults after BIOS has been upgraded.

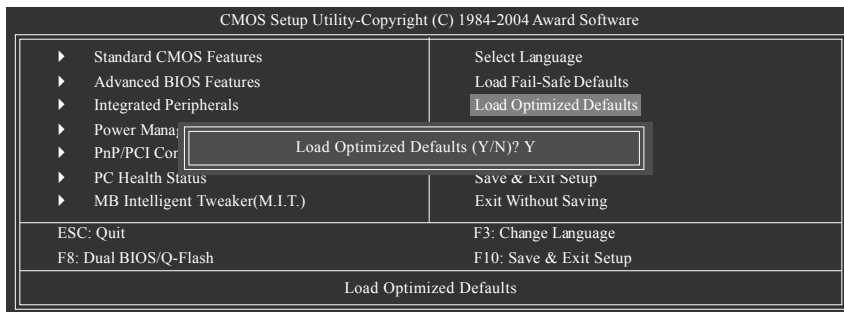

Press **Y** on your keyboard to load defaults.

7. Select **Save & Exit Setup** item to save the settings to CMOS and exit the BIOS menu. System will reboot after you exit the BIOS menu. The procedure is completed.

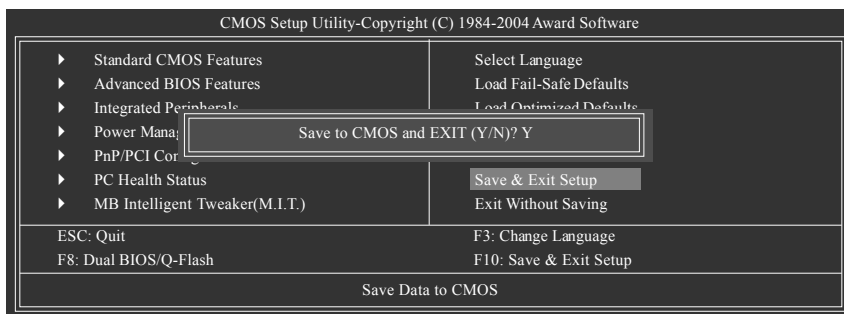

Press **Y** on your keyboard to save and exit.

Part Two:

Updating BIOS with Q-Flash™ Utility on Single-BIOS Motherboards.

This part guides users of single-BIOS motherboards how to update BIOS using the Q-Flash™ utility.

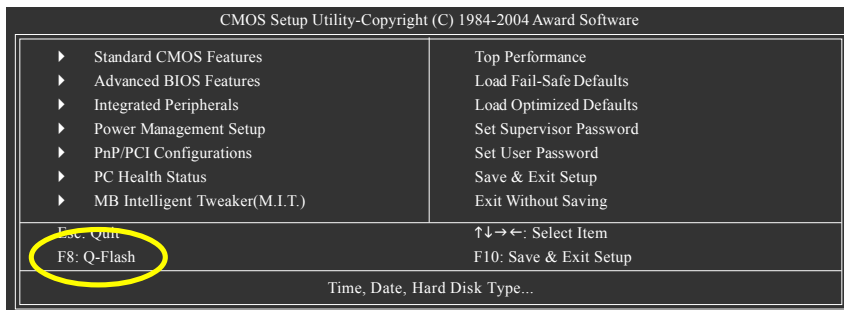

Exploring the Q-Flash™ utility screen

The Q-FlashBIOS utility screen consists of the following key components.

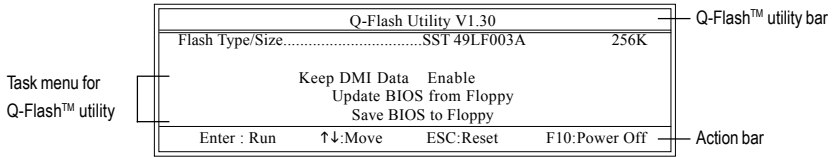

Task menu for Q-Flash utility:

Contains the names of three tasks. Blocking a task and pressing Enter key on your keyboard to enable execution of the task.

Action bar:

Contains the names of four actions needed to operate the Q-Flash utility. Pressing the buttons mentioned on your keyboards to perform these actions.

Using the Q-Flash™ utility:

This section tells you how to update BIOS using the Q-Flash utility. As described in the "Before you begin" section above, you must prepare a floppy disk having the BIOS file for your motherboard and insert it to your computer. If you have already put the floppy disk into your system and have entered the Q-Flash utility, please follow the steps below to flash BIOS.

Steps:

1. Press arrow buttons on your keyboard to move the light bar to "Update BIOS from Floppy" item in the Q-Flash menu and press Enter button.
Later, you will see a box pop up showing the BIOS files you previously downloaded to the floppy disk.



If you want to save the current BIOS for backup purpose, you can begin Step 1 with "Save BIOS to Floppy" item.

2. Move to the BIOS file you want to flash and press Enter.

In this example, we only download one BIOS file to the floppy disk so only one BIOS file, 8GE800.F4, is listed.



Please confirm again you have the correct BIOS file for your motherboard.

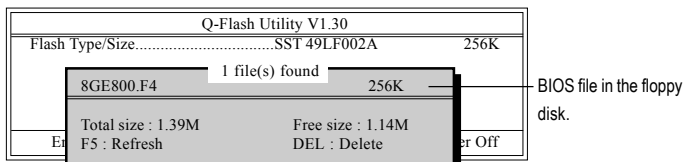

Do not turn off power or reset your system at this stage!!

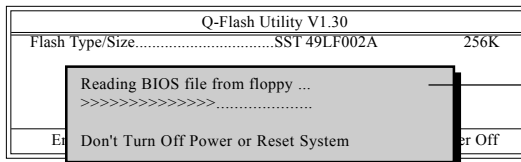

After BIOS file is read, you'll see a confirmation dialog box asking you "Are you sure to update BIOS?"



Please do not take out the floppy disk when it begins flashing BIOS.

- Press Y button on your keyboard after you are sure to update BIOS.
Then it will begin to update BIOS. The progress of updating BIOS will be shown at the same time.

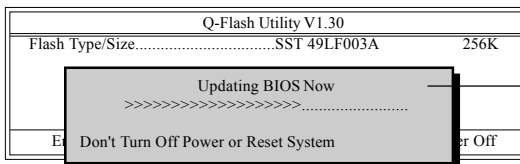

Do not turn off power or reset your system at this stage!!

- Press any keys to return to the Q-Flash menu when the BIOS updating procedure is completed.

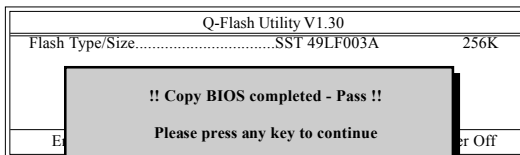

- Press Esc and then Y button to exit the Q-Flash utility. The computer will restart automatically after you exit Q-Flash.

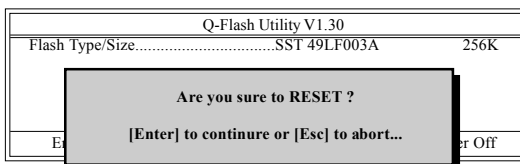

After system reboots, you may find the BIOS version on your boot screen becomes the one you flashed.

The BIOS file becomes F4 after updating

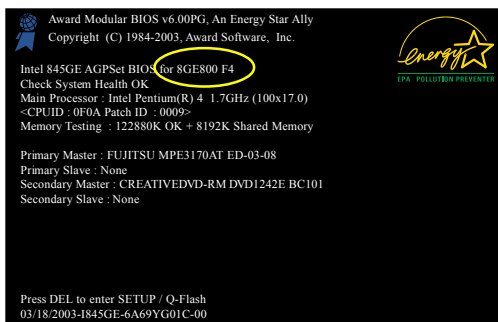

- Press Del to enter BIOS menu after system reboots and "Load BIOS Optimized Defaults". See how to Load BIOS Optimized Defaults, please kindly refer to Step 6 to 7 in **Part One**.

Congratulation!! You have updated BIOS successfully!!

Method 2 : @BIOS™ Utility

If you do not have a DOS startup disk, we recommend that you use the new @BIOS utility. @BIOS allows users to update their BIOS under Windows. Just select the desired @BIOS server to download the latest version of BIOS.

Fig 1. Installing the @BIOS utility

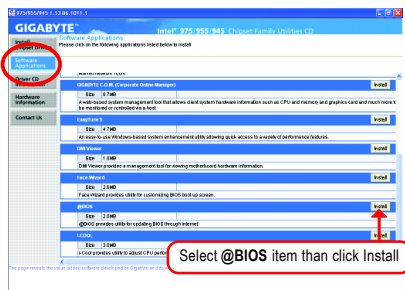

Fig 2. Installation Complete and Run @BIOS

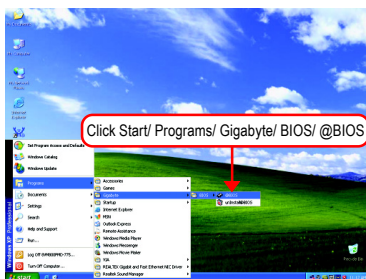

Fig 3. The @BIOS Utility

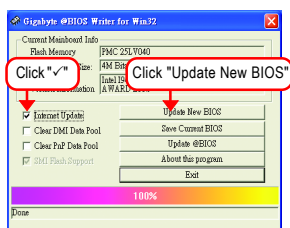
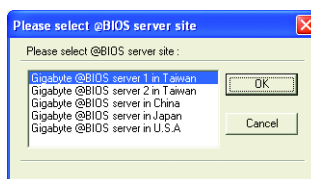

Fig 4. Select the desired @BIOS server



1. Methods and steps:

I. Update BIOS through Internet

- a. Click "Internet Update" icon
- b. Click "Update New BIOS" icon
- c. Select @BIOS™ sever
- d. Select the exact model name on your motherboard
- e. System will automatically download and update the BIOS.

II. Update BIOS NOT through Internet:

- a. Do not click "Internet Update" icon
- b. Click "Update New BIOS"
- c. Please select "All Files" in dialog box while opening the old file.
- d. Please search for BIOS unzip file, downloading from internet or any other methods (such as: 9plmids21.F1).
- e. Complete update process following the instruction.

III. Save BIOS

In the very beginning, there is "Save Current BIOS" icon shown in dialog box. It means to save the current BIOS version.

IV. Check out supported motherboard and Flash ROM:

In the very beginning, there is "About this program" icon shown in dialog box. It can help you check out which kind of motherboard and which brand of Flash ROM are supported.

2. Note:

- I. In method I, if it shows two or more motherboard's model names to be selected, please make sure your motherboard's model name again. Selecting wrong model name will cause the system unbooted.
- II. In method II, be sure that motherboard's model name in BIOS unzip file are the same as your motherboard's. Otherwise, your system won't boot.
- III. In method I, if the BIOS file you need cannot be found in @BIOS™ server, please go onto Gigabyte's web site for downloading and updating it according to method II.
- IV. Please note that any interruption during updating will cause system unbooted.
- V. Do not use @BIOS and C.O.M. (Corporate Online Management) at the same time.

The default speaker settings for the 6 audio jacks are as shown in the picture to the right. The jack retasking capability supported by HD Audio allows users to change the function for each audio jack by the audio software provided. For example, if a rear speaker is plugged into the center/subwoofer speaker out jack, you can change the center/subwoofer speaker out jack to function as a rear speaker out jack via the audio software. Please follow the steps to install the function. (Following pictures are in Windows XP)

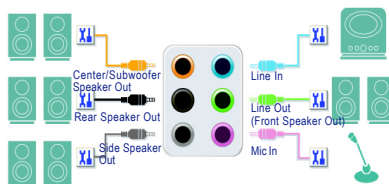

Note that if you wish to connect a microphone, you MUST connect it to the default Mic In jack for the microphone to work correctly.

HD Audio

With multiple built-in high quality digital-to-analog converters (DACs) that support audio output at up to 192 kHz/24-bit quality and multi-streaming applications, HD Audio is able to handle multiple audio streams (in and out) simultaneously. Multi-channel audio experiences have become a reality so you can, for instance, listen to MP3 music, have an Internet chat, make a telephone call over the Internet, and etc. all at the same time.

Stereo Speakers Connection and Settings:

We recommend that you use the speaker with amplifier to acquire the best sound effect if the stereo output is applied.

STEP 1 :

After installation of the audio driver, you should find an Audio Manager  icon in your system tray (you can also find the icon in Control Panel). Double-click the icon to open the Audio Control Panel.



STEP 2:

In the Audio Control Panel, click the **Audio I/O** tab.
In the upper left list, click **2CH Speaker**.

**STEP 3:**

Connect a speaker or headphone to the rear Line Out jack, a small window will pop up and ask you what type of equipment is connected. Choose **Headphone** or **Line Out** depending on the device connected and click **OK**. The 2-channel audio setup is completed.

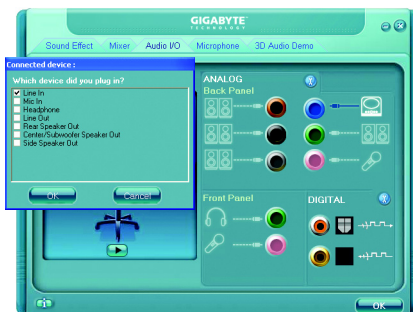
**Setting Up 4-Channel Audio****STEP 1 :**

After installation of the audio driver, you should find an Audio Manager icon in your system tray (you can also find the icon in Control Panel). Double-click the icon to open the Audio Control Panel.



STEP 2:

In the Audio Control Panel, click the **Audio I/O** tab. In the upper left list, click **4CH Speaker**.

**STEP 3:**

Connect the 4-channel speakers to the audio jacks on the motherboard and the surround cable, a small window will pop up and ask you what type of equipment is connected. Choose a device depending on the type of speaker connected (4-channel audio consists of Front Speaker Out (Line Out) and Rear Speaker Out) and then click **OK**. The 4-channel audio setup is completed.

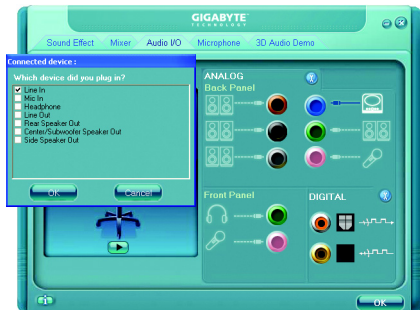
**Setting Up 6-Channel Audio****STEP 1 :**

After installation of the audio driver, you should find an Audio Manager icon in your system tray (you can also find the icon in Control Panel). Double-click the icon to open the Audio Control Panel.

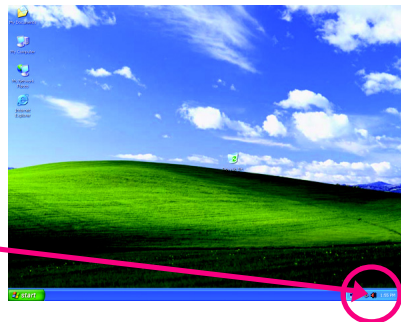

STEP 2:

In the Audio Control Panel, click the **Audio I/O** tab. In the upper left list, click **6CH Speaker**.

**STEP 3:**

Connect the 6-channel speakers to the audio jacks on the motherboard and the surround cable, a small window will pop up and ask you what type of equipment is connected. Choose a device depending on the type of speaker connected (6-channel audio consists of Front Speaker Out (Line Out), Rear Speaker Out, and Center/Subwoofer Speaker Out) then click **OK**. The 6-channel audio setup is completed.

**Setting Up 8-Channel Audio****STEP 1 :**

After installation of the audio driver, you should find an Audio Manager icon in your system tray (you can also find the icon in Control Panel). Double-click the icon to open the Audio Control Panel.



STEP 2:

In the Audio Control Panel, click the **Audio I/O** tab.
In the upper left list, click **8CH Speaker**.

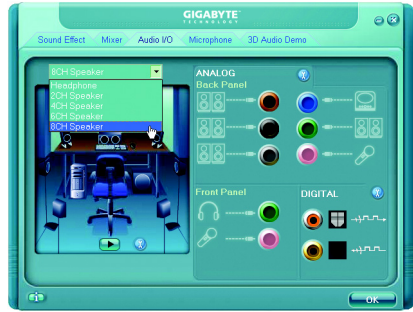
**STEP 3:**

Connect the 8-channel speakers to the audio jacks on the motherboard and the surround cable, a small window will pop up and ask you what type of equipment is connected. Choose a device depending on the type of speaker connected (8-channel audio consists of Front Speaker Out (Line Out), Rear Speaker Out, Center/Subwoofer Speaker Out, and Side Speaker Out) then click **OK**. The 8-channel audio setup is completed.

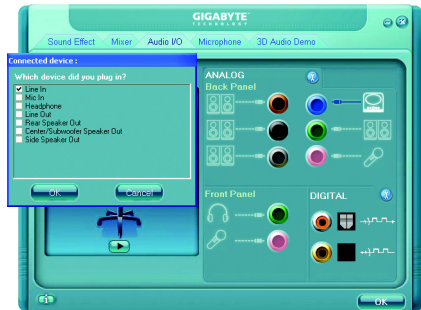
**Sound Effect Configuration:**

At the **Sound Effect** menu, users can adjust sound option settings as desired.



AC'97 Audio Configuration:

To enable the front panel audio connector to support AC97 Audio mode, go to the Audio Control Panel and click the **Audio I/O** tab. In the **ANALOG** area, click the **Tool** icon and then select the **Disable front panel jack detection** check box. This action completes the AC'97 Audio configuration.

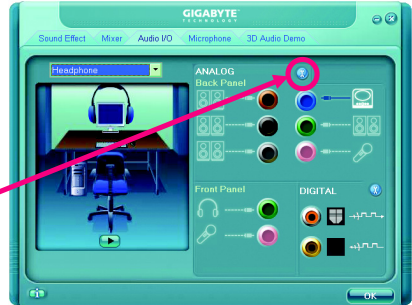

4-2 Troubleshooting

Below is a collection of general asked questions. To check general asked questions based on a specific motherboard model, please log on to <http://www.gigabyte.com.tw>

Question 1: I cannot see some options that were included in previous BIOS after updating BIOS. Why?

Answer: Some advanced options are hidden in new BIOS version. Please press Ctrl and F1 keys after entering BIOS menu and you will be able to see these options.

Questions 2: Why is the light of my keyboard/optical mouse still on after computer shuts down?

Answer: In some boards, a small amount of electricity is kept on standby after computer shuts down and that's why the light is still on.

Question 3: How do I clear CMOS?

Answer: If your board has a Clear CMOS jumper, please refer to the Clear CMOS steps in the manual. If your board doesn't have such jumper, you can take off the on-board battery to leak voltage to clear CMOS. Please refer to the steps below:

Steps:

1. Turn off power.
2. Disconnect the power cord from MB.
3. Take out the battery gently and put it aside for about 1 minute (Or you can use a metal object to connect the positive and negative pins in the battery holder to makethem short for 5 seconds).
4. Re-insert the battery to the battery holder.
5. Connect power cord to MB again and turn on power.
6. Press Del to enter BIOS and load Fail-Safe Defaults(or load Optimized Defaults).
7. Save changes and reboot the system.

Question 4: Why do I still get a weak sound after turning up the speaker to the maximum volume?

Answer: Please make sure the speaker you are using is equipped with an internal amplifier. If not, please change another speaker with power/amplifier and try again later.

Question 5: Sometimes I hear different continuous beeps from computer after system boots up. What do these beeps usually stand for?

Answer: The beep codes below may help you identify the possible computer problems. However, they are only for reference purposes. The situations might differ from case to case.

→ AWARD BIOS Beep Codes

1 short: System boots successfully

2 short: CMOS setting error

1 long 1 short: DRAM or M/B error

1 long 2 short: Monitor or display card error

1 long 3 short: Keyboard error

1 long 9 short: BIOS ROM error

Continuous long beeps: DRAM error

Continuous short beeps: Power error



Contact Us

- **Taiwan (Headquarters)**

GIGA-BYTE TECHNOLOGY CO., LTD.

Address: No.6, Bau Chiang Road, Hsin-Tien,

Taipei 231, Taiwan

TEL: +886-2-8912-4888

FAX: +886-2-8912-4003

Tech. and Non-Tech. Support (Sales/Marketing) :

<http://ggts.gigabyte.com.tw>

WEB address (English): <http://www.gigabyte.com.tw>

WEB address (Chinese): <http://www.gigabyte.tw>

- **U.S.A.**

G.B.T. INC.

TEL: +1-626-854-9338

FAX: +1-626-854-9339

Tech. Support:

<http://rma.gigabyte-usa.com>

Web address: <http://www.gigabyte.us>

- **Mexico**

G.B.T Inc (USA)

Tel: +1-626-854-9338 x 215 (Soporte de habla hispano)

FAX: +1-626-854-9339

Correo: soporte@gigabyte-usa.com

Tech. Support:

<http://rma.gigabyte-usa.com>

Web address: <http://www.gigabyte-latam.com>

- **Japan**

NIPPON GIGA-BYTE CORPORATION

WEB address : <http://www.gigabyte.co.jp>

- **Singapore**

GIGA-BYTE SINGAPORE PTE. LTD.

WEB address : <http://www.gigabyte.com.sg>

- **China**

NINGBO G.B.T. TECH. TRADING CO., LTD.

WEB address : <http://www.gigabyte.cn>

- **Shanghai**

TEL: +86-21-63410999

FAX: +86-21-63410100

- **Beijing**

TEL: +86-10-62102838

FAX: +86-10-62102848

- **Wuhan**

TEL: +86-27-87851061

FAX: +86-27-87851330

- **GuangZhou**

TEL: +86-20-87540700

FAX: +86-20-87544306 ext. 333

- **Chengdu**

TEL: +86-28-85236930

FAX: +86-28-85256822 ext. 814

- **Xian**

TEL: +86-29-85531943

FAX: +86-29-85539821

- **Shenyang**

TEL: +86-24-83992901

FAX: +86-24-83992909

- **India**

GIGABYTE TECHNOLOGY (INDIA) LIMITED

WEB address : <http://www.gigabyte.in>

- **Australia**

GIGABYTE TECHNOLOGY PTY. LTD.

WEB address : <http://www.gigabyte.com.au>

- **Germany**

G.B.T. TECHNOLOGY TRADING GMBH

WEB address : <http://www.gigabyte.de>

- **U.K.**

G.B.T. TECH. CO., LTD.

WEB address : <http://www.giga-byte.co.uk>

- **The Netherlands**

GIGA-BYTE TECHNOLOGY B.V.

WEB address : <http://www.giga-byte.nl>

- **France**

GIGABYTE TECHNOLOGY FRANCE

WEB address : <http://www.gigabyte.fr>

- **Italy**

WEB address : <http://www.giga-byte.it>

- **Spain**

GIGA-BYTE SPAIN

WEB address : <http://www.giga-byte.es>

- **Czech Republic**

Representative Office Of GIGA-BYTE Technology Co., Ltd.
in CZECH REPUBLIC

WEB address : <http://www.gigabyte.cz>

- **Turkey**

Representative Office Of GIGA-BYTE Technology Co., Ltd.
in TURKEY

WEB address : <http://www.gigabyte.com.tr>

- **Russia**

Moscow Representative Office Of GIGA-BYTE Technology Co., Ltd.

WEB address : <http://www.gigabyte.ru>

- **Latvia**

GIGA-BYTE Latvia

WEB address : <http://www.gigabyte.com.lv>

- **Poland**

Office of GIGA-BYTE TECHNOLOGY Co., Ltd. in POLAND

WEB address : <http://www.gigabyte.pl>

- **Ukraine**

WEB address : <http://www.gigabyte.kiev.ua>

- **Romania**

Representative Office Of GIGA-BYTE Technology Co., Ltd.
in Romania

WEB address : <http://www.gigabyte.com.ro>

- **Serbia & Montenegro**

Representative Office Of GIGA-BYTE Technology Co., Ltd.
in SERBIA & MONTENEGRO

WEB address : <http://www.gigabyte.co.yu>

- **GIGABYTE Global Service System**



To submit a technical or non-technical (Sales/Marketing) question, please link to :

<http://gts.gigabyte.com.tw>

Then select your language to enter the system.



关于符合中国《电子信息产品污染控制管理办法》的声明
 Management Methods on Control of Pollution from Electronic Information Products
 (China RoHS Declaration)

产品中有毒有害物质或元素的名称及含量
 Hazardous Substances Table

部件名称 (Parts)	有毒有害物质或元素 (Hazardous Substances)					
	铅 (Pb)	汞 (Hg)	镉 (Cd)	六价铬 (Cr (VI))	多溴联苯 (PBB)	多溴二苯醚 (PBDE)
PCB板 PCB	○	○	○	○	○	○
结构件及风扇 Mechanical parts and Fan	×	○	○	○	○	○
芯片及其他出动零件 Chip and other Active components	×	○	○	○	○	○
连接器 Connectors	×	○	○	○	○	○
被动电子元器们 Passive Components	×	○	○	○	○	○
线材 Cables	○	○	○	○	○	○
焊接金属 Soldering metal	○	○	○	○	○	○
助焊剂, 散热膏, 标签及其他耗材 Flux, Solder Paste, Label and other Consumable Materials	○	○	○	○	○	○
○:表示该有毒有害物质在该部件所有均质材料中的含量均在SJ/T11363-2006标准规定的限量要求以下。 Indicates that this hazardous substance contained in all homogenous materials of this part is below the limit requirement SJ/T 11363-2006						
×:表示该有毒有害物质至少在该部件的某一均质材料中的含量超出SJ/T11363-2006标准规定的限量要求。 Indicates that this hazardous substance contained in at least one of the homogenous materials of this part is above the limit requirement in SJ/T 11363-2006						
对销售之日的所发售产品, 本表显示我公司供应链的电子信息产品可能包含这些物质。注意: 在所售产品中可能会也可能不会含有所有列出的部件。 This table shows where these substances may be found in the supply chain of our electronic information products, as of the date of the sale of the enclosed products. Note that some of the component types listed above may or may not be a part of the enclosed product.						

Free Manuals Download Website

<http://myh66.com>

<http://usermanuals.us>

<http://www.somanuals.com>

<http://www.4manuals.cc>

<http://www.manual-lib.com>

<http://www.404manual.com>

<http://www.luxmanual.com>

<http://aubethermostatmanual.com>

Golf course search by state

<http://golfingnear.com>

Email search by domain

<http://emailbydomain.com>

Auto manuals search

<http://auto.somanuals.com>

TV manuals search

<http://tv.somanuals.com>