



When you installing AGP card, please make sure the following notice is fully understood and practiced. If your AGP card has "AGP 4X(1.5V) notch" (show below), please make sure your AGP card is AGP 4X(1.5V).



Caution: AGP 2X(3.3V) card is not supported by Intel® 845(GE/PE) / 845(E/G) / 850(E). You might experience system unable to boot up normally. Please insert an AGP 4X(1.5V) card

Example 1: Diamond Vipper V770 golden finger is compatible with 2X/4X mode AGP slot. It can be switched between AGP 2X(3.3V) or 4X(1.5V) mode by adjusting the jumper. The factory default for this card is 2X(3.3V).

The GA-8PE667 Ultra2 / GA-8PE667 Pro(or any AGP 4X only) motherboards might not function properly, if you install this card without switching the jumper to 4X(1.5) mode in it.

Example 2: Some ATi Rage 128 Pro graphics cards made by "Power Color", the graphics card manufacturer & some SiS 305 cards, their golden finger is compatible with 2X(3.3V)/4X(1.5V) mode AGP slot, but they support 2X(3.3V) only. The GA-8PE667 Ultra2 / GA-8PE667 Pro (or any AGP 4X only) motherboards might not function properly, If you install this card in it.

Note : Although Gigabyte's AG32S(G) graphics card is based on ATi Rage 128 Pro chip, the design of AG32S(G) is compliance with AGP 4X(1.5V) specification. Therefore, AG32S (G)will work fine with Intel®845(GE/PE) /845(E/G) / 850(E) based motherboards.



Before you install PCI cards, please remove the Dual BIOS label from PCI slots if there is one.



- ☛ The author assumes no responsibility for any errors or omissions that may appear in this document nor does the author make a commitment to update the information contained herein.
- ☛ Third-party brands and names are the property of their respective owners.
- ☛ Please do not remove any labels on motherboard, this may void the warranty of this motherboard.
- ☛ Due to rapid change in technology, some of the specifications might be out of date before publication of this booklet.



WARNING: Never run the processor without the heatsink properly and firmly attached. **PERMANENT DAMAGE WILL RESULT!**

Mise en garde : Ne faites jamais tourner le processeur sans que le dissipateur de chaleur soit fixé correctement et fermement. **UN DOMMAGE PERMANENT EN RÉSULTERA !**

Achtung: Der Prozessor darf nur in Betrieb genommen werden, wenn der W irmebleiber ordnungsgem ä and fest angebracht ist. **DIES HAT EINEN PERMANENTEN SCHADEN ZUR FOLGE!**

Advertencia: Nunca haga funcionar el procesador sin el dissipador de calor instalado correcta y firmemente. **¡SE PRODUCIRÁ UN DAÑO PERMANENTE!**

Aviso: Nunca execute o procesador sem o dissipador de calor estar adequadamente e firmemente conectado. **O RESULTADO SERÁ UM DANO PERMANENTE!**

警告: 将散热器牢固地安装到处理器上之前, 不要运行处理器。否则将永远损坏处理器!

警告: 将散热器牢固地安装到处理器上之前, 不要运行处理器。否则将永远损坏处理器!

注意: 히트싱크를 제대로 또 단단히 부착시키지 않은 채 프로세서를 구동시키지 마십시오. 영구적 고장이 발생할 수 있습니다!

警告: 永久的な損傷を防止するため、ヒートシンクを正しくしっかりと取り付けるまでは、プロセッサを動作させないようにしてください。

Declaration of Conformity

We, Manufacturer/Importer
(full address)

G.B.T. Technology Trading GmbH
Ausschlagler Weg 41, 1F, 20537 Hamburg, Germany

declare that the product
(description of the apparatus, system, installation to which it refers)

Mother Board

GA-8PE667 Ultra2 / GA-8PE667 Pro
is in conformity with

(reference to the specification under which conformity is declared)
in accordance with 89/336 EEC-EMC Directive

| | | | |
|---|--|--|--|
| <input type="checkbox"/> EN 55011 | Limits and methods of measurement of radio disturbance characteristics of industrial, scientific and medical (ISM) high frequency equipment | <input type="checkbox"/> EN 61000-3-2* <input checked="" type="checkbox"/> EN 60555-2 | Disturbances in supply systems cause by household appliances and similar electrical equipment "Harmonics" |
| <input type="checkbox"/> EN 55013 | Limits and methods of measurement of radio disturbance characteristics of broadcast receivers and associated equipment | <input type="checkbox"/> EN 61000-3-3* <input checked="" type="checkbox"/> EN 60555-3 | Disturbances in supply systems cause by household appliances and similar electrical equipment "Voltage fluctuations" |
| <input type="checkbox"/> EN 55014 | Limits and methods of measurement of radio disturbance characteristics of household electrical appliances, portable tools and similar electrical apparatus | <input checked="" type="checkbox"/> EN 50081-1 <input checked="" type="checkbox"/> EN 50082-1 | Generic emission standard Part 1: Residual commercial and light industry Generic immunity standard Part 1: Residual commercial and light industry |
| <input type="checkbox"/> EN 55015 | Limits and methods of measurement of radio disturbance characteristics of fluorescent lamps and luminaries | <input type="checkbox"/> EN 55081-2 | Generic emission standard Part 2: Industrial environment |
| <input type="checkbox"/> EN 55020 | Immunity from radio interference of broadcast receivers and associated equipment | <input type="checkbox"/> EN 55082-2 | Generic emission standard Part 2: Industrial environment |
| <input checked="" type="checkbox"/> EN 55022 | Limits and methods of measurement of radio disturbance characteristics of information technology equipment | <input type="checkbox"/> ENV 55104 | Immunity requirements for household appliances tools and similar apparatus |
| <input type="checkbox"/> DIN VDE 0855 <input type="checkbox"/> part 10 <input type="checkbox"/> part 12 | Cabled distribution systems; Equipment for receiving and/or distribution from sound and television signals | <input type="checkbox"/> EN50091-2 | EMC requirements for uninterruptible power systems (UPS) |
| <input checked="" type="checkbox"/> CE marking | |  | (EC conformity marking) |

The manufacturer also declares the conformity of above mentioned product
with the actual required safety standards in accordance with LVD 73/23 EEC

| | | | |
|-----------------------------------|---|-------------------------------------|--|
| <input type="checkbox"/> EN 60065 | Safety requirements for mains operated electronic and related apparatus for household and similar general use | <input type="checkbox"/> EN 60950 | Safety for information technology equipment including electrical bussiness equipment |
| <input type="checkbox"/> EN 60335 | Safety of household and similar electrical appliances | <input type="checkbox"/> EN 50091-1 | General and Safety requirements for uninterruptible power systems (UPS) |

Manufacturer/Importer

(Stamp)

Date : Nov. 12, 2002

Signature:

Name:

Timmy Huang
Timmy Huang

DECLARATION OF CONFORMITY

Per FCC Part 2 Section 2.1077(a)



Responsible PartName: G.B.T. INC. (U.S.A.)

Address: 17358 Railroad Street
City of Industry, CA 91748

Phone/Fax No: (818) 854-9338/ (818) 854-9339

hereby declares that the product

Product Name: Motherboard

Model Number: GA-8PE667 Ultra2 / GA-8PE667 Pro

Conforms to the following specifications:

FCC Part 15, Subpart B, Section 15.107(a) and Section 15.109
(a), Class B Digital Device

Supplementary Information:

This device complies with part 15 of the FCC Rules. Operation is subject to the following two conditions: (1) This device may not cause harmful and (2) this device must accept any inference received, including that may cause undesired operation.

Representative Person's Name: ERIC LU

Signature: *Eric Lu*

Date: Nov. 12, 2002

GA-8PE667 Ultra2 / Pro
P4 Titan 667 Motherboard

USER ' S MANUAL

Pentium®4 Processor Motherboard

Rev. 1201

12ME-8PE667U2-1201

Table of Content

| | |
|--|----|
| Item Checklist | 4 |
| WARNING! | 4 |
| | |
| Chapter 1 Introduction | 5 |
| Features Summary | 5 |
| GA-PE667 Ultra 2 / Pro Motherboard Layout | 8 |
| Block Diagram | 9 |
| | |
| Chapter 2 Hardware Installation Process | 11 |
| Step 1: Install the Central Processing Unit (CPU) | 12 |
| Step 1-1 : CPU Installation | 12 |
| Step 1-2 : CPU Heat Sink Installation | 13 |
| Step 2: Install memory modules | 14 |
| Step 3: Install expansion cards | 16 |
| Step 4: Connect ribbon cables, cabinet wires, and power supply | 17 |
| Step 4-1 : I/O Back Panel Introduction | 17 |
| Step 4-2 : Connectors & Jumper Setting Introduction | 19 |
| | |
| Chapter 3 BIOS Setup | 35 |
| The Main Menu (For example: BIOS Ver. :F1) | 36 |
| Standard CMOS Features | 38 |
| Advanced BIOS Features | 41 |
| Integrated Peripherals | 43 |

| | |
|---|----|
| Power Management Setup | 49 |
| PnP/PCI Configurations | 52 |
| PC Health Status | 53 |
| Frequency/Voltage Control | 55 |
| Top Performance | 57 |
| Select Language | 58 |
| Load Fail-Safe Defaults | 59 |
| Load Optimized Defaults | 60 |
| Set Supervisor/User Password | 61 |
| Save & Exit Setup | 62 |
| Exit Without Saving | 63 |
| | |
| Chapter 4 Technical Reference | 65 |
| @ BIOS Introduction | 65 |
| Easy Tune 4™ Introduction | 66 |
| Face-Wizard Utilities Installation | 67 |
| BIOS Flash PRocedure | 68 |
| 2-/4-/6-Channel Audio Function Introduction | 88 |
| | |
| Chapter 5 Appendix | 95 |

Item Checklist

- | | |
|---|--|
| <input checked="" type="checkbox"/> The GA-8PE667 Ultra2 /Pro motherboard | <input checked="" type="checkbox"/> IDE cable x1 / Floppy cable x 1 * |
| <input checked="" type="checkbox"/> CD for motherboard driver & utility | <input checked="" type="checkbox"/> IDE cable x3 / Floppy cable x 1 ** |
| <input checked="" type="checkbox"/> GA-8PE667 Ultra2 /Pro user's manual | <input checked="" type="checkbox"/> 4 Port USB Cable x 1 |
| <input checked="" type="checkbox"/> Quick PC Installation Guide | <input checked="" type="checkbox"/> SATA cable x2 ** |
| <input checked="" type="checkbox"/> RAID Manual ** | <input checked="" type="checkbox"/> Audio combo kit x1 ** |
| <input checked="" type="checkbox"/> SATA RAID Manual ** | <input checked="" type="checkbox"/> SPDIF Kit x1(SPD-KIT) * |
| <input checked="" type="checkbox"/> Motherboard Settings Label | <input checked="" type="checkbox"/> I/O Shield |
| <input type="checkbox"/> GC-SATA Card (Optional) ** | |
- (Manual ; SATA cable x1 ; Power cable x 1)



CAUTION

Computer motherboards and expansion cards contain very delicate Integrated Circuit (IC) chips. To protect them against damage from static electricity, you should follow some precautions whenever you work on your computer.

1. Unplug your computer when working on the inside.
2. Use a grounded wrist strap before handling computer components. If you do not have one, touch both of your hands to a safely grounded object or to a metal object, such as the power supply case.
3. Hold components by the edges and try not touch the IC chips, leads or connectors, or other components.
4. Place components on a grounded antistatic pad or on the bag that came with the components whenever the components are separated from the system.
5. Ensure that the ATX power supply is switched off before you plug in or remove the ATX power connector on the motherboard.

Installing the motherboard to the chassis...

If the motherboard has mounting holes, but they don't line up with the holes on the base and there are no slots to attach the spacers, do not become alarmed you can still attach the spacers to the mounting holes. Just cut the bottom portion of the spacers (the spacer may be a little hard to cut off, so be careful of your hands). In this way you can still attach the motherboard to the base without worrying about short circuits. Sometimes you may need to use the plastic springs to isolate the screw from the motherboard PCB surface, because the circuit wire may be near by the hole. Be careful, don't let the screw contact any printed circuit write or parts on the PCB that are near the fixing hole, otherwise it may damage the board or cause board malfunctioning.

* For GA-8PE667 Pro Only ** For GA-8PE667 Ultra2 Only

Chapter 1 Introduction

Features Summary

| | |
|----------------------|---|
| Form Factor | <ul style="list-style-type: none"> • 30.5cm x 24.4cm ATX size form factor, 4 layers PCB. |
| Motherboard | <ul style="list-style-type: none"> • GA-8PE667 Series Motherboard: GA-8PE667 Ultra2 and GA-8PE667 Pro |
| CPU | <ul style="list-style-type: none"> • Socket 478 for Intel® Micro FC-PGA2 Pentium® 4 processor • Intel Pentium®4 533MHz/400MHz FSB • Support Intel® Pentium® 4 (Northwood, 0.13µm) processor • Support Intel® Pentium® 4 Processor with HT Technology • 2nd cache depend on CPU |
| Chipset | <ul style="list-style-type: none"> • Chipset 845PE HOST/AGP/Controller • ICH4 I/O Controller Hub |
| Memory | <ul style="list-style-type: none"> • 3 184-pin DDR DIMM sockets • Supports DDR333/DDR266 DDR DIMM • Supports up to 2GB DRAM (Max) • Supports only 2.5V DDR DIMM |
| I/O Control | <ul style="list-style-type: none"> • ITE8712 |
| Slots | <ul style="list-style-type: none"> • 1 CNR(Communication and Networking Riser) Slot ** • 1 AGP slot 4X (1.5V only) device support • 6 PCI slot supports 33MHz & PCI 2.2 compliant |
| On-Board IDE | <ul style="list-style-type: none"> • 2 IDE controllers on the Intel ICH4 PCI chipset provides IDE HDD/CD-ROM (IDE1, IDE2) with PIO, Bus Master (Ultra DMA33/ATA66/ATA100) operation modes. • IDE3 and IDE4 Compatible with RAID,Ultra ATA133/100.** |
| On-Board Peripherals | <ul style="list-style-type: none"> • 1 Floppy port supports 2 FDD with 360K, 720K,1.2M, 1.44M and 2.88M bytes. • 1 Parallel port supports Normal/EPP/ECP mode • 2 Serial ports (COMA & COMB) • 6 USB 2.0/1.1 (2 port rear,4 ports by cable) • 1 IrDA connector for IR/CIR • 1 Front Audio connector |

* For GA-8PE667 Pro Only ** For GA-8PE667 Ultra2 Only

to be continued.....

- Due to (Intel 845PE/GE/GV) chipset architecture limitation, DDR 333 memory module is only supported when using FSB 533 Pentium 4 processor. A FSB 400 Pentium 4 processor will only support DDR 266 memory module

| | |
|-----------------------|---|
| Hardware Monitor | <ul style="list-style-type: none"> • CPU/Power/System Fan Revolution detect • CPU/Power/System Fan Control • CPU Overheat Warning • System Voltage Detect |
| On-Board Sound | <ul style="list-style-type: none"> • Realtek ALC650 CODEC • Line Out / 2 front speaker • Line In / 2 rear speaker(by s/w switch) • Mic In / center& subwoofer(by s/w switch) • SPDIF out / SPDIF In • CD In / AUX In / Game port |
| On-Board RAID ** | <ul style="list-style-type: none"> • Onboard Promise PDC20276 • Supports data striping (RAID 0) or mirroring (RAID 1) • Supports concurrent dual ATA133 IDE controller operation • Support ATAPI mode for CD ROM, DVD ROM ..etc. • Supports IDE bus master operation • Support ATA133/RAID mode switch by BIOS • Mirroring supports automatic background rebuilds • Features LBA and Extended Interrupt 13 drive translation in controller onboard BIOS |
| On-Board SATA RAID ** | <ul style="list-style-type: none"> • Onboard Silicon Image SiI3112A • Supports Disk striping (RAID0) or DISK Mirroring (RAID1) • Supports UDMA up to 150 MB/sec • AIL UDMA and PIO Modes • Up to 2 SATA Device • ACPI and ATA/ATAPI6 |
| On-Board LAN | <ul style="list-style-type: none"> • Intel Kenai-32 LAN PHY ** Data transfer rate 10/100/1000 supported • Intel Kinnereth-R LAN PHY * Data transfer rate 10/100 supported |
| On-Board SCR | <ul style="list-style-type: none"> • IT8712 I/O Chipset (Smart Card Reader) |
| On-Board USB 2.0 | <ul style="list-style-type: none"> • Built in ICH4 Chipset |

to be continued.....

* For GA-8PE667 Pro Only ** For GA-8PE667 Ultra2 Only

| | |
|---------------------|---|
| PS/2 Connector | <ul style="list-style-type: none"> • PS/2 Keyboard interface and PS/2 Mouse interface |
| BIOS | <ul style="list-style-type: none"> • Licensed AWARD BIOS, 4M bit x 2 FWH ** • Licensed AWARD BIOS, 3M bit x 2 FWH * • Supports Dual BIOS • Supports Multi Language • Supports Face Wizard • Supports Q-Flash |
| Additional Features | <ul style="list-style-type: none"> • PS/2 Keyboard power on by password • PS/2 Mouse power on • External Modem wake up • STR(Suspend-To-RAM) • Wake on LAN (WOL) • AC Recovery • Poly fuse for keyboard over-current protection • USB KB/Mouse wake up from S3 • Supports @BIOS • Supports EasyTune 4 • Supports clear password function |
| Overclocking | <ul style="list-style-type: none"> • Over Voltage (DDR/AGP/CPU) by BIOS • Over Clock (DDR/AGP/CPU/PCI) by BIOS |

* For GA-8PE667 Pro Only ** For GA-8PE667 Ultra2 Only



***** HT functionality requirement content :**

Enabling the functionality of Hyper-Threading Technology for your computer system requires all of the following platform components:

- CPU: An Intel® Pentium 4 Processor with HT Technology
- Chipset: An Intel® Chipset that supports HT Technology
- BIOS: A BIOS that supports HT Technology and has it enabled
- OS: An operation system that has optimizations for HT Technology



Please set the CPU host frequency in accordance with your processor's specifications. We don't recommend you to set the system bus frequency over the CPU's specification because these specific bus frequencies are not the standard specifications for CPU, chipset and most of the peripherals. Whether your system can run under these specific bus frequencies properly will depend on your hardware configurations, including CPU, Chipsets, SDRAM, Cards....etc.

GA-8PE667 Ultra2 / Pro Motherboard Layout

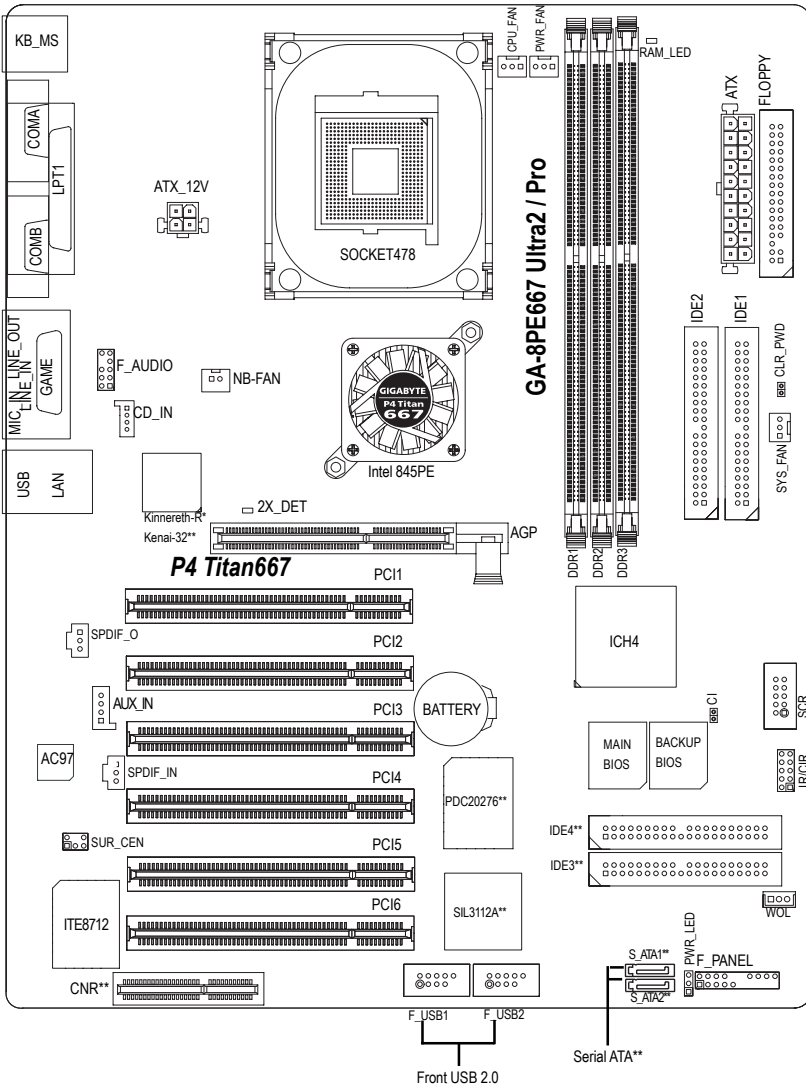

* For GA-8PE667 Pro Only ** For GA-8PE667 Ultra2 Only

Block Diagram

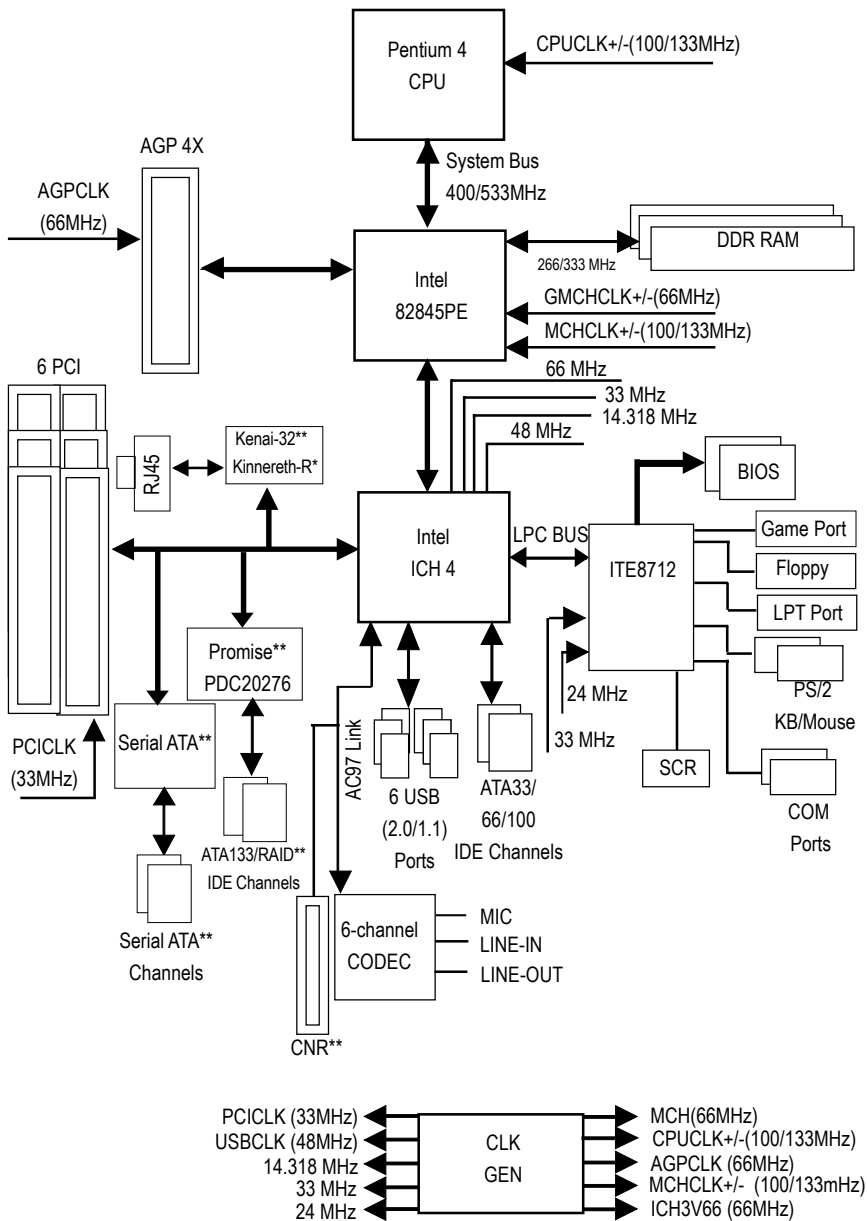

* For GA-8PE667 Pro Only ** For GA-8PE667 Ultra2 Only

Chapter 2 Hardware Installation Process

To set up your computer, you must complete the following steps:

- Step 1- Install the Central Processing Unit (CPU)
- Step 2- Install memory modules
- Step 3- Install expansion cards
- Step 4- Connect ribbon cables, cabinet wires, and power supply

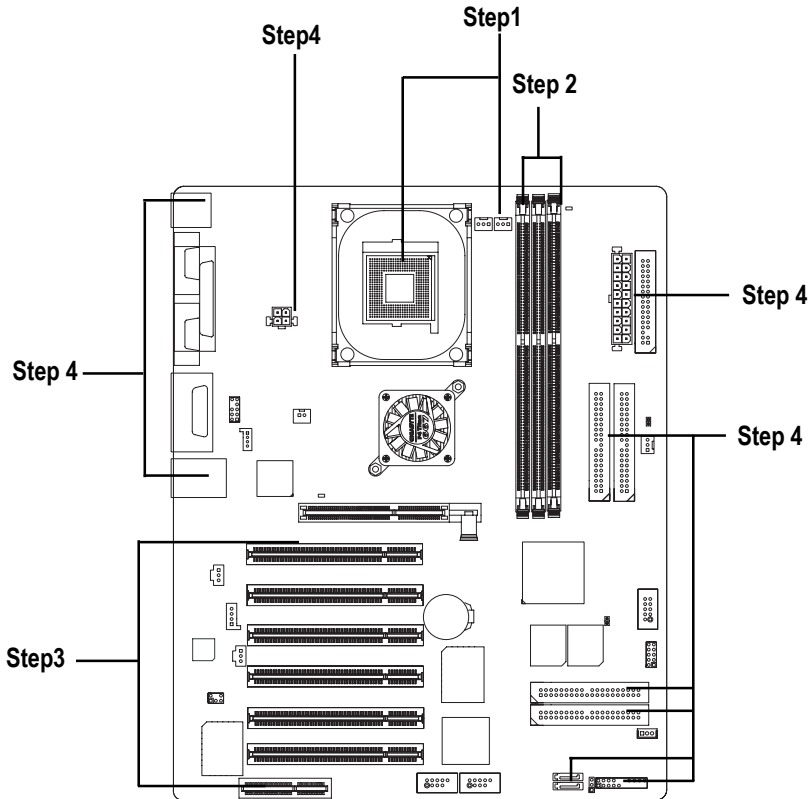

Congratulations you have accomplished the hardware installation!
Turn on the power supply or connect the power cable to the power outlet. Continue with the BIOS/software installation.

Step 1: Install the Central Processing Unit (CPU)

Before installing the processor , adhere to the following warning:



If you do not match the CPU socket Pin 1 and CPU cut edge well, it will cause improper installation. Please change the insert orientation.

Please make sure the CPU type is supported by the motherboard.

Step 1-1: CPU Installation

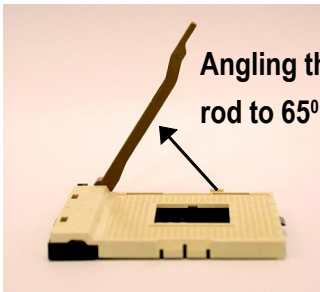

1. Angling the rod to 65-degree maybe feel a kind of tight , and then continue pull the rod to 90-degree when a noise “cough” made.

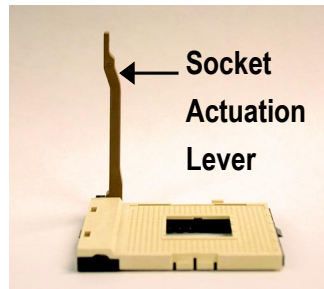

2. Pull the rod to the 90-degree directly.



3. CPU Top View

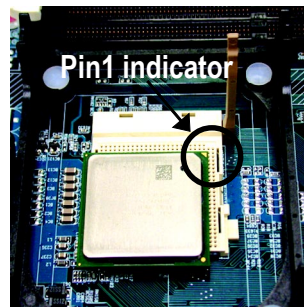

4. Locate Pin 1 in the socket and look for a (golden) cut edge on the CPU upper corner. Then insert the CPU into the socket.

Step 1-2 : CPU Heat Sink Installation



Before installing the CPU Heat Sink , adhere to the following warning:

1. Please use Intel approved cooling fan.
2. We recommend you to apply the thermal tape to provide better heat conduction between your CPU and heatsink.

(The CPU cooling fan might stick to the CPU due to the hardening of the thermal paste. During this condition if you try to remove the cooling fan, you might pull the processor out of the CPU socket along with the cooling fan, and might damage the processor. To avoid this from happening, we suggest you to either use thermal tape instead of thermal paste, or remove the cooling fan with extreme caution.)

3. Make sure the CPU fan power cable is plugged in to the CPU fan connector, this completes the installation.

Please refer to CPU heat sink user's manual for more detail installation procedure.

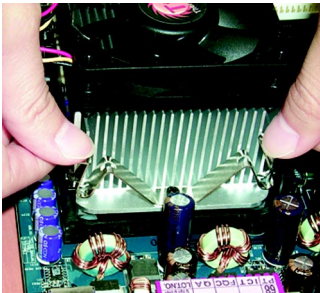

1. Fasten the heatsink supporting-base onto the CPU socket on the motherboard.

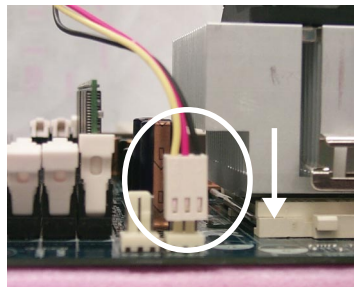

2. Make sure the CPU fan is plugged to the CPU fan connector, than install complete.

Step 2: Install memory modules



Before installing the processor and heatsink, adhere to the following warning:

When DIMM LED is ON, do not install/remove DIMM from socket.

Please note that the DIMM module can only fit in one direction due to the one notches.

Wrong orientation will cause improper installation. Please change the insert orientation.

The motherboard has 3 dual inline memory module (DIMM) sockets, but it can only support a maximum of 4 banks of DDR memory. DDR sockets 1 uses 2 banks, DDR sockets 2&3 share the remaining 2 banks. Please refer to the following tables for possible memory configurations supported. The BIOS will automatically detects memory type and size. To install the memory module, just push it vertically into the DIMM socket. The DIMM module can only fit in one direction due to the notch. Memory size can vary between sockets.

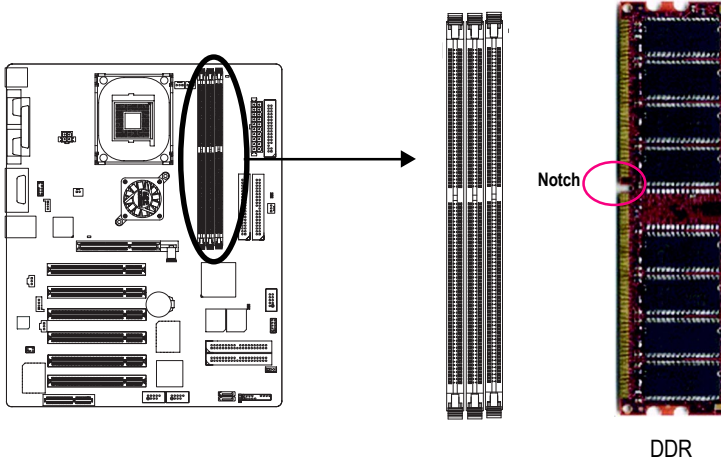

Support Unbuffered DDR DIMM Sizes type:

| | | |
|------------------------------|-------------------------|-------------------------|
| 64 Mbit (2Mx8x4 banks) | 64 Mbit (1Mx16x4 banks) | 128 Mbit(4Mx8x4 banks) |
| 128 Mbit(2Mx16x4 banks) | 256 Mbit(8Mx8x4 banks) | 256 Mbit(4Mx16x4 banks) |
| 512 Mbit(16Mx8x4 banks) | 512 Mbit(8Mx16x4 banks) | |
| Total System Memory (Max2GB) | | |

| DDR1 | DDR2 | DDR3 |
|------|------|------|
| S | S | S |
| D | S | S |
| D | D | X |
| D | X | D |
| S | D | X |
| S | X | D |

D:Double Sided DIMM S:Single Sided DIMM

X:Not Use

1. The DIMM slot has a notch, so the DIMM memory module can only fit in one direction.

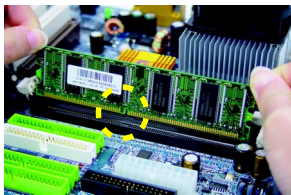

2. Insert the DIMM memory module vertically into the DIMM slot. Then push it down.

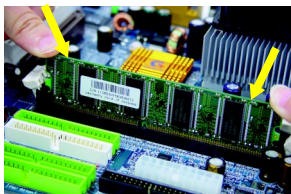

3. Close the plastic clip at both edges of the DIMM slots to lock the DIMM module. Reverse the installation steps when you wish to remove the DIMM module.



DDR Introduction

Established on the existing SDRAM industry infrastructure, DDR (Double Data Rate) memory is a high performance and cost-effective solution that allows easy adoption for memory vendors, OEMs and system integrators.

DDR memory is a sensible evolutionary solution for the PC industry that builds on the existing SDRAM infrastructure, yet makes awesome advances in solving the system performance bottleneck by doubling the memory bandwidth. DDR SDRAM will offer a superior solution and migration path from existing SDRAM designs due to its availability, pricing and overall market support. PC2100 DDR memory (DDR266) doubles the data rate through reading and writing at both the rising and falling edge of the clock, achieving data bandwidth 2X greater than PC133 when running with the same DRAM clock frequency. With peak bandwidth of 2.664GB per second, DDR memory enables system OEMs to build high performance and low latency DRAM subsystems that are suitable for servers, workstations, high-end PC's and value desktop SMA systems. With a core voltage of only 2.5 Volts compared to conventional SDRAM's 3.3 volts, DDR memory is a compelling solution for small form factor desktops and notebook applications.

Step 3: Install expansion cards

1. Read the related expansion card's instruction document before install the expansion card into the computer.
2. Remove your computer's chassis cover, necessary screws and slot bracket from the computer.
3. Press the expansion card firmly into expansion slot in motherboard.
4. Be sure the metal contacts on the card are indeed seated in the slot.
5. Replace the screw to secure the slot bracket of the expansion card.
6. Replace your computer's chassis cover.
7. Power on the computer, if necessary, setup BIOS utility of expansion card from BIOS.
8. Install related driver from the operating system.

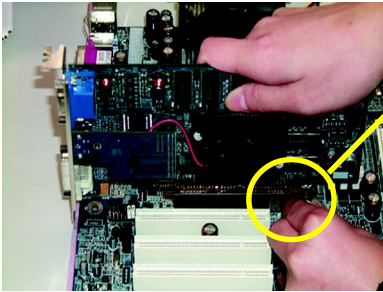

AGP Card

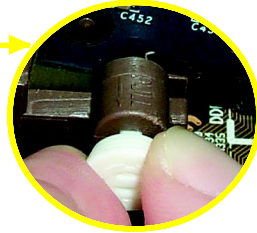

Please carefully pull out the small white- drawable bar at the end of the AGP slot when you try to install/ Uninstall the AGP card. Please align the AGP card to the onboard AGP slot and press firmly down on the slot .Make sure your AGP card is locked by the small white-drawable bar.



When an AGP 2x (3.3V) card is installed the 2X_DET will light up, indicating a non-supported graphics card is inserted. Informing users that system might not boot up normally due to AGP 2x (3.3V) is not supported by the chipset.

Issues To Beware Of When Installing CNR **

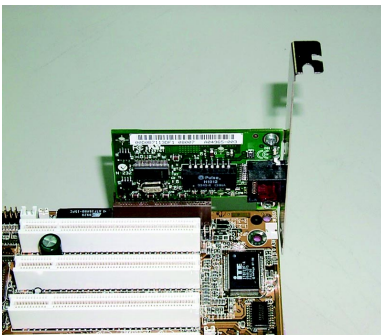

Standard CNR Card

Please use standard CNR card like the one in order to avoid mechanical problem.

** For GA-8PE667 Ultra2 Only

Step 4: Connect ribbon cables, cabinet wires, and power supply

Step 4-1 : I/O Back Panel Introduction

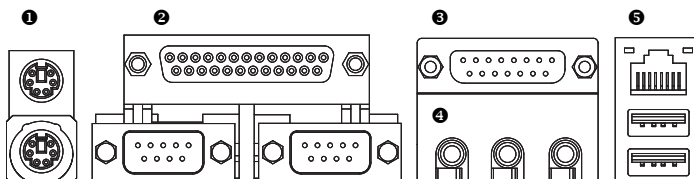

❶ PS/2 Keyboard and PS/2 Mouse Connector



PS/2 Mouse Connector

(6 pin Female)

PS/2 Keyboard Connector

(6 pin Female)

➤ This connector supports standard PS/2 keyboard and PS/2 mouse.

❷ Parallel Port and Serial Ports (COMA/COMB)

Parallel Port

(25 pin Female)

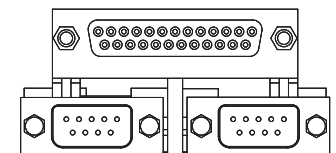

COMA

COMB

Serial Ports (9 pin Male)

➤ This connector supports 2 standard COM ports and 1 Parallel port. Device like printer can be connected to Parallel port ; mouse and modem etc can be connected to Serial ports.

4 Game /MIDI Ports

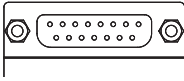

Joystick/ MIDI (15 pin Female)

- This connector supports joystick, MIDI keyboard and other relate audio devices.

5 Audio Connectors

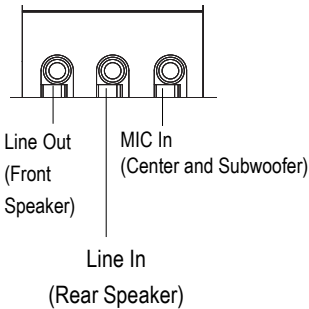

- After install onboard audio driver, you may connect speaker to Line Out jack, micro phone to MIC In jack. Device like CD-ROM , walkman etc can be connected to Line-In jack.

Please note:

You are able to use 2-/4-/6- channel audio feature by S/W selection.

If you want to enable 6-channel function, you have 2 choose for hardware connection.

Method1:

Connect "Front Speaker" to "Line Out"

Connect "Rear Speaker" to "Line In"

Connect "Center and Subwooferr" to "MIC Out ".

Method2:

You can refer to page 31, and contact your nearest dealer for optional SUR_CEN cable.



If you want the detail information for 2-/4-/6-channel audio setup installation, please refer to "2-/4-/6-Channel Audio Function Introduction".

6 USB/ LAN Connector

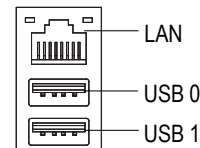

- Before you connect your device(s) into USB connector(s), please make sure your device(s) such as USB keyboard, mouse, scanner, zip, speaker..etc. Have a standard USB interface. Also make sure your OS supports USB controller. If your OS does not support USB controller, please contact OS vendor for possible patch or driver upgrade. For more information please contact your OS or device(s) vendors.

Step 4-2 :Connectors & Jumper Setting Introduction

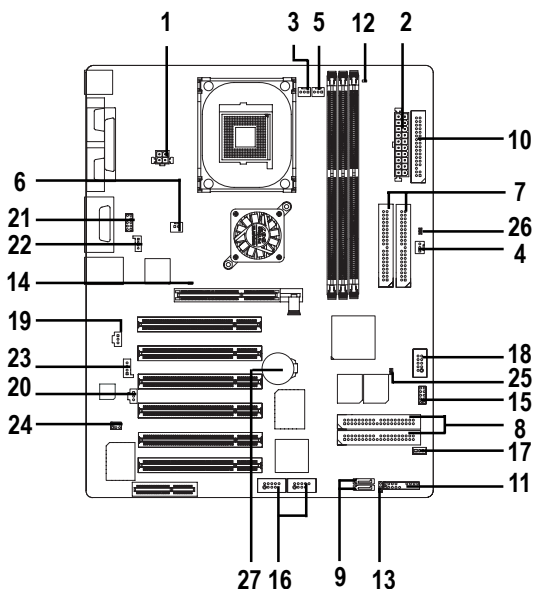

| | |
|---------------------|-------------------|
| 1) ATX_12V | 15) IR/CIR |
| 2) ATX Power | 16) F_USB1/F_USB2 |
| 3) CPU_FAN | 17) WOL |
| 4) SYS_FAN | 18) SCR |
| 5) PWR_FAN | 19) SPDIF_O |
| 6) NB_FAN | 20) SPDIF_IN |
| 7) IDE1/IDE2 | 21) F_AUDIO |
| 8) IDE3/IDE4 ** | 22) CD_IN |
| 9) S_ATA1/S_ATA2 ** | 23) AUX_IN |
| 10) FDD | 24) SUR_CEN |
| 11) F_PANEL | 25) CI |
| 12) RAM_LED | 26) CLR_PWD |
| 13) PWR_LED | 27) BATTERY |
| 14) 2X_DET | |

* For GA-8PE667 Pro Only ** For GA-8PE667 Ultra2 Only

1) ATX_12V (+12V Power Connector)

This connector (ATX_12V) supplies the CPU operation voltage (Vcore). If this "ATX_12V connector" is not connected, system cannot boot.

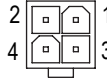
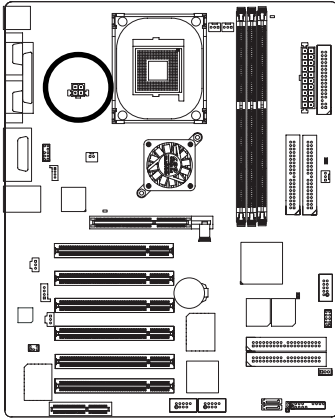

| Pin No. | Definition |
|---------|------------|
| 1 | GND |
| 2 | GND |
| 3 | +12V |
| 4 | +12V |

2) ATX_POWER (ATX Power)

AC power cord should only be connected to your power supply unit after ATX power cable and other related devices are firmly connected to the mainboard.

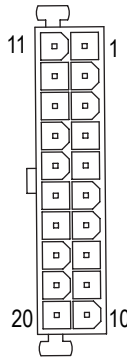
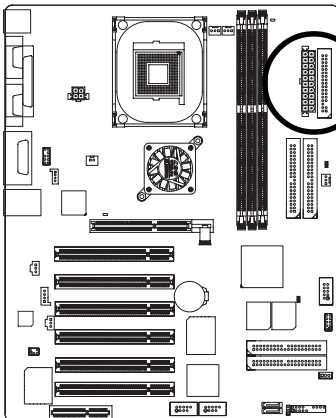

| Pin No. | Definition |
|---------|---------------------|
| 1 | 3.3V |
| 2 | 3.3V |
| 3 | GND |
| 4 | VCC |
| 5 | GND |
| 6 | VCC |
| 7 | GND |
| 8 | Power Good |
| 9 | 5V SB(stand by +5V) |
| 10 | +12V |
| 11 | 3.3V |
| 12 | -12V |
| 13 | GND |
| 14 | PS_ON(softOn/Off) |
| 15 | GND |
| 16 | GND |
| 17 | GND |
| 18 | -5V |
| 19 | VCC |
| 20 | VCC |

3) CPU_FAN (CPU FAN Connector)

Please note, a proper installation of the CPU cooler is essential to prevent the CPU from running under abnormal condition or damaged by overheating. The CPU fan connector supports Max. current up to 600 mA.

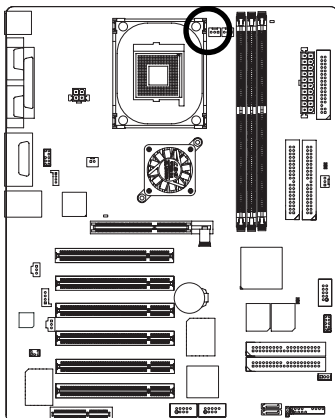

| Pin No. | Definition |
|---------|------------|
| 1 | GND |
| 2 | +12V |
| 3 | Sense |

4) SYS_FAN (System FAN Connector)

This connector allows you to link with the cooling fan on the system case to lower the system temperature.

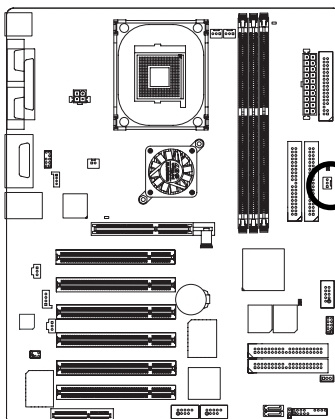

| Pin No. | Definition |
|---------|------------|
| 1 | GND |
| 2 | +12V |
| 3 | Sense |

5) PWR_FAN (Power Fan Connector)

This connector allows you to link with the cooling fan on the system case to lower the system temperature.

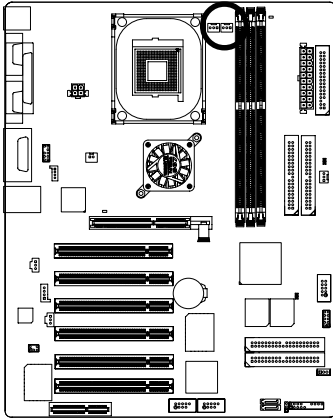

| Pin No. | Definition |
|---------|------------|
| 1 | GND |
| 2 | +12V |
| 3 | Sense |

6) NB_FAN

If you installed wrong direction, the Chip Fan will not work. Sometimes will damage the Chip Fan. (Usually black cable is GND)

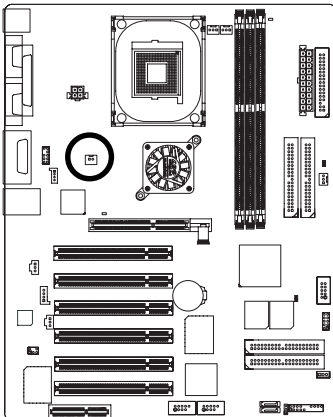

| Pin No. | Definition |
|---------|------------|
| 1 | VCC |
| 2 | GND |

7) IDE1/ IDE2(IDE1/IDE2 Connector)

Please connect first harddisk to IDE1 and connect CDROM to IDE2. The red stripe of the ribbon cable must be the same side with the Pin1.

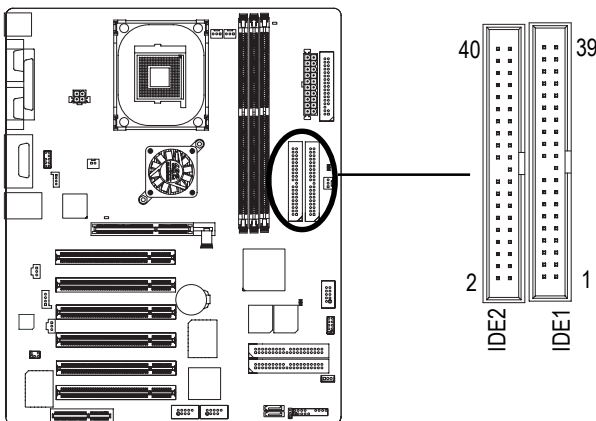

8) IDE3 /IDE4 (RAID/ATA133,Green Connector)**

The red stripe of the ribbon cable must be the same side with the Pin1.

If you wish to use IDE3 and IDE4, please use it in unity with BIOS (either RAID or ATA133).

Then, install the correct driver to have proper operation. For details, please refer to the RAID manual.

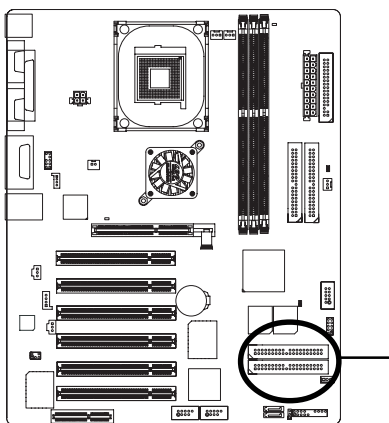

(BIOS Default Value :ATA, If you want to use RAID function, please change "Integrated Peripherals-RAID Controller Function" to "RAID")

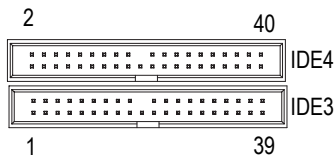

* For GA-8PE667 Pro Only ** For GA-8PE667 Ultra2 Only

9) S_ATA1/S_ATA2 (Serial ATA Connector)**

You can connect the Serial ATA device to this connector, it provides you high speed transfer rates (150MB/sec).

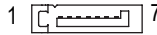
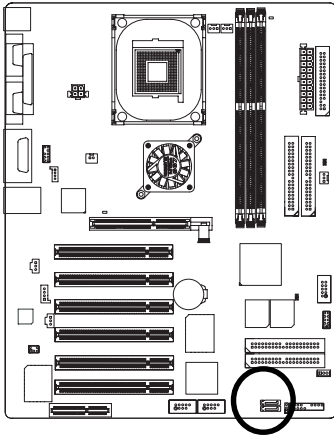

| Pin No. | Definition |
|---------|------------|
| 1 | GND |
| 2 | TXP |
| 3 | TXN |
| 4 | GND |
| 5 | RXN |
| 6 | RXP |
| 7 | GND |

10) FDD (Floppy Connector)

Please connect the floppy drive ribbon cables to FDD. It supports 360K,720K,1.2M,1.44M and 2.88Mbytes floppy disk types. The red stripe of the ribbon cable must be the same side with the Pin1.

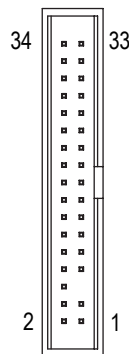
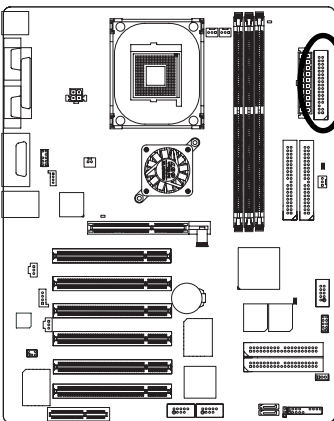

* For GA-8PE667 Pro Only ** For GA-8PE667 Ultra2 Only

11) F_PANEL (2x10 pins connector)

Please connect the power LED, PC peaker, reset switch and power switch etc of your chassis front panel to the F_PANEL connector according to the pin assignment above.

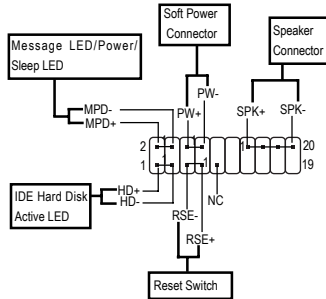
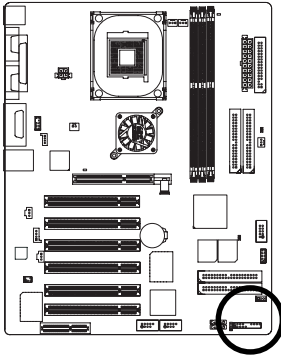

| | |
|--|--|
| HD (IDE Hard Disk Active LED) (Blue) | Pin 1: LED anode(+) Pin 2: LED cathode(-) |
| SPK (Speaker Connector) (Amber) | Pin 1: VCC(+) Pin 2- Pin 3: NC Pin 4: Data(-) |
| RES (Reset Switch) (Green) | Open: Normal Operation Close: Reset Hardware System |
| PW (Soft Power Connector) (Red) | Open: Normal Operation Close: Power On/Off |
| MSG(Message LED/Power/ Sleep LED)(Yellow) | Pin 1: LED anode(+) Pin 2: LED cathode(-) |
| NC(Purple) | NC |

12) RAM_LED

Do not remove memory modules while DIMM LED is on. It might cause short or other unexpected damages due to the 2.5V stand by voltage. Remove memory modules only when AC Power cord is disconnected.

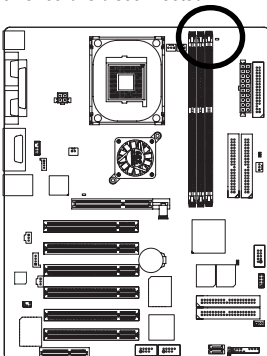

13)PWR_LED

PWR_LED is connect with the system power indicator to indicate whether the system is on/off. It will blink when the system enters suspend mode. If you use dual color LED, power LED will turn to another color.

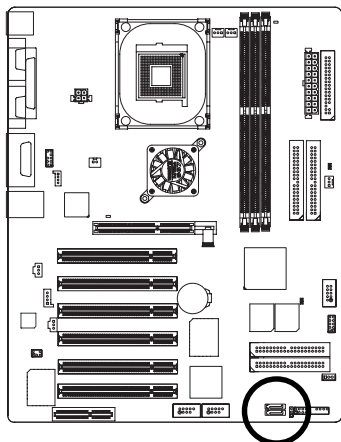

| Pin No. | Definition |
|---------|------------|
| 1 | MPD+ |
| 2 | MPD- |
| 3 | MPD- |

8)2X_DET

When an AGP 2X (3.3V) card is installed the 2X_DET will light up, indicating a nonsupported graphics card is inserted. Informing users that system might not boot up normally due to AGP 2X (3.3V) is not supported by the chipset.

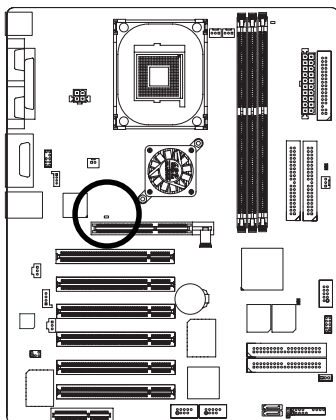

15) IR_CIR

Make sure the pin 1 on the IR device is along with pin one the connector. To enable the IR/CIR function on the board, you are required to purchase an option IR/CIR module. For detail information please contact your authorized Giga-Byte distributor.

To use IR function only, please connect IR module to Pin1 to Pin5.

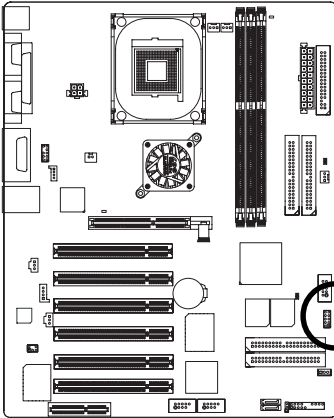

| Pin No. | Definition |
|---------|------------|
| 1 | VCC |
| 2 | NC |
| 3 | IRRX |
| 4 | GND |
| 5 | IRTX |
| 6 | NC |
| 7 | CIRRX |
| 8 | VCC |
| 9 | CIRTX |
| 10 | NC |

16) F_USB1 / F_USB2(Front USB Connector, Yellow)

Be careful with the polarity of the front USB connector. Check the pin assignment while you connect the front USB cable. Please contact your nearest dealer for optional front USB cable.

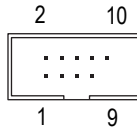
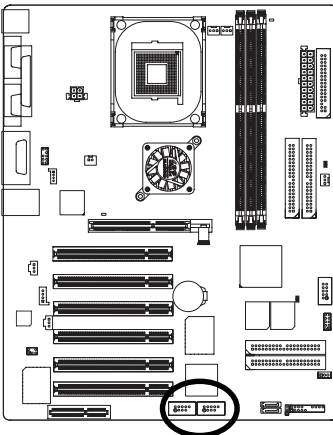

| Pin No. | Definition |
|---------|------------------|
| 1 | Power |
| 2 | Power |
| 3 | USB DX- |
| 4 | USB Dy- |
| 5 | USB DX+ |
| 6 | USB Dy+ |
| 7 | GND |
| 8 | GND |
| 9 | No Pin |
| 10 | USB Over Current |

17) WOL (Wake On Lan)

This connector allows the remote servers to manage the system that installed this mainboard via your network adapter which also supports WOL.

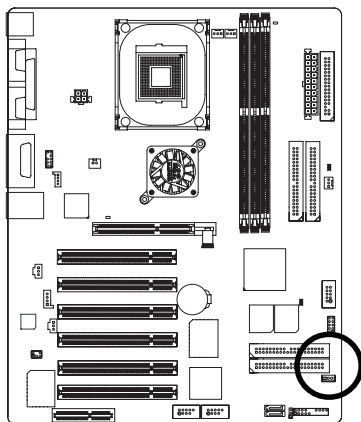

| Pin No. | Definition |
|---------|------------|
| 1 | +5V SB |
| 2 | GND |
| 3 | Signal |

18) SCR (Smart Card Reader Header, Black Connector)

This MB supports smart card reader. To enable smart card reader function an optional smart card reader box is required. Please contact your authorized distributor.

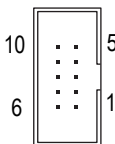
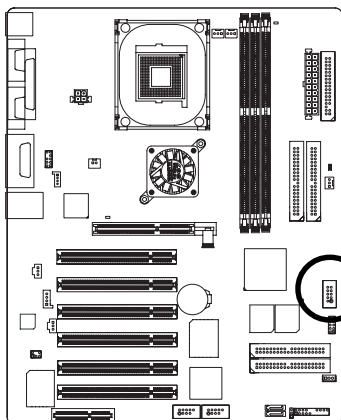

| Pin No. | Definition |
|---------|------------|
| 1 | VCC |
| 2 | SCAPWCTL- |
| 3 | SCAC4 |
| 4 | SCAIO |
| 5 | SCACLK |
| 6 | GND |
| 7 | SCARST- |
| 8 | SCALED |
| 9 | SCAC8 |
| 10 | SCAPSNT |

19) SPDIF_O (SPDIFOut)

The SPDIF output is capable of providing digital audio to external speakers or compressed AC3 data to an external Dolby Digital Decoder. Use this feature only when your stereo system has digital input function.

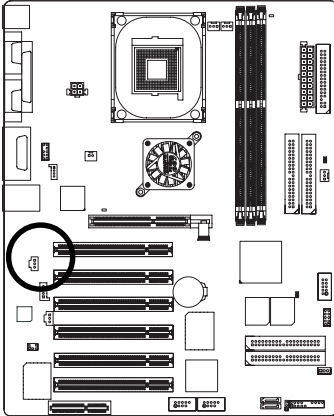

| Pin No. | Definition |
|---------|------------|
| 1 | VCC |
| 2 | SPDIF OUT |
| 3 | GND |

20) SPDIF_IN

Use this feature only when your device has digital output function.

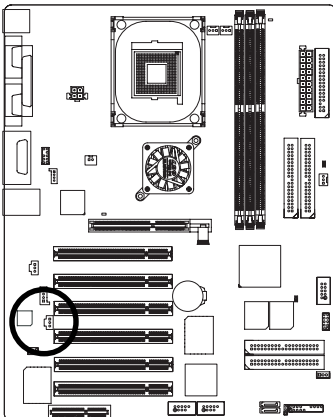

| Pin No. | Definition |
|---------|------------|
| 1 | VCC |
| 2 | SPDIF IN |
| 3 | GND |

21) F_AUDIO (F_AUDIO Connector)

If you want to use Front Audio connector, you must remove 5-6, 9-10 Jumper. In order to utilize the front audio header, your chassis must have front audio connector. Also please make sure the pin assignment on the cable is the same as the pin assignment on the MB header. To find out if the chassis you are buying support front audio connector, please contact your dealer.

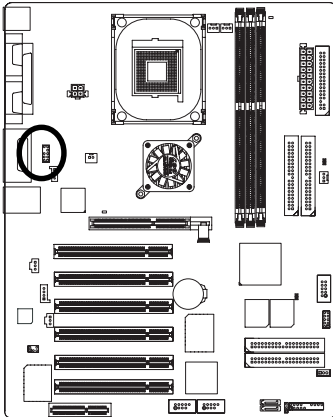

| Pin No. | Definition |
|---------|---------------|
| 1 | MIC |
| 2 | GND |
| 3 | REF |
| 4 | POWER |
| 5 | FrontAudio(R) |
| 6 | RearAudio(R) |
| 7 | Reserved |
| 8 | No Pin |
| 9 | FrontAudio(L) |
| 10 | RearAudio(L) |

22) CD_IN (CD IN,Blank)

Connect CD-ROM or DVD-ROM audio out to the connector.

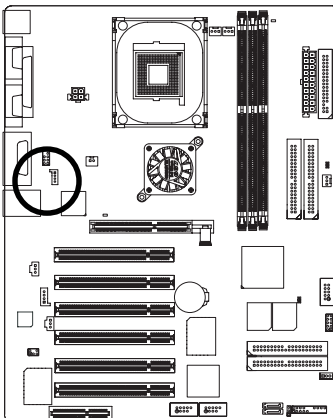

| Pin No. | Definition |
|---------|------------|
| 1 | CD-L |
| 2 | GND |
| 3 | GND |
| 4 | CD_R |

23) AUX_IN (AUX In Connector)

Connect other device(such as PCI TV Tunner audio out)to the connector.

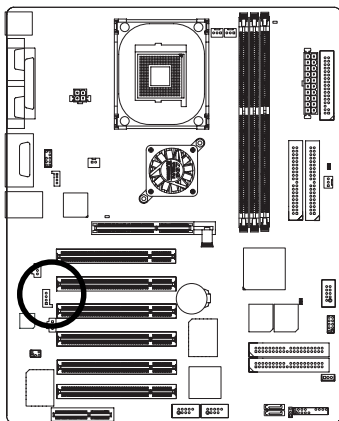

| Pin No. | Definition |
|---------|------------|
| 1 | AUX-L |
| 2 | GND |
| 3 | GND |
| 4 | AUX_R |

24) SUR_CEN

Please contact your nearest dealer for optional SUR_CEN cable.

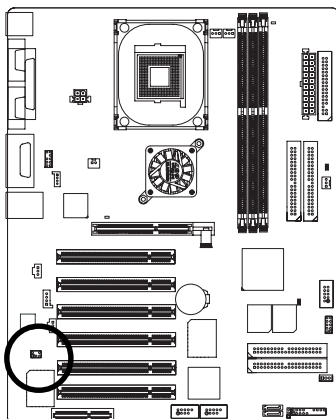

| Pin No. | Definition |
|---------|------------|
| 1 | SUR OUTL |
| 2 | SUR OUTR |
| 3 | GND |
| 4 | No Pin |
| 5 | CENTER_OUT |
| 6 | BASS_OUT |

25) CI (CASE OPEN)

This 2 pin connector allows your system to enable or disable the "case open" item in BIOS if the system case begin remove.

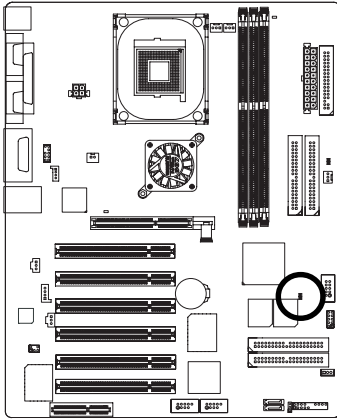

1

| Pin No. | Definition |
|---------|------------|
| 1 | Signal |
| 2 | GND |

26) CLR_PWD

When Jumper set to "open", the password that set will be cleared. On the contrary when Jumper set to "close", the current status remains.

● PS, the function offers a solution for users who forget the password.

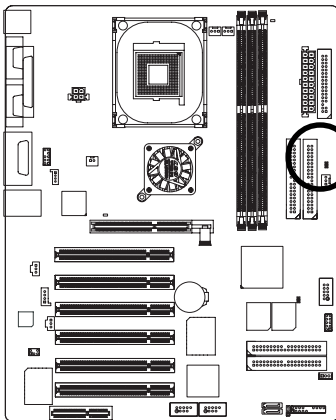

1 open: Clear password

1 close: Normal

27) BATTERY (Battery)

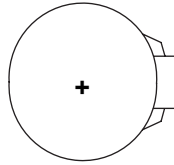
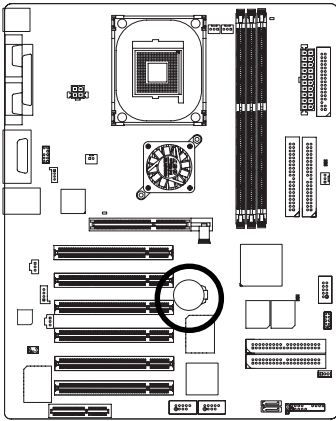

CAUTION

- ❖ Danger of explosion if battery is incorrectly replaced.
- ❖ Replace only with the same or equivalent type recommended by the manufacturer.
- ❖ Dispose of used batteries according to the manufacturer's instructions.

If you want to erase CMOS...

1. Turn OFF the computer and unplug the power cord.
2. Remove the battery, wait for 30 second.
3. Re-install the battery.
4. Plug the power cord and turn ON the computer.

Chapter 3 BIOS Setup

BIOS Setup is an overview of the BIOS Setup Program. The program that allows users to modify the basic system configuration. This type of information is stored in battery-backed CMOS RAM so that it retains the Setup information when the power is turned off.

ENTERING SETUP

After power on the computer, pressing **** immediately during POST (Power On Self Test) it will allow you to enter standard BIOS CMOS SETUP.

If you require more advanced BIOS settings, please go to “advanced BIOS” setting menu. To enter Advanced BIOS setting menu, press “Ctrl+F1” key on the BIOS screen.

CONTROL KEYS

| | |
|----------|---|
| <↑> | Move to previous item |
| <↓> | Move to next item |
| <←> | Move to the item in the left hand |
| <→> | Move to the item in the right hand |
| <Esc> | Main Menu - Quit and not save changes into CMOS Status Page Setup Menu and Option Page Setup Menu - Exit current page and return to Main Menu |
| <+/PgUp> | Increase the numeric value or make changes |
| <-/PgDn> | Decrease the numeric value or make changes |
| <F1> | General help, only for Status Page Setup Menu and Option Page Setup Menu |
| <F2> | Item help |
| <F3> | Reserved |
| <F4> | Reserved |
| <F5> | Restore the previous CMOS value from CMOS, only for Option Page Setup Menu |
| <F6> | Load the default CMOS value from BIOS default table, only for Option Page Setup Menu |
| <F7> | Load the Setup Defaults |
| <F8> | Dual BIOS/Q-Flash |
| <F9> | Reserved |
| <F10> | Save all the CMOS changes, only for Main Menu |

GETTING HELP

Main Menu

The on-line description of the highlighted setup function is displayed at the bottom of the screen.

Status Page Setup Menu / Option Page Setup Menu

Press F1 to pop up a small help window that describes the appropriate keys to use and the possible selections for the highlighted item. To exit the Help Window press <Esc>.

The Main Menu (For example: BIOS Ver. : F1)

Once you enter Award BIOS CMOS Setup Utility, the Main Menu (Figure 1) will appear on the screen. The Main Menu allows you to select from eight setup functions and two exit choices. Use arrow keys to select among the items and press <Enter> to accept or enter the sub-menu.

CMOS Setup Utility-Copyright (C) 1984-2002 Award Software

| | |
|-------------------------------|-------------------------|
| ▶Standard CMOS Features | Select Language |
| ▶Advanced BIOS Features | Load Fail-Safe Defaults |
| ▶Integrated Peripherals | Load Optimized Defaults |
| ▶Power Management Setup | Set Supervisor Password |
| ▶BnP/PCI Configurations | Set User Password |
| ▶PC Health Status | Save & Exit Setup |
| ▶Frequency/Voltage Control | Exit Without Saving |
| Top Performance | |
| ESC:Quit | F3:Change Language |
| F8:Dual BIOS /Q-Flash | F10:Save & Exit Setup |
| Time, Date, Hard Disk Type... | |

Figure 1: Main Menu



If you can't find the setting you want, please press "Ctrl+F1" to search the advanced option widden.

- **Standard CMOS Features**
This setup page includes all the items in standard compatible BIOS.
- **Advanced BIOS Features**
This setup page includes all the items of Award special enhanced features.
- **Integrated Peripherals**
This setup page includes all onboard peripherals.

- **Power Management Setup**
This setup page includes all the items of Green function features.
- **PnP/PCI Configurations**
This setup page includes all the configurations of PCI & PnP ISA resources.
- **PC Health Status**
This setup page is the System auto detect Temperature, voltage, fan, speed.
- **Frequency/Voltage Control**
This setup page is control CPU's clock and frequency ratio.
- **Top Performance**
Top Performance Defaults indicates the value of the system parameters which the system would be in best performance configuration.
- **Select Language**
This setup page is select multi language.
- **Load Fail-Safe Defaults**
Fail-Safe Defaults indicates the value of the system parameters which the system would be in safe configuration.
- **Load Optimized Defaults**
Optimized Defaults indicates the value of the system parameters which the system would be in better performance configuration.
- **Set Supervisor password**
Change, set, or disable password. It allows you to limit access to the system and Setup, or just to Setup.
- **Set User password**
Change, set, or disable password. It allows you to limit access to the system.
- **Save & Exit Setup**
Save CMOS value settings to CMOS and exit setup.
- **Exit Without Saving**
Abandon all CMOS value changes and exit setup.

Standard CMOS Features

CMOS Setup Utility-Copyright (C) 1984-2002 Award Software

Standard CMOS Features

| | | |
|---|---------------------|--|
| Date (mm:dd:yy) | Thu, Feb 21 2002 | Item Help |
| Time (hh:mm:ss) | 22:31:24 | Menu Level ► |
| ►IDE Primary Master | [Press Enter None] | Change the day, month, year |
| ►IDE Primary Slave | [Press Enter None] | <Week> |
| ►IDE Secondary Master | [Press Enter None] | Sun. to Sat. |
| ►IDE Secondary Slave | [Press Enter None] | <Month> |
| Drive A | [1.44M, 3.5"] | Jan. to Dec. |
| Drive B | [None] | <Day> |
| Floppy 3 Mode Support | [Disabled] | 1 to 31(or maximum allowed in the month.) |
| Halt On | [All, But Keyboard] | <year> |
| Base Memory | 640K | 1999 to 2098 |
| Extended Memory | 130048K | |
| Total Memory | 131072K | |
| ↑↓→←: Move Enter:Select +/-/PU/ED:Value F10:Save ESC:Exit F1:General Help F3:Language F5:Previous Values F6:Fail-Safe Defaults F7:Optimized Defaults | | |

Figure 2: Standard CMOS Features

Date

The date format is <week>, <month>, <day>, <year>.

- Week The week, from Sun to Sat, determined by the BIOS and is display only
- Month The month, Jan. Through Dec.
- Day The day, from 1 to 31 (or the maximum allowed in the month)
- Year The year, from 1999 through 2098

Time

The times format in <hour> <minute> <second>. The time is calculated base on the 24-hour military-time clock. For example, 1 p.m. is 13:00:00.

☛ IDE Primary Master, Slave / Secondary Master, Slave

The category identifies the types of hard disk from drive C to F that has been installed in the computer. There are two types: auto type, and manual type. Manual type is user-definable; Auto type which will automatically detect HDD type.

Note that the specifications of your drive must match with the drive table. The hard disk will not work properly if you enter improper information for this category.

If you select User Type, related information will be asked to enter to the following items. Enter the information directly from the keyboard and press <Enter>. Such information should be provided in the documentation from your hard disk vendor or the system manufacturer.

- ▶▶ Capacity: The hard disk size. The unit is Mega Bytes.
- ▶▶ Access Mode: The options are: Auto / Large / LBA / Normal.
- ▶▶ Cylinder: The cylinder number of hard disk.
- ▶▶ Head: The read / Write head number of hard disk.
- ▶▶ Precomp: The cylinder number at which the disk driver changes the write current.
- ▶▶ Landing Zone: The cylinder number that the disk driver heads(read/write) are seated when the disk drive is parked.
- ▶▶ SECTORS: The sector number of each track define on the hard disk.

If a hard disk has not been installed select NONE and press <Enter>.

☛ Drive A / Drive B

The category identifies the types of floppy disk drive A or drive B that has been installed in the computer.

- ▶▶ None: No floppy drive installed
- ▶▶ 360K, 5.25": 5.25 inch FC-type standard drive; 360K byte capacity.
- ▶▶ 1.2M, 5.25": 5.25 inch AT-type high-density drive; 1.2M byte capacity (3.5 inch when 3 Mode is Enabled).
- ▶▶ 720K, 3.5": 3.5 inch double-sided drive; 720K byte capacity
- ▶▶ 1.44M, 3.5": 3.5 inch double-sided drive; 1.44M byte capacity.
- ▶▶ 2.88M, 3.5": 3.5 inch double-sided drive; 2.88M byte capacity.

☛ Floppy 3 Mode Support (for Japan Area)

- ▶▶ Disabled: Normal Floppy Drive. (Default value)
- ▶▶ Drive A: Enabled 3 mode function of Drive A
- ▶▶ Drive B: Enabled 3 mode function of Drive B.
- ▶▶ Both: Drive A & B are 3 mode Floppy Drives.

☛ Halt on

The category determines whether the computer will stop if an error is detected during power up.

- ▶▶ NO Errors The system boot will not stop for any error that may be detected and you will be prompted.
- ▶▶ All Errors Whenever the BIOS detects a non-fatal error the system will be stopped.
- ▶▶ All, But Keyboard The system boot will not stop for a keyboard error; it will stop for all other errors. (Default value)
- ▶▶ All, But Diskette The system boot will not stop for a disk error; it will stop for all other errors.
- ▶▶ All, But Disk/Key The system boot will not stop for a keyboard or disk error; it will stop for all other errors.

Memory

The category is display-only which is determined by POST (Power On Self Test) of the BIOS.

Base Memory

The POST of the BIOS will determine the amount of base (or conventional) memory installed in the system.

The value of the base memory is typically 512 K for systems with 512 K memory installed on the motherboard, or 640 K for systems with 640 K or more memory installed on the motherboard.

Extended Memory

The BIOS determines how much extended memory is present during the POST.

This is the amount of memory located above 1 MB in the CPU's memory address map.

Advanced BIOS Features

MDS Setup Utility-Copyright (C) 1984-2002 Award Software

Advanced BIOS Features

| | | |
|---|-------------|--------------|
| SATA/RAID / SCSI Boot Order** | [RAID,SCSI] | Item Help |
| First Boot Device | [Floppy] | Menu Level ► |
| Second Boot Device | [HDD-0] | |
| Third Boot Device | [CDROM] | |
| Boot Up Floppy Seek | [Disabled] | |
| Password Check | [Setup] | |
| #CPU Hyper-Threading | [Enabled] | |
| Init Display First | [AGP] | |
| ↑↓→← : Move Enter:Select +/-/U/ED=Value F10:Save ESC:Exit F1:General Help F3:Language F5:Previous Values F6:Fail-Safe Defaults F7:Optimized Defaults | | |

Figure 3: Advanced BIOS Features

“ # ” System will detect automatically and show up when you install the Intel® Pentium® 4 processor with HT Technology.

☛ SATA/RAID // SCSI Boot Order **

☛ This feature allows you to select the boot order SATA or RAID or SCSI device.

- ▶▶ SATA Select your boot device priority by SATA.
- ▶▶ RAID Select your boot device priority by RAID.
- ▶▶ SCSI Select your boot device priority by SCSI.

☛ First / Second / Third Boot device

☛ This feature allows you to select the boot device priority.

- ▶▶ Floppy Select your boot device priority by Floppy.
- ▶▶ LS120 Select your boot device priority by LS120.
- ▶▶ HDD-0-3 Select your boot device priority by HD-0-3.
- ▶▶ SCSI Select your boot device priority by SCSI.
- ▶▶ CDROM Select your boot device priority by CDROM.
- ▶▶ LAN Select your boot device priority by LAN.
- ▶▶ USB-CDROM Select your boot device priority by USB-CDROM.

** For GA-8PE667 Ultra2 Only

- ▶▶ USB-ZIP Select your boot device priority by USB-ZIP.
- ▶▶ USB-FDD Select your boot device priority by USB-FDD.
- ▶▶ USB-HDD Select your boot device priority by USB-HDD.
- ▶▶ ZIP Select your boot device priority by ZIP.
- ▶▶ Disabled Disabled this function.

☞ Boot Up Floppy Seek

☛ During POST, BIOS will determine the floppy disk drive installed is 40 or 80 tracks. 360 K type is 40 tracks 720 K, 1.2 M and 1.44 M are all 80 tracks.

- ▶▶ Enabled BIOS searches for floppy disk drive to determine it is 40 or 80 tracks. Note that BIOS can not tell from 720 K, 1.2 M or 1.44 M drive type as they are all 80tracks.
- ▶▶ Disabled BIOS will not search for the type of floppy disk drive by track number. Note that there will not be any warning message if the drive installed is 360 K.
(Default value)

☞ Password Check

- ▶▶ System The system can not boot and can not access to Setup page will be denied if the correct password is not entered at the prompt.
- ▶▶ Setup The system will boot, but access to Setup will be denied if the correct password is not entered at the prompt. (Default value)

☞ CPU Hyper-Threading

- ▶▶ Enabled Enables CPU Hyper Threading Feature. Please note that this feature is only working for operating system with multi processors mode supported.
(Default value)
- ▶▶ Disabled Disables CPU Hyper Threading.

☞ Init Display First

☛ This feature allows you to select the first initiation of the monitor display from which card, when you install an AGP VGA card and a PCI VGA card on board.

- ▶▶ PCI Set Init Display First to PCI Slot.
- ▶▶ AGP Set Init Display First to AGP. (Default value)

Integrated Peripherals

CMOS Setup Utility-Copyright (C) 1984-2002 Award Software

Integrated Peripherals

| | | |
|---|------------|--------------|
| On-Chip Primary PCI IDE | [Enabled] | Item Help |
| On-Chip Secondary PCI IDE | [Enabled] | Menu Level ► |
| IDE1 Conductor Cable | [Auto] | |
| IDE2 Conductor Cable | [Auto] | |
| USB Controller | [Enabled] | |
| USB Keyboard Support | [Disabled] | |
| USB Mouse Support | [Disabled] | |
| AC97 Audio | [Auto] | |
| Onboard H/W SATA** | [Enabled] | |
| Serial ATA Function** | [RAID] | |
| Onboard ATA/RAID Device * | [Enabled] | |
| RAID Controller Function * | [ATA] | |
| Onboard H/W LAN | [Enabled] | |
| Onboard LAN Boot ROM | [Disabled] | |
| Onboard Serial Port 1 | [3F8/IRQ4] | |
| Onboard Serial Port 2 | [2F8/IRQ3] | |
| UART Mode Select | [Normal] | |
| *UR2 Duplex Mode | Half | |
| Onboard Parallel Port | [378/IRQ7] | |
| Parallel Port Mode | [SPP] | |
| *ECP Mode Use DMA | 3 | |
| Game Port Address | [201] | |
| Midi Port Address | [300] | |
| Midi Port IRQ | [10] | |
| CIR Port Address | [Disabled] | |
| *CIR Port IRQ | 11 | |
| ↑↓←→: Move Enter:Select +/-/PU/ED:Value F10:Save ESC:Exit F1:General Help F3:Language F5:Previous Values F6:Fail-Safe Defaults F7:Optimized Defaults | | |

Figure 4: Integrated Peripherals

** For GA-8PE667 Ultra2 Only

☛ On-Chip Primary PCI IDE

☛ When enabled, allows you to use the onboard primary PCI IDE. If a hard disk controller card is used, set at Disabled.

- ▶▶ Enabled Enable onboard 1st channel IDE port. (Default value)
- ▶▶ Disabled Disable onboard 1st channel IDE port.

☛ On-Chip Secondary PCI IDE

☛ When enabled, allows you to use the onboard secondary PCI IDE. If a hard disk controller card is used, set at Disabled.

- ▶▶ Enabled Enable onboard 2nd channel IDE port. (Default value)
- ▶▶ Disabled Disable onboard 2nd channel IDE port.

☛ IDE1 Conductor Cable

- ▶▶ Auto Will be automatically detected by BIOS (Default Value)
- ▶▶ ATA66/100 Set IDE1 Conductor Cable to ATA66/100 (Please make sure your IDE device and cable is compatible with ATA66/100)
- ▶▶ ATA33 Set IDE1 Conductor Cable to ATA33 (Please make sure your IDE device and cable is compatible with ATA33)

☛ IDE2 Conductor Cable

- ▶▶ Auto Will be automatically detected by BIOS (Default Value)
- ▶▶ ATA66/100 Set IDE2 Conductor Cable to ATA66/100 (Please make sure your IDE device and cable is compatible with ATA66/100)
- ▶▶ ATA33 Set IDE2 Conductor Cable to ATA33 (Please make sure your IDE device and cable is compatible with ATA33).

☛ USB Controller

☛ Disable this option if you are not using the onboard USB feature.

- ▶▶ Enabled Enabled USB Controller. (Default value)
- ▶▶ Disabled Disabled USB Controller.

☛ USB Keyboard Support

☛ When a USB keyboard is installed, please set at Enabled.

- ▶▶ Enabled Enabled USB Keyboard Support.
- ▶▶ Disabled Disabled USB Keyboard Support. (Default value)

☛ USB Mouse Support

- ▶▶ Enabled Enabled USB Mouse Support.
- ▶▶ Disabled Disabled USB Mouse Support. (Default value)

☛ AC97 Audio

- ▶▶ Auto BIOS will automatically detect onboard AC97 Audio. (Default value)
- ▶▶ Disabled Disabled AC97 Audio.

☛ Onboard H/W SATA **

🔌 Disable this option if you are not using the onboard Serial ATA feature.

- ▶▶ Enabled Enabled Onboard H/W Serial ATA support. (Default value)
- ▶▶ Disabled Disabled Onboard H/W Serial ATA.

☛ Serial ATA Function **

- ▶▶ RAID Select onboard Serial ATA chip function as RAID. (Default value)
- ▶▶ BASE Select onboard Serial ATA chip function as BASE.

☛ Onboard ATA/RAID Device **(For IDE3/4)

🔌* If you don't set any HDD Device in IDE3 or 4 but enable the function, the normal message "MBUltra133 BIOS is not installed because there are no drives attached" will come out.

Ignore this message or set the option disable to make the message disappear.

- ▶▶ Enable Enabled onboard ATA/RAID function. (Default value)
- ▶▶ Disable Disabled this function.

☛ RAID Controller Function **(For IDE3/4)

🔌 Select onboard IDE RAID chip function as ATA or RAID.

- ▶▶ ATA Enabled ATA function. (Default value)
- ▶▶ RAID Enabled RAID function.

☛ Onboard H/W LAN

- ▶▶ Enable Enabled onboard LAN function. (Default value)
- ▶▶ Disable Disable onboard LAN function.

** For GA-8PE667 Ultra2 Only

☛ Onboard LAN Boot ROM

☛ This function is to invoke onboard LAN chip to boot up the system

- ▶▶ Enable Enable onboard LAN boot ROM function.
- ▶▶ Disable Disable this function. (Default value)

☛ Onboard Serial Port 1

- ▶▶ Auto BIOS will automatically setup the port 1 address.
- ▶▶ 3F8/IRQ4 Enable onboard Serial port 1 and address is 3F8. (Default value)
- ▶▶ 2F8/IRQ3 Enable onboard Serial port 1 and address is 2F8.
- ▶▶ 3E8/IRQ4 Enable onboard Serial port 1 and address is 3E8.
- ▶▶ 2E8/IRQ3 Enable onboard Serial port 1 and address is 2E8.
- ▶▶ Disabled Disable onboard Serial port 1.

☛ Onboard Serial Port 2

- ▶▶ Auto BIOS will automatically setup the port 2 address.
- ▶▶ 3F8/IRQ4 Enable onboard Serial port 2 and address is 3F8.
- ▶▶ 2F8/IRQ3 Enable onboard Serial port 2 and address is 2F8. (Default Value)
- ▶▶ 3E8/IRQ4 Enable onboard Serial port 2 and address is 3E8.
- ▶▶ 2E8/IRQ3 Enable onboard Serial port 2 and address is 2E8.
- ▶▶ Disabled Disable onboard Serial port 2.

☛ UART Mode Select

☛ This feature allows you to determine which Infra Red(IR) function of Onboard I/O chip)

- ▶▶ ASKIR Using as IR and set to ASKIR Mode.
- ▶▶ IrDA Using as IR and set to IrDA Mode.
- ▶▶ Normal Using as standard serial port. (Default Value)
- ▶▶ SCR Using as smart card Interface.

☛ UR2 Duplex Mode(When UART Mode Select is set [ASKIR or IrDA or SCR])

☛ This feature allows you to select the IR modes.

- ▶▶ Half IR Function Duplex Half. (Default Value)
- ▶▶ Full IR Function Duplex Full.

☛ OnBoard Parallel port

☛ This feature allows you to select from a given set of parameters if the parallel port uses the onboard I/O controller.

- ▶▶ 378/IRQ7 Enable On Board LPT port and address is 378. (Default Value)
- ▶▶ 278/IRQ5 Enable On Board LPT port and address is 278.
- ▶▶ 3BC/IRQ7 Enable On Board LPT port and address is 3BC.

☛ Parallel Port Mode

☛ This feature allows you to connect with an advanced print via the port mode it supports.

- ▶▶ SPP Using Parallel port as Standard Parallel Port . (Default Value)
- ▶▶ EPP Using Parallel port as Enhanced Parallel Port .
- ▶▶ ECP Using Parallel port as Extended Capabilities Port .
- ▶▶ ECP+EPP Using Parallel port as ECP & EPP mode.

☛ ECP Mode Use DMA(When Parallel Port Mode is set [ECP or ECP+EPP])

- ▶▶ 3 Use DMA 3 for ECP mode. (Default value)
- ▶▶ 1 Use DMA 1 for ECP mode.

☛ Game Port Address

- ▶▶ Disabled Disabled this function.
- ▶▶ 201 Enabled Game Port and Address is 201. (Default Value)
- ▶▶ 209 Enabled Game Port and Address is 209.

☛ Midi Port Address

- ▶▶ Disabled Disabled this function.
- ▶▶ 300 Enabled Midi Port and Address is 300.
- ▶▶ 330 Enabled Midi Port and Address is 330. (Default Value)

☛ Midi Port IRQ

- ▶▶ 5 Midi Port use IRQ 5.
- ▶▶ 10 Midi Port use IRQ 10. (Default Value)

☛ CIR Port Address

This feature allows you to select CIR port address or disable it.

- ▶▶ Disabled Disabled this function. (Default Value)
- ▶▶ 310 Enabled CIR and Address is 310.
- ▶▶ 320 Enabled CIR and Address is 320.

☛ CIR Port IRQ (When Paralleled Port Mode is set [HCP or HCP+HPP])

This feature allows you to select CIR IRQ , if CIR is enabled.

- ▶▶ 5 CIR use IRQ 5.
- ▶▶ 11 CIR use IRQ 11. (Default Value)

Power Management Setup

CMOS Setup Utility-Copyright (C) 1984-2002 Award Software

Power Management Setup

| | | |
|---|---------------|--------------|
| ACPI Suspend Type | [S1(POS)] | Item Help |
| Power LED in S1 State | [Blinking] | Menu Level ► |
| Soft-Off by PWR-BTIN | [Instant-Off] | |
| PMEvent Wake Up | [Enabled] | |
| ModemRingOn/WakeOnLAN | [Enabled] | |
| Resume by Alarm | [Disabled] | |
| * Date(of Month) Alarm | Everyday | |
| * Time(hh:mm:ss) Alarm | 0: 0: 0 | |
| Power On By Mouse | [Disabled] | |
| Power On By Keyboard | [Disabled] | |
| *KB Power On Password | Enter | |
| AC Back Function | [Soft-Off] | |
| ↑↓→←: Move Enter:Select +/-/PU/ED:Value F10:Save ESC:Exit F1:General Help F3:Language F5:Previous Values F6:Fail-Safe Defaults F7:Optimized Defaults | | |

Figure 5: Power Management Setup

☛ ACPI Suspend Type

- ▶ S1 (POS) Set ACPI Suspend Type to S1/POS (Power On Suspend). (Default value)
- ▶ S3 (SIR) Set ACPI Suspend Type to S3/SIR (Suspend To RAM).

☛ Power LED in S1 State

- ▶ Blinking In standby mode(S1), power LED will blink. (Default Value)
- ▶ Dual/Off In standby mode(S1):
 - a. If use single color LED, power LED will turn off
 - b. If use dual color LED, power LED will turn to another color.

☛ Soft-off by PWR-BT/N

- ▶ Instant-off Press power button then Power off instantly. (Default value)
- ▶ Delay 4 Sec. Press power button 4 sec to Power off. Enter suspend if button is pressed less than 4 sec.

☛ PME Event Wake up

- When set at Enabled, any PCI-PM event awakes the system from a PCI-PM controlled state.
- This feature requires an ATX power supply that provides at least 1A on the +5VSB lead.
 - ▶ Disabled Disabled PME Event Wake up function.
 - ▶ Enabled Enabled PME Event Wake up function. (Default Value)

☛ Modem Ring On/ WakeOnLAN (When AC Back Function is set to [Soft-Off])

- You can enable wake on LAN feature by the "ModemRingOn/WakeOnLAN" or "PME Event Wake up" when the M/B has "WOL" onboard connector. Only enabled the feature by "PME Event Wake up".
- An incoming call via modem awakes the system from its soft-off mode.
- When set at Enabled, an input signal comes from the other client/server on the LAN awakes the system from a soft off state if connected over LAN.
 - ▶ Disabled Disabled Modem Ring On / Wake On LAN function.
 - ▶ Enabled Enabled Modem Ring On / Wake On LAN function. (Default Value)

☛ Resume by Alarm

You can set "Resume by Alarm" item to enabled and key in Date/time to power on system.

- ▶▶ Disabled Disable this function. (Default Value)
- ▶▶ Enabled Enable alarm function to POWER ON system.

IFRTC Alarm Lead To Power On is Enabled.

Date (of Month) Alarm : Everyday, 1-31
 Time (Hh: mm: ss) Alarm : (0-23) : (0-59) : (0-59)

☛ Power On By Mouse

- ▶▶ Disabled Disabled this function. (Default value)
- ▶▶ Mouse Click Set mouse double click to power on system.

☛ Power On By Keyboard

This feature allows you to set the method for powering-on the system.

The option "Password" allows you to set up to 5 alphanumeric characters to power-on the system.

The option "Keyboard 98" allows you to use the standard keyboard 98 to power on the system.

- ▶▶ Password Enter from 1 to 5 characters to set the Keyboard Power On Password.
- ▶▶ Disabled Disabled this function. (Default value)
- ▶▶ Keyboard 98 If your keyboard have "POWER Key" button, you can press the key to power on your system.

☛ KB Power ON Password

- ▶▶ Enter Input password (from 1 to 5 characters) and press Enter to set the Keyboard Power On Password..

☛ AC Back Function

- ▶▶ Memory System power on depends on the status before AC lost.
- ▶▶ Soft-Of f Always in Of f state when AC back. (Default value)
- ▶▶ Full-On Always power on the system when AC back.

PnP/PCI Configurations

CMOS Setup Utility-Copyright (C) 1984-2002 Award Software

PnP/PCI Configurations

| | | |
|--|--------|--------------|
| PCI1/PCI5 IRQ Assignment | [Auto] | Item Help |
| PCI2 /PCI6 IRQ Assignment | [Auto] | Menu Level ► |
| PCI3 IRQ Assignment | [Auto] | |
| PCI4 IRQ Assignment | [Auto] | |
| ↑↓→← : Move Enter:Select +/-/PU/ED:Value F10:Save ESC:Exit F1:General Help F3:Language F5:Previous Values F6:Fail-Safe Defaults F7:Optimized Defaults | | |

Figure 6: PnP/PCI Configurations

☛ PCI1/PCI5 IRQ Assignment

- ▶▶ Auto Auto assign IRQ to PCI 1/ PCI 5. (Default value)
- ▶▶ 3,4,5,7,9, ,10,11,12,15 Set 3,4,5,7,9,10,11,12,15 to PCI1/ PCI5.

☛ PCI2/PCI6 IRQ Assignment

- ▶▶ Auto Auto assign IRQ to PCI 2/ PCI 6. (Default value)
- ▶▶ 3,4,5,7,9, ,10,11,12,15 Set 3,4,5,7,9,10,11,12,15 to PCI2/ PCI6.

☛ PCI3 IRQ Assignment

- ▶▶ Auto Auto assign IRQ to PCI 3. (Default value)
- ▶▶ 3,4,5,7,9, ,10,11,12,15 Set 3,4,5,7,9,10,11,12,15 to PCI3.

☛ PCI4 IRQ Assignment

- ▶▶ Auto Auto assign IRQ to PCI 4. (Default value)
- ▶▶ 3,4,5,7,9, ,10,11,12,15 Set 3,4,5,7,9,10,11,12,15 to PCI4.

PC Health Status

CMOS Setup Utility-Copyright (C) 1984-2002 Award Software

PC Health Status

| | | |
|--|------------|--------------|
| Reset Case Open Status | [Disabled] | Item Help |
| Case Opened | No | Menu Level ▶ |
| VCORE | 1.448V | |
| +1.5V | 1.448V | |
| +3.3V | 3.312V | |
| +5V | 5.080 V | |
| +12V | 11.904V | |
| Current CPU Temperature | 30°C | |
| Current CPU FAN Speed | 4440 RPM | |
| Current POWER FAN speed | 0 RPM | |
| Current SYSTEM FAN speed | 0 RPM | |
| CPU Warning Temperature | [Disabled] | |
| CPU FAN Fail Warning | [Disabled] | |
| POWER FAN Fail Warning | [Disabled] | |
| SYSTEM FAN Fail Warning | [Disabled] | |
| ↑↓→←: Move Enter:Select +/-/U/ED:Value F10:Save ESC:Exit F1:General Help F3:Language F5:Previous Values F6:Fail-Safe Defaults F7:Optimized Defaults | | |

Figure7: PC Health Status

Reset Case Open Status

Case Opened

If the case is closed, "Case Opened" will show "No".

If the case have been opened, "Case Opened" will show "Yes".

If you want to reset "Case Opened" value, set "Reset Case Open Status" to "Enabled" and save CMOS, your computer will restart.

Current Voltage (V) VCORE /+1.5V/+3.3V/ +5V / +12V

Detect system's voltage status automatically.

☛ Current CPU Temperature (°C)

Detect CPU Temp. automatically.

☛ Current CPU FAN / POWER / SYSTEM FAN Speed (RPM)

Detect Fan speed status automatically.

☛ CPU Warning Temperature

- ▶▶ 60°C / 140°F Monitor CPU Temp. at 60°C / 140°F.
- ▶▶ 70°C / 158°F Monitor CPU Temp. at 70°C / 158°F.
- ▶▶ 80°C / 176°F Monitor CPU Temp. at 80°C / 176°F.
- ▶▶ 90°C / 194°F Monitor CPU Temp. at 90°C / 194°F.
- ▶▶ Disabled Don't monitor current temperature. (Default value)

☛ Fan Fail Warning (CPU / POWER / SYSTEM)

- ▶▶ Disabled Fan Fail Alarm Function Disabled. (Default value)
- ▶▶ Enabled Fan Fail Alarm Function Enabled.

Frequency/Voltage Control

MDS Setup Utility-Copyright (C) 1984-2002 Award Software

Frequency/Voltage Control

| | | |
|--|-----------|--------------|
| CPU Clock Ratio | [15X] | Item Help |
| CPU Host Clock Control | [Disable] | Menu Level ► |
| *CPU Host Frequency(MHz) | 100 | |
| *Fixed PCI/AGP Frequency | 33/66 | |
| Host/DRAM Clock ratio | [Auto] | |
| Memory Frequency(MHz) | 256 | |
| PCI/AGP Frequency(MHz) | 33/66 | |
| DIMM OverVoltage Control | [Normal] | |
| AGP OverVoltage Control | [Normal] | |
| CPU Voltage Control | [Normal] | |
| Normal CPU Vcore | 1.5V | |
| ↑↓→← : Move Enter:Select +/-/F10:Value F10:Save ESC:Exit F1:General Help F3:Language F5:Previous Values F6:Fail-Safe Defaults F7:Optimized Defaults | | |

Figure 8: Frequency/Voltage Control

*Those items will be available when "CPU Host Clock Control" is set to Enabled.

☞ CPU Clock Ratio

This setup option will automatically assign by CPU detection.

For Willamette CPU:

8X-23X default: 14X

For C-Stepping P4:

8X,10X-24X default: 15X

For Northwood CPU:

12X-24X default: 16X

The option will display "Locked" and read only if the CPU ratio is not changeable.

☞ CPU Host Clock Control

Note: If system hangs up before enter MDS setup utility, wait for 20 sec for times out reboot. When time out occur, system will reset and run at CPU default Host clock at next boot.

- ▶▶ Disable Disable CPU Host Clock Control. (Default value)
- ▶▶ Enable Enable CPU Host Clock Control.

☛ CPU Host Frequency (MHz)

▶▶ 100MHz ~ 355MHz Set CPU Host Clock from 100MHz to 355MHz.

☛ Fixed PCI/AGP Frequency

▶▶ You can choose those mode to adjust PCI/AGP frequency. (Select PCI/AGP frequency asynchronous with CPU frequency).

☛ Host/DRAM Clock Ratio

for FSB(Front Side Bus) frequency=400MHz,

▶▶ 2.0 Memory Frequency = Host clock X 2.0.

▶▶ 2.66 Memory Frequency = Host clock X 2.66.

▶▶ Auto Set Memory frequency by DRAM SPD data. (Default value)

for FSB(Front Side Bus) frequency=533MHz,

▶▶ 2.0 Memory Frequency = Host clock X 2.0.

▶▶ 2.5 Memory Frequency = Host clock X 2.5.

▶▶ Auto Set Memory frequency by DRAM SPD data. (Default value)

☛ Memory Frequency(Mhz)

▶▶ The values depend on CPU Host Frequency(Mhz) .

☛ PCI/AGP Frequency(Mhz)

▶▶ The values depend on Fixed PCI/AGP Frequency item

☛ DIMM OverVoltage Control

▶▶ Normal The default DIMM voltage. (Default value)

▶▶ +0.1V~+0.2V Set DIMM voltage from 2.6V~2.7V.

☛ AGP OverVoltage Control

▶▶ Normal Auto detect AGP voltage. (Default value)

▶▶ +0.1V~+.03V Set AGP voltage from 1.6V~1.8V.

☛ CPU OverVoltage Control

▶▶ Normal Auto detect CPU voltage. (Default value)

▶▶ 1.775V~1.850V Set CPU voltage from 1.775V~1.850V.

☛ Normal CPU Vcore 1.5V

Select Language

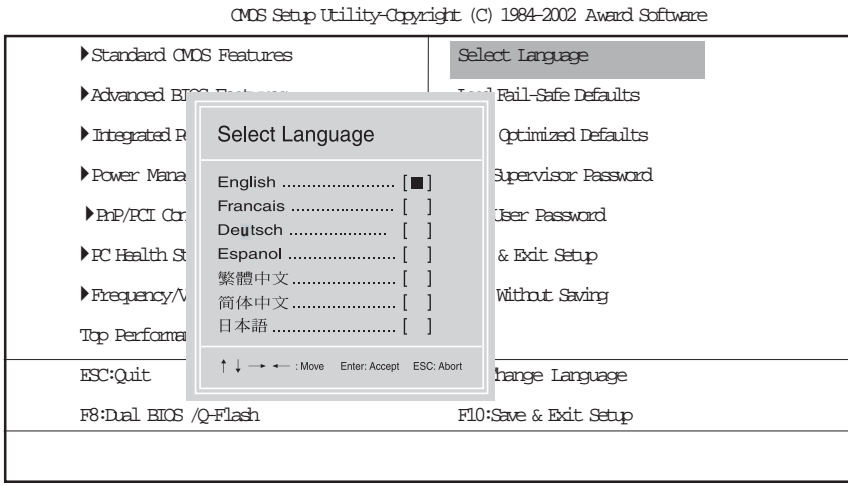

Figure 10:Select Language

Select Language

Multi Language is supports 7 languages. There are English, Japanese, French, Spanish, Germany, Simplified Chinese, Traditional Chinese.

Load Fail-Safe Defaults

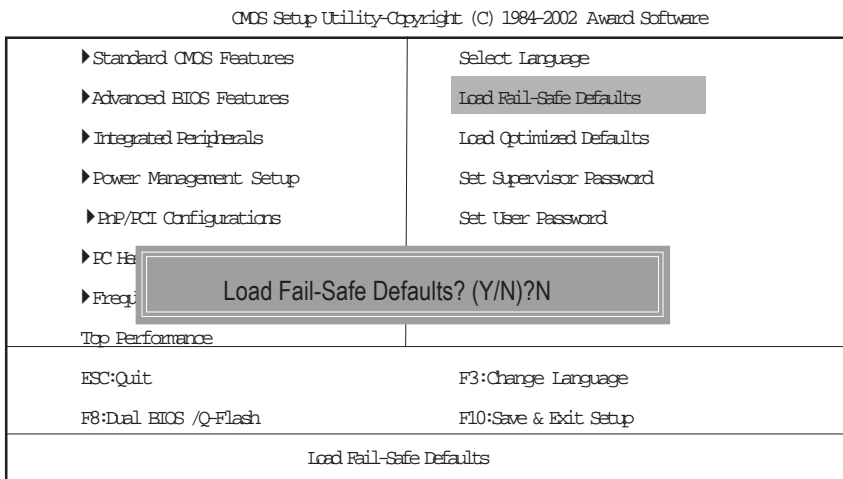

Figure 11: Load Fail-Safe Defaults

☛ Load Fail-Safe Defaults

Fail-Safe defaults contain the most appropriate values of the system parameters that allow minimum system performance.

Load Optimized Defaults

CMOS Setup Utility-Copyright (C) 1984-2002 Award Software

| | |
|-----------------------------|--------------------------------|
| ▶ Standard CMOS Features | Select Language |
| ▶ Advanced BIOS Features | Load Fail-Safe Defaults |
| ▶ Integrated Peripherals | Load Optimized Defaults |
| ▶ Power Management Setup | Set Supervisor Password |
| ▶ AP/PCI | |
| ▶ PC Health | |
| ▶ Frequency/Voltage Control | Exit Without Saving |
| Top Performance | |
| ESC:Quit | F3:Change Language |
| F8:Dual BIOS /Q-Flash | F10:Save & Exit Setup |
| Load Optimized Defaults | |

Figure 12: Load Optimized Defaults

☛ Load Optimized Defaults

Selecting this field loads the factory defaults for BIOS and Chipset Features which the system automatically detects.

Set Supervisor/User Password

CMOS Setup Utility-Copyright (C) 1984-2002 Award Software

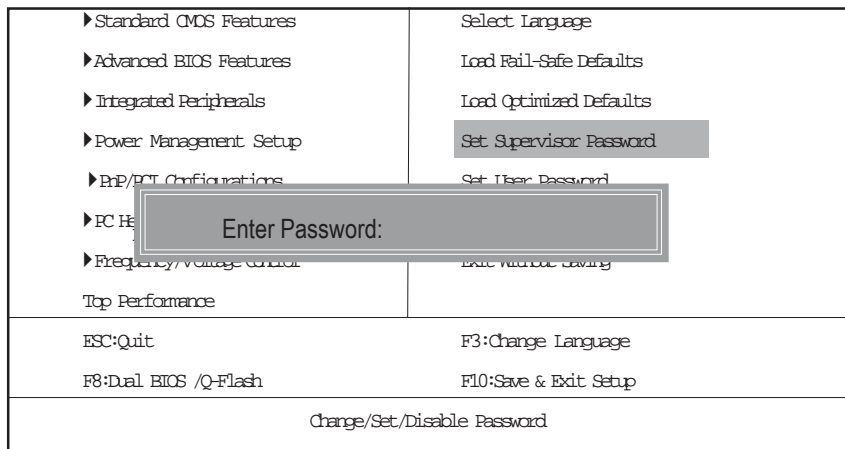

Figure 13: Password Setting

When you select this function, the following message will appear at the center of the screen to assist you in creating a password.

Type the password, up to eight characters, and press <Enter>. You will be asked to confirm the password. Type the password again and press <Enter>. You may also press <Esc> to abort the selection and not enter a password.

To disable password, just press <Enter> when you are prompted to enter password. A message "PASSWORD DISABLED" will appear to confirm the password being disabled. Once the password is disabled, the system will boot and you can enter Setup freely.

The BIOS Setup program allows you to specify two separate passwords: a SUPERVISOR PASSWORD and a USER PASSWORD. When disabled, anyone may access all BIOS Setup program function. When enabled, the Supervisor password is required for entering the BIOS Setup program and having full configuration fields, the User password is required to access only basic items.

If you select "System" at "Security Option" in Advance BIOS Features Menu, you will be prompted for the password every time the system is rebooted or any time you try to enter Setup Menu.

If you select "Setup" at "Security Option" in Advance BIOS Features Menu, you will be prompted only when you try to enter Setup.

Save & Exit Setup

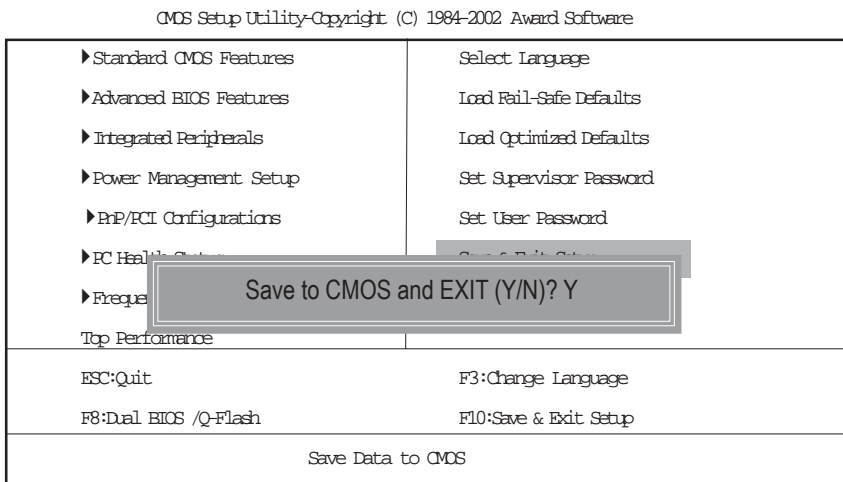

Figure 14: Save & Exit Setup

Type "Y" will quit the Setup Utility and save the user setup value to RTC CMOS.

Type "N" will return to Setup Utility.

Exit Without Saving

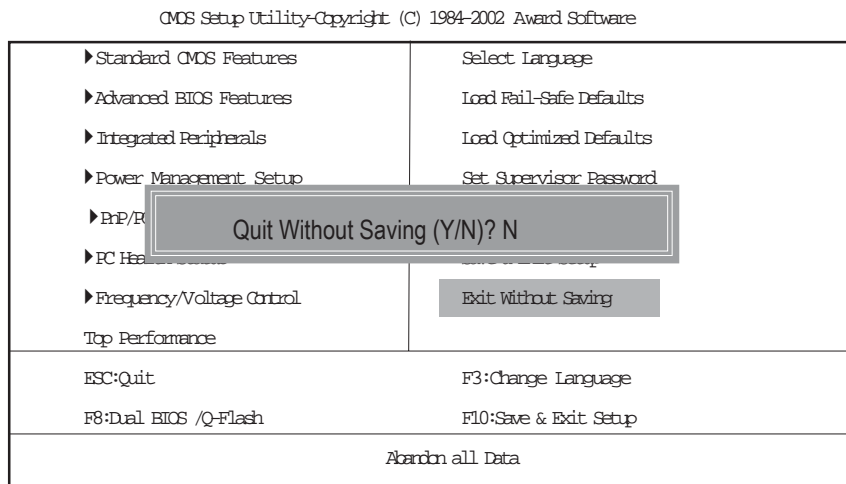

Figure 15: Exit Without Saving

Type "Y" will quit the Setup Utility without saving to RTC CMOS.

Type "N" will return to Setup Utility.

Chapter 4 Technical Reference

@ BIOS Introduction

Gigabyte announces @ BIOS Windows BIOS live update utility



Have you ever updated BIOS by yourself? Or like many other people, you just know what BIOS is, but always hesitate to update it? Because you think updating newest BIOS is unnecessary and actually you don't know how to update it.

Maybe not like others, you are very experienced in BIOS updating and spend quite a lot of time to do it. But of course you don't like to do it too much. First, download different BIOS from website and then switch the operating system to DOS mode. Secondly, use different flash utility to update BIOS. The above process is not a interesting job. Besides, always be carefully to store the BIOS source code correctly in your disks as if you update the wrong BIOS, it will be a nightmare.

Certainly, you wonder why motherboard vendors could not just do something right to save your time and effort and save you from the lousy BIOS updating work? Here it comes! Now Gigabyte announces @BIOS—the first Windows BIOS live update utility. This is a smart BIOS update software. It could help you to download the BIOS from internet and update it. Not like the other BIOS update software, it's a Windows utility. With the help of "@BIOS", BIOS updating is no more than a click.

Besides, no matter which mainboard you are using, if it's a Gigabyte's product*, @BIOS help you to maintain the BIOS. This utility could detect your correct mainboard model and help you to choose the BIOS accordingly. It then downloads the BIOS from the nearest Gigabyte ftp site automatically. There are several different choices; you could use "Internet Update" to download and update your BIOS directly. Or you may want to keep a backup for your current BIOS, just choose "Save Current BIOS" to save it first. You make a wise choice to use Gigabyte, and @BIOS update your BIOS smartly. You are now worry free from updating wrong BIOS, and capable to maintain and manage your BIOS easily. Again, Gigabyte's innovative product erects a milestone in mainboard industries.

For such a wonderful software, how much it costs? Impossible! It's free! Now, if you buy a Gigabyte's motherboard, you could find this amazing software in the attached driver CD. But please remember, connected to internet at first, then you could have a internet BIOS update from your Gigabyte @BIOS.

Easy Tune™ 4 Introduction

Gigabyte announces *EasyTune™ 4* Windows based Overclocking utility

EasyTune 4 carries on the heritage so as to pave the way for future generations.

"Overclock" might be one of the most common issues in computer field. But have many users ever tried it? The answer is probably "no". Because "Overclock" is thought to be very difficult and includes a lot of technical know-how, sometimes "Overclock" is even considered as special skills found only in some enthusiasts. But as to the experts in "Overclock", what's the truth? They may spend quite a lot of time and money to study, try and use many different hardware or BIOS tools to do "Overclock". And even with these technologies, they still learn that it's quite a risk because the safety



and stability of an "Overclock" system is unknown. Now everything is different because of a Windows based overclocking utility "EasyTune 4" --announced by Gigabyte. This windows based utility has totally changed the gaming rule of "Overclock". This is the first windows based overclocking utility is suitable for both normal and power users. Users can choose either "Easy Mode" or "Advanced Mode" for overclocking at their convenience. For users who choose "Easy Mode", they just need to click "Auto Optimize" to have autoed and immediate CPU overclocking. This software will then overdrive CPU speed automatically with the result being shown in the control panel. If users prefer "Overclock" by them, there is also another choice. Click "Advanced Mode" to enjoy "sport drive" class Overclocking user interface. "Advanced Mode", allows users to change the system bus / AGP / Memory working frequency in small increments to get ultimate system performance. It operates in coordination with Gigabyte motherboards. Besides, it is different from other traditional overclocking methods, EasyTune 4 doesn't require users to change neither BIOS nor hardware switch/jumper setting; on the other hand, they can do "Overclock" at easy step . Therefore, this is a safer way for "Overclock" as nothing is changed on software or hardware. If user runs EasyTune 4 over system's limitation, the biggest lost is only to restart the computer again and the side effect is then well controlled. Moreover, if one well-performed system speed has been tested in EasyTune 4, user can "Save" this setting and "Load" it in next time. Obviously, Gigabyte EasyTune 4 has already turned the "Overclock" technology toward to a newer generation. This wonderful software is now free bundled in Gigabyte motherboard attached in driver CD. Users may make a test drive of "EasyTune 4" to find out more amazing features by themselves.

*Some Gigabyte products are not fully supported by EasyTune 4. Please find the products supported list in the web site.

*Any "Overclocking action" is at user's risk, Gigabyte Technology will not be responsible for any damage or instability to your processor, motherboard, or any other components.

BIOS Flash Procedure



Method 1:

We use GA-7VTX motherboard and Flash841 BIOS flash utility as example.

Please flash the BIOS according to the following procedures if you are now under the DOS mode.

Flash BIOS Procedure:

STEP 1:

(1) Please make sure your system has installed the extraction utility such as winzip or pkunzip.

Firstly you have to install the extraction utility such as winzip or pkunzip for unzip the files. Both of these utilities are available on many shareware download pages like <http://www.cnet.com>

STEP 2: Make a DOS boot diskette. (See example: Windows 98 O.S.)

Beware: Windows ME/2000 are not allowed to make a DOS boot diskette.

(1) With an available floppy disk in the floppy drive. Please leave the diskette "UN-write protected" type. Double click the "My Computer" icon from Desktop, then click "3.5 diskette (A)" and right click to select "Format (M)"

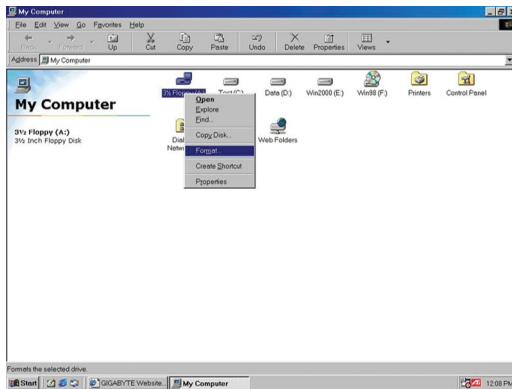

- (2) Select the "Quick (erase)" for Format Type, and pick both "Display summary when finished" and "Copy system files", after that press "Start". That will format the floppy and transfer the needed system files to it.

Beware: This procedure will erase all the prior data on that floppy, so please proceed accordingly.

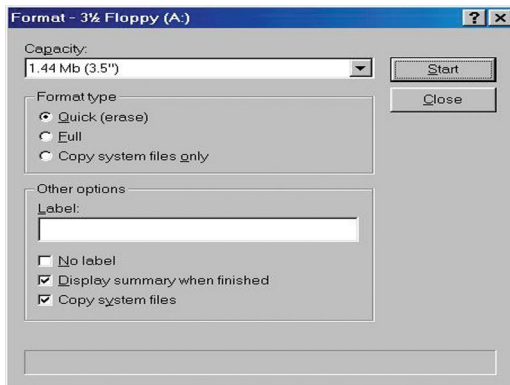

- (3) After the floppy has been formatted completely, please press "Close".

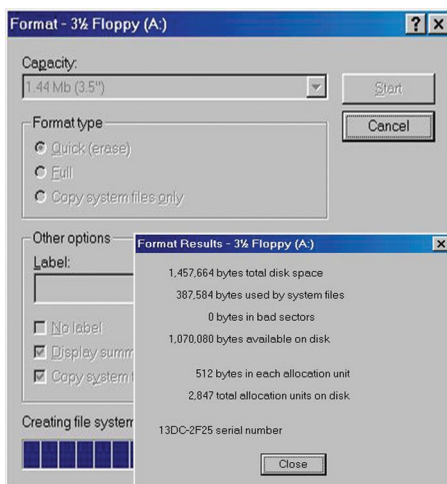

STEP 3: Download BIOS and BIOS utility program.

(1) Please go to Gigabyte website <http://www.gigabyte.com.tw/index.html>, and click "Support".

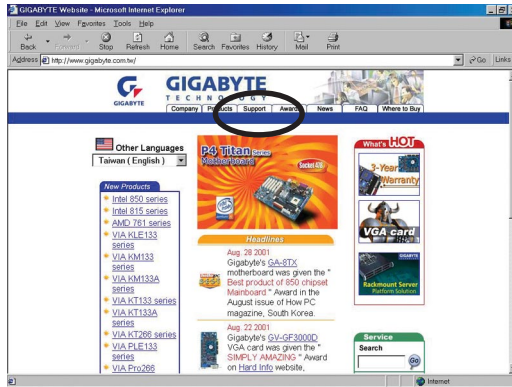

(2) From Support zone, click the "Motherboards BIOS & Drivers".

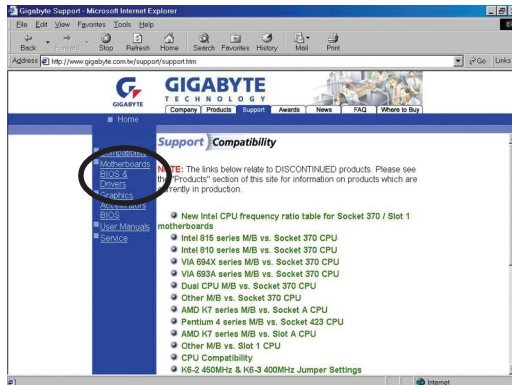

- (3) We use GA-7VTX motherboard as example. Please select GA-7VTX by Model or Chipset optional menu to obtain BIOS flash files.

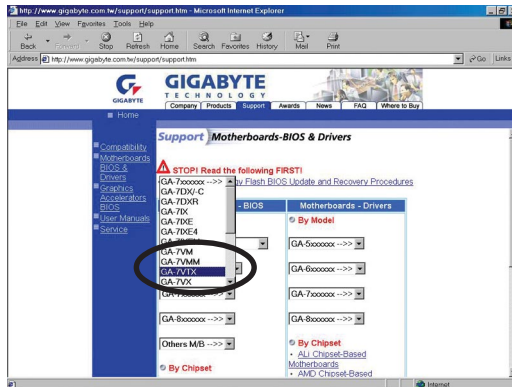

- (4) Select an appropriate BIOS version (For example: F4), and click to download the file. It will pop up a file download screen, then select the "Open this file from its current location" and press "OK".

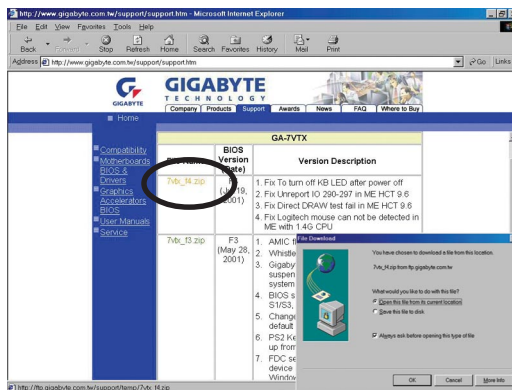

- (5) At this time the screen shows the following picture, please click "Extract" button to unzip the files.

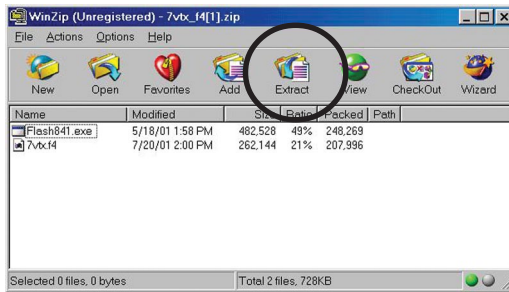

- (6) Please extract the download files into the clean bootable floppy disk A mentioned in STEP 2, and press "Extract".

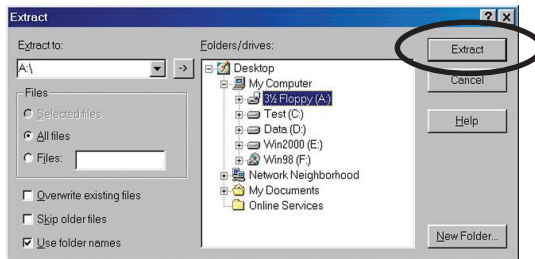

STEP 4: Make sure the system will boot from the floppy disk.

- (1) Insert the floppy disk (contains bootable program and unzip file) into the floppy drive A. Then, restart the system. The system will boot from the floppy disk. Please press key to enter BIOS setup main menu when system is boot up.



- (2) Once you enter the BIOS setup utility, the main menu will appear on the screen. Use the arrows to highlight the item "BIOS FEATURES SETUP".

| | |
|---|---|
| AMIBIOS SIMPLE SETUP UTILITY - VERSION 1.24b (C) 1999 American Megatrends, Inc. All Rights Reserved | |
| STANDARD CMOS SETUP BIOS FEATURES SETUP CHIPSET FEATURES SETUP POWER MANAGEMENT SETUP PNP / PCI CONFIGURATION LOAD BIOS DEFAULTS LOAD SETUP DEFAULTS | INTEGRATED PERIPHERALS HARDWARE MONITOR & MISC SETUP SUPERVISOR PASSWORD USER PASSWORD IDE HDD AUTO DETECTION SAVE & EXIT SETUP EXIT WITHOUT SAVING |
| ESC: Quit ↑↓←→ : Select Item (Shift)F2 : Change Color F5: Old Values F6: Load BIOS Defaults F7: Load Setup Defaults F10: Save & Exit | |
| Time, Date , Hard Disk Type... | |

- (3) Press "Enter" to enter "BIOS FEATURES SETUP" menu. Use the arrows to highlight the item "1st Boot Device", and then use the "Page Up" or "Page Down" keys to select "Floppy".

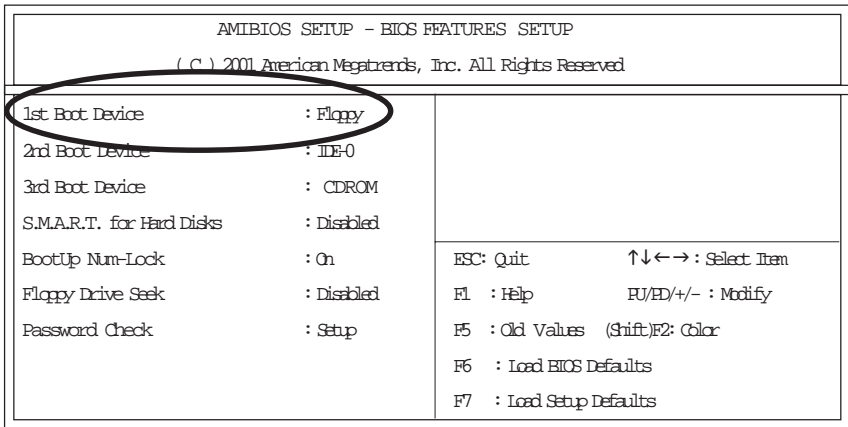

- (4) Press "ESC" to go back to previous screen. Use the arrows to highlight the item "SAVE & EXIT SETUP" then press "Enter". System will ask "SAVE to CMOS and EXIT (Y/N)?" Press "Y" and "Enter" keys to confirm. Now the system will reboot automatically, the new BIOS setting will be taken effect next boot-up.

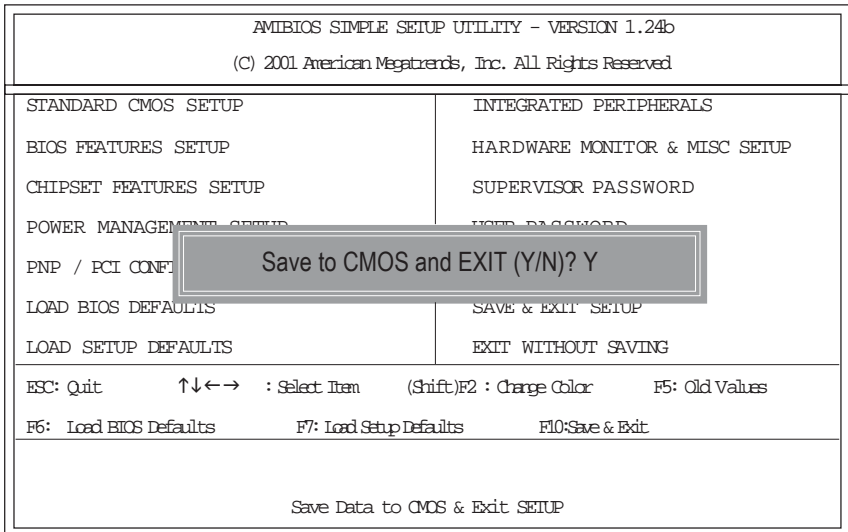

STEP 5: BIOS flashing.

- (1) After the system boot from floppy disk, type "A:\> dir/w" and press "Enter" to check the entire files in floppy A. Then type the "BIOS flash utility" and "BIOS file" after A:\>. In this case you have to type "A:\> Flash841 7VTX.F4" and then press "Enter".

```
Starting Windows 98...

Microsoft(R) Windows98
  © Copyright Microsoft Corp 1981-1999

A:\> dir/w
      Volume in drive A has no label
      Volume Serial Number is 16EB-353D
      Directory of A:\
COMMAND.COM  7VTX.F4  FLASH841.EXE
              3 file(s)  838,954 bytes
              0 dir(s)   324,608 bytes free

A:\> Flash841 7VTX.F4
```

- (2) Now screen appears the following Flash Utility main menu. Press "Enter", the highlighted item will locate on the model name of the right-upper screen. Right after that, press "Enter" to start BIOS Flash Utility.

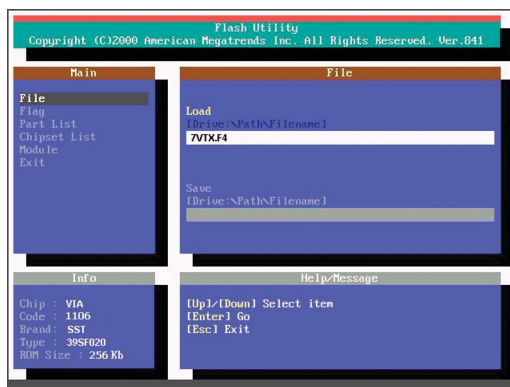

- (3) It will pop up a screen and asks "Are you sure to flash the BIOS?" Press [Enter] to continue the procedure, or press [ESC] to quit.

Beware: Please do not turn off the system while you are upgrading BIOS. It will render your BIOS corrupted and system totally inoperative.

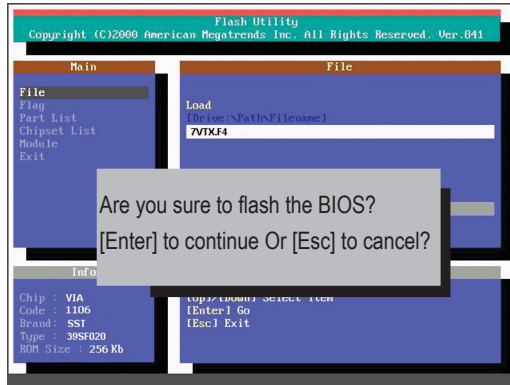

- (4) The BIOS flash completed. Please press [ESC] to exit Flash Utility.

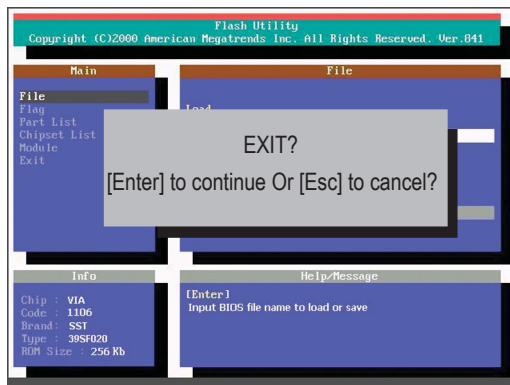

STEP 6: Load BIOS defaults.

Normally the system redetects all devices after BIOS has been upgraded. Therefore, we highly recommend reloading the BIOS defaults after BIOS has been upgraded. This important step resets everything after the flash.

- (1) Take out the floppy diskette from floppy drive, and then restart the system. The boot up screen will indicate your motherboard model and current BIOS version.



- (2) Don't forget to press key to enter BIOS setup again when system is boot up. Use the arrows to highlight the item "LOAD SETUP DEFAULTS" then press "Enter". System will ask "Load Setup Defaults (Y/N)?" Press "Y" and "Enter" keys to confirm.

| AMIBIOS SIMPLE SETUP UTILITY - VERSION 1.24b | |
|---|-------------------------------|
| (C) 2001 American Megatrends, Inc. All Rights Reserved | |
| STANDARD CMOS SETUP | INTEGRATED PERIPHERALS |
| BIOS FEATURES SETUP | HARDWARE MONITOR & MISC SETUP |
| CHIPSET FEATURES SETUP | SUPERVISOR PASSWORD |
| POWER MANAGEMENT | |
| PNP / PCI CONFIGURATION | |
| LOAD BIOS DEFAULTS | SAVE & EXIT SETUP |
| LOAD SETUP DEFAULTS | EXIT WITHOUT SAVING |
| Load Setup Defaults? (Y/N)?N | |
| ESC: Quit ↑↓←→ : Select Item (Shift)F2 : Change Color F5: Old Values | |
| F6: Load BIOS Defaults F7: Load Setup Defaults F10: Save & Exit | |
| Load Setup Defaults | |

- (3) Use the arrows to highlight the item "SAVE & EXIT SETUP" and press "Enter". System will ask "SAVE to CMOS and EXIT (Y/N)?" Press "Y" and "Enter" keys to confirm. Now the system will reboot automatically, the new BIOS setting will be taken effect next boot-up.

| AMIBIOS SIMPLE SETUP UTILITY - VERSION 1.24b | |
|--|-------------------------------|
| (C) 2001 American Megatrends, Inc. All Rights Reserved | |
| STANDARD CMOS SETUP | INTEGRATED PERIPHERALS |
| BIOS FEATURES SETUP | HARDWARE MONITOR & MISC SETUP |
| CHIPSET FEATURES SETUP | SUPERVISOR PASSWORD |
| POWER MANAGEMENT SETUP | USER PASSWORD |
| PNP / PCI CONFIGURATION | SAVE & EXIT SETUP |
| LOAD BIOS DEFAULTS | EXIT WITHOUT SAVING |
| LOAD SETUP DEFAULTS | |
| ESC: Quit ↑↓←→ : Select Item (Shift)F2 : Change Color F5: Old Values F6: Load BIOS Defaults F7: Load Setup Defaults F10: Save & Exit | |
| Save Data to CMOS & Exit SETUP | |

- (4) Congratulate you have accomplished the BIOS flash procedure.

Method 2:

Dual BIOS / Q-Flash Introduction

A. What is Dual BIOS Technology?

Dual BIOS means that there are two system BIOS (ROM) on the motherboard, one is the Main BIOS and the other is Backup BIOS. Under the normal circumstances, the system works on the Main BIOS. If the Main BIOS is corrupted or damaged, the Backup BIOS can take over while the system is powered on. This means that your PC will still be able to run stably as if nothing has happened in your BIOS.

B. How to use Dual BIOS and Q-Flash Utility?

a. After power on the computer, pressing immediately during POST (Power On Self Test) it will allow you to enter Award BIOS CMOS SETUP, then press <F8> to enter Flash utility.

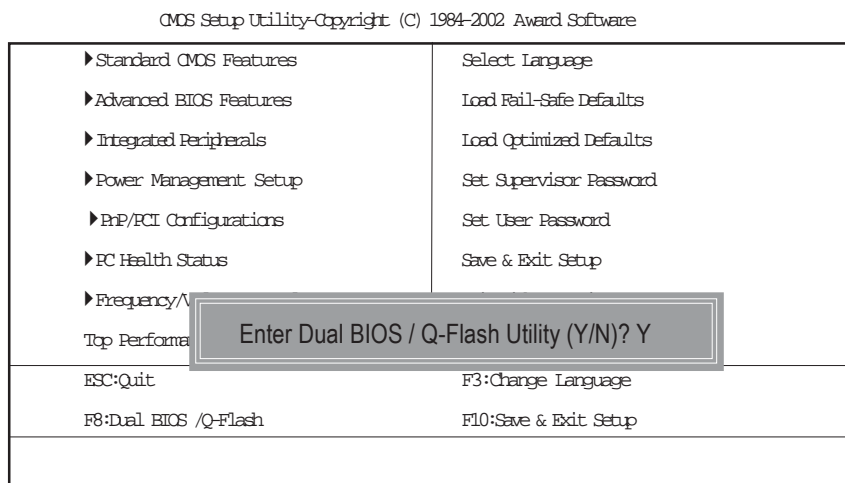

b. Dual BIOS / Q-Flash Utility

| Dual BIOS / Q-Flash Utility V845.4MF3 (C) 2001, GIGA-BYTE Technology Co., LTD. | |
|---|------------------------|
| Wide Range Protection | :Disabled |
| Halt On BIOS Defects | :Disabled |
| Auto Recovery | :Enabled |
| Boot From | :Main BIOS |
| BIOS Recovery | :Main to Backup |
| F3: Load Default | F5:Start BIOS Recovery |
| F7: Save And Restart | F9:Exit Without Saving |
| F8: Update BIOS from disk | F10:Recovery from Disk |
| Use <Space> key to toggle setup | |

c. Dual BIOS Item explanation:

Wide Range Protection: Disabled(Default), Enabled

Status 1:

If any failure (ex. Update ESCD failure, checksum error or reset...) occurs in the Main BIOS , just before the Operating System is loaded and after the power is on, and that the Wide Range Protection is set to "Enable", the PC will boot from Backup BIOS automatically.

Status 2:

If the ROM BIOS on peripherals cards(ex. SCSI Cards, LAN Cards,..) emits signals to request restart of the system after the user make any alteration on it, the boot up BIOS will not be changed to the Backup BIOS.

Halt On BIOS Defects : Disabled(Default), Enabled

If the BIOS occurs a checksum error or the Main BIOS occurs a WIDE RANGE PROTECTION error and Halt On BIOS Defects set to Enable, the PC will show messages on the boot screen, and the system will pause and wait for the user's instruction.

If Auto Recovery :**Disabled**, it will show **<or the other key to continue.>**

If Auto Recovery :**Enabled**, it will show **<or the other key to Auto Recover.>**

Auto Recovery : Enabled(Default), Disabled

When one of the Main BIOS or Backup BIOS occurs checksum failure, the working BIOS will automatically recover the BIOS of checksum failure.

(In the Power Management Setup of the BIOS Setting, if ACPI Suspend Type is set to Suspend to RAM, the Auto Recovery will be set to Enable automatically.)

(If you want to enter the BIOS setting, please press "Del" key when the boot screen appears.)

Boot From : Main BIOS(Default), Backup BIOS

Status 1:

The user can set to boot from main BIOS or Backup BIOS.

Status 2:

If one of the main BIOS or the Backup BIOS fails, this item "*Boot From : Main BIOS(Default)*" will become gray and will not be changed by user.

BIOS Recovery : Main to Backup

Auto recovery message:

BIOS Recovery: Main to Backup

The means that the Main BIOS works normally and could automatically recover the Backup BIOS.

BIOS Recovery: Backup to Main

The means that the Backup BIOS works normally and could automatically recover the Main BIOS.

(This auto recovery utility is set by system automatically and can't be changed by user.)

C. What is Q-Flash Utility?

Q-Flash utility is a pre-O.S. BIOS flash utility enables users to update its BIOS within BIOS mode, no more fooling around any OS.

D. How to use Q-Flash Flash?

| | |
|---|---|
| <p>F3: Load Default Load current BIOS default value.</p> | <p>F5: Start BIOS Recovery Press F5 to recovery new BIOS version.</p> |
| <p>F7: Save and Restart Save revised setting and restart the computer.</p> | <p>F9: Exit Without Saving Exit without changing.</p> |
| <p>F8: Update BIOS from Disk Update boot-up BIOS.</p> | <p>F10: Recovery from Disk Update another BIOS (different from boot-up BIOS)</p> |



DualBIOS™ Technology FAQ

GIGABYTE Technology is pleased to introduce DualBIOS technology, a hot spare for your system BIOS. This newest "Value-added" feature, in a long series of innovations from GIGABYTE, is available on this mainboard. Future GIGABYTE motherboards will also incorporate this innovation.

What's DualBIOS™?

On GIGABYTE motherboards with DualBIOS there are physically two BIOS chips. For simplicity we'll call one your "Main BIOS" and the other we'll call your "Backup" BIOS (your "hot spare"). If your Main BIOS fails, the Backup BIOS almost automatically takes over on your next system boot. Almost automatically and with virtually zero down time! Whether the problem is a failure in flashing your BIOS or a virus or a catastrophic failure of the Main BIOS chip, the result is the same - the Backup BIOS backs you up, almost automatically.

I. Q: What is DualBIOS™ technology?

Answer:

DualBIOS technology is a patented technology from Giga-Byte Technology. The concept of this technology is based on the redundancy and fault tolerance theory. DualBIOS™ technology simply means there are two system BIOSes (ROM) integrated onto the motherboard. One is a main BIOS, and the other is a backup BIOS. The mainboard will operate normally with the main BIOS, however, if the main BIOS is corrupt or damaged for various reasons, the backup BIOS will be automatically used when the system powered-On. Your PC will operate as before the main BIOS was damaged, and is completely transparent to the user.

II. Q: Why does anyone need a motherboard with DualBIOS™ technology?

Answer:

In today's systems there are more and more BIOS failures. The most common reasons are virus attacks, BIOS upgrade failures, and/or deterioration of the BIOS (ROM) chip itself.

1. New computer viruses are being found that attack and destroy the system BIOS. They may corrupt your BIOS code, causing your PC to be unstable or even not boot normally.
2. BIOS data will be corrupted if a power loss/surge occurs, or if a user resets the system, or if the power button is pressed during the process of performing a system BIOS upgrade.
3. If a user mistakenly updates their mainboard with the incorrect BIOS file, then the system may not be able to boot correctly. This may cause the PC system hang in operation or during boot.
4. A flash ROM's life cycle is limited according to electronic characteristics. The modern PC utilizes the Plug and Play BIOS, and is updated regularly. If a user changes peripherals often, there is a slight chance of damage to the flash ROM.

With Giga-Byte Technology's patented DualBIOS™ technology you can reduce the possibility of hangs during system boot up, and/or loss BIOS data due to above reasons. This new technology will eliminate valuable system down time and costly repair bills cause by BIOS failures.

III. Q: How does DualBIOS™ technology work?

Answer:

1. DualBIOS™ technology provides a wide range of protection during the boot up procedure. It protects your BIOS during system POST, ESCD update, and even all the way to PNP detection/assignment.
2. DualBIOS™ provides automatic recovery for the BIOS. When the first BIOS used during boot up does not complete or if a BIOS checksum error occurs, boot-up is still possible. In the DualBIOS™ utility, the "Auto Recovery" option will guarantee that if either the main BIOS or backup BIOS is corrupted, the DualBIOS™ technology will use the good BIOS and correct the wrong BIOS automatically.
3. DualBIOS™ provides manual recovery for the BIOS. DualBIOS™ technology contains a built-in flash utility, which can flash your system BIOS from backup to main and/or visa versa. There is no need for an OS-dependent flash utility program.
4. DualBIOS™ contains a one-way flash utility. The built-in one-way flash utility will ensure that the corrupt BIOS is not mistaken as the good BIOS during recovery and that the correct BIOS (main vs. backup) will be flashed. This will prevent the good BIOS from being flashed.

IV. Q: Who Needs DualBIOS™ technology?

Answer:

1. Every user should have DualBIOS™ technology due to the advancement of computer viruses.

Everyday, there are new BIOS-type viruses discovered that will destroy your system BIOS. Most commercial products on the market do not have solutions to guard against this type of virus intrusion. The DualBIOS™ technology will provide a state-of-the-art solution to protect your PC:

Case I.) Vicious computer viruses may wipe out your entire system BIOS. With a conventional single system BIOS PC, the PC will not be functional until it is sent for repairs.

Case II.) If the "Auto Recovery" option is enabled in the DualBIOS™ utility, and if a virus corrupts your system BIOS, the backup BIOS will automatically reboot the system and correct the main BIOS.

Case III.) A user may override booting from the main system BIOS. The DualBIOS™

- utility may be entered to manually change the boot sequence to boot from the backup BIOS.
2. During or after a BIOS upgrade, if DualBIOS™ detects that the main BIOS is corrupt, the backup BIOS will take over the boot-up process automatically. Moreover, it will verify the main and backup BIOS checksums when booting-up. DualBIOS™ technology examines the checksum of the main and backup BIOS while the system is powered on to guarantee your BIOS operates properly.
 3. Power Users will have the advantage of having two BIOS versions on their mainboard. The benefit is being able to select either version BIOS to suit the performance system needs.
 4. Flexibility for high-end desktop PCs and workstation/servers. In the DualBIOS™ utility, the option can be set, "Halt On When BIOS Defects," to be enabled to halt your system with awarning message that the main BIOS has been corrupted. Most workstation/servers require constant operation to guarantee services have not been interrupted. In this situation, the "Halt On When BIOS Defects" message may be disabled to avoid system pauses during normal booting. Another advantage you gain from Giga-Byte's DualBIOS™ technology is the ability to upgrade from dual 2 Mbit BIOS to dual 4 Mbit BIOS in the future if extra BIOS storage is need.



Method 3:

If you don't have DOS boot disk, we recommend that you used Gigabyte @BIOS™ program to flash BIOS.

Follow the setup that showing on the screen to install the Utility.

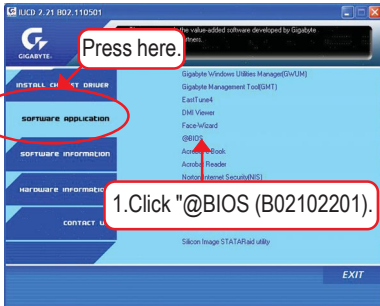

(1)

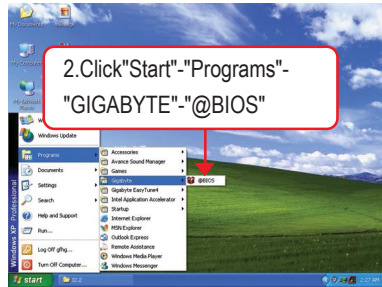

(2)

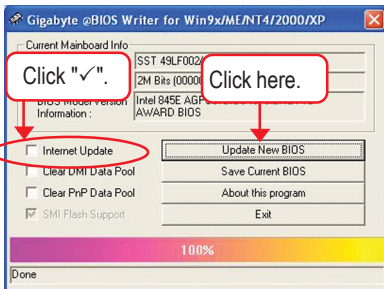

(3)

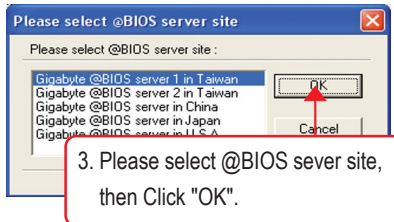

(4)

Methods and steps:

- I. Update BIOS through Internet
 - a. Click "Internet Update" icon
 - b. Click "Update New BIOS" icon
 - c. Select @BIOS™ sever
 - d. Select the exact model name on your motherboard
 - e. System will automatically download and update the BIOS.

II. Update BIOS NOT through Internet:

- a. Do not click "Internet Update" icon
- b. Click "Update New BIOS"
- c. Please select "All Files" in dialog box while opening the old file.
- d. Please search for BIOS unzip file, downloading from internet or any other methods (such as: 8PE667U2.F1).
- e. Complete update process following the instruction.

III. Save BIOS

In the very beginning, there is "Save Current BIOS" icon shown in dialog box. It means to save the current BIOS version.

IV. Check out supported motherboard and Flash ROM:

In the very beginning, there is "About this program" icon shown in dialog box. It can help you check out which kind of motherboard and which brand of Flash ROM are supported.

Note:

- a. In method I, if it shows two or more motherboard's model names to be selected, please make sure your motherboard's model name again. Selecting wrong model name will cause the system unbooted.
- b. In method II, be sure that motherboard's model name in BIOS unzip file are the same as your motherboard's. Otherwise, your system won't boot.
- c. In method I, if the BIOS file you need cannot be found in @BIOS™ server, please go onto Gigabyte's web site for downloading and updating it according to method II.
- d. Please note that any interruption during updating will cause system unbooted

2-/4-/6-Channel Audio Function Intruotion

The installation of windows 98SE/2K/ME/XP is very simple. Please follow next step to install the function!

Stereo Speakers Connection and Settings:

We recommend that you use the speaker with amplifier to acquire the best sound effect if the stereo output is applied.

STEP 1:

Connect the stereo speakers or earphone to "Line Out".

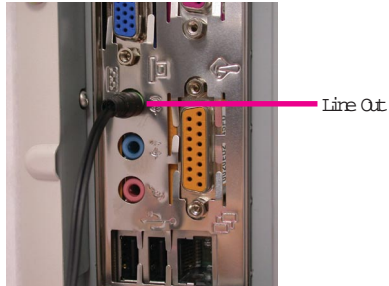

STEP 2 :

After installation of the audio driver, you'll find an  icon on the taskbar's status area. Click the audio icon "Sound Effect" from the windows tray at the bottom of the screen.

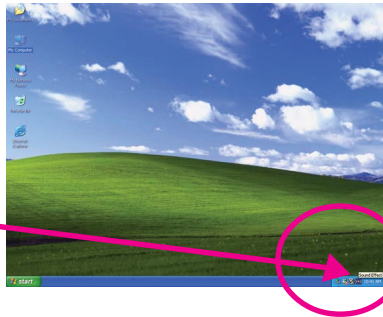
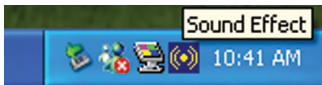

STEP 3:

Select "Speaker Configuration", and choose the "2 channels for stereo speakers output".

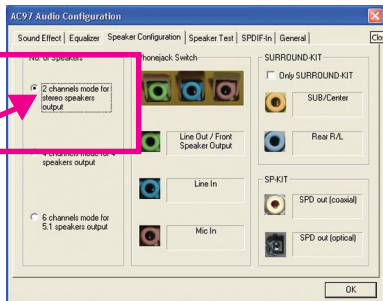

4 Channel Analog Audio Output Mode

STEP 1 :

Connect the front channels to "Line Out", the rear channels to "Line In".

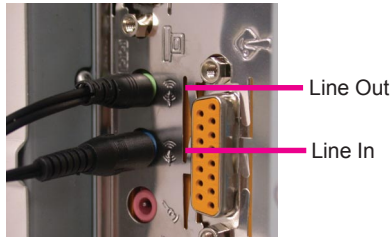

STEP 2 :

After installation of the audio driver, you'll find an icon on the taskbar's status area. Click the audio icon "Sound Effect" from the windows tray at the bottom of the screen.

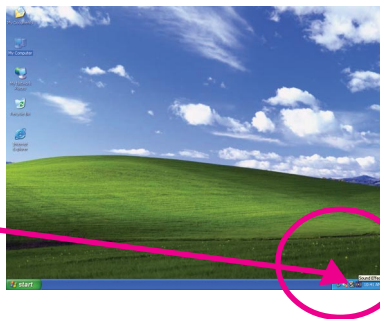
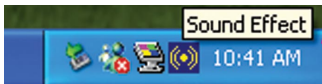

STEP 3 :

Select "Speaker Configuration", and choose the "4 channels for 4 speakers output".

Disable "Only SURROUND-KIT", and press "OK".

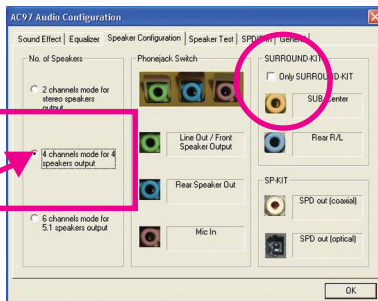

When the "Environment settings" is "None", the sound would be performed as stereo mode (2 channels output). Please select the other settings for 4 channels output.

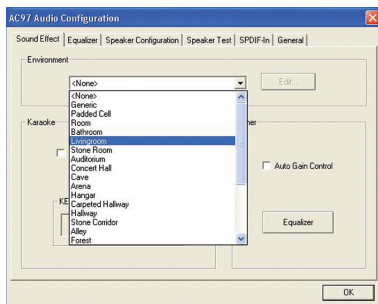

Basic 6 Channel Analog Audio Output Mode

Use the back audio panel to connect the audio output without any additional module.

STEP 1 :

Connect the front channels to "Line Out", the rear channels to "Line In", and the Center/Subwoofer channels to "MIC In".

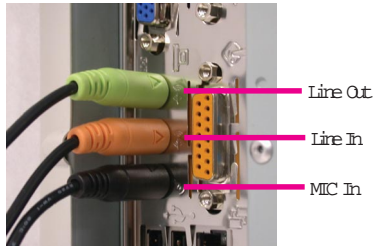

STEP 2 :

After installation of the audio driver, you'll find an  icon on the taskbar's status area. Click the audio icon "Sound Effect" from the windows tray at the bottom of the screen.

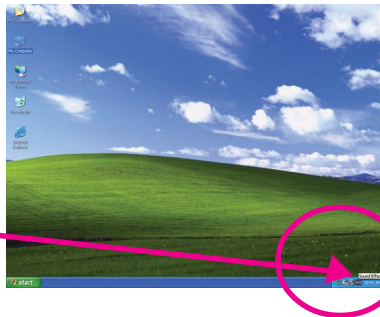
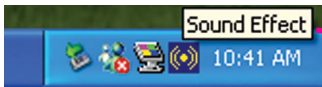

STEP 3 :

Select "Speaker Configuration", and choose the "6 channels for 5.1 speakers output".

Disable "Only SURROUND-KIT" and press "OK"

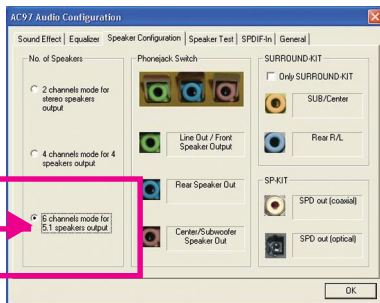

Advanced 6 Channel Analog Audio Output Mode (using Audio Combo Kit,Optional Device):

(Audio Combo Kit provides SPDIF output port : optical & coaxial and SURROUND-KIT : Rear R/L & CEN / Subwoofer)

SURROUND-KIT access analog output to rear channels and Center/Subwoofer channels. It is the best solution if you need 6 channel output, Line In and MIC at the same time. "SURROUND-KIT" is included in the GIGABYTE unique "Audio Combo Kit" as picture.



STEP 1 :

Insert the "Audio Combo Kit" in the back of the case , and fix it with the screw.



STEP 2 :

Connect the "SURROUND-KIT" to SUR_CEN on the M/B.

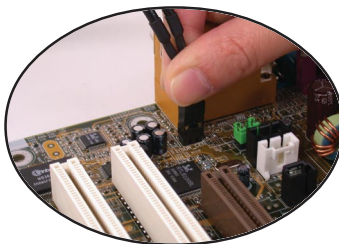
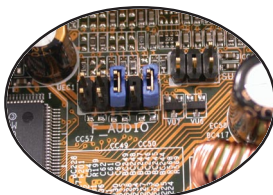

STEP 3 :

Connect the front channels to back audio panel's "Line Out", the rear channels to SURROUND-KIT's REAR R/L, and the Center/Subwoofer channels to SURROUND-KIT's SUB CENTER.

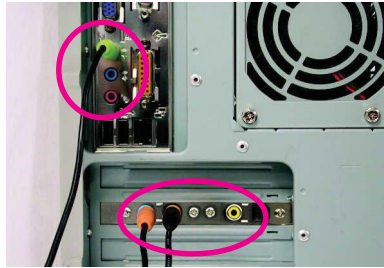

STEP 4 :

Click the audio icon "Sound Effect" from the windows tray at the bottom of the screen.

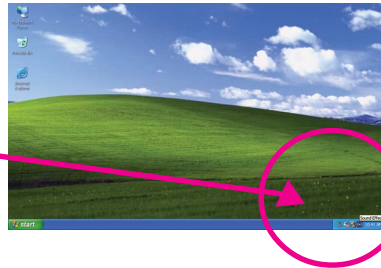
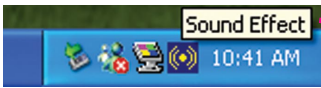

STEP 5 :

Select "Speaker Configuration", and choose the "6 channels for 5.1 speakers output".

Enable "Only SURROUND-KIT" and press "OK".

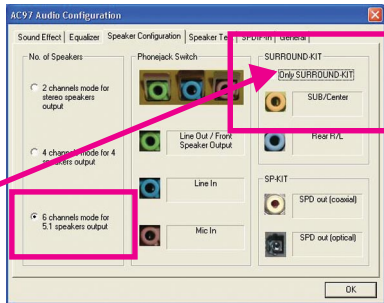

Basic & Advanced 6 Channel Analog Audio Output ModeNotes:

When the "Environment settings" is "None", the sound would be performed as stereo mode(2 channels output). Please select the other settings for 6 channels output.

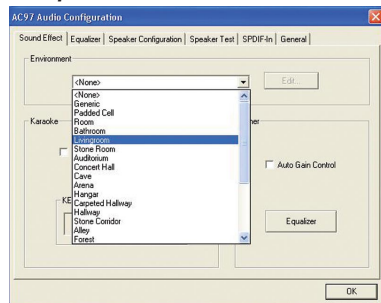

SPDIF Output Device (Optional Device)

A “SPDIF output” device is available on the motherboard. Cable with rear bracket is provided and could link to the “SPDIF output” connector (As picture.) For the further linkage to decoder, rear bracket provides coaxial cable and Fiber connecting port.

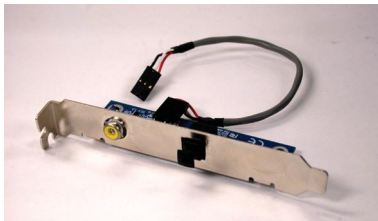

- 1 Connect the SPDIF output device to the rear bracket of PC, and fix it with screw.



2. Connect SPDIF wire to the motherboard.

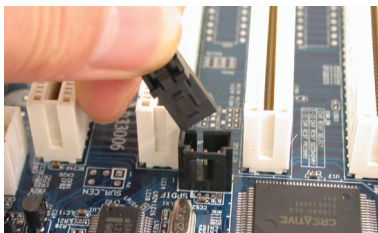

- 3 Connect co-axial or optical output to the SPDIF decoder.

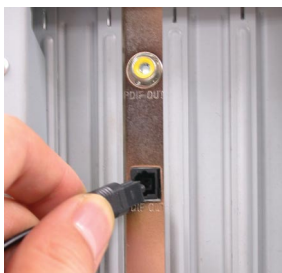

Chapter 5 Appendix

Install Drivers



NOTE

Picture below are shown in Windows XP (IUCD ver 2.21)

Insert the driver CD-title that came with your motherboard into your CD-ROM drive, the driver CD-title will auto start and show the installation guide. If not, please double click the CD-ROM device icon in "My computer", and execute the setup.exe.

INSTALL CHIPSET DRIVER

This page shows the drivers that need to be installed for the system. Click each item to install the driver manually or switch to the  to install the drivers automatically.

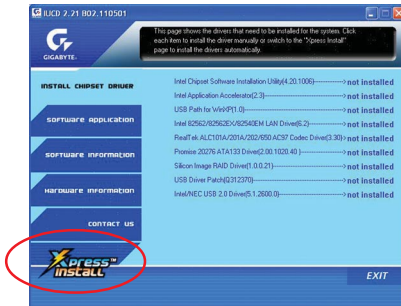

Message: Some device drivers will restart your system automatically. After restarting your system the "Xpress Install" will continue to install other drivers.

The "Xpress Install" uses the "Click and Forget" technology to install the drivers automatically. Just select the drivers you want then click the "GO" button. The  will execute the installation for you by itself.

We recommend that you install all components in the list

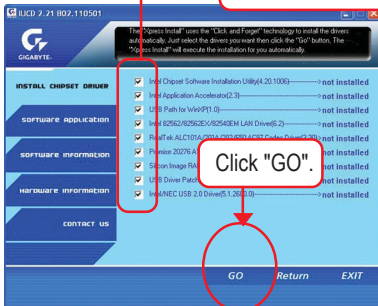

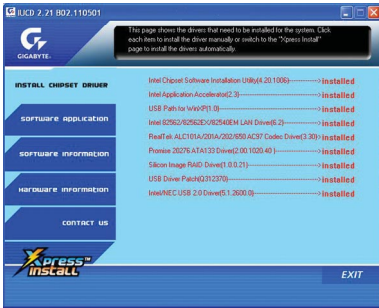

Driver install finished!! you have to reboot system!!

Item Description

- Intel Chipset Software Installation Utility
 - Tell the operating system how the chipset components will be configured
- Intel Application Accelerator
 - Designed to improve performance of the storage sub-system and overall system performance
- USB Path for WinXP
 - This patch driver can help you to resolve the USB device wake up S3 hang up issue in XP
- Intel 82562/82562EX/82540EM LAN Driver
 - For Intel(R) PRO/10/100/1000/Wireless Ethernet connections
- RealTek ALC101A/201A/202/650 AC97 Codec Driver
 - For Intel(R) ICH/ICH2/ICH4 AC97 audio
- Promise 20276 ATA133 Driver / Promise 20276 RAID Driver
 - For Promise 20276 ATA133 or IDE RAID controller Driver
- Silicon Image RAID Driver
 - Serial-ATA RAID Driver from Silicon Image
- USB Driver Patch
 - This patch driver can help you to resolve some USB device issue on XP
- Intel/NEC USB 2.0 Driver
 - It is recommended that you use the Microsoft Windows update for the most updated driver for XP/2K

SOFTWARE APPLICATION

This page reveals the value-added software developed by Gigabyte and its worldwide partners.

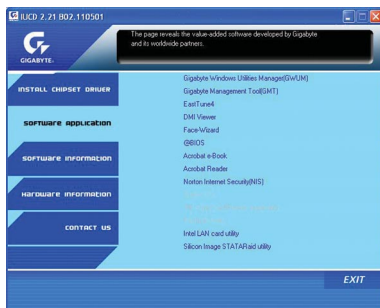

- Gigabyte Windows Utilities Manager (GWUM)
This utility can integrate the Gigabyte's applications in the system tray
- Gigabyte Management Tool (GMT)
A useful tool which can manage the computer via the network
- EastTune4
Powerful utility that integrates the overclocking and hardware monitoring functions
- DMI Viewer
Windows based utility which is used to browse the DMI/SMBIOS information of the system
- Face-Wizard
New utility for adding BIOS logo
- @BIOS
Gigabyte windows flash BIOS utility
- Acrobat e-Book
Useful utility from Adobe
- Acrobat Reader
Popular utility from Adobe for reading .PDF file format documents
- Intel LAN card utility
Utility for Intel(R) PRO/10/100/1000/Wireless Ethernet connections
- Silicon Image SATA RAID utility
RAID utility for Silicon Image Serial-ATA 3112
- Norton Internet Security (NIS)
Integrated utility which includes anti-virus, ad control, etc



Please do not install "Silicon Image SIL3112 SATA RAID Driver Utility" under WIN98 or WIN ME if there is no Serial ATA Device.

For top performance and compatibility, it is recommend to use the SATA daughter Card which has Silicon Image Chipset.

SOFTWARE INFORMATION

This page list the contents of softwares and drivers in this CD title.

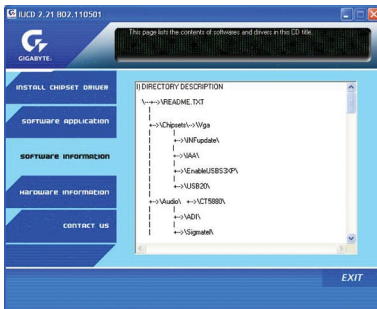

HARDWARE INFORMATION

This page lists all device you have for this motherboard.

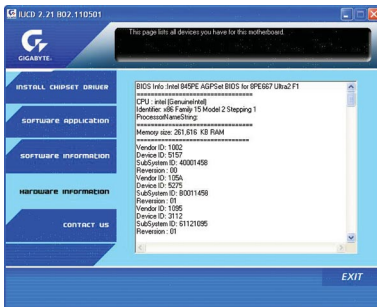

CONTACT US

Contact us via the information in this page all over the world.



- Taiwan

Gigabyte Technology Co., Ltd.

Address: No.6, Bau Chiang Road, Hsin-Tien, Taipei Hsien, Taiwan, R.O.C.

TEL: 886 (2) 8912-4888 (50 lines)

FAX: 886 (2) 8912-4004

E-mail: english@gigabyte.com.tw

Web Address: <http://www.gigabyte.com.tw>

- USA

G.B.T. INC.

Address: 17358 Railroad St, City of Industry, CA 91748.

Tel: 1 (626) 854-9338

Fax: 1 (626) 854-9339

E-mail: sales@giga-byte.com

support@giga-byte.com

Web Address: www.giga-byte.com

- Germany

G.B.T. Technology Trading GmbH

Tel: 49-40-2533040

Fax: 49-40-25492343 (Sales)

Tel: 49-01803-428468 (Tech.)

Fax: 49-01803-428329 (Tech.)

E-mail: support@gigabyte.de

Web Address: www.gigabyte.de

- JAPAN

Nippon Giga-Byte Corporation

Fax: 81-3-5791-5439

Web Address: www.gigabyte.co.jp

- U.K

G.B.T. TECH. CO. LTD.

Tel: 44-1908-362700

Fax: 44-1908-362709

E-mail: support@gbt-tech.co.uk

Web Address: www.gbt-tech.co.uk

- The Netherlands

Giga-Byte Technology B.V.

Address: Postbus 1385, 5602 BJ, Eindhoven, The Netherlands

Tel: +31 40 290 2088

Fax: +31 40 290 2089

E-mail: info@giga-byte.nl

Web Address: <http://www.giga-byte.nl>

- China

Shanghai Office

Tel: 86-21-64737410

Fax: 86-21-64453227

Web Address: www.gigabyte.com.cn

GuangZhou Office

Tel: 86-20-87586273

Fax: 86-20-87544306

Web Address: www.gigabyte.com.cn

Beijing Office

Tel: 86-10-82856054

86-10-82856064

86-10-82856094

Fax: 86-10-82856575

Web Address: www.gigabyte.com.cn

E-mail: bjsupport@gigabyte.com.cn

Chengdu Office

Tel: 86-28-85236930

Fax: 86-28-85256822

Web Address: www.gigabyte.com.cn

Acronyms

| Acronyms | Meaning |
|----------|--|
| ACPI | Advanced Configuration and Power Interface |
| APM | Advanced Power Management |
| AGP | Accelerated Graphics Port |
| AMR | Audio Modem Riser |
| ACR | Advanced Communications Riser |
| BIOS | Basic Input / Output System |
| CPU | Central Processing Unit |
| CMOS | Complementary Metal Oxide Semiconductor |
| CRIMM | Continuity RIMM |
| CNR | Communication and Networking Riser |
| DMA | Direct Memory Access |
| DMI | Desktop Management Interface |
| DIMM | Dual Inline Memory Module |
| DRM | Dual Retention Mechanism |
| DRAM | Dynamic Random Access Memory |
| DDR | Double Data Rate |
| ECP | Extended Capabilities Port |
| ESCD | Extended System Configuration Data |
| ECC | Error Checking and Correcting |
| EMC | Electromagnetic Compatibility |
| EPP | Enhanced Parallel Port |
| ESD | Electrostatic Discharge |
| FDD | Floppy Disk Device |
| FSB | Front Side Bus |
| HDD | Hard Disk Device |
| IDE | Integrated Dual Channel Enhanced |
| IRQ | Interrupt Request |

to be continued.....

| Acronyms | Meaning |
|----------|---|
| IOAPIC | Input Output Advanced Programmable Input Controller |
| ISA | Industry Standard Architecture |
| LAN | Local Area Network |
| I/O | Input / Output |
| LBA | Logical Block Addressing |
| LED | Light Emitting Diode |
| MHz | Megahertz |
| MIDI | Musical Instrument Digital Interface |
| MTH | Memory Translator Hub |
| MPT | Memory Protocol Translator |
| NIC | Network Interface Card |
| OS | Operating System |
| OEM | Original Equipment Manufacturer |
| PAC | PCI A.G.P. Controller |
| POST | Power-On Self Test |
| PCI | Peripheral Component Interconnect |
| RIMM | Rambus in-line Memory Module |
| SCI | Special Circumstance Instructions |
| SECC | Single Edge Contact Cartridge |
| SRAM | Static Random Access Memory |

Technical Support/RMA Sheet

| | | |
|-------------------|---------------|------------|
| Customer/Country: | Company: | Phone No.: |
| Contact Person: | E-mail Add. : | |

| | |
|------------------------|---------------|
| Model name/Lot Number: | PCB revision: |
| BIOS version: | O.S./A.S.: |

| Hardware Configuration | Mfs. | Model name | Size: | Driver/Utility: |
|------------------------|------|------------|-------|-----------------|
| CPU | | | | |
| Memory Brand | | | | |
| Video Card | | | | |
| Audio Card | | | | |
| HDD | | | | |
| CD-ROM / DVD-ROM | | | | |
| Modem | | | | |
| Network | | | | |
| AMR / CNR | | | | |
| Keyboard | | | | |
| Mouse | | | | |
| Power supply | | | | |
| Other Device | | | | |
| | | | | |
| | | | | |
| | | | | |

Problem Description:

Troubleshooting



If you encounter any trouble during boot up, please follow the troubleshooting procedures .

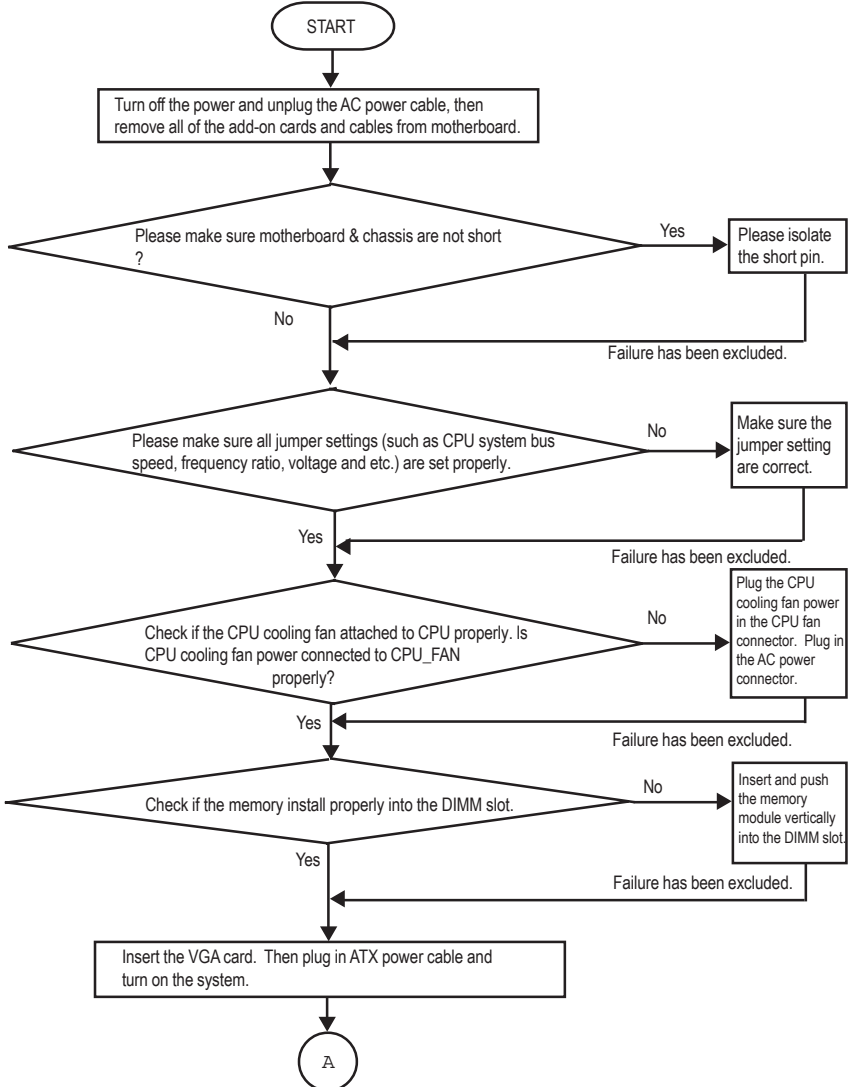

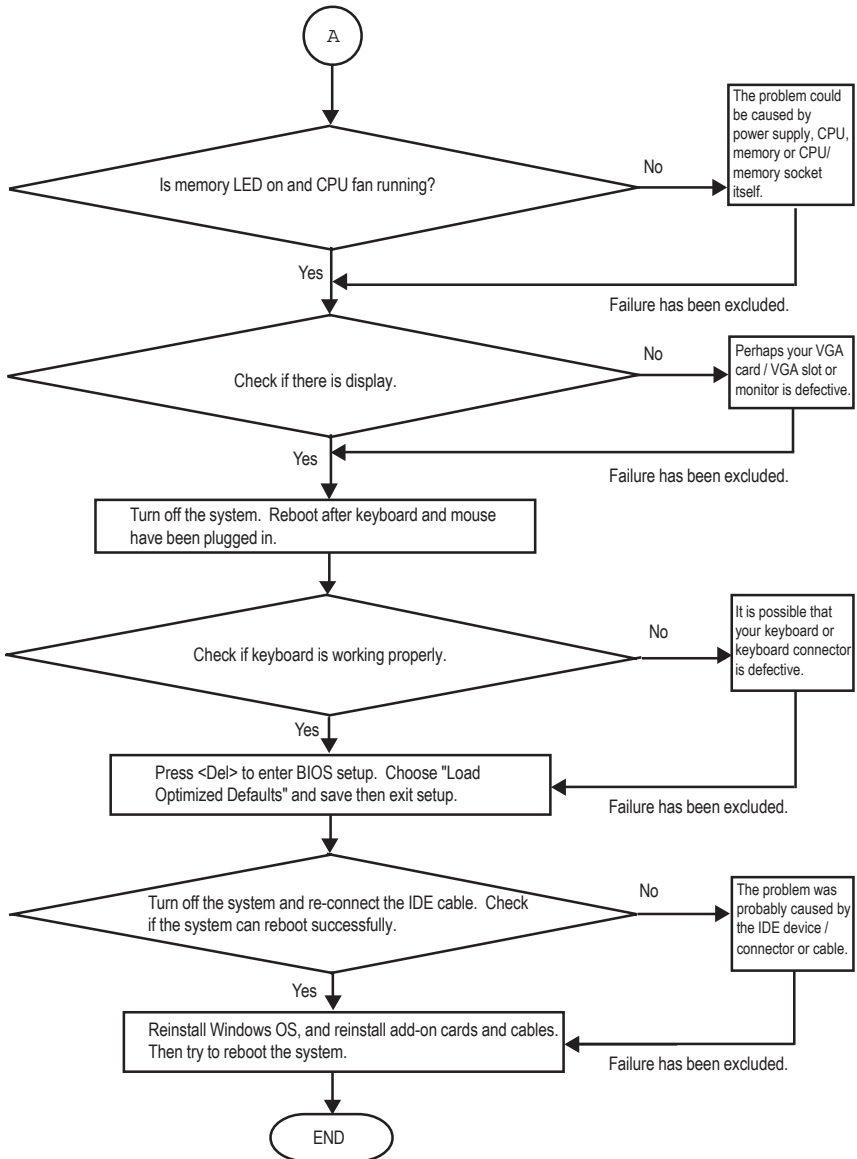

If the above procedure unable to solve your problem, please contact with your local retailer or national distributor for help. Or, you could submit your question to the service mail via Gigabyte website technical support zone (<http://www.gigabyte.com.tw>). The appropriate response will be provided ASAP.

Free Manuals Download Website

<http://myh66.com>

<http://usermanuals.us>

<http://www.somanuals.com>

<http://www.4manuals.cc>

<http://www.manual-lib.com>

<http://www.404manual.com>

<http://www.luxmanual.com>

<http://aubethermostatmanual.com>

Golf course search by state

<http://golfingnear.com>

Email search by domain

<http://emailbydomain.com>

Auto manuals search

<http://auto.somanuals.com>

TV manuals search

<http://tv.somanuals.com>