

7VT600-RZ / 7VT600-RZ-C

AMD Athlon™ / Athlon™ XP / Duron™ Socket A Processor Motherboard

User's Manual

Rev. 1003

12ME-7VT600RZ-1003

Copyright

© 2004 GIGABYTE TECHNOLOGY CO., LTD

Copyright by GIGA-BYTE TECHNOLOGY CO., LTD. ("GBT"). No part of this manual may be reproduced or transmitted in any form without the expressed, written permission of GBT.

Trademarks

Third-party brands and names are the property of their respective owners.

Notice

Please do not remove any labels on motherboard, this may void the warranty of this motherboard.

Due to rapid change in technology, some of the specifications might be out of date before publication of this booklet.

The author assumes no responsibility for any errors or omissions that may appear in this document nor does the author make a commitment to update the information contained herein.

DECLARATION OF CONFORMITY

Per FCC Part 2 Section 2.1077(a)



Responsible Party Name: G.B.T. INC. (U.S.A.)

Address: 17358 Railroad Street

City of Industry, CA 91748

Phone/Fax No: (818) 854-9338/ (818) 854-9339

herby declares that the product

Product Name: Motherboard

Model Number: 7VT600-RZ

Conforms to the following specifications:

FCC Part 15, Subpart B, Section 15.107(a) and Section 15.109

(e), Class B Digital Device

Supplementary Information:

This device complies with part 15 of the FCC Rules. Operation is subject to the following two conditions: (1) This device may not cause harmful and (2) this device must accept any interference received, including that may cause undesired operation.

Representative Person's Name: ERIC LIU

Signature: *Eric Liu*

Date: Feb. 20, 2004

Declaration of Conformity

G.B.T. INC. (U.S.A.)
17358 Railroad Street
Industry, CA 91748

(Resident of the signatory, I declare to which the signatory

declares that he is a

Mother Board

7VT600-RZ

is a family with

products for the application of the conformity's declared

F. Declaration with CE-EMC Directive

EMC Directive

EMC Directive

EMC Directive

EMC Directive

EMC Directive

EMC Directive

EMC Directive

EMC Directive

EMC Directive

EMC Directive

EMC Directive

EMC Directive

EMC Directive

EMC Directive

EMC Directive

EMC Directive

EMC Directive

EMC Directive

EMC Directive

EMC Directive

EMC Directive

EMC Directive

EMC Directive

EMC Directive

EMC Directive

EMC Directive

EMC Directive

EMC Directive

EMC Directive

EMC Directive

EMC Directive

EMC Directive

EMC Directive

EMC Directive

EMC Directive

EMC Directive

EMC Directive

EMC Directive

EMC Directive

EMC Directive

EMC Directive

EMC Directive

EMC Directive



The manufacturer has declared the conformity of the above named product

with the standard required (EMC standards) in accordance with CE marking

EMC Directive

EMC Directive

EMC Directive

EMC Directive

EMC Directive

EMC Directive

EMC Directive

EMC Directive

EMC Directive

EMC Directive

EMC Directive

EMC Directive

EMC Directive

Signature: *Eric Liu*

Name: *Eric Liu*

Date: Feb. 20, 2004

Signature: *Eric Liu*

Name: *Eric Liu*

Date: Feb. 20, 2004

Signature: *Eric Liu*

Name: *Eric Liu*

Date: Feb. 20, 2004

Preparing Your Computer

Computer motherboards and expansion cards contain very delicate Integrated Circuit (IC) chips. To protect them against damage from static electricity, you should follow some precautions whenever you work on your computer.

1. Unplug your computer when working on the inside.
2. Use a grounded wrist strap before handling computer components. If you do not have one, touch both of your hands to a safely grounded object or to a metal object, such as the power supply case.
3. Hold components by the edges and try not to touch the IC chips, leads or connectors, or other components.
4. Place components on a grounded antistatic pad or on the bag that came with the components whenever the components are separated from the system.
5. Ensure that the ATX power supply is switched off before you plug in or remove the ATX power connector on the motherboard.



Installing the motherboard to the chassis

If the motherboard has mounting holes, but they don't line up with the holes on the base and there are no slots to attach the spacers, do not become alarmed you can still attach the spacers to the mounting holes. Just cut the bottom portion of the spacers (the spacer may be a little hard to cut off, so be careful of your hands). In this way you can still attach the motherboard to the base without worrying about short circuits. Sometimes you may need to use the plastic springs to isolate the screw from the motherboard PCB surface, because the circuit wire may be near by the hole. Be careful, don't let the screw contact any printed circuit write or parts on the PCB that are near the fixing hole, otherwise it may damage the board or cause board malfunctioning.

Table of Content

Chapter 1 Introduction	5
Features Summary	5
7VT600-RZ Series Motherboard Layout	7
Block Diagram	8
Hardware Installation Process	9
Step 1: Set System Jumper (JP1)	9
Step 2: Install the Central Processing Unit (CPU)	10
Step 2-1: CPU Installation	10
Step 2-2: CPU Cooling Fan Installation	10
Step 3: Install Memory Modules	11
Step 4: Install Expansion Cards	12
Step 5: Install I/O Peripherals Cables	12
Step 5-1: I/O Back Panel Introduction	12
Step 5-2: Connectors Introduction	13
 Chapter 2 BIOS Setup	 21
The Main Menu (For example: BIOS Ver. : F4c)	21
Standard CMOS Features	23
Advanced BIOS Features	25
Integrated Peripherals	26
Power Management Setup	28
PnP/PCI Configurations	30
PCI Health Status	31
Frequency/Voltage Control	32
Load Fail-Safe Defaults	34
Load Optimized Defaults	34
Set Supervisor/User Password	35
Save & Exit Setup	36
Exit Without Saving	36
 Chapter 3 Install Drivers	 37

Chapter 1 Introduction

Features Summary

CPU	<ul style="list-style-type: none"> • Socket A processor AMD Athlon™/ Athlon™ XP/ Duron™ (K7) 128K L1 & 512K/256K/64K L2 cache on die 200/266/333/400 MHz FSB • Supports 1.4GHz and faster
Chipset	<ul style="list-style-type: none"> • North Bridge: VIA KT600 • South Bridge: VIA VT8235
Memory	<ul style="list-style-type: none"> • 3 184-pin DDR sockets • Supports DDR DRAM PC2100/PC2700/PC3200 • Supports up to 3.0GB DDR (Max) • Supports only 2.5V DDR DIMM
Slots	<ul style="list-style-type: none"> • 1 AGP slot supports 8X/4X mode(1.5V) • 5 PCI slots supports 33MHz & PCI 2.2 compliant
On-Board IDE	<ul style="list-style-type: none"> • 2 IDE controllers provides IDE HDD/CD-ROM (IDE1, IDE2) with PIO, Bus Master (Ultra DMA33/ATA66/ATA100/ATA133) operation mode
On-Board Floppy	<ul style="list-style-type: none"> • Floppy port supports 2 FDD with 360K, 720K, 1.2M, 1.44M and 2.88M bytes
On-Board Peripherals	<ul style="list-style-type: none"> • 1 Parallel port supports Normal/EPP/ECP mode • 2 Serial port (COMA & COMB) • 6 x USB 2.0/1.1 (4 by cable) • PS/2 Keyboard interface and PS/2 Mouse interface
On-Board LAN *	<ul style="list-style-type: none"> • VIA VT6103L • 1 RJ45 port
On-Board Sound	<ul style="list-style-type: none"> • Realtek ALC655 CODEC • Supports Jack Sensing function • Line Out / 2 front speaker • Line In / 2 rear speaker(by s/w switch) • Mic In / center & subwoofer(by s/w switch) • SPDIF Out / SPDIF In • CD In / AUX In / Game Port
On-Board USB 2.0	<ul style="list-style-type: none"> • Built in VIA VT8235 Chipset
BIOS	<ul style="list-style-type: none"> • Licensed Award BIOS • Supports Q-Flash
I/O Control	<ul style="list-style-type: none"> • IT8705
Hardware Monitor	<ul style="list-style-type: none"> • CPU/System Fan Revolution detect • CPU/System temperature detect • System voltage detect • CPU/System fan fail warning • Thermal shutdown function

* * Support 7VT600-RZ only.

Additional Features	<ul style="list-style-type: none">• PS/2 Keyboard power on by password,• PS/2 Mouse power on by double click• External Modem wake up• STR(Suspend-To-RAM)• AC Recovery• Poly fuse for keyboard over-current protection• USB KB/Mouse wake up from S3• Supports @BIOS• Supports EasyTune 4
Overclocking	<ul style="list-style-type: none">• Over Voltage (CPU/AGP/DDR/PCI) by BIOS• Over Clock (CPU/AGP/DDR/PCI) by BIOS
Form Factor	<ul style="list-style-type: none">• 30.5cm x 20.0cm ATX size form factor, 4 layers PCB.



Please set the CPU host frequency in accordance with your processor's specifications.

We don't recommend you to set the system bus frequency over the CPU's specification because these specific bus frequencies are not the standard specifications for CPU, chipset and most of the peripherals. Whether your system can run under these specific bus frequencies properly will depend on your hardware configurations, including CPU, Memory, Cards...etc.

7VT600-RZ Series Motherboard Layout

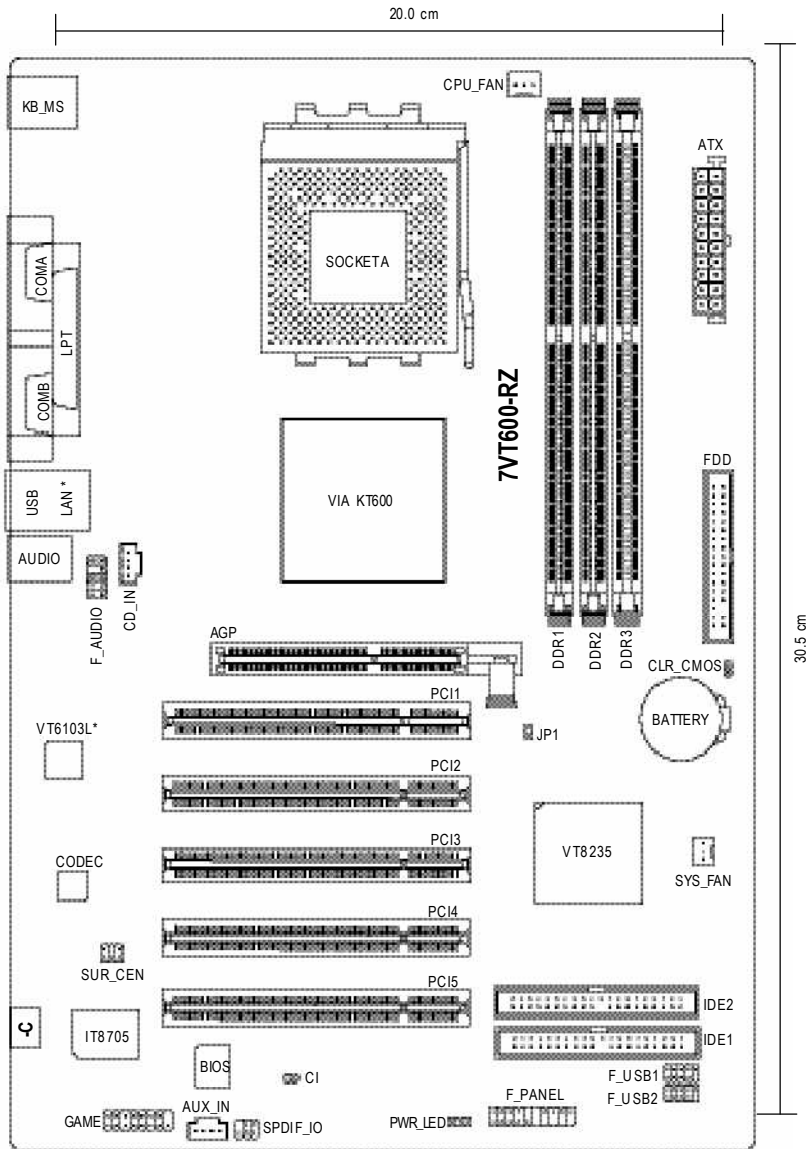

** * Support 7VT600-RZ only.

Block Diagram

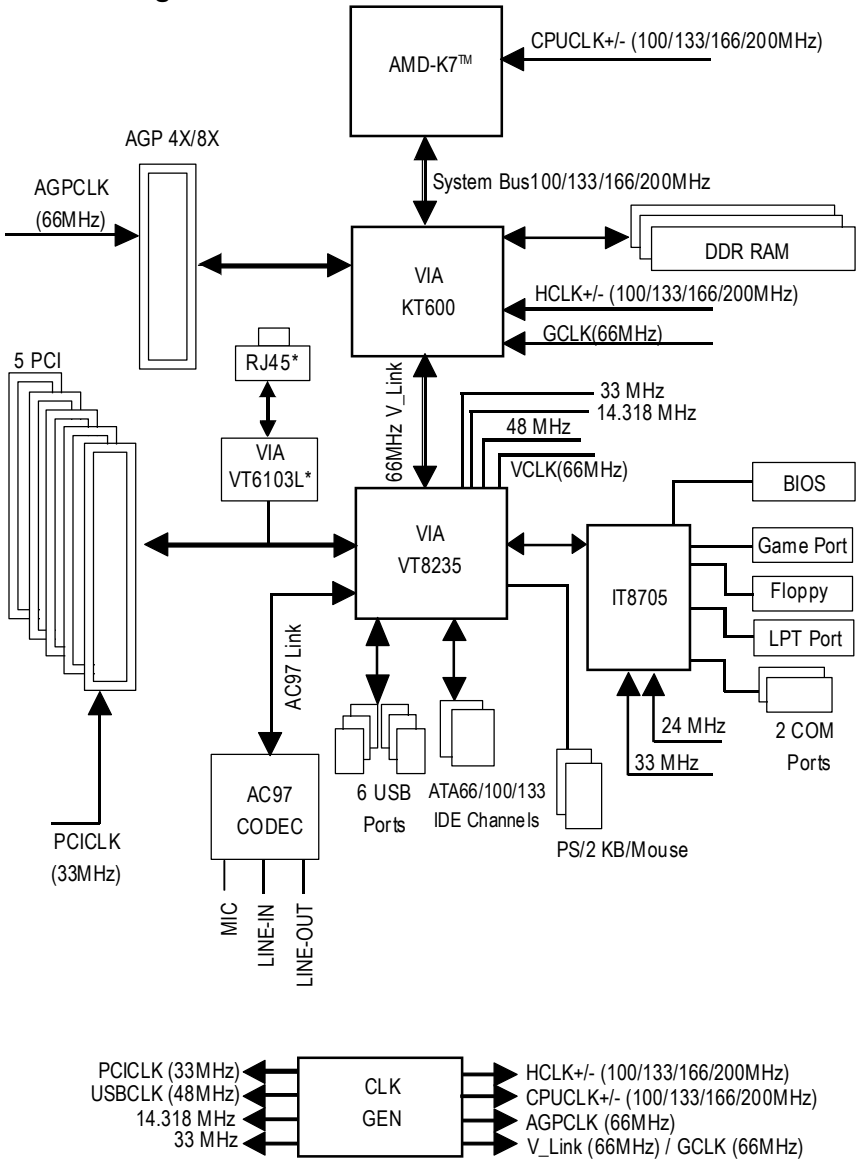

*** Support 7VT600-RZ only.

Hardware Installation Process

To set up your computer, you must complete the following steps:

- Step 1- Set System Jumper (JP1)
- Step 2- Install the Central Processing Unit (CPU)
- Step 3- Install memory modules
- Step 4- Install expansion cards
- Step 5- Install I/O Peripherals cables

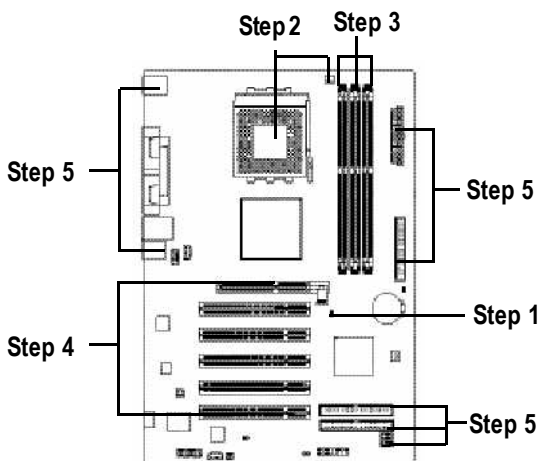

Step 1: Set System Jumper (JP1)

The system bus frequency can be switched at 100/133/166/200MHz by adjusting system jumper (JP1).
(The internal frequency depend on CPU.)

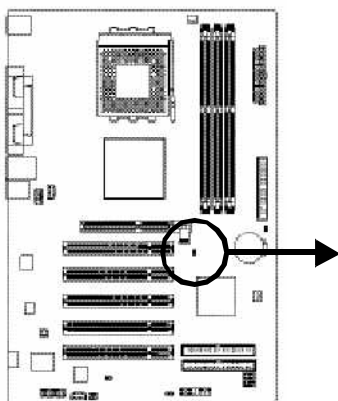

 Open: Auto

 Close: 100MHz (Default)

JP1	CPU CLOCK	
	100MHz	Auto
1-2	Close	Open



100MHz : Fix FSB 200MHz CPU

Auto : Support FSB 266/333/400 MHz CPU

The "JP1" must set to "Auto" when you are using FSB 266/333/400MHz CPU.

Step 2: Install the Central Processing Unit (CPU)



Before installing the processor, adhere to the following warning:

1. Please make sure the CPU type is supported by the motherboard.
2. The processor will overheat without the heatsink and/or fan, resulting in permanent irreparable damage.
3. If you do not match the CPU socket Pin 1 and CPU cut edge well, it will cause improper installation. Please change the insert orientation.
4. Apply thermal grease between the processor and cooling fan.
5. Never run the processor without the heatsink properly and firmly attached. Permanent damage will result.
6. Please set the CPU host frequency in accordance with your processor's specifications. We don't recommend you to set the system bus frequency over the CPU's specification because these specific bus frequencies are not the standard specifications for CPU, chipset and most of the peripherals. Whether your system can run under these specific bus frequencies properly will depend on your hardware configurations, including CPU, Memory, Cards...etc.

Step 2-1: CPU Installation

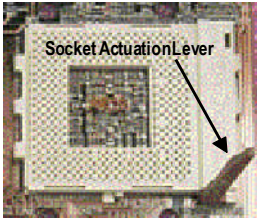

Figure 1.
Pull the rod to the 90-degree directly.

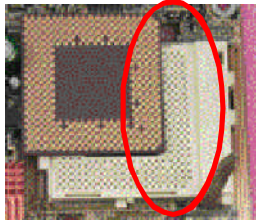

Figure 2.
Locate Pin 1 in the socket and look for a (golden) cut edge on the CPU upper corner. Insert the CPU into the socket. (Do not force the CPU into the socket.) Then move the socket lever to the locked position while holding pressure on the center of the CPU.

Step 2-2: CPU Cooling Fan Installation



Figure 1.
Apply the thermal tape(or grease) to provide better heat conduction between your CPU and cooling fan.

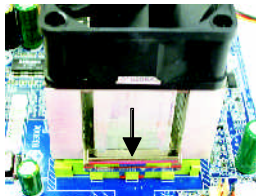

Figure 2.
Fasten the cooling fan supporting-base onto the CPU socket on the motherboard.

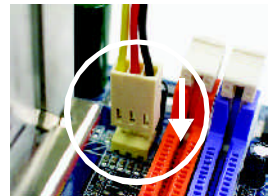

Figure 3.
Make sure the CPU fan is plugged to the CPU fan connector, than the install completely.

Step 3: Install Memory Modules



Before installing the memory modules, adhere to the following warning:

1. When DIMM LED is ON, do not install / remove DIMM from socket.
2. Please note that the DIMM module can only fit in one direction due to the one notch. Wrong orientation will cause improper installation. Please change the insert orientation.

The motherboard has 3 dual inline memory module (DIMM) sockets. The BIOS will automatically detect memory type and size. To install the memory module, just push it vertically into the DIMM socket. The DIMM module can only fit in one direction due to the notch. Memory size can vary between sockets.

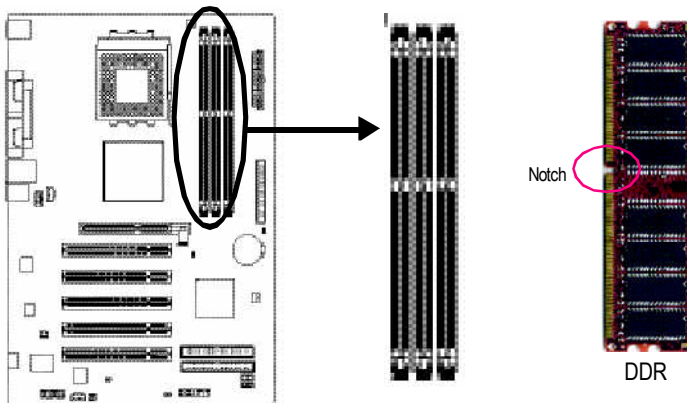

Support Unbuffered DDR DIMM Sizes type:

64 Mbit (2Mx8x4 banks)	64 Mbit (1Mx16x4 banks)	128 Mbit (4Mx8x4 banks)
128 Mbit (2Mx16x4 banks)	256 Mbit (8Mx8x4 banks)	256 Mbit (4Mx16x4 banks)
512 Mbit (16Mx8x4 banks)	512 Mbit (8Mx16x4 banks)	
Total System Memory (Max3GB)		



1. The DIMM socket has a notch, so the DIMM memory module can only fit in one direction.



2. Insert the DIMM memory module vertically into the DIMM socket. Then push it down.



3. Close the plastic clip at both edges of the DIMM sockets to lock the DIMM module. Reverse the installation steps when you wish to remove the DIMM module.

Step 4: Install Expansion Cards

1. Read the related expansion card's instruction document before install the expansion card into the computer.
2. Please make sure your AGP card is AGP 4X/8X (1.5V).



3. Please carefully pull out the small white- drawbar at the end of the AGP slot when you try to install/ Uninstall the AGP card. Please align the AGP card to the onboard AGP slot and press firmly down on the slot .Make sure your AGP card is locked by the small white- drawbar.

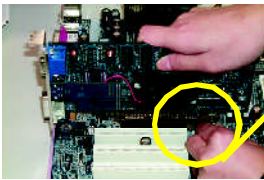

AGP Card



Step 5: Install I/O Peripherals Cables

Step 5-1: I/O Back Panel Introduction

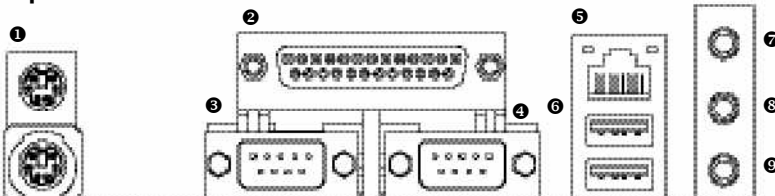

- ❶ **PS/2 Keyboard and PS/2 Mouse connector**
This connector supports standard PS/2 keyboard and PS/2 mouse.
- ❷ **Parallel port (LPT)**
Device like printer can be connected to Parallel port.
- ❸/❹ **Serial ports (COMA / COMB)**
Mouse and modem etc. can be connected to Serial port.
- ❺ **LAN port ***
LAN is fast Ethernet with 10/100Mbps speed.
- ❻ **USB port**
Before you connect your device(s) into USB connector(s), please make sure your device(s) such as USB keyboard, mouse, scanner, zip, speaker...etc. Have a standard USB interface. Also make sure your OS supports USB controller. If your OS does not support USB controller, please contact OS vendor for possible patch or driver upgrade. For more information please contact your OS or device(s) vendors.

* * * Support 7VT600-RZ only.

7 Line In jack

Devices like CD-ROM, walkman etc. can be connect to Line In jack.

8 Line Out jack

Connect the stereo speakers or earphone to this connector.

9 MIC In jack

Microphone can be connect to MIC In jack.

After installation of the audio driver, you are able to use 2/4/6-channel audio feature by software selection. You can connect "Front speaker" to "Line Out" jack, Connect "Rear speaker" to "Line In" jack and connect "Center/Subwoofer" to "MIC In" jack.

Step 5-2: Connectors Introduction

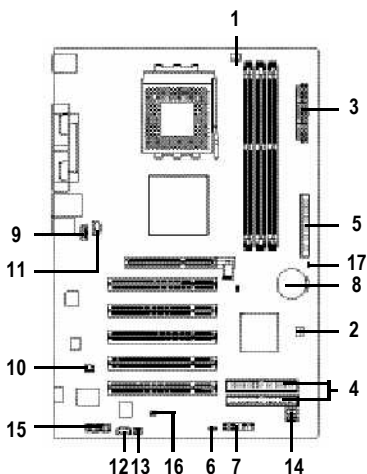

1) CPU_FAN	10) SUR_CEN
2) SYS_FAN	11) CD_IN
3) ATX(ATX Power)	12) AUX_IN
4) IDE1 / IDE2	13) SPDIF_IO
5) FDD	14) F_USB1 / F_USB2
6) PWR_LED	15) GAME
7) F_PANEL	16) CI (Case Open)
8) BATTERY	17) CLR_CMOS
9) F_AUDIO	

1) CPU_FAN (CPU FAN Connector)

Please note, a proper installation of the CPU cooler is essential to prevent the CPU from running under abnormal condition or damaged by overheating. The CPU fan connector supports Max. current up to 600 mA.

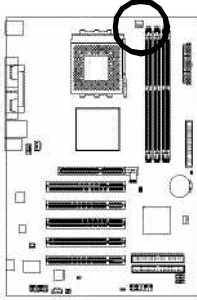

Pin No.	Definition
1	GND
2	+12V
3	Sense

2) SYS_FAN (System FAN Connector)

This connector allows you to link with the cooling fan on the system case to lower the system temperature.

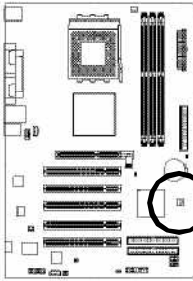

Pin No.	Definition
1	GND
2	+12V
3	Sense

3) ATX (ATX Power Connector)

AC power cord should only be connected to your power supply unit after ATX power cable and other related devices are firmly connected to the mainboard.

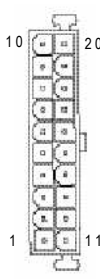
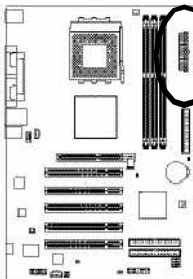

Pin No.	Definition	Pin No.	Definition
1	3.3V	11	3.3V
2	3.3V	12	-12V
3	GND	13	GND
4	VCC	14	PS_ON(soft on/off)
5	GND	15	GND
6	VCC	16	GND
7	GND	17	GND
8	Power Good	18	-5V
9	5V SB (stand by +5V)	19	VCC
10	+12V	20	VCC

4) IDE1/ IDE2(IDE1//IDE2 Connector)

Please connect first harddisk to IDE1 and connect CDRROM to IDE2. The red stripe of the ribbon cable must be the same side with the Pin1.

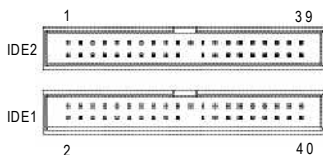
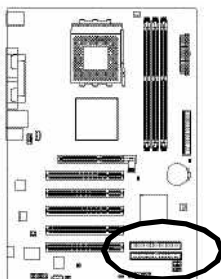

5) FDD (Floppy Connector)

Please connect the floppy drive ribbon cables to FDD. It supports 360K,720K,1.2M,1.44M and 2.88Mbytes floppy disk types. The red stripe of the ribbon cable must be the same side with the Pin1.

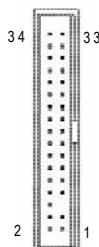
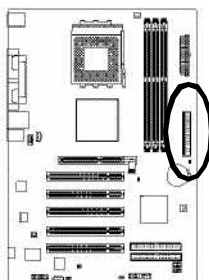

6) PWR_LED

PWR_LED is connect with the system power indicator to indicate whether the system is on/off. It will blink when the system enters suspend mode. If you use dual color LED, power LED will turn to another color.

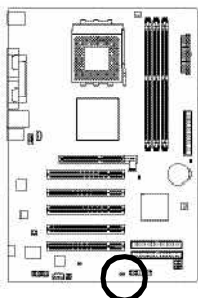

Pin No.	Definition
1	MPD+
2	MPD-
3	MPD-

7) F_PANEL (2 x 10 pins Connector)

Please connect the power LED, PC speaker, reset switch and power switch etc. of your chassis front panel to the F_PANEL connector according to the pin assignment below.

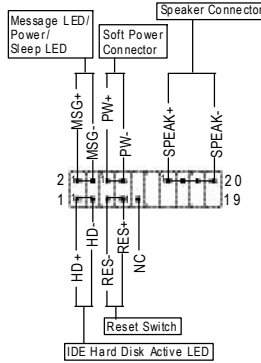
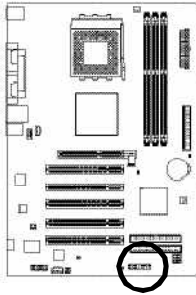

HD (IDE Hard Disk Active LED)	Pin 1: LED anode(+) Pin 2: LED cathode(-)
SPK (Speaker Connector)	Pin 1: VCC(+) Pin 2- Pin 3: NC Pin 4: Data(-)
RST (Reset Switch)	Open: Normal Operation Close: Reset Hardware System
PW (Soft Power Connector)	Open: Normal Operation Close: Power On/Off
MPD (Message LED/Power/Sleep LED)	Pin 1: LED anode(+) Pin 2: LED cathode(-)
NC	NC

8) BATTERY (Battery)

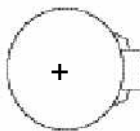
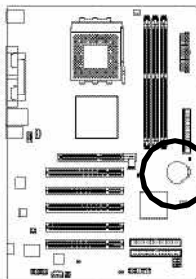

CAUTION

- ❖ Danger of explosion if battery is incorrectly replaced.
- ❖ Replace only with the same or equivalent type recommended by the manufacturer.
- ❖ Dispose of used batteries according to the manufacturer's instructions.

If you want to erase CMOS...

1. Turn off the computer and unplug the power cord.
2. Remove the battery, wait for 30 second.
3. Re-install the battery.
4. Plug the power cord and turn on the computer.

9) F_AUDIO (Front Audio Connector)

If you want to use Front Audio connector, you must remove 5-6, 9-10 Jumper.

In order to utilize the front audio header, your chassis must have front audio connector. Also please make sure the pin assignment on the cable is the same as the pin assignment on the MB header. To find out if the chassis you are buying support front audio connector, please contact your dealer. Please note, you can have the alternative of using front audio connector or of using rear audio connector to play sound.

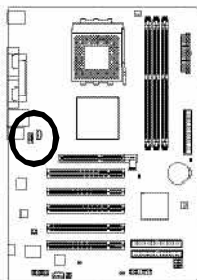

Pin No.	Definition
1	MIC
2	GND
3	REF
4	Power
5	FrontAudio (R)
6	RearAudio (R)
7	Resevod
8	No Pin
9	FrontAudio (L)
10	RearAudio (L)

10) SUR_CEN (Surround Center Connector)

Please contact your nearest dealer for optional SUR_CEN cable.

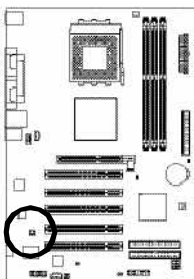

Pin No.	Definition
1	SUROUTL
2	SUROUTR
3	GND
4	No Pin
5	CENTER_OUT
6	BASS_OUT

11) CD_IN (CD In Connector)

Connect CD-ROM or DVD-ROM audio out to the connector.

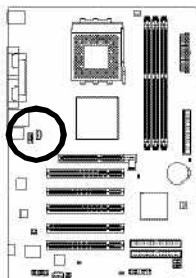

Pin No.	Definition
1	CD-L
2	GND
3	GND
4	CD-R

12) AUX_IN (AUX In Connector)

Connect other device (such as PCI TV Tunner audio out)to the connector.

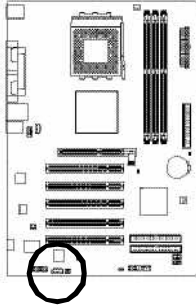

Pin No.	Definition
1	AUX-L
2	GND
3	GND
4	AUX-R

13) SPDIF_IO (SPDIF In/Out Connector)

The SPDIF output is capable of providing digital audio to external speakers or compressed AC3 data to an external Dolby Digital Decoder. Use this feature only when your stereo system has digital input and output function. Use SPDIF in feature only when your device has digital output function. Be careful with the polarity of the SPDIF_IO connector. Check the pin assignment carefully while you connect the SPDIF cable, incorrect connection between the cable and connector will make the device unable to work or even damage it. For optional SPDIF cable, please contact your local dealer.

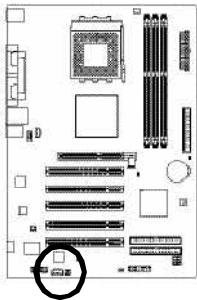

Pin No.	Definition
1	VCC
2	No Pin
3	SPDIF
4	SPDIFI
5	GND
6	GND

14) F_USB1 / F_USB2 (Front USB Connector)

Be careful with the polarity of the F_USB connector. Check the pin assignment carefully while you connect the F_USB cable, incorrect connection between the cable and connector will make the device unable to work or even damage it. For optional F_USB cable, please contact your local dealer.

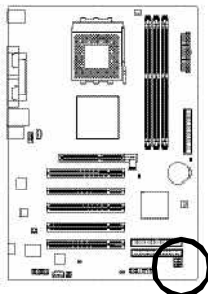

Pin No.	Definition
1	Power
2	Power
3	USB0DX-/USB2DX-
4	USB1 Dy-/USB3 Dy-
5	USB0 DX+/USB2 DX+
6	USB1 Dy+/USB3 Dy+
7	GND
8	GND
9	No Pin
10	NC

15) GAME (Game Connector)

This connector supports joystick, MIDI keyboard and other relate audio devices. Check the pin assignment while you connect the game cables. Please contact your nearest dealer for optional game cables.

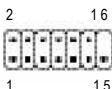
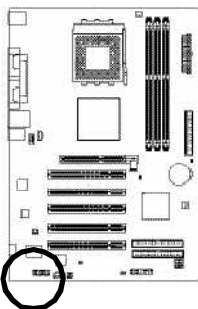

Pin No.	Definition	Pin No.	Definition
1	VCC	9	GPSA1
2	GRX1_R	10	GND
3	GND	11	GPY1_R
4	GPSA2	12	VCC
5	VCC	13	GPSB1
6	GPX2_R	14	MSO_R
7	GPY2_R	15	GPSB2
8	MSL_R	16	No Pin

16) CI (Chassis Intrusion, Case Open)

This 2-pin connector allows your system to enable or disable the "case open" item in BIOS if the system case begin remove.

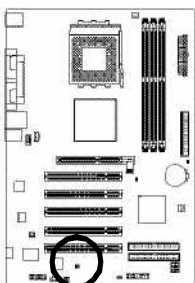



Pin No.	Definition
1	Signal
2	GND

17) CLR_CMOS (Clear CMOS)

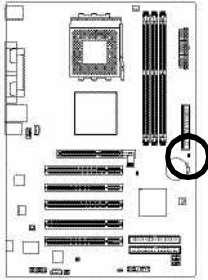
You may clear the CMOS data to its default values by this jumper. To clear CMOS, temporarily short 1-2 pin. Default doesn't include the "Shunter" to prevent from improper use this jumper.



1  Short: Clear CMOS

1  Open: Normal

Chapter 2 BIOS Setup

BIOS Setup is an overview of the BIOS Setup Program. The program that allows users to modify the basic system configuration. This type of information is stored in battery-backed CMOS RAM so that it retains the Setup information when the power is turned off.

ENTERING SETUP

Powering ON the computer and pressing immediately will allow you to enter Setup. If you require more advanced BIOS settings, please go to "Advanced BIOS" setting menu. To enter Advanced BIOS setting menu, press "Ctrl+F1" key on the BIOS screen.

CONTROL KEYS

<↑><↓><←><→>	Move to select item
<Enter>	Select Item
<Esc>	Main Menu - Quit and not save changes into CMOS Status Page Setup Menu and Option Page Setup Menu - Exit current page and return to Main Menu
<+/PgUp>	Increase the numeric value or make changes
<-/PgDn>	Decrease the numeric value or make changes
<F1>	General help, only for Status Page Setup Menu and Option Page Setup Menu
<F2>	Item Help
<F5>	Restore the previous CMOS value from CMOS, only for Option Page Setup Menu
<F6>	Load the file-safe default CMOS value from BIOS default table
<F7>	Load the Optimized Defaults
<F8>	Q-Flash utility
<F9>	System Information
<F10>	Save all the CMOS changes, only for Main Menu

Main Menu

The on-line description of the highlighted setup function is displayed at the bottom of the screen.

Status Page Setup Menu / Option Page Setup Menu

Press F1 to pop up a small help window that describes the appropriate keys to use and the possible selections for the highlighted item. To exit the Help Window press <Esc>.

The Main Menu (For example: BIOS Ver. : F4c)

Once you enter Award BIOS CMOS Setup Utility, the Main Menu (as figure below) will appear on the screen. The Main Menu allows you to select from eight setup functions and two exit choices. Use arrow keys to select among the items and press <Enter> to accept or enter the sub-menu.

CMOS Setup Utility-Copyright (C) 1984-2004 Award Software

<ul style="list-style-type: none"> ▶ Standard CMOS Features ▶ Advanced BIOS Features ▶ Integrated Peripherals ▶ Power Management Setup ▶ PnP/PCI Configurations ▶ PC Health Status ▶ Frequency/Voltage Control 	<ul style="list-style-type: none"> Load Fail-Safe Defaults Load Optimized Defaults Set Supervisor Password Set User Password Save & Exit Setup Exit Without Saving
ESC: Quit	↑↓←→: Select Item
F8: Q-Flash	F10: Save & Exit Setup
Time, Date, Hard Disk Type...	



If you can't find the setting you want, please press "Ctrl+F1" to search the advanced option hidden.

- **Standard CMOS Features**

This setup page includes all the items in standard compatible BIOS.

- **Advanced BIOS Features**

This setup page includes all the items of Award special enhanced features.

- **Integrated Peripherals**

This setup page includes all onboard peripherals.

- **PowerManagement Setup**

This setup page includes all the items of Green function features.

- **PnP/PCI Configuration**

This setup page includes all the configurations of PCI & PnP ISA resources.

- **PC Health Status**

This setup page is the System auto detect Temperature, voltage, fan, speed.

- **Frequency/VoltageControl**

This setup page is control CPU clock and frequency ratio.

- **Load Fail-Safe Defaults**

Fail-Safe Defaults indicates the value of the system parameters which the system would be in safe configuration.

- **Load Optimized Defaults**

Optimized Defaults indicates the value of the system parameters which the system would be in best performance configuration.

- **Set Supervisor Password**

Change, set, or disable password. It allows you to limit access to the system and Setup, or just to Setup.

- **Set User Password**

Change, set, or disable password. It allows you to limit access to the system.

- **Save & Exit Setup**

Save CMOS value settings to CMOS and exit setup.

- **Exit Without Saving**

Abandon all CMOS value changes and exit setup.

Standard CMOS Features

CMOS Setup Utility—Copyright (C) 1984-2004 Award Software
Standard CMOS Features

		Item Help
Date (mm:dd:yy)	Fri, Jan 9 2004	Menu Level▶
Time (hh:mm:ss)	22:31:24	Change the day, month, year
▶ IDE Primary Master	[None]	<Week>
▶ IDE Primary Slave	[None]	Sun. to Sat.
▶ IDE Secondary Master	[None]	<Month>
▶ IDE Secondary Slave	[None]	Jan. to Dec.
Drive A	[1.44M, 3.5"]	<Day>
Drive B	[None]	1 to 31 (or maximum allowed in the month)
Floppy 3 Mode Support	[Disabled]	<Year>
Holt On	[All, But Keyboard]	1999 to 2098
Base Memory	640K	
Extended Memory	127M	
Total Memory	128M	
↑↓→←: Move Enter: Select +/~/PU/PD: Value F10: Save ESC: Exit F1: General Help F5: Previous Values F6: Fail-Save Default F7: Optimized Defaults		

☞ Date

The date format is <week>, <month>, <day>, <year>.

- ▶▶ Week The week, from Sun to Sat, determined by the BIOS and is display only
- ▶▶ Month The month, Jan. Through Dec.
- ▶▶ Day The day, from 1 to 31 (or the maximum allowed in the month)
- ▶▶ Year The year, from 1999 through 2098

☞ Time

The times format in <hour> <minute> <second>. The time is calculated base on the 24-hour military-time clock. For example, 1 p.m. is 13:00:00.

☞ IDE Primary Master, Slave / Secondary Master, Slave

The category identifies the types of hard disk from drive C to F that has been installed in the computer. There are two types: auto type, and manual type. Manual type is user-definable; Auto type which will automatically detect HDD type.

Note that the specifications of your drive must match with the drive table. The hard disk will not work properly if you enter improper information for this category.

If you select User Type, related information will be asked to enter to the following items. Enter the information directly from the keyboard and press <Enter>. Such information should be provided in the documentation form your hard disk vendor or the system manufacturer.

- ▶▶ Capacity: The hard disk size. The unit is Mega Bytes.
- ▶▶ Access Mode: The options are: Auto / Large / LBA / Normal.
- ▶▶ Cylinder: The cylinder number of hard disk.
- ▶▶ Head The read / Write head number of hard disk.
- ▶▶ Precomp The cylinder number at which the disk driver changes the write current
- ▶▶ Landing Zone The cylinder number that the disk driver heads(read/write) are seated when the disk drive is parked.
- ▶▶ SECTORS The sector number of each track define on the hard disk.

If a hard disk has not been installed select NONE and press <Enter>.

☞ Drive A / Drive B

The category identifies the types of floppy disk drive A or drive B that has been installed in the computer.

- ▶▶ None No floppy drive installed
- ▶▶ 360K, 5.25 ". 5.25 inch PC-type standard drive; 360K byte capacity.
- ▶▶ 1.2M, 5.25 ". 5.25 inch AT-type high-density drive; 1.2M byte capacity (3.5 inch when 3 Mode is Enabled).
- ▶▶ 720K, 3.5 ". 3.5 inch double-sided drive; 720K byte capacity
- ▶▶ 1.44M, 3.5 ". 3.5 inch double-sided drive; 1.44M byte capacity.
- ▶▶ 2.88M, 3.5 ". 3.5 inch double-sided drive; 2.88M byte capacity.

☞ Floppy 3 Mode Support (for Japan Area)

- ▶▶ Disabled Normal Floppy Drive. (Default value)
- ▶▶ Drive A Enabled 3 mode function of Drive A.
- ▶▶ Drive B Enabled 3 mode function of Drive B.
- ▶▶ Both Drive A & B are 3 mode Floppy Drives.

☞ Halt on

The category determines whether the computer will stop if an error is detected during power up.

- ▶▶ NO Errors The system boot will not stop for any error that may be detected and you will be prompted.
- ▶▶ All Errors Whenever the BIOS detects a non-fatal error the system will be stopped.
- ▶▶ All, But Keyboard The system boot will not stop for a keyboard error; it will stop for all other errors. (Default value)
- ▶▶ All, But Diskette The system boot will not stop for a disk error; it will stop for all other errors.
- ▶▶ All, But Disk/Key The system boot will not stop for a keyboard or disk error; it will stop for all other errors.

Memory

The category is display-only which is determined by POST (Power On Self Test) of the BIOS.

BaseMemory

The POST of the BIOS will determine the amount of base (or conventional) memory installed in the system.

The value of the base memory is typically 512 K for systems with 512 K memory installed on the motherboard, or 640 K for systems with 640 K or more memory installed on the motherboard.

ExtendedMemory

The BIOS determines how much extended memory is present during the POST. This is the amount of memory located above 1 MB in the CPU memory address map.

Advanced BIOS Features

CMOS Setup Utility-Copyright (C) 1984-2004 Award Software
Advanced BIOS Features

First Boot Device	[Floppy]	Item Help
Second Boot Device	[HDD-0]	Menu Level▶
Third Boot Device	[CDROM]	Select Boot Device priority
Password Check	[Setup]	[Floppy] Boot from floppy
		[LS120] Boot from LS120
		[HDD-0] Boot from First HDD
		[HDD-1] Boot from Second HDD
↑↓→←: Move Enter: Select +/-/PU/PD: Value F10: Save ESC: Exit F1: General Help F5: Previous Values F6: Fail-Save Default F7: Optimized Defaults		

☞ First / Second / Third Boot device

☛ This feature allows you to select the boot device priority.

- ▶▶ Floppy Select your boot device priority by Floppy.
- ▶▶ LS120 Select your boot device priority by LS120.
- ▶▶ HDD-0~3 Select your boot device priority by HDD-0~3.
- ▶▶ SCSI Select your boot device priority by SCSI.
- ▶▶ CDROM Select your boot device priority by CDROM.
- ▶▶ LAN Select your boot device priority by LAN.
- ▶▶ USB-CDROM Select your boot device priority by USB-CDROM.
- ▶▶ USB-ZIP Select your boot device priority by USB-ZIP.
- ▶▶ USB-FDD Select your boot device priority by USB-FDD.
- ▶▶ USB-HDD Select your boot device priority by USB-HDD.
- ▶▶ ZIP Select your boot device priority by ZIP.
- ▶▶ Disabled Disabled this function.

☞ Password Check

- ▶▶ System The system can not boot and can not access to Setup page will be denied if the correct password is not entered at the prompt.
- ▶▶ Setup The system will boot, but access to Setup will be denied if the correct password is not entered at the prompt. (Default value)

Integrated Peripherals

CMOS Setup Utility-Copyright (C) 1984-2003 Award Software

Integrated Peripherals

OnChip IDE Channel0	[Enabled]	Item Help
OnChip IDE Channel1	[Enabled]	
AC97 Audio	[Auto]	Menu Level ►
VIA Onboard LAN *	[Enabled]	
USB 1.1 Controller	[Enabled]	
USB 2.0 Controller	[Enabled]	
USB Keyboard Support	[Disabled]	
USB Mouse Support	[Disabled]	
VIA LAN Boot ROM *	[Disabled]	
Onboard Serial Port 1	[3F8/IRQ4]	
Onboard Serial Port 2	[2F8/IRQ3]	
Onboard Parallel Port	[378/IRQ7]	
UART Mode Select	[Normal]	
Parallel Port Mode	[SPP]	
Game Port Address	[201]	
Midi Port Address	[330]	
Midi Port IRQ	10	
<p>↑↓→←: Move Enter: Select +/-/PU/PD: Value F10: Save ESC: Exit F1: General Help F5: Previous Values F6: Fail-Save Default F7: Optimized Defaults</p>		

☞ OnChip IDE Channel0

● When enabled, allows you to use the onboard primary PCI IDE. If a hard disk controller card is used, set at Disabled.

- ▶▶ Enabled Enable onboard 1st channel IDE port. (Default value)
- ▶▶ Disabled Disable onboard 1st channel IDE port.

☞ OnChip IDE Channel1

● When enabled, allows you to use the onboard secondary PCI IDE. If a hard disk controller card is used, set at Disabled.

- ▶▶ Enabled Enable onboard 2nd channel IDE port. (Default value)
- ▶▶ Disabled Disable onboard 2nd channel IDE port.

☞ AC97 Audio

- ▶▶ Enabled BIOS will automatically detect onboard AC97 Audio. (Default value)
- ▶▶ Disabled Disabled AC97 Audio.

☞ VIA Onboard LAN *

- ▶▶ Enabled Enable VIA Onboard LAN function. (Default value)
- ▶▶ Disabled Disable this function.

☞ USB 1.1 Controller

● Disable this option if you are not using the onboard USB feature.

- ▶▶ Enabled Enabled USB Controller. (Default value)
- ▶▶ Disabled Disabled USB Controller.

☞ USB 2.0 Controller

● Disable this option if you are not using the onboard USB 2.0 feature.

- ▶▶ Enabled Enabled USB 2.0 Controller. (Default value)
- ▶▶ Disabled Disabled USB 2.0 Controller.

" * " For 7VT600-RZ-C only.

☞ USB Keyboard Support

🔊 When a USB keyboard is installed, please set at Enabled.

- ▶▶ Enabled Enabled USB Keyboard Support.
- ▶▶ Disabled Disabled USB Keyboard Support. (Default value)

☞ USB Mouse Support

- ▶▶ Enabled Enabled USB Mouse Support.
- ▶▶ Disabled Disabled USB Mouse Support. (Default value)

☞ VIA LAN Boot ROM *

This function decide whether to invoke the boot ROM of the onboard LAN chip.

- ▶▶ Disabled Disable this function. (Default Value)
- ▶▶ Enabled Enable this function.

☞ Onboard Serial Port 1

- ▶▶ Auto BIOS will automatically setup the port 1 address.
- ▶▶ 3F8/IRQ4 Enable onboard Serial port 1 and address is 3F8,Using IRQ4. (Default value)
- ▶▶ 2F8/IRQ3 Enable onboard Serial port 1 and address is 2F8,Using IRQ3.
- ▶▶ 3E8/IRQ4 Enable onboard Serial port 1 and address is 3E8,Using IRQ4.
- ▶▶ 2E8/IRQ3 Enable onboard Serial port 1 and address is 2E8,Using IRQ3.
- ▶▶ Disabled Disable onboard Serial port 1.

☞ Onboard Serial Port 2

- ▶▶ Auto BIOS will automatically setup the port 2 address.
- ▶▶ 3F8/IRQ4 Enable onboard Serial port 2 and address is 3F8,Using IRQ4.
- ▶▶ 2F8/IRQ3 Enable onboard Serial port 2 and address is 2F8,Using IRQ3. (Default Value)
- ▶▶ 3E8/IRQ4 Enable onboard Serial port 2 and address is 3E8,Using IRQ4.
- ▶▶ 2E8/IRQ3 Enable onboard Serial port 2 and address is 2E8,Using IRQ3.
- ▶▶ Disabled Disable onboard Serial port 2.

☞ OnBoard Parallel port

🔊 This feature allows you to select from a given set of parameters if the parallel port uses the onboard I/O controller.

- ▶▶ 378/IRQ7 Enable onboard LPT port and address is 378, Using IRQ7.(Default Value)
- ▶▶ 278/IRQ5 Enable onboard LPT port and address is 278,Using IRQ5.
- ▶▶ 3BC/IRQ7 Enable onboard LPT port and address is 3BC,Using IRQ7.
- ▶▶ Disabled Disable onboard parallel port

☞ UART Mode Select

This item allows you to determine which Infra Red(IR) function of Onboard I/O chip.

- ▶▶ Normal Set onboard I/O chip UART to Normal Mode. (Default Value)
- ▶▶ IrDA Set onboard I/O chip UART to IrDA Mode.
- ▶▶ ASKIR Set onboard I/O chip UART to ASKIR Mode.
- ▶▶ SCR Set onboard I/O chip as Smart Card interface.

" * " For 7VT600-RZ-C only.

Parallel Port Mode

- ☛ This feature allows you to connect with an advanced print via the port mode it supports.
 - ▶▶ SPP Using Parallel port as Standard Parallel Port using IRQ7. (Default Value)
 - ▶▶ EPP Using Parallel port as Enhanced Parallel Port IRQ5.
 - ▶▶ ECP Using Parallel port as Extended Capabilities Port using IRQ7.
 - ▶▶ ECP+EPP Using Parallel port as ECP & EPP mode.

Game Port Address

- ▶▶ Disabled Disabled this function.
- ▶▶ 201 Set Game PortAddress to 201. (Default Value)
- ▶▶ 209 Set Game Port Address to 209.

Midi Port Address

- ▶▶ Disabled Disabled this function. (Default Value)
- ▶▶ 300 SetMidi Port Address to 300.
- ▶▶ 330 SetMidi Port Address to 330.

Midi Port IRQ

- ▶▶ 5 Set5 for Midi Port IRQ.
- ▶▶ 10 Set10 for Midi Port IRQ.(Default value)

Power Management Setup

CMOS Setup Utility-Copyright (C) 1984-2003 Award Software
Power Management Setup

ACPI Suspend Type	[S1 (POS)]	Item Help
x USB Device Wake-Up From S3	Disabled	Menu Level ▶
Power LED in S1 state	[Blinking]	[S1]
Soft-Off by PWRBTN	[Instant-off]	Set suspend type to
AC Back Function	[Soft-Off]	Power On Suspend under
Keyboard Power On	[Disabled]	ACPI OS
Mouse Power On	[Disabled]	
PME Event Wake Up	[Enabled]	[S3]
ModemRingOn/WakeOnLAN	[Enabled]	Set suspend type to
Resume by Alarm	[Disabled]	Suspend to RAM under
x Date (of Month) Alarm	Everyday	ACPI OS
x Time (hh:mm:ss) Alarm	0 : 0 : 0	
↑↓→←: Move Enter: Select +/-/PU/PD: Value F10: Save ESC: Exit F1: General Help F5: Previous Values F6: Fail-Save Default F7: Optimized Defaults		

☞ ACPI Suspend Type

- ▶▶ S1(POS) Set suspend type to Power On Suspend under ACPI OS(Power On Suspend). (Default value)
- ▶▶ S3(STR) Set suspend type to Suspend To RAM under ACPI OS (Suspend To RAM).

☞ USB Device Wakeup From S3(When ACPI Suspend Type is set [S3(STR)])

USB device wakeup From S3 can be set when ACPI standby state set to S3/STR.

- ▶▶ Enabled USB Device can wakeup system from S3.
- ▶▶ Disabled USB Device can't wakeup system from S3. (Default value)

☞ Power LED in S1 state

- ▶▶ Blinking In standby mode(S1), power LED will blink. (Default value)
- ▶▶ Dual/Off In standby mode(S1):
 - a. If use single color LED, power LED will turn off.
 - b. If use dual color LED, power LED will turn to another color.

☞ Soft-off by PWRBTN

- ▶▶ Instant-off Press power button then Power off instantly. (Default value)
- ▶▶ Delay 4 Sec. Press power button 4 sec to Power off. Enter suspend if button is pressed less than 4 sec.

☞ AC Back Function

- ▶▶ Memory System power on depends on the status before AC lost.
- ▶▶ Soft-Off Always in Off state when AC back. (Default value)
- ▶▶ Full-On Always power on the system when AC back.

☞ Keyboard Power On

This feature allows you to set the method for powering-on the system.

The option "Password" allows you to set up to 8 alphanumeric characters to power-on the system.

The option "Keyboard 98" allows you to use the standard keyboard 98 to power on the system.

- ▶▶ Password Enter from 1 to 8 characters to set the Keyboard Power On Password.
- ▶▶ Disabled Disabled this function. (Default value)
- ▶▶ Keyboard 98 If your keyboard have "POWER Key" button, you can press the key to power on your system.

☞ Mouse Power On

- ▶▶ Disabled Can't Power on system by Mouse Event. (Default value)
- ▶▶ Enabled Can Power on system by Mouse Event.

☞ PME Event Wake up

When set at Enabled, any PCI-PM event awakes the system from a PCI-PM controlled state.

This feature requires an ATX power supply that provides at least 1A on the +5VSB lead.

- ▶▶ Disabled Disabled PME Event Wake up function.
- ▶▶ Enabled Enabled PME Event Wake up function. (Default Value)

☛ **ModemRingOn/WakeOnLAN (When AC Back Function set to [Soft-Off])**

You can enable wake on LAN feature by the "ModemRingOn/WakeOnLAN" or "PME Event Wake up" when the M/B has "WOL" onboard connector. Only enabled the feature by "PME Event Wake up". An incoming call via modem awakes the system from its soft-off mode. When set at Enabled, an input signal comes from the other client.

Server on the LAN awaks the system from a soft off state if connected over LAN.

- ▶▶ Disabled Disabled Modem Ring On / Wake On LAN function.
- ▶▶ Enabled Enabled Modem Ring On / Wake On LAN function. (Default Value)

☛ **Resume by Alarm**

You can set "Resume by Alarm" item to enabled and key in Data/time to power on system.

- ▶▶ Disabled Disable this function. (Default Value)
- ▶▶ Enabled Enable alarm function to POWER ON system.

If RTC Alarm Lead To Power On is Enabled.

Date (of Month) Alarm : Everyday, 1~31
 Time (hh: m.m: ss) Alarm : (0~23) : (0~59) : (0~59)

PnP/PCI Configurations

CMOS Setup Utility-Copyright (C) 1984-2003 Award Software

PnP/PCI Configurations

PCI1/PCI5 IRQ Assignment	[Auto]	Item Help
PCI2 IRQ Assignment	[Auto]	Menu Level ▶
PCI3 IRQ Assignment	[Auto]	
PCI4 IRQ Assignment	[Auto]	
↑↓→←: Move Enter: Select +/-/PU/PD: Value F10: Save ESC: Exit F1: General Help F5: Previous Values F6: Fail-Save Default F7: Optimized Defaults		

☞ PCI1/PCI5 IRQ Assignment

- ▶▶ Auto Auto assign IRQ to PCI 1/ PCI 5. (Default value)
- ▶▶ 3,4,5,7,9.,10,11,12,14,15 Set 3,4,5,7,9,10,11,12,14,15 to PCI1/ PCI5.

☞ PCI2 IRQ Assignment

- ▶▶ Auto Auto assign IRQ to PCI 2. (Default value)
- ▶▶ 3,4,5,7,9.,10,11,12,14,15 Set 3,4,5,7,9,10,11,12,14,15 to PCI2.

☞ PCI3 IRQ Assignment

- ▶▶ Auto Auto assign IRQ to PCI 3. (Default value)
- ▶▶ 3,4,5,7,9.,10,11,12,14,15 Set 3,4,5,7,9,10,11,12,14,15 to PCI3.

☞ PCI4 IRQ Assignment

- ▶▶ Auto Auto assign IRQ to PCI 4. (Default value)
- ▶▶ 3,4,5,7,9.,10,11,12,14,15 Set 3,4,5,7,9,10,11,12,14,15 to PCI4.

PCI Health Status

CMOS Setup Utility-Copyright (C) 1984-2003 Award Software

PC Health Status

Reset Case Open Status	[Disabled]	Item Help
Case Opened	No	
Vcore	1.810V	Menu Level ▶
DDR Vtt	1.248V	[Disabled]
+3.3V	3.280V	Don't reset case
+5V	4.919V	open status
+12V	11.968V	
5VSB	5.053V	[Enabled]
Current System Temperature	27°C	Clear case open
Current CPU Temperature	37°C	status at next boot
Current CPU FAN Speed	4687 RPM	
Current SYSTEM FAN Speed	0 RPM	
CPU FAN Fail Warning	[Disabled]	
SYSTEM FAN Fail Warning	[Disabled]	
↑↓→←: Move Enter: Select +/-/PU/PD: Value F10: Save ESC: Exit F1: General Help F5: Previous Values F6: Fail-Save Default F7: Optimized Defaults		

☞ Reset Case Open Status

☞ Case Opened

If the case is closed, "Case Opened" will show "No".

If the case have been opened, "Case Opened" will show "Yes".

If you want to reset "Case Opened" value, set "Reset Case Open Status" to "Enabled" and save CMOS, your computer will restart.

☞ Current Voltage (V) Vcore / DDR Vtt / +3.3V / +5V / +12V / 5VSB

Detect system's voltage status automatically.

☞ Current System Temperature (°C)

Detect System Temp. automatically.

☞ Current CPU Temperature (°C)

Detect CPU Temp. automatically.

☞ Current CPU FAN / SYSTEM FAN Speed (RPM)

Detect Fan speed status automatically.

☞ Fan Fail Warning (CPU / SYSTEM)

- ☞ Disabled Don't monitor current fan speed. (Default value)
- ☞ Enabled Alarm when stops.

Frequency/Voltage Control

CMOS Setup Utility-Copyright (C) 1984-2003 Award Software

Frequency/Voltage Control

Spread Spectrum Modulated	[Enabled]	Item Help
CPU Host Clock Control	[Disable]	
※CPU Host Frequency(MHz)	133	Menu Level ▶
※PCI/AGP Frequency(MHz)	33/66	
DRAM Clock(MHz)	[Auto]	
CPU OverVoltage Control	[Auto]	
AGP OverVoltage Control	[Auto]	
DIMM OverVoltage Control	[Auto]	
↑↓→←: Move Enter: Select +/-/PU/PD: Value F10: Save ESC: Exit F1: General Help F5: Previous Values F6: Fail-Save Default F7: Optimized Defaults		

※Those items will be available when "CPU Host Clock Control" is set to Enabled.

☞ Spread Spectrum Modulated

- ▶▶ Disabled Disable clock spread spectrum.
- ▶▶ Enabled Enable clock spread spectrum.(Default value)

☞ CPU Host Clock Control

Note: If system hangs up before enter CMOS setup utility, wait for 20 sec for times out reboot . When time out occur, system will reset and run at CPU default Host clock at next boot.

- ▶▶ Disable Disable CPU Host Clock Control.(Default value)
- ▶▶ Enable Enable CPU Host Clock Control.

☞ CPU Host Frequency (MHz) (By switch SW1)

- ▶▶ 100 Set CPU Host Clock to 100MHz~132MHz.
- ▶▶ 133 Set CPU Host Clock to 133MHz~165MHz.
- ▶▶ 166 Set CPU Host Clock to 166MHz~200MHz.
- ▶▶ 200 Set CPU Host Clock to 200MHz~254MHz.

☞ PCI/AGP Frequency (MHz)

- ▶▶ The values depend on CPU Host Frequency(MHz) .

☞ DRAM Clock (MHz)

- ▶▶ Please set DRAM Clock according to your requirement. (Default value: Auto)
- If you use DDR266 DRAM module, please set "DRAM Clock(MHz)" to "133-DDR266". If you use DDR333 DRAM module, please set "DRAM Clock(MHz)" to "166-DDR333". If you use DDR400 DRAM module, please set "DRAM Clock(MHz)" to "200-DDR400".
- Incorrect using it may cause your system broken. For power End-User use only!

☞ CPU OverVoltage Control

Increase CPU voltage may get stable for Over_Clock. But it may damage to CPU when enable this feature.

- ▶▶ Auto Supply voltage as CPU required. (Default value)
- ▶▶ +5% / +7.5% / +10% Increase voltage range as user selected.

☞ AGP OverVoltage Control

Increase AGP voltage may get stable for Over_Clock. But it may damage to AGP Card when enable this feature.

- ▶▶ Auto Supply voltage as AGP Card required. (Default value)
- ▶▶ +0.1V ~ +0.3V Set AGP voltage from 1.6V~1.8V.

☞ DIMM OverVoltage Control

Increase DRAM voltage may get stable for Over_Clock. But it may damage to DRAM module when enable this feature.

- ▶▶ Auto Supply voltage as DRAM module required. (Default value)
- ▶▶ +0.1V ~ +0.3V Set DIMM voltage from 2.6V~2.8V.

Load Fail-Safe Defaults

CMOS Setup Utility-Copyright (C) 1984-2004 Award Software

<ul style="list-style-type: none"> ▶ Standard CMOS Features ▶ Advanced BIOS Features ▶ Integrated Peripherals ▶ Power Management ▶ PnP/PCI ▶ PC Health ▶ Frequency/Voltage Control 	<ul style="list-style-type: none"> Load Fail-Safe Defaults Load Optimized Defaults Set Supervisor Password
Load Fail-Safe Defaults (Y/N)? N	
ESC: Quit	↑↓→←: Select Item
F8: Q-Flash	F10: Save & Exit Setup
Load Fail-Safe Defaults	

Fail-Safe defaults contain the most appropriate values of the system parameters that allow minimum system performance.

Load Optimized Defaults

CMOS Setup Utility-Copyright (C) 1984-2004 Award Software

<ul style="list-style-type: none"> ▶ Standard CMOS Features ▶ Advanced BIOS Features ▶ Integrated Peripherals ▶ Power Management ▶ PnP/PCI ▶ PC Health ▶ Frequency/Voltage Control 	<ul style="list-style-type: none"> Load Fail-Safe Defaults Load Optimized Defaults Set Supervisor Password
Load Optimized Defaults (Y/N)? N	
ESC: Quit	↑↓→←: Select Item
F8: Q-Flash	F10: Save & Exit Setup
Load Optimized Defaults	

Selecting this field loads the factory defaults for BIOS and Chipset Features which the system automatically detects.

Set Supervisor/User Password

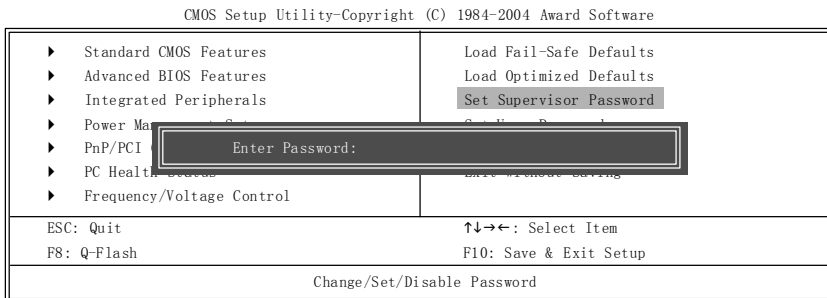

When you select this function, the following message will appear at the center of the screen to assist you in creating a password.

Type the password, up to eight characters, and press <Enter>. You will be asked to confirm the password. Type the password again and press <Enter>. You may also press <Esc> to abort the selection and not enter a password.

To disable password, just press <Enter> when you are prompted to enter password. A message "PASSWORD DISABLED" will appear to confirm the password being disabled. Once the password is disabled, the system will boot and you can enter Setup freely.

The BIOS Setup program allows you to specify two separate passwords:

SUPERVISOR PASSWORD and a USER PASSWORD. When disabled, anyone may access all BIOS Setup program function. When enabled, the Supervisor password is required for entering the BIOS Setup program and having full configuration fields, the User password is required to access only basic items.

If you select "System" at "Password Check" in Advance BIOS Features Menu, you will be prompted for the password every time the system is rebooted or any time you try to enter Setup Menu.

If you select "Setup" at "Password Check" in Advance BIOS Features Menu, you will be prompted only when you try to enter Setup.

Save & Exit Setup

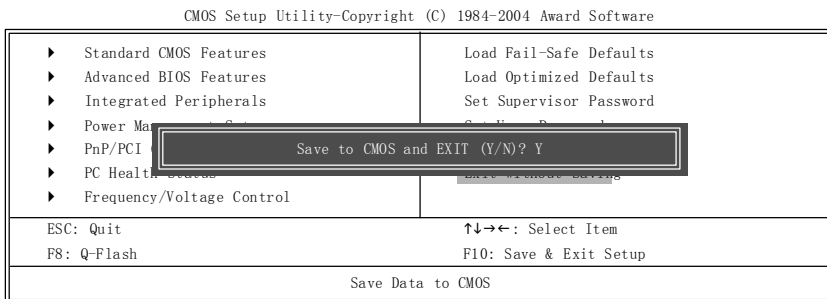

Type "Y" will quit the Setup Utility and save the user setup value to RTC CMOS.
Type "N" will return to Setup Utility.

Exit Without Saving

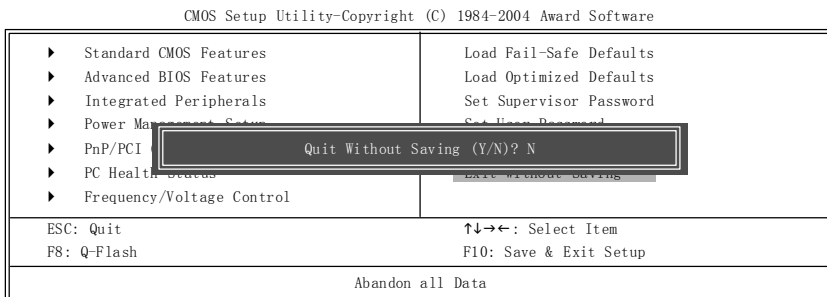

Type "Y" will quit the Setup Utility without saving to RTC CMOS.
Type "N" will return to Setup Utility.

Chapter 3 Install Drivers

Install Drivers



Picture below are shown in Windows XP

Insert the driver CD-title that came with your motherboard into your CD-ROM drive, the driver CD-title will auto start and show the installation guide. If not, please double click the CD-ROM device icon in "My computer", and execute the setup.exe.

INSTALL CHIPSET DRIVER

This page shows the drivers that need to be installed for the system. Click each item to install the driver manually or switch to the  to install the drivers automatically.

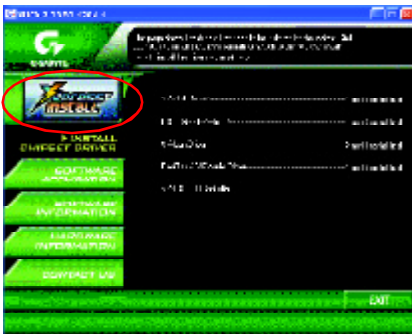

The "Xpress Install" uses the "Click and GO" technology to install the drivers automatically. Just select the drivers you want then click the "GO" button. The  will finish the installation for you automatically.

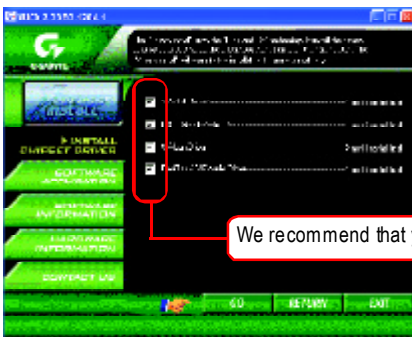

Message: Some device drivers will restart your system automatically. After restarting your system the "Xpress Install" will continue to install other drivers.

We recommend that you install all components in the list.



Driver install finished !
You have to reboot system !

Item Description

- VIA 4IN1 Driver
For INF, AGP, IDE and DMA Driver
- USB Path for WinXP
This patch driver can help you to resolve the USB device wake up S3 hang up issue in XP
- VIA Lan Driver *
VIA 10/100 LAN driver for VT6103L chips
- RealTek AC97 Audio Driver
Audio driver for Realtek AC97 codec chipset
- VIA USB 2.0 Controller
USB 2.0 Driver information for XP



For USB2.0 driver support under Windows XP operating system, please use Windows Service Pack. After install Windows Service Pack, it will show a question mark "?" in "Universal Serial Bus controller" under "Device Manager". Please remove the question mark and restart the system (System will auto-detect the right USB2.0 driver).

" * " For 7VT600-RZ-C Only.

A series of horizontal lines for writing, consisting of 24 evenly spaced lines.

CONTACT US

Contact us via the information in this page all over the world.

• Taiwan

Gigabyte Technology Co., Ltd.
 Address: No.6, Bau Chiang Road, Hsin-Tien, Taipei Hsien,
 Taiwan, R.O.C.
 Tel: 886 (2) 8912-4888
 Fax: 886 (2) 8912-4004
 Tech.Support:
<http://tw.giga-byte.com/TechSupport/ServiceCenter.htm>
 Non-Tech.Support (Sales/Marketing issues):
<http://ggts.gigabyte.com.tw/nontech.asp>
 Website: <http://www.gigabyte.com.tw>

• USA

G.B.T. INC.
 Address: 17358 Railroad St, City of Industry, CA91748.
 Tel: 1 (626) 854-9338
 Fax: 1 (626) 854-9339
 Tech.Support:
<http://www.giga-byte.com/TechSupport/ServiceCenter.htm>
 Non-Tech.Support (Sales/Marketing issues):
<http://ggts.gigabyte.com.tw/nontech.asp>
 Website: <http://www.giga-byte.com>

• Germany

G.B.T. Technology Trading GmbH
 Tel: 49-40-2533040
 49-01803-428468 (Tech.)
 Fax: 49-40-25492343 (Sales)
 49-01803-428329 (Tech.)
 Tech.Support:
<http://de.giga-byte.com/TechSupport/ServiceCenter.htm>
 Non-Tech.Support (Sales/Marketing issues):
<http://ggts.gigabyte.com.tw/nontech.asp>
 Website: <http://www.gigabyte.de>

• Japan

Nippon Giga-Byte Corporation
 Website: <http://www.gigabyte.co.jp>

• U.K

G.B.T. TECH. CO. LTD.
 Tel: 44-1908-362700
 Fax: 44-1908-362709
 Tech.Support:
<http://uk.giga-byte.com/TechSupport/ServiceCenter.htm>
 Non-Tech.Support (Sales/Marketing issues):
<http://ggts.gigabyte.com.tw/nontech.asp>
 Website: <http://uk.giga-byte.com>

• The Netherlands

Giga-Byte Technology B.V.
 Address: Verdunplein 8 5627 SZ, Eindhoven, The Netherlands
 Tel: +31 40 290 2088
 NL Tech.Support: 0900-GIGABYTE (0900-44422983, €0.2/M)
 BE Tech.Support: 0900-84034 (€0.4/M)
 Fax: +31 40 290 2089
 Tech.Support:
<http://nz.giga-byte.com/TechSupport/ServiceCenter.htm>
 Non-Tech.Support (Sales/Marketing issues):
<http://ggts.gigabyte.com.tw/nontech.asp>
 Website: <http://www.giga-byte.nl>

• China

NINGBO G.B.T. Tech. Trading CO., Ltd.
 Tech.Support:
<http://cn.giga-byte.com/TechSupport/ServiceCenter.htm>
 Non-Tech.Support (Sales/Marketing issues):
<http://ggts.gigabyte.com.tw/nontech.asp>
 Website: <http://www.gigabyte.com.cn>
Beijing
 Tel: 86-10-82856054, 86-10-82856064, 86-10-82856094
 Fax: 86-10-82856575
Chengdu
 Tel: 86-28-85236930
 Fax: 86-28-85256822
GuangZhou
 Tel: 86-20-87586273
 Fax: 86-20-87544306
Shanghai
 Tel: 86-21-64737410
 Fax: 86-21-64453227
Shenyang
 Tel: 86-24-23960918, 86-24-23960893
Wuhan
 Tel: 86-27-87854385, 86-27-87854802
 Fax: 86-27-87854031
Xian
 Tel: 86-29-5531943
 Fax: 86-29-5539821

Free Manuals Download Website

<http://myh66.com>

<http://usermanuals.us>

<http://www.somanuals.com>

<http://www.4manuals.cc>

<http://www.manual-lib.com>

<http://www.404manual.com>

<http://www.luxmanual.com>

<http://aubethermostatmanual.com>

Golf course search by state

<http://golfingnear.com>

Email search by domain

<http://emailbydomain.com>

Auto manuals search

<http://auto.somanuals.com>

TV manuals search

<http://tv.somanuals.com>