



SIR-WRS1

User's Guide

SIRIUS Echo Signal Repeater System

Directed
ELECTRONICS

Table of Contents

FCC.....	4
Warning and Safety Information.....	5
Package Contents.....	7
Overview.....	8
System Components Descriptions.....	10
Echo Transmitter.....	10
Echo Antenna	12
Installation Instructions	13
Antenna Installation	13
Echo Transmitter Installation	14
Echo Antenna Installation	15
Extra Installation tips	16
Using the SIRIUS Echo Signal Repeater System	17
Troubleshooting	19
Specifications	22
Optional Accessories	22
Warranty.....	23

FCC NOTICE:

This device complies with part 15 of the FCC Rules. Operation is subject to the following two conditions:

- (1) this device must not cause harmful interference, and
- (2) this device must accept any interference received, including interference that may cause undesired operation.

WARNING: Changes or modifications not expressly approved by the party responsible for compliance could void the user's authority to operate the equipment.

Warning and Safety Information

Safety Precautions



WARNING

Take the following precautions to prevent fire and avoid personal injury:

- To avoid short circuits, never put any metallic objects (coins, tools, etc.) inside the unit.
- If the Echo Transmitter emits smoke or unusual odors, turn the power off immediately and consult the dealer or retailer from whom you purchased this product.
- Do not drop the Echo Transmitter or Echo Antenna, or subject them to strong shocks.



CAUTION

Take the following precautions to keep the Echo Transmitter and Echo Antenna in proper working order:

- Be sure the Echo Transmitter unit is connected to a standard 110 volt AC outlet.
- Do not open the Echo Transmitter or Echo Antenna.
- Do not install the Echo Transmitter or Echo Antenna where they will be exposed to high levels of humidity, moisture, or dust.

SIRIUS Echo Signal Repeater System

Package Contents

Unpack your SIRIUS Echo Signal Repeater System and be sure that everything listed here is present:

- 1 Echo Transmitter
- 1 Echo Antenna
- 1 AC Adapter
- 4 Wall Mounting Screws
- 1 User's Manual

If anything is missing or damaged, or if your SIRIUS Echo Signal Repeater System fails to operate properly, notify the dealer or retailer where you purchased the product immediately. It is recommended that you retain the original receipt, carton, and packing materials in case you need to return or ship your system in the future.



Wall Mounting Screws

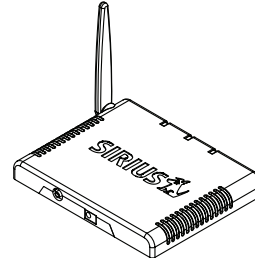

Echo Transmitter



AC Adapter

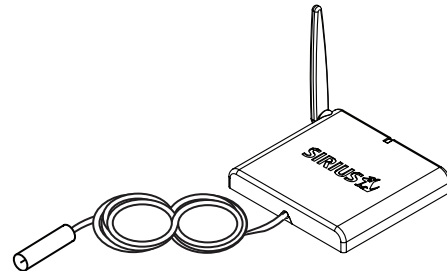

Echo Antenna

Overview:

The SIRIUS Echo Signal Repeater System lets you enjoy SIRIUS radio throughout your home without the need to run antenna wires. It makes it easier to position and install your SIRIUS home antenna for best reception without restricting where you place your SIRIUS radio – essentially giving you the freedom to place your SIRIUS radio anywhere you want in your home. The Echo Transmitter connects to any SIRIUS home antenna, which must be positioned with a clear, unobstructed view of the SIRIUS satellites. The Echo Transmitter wirelessly sends the SIRIUS signal to the Echo Antenna, through the walls and floors of your home. The Echo Antenna discreetly connects to any SIRIUS radio. Now your SIRIUS radio can be conveniently located anywhere in your home, even in interior rooms, without restrictions due to antenna placement or antenna cable length, and without the need to run wires through your home. You can even operate multiple SIRIUS radios in different rooms throughout your home, by connecting each additional SIRIUS radio

to an additional Echo Antenna (model SIR-WRR1), which is sold separately.

The SIRIUS Echo Signal Repeater System is designed to work up to a distance of 75 feet between the Echo Transmitter and each Echo Antenna, passing the signal through walls and floors, in a typical wood frame and drywall construction home found in North America. However, homes constructed with concrete interior walls or with steel frame construction, may affect the wireless signal strength and degrade the range of the system.

SIRIUS Echo Signal Repeater System

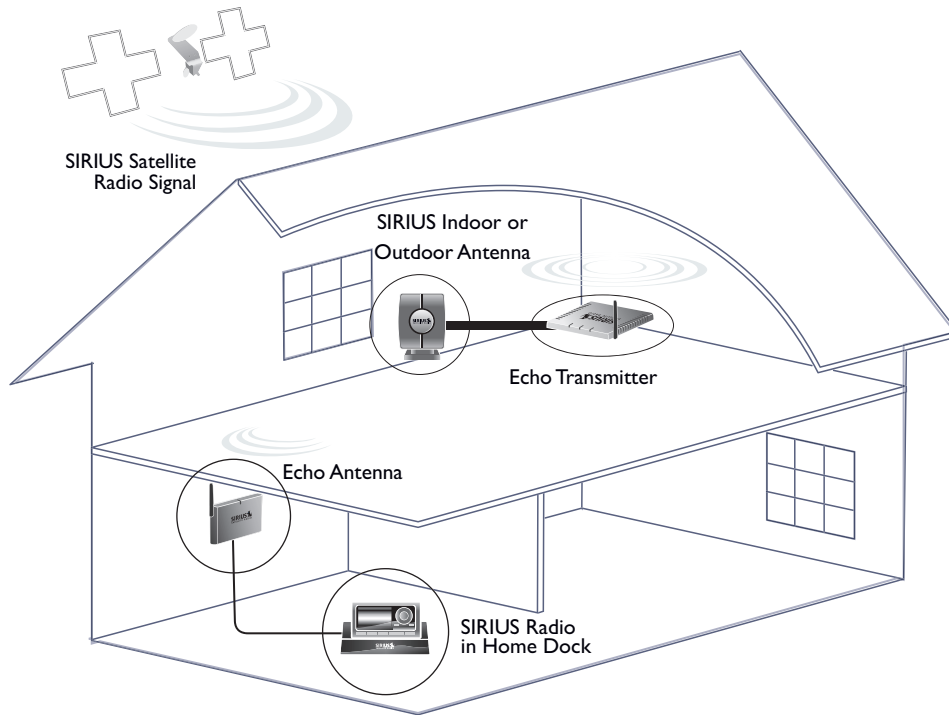

System Component Descriptions

Echo Transmitter

The Echo Transmitter connects to the SIRIUS indoor/outdoor or outdoor home antenna and wirelessly broadcasts the SIRIUS signal throughout the home. It can be placed on a flat surface or wall mounted vertically using two screws and the mounting slots on the base of the unit.

The Echo Transmitter has Power and Antenna connections on the rear of the unit, and three green LEDs on the front, labeled "SIGNAL" "POWER" and "ANTENNA" respectively from left to right. It also has a black plastic antenna on the side that can swivel up and down.

The "POWER" LED lights up when the unit is properly connected and powered by the AC Adapter. The "ANTENNA" LED lights up when the SIRIUS home antenna is properly connected to the Echo Transmitter. The "SIGNAL" LED lights up when the SIRIUS home antenna is receiving a good strong SIRIUS

signal that can be broadcasted by the Echo Transmitter. For proper operation of the Echo Transmitter, all three LEDs need to be lit up. The black plastic antenna on the side needs to be swiveled up in an upright vertical position, so that it is always pointing straight up, regardless if the unit is placed on a flat surface or mounted to a wall.

SIRIUS Echo Signal Repeater System

Front View

when placed on flat surface

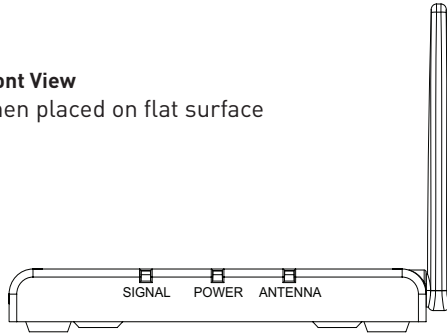

Rear View

when placed on flat surface

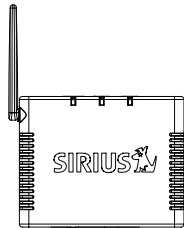
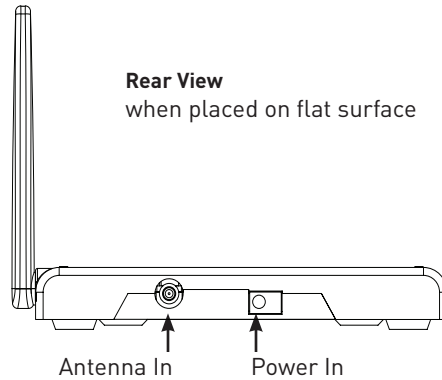

Front View

when mounted on wall

Echo Antenna

The Echo Antenna connects to a SIRIUS radio or the SIRIUS radio dock and receives the wireless signal from the Echo Transmitter. It can be placed on a flat surface or wall mounted vertically using two screws and the mounting slots on the base of the unit.

The Echo Antenna comes with a 4 feet cable with which it connects to the SIRIUS radio. It has a green LED on the front, labeled "POWER". It also has a black plastic antenna on the side that can swivel up and down.

The "POWER" LED lights up when the unit is properly connected to the SIRIUS radio and the SIRIUS radio itself is turned on. For proper operation of the Echo Antenna, this LED needs to be lit up. The black plastic antenna on the side needs to be swiveled up in an upright vertical position, so that it is pointing straight up, regardless if the unit is placed on a flat surface or mounted to a wall.

Front View

when placed on flat surface

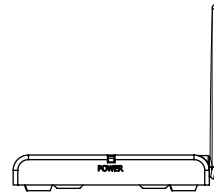

Front View

when mounted on wall

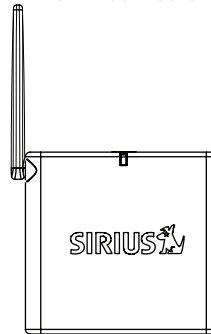

SIRIUS Echo Signal Repeater System

Installation Instructions

Antenna Installation

You can either use the SIRIUS indoor/outdoor home antenna that is sold with SIRIUS home kits or the SIRIUS outdoor home antenna that is either sold separately or as part of a home distribution kit. The SIRIUS home antenna must be located, positioned and aimed properly with a clear, unobstructed view of the SIRIUS satellites in the sky. Whichever antenna you choose to use, carefully follow the instructions included with the antenna when installing the antenna.

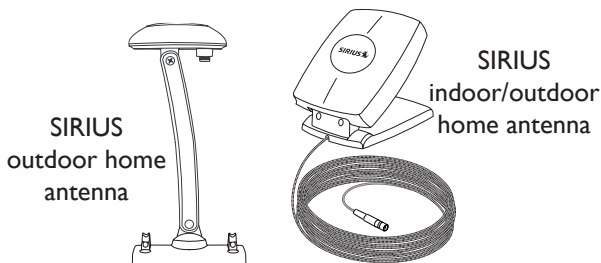

Before installing the components of the SIRIUS Echo Signal Repeater System, it is important to verify that your SIRIUS home antenna is receiving good signal

by doing the following:

- 1 Temporarily connect your SIRIUS radio directly to the SIRIUS home antenna and turn your SIRIUS radio on.
- 2 Access the "Antenna Aiming" screen. Refer to your radio's manual for instructions on accessing this screen. The option may also be called "Signal Strength" or "Signal Indicator" on some SIRIUS radios.
- 3 The antenna aiming/signal indicator screen shows the strength of both the satellite (SAT) signal and the terrestrial (TER) signal (if available).

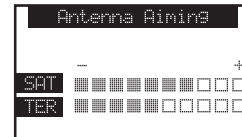

- 4 Follow the directions included with your SIRIUS home antenna and adjust the antenna location and aim for the maximum amount of SAT and TER signal strength.

Echo Transmitter Installation

When you have confirmed that the SIRIUS home antenna is aimed properly, and has a good SIRIUS signal, you are ready to install the Echo Transmitter. The location of the Echo Transmitter is important for getting the best performance out of your SIRIUS Echo Signal Repeater System. Avoid locating the Echo Transmitter near any of the following items which could cause degradation of the wireless signal:

- Microwave Ovens
- Electric Ranges
- Window Air Conditioners
- Large Appliances
- Cordless phones
- Electrical Fuse or Breaker Panels
- Other wireless transmitters such as those for Wireless Video or Wireless Headphones or the SIRIUS Tuner in the SIRIUS Conductor System.

Consider where you will be using the Echo Antenna(s). Locate the Echo Transmitter within 75

feet of the farthest Echo Antenna, but no closer than 10 feet to the closest Echo Antenna. For multi-story homes, you can place the Echo Transmitter and Echo Antennas in different floors.

To install the Echo Transmitter,

- 1 Connect the cable from the SIRIUS home antenna to the antenna connector on the rear of the Echo Transmitter.
- 2 Connect the AC Adapter to the power connection on the rear of the Echo Transmitter, and plug the AC Adapter in to a standard 110 volt AC outlet.
- 3 Raise the black plastic antenna to an upright vertical position, so that it is pointing straight up.
- 4 Ensure that all the 3 LEDs on the front of the Echo Transmitter are lit up.

This completes the Echo Transmitter installation.

SIRIUS Echo Signal Repeater System

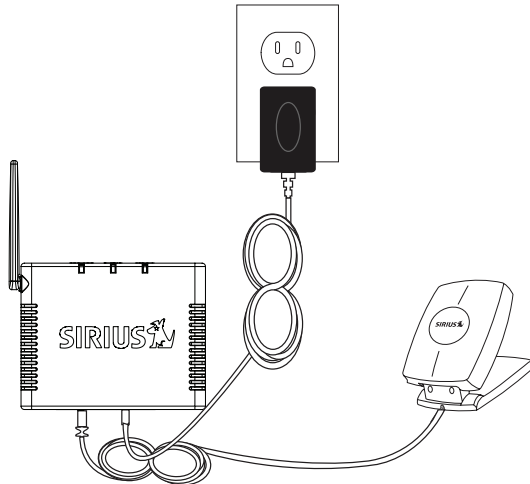

Echo Transmitter connected to SIRIUS home antenna and AC Adapter

Echo Antenna Installation

- 1 Connect the antenna cable from the Echo Antenna to the SIRIUS radio or home dock.
- 2 Raise the black plastic antenna to an upright vertical position, so that it is pointing straight up.
- 3 Turn on the SIRIUS radio. Ensure that the 'POWER' LED on the front of the Echo Antenna is lit up.

This completes the Echo Antenna installation.



Echo Antenna connected to SIRIUS Radio

Extra Installation Tips

- Your Echo Antenna may be placed indoors up to 75 feet away from the Echo Transmitter.
- There should at least be a separation of 10 feet between your Echo Transmitter and Echo Antenna
- The Echo Antenna should be placed as high as possible above obstacles for best reception.
- Multiple Echo Antennas (and SIRIUS radios) can be operated with one Echo Transmitter (additional Echo Antennas are available separately, P/N SIR-WRR1).
- Both the Echo Transmitter and the Echo Antenna may be wall mounted using the screws included in the kit. The Echo Transmitter has wall mount screw spacing of 2 ½ inches apart and the Echo Antenna has a spacing of 1 ½ inches apart. Insert the screws into the wall with approximately ¼" distance from the wall. Place the back of the unit over the heads of the screws and pull down slightly to engage the slot lock. To remove the unit from the wall, slide directly up the wall and pull out and off the screw heads. The Echo Antenna can be rotated 90 degrees when a wall mount configuration is desired.
- You can use the following SIRIUS home antennas either sold separately or found in signal distribution kits to connect to the Echo Transmitter:
 - o The SIRIUS indoor/outdoor home antenna found in SIRIUS home kits
 - o The SIRIUS indoor/outdoor home antenna sold separately
 - o The SIRIUS outdoor home antenna sold separately
 - o The SIRIUS outdoor home antenna found in the following signal distribution kits:
 - 14245 Home Signal Distribution Kit – Satellite Radio,
 - 14250 Home Signal Distribution Kit – CATV plus SIRIUS,
 - 14255 Home Signal Distribution Kit – Sat TV plus SIRIUS

SIRIUS Echo Signal Repeater System

Using the SIRIUS Echo Signal Repeater System

When the Echo Transmitter and Echo Antenna have been installed, turn on the SIRIUS radio and check the Antenna Aiming/Signal Strength display to verify the SIRIUS signal strength. If the SIRIUS signal strength is good, and the audio from the SIRIUS radio is good, the system is working properly. If the SIRIUS signal strength is not good, or the audio from your SIRIUS radio is either absent or intermittent, then the system installation needs to be fine tuned. Please consult the troubleshooting section in this manual.

SIRIUS Echo Signal Repeater System and SIRIUS Conductor System - Coexistence

The SIRIUS Echo Signal Repeater System has been designed to minimize interference between any of its own system components (Echo Transmitter and Echo Antenna) and other wireless devices that are typically found in a home such as certain cordless phones, baby monitors, wireless headphones etc. However, to get the best performance out of your SIRIUS Echo system and these other devices, we advise that you

avoid placing the Echo Transmitter and the Echo Antenna close to these other products.

Special consideration in product placement should be given if you want to operate both the SIRIUS Echo Signal Repeater System and the SIRIUS Conductor System in your home. In this case, we recommend that you place the Echo Transmitter and the SIRIUS Conductor Tuner as far apart from each other as possible and at least in separate rooms. This type of placement would maximize the chances of getting the best performance out of both systems. Also, if the SIRIUS Conductor Remote is used in close proximity of the Echo Transmitter, you may experience some reduction in its range. Also, if the SIRIUS Conductor Remote is used in close proximity to the Echo Transmitter, you may experience some reduction in the Conductor Remote's range.

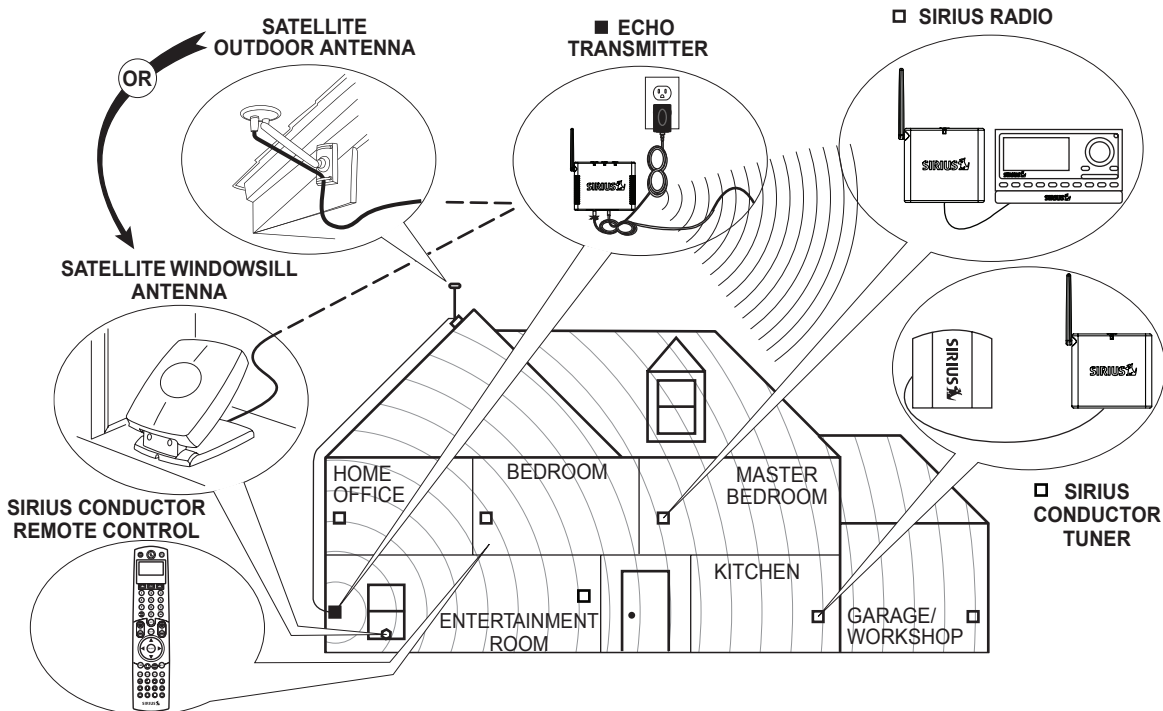

SIRIUS Echo Signal Repeater System

Troubleshooting

This section lists several common problems and suggested solutions. If, after trying the suggested solutions listed here, you are still unable to resolve the problem you're having with your SIRIUS Echo Signal Repeater System, contact your dealer or retailer for more help.

Problem	Suggested Solution (s)
SIRIUS signal strength is zero to one bar OR Audio from the SIRIUS radio sounds like it has an echo	<p>1 Adjust the SIRIUS home antenna until it receives adequate signal from the SIRIUS satellites. Temporarily connect the SIRIUS radio directly to the SIRIUS home antenna by disconnecting the Echo Antenna from the SIRIUS radio, disconnecting the SIRIUS home antenna from the Echo Transmitter, and connecting the SIRIUS home antenna directly to the SIRIUS radio or home dock. Using the Antenna Aiming or Signal Strength display of your SIRIUS radio, aim the SIRIUS home antenna to obtain at least six bars of SAT and/or TER signal strength. (Refer to the instruction manual of your SIRIUS radio for more information on using the Antenna Aiming/Signal Strength display, and the SIRIUS home antenna installation manual for more information on aiming the antenna).</p> <p>Reconnect the SIRIUS home antenna and the AC Adapter to the Echo Transmitter. Plug in the AC Adapter to a standard 110 volt AC outlet. Verify that all 3 green LEDs on the front of the Echo Transmitter are lit. Especially, if the "SIGNAL" LED on the front of the Echo Transmitter is lit, then the SIRIUS home antenna is receiving a usable level of SIRIUS signal that the Echo Transmitter can broadcast around the home. If it is not, then adjust the SIRIUS home antenna until the "SIGNAL" LED on the Echo Transmitter lights up</p>

Problem	Suggested Solution (s)
(continued from previous page)	2 Reduce the distance between the Echo Transmitter and Echo Antenna, or adjust the location of one or both units until the signal strength on your SIRIUS radio is good and the audio from it is acceptable. Materials used in the construction of your home and/or proximity to other 900 MHz products may have an adverse effect on the range of the SIRIUS Echo Signal Repeater System.
SIRIUS radio displays, "Acquiring Signal"	1 Verify that the SIRIUS home antenna cable is connected to the Echo Transmitter. 2 Verify that the AC Adapter is plugged into a working 110 volt AC outlet and is connected to the Echo Transmitter. 3 Verify that all three green LEDs on the Echo Transmitter and the single green LED on the Echo Antenna are lit. 4 Check the Antenna Aiming/Signal Strength display on your SIRIUS radio to verify that you have at least six bars of SAT or TER signal. (See previous suggested solution.)
SIRIUS radio displays "Antenna Not Detected"	1 Verify that the cable from the Echo Antenna is connected to the SIRIUS radio and that the single green LED on the Echo Antenna is lit.

SIRIUS Echo Signal Repeater System

Problem	Suggested Solution (s)
Audio from the SIRIUS radio sounds over-modulated, muffled, or unintelligible	1 The Echo Transmitter and the Echo Antenna may be positioned too close to each other. Increase the distance between the Echo Transmitter and the Echo Antenna.

Specifications

Dimensions (inches):

Transmitter: 4.6" x 3.5" x 0.6"
(height with antenna vertically extended: 3.3")

Receiver: 3.4" x 3.2" x 0.6"
(height with antenna vertically extended: 3.3")

Inputs and Outputs:

Echo Transmitter:

Antenna in: RF SMB connector

DC in: 2.5 mm power jack

Echo Antenna:

SIRIUS radio: 4 foot RF cable with SMB connector

Optional Accessories

Additional Echo Antennas are available for your SIRIUS Echo Signal Repeater System. When you add an additional SIRIUS radio or docking kit to your home, you can purchase an additional Echo Antenna which will work with your already installed Echo Transmitter. The part number is SIR-WRR1.

SIRIUS Echo Signal Repeater System

Limited One Year Consumer Warranty

Directed Electronics (herein "DIRECTED") promises to the original purchaser, to replace this product should it prove to be defective in workmanship or material under normal use, for a period of one-year from the date of purchase from the dealer as indicated by the date code marking of the product. During this one-year period, there will be no charge for this replacement PROVIDED the unit is returned to DIRECTED, shipping pre-paid. This warranty is non-transferable and does not apply to any unit that has been modified or used in a manner contrary to its intended purpose, and does not cover damage to the unit caused by installation or removal of the unit. This warranty is void if the product has been damaged by accident or unreasonable use, neglect, improper service or other causes not arising out of defects in materials or construction. ALL WARRANTIES, INCLUDING BUT NOT LIMITED TO EXPRESS WARRANTY, IMPLIED WARRANTY, WARRANTY OF MERCHANTABILITY, FITNESS FOR PARTICULAR PURPOSE, AND WARRANTY OF NONINFRINGEMENT OF INTELLECTUAL PROPERTY ARE EXPRESSLY EXCLUDED TO THE MAXIMUM EXTENT ALLOWED BY LAW, AND DIRECTED NEITHER ASSUMES NOR AUTHORIZES ANY PERSON TO ASSUME FOR IT ANY LIABILITY IN CONNECTION WITH THE SALE OF THE PRODUCT. DIRECTED HAS ABSOLUTELY NO LIABILITY FOR ANY AND ALL ACTS OF THIRD PARTIES INCLUDING ITS AUTHORIZED DEALERS OR INSTALLERS. IN NO EVENT WILL DIRECTED BE LIABLE FOR ANY INCIDENTAL, SPECIAL OR CONSEQUENTIAL DAMAGES (INCLUDING LOSS OF PROFITS) AND IN NO EVENT, SHALL DIRECTED'S LIABILITY EXCEED THE PURCHASE PRICE PAID BY PURCHASER FOR THE PRODUCT. Some states do not allow the exclusion or limitation of incidental or consequential damages, so the above limitation or exclusion may not apply to you. Some states do not allow limitations on how long an implied warranty lasts, so the above limitation may not apply to you. Unit must be returned to DIRECTED, postage prepaid, with bill of sale or other dated proof of purchase bearing the following information: consumer's name, telephone number, and address, authorized dealer's name and address, and product description. Note: This warranty does not cover labor costs for the removal and reinstallation of the unit. IN ORDER FOR THIS WARRANTY TO BE VALID, YOUR UNIT MUST BE SHIPPED WITH PROOF OF PURCHASE FROM AN AUTHORIZED DIRECTED DEALER. BY PURCHASING THIS PRODUCT, THE CONSUMER AGREES AND CONSENTS THAT ALL DISPUTES BETWEEN THE CONSUMER AND DIRECTED SHALL BE RESOLVED IN ACCORDANCE WITH CALIFORNIA LAWS IN SAN DIEGO COUNTY, CALIFORNIA.

Designed and Engineered in the USA

Directed[®]
E L E C T R O N I C S

SIRWRS1 03-07



© 2007 Directed Electronics, all rights reserved.

Free Manuals Download Website

<http://myh66.com>

<http://usermanuals.us>

<http://www.somanuals.com>

<http://www.4manuals.cc>

<http://www.manual-lib.com>

<http://www.404manual.com>

<http://www.luxmanual.com>

<http://aubethermostatmanual.com>

Golf course search by state

<http://golfingnear.com>

Email search by domain

<http://emailbydomain.com>

Auto manuals search

<http://auto.somanuals.com>

TV manuals search

<http://tv.somanuals.com>