

Router / Shaper

(Model 43-505)



PART NO. 902118 (0112)
Copyright © 2001 Delta Machinery



To learn more about DELTA MACHINERY
visit our website at: www.deltamachinery.com.

For Parts, Service, Warranty or other Assistance,

please call 1-800-223-7278 (In Canada call 1-800-463-3582).

ESPAÑOL: PÁGINA 19

GENERAL SAFETY RULES

Woodworking can be dangerous if safe and proper operating procedures are not followed. As with all machinery, there are certain hazards involved with the operation of the product. Using the machine with respect and caution will considerably lessen the possibility of personal injury. However, if normal safety precautions are overlooked or ignored, personal injury to the operator may result. Safety equipment such as guards, push sticks, hold-downs, featherboards, goggles, dust masks and hearing protection can reduce your potential for injury. But even the best guard won't make up for poor judgment, carelessness or inattention. Always use common sense and exercise caution in the workshop. If a procedure feels dangerous, don't try it. Figure out an alternative procedure that feels safer. **REMEMBER:** Your personal safety is your responsibility.

This machine was designed for certain applications only. Delta Machinery strongly recommends that this machine not be modified and/or used for any application other than that for which it was designed. If you have any questions relative to a particular application, **DO NOT** use the machine until you have first contacted Delta to determine if it can or should be performed on the product.

Technical Service Manager

Delta Machinery
4825 Highway 45 North
Jackson, TN 38305

(IN CANADA: 505 SOUTHGATE DRIVE, GUELPH, ONTARIO N1H 6M7)



WARNING: FAILURE TO FOLLOW THESE RULES MAY RESULT IN SERIOUS PERSONAL INJURY

1. **FOR YOUR OWN SAFETY, READ INSTRUCTION MANUAL BEFORE OPERATING THE TOOL.** Learn the tool's application and limitations as well as the specific hazards peculiar to it.

2. **KEEP GUARDS IN PLACE** and in working order.

3. **ALWAYS WEAR EYE PROTECTION.** Wear safety glasses. Everyday eyeglasses only have impact resistant lenses; they are not safety glasses. Also use face or dust mask if cutting operation is dusty. These safety glasses must conform to ANSI Z87.1 requirements. **NOTE:** Approved glasses have Z87 printed or stamped on them.

4. **REMOVE ADJUSTING KEYS AND WRENCHES.** Form habit of checking to see that keys and adjusting wrenches are removed from tool before turning it "on".

5. **KEEP WORK AREA CLEAN.** Cluttered areas and benches invite accidents.

6. **DON'T USE IN DANGEROUS ENVIRONMENT.** Don't use power tools in damp or wet locations, or expose them to rain. Keep work area well-lighted.

7. **KEEP CHILDREN AND VISITORS AWAY.** All children and visitors should be kept a safe distance from work area.

8. **MAKE WORKSHOP CHILDPROOF** – with padlocks, master switches, or by removing starter keys.

9. **DON'T FORCE TOOL.** It will do the job better and be safer at the rate for which it was designed.

10. **USE RIGHT TOOL.** Don't force tool or attachment to do a job for which it was not designed.

11. **WEAR PROPER APPAREL.** No loose clothing, gloves, neckties, rings, bracelets, or other jewelry to get caught in moving parts. Nonslip footwear is recommended. Wear protective hair covering to contain long hair.

12. **SECURE WORK.** Use clamps or a vise to hold work when practical. It's safer than using your hand and frees both hands to operate tool.

13. **DON'T OVERREACH.** Keep proper footing and balance at all times.

14. **MAINTAIN TOOLS IN TOP CONDITION.** Keep tools sharp and clean for best and safest performance. Follow instructions for lubricating and changing accessories.

15. **DISCONNECT TOOLS** before servicing and when changing accessories such as blades, bits, cutters, etc.

16. **USE RECOMMENDED ACCESSORIES.** The use of accessories and attachments not recommended by Delta may cause hazards or risk of injury to persons.

17. **REDUCE THE RISK OF UNINTENTIONAL STARTING.** Make sure switch is in "OFF" position before plugging in power cord. In the event of a power failure, move switch to the "OFF" position.

18. **NEVER STAND ON TOOL.** Serious injury could occur if the tool is tipped or if the cutting tool is accidentally contacted.

19. **CHECK DAMAGED PARTS.** Before further use of the tool, a guard or other part that is damaged should be carefully checked to ensure that it will operate properly and perform its intended function – check for alignment of moving parts, binding of moving parts, breakage of parts, mounting, and any other conditions that may affect its operation. A guard or other part that is damaged should be properly repaired or replaced.

20. **DIRECTION OF FEED.** Feed work into a blade or cutter against the direction of rotation of the blade or cutter only.

21. **NEVER LEAVE TOOL RUNNING UNATTENDED. TURN POWER OFF.** Don't leave tool until it comes to a complete stop.

22. **STAY ALERT, WATCH WHAT YOU ARE DOING, AND USE COMMON SENSE WHEN OPERATING A POWER TOOL. DO NOT USE TOOL WHILE TIRED OR UNDER THE INFLUENCE OF DRUGS, ALCOHOL, OR MEDICATION.** A moment of inattention while operating power tools may result in serious personal injury.

23. **MAKE SURE TOOL IS DISCONNECTED FROM POWER SUPPLY** while motor is being mounted, connected or reconnected.

24. **THE DUST GENERATED** by certain woods and wood products can be injurious to your health. Always operate machinery in well ventilated areas and provide for proper dust removal. Use wood dust collection systems whenever possible.

25.  **WARNING: SOME DUST CREATED BY POWER SANDING, SAWING, GRINDING, DRILLING, AND OTHER CONSTRUCTION ACTIVITIES** contains chemicals known to cause cancer, birth defects or other reproductive harm. Some examples of these chemicals are:

- lead from lead-based paints,
 - crystalline silica from bricks and cement and other masonry products, and
 - arsenic and chromium from chemically-treated lumber.
- Your risk from these exposures varies, depending on how often you do this type of work. To reduce your exposure to these chemicals: work in a well ventilated area, and work with approved safety equipment, such as those dust masks that are specially designed to filter out microscopic particles.

SAVE THESE INSTRUCTIONS.

Refer to them often and use them to instruct others.

ADDITIONAL SAFETY RULES FOR FOR THE ROUTER/SHAPER



WARNING: FAILURE TO FOLLOW THESE RULES MAY RESULT IN SERIOUS PERSONAL INJURY

1. **DO NOT OPERATE THIS MACHINE UNTIL** it is **assembled** and **installed** according to the instructions.
2. **OBTAIN ADVICE** from your **supervisor, instructor, or another qualified person** if you are not familiar with the operation of this machine.
3. **FOLLOW ALL WIRING CODES** and recommended electrical connections.
4. **NEVER** turn the machine "ON" before clearing the table of all objects (tools, scraps of wood, etc.).
5. **AVOID** awkward hand positions. A sudden slip could allow the hand to contact the cutter.
6. **KEEP** hands away from cutter.
7. **NEVER START THE MACHINE** with the workpiece contacting the cutter.
8. **NEVER** reach under the table while the machine is running.
9. **KEEP** cutters sharp and free from rust and pitch.
10. **NEVER ADJUST THE FENCE** while the machine is running.
11. **ADJUST THE FENCE HALVES** so that the cutter opening is never more than is required to clear the cutter.
12. **LOCK THE FENCE HARDWARE** after making fence adjustments.
13. **PROPERLY SECURE THE CUTTERS** before starting the machine.
14. **DO NOT** perform any operation freehand. Use the fence for straight shaping, the miter gauge for edge shaping, and the starting pin and rub collars for curve shaping.
15. **KEEP THE FRONT MOTOR ACCESS PANEL CLOSED** while operating the machine.
16. **USE GUARDS** provided with the machine.
17. **DO NOT** feed a workpiece that is warped, contains knots, or is embedded with foreign objects, (nails, staples, etc.).
18. **NEVER** run the workpiece between the fence and the cutter.
19. **USE A MITER GAUGE** and a clamp attachment when edge shaping work less than 3" wide. Remove the fence during this operation.
20. **PROVIDE SUFFICIENT BEARING** surface when shaping with a starting pin and collar(s) (Figs. B and C).

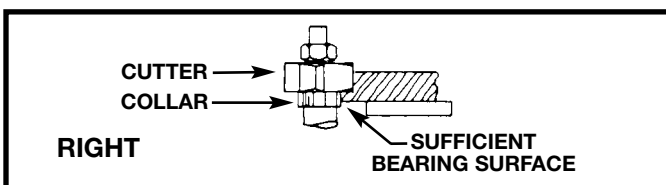

Fig. B

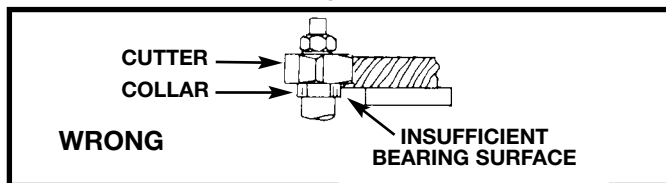

Fig. C

21. **USE A HEAVY WORKPIECE** when shaping with starting pin and collar(s). **DO NOT SHAPE** a short, light workpiece against the collar(s) (Figs. D and E).

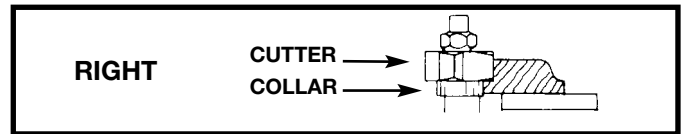

Fig. D

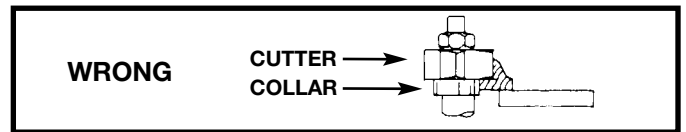

Fig. E

22. **POSITION THE CUTTER** below the collar(s) when shaping with starting pin and collar(s) (Fig. F).

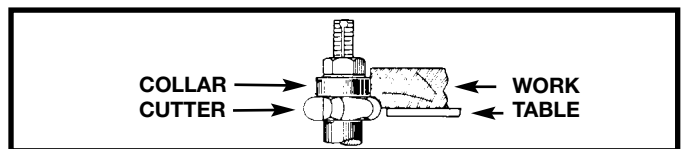

Fig. F

23. **FEED WORKPIECE** against cutter rotation (Fig. G).

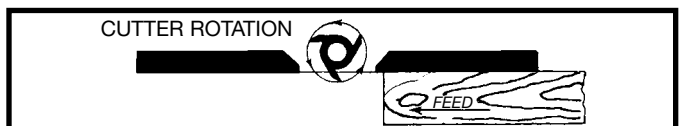

Fig. G

24. **NEVER PERFORM LAYOUT**, assembly, or set-up work on the table while the machine is running.
25. **TURN THE MACHINE "OFF" AND DISCONNECT THE MACHINE** from the power source before installing or removing accessories, before adjusting or changing set-ups, or when making repairs.
26. **TURN THE MACHINE "OFF"**, disconnect the machine from the power source, and clean the table/work area before leaving the machine. **LOCK THE SWITCH** IN THE "OFF" POSITION to prevent unauthorized use.
27. **ADDITIONAL INFORMATION** regarding the safe and proper operation of this machine is available from the Power Tool Institute, 1300 Summer Avenue, Cleveland, OH 44115-2851. Information is also available from the National Safety Council, 1121 Spring Lake Drive, Itasca, IL 60143-3201. Please refer to the American National Standards Institute ANSI 01.1 Safety Requirements for Woodworking Machines and the U.S. Department of Labor OSHA 1910.213 Regulations.

SAVE THESE INSTRUCTIONS.

Refer to them often

and use them to instruct others.

POWER CONNECTIONS

A separate electrical circuit should be used for your machines. This circuit should not be less than #12 wire and should be protected with a 20 Amp time lag fuse. If an extension cord is used, use only 3-wire extension cords which have 3-prong grounding type plugs and matching receptacle which will accept the machine's plug. Before connecting the motor to the power line, make sure the switch is in the "OFF" position and be sure that the electric current is of the same characteristics as indicated on the machine. All line connections should make good contact. Running on low voltage will damage the motor.

 **WARNING: DO NOT EXPOSE THE MACHINE TO RAIN OR OPERATE THE MACHINE IN DAMP LOCATIONS.**

MOTOR SPECIFICATIONS

Your machine is wired for 120 volt, 60 HZ alternating current. Before connecting the machine to the power source, make sure the switch is in the "OFF" position.

GROUNDING INSTRUCTIONS

 **WARNING: THIS MACHINE MUST BE GROUNDED WHILE IN USE TO PROTECT THE OPERATOR FROM ELECTRIC SHOCK.**

1. All grounded, cord-connected machines:

In the event of a malfunction or breakdown, grounding provides a path of least resistance for electric current to reduce the risk of electric shock. This machine is equipped with an electric cord having an equipment-grounding conductor and a grounding plug. The plug must be plugged into a matching outlet that is properly installed and grounded in accordance with all local codes and ordinances.

Do not modify the plug provided - if it will not fit the outlet, have the proper outlet installed by a qualified electrician.

Improper connection of the equipment-grounding conductor can result in risk of electric shock. The conductor with insulation having an outer surface that is green with or without yellow stripes is the equipment-grounding conductor. If repair or replacement of the electric cord or plug is necessary, do not connect the equipment-grounding conductor to a live terminal.

Check with a qualified electrician or service personnel if the grounding instructions are not completely understood, or if in doubt as to whether the machine is properly grounded.

Use only 3-wire extension cords that have 3-prong grounding type plugs and matching 3-conductor receptacles that accept the machine's plug, as shown in Fig. A.

Repair or replace damaged or worn cord immediately.

2. Grounded, cord-connected machines intended for use on a supply circuit having a nominal rating less than 150 volts:

If the machine is intended for use on a circuit that has an outlet that looks like the one illustrated in Fig. A, the machine will have a grounding plug that looks like the plug illustrated in Fig. A. A temporary adapter, which looks like the adapter illustrated in Fig. B, may be used to connect this plug to a matching 2-conductor receptacle as shown in Fig. B if a properly grounded outlet is not available. The temporary adapter should be used only until a properly grounded outlet can be installed by a qualified electrician. The green-colored rigid ear, lug, and the like, extending from the adapter must be connected to a permanent ground such as a properly grounded outlet box. Whenever the adapter is used, it must be held in place with a metal screw.

NOTE: In Canada, the use of a temporary adapter is not permitted by the Canadian Electric Code.

 **WARNING: IN ALL CASES, MAKE CERTAIN THE RECEPTACLE IN QUESTION IS PROPERLY GROUNDED. IF YOU ARE NOT SURE HAVE A QUALIFIED ELECTRICIAN CHECK THE RECEPTACLE.**

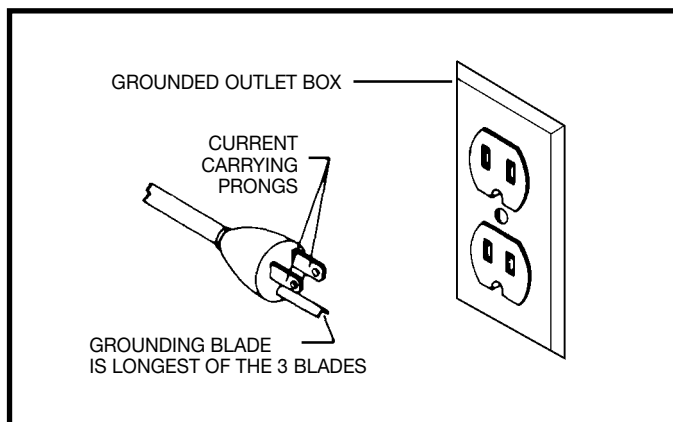

Fig. A

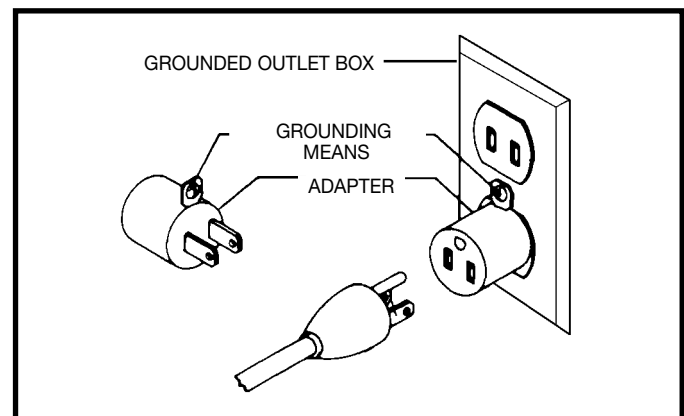

Fig. B

EXTENSION CORDS

Use proper extension cords. Make sure your extension cord is in good condition and is a 3-wire extension cord which has a 3-prong grounding type plug and matching receptacle which will accept the machine's plug. When using an extension cord, be sure to use one heavy enough to carry the current of the machine. An undersized cord will cause a drop in line voltage, resulting in loss of power and overheating. Fig. D, shows the correct gauge to use depending on the cord length. If in doubt, use the next heavier gauge. The smaller the gauge number, the heavier the cord.

MINIMUM GAUGE EXTENSION CORD			
RECOMMENDED SIZES FOR USE WITH STATIONARY ELECTRIC MACHINES			
Ampere Rating	Volts	Total Length of Cord in Feet	Gauge of Extension Cord
0-6	120	up to 25	18 AWG
0-6	120	25-50	16 AWG
0-6	120	50-100	16 AWG
0-6	120	100-150	14 AWG
6-10	120	up to 25	18 AWG
6-10	120	25-50	16 AWG
6-10	120	50-100	14 AWG
6-10	120	100-150	12 AWG
10-12	120	up to 25	16 AWG
10-12	120	25-50	16 AWG
10-12	120	50-100	14 AWG
10-12	120	100-150	12 AWG
12-16	120	up to 25	14 AWG
12-16	120	25-50	12 AWG
12-16	120	GREATER THAN 50 FEET NOT RECOMMENDED	

Fig. D

OPERATING INSTRUCTIONS

FOREWORD

Delta Model 43-505 Router / Shaper is an economical alternative to the production wood shaper. The Router / Shaper has a powerful, 9 amp, induction-type, ball bearing motor for long-lasting trouble free operation. The Router / Shaper also has a thermal overload protection which prevents motor overload.

UNPACKING AND CLEANING

Carefully unpack the machine and all loose items from the shipping container(s). Remove the protective coating from all unpainted surfaces. This coating may be removed with a soft cloth moistened with kerosene (do not use acetone, gasoline or lacquer thinner for this purpose). After cleaning, cover the unpainted surfaces with a good quality household floor paste wax.

NOTICE: THE MANUAL COVER PHOTO ILLUSTRATES THE CURRENT PRODUCTION MODEL. ALL OTHER ILLUSTRATIONS ARE REPRESENTATIVE ONLY AND MAY NOT DEPICT THE ACTUAL COLOR, LABELING OR ACCESSORIES.

ASSEMBLY

⚠️ WARNING: FOR YOUR OWN SAFETY, DO NOT CONNECT THE MACHINE TO THE POWER SOURCE UNTIL THE MACHINE IS COMPLETELY ASSEMBLED AND YOU READ AND UNDERSTAND THE ENTIRE INSTRUCTION MANUAL.

ASSEMBLING ACCESSORY STAND

If you purchased the accessory stand for use with your Router/Shaper, the stand must be assembled as follows:

1. Remove the rubber feet from the bottom of the Router/Shaper.
2. Assemble the stand as shown in Fig. 2. Align the holes in the stand and fasten the stand together by inserting a M8X20mm carriage head bolt through the hole, place a 3/8" flat washer onto the carriage head bolt, thread a M8 hex nut onto the screw, and hand tighten. Repeat this process for the thirty one remaining holes. Do not completely tighten the hardware at this time.

3. **IMPORTANT:** The four top brackets (A) and (B) Fig. 3, of the stand are the same length; however, the top lips of the two brackets (A) must fit over the top of brackets (B), as shown. The left and right side of the Router/Shaper cabinet will then be fastened to the two side brackets (A).

4. Assemble a rubber foot (D) Fig. 4, to the bottom of each leg (E) as shown. **NOTE:** Each rubber foot (D) is provided with a hole for mounting the stand to the floor surface if required.

ASSEMBLING ROUTER/SHAPER TO ACCESSORY STAND

1. Position the Router/Shaper (F) Fig. 5, on the stand (G) lining up the four holes on the bottom of the left and right side of the Router/Shaper cabinet with the four holes on top of the two side brackets (A) Fig. 3. Fasten the machine to the stand by inserting a M8X20mm carriage head bolt through the hole, place a 3/8" flat washer onto the carriage head bolt, thread a M8 hex nut onto the screw, and tighten securely. Repeat this process for the three remaining holes.

2. Push down on top of Router/Shaper (F) Fig. 5, so the legs (G) of stand adjust to the surface of the floor and tighten all stand hardware.



Fig. 2

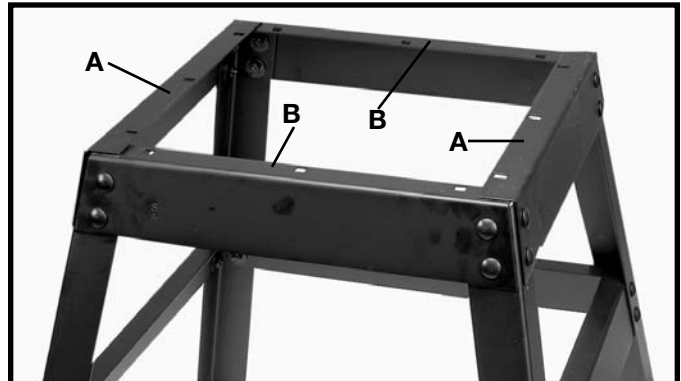

Fig. 3

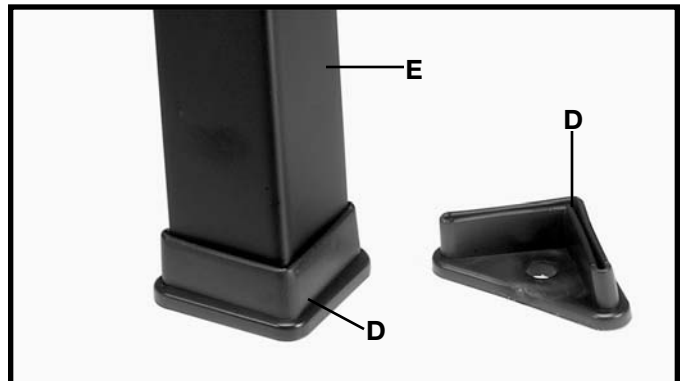

Fig. 4



Fig. 5

ASSEMBLING OVERHEAD CUTTER GUARD BRACKET

Assemble the overhead cutter guard holding bracket (A) Fig. 6, to the rear of the Router/Shaper and fasten with the two M6x10mm sheet metal screws (B).

ASSEMBLING AND INSTALLING FENCE ASSEMBLY AND DUST CHUTE

Two fence halves are supplied as standard equipment with the Router/Shaper. To assemble and install the fence assembly, proceed as follows:

1. **NOTE:** The fence body with the see-thru cutter guard (R) Fig. 7, assembled to it, is to be assembled to the right hand side of the table. Place keyed bottom portion of the left hand fence body (A) Fig. 7, in table slot (B). Insert a 5/16-18x1-1/4" carriage head bolt (C) up through bottom of table slot (B), place a 5/16" flat washer on bolt and secure with lock handle.

2. Place back of wooden fence (E) Fig. 7, against front of fence body (A), as shown. Line up hole in wooden fence (E) with slot (F) in fence body (A) and fasten wooden fence (E) to fence body by inserting a 3/8-16x1-1/2" screw through hole in wooden fence and hole in fence body thread a 3/8-16 hex nut (G) onto the 3/8-16x1-1/2" screw.

3. Assemble the right hand fence assembly (T) Fig. 7, to the table in the same manner.

4. If you will be connecting your Router/Shaper to a dust collection system, assemble the dust chute (H) Fig. 8, to the rear of the table by fastening bottom lip (M) of dust chute to sheet metal plate (N) using two M4x8mm sheet metal screws (J). **IMPORTANT:** Make certain the slot (K) in dust chute fits snugly around table lip (L). Also make certain lip (M) of dust chute, is underneath sheet metal plate (N). **NOTE:** If a dust collection system is not going to be used, do not attach the dust chute.

5. Fig. 9, illustrates the dust chute (H) assembled to the table.

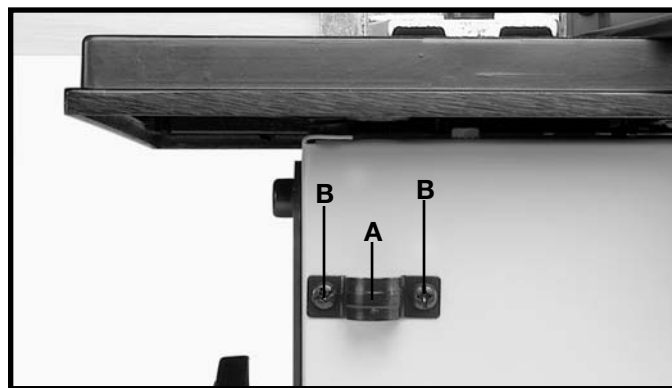

Fig. 6

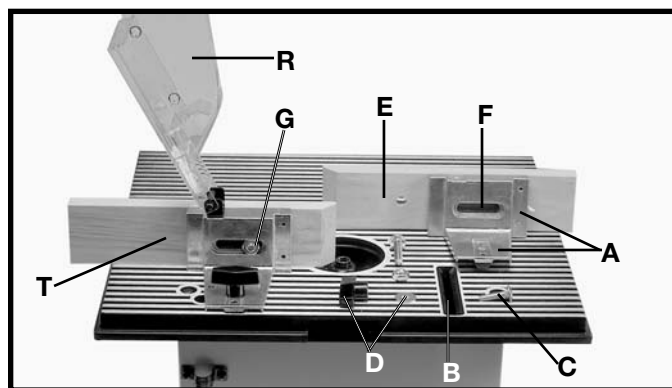

Fig. 7

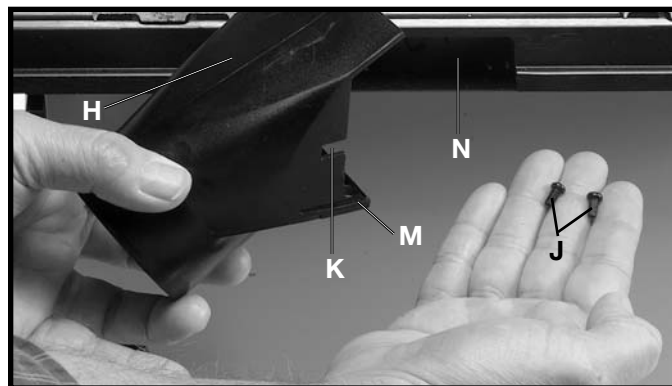

Fig. 8

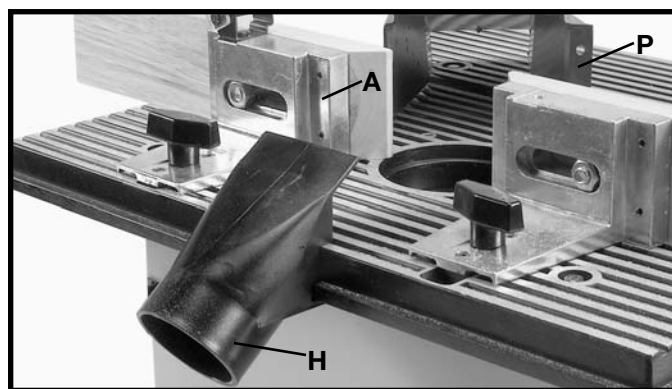

Fig. 9

6. Place dust hood (P) Figs. 9 and 10, over dust chute (H) and fasten dust hood to back of fence body (A) using two M5x10mm sheet metal screws (S), as shown in Fig. 10. **NOTE:** Dust hood (P) should always be used. Dust chute (H) is used only with a dust collection system.

ASSEMBLING TABLE INSERT

The table insert (A) is assembled in the table, as shown in Fig. 11.

FASTENING ROUTER/SHAPER TO SUPPORTING SURFACE

IF DURING OPERATION THERE IS ANY TENDENCY FOR THE ROUTER/SHAPER TO TIP OVER, SLIDE OR WALK ON THE SUPPORTING SURFACE, THE ROUTER/SHAPER SHOULD BE SECURED TO THE SUPPORTING SURFACE. REMOVE THE FOUR RUBBER FEET ATTACHED TO THE ROUTER/SHAPER, AND FASTENING THE MACHINE TO THE SUPPORTING SURFACE WITH FASTENERS (not supplied).

IF YOU PURCHASED THE ACCESSORY STAND, THE FOUR PLASTIC FEET, SUPPLIED WITH THE STAND, FEATURE HOLES WHICH ALLOW THE STAND TO BE SECURED TO A SUPPORTING SURFACE WITH FASTENERS (not supplied).

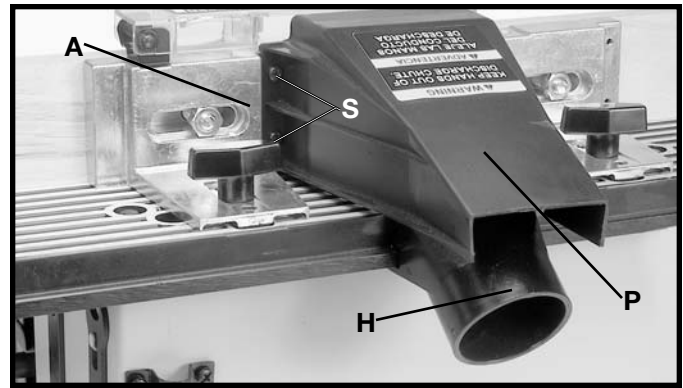

Fig. 10

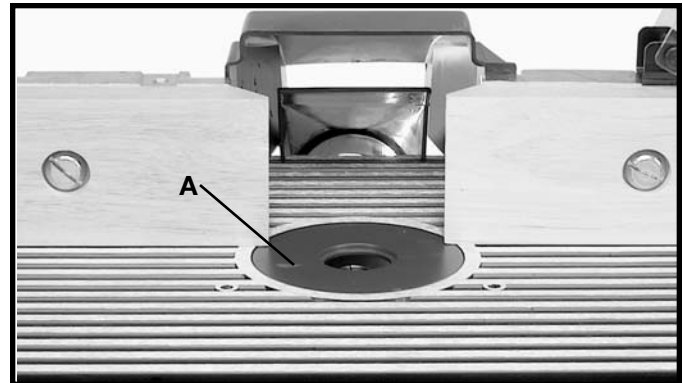

Fig. 11

OPERATING CONTROLS AND ADJUSTMENTS

STARTING AND STOPPING ROUTER/SHAPER

The on/off switch (A) Fig. 14, is located on the front of the Router/Shaper cabinet. To turn the machine "ON," move the switch (A) to the "ON" position. To turn the machine "OFF," move the switch (A) to the "OFF" position.

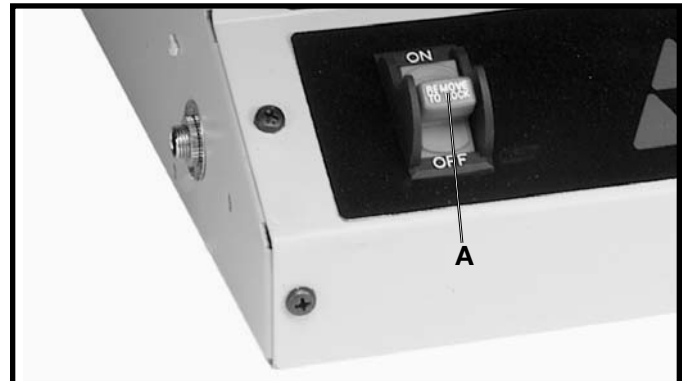

Fig. 14

LOCKING SWITCH IN THE "OFF" POSITION

IMPORTANT: When the machine is not in use, the switch should be locked in the "OFF" position to prevent unauthorized use. This can be done by grasping the switch toggle (B) Fig. 15, and pulling it out of the switch as shown. With the switch toggle (B) removed, the switch will not operate. However, should the switch toggle be removed while the machine is running, it can be turned "OFF" once, but cannot be restarted without inserting the switch toggle (B).

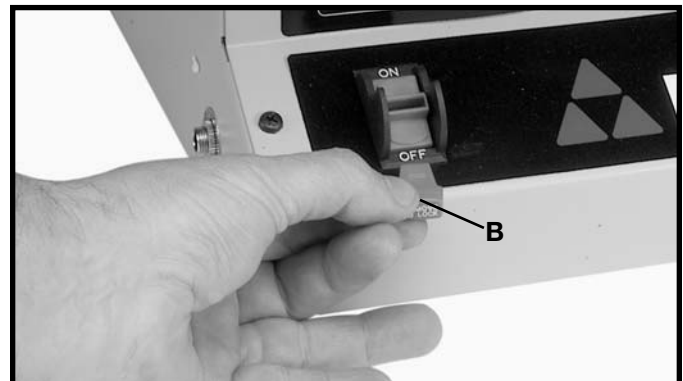

Fig. 15

OVERLOAD PROTECTION

The Router/Shaper is equipped with overload protection. If the motor shuts off, or fails to start due to overloading (cutting stock too fast; using dull bits and cutters; using the machine beyond its capacity or at low voltage, etc.), **TURN THE SWITCH (A) FIG. 16, TO THE "OFF" POSITION.** Let the motor cool three to five minutes and push the overload reset button (C) which will reset the overload device. The machine can then be turned on again in the usual manner.

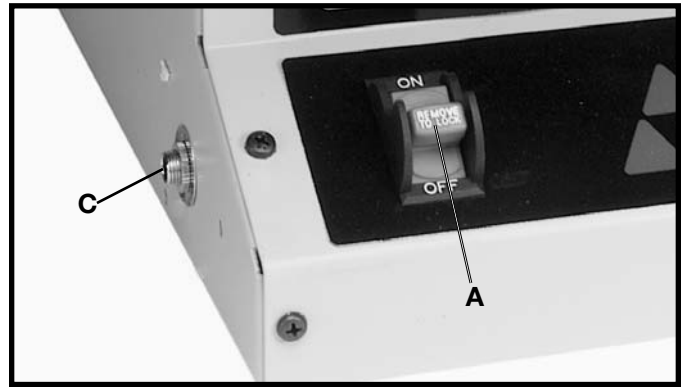

Fig. 16

RAISING AND LOWERING SPINDLE

To raise the spindle, loosen lock knob (A) Fig. 17, and turn the elevation knob (B) clockwise. When the spindle is at the desired height, tighten lock knob (A).

To lower the spindle, loosen lock knob (A) Fig. 17, and turn elevation knob (B) counterclockwise. **NOTE:** Final height setting of the cutter should always be from the bottom to the up position. Always tighten lock knob (A) after adjusting spindle height.

The Router/Shaper is equipped with a spindle height adjustment scale (C) Fig. 17, and spindle height indicator (D). The spindle height indicator moves up or down as the spindle is raised or lowered.

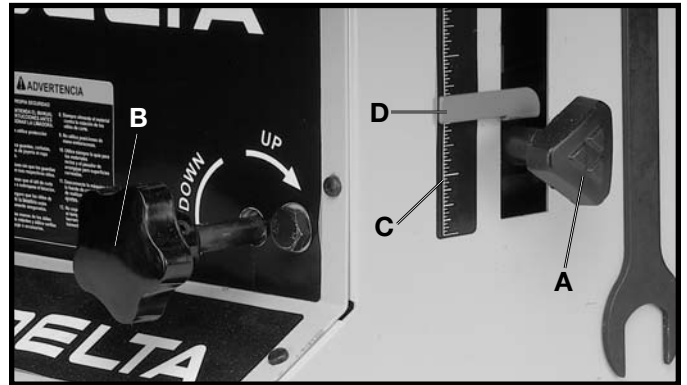

Fig. 17

FENCE ADJUSTMENTS

DISCONNECT MACHINE FROM POWER SOURCE.

Either half of the two-piece fence assembly (A) Fig. 18, can be moved independently. To adjust each fence half, loosen lock knob (B) and move fence half (A) to the desired position depending on the work being performed. Then tighten lock knob (B).

In order to do accurate work, both wooden fence halves must be parallel with each other.

To check and adjust, move both fence halves in or out until they are in line with each other. Using a straight edge check to see if both fence halves are parallel with each other the complete length of the fences. If an adjustment is necessary, loosen four socket head cap screws (C) Fig. 18, located on the fence bracket casting directly in front of and in back of lock knobs (B) Fig. 18, and adjust the fences accordingly. Then tighten the four screws.

To adjust each wooden fence half (C) Fig. 19, for side to side movement, loosen screw (D) and move wooden fence (C) as needed. **IMPORTANT:** Each wooden fence half (C) should be adjusted as close to the cutter as possible, without touching. Once adjustments are made, retighten screw (D).

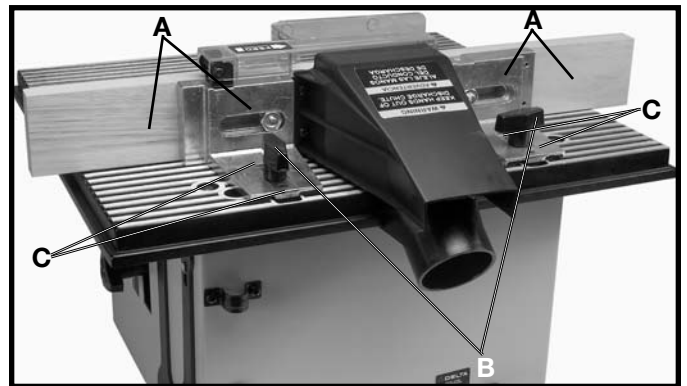

Fig. 18

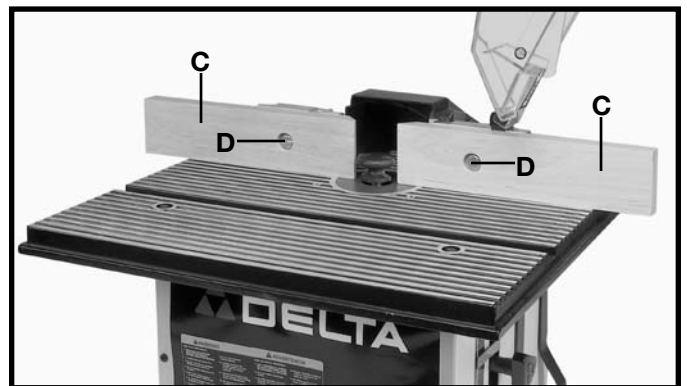

Fig. 19

SEE-THRU CUTTER GUARD

The see-through cutter guard (A) Fig. 20, should always be used when using the fence to guide the work. The guard (A) raises as the workpiece is pushed along the fence and lowers at the completion of the cut.

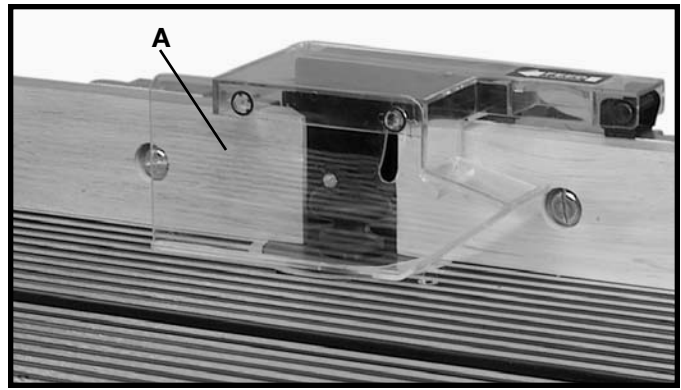

Fig. 20

The guard (A) can be moved up and out of the way as shown in Fig. 21, when changing bits and cutters.

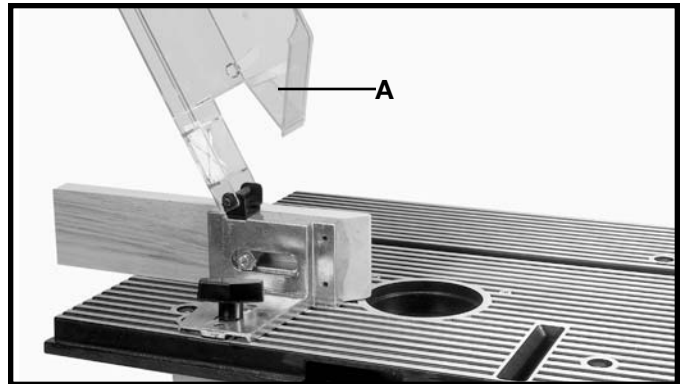

Fig. 21

WRENCH STORAGE

The Router/Shaper is supplied with two wrenches (A) Fig. 22. When not in use, the wrenches (A) can be stored safely out of the way on the two hooks (B) located on the right side of the cabinet, as shown in Fig. 22.

ADJUSTING SPINDLE 90 DEGREES (LEFT AND RIGHT) TO THE TABLE

The spindle has been aligned at the factory so it is 90 degrees, left and right, to the table surface and further adjustment should not be necessary. However, rough handling during shipment or repair or replacement of certain components might disturb this setting. To check and adjust the spindle 90 degrees (left and right) to the table surface, proceed as follows:

1. **DISCONNECT MACHINE FROM POWER SOURCE.**
2. Tighten the spindle height lock knob.
3. Insert a "straight" section of 1/2-inch diameter metal rod, (A) Fig. 23, which is at least 6 inches in length, into router collet (B) and tighten collet (B) as you would a router bit.
4. Using a square (C) Fig. 23, either on the right or the left side of the table, place one end of the square against the metal rod (A) as shown. Check to see if metal rod (A) is 90 degrees (left and right) to the table surface. If an adjustment is necessary, proceed as follows:

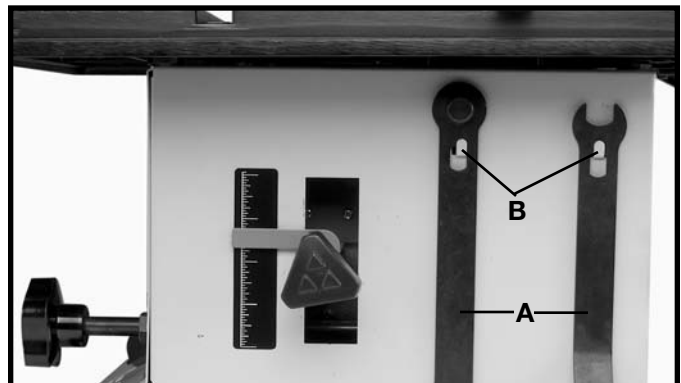

Fig. 22

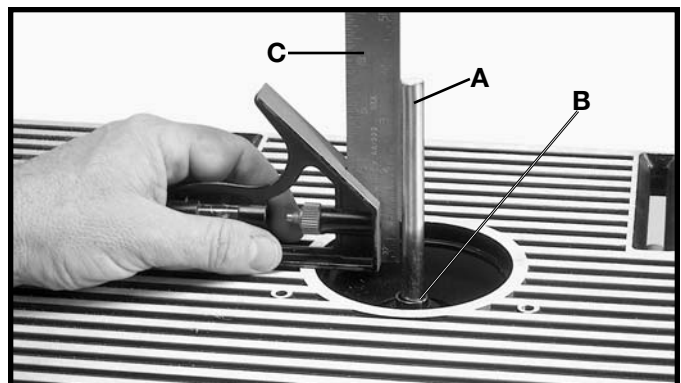

Fig. 23

5. Loosen adjustment bolt (D) Fig. 24, and corresponding bolt at the rear of the machine (not shown).

6. Carefully move the spindle height lock knob (E) Fig. 24, up or down until the metal rod (A) is 90 degrees to the table surface. Then tighten adjustment bolts (D) which were loosened in **STEP 5**.

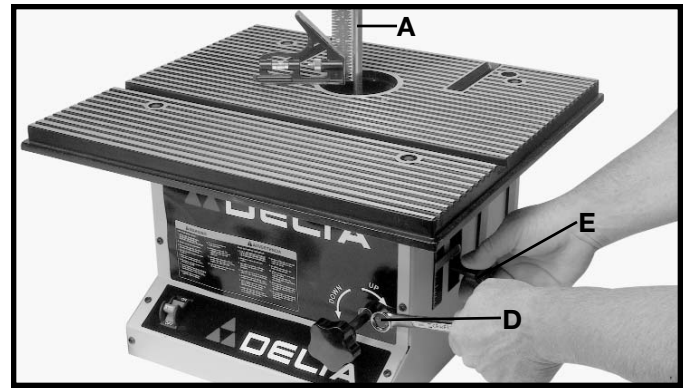

Fig. 24

ADJUSTING TABLE 90 DEGREES (FRONT AND BACK) TO THE SPINDLE

The table has been adjusted at the factory so the table surface is 90 degrees, front and back, to the spindle and further adjustment should not be necessary. However, rough handling during shipment or repair or replacement of certain components might disturb this setting. To check and adjust the table surface 90 degrees (front and back) to the spindle, proceed as follows:

1. **DISCONNECT MACHINE FROM POWER SOURCE.**
2. Tighten the spindle height lock knob.
3. Insert a “straight” section of 1/2 inch diameter metal rod (A) Fig. 25, which is at least 6 inches in length, into router collet (B), and tighten collet (B) as you would a router bit.
4. Using a square (C) Fig. 25, either on the front or rear of the table, place one end of the square against the metal rod (A) as shown. Check to see if the table surface is 90 degrees to metal rod (A) (front to back). If an adjustment is necessary, proceed as follows:
5. Loosen two screws (E) Fig. 25, that fasten the rear of the table to the cabinet.
6. Rotate leveling nut (F) Fig. 26, which is located at the rear of the machine and under the table counterclockwise as far it it will go up into the table.
7. Rotate leveling nut (G) Fig. 26, right or left until table surface (front and back) is 90 degrees to metal rod (A).
8. Turn leveling nut (F) Fig. 26, clockwise until it just contacts top of cabinet.
9. Tighten two screws that were loosened in **STEP 5**.

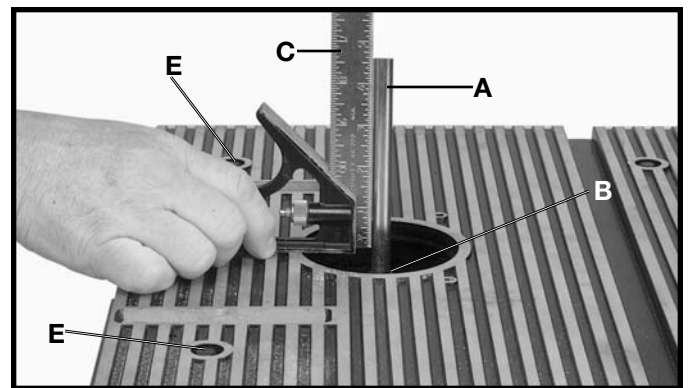

Fig. 25

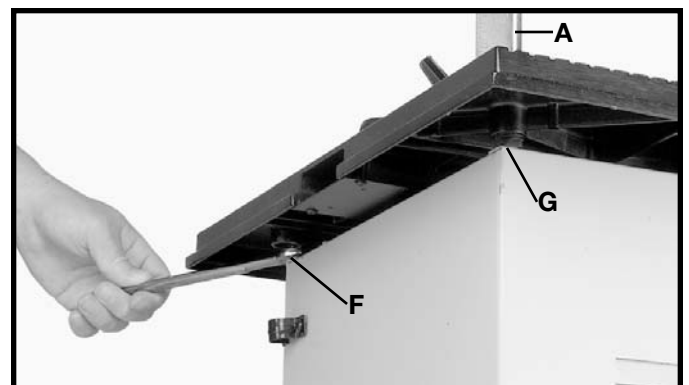

Fig. 26

INSTALLING ROUTER BITS

1. **DISCONNECT MACHINE FROM POWER SOURCE.**
2. Raise spindle to the maximum height and tighten lock knob.
3. This machine is supplied with a 1/2 inch collet (A) Fig. 27, that accepts 1/2 inch shank router bits. A 1/4 inch adapter sleeve (B) Fig. 28, is also furnished that allows you to use 1/4 inch shank router bits.
4. Insert 1/2 inch collet (A) Fig. 27, into spindle assembly (C) and hand tighten nut (D). If you are using 1/4 inch shank router bits, insert 1/4 inch adapter sleeve (B) Fig. 28, into 1/2 inch collet (A), making certain slot (K) in adapter sleeve (B) is aligned with the slot in 1/2 inch collet (A). **NOTE:** This is important for maximum clamping of the router bit in the spindle.
5. Clean and insert shank of router bit (E) Fig. 29, into collet (A) or adapter sleeve until it bottoms, then back out router bit approximately 1/16 inch.
6. Place wrench (F) Fig. 29, on flats of spindle assembly to keep spindle from turning during router bit installation.

NOTE: Spindle wrench (F) Fig. 29, features a round protrusion on one side that makes installation easier. With the open end of wrench (F) Fig. 29, on the flats of the spindle, rotate the wrench until the protrusion slides into the miter gage slot (G) as shown. Place the other wrench (H) on flats of the collet and turn wrench clockwise to tighten router bit in spindle assembly. **CAUTION: Table ridges may be sharp. To avoid personal injury, we suggest that wrenches (F) and (H) supplied with your machine be used when installing and removing router bits.**

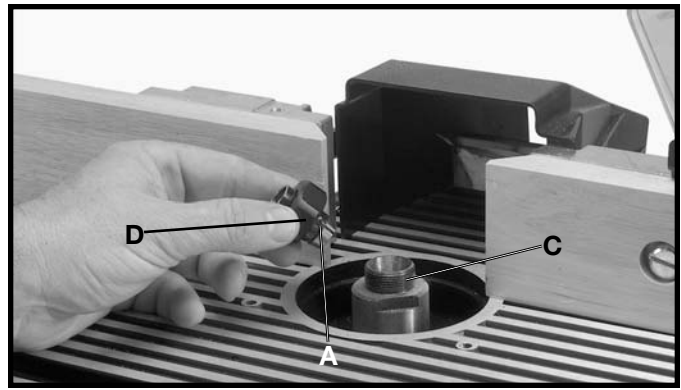

Fig. 27

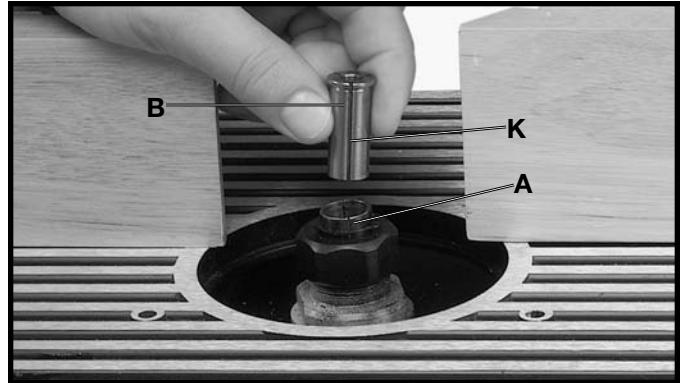

Fig. 28

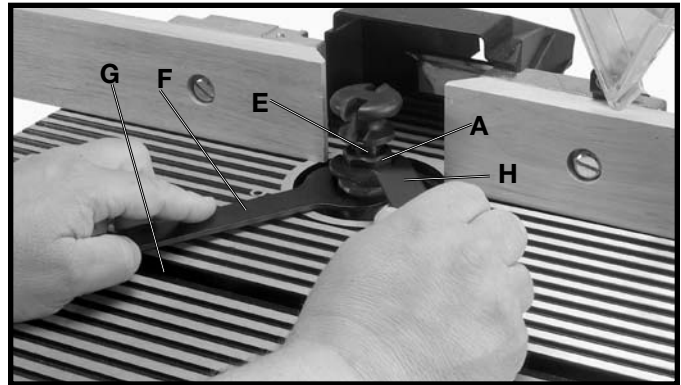

Fig. 29

STARTING PIN

A starting pin (A) Fig. 30, is supplied with your Router/Shaper and is used to support the workpiece at the start of the cut when using the Router/Shaper without the fence. The starting pin can be inserted into either one of the two holes (B) provided in the table.

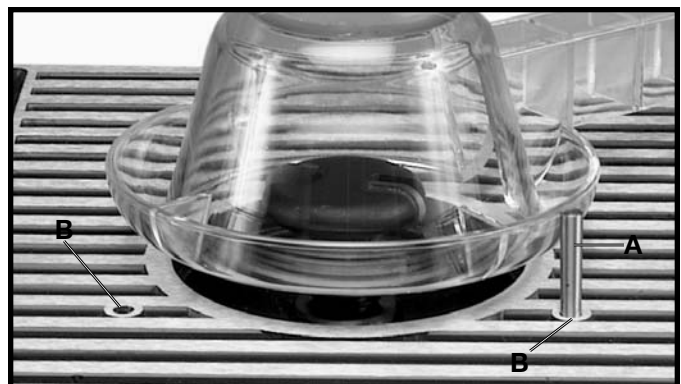

Fig. 30

INSTALLING OVERHEAD CUTTER GUARD

An overhead cutter guard, shown in Fig. 31, is supplied as standard equipment with your Router/Shaper and should always be used for operations that require the fence to be removed. To install the overhead cutter guard, proceed as follows:

1. **DISCONNECT MACHINE FROM POWER SOURCE.**
2. Remove the fence assembly from the table.
3. Insert rod (A) Fig. 31, of overhead cutter guard through hole in rear of table, as shown, and into bracket (C). **NOTE:** It may be necessary to loosen bracket (C) in order to insert rod (A). Adjust the height of the overhead guard (D) until the rim of the guard (D) lays flat on the workpiece and tighten two screws, both of which are shown at (E) Fig. 31. The guard raises as the workpiece moves against the cutter, and lowers at the completion of the cut.

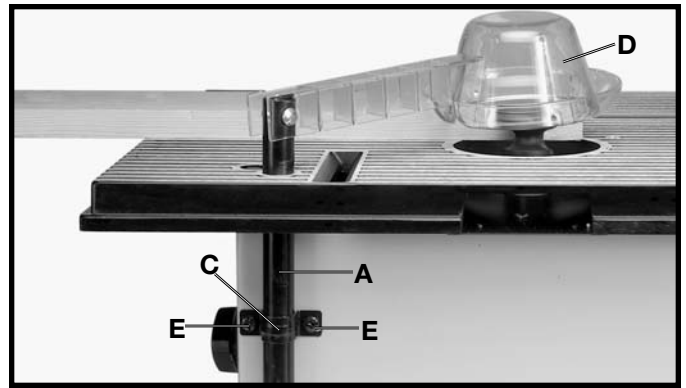

Fig. 31

INSTALLING ACCESSORY SHAPER SPINDLE

An optional 1/2" shaper cutter spindle that accommodates 1/2" bore shaper cutters is available for use with your Router/Shaper and can be installed as follows:

1. **DISCONNECT MACHINE FROM POWER SOURCE.**
2. Raise spindle as far as it will go and lock spindle height lock knob.
3. Assemble collet (A) Fig. 32.
4. Insert accessory shaper spindle (B) Fig. 33, into collet (A). Tighten shaper spindle (B) Fig. 34, in collet (A) using wrenches supplied (C).
5. Fig. 35, illustrates the shaper spindle (B) and shaper cutter (D) installed in the collet (A). After installing shaper cutter, fences (E) Fig. 35, should be moved as close as possible to the cutter (D) without touching. **IMPORTANT:** Always use table insert whenever possible.

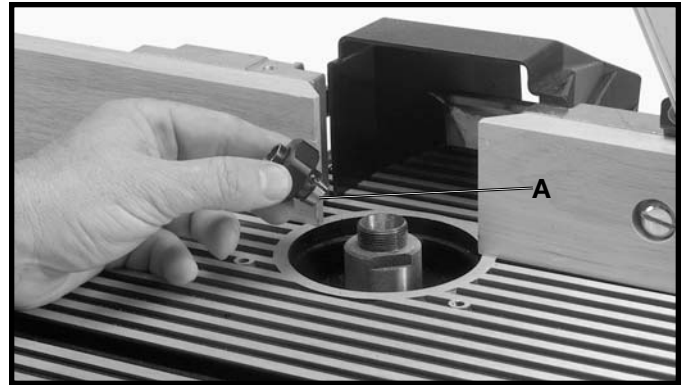

Fig. 32

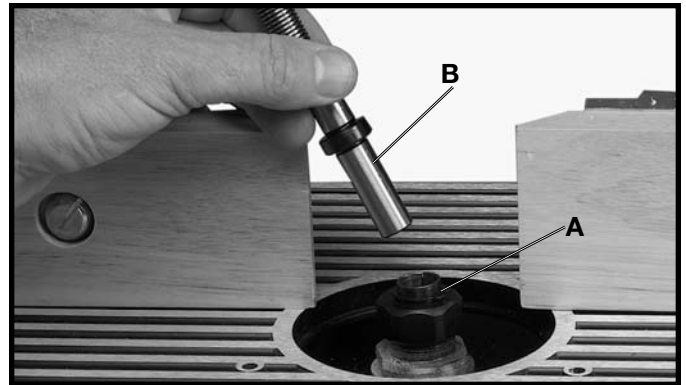

Fig. 33

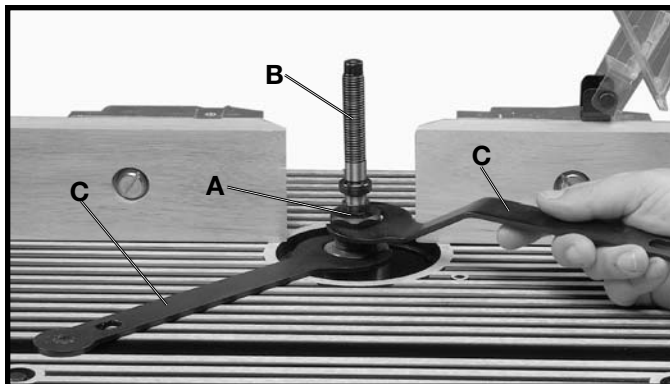

Fig. 34

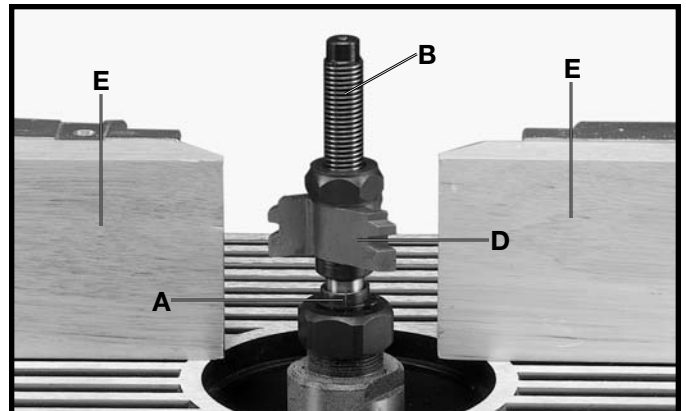

Fig. 35

OPERATION

The following is an example of the setting-up and operational procedures when using the fence, collars and starting pin. Please review this information carefully before turning on the power to avoid damage to the machine or personal injury. **WARNING:** The use of accessories and attachments not recommended by Delta may result in risk of injuries.

ROUTING OR SHAPING WHEN USING THE FENCE AS A GUIDE AS A GUIDE

Using the fence is the safest and most satisfactory method of shaping and routing and this method should always be used when the work permits. Almost all straight work can be shaped using the fence as follows:

1. For average work, where a portion of the original edge of the work is not touched by the cutter, both the front and rear fences are in a straight line, as shown in Fig. 36.
2. When the operation removes the entire edge of the work, e.g., in jointing or making a full bead, the shaped edge will not be supported by the rear fence when both fences are in line, as shown in Fig. 37. In this case, the work should be advanced to the position shown in Fig. 37 and stopped. Then turn the machine off.
3. The rear fence should then be advanced to contact the work, as shown in Fig. 38. The rear fence will then be in line with the cutting circle.

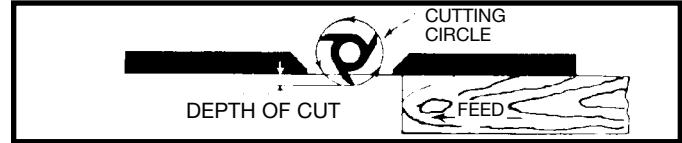

Fig. 36



Fig. 37



Fig. 38

ROUTING OR SHAPING WITH COLLARS AND STARTING PIN

When using collars and starting pin, the following rules must always be followed for good work and safety in operation.

1. Collars **MUST** be smooth and free of all gum or other substances.
2. The edge of the work to be shaped **MUST** be smooth, as any irregularity in the surface which rides against the collar will be duplicated on the molded surface.
3. A portion of the edge of the work **MUST** remain untouched by the cutters in order that the collar will have sufficient bearing surface. Fig. 39, illustrates the **wrong way** for the operation while Fig. 40 illustrates the **right way**.
4. The work **MUST** be fairly heavy in proportion to the cut being made as shown in Fig. 41. Under **NO** circumstances should short work of light body be shaped against the collars as shown in Fig. 42.
5. When shaping or routing with collars and starting pin, the overhead guard, supplied with the machine, should always be used.

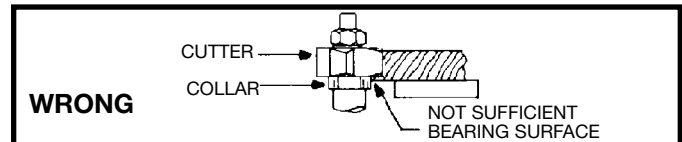

Fig. 39

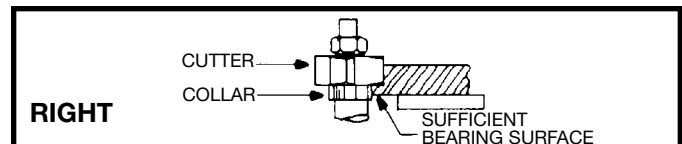

Fig. 40

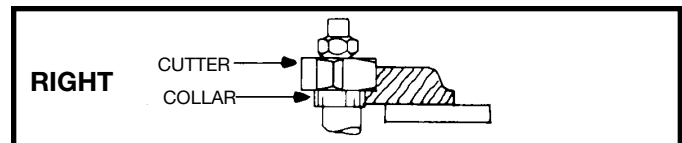

Fig. 41

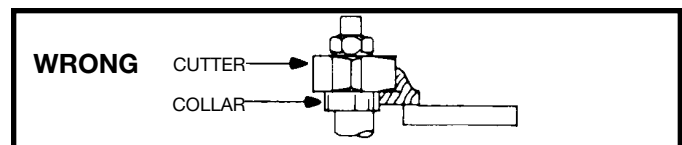

Fig. 42

POSITION OF COLLARS

1. The collars may be used in any of the following positions: above, below or between two cutters.
2. When the collar is used below the cutter, as shown in Fig. 43, the progress of the cut can be observed at all times. However, any accidental lifting of the work will gouge the wood and ruin the workpiece.
3. When the collar is used above the cutter as shown in Fig. 44, the cut cannot be seen, yet this method offers some advantage in that the cut is not affected by slight variations in the thickness of the stock. Also accidental lifting of the work will not gouge the workpiece. Simply correct the mistake by repeating the operation.
4. The collar between cutters method, as shown in Fig. 45, has both the advantages of the first two methods and is frequently used where both edges of the work are to be shaped.

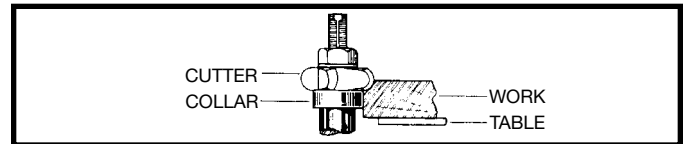

Fig. 43

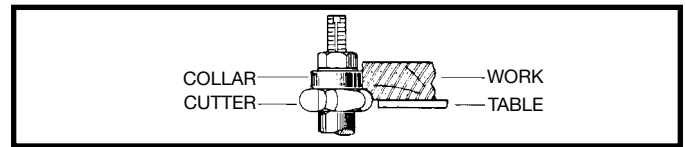

Fig. 44

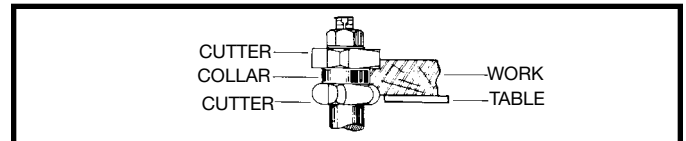

Fig. 45

STARTING PIN

1. Your machine is supplied with a tapered starting pin which is used as a support when starting the cut. The starting pin is placed in one of the two tapered holes in the table.
2. The work should be placed in the first position using the guide pin as a support, as shown in Fig. 46. Then swing the work into the cutter as shown in the second position. The work will now be supported by the collar and starting pin as shown in Fig. 46.
3. After the cut has been started, the work is swung free of the starting pin, and rides only against the collar as shown in the third position Fig. 47. **ALWAYS FEED AGAINST THE ROTATION OF THE CUTTER.**

IMPORTANT: If the work would be advanced to the cutter without the side support of the starting pin, it would invariably be kicked back.

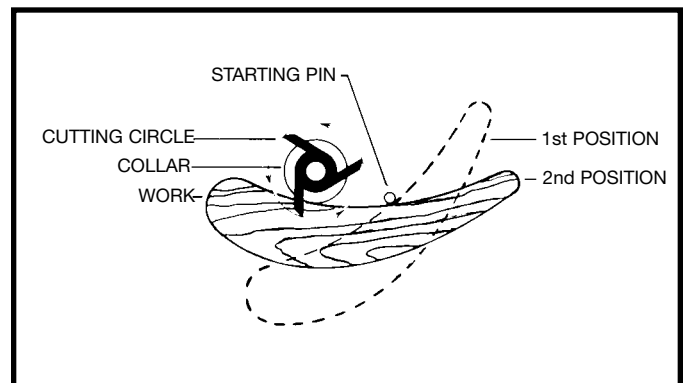

Fig. 46

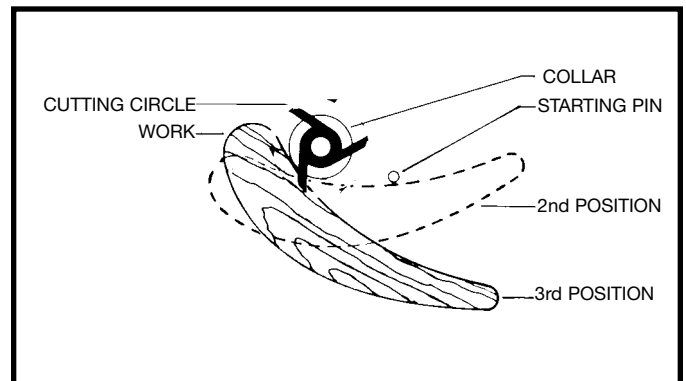



Fig. 47

ACCESSORIES

A complete line of accessories is available from your Delta Supplier, Porter-Cable • Delta Factory Service Centers, and Delta Authorized Service Stations. Please visit our Web Site www.deltamachinery.com for a catalog or for the name of your nearest supplier.

 **WARNING:** Since accessories other than those offered by Delta have not been tested with this product, use of such accessories could be hazardous. For safest operation, only Delta recommended accessories should be used with this product.



PARTS, SERVICE OR WARRANTY ASSISTANCE

All Delta Machines and accessories are manufactured to high quality standards and are serviced by a network of Porter-Cable • Delta Factory Service Centers and Delta Authorized Service Stations. To obtain additional information regarding your Delta quality product or to obtain parts, service, warranty assistance, or the location of the nearest service outlet, please call 1-800-223-7278 (In Canada call 1-800-463-3582).



Two Year Limited Warranty

Delta will repair or replace, at its expense and at its option, any Delta machine, machine part, or machine accessory which in normal use has proven to be defective in workmanship or material, provided that the customer returns the product prepaid to a Delta factory service center or authorized service station with proof of purchase of the product within two years and provides Delta with reasonable opportunity to verify the alleged defect by inspection. Delta may require that electric motors be returned prepaid to a motor manufacturer's authorized station for inspection and repair or replacement. Delta will not be responsible for any asserted defect which has resulted from normal wear, misuse, abuse or repair or alteration made or specifically authorized by anyone other than an authorized Delta service facility or representative. Under no circumstances will Delta be liable for incidental or consequential damages resulting from defective products. This warranty is Delta's sole warranty and sets forth the customer's exclusive remedy, with respect to defective products; all other warranties, express or implied, whether of merchantability, fitness for purpose, or otherwise, are expressly disclaimed by Delta.

Printed in U.S.A.

NOTES

NOTES

Free Manuals Download Website

<http://myh66.com>

<http://usermanuals.us>

<http://www.somanuals.com>

<http://www.4manuals.cc>

<http://www.manual-lib.com>

<http://www.404manual.com>

<http://www.luxmanual.com>

<http://aubethermostatmanual.com>

Golf course search by state

<http://golfingnear.com>

Email search by domain

<http://emailbydomain.com>

Auto manuals search

<http://auto.somanuals.com>

TV manuals search

<http://tv.somanuals.com>