

ON LINE
N-Series

U ninterruptible
P ower
S upply

700VA~3KVA

User's Manual

1. IMPORTANT SAFETY INSTRUCTIONS

1-1 UL safety instructions

SAVE THESE INSTRUCTIONS - This manual contains important instructions for our UPS that should be followed during installation and maintenance of the UPS and batteries.

- To reduce the risk of electric shock, install this UPS in a temperature and humidity controlled indoor area free of conductive contaminants. Ambient temperature must not exceed 40°C (104°F).
- The AC output of the UPS need a disconnect switch such as a breaker which has to be provided by others.
- The over-current protection for the output AC circuit has to be provided by others. All of our UPS has an electronic protection of AC output short circuit.

[1KVA MODEL]Federal Communications Commission Interference Statement

This equipment has been tested and found to comply with the limits for a Class B digital device, pursuant to Part 15 of the FCC Rules. These limits are designed to provide reasonable protection against harmful interference in a residential installation. This equipment generates, uses and can radiate radio frequency energy and, if not installed and used in accordance with the instructions, may cause harmful interference to radio communications. However, there is no guarantee that interference will not occur in a particular installation. If this equipment does cause harmful interference to radio or television reception, which can be determined by turning the equipment off and on, the user is encouraged to try to correct the interference by one of the following measures:

- Reorient or relocate the receiving antenna
- Increase the separation between the equipment and receiver.
- Connect the equipment into an outlet on a circuit different from that to which the receiver is connected.
- Consult the dealer or an experienced radio/TV technician for help.

FCC Caution: To assure continued compliance, (example-use only shielded interface cables when connecting to computer or peripheral devices). Any changes or modifications not expressly approved by the party responsible for compliance could void the user's authority to operate this equipment.

This device complies with Part 15 of the FCC Rules. Operation is subject to the following two conditions: (1) this device may not cause harmful interference, and (2) this device must accept any interference received, including interference that may cause undesired operation.

DELTA PRODUCTS CORPORATION CALIFORNIA (DPC)
4405 CUSHING PARKWAY
FREMONT, CA94538, U.S.A.
TEL: 1-510-668-5100

Other safety notes:

- Examine the packing container for damage. Notify the carrier immediately if damage is present.
- Do not disassemble the UPS.
- Plug the UPS into a grounded 3-wire AC receptacle only.
- Do not use extension cords.
- Do not operate in area near water or excessive humidity.
- Keep liquid and foreign objects from getting inside the UPS.
- Install UPS in a well-ventilated area. Do not block air vents in front of UPS or air exhausts in the back.
- Do not operate close to gas or electric half bridge rectified load, into the UPS receptacles.
- Do not plug appliances, such as half bridge rectified load, into the UPS receptacles.
- Do not operate if the unit is leaking liquid or if a white powdery residue is present.
- Batteries may contain metals and other chemical hazardous waste. For proper disposal, consult your local state and federal EPA and other environmental laws and regulations.
- Use only the power supply cord provided with this unit. The power cord for UPS is wired in accordance with National Electrical Code (NEC) specifications. Be sure that the wall outlet is wired to these specifications into the wall outlet.
- The UPS contains its own energy source (battery). The output receptacles may be live even when the UPS is not connected to an AC supply.
- Once you have connected the battery connectors, do not attempt to lift the cabinets.
- Do not connect or disconnect the battery cabinets while the UPS is operating from battery.

[2,3KVA MODELS] Federal Communications Commission Interference Statement

This equipment has been tested and found to comply with the limits for a Class A digital device, pursuant to Part 15 of the FCC Rules. These limits are designed to provide reasonable protection against harmful interference when the equipment is operated in a commercial environment. This equipment generates, uses and can radiate radio frequency energy and, if not installed and used in accordance with the instructions manual, may cause harmful interference to radio communications. Operation of this equipment in a residential area is likely to cause harmful interference in which case the user will be required to correct the interference at his own expense.

FCC Caution: To assure continued compliance, (example-use only shielded interface cables when connecting to computer or peripheral devices). Any changes or modifications not expressly approved by the party responsible for compliance could void the user's authority to operate this equipment.

1-2 TUV safety instructions

Please observe the following precautions to ensure personnel safety and reliable equipment operation:

- The sound pressure level at the operators position according to IEC 704-1:1982 is equal or less than 70dB(A).
- Der arbeitsplatzbezogene Schalldruckpegel dieses Gerätes nach DIN 45635 beträgt 70dB (A) oder weniger.

For installation:

- The unit should be installed from service personnel.
- Dieses Gerät ist durch Elektrofachkräfte zu installieren.
- To prevent an overbalance of this equipment, the stabilizer must be mounted at the bottom of the enclosure.
- Upon installation, it should be ensured that the sum of the leakage current of the UPS and the connected consumer does not exceed 3.5mA.
- Bei der Installation dieses Gerätes ist darauf zu achten, daß die Ableitströme der USV und der angeschlossenen Verbraucher den Maximalwert von 3.5 mA nicht überschreiten.
- The socket-outlet shall be near the equipment and easily accessible.
- Die Gerätesteckdose muß nahe dem Gerät angebracht und leicht zugänglich sein.

Other safety instructions:

- The UPS contains voltages which are potentially hazardous. All repairs should be performed by qualified service personnel. The UPS has its own internal energy source (Battery). The output receptacles may be alive even when the UPS is not connected to the mains.
- Die USV enthält Spannungen die möglicherweise gefährlich sind. Alle Reparaturen sollten nur von ausgebildeten Monteuren durchgeführt werden. Die USV hat eine interne Stromversorgung (Batterien). Die Ausgangsanschlüsse können daher unter Strom stehen auch wenn die USV nicht an das Versorgungsnetz angeschlossen ist.
- When replacing batteries, always use the same type and quantity as the previous one. Batteries of GP1270-F2(CSB), NP7-12(YUASA) , 1234W(CSB).
- Falls Sie die Batterien austauschen, verwenden Sie bitte ausschließlich die gleiche Anzahl und die folgenden Batterietypen: GP1270-F2(CSB), NP7-12(YUASA), 1234W(CSB).
- Do not dispose the battery or batteries in fire as this may explode.
- Werfen Sie niemals die Batterien in das Feuer, die Batterien könnten explodieren.
- Do not open or mutilate the battery or batteries as released electrolyte is toxic and harmful to skin and eyes.
- Öffnen oder beschädigen Sie nicht die Batterien, ausfließendes Elektrolyt ist schädlich für Haut und Augen.

- A battery can present a risk of electric shock and high short circuit current. The following precaution should be observed when working on batteries.
 - Remove watches, rings or other metal objects.
 - Use tools with insulated handles.
- Eine Batterie kann eine Gefahr eines elektrischen Schlages und sehr großer Kurzschlussströme beinhalten. Folgende Vorkehrungen sollten getroffen werden, wenn Sie mit der Batterie arbeiten.
 - * Entfernen Sie Uhren, Ringe und andere metallische Objekte.
 - * Verwenden Sie Werkzeug mit isolierten Griffen.
- The equipment is to be operated by fully trained personnels.
- Diese Gerät ist nur durch unterwiesenes Personal zu bedienen.
- **EC conformity declaration**
- These devices comply with the regulations of the following guide-lines:
 - 73/23/EEC guide-line of the Council for approximation of the legal regulations of the EC countries concerning the electrical apparatus within certain voltage tolerances, modified by the guide-line RL 93/68/EEC of the Council.
 - 89/336/EEC guide-line of the Council for approximation of the legal regulations of the EC countries concerning the electromagnetic compatibility, modified by the guide-lines RL 91/236/EEC,..... and 93/68/EEC of the Council.
- The compliance with the following standards proves the conformity:
 - EN 50091-1-1
 - EN 55022/EN 55011, class B.

2 INTRODUCTION

2-1 Theory of operation

The main topology of the UPS consists of bypass path, AC-DC converter, DC-AC inverter, battery charger, DC-DC converter, control circuit and detection circuit. Moreover, the intelligent power management software is also optional. The function and efficiency are superior to the traditional UPS.

Description of block diagram

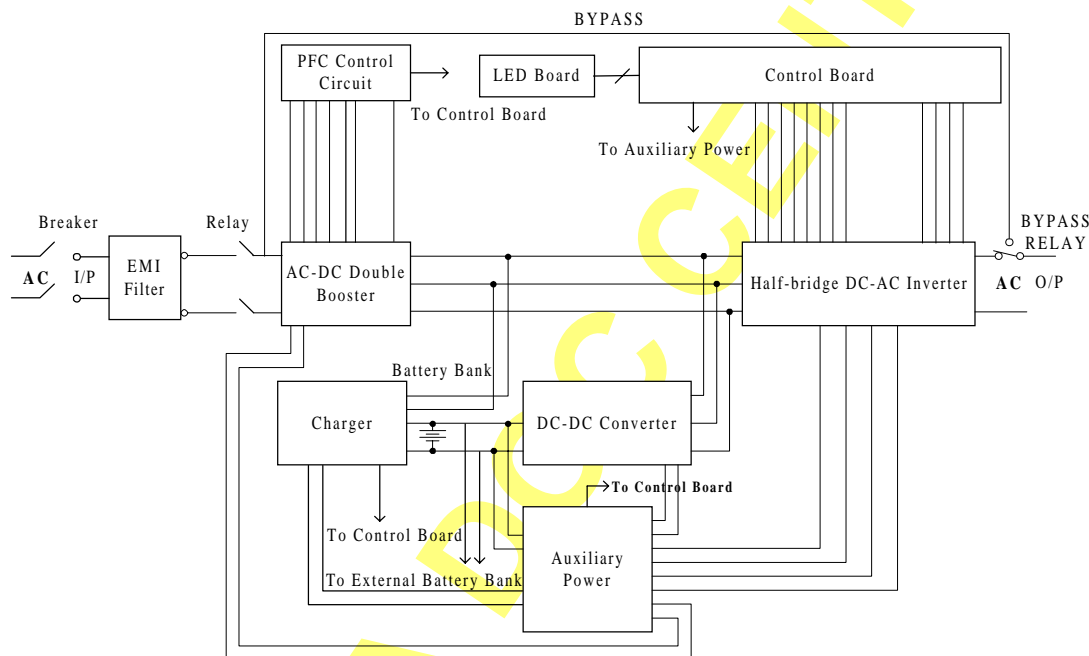

Fig. 2.1 is the hardware block diagram of the UPS.

The UPS operation is described as below:

When the utility power is applied into the UPS, it was divided into two ways after going through the breaker and EMI filter. One way is connected to AC-DC converter which converts the utility AC power into a DC voltage which is called DC-BUS voltage then divide into two path. One path goes to charger which converts the DC-BUS voltage into a proper DC voltage to charge the UPS battery. The other path goes into DC-AC half bridge inverter. The other way works as a bypass path. The bypass relay near the output will choose either the bypass path or inverter output. In general, the UPS will internally do the self-diagnosis. If there is no problem, the bypass relay will choose the inverter output. This is so called “**ON-LINE mode**”.

In case the utility power fail, the AC-DC converter and charger will be off duty. The DC-DC converter works and converts the battery voltage into DC-BUS voltage. The DC-AC inverter converts the DC-BUS voltage into AC voltage. This is so called “**ON-BATTERY mode**”.

The auxiliary power circuit supplies the designated power to all the control circuits.

Because the DC-AC inverter is always working, the DC-DC converter can work rapidly and replace the AC-DC converter while the utility power fails. Furthermore, the bypass relay continuously keeps in the position of inverter output to supply the regulated power for the load. There is no power failure to loading equipment.

2-2 Feature

The UPS, available in 700VA, 1KVA, 2KVA and 3KVA, is an advanced on-line UPS providing reliable and consistent sine-wave quality power to vital equipment. It supports personal computers, networks, servers, telecommunication equipment and a variety of other facilities. With its outstanding protection features, the unit keeps your applications safe and running smoothly at all times.

High power density

Other than traditional UPS adopting 0.7 output power factor, the UPS uses the latest technology and highest quality components giving output power factor up to 0.8. Compared to other UPS (1000VA/700W), these UPS series boosts a 12% more output power. This UPS with its compact size, generates higher power density thus giving convenience to the users. Moreover, through the use of advanced technology, the UPS efficiency increases to more than 87%. Compared with other traditional UPS with only 80 to 85% efficiency, this UPS produces greater electric power efficiency at less electric costs.

PFC (Power Factor Correction)

With this function, the investment in the capacity of circuit breakers can be reduced, specially it will be highly regarded as an important feature in critical load applications.

Complete Protection

On-line double conversion design, pure sinewave output and zero transfer time provide best protection. With a built-in surge, spike and line noise protection, the UPS prevents destructive hardware damage and extends system life. The EMI/RFI filtering design prevents electrical noise from affecting computer operation and data files. Besides, the UPS provides built-in Fax/Network cable (RJ11/RJ45) jacks protecting your hardware from surge, spikes and line-noise which travel along communication lines, therefore providing you a complete “back door” protection.

Intelligent design

Integrated with a microprocessor, the UPS is able to perform intelligent functions. The UPS triggers over-voltage protection function and transfers to “**On- Battery mode**” even when utility voltage exceeds 300V for 200V-series. In addition, the UPS can accept large voltage variation of 65V to 138V for 100V-series or 130V to 275V for 200V-series. Wide input voltage range means less battery power usage frequency and longer battery life-span. Besides, programmable outlet design, suitable for power management, is also included in this unit.

Considerate design

Battery start function allows startup of the UPS even when there is no AC line available. In addition, the UPS which was shut down by remote control during power line blackout will restart automatically when AC power recovers. Using our automatic frequency sensing function to match input and output frequency, users don't need to set either 50Hz or 60Hz. Other features, such as UPS self-diagnosis and flexible external battery pack, are also included.

Green function design

The UPS comes with an intelligent fan design, which can have variable fan speed depending on load status, thereby saving the use of power and reducing audible noise. Besides, the operation in sleeping mode is designed to just keep charging which saves the energy a lot.

User friendly interface

The UPS provides a variety of functions which meet users' needs. Users can instantly understand the status of the UPS via the informative LED display. Audible alarms, bar meters and status indicators, such as battery replace indication, UPS fault, line condition, overload etc. are simple and easy for user to understand. Moreover, users can simply reset the circuit breaker instead of having to replace a fuse in the event of output overload.

Safety approvals

The UPS has passed various safety regulations. UL/cUL, TUV/EMC, TUV/GS, CE mark and other safety approvals, proves that the UPS is a safe reliable solution to your power problems.

Network Management

Build-in communication interface port supporting **RS232** and **Dry contact** protocols enhances the reliability and manageability of the UPS over all major operating systems, including Windows 95/98, Windows NT, Netware, Unix, and others. Besides, the UPS also supports the **Simple Network Management Protocol** and **Hyper Text Transfer Protocol** via plugging a **SNMP/HTTP** adapter into the build-in **SNMP** slot.

2-3 Annotation and symbol

The two signs shown on the manual indicating important instruction need to be followed.



Read before Operation

Maybe Dangerous/Follow Instructions

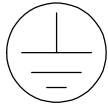

PROTECTIVE GROUNDING TERMINAL: A terminal which must be connected to earth ground prior to making any other connection to the equipment.



This symbol indicates the word “phase”.



This symbol indicates the principal on/off switch is in the “ON” position.



This symbol indicates the principal on/off switch is in the “STANDBY” position.

2-4 FRONT PANEL

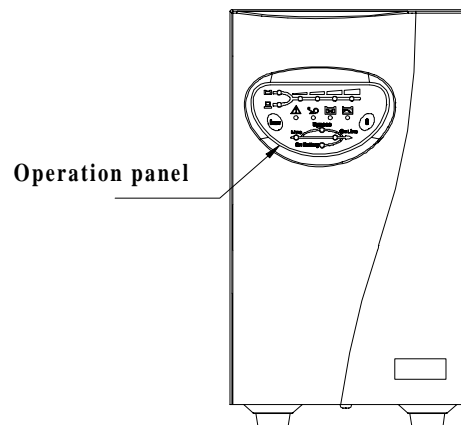

Fig 2-1.1 Front Panel for 700VA or 1KVA

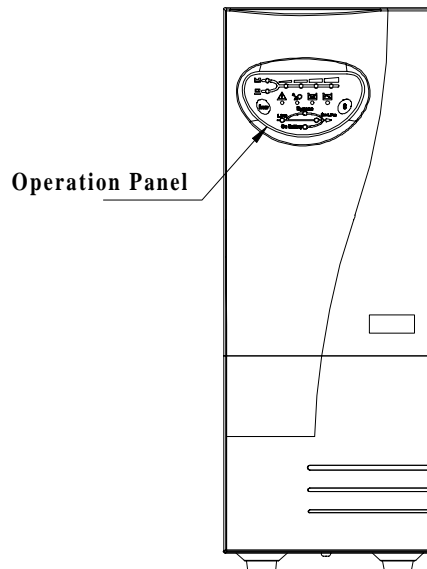

Fig 2-1.2 Front Panel for 2KVA or 3KVA

2-5 OPERATION PANEL

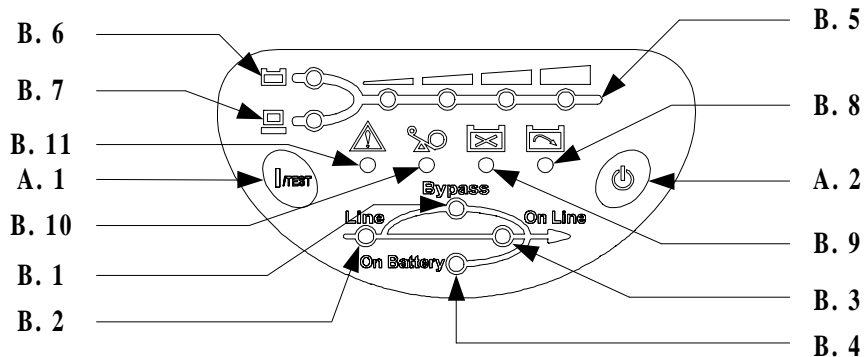

Fig 2-2 Operation Panel

OPERATION PANEL

A. Button:

1. **1/TEST:** The button is used for turning on the UPS, it also can perform the test function in **"ON-LINE mode"**. In backup mode, this button can turn off the buzzer for silence.
2. **0:** The button is used for turning off UPS.

B. LED display:

1. **Bypass:** The LED indicates UPS in **"BYPASS mode"**.

2. **Line:** The LED indicates the condition of UPS input line. If the input voltage is too low, too high or out of frequency this LED will flash. When line is blackout or **ultra** high voltage (>150Vac for 100-series, >300Vac for 200-series), this LED will light off.
3. **ON Line:** The UPS is running in “**ON-LINE mode**”.
4. **ON Battery:** The UPS is running in “**ON-BATTERY mode**” (backup mode), the internal batteries supply power.

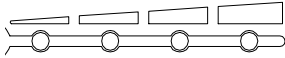

5. **Level LEDs:** The four LEDs indicates the battery capacity in “**ON-BATTERY mode**” or UPS load percentage in “**ON-LINE mode**”.



6. **Battery:** “Level LEDs” shows the current battery capacity when the LED lights up.



7. **Load:** “Level LEDs” shows the UPS load level when the LED lights up.



8. **Battery low:** The LED indicates the battery in battery low condition.



9. **Battery replace:** The LED indicates the batteries are weak and suggest the user to replace the batteries.



10. **Overload:** The LED indicates UPS' load exceed the rating, after a limited period, the UPS will transfer to “**BYPASS mode**” and the LED will still light on to alarm the user.



11. **Fault:** The LED indicates that the UPS is fault. This LED also shows a site wiring fault message when UPS is in “**STANDBY mode**”. It will warn the user that UPS has a site wiring fault from AC power.

2.6 REAR PANEL

The rear panel is explained as follows: (Please refer to fig 2-3, 2-4)

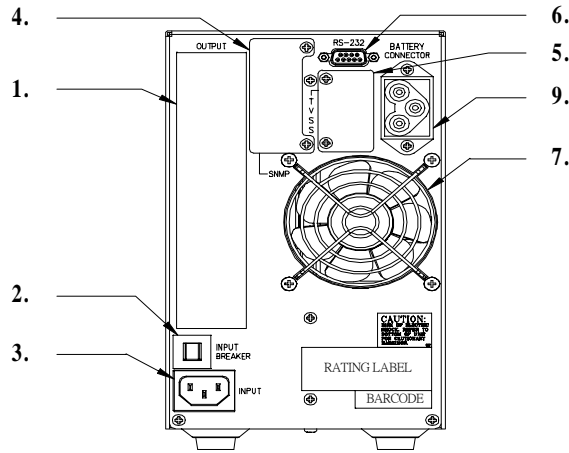

Fig 2-3 700VA, 1KVA

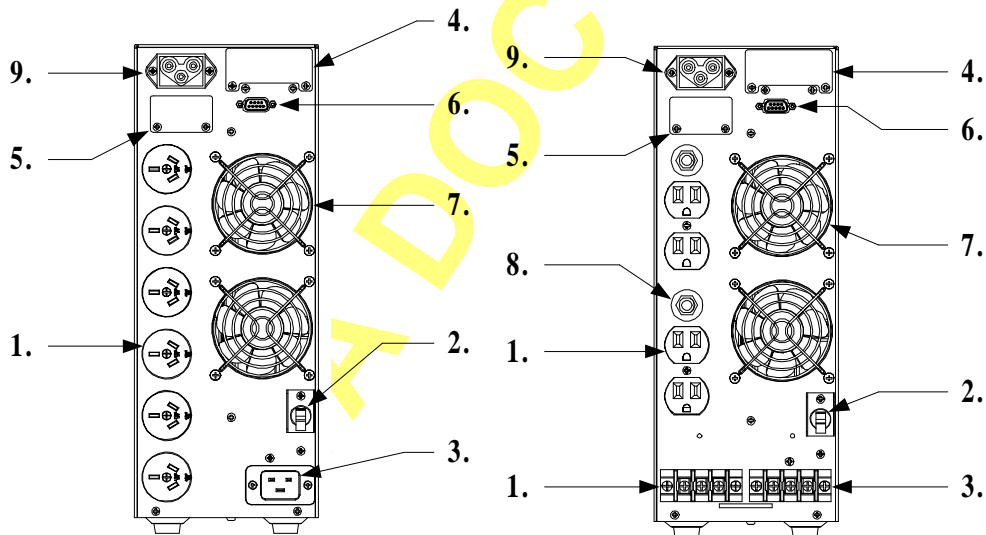

Fig 2-4 2KVA, 3KVA

- 1. OUTPUT RECEPTACLES or TERMINAL:** The UPS supplies AC power to the load via these receptacles and terminal. There are several kinds of output connector for different demands, like:

- NEMA 5-20R type
- NEMA 5-15R type
- IEC320 type
- AUSTRALIAN type

2. **I/P BREAKER:** This is used to prevent high input current from the UPS.
3. **INPUT SOCKET or TERMINAL:** AC input utility power supplies to the UPS via the socket or terminal.
4. **SNMP SLOT:** A SNMP adapter can be plugged in this port for managing UPS on network.
5. **TVSS (Transient Voltage Surge Surppressor) (RJ-45/RJ-11 SURGE PROTECTOR):** These connectors are used to prevent damage from surge, noise and spike traveling form telephone or network line.
6. **COMMUNICATION INTERFACE (RS-232/DRY CONTACT):** The communication port is used to communicate PC and UPS. Please refer to section 8 for more information.
7. **Fan:** DC fans for cooling purpose.
8. **Circuit Breaker:** Used to protect UPS from output overload.
9. **External Batteries Connector:** Used for connecting external battery cabinets to extend back up time.

3. INSTALLATION

3-1 Unpacking



- Please read this user manual before installing the UPS.
- This UPS contains batteries which are potentially hazardous to user, even when the UPS is not connected to the utility power.
- Before unpacking the UPS, check the packing box. If there are any visible damage, contact your dealer at once.
 - This unit is to operate by any individuals with previous training.
 - This unit should be installed by service personnel.

3-2 Before Installation



- Avoid exposing the UPS to direct sunlight or other heat source. The UPS should be facing away from direct sunlight glare.
- Choose a well-ventilated area to position your UPS to allow adequate dissipation of heat.
- Ensure the UPS surrounding area is clean and free from moisture.
- Do not put heavy objects on the cable or power cord.

3-3 Installation

Notice:

- AC output need a disconnect device such as a breaker which has to be provided by others.
- The wire length of output power cord connected to the output receptacle or pressure terminal should be less than 10 meters.
- The UPS provide with pressure terminal connector for field installed wiring, the terminal connector should be applied a 13.8 lb-in (1.554 N-m) of tightening torque.
- The over current protection and short circuit protection for the AC output is provided by internal circuits of UPS and breaker.
- Concerning about the battery voltage, ambient temperature and other specifications of the UPS, please refer to the specification section of this manual.
- Servicing of batteries should be performed or supervised by personnel knowledgeable of batteries and the required precautions. Keep unauthorized personnel away batteries.
- When replacing batteries, replace with the same type and number .

1. Connecting to utility power (Refer to fig 3-4)

• If input type is socket type

- (1) Connect the IEC plug of power cord to the IEC 320 connector on the UPS.

- (2) Plug the other end of the power cord into a two-pole, three-wire, grounding receptacle only. Avoid using extension cords and adapter plug.

- **If input type is terminal type**

- (1) Be sure to utilize UL1015#12 AWG WIRE for GES302N11XX model and UL1015#10 AWG WIRE for GES202N11XX model for power connection.
- (2) Connect one end of L,N,G strings to those of the terminal block and the other end to those of the switch box (L-L, N-N, G-G).
 - Avoid using extension cords and adapter plug from UPS.
 - Turn on the input breaker (if the breaker can be turned on) on the rear panel of UPS.
 - After that, the fan (in rear panel) will run and all LEDs will light for about 2-3 sec. Meanwhile the CPU inside the UPS setups the initial parameters. User also can check whether all LEDs are normal or not. The UPS is set in “**STANDBY mode**” initially, after a ‘bee’ is heard, the load LED lights on and the line LED shows AC utility status. Shown as fig 3-1.

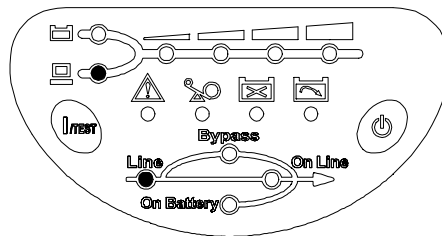

Fig 3-1 Stand-By Mode

2. Checking the site wiring fault LED (If the function is available)

- After the UPS is plugged in , check the site wiring fault LED (fault LED in “**STANDBY mode**”). If the UPS is plugged into an improper wired AC power outlet, this LED flashes. Shown as fig 3-2.

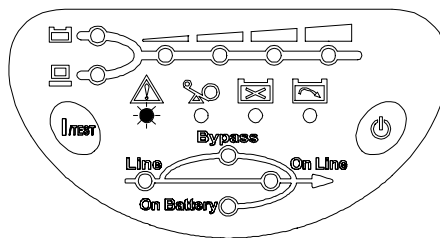

Fig 3-2 Site Fault

- The detection of site wiring fault includes missing ground, hot-neutral polarity reversal and overloaded neutral circuit. If it lights up, unplug the UPS and have the site wiring checked by qualified electrician.

3. Charging the battery

- The battery charger of the UPS automatically charges the battery whenever the power cord of UPS is connected to a acceptable utility power.
- When UPS is running for the first time, charge the UPS for at least 6 hours to ensure batteries inside are fully charged before operation.
- You may immediately use the UPS without having to wait for the batteries to be fully charged. However, it is advisable not to do this as UPS will have a shorter back-up time than expected if such action is taken.

Connecting the battery bank

1. Utilize the battery connection cable packed with the battery bank.
2. Connect on one end of the cable to the external battery connector of UPS, and the other end to that of the battery bank.
3. Warning: For safety reason, the manufacturer suggests that ONE UPS CONNECTS AS MANY AS FIFTEEN EXTERNAL BATTERY BANKS.

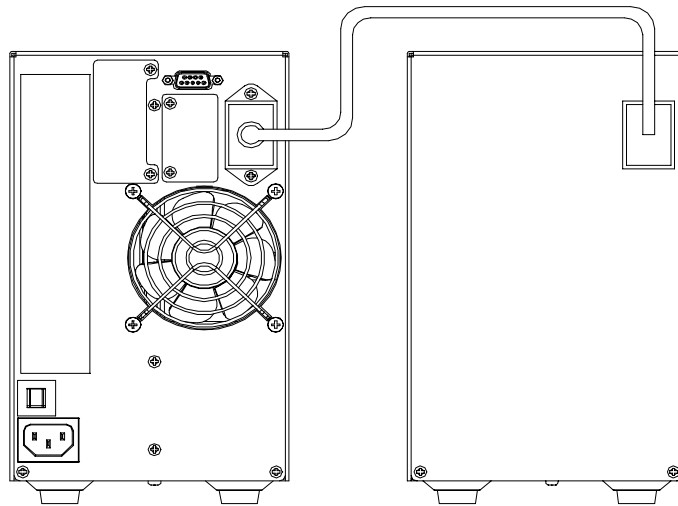

Fig 3-3 UPS Connected to External Battery Bank

4. The battery banks should be installed by service personnel.
 - A. According to UL 1778 safety requirement: in order to remove the battery power cord emergently, please plug in the power cord directly.
 - B. According to EN50091-1-1 safety requirement: beside plugging in the battery power cord, the battery power cord need to be fixed with the screws.

4. Connecting the load

- Calculate power consumption of your loads to ensure that the overload condition will not happen.
- Plug the power cord of the equipment into the output receptacles on the rear panel of the UPS.

- Turn on the equipment connected to the UPS.
- Caution: Do not connect a laser printer to the UPS.
- Caution: Do not connect the UPS from generator.

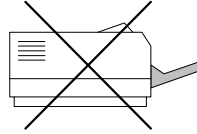

5. Connecting the RS-232/Dry contact

- Connect the interface signal cable between the **RS-232/Dry contact** port on the rear panel of UPS and COM1 or COM2 of computer if necessary.

The D-sub 9 connector can work as a **Dry contact** or **RS-232** communication port depending on the type of cable and software used. Refer to section 8 for more information.

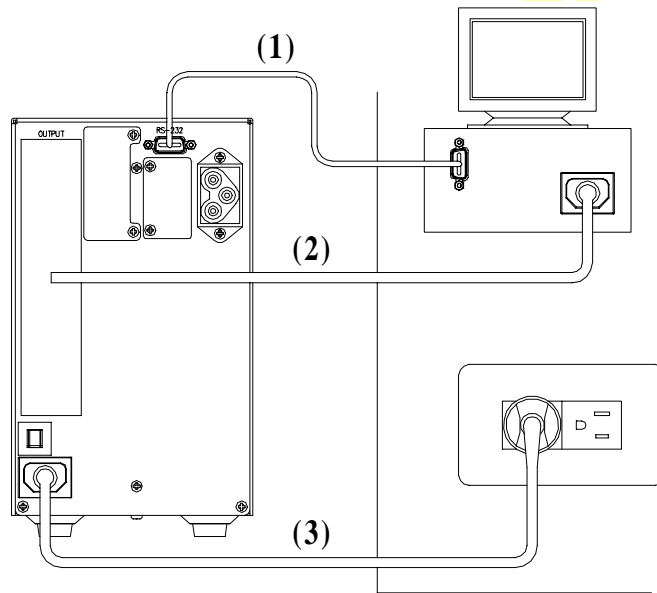

Fig 3-4.1 UPS Connection for 700VA or 1KVA:

- (1) RS-232/Dry contact cable. (2) Provides power to PC. (3) Connected to utility power.

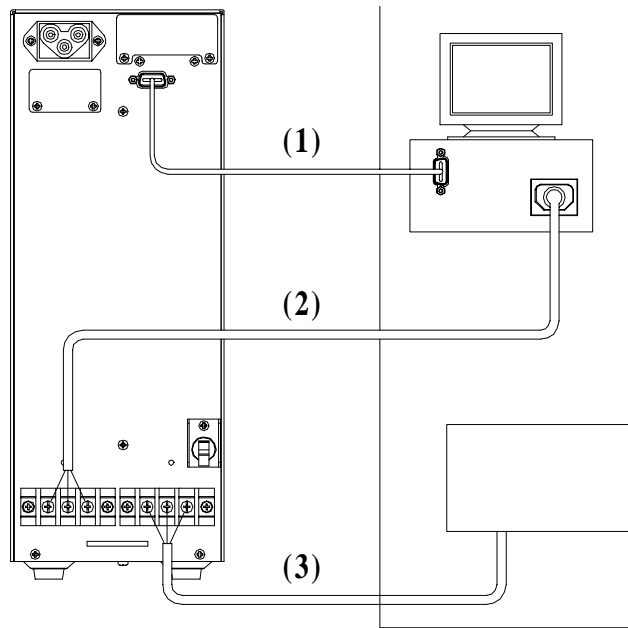

Fig 3-4.2 UPS Connection for 2KVA or 3KVA:

(1) RS-232/Dry contact cable. (2) Provides power to PC. (3) Connected to utility power.

4. OPERATION

4-1 Cold start when utility is not present

Even when there is no utility power, you can still turn on the UPS. Just press the **1/TEST** button and hold for one second, the UPS will start up after you hear a “bee”. The battery LED and on-battery LED will light on and the UPS runs on “**ON-BATTERY mode**”. Shown as fig 4-1.

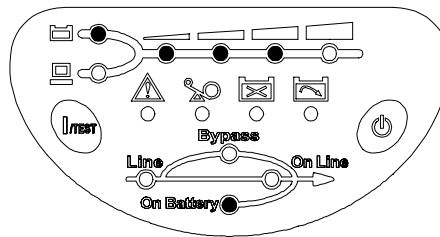

Fig 4-1 On Battery Mode

4-2 Turning “ON” the UPS

When the utility power is acceptable for the UPS, you can normally turn on the UPS after pushing the **1/TEST** button and hold a few seconds until a “bee” is heard. The bypass LED will extinguish after shortly light on. When the on-line LED lights on, the UPS is running on “**ON-LINE mode**”. Shown as fig 4-2.

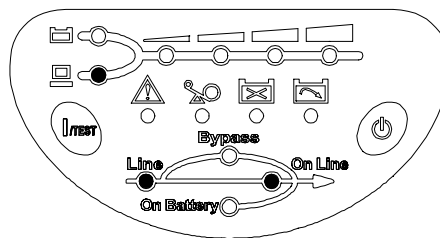

Fig 4-2 On-Line Mode

4-3 Turning “OFF” the UPS

Push the **0** button for turning off the UPS, when a “bee” is heard release your press. After a few seconds the UPS is off.

The UPS will keep charging when UPS is in “**STANDBY mode**” even though the **0** button has been pressed. To fully turn off the UPS, it is advised to unplug the power cord. Refer to fig 3-1.

4-4 UPS self-test

If press the 1/TEST button when the UPS is in “ON-LINE mode”, it will make the UPS shift to “ON-BATTERY mode” and automatically perform a self-test for about 10 seconds. (Shown as fig 4-4.) The self-test function will check the condition of the battery. After self-test is finished and test is O.K, the UPS will return to “ON- LINE mode”.

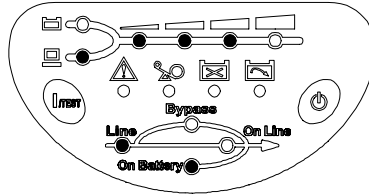

Fig 4-4 UPS Self-Test

4-5 Silence function

The buzzer can be turned “On” or “Off” by toggling the 1/TEST button when the UPS is in “ON-BATTERY mode”.

4-6 If certain abnormal condition occurs, the UPS will send the following messages:

- **ON-BATTERY mode:** When the UPS is in “ON-BATTERY mode”, the on- battery LED will light on, buzzer beep half second every 2 seconds and then the UPS will start supplying power to load through batteries. Shown as fig 4-5.

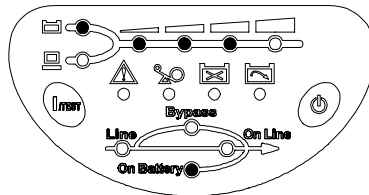

Fig 4-5 On-Battery Mode

- **OVERLOAD:** If the load exceeds the UPS rating, after a limited period, the overload LED will light on and buzzer continuous beeping to alarm the user. The user should unplug some uncrucial loads to release the overload condition. Shown as fig 4-6.

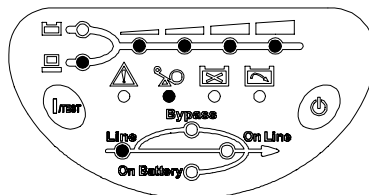

Fig 4-6 Overload and UPS turn into Bypass

- BATTERY REPLACE:** This LED function is to alert user that the batteries should be replaced. When the microprocessor in the UPS detects a battery fault, the UPS alarm will give out three beeps. Each beep lasts for 0.5 seconds and interrupted by an interval of 0.5 seconds. After the initial 3 beeps, the alarm will continue to sound every one hour. Shown as fig 4-7.

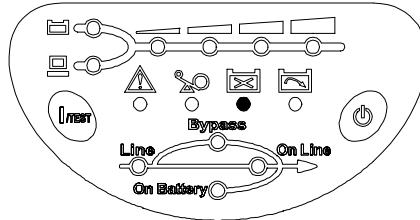

Fig 4-7 Battery Replace

- BATTERY LOW:** This function is to inform user the remaining power capacity of the batteries. When batteries reach a low level condition, the UPS alarm will beep half second every 1.5 seconds until running out of battery capacity. Shown as fig 4-8.

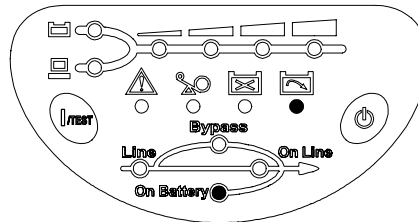

Fig 4-8 Battery Low

- SHORT CIRCUIT:** When the output of the UPS shorts in “ON-LINE mode” or “ON-BATTERY mode”, the UPS will shut down (without output voltage). As soon as the short circuit is happened, the fault LED will light on and the UPS alarm will sound continuously. When remove short circuit, the UPS output will recover. If short circuit is happened in “BYPASS mode”, the UPS will protect itself by tripping the input breaker and shut down. Shown as fig 4-9.

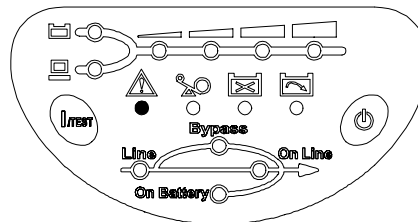

Fig 4-9 Short Circuit

4-7 UPS internal fault

If the following conditions occur, the UPS fails. At this time the UPS will transfer to “**BYPASS mode**”. The bypass LED and fault LED will light on and alarm continuously. If utility is too low or too high the UPS output will be disabled. For fault messages, please refer to the troubleshooting (section7) of this manual.

- When the UPS inner component overheat, the UPS will protect itself by thermo-switches. This status is so-called “**O.T.P**”
- When under (or over) voltage is happened in the UPS output. This kind of fault will be detected by the microprocessor in the UPS and is so-called “**U.V.P**” (“**O.V.P**”).
- When under (or over) bus voltage is happened in the UPS and is so-called “**Bus U.V.P**” (“**Bus O.V.P**”).

4-8 Storing the message into EEPROM

After low battery shutdown or fault, the UPS will store the message into EEPROM. The UPS will auto-restart when the utility power is recovered. Shown as fig 4-10.

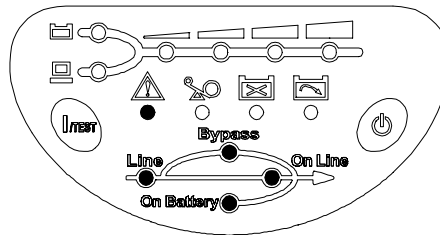

Fig 4-10 Store message in EEPROM

4-9 Derating power

In the range of 130Vac to 160Vac(or 65-80Vac), the UPS load capacity will decrease. This function provides a wider operating power voltage range.

4-10 Programmable output (Optional)

User can use the monitoring software to control which receptacle can deliver power.

5. MAINTENANCE



- Normally, the life of battery is 3 years. But extreme operating condition and environment may shorten its life-span.
- To replace batteries, contact qualified personnel.
- When UPS has been unused for a period of time, the batteries will discharge slightly. It is recommended to charge the UPS once every 3 months.
- Use a vacuum cleaner to get rid of any dust that may rest on the opening of the fan.
- Unplug the UPS when it is not used for a long time.
- When cleaning the plastic case or front panel, only use a soft, dry cloth. If the case or front panel is very dirty, use a neutral, non-abrasive detergent. Do not use alcohol or ammonia based solutions.
- When moving your UPS, always handle it with care.
- Avoid spilling liquid on the UPS.
- The equipment should be repaired and installed by individuals with previous training.

When installing this equipment, it should be noted that the leakage current of the UPS and its loads must not exceed 3.5mA in total for safety.

6. PLACEMENT

To stably install the UPS, the 2,3KVA must add stands to support themselves. The installation method is as shown below:

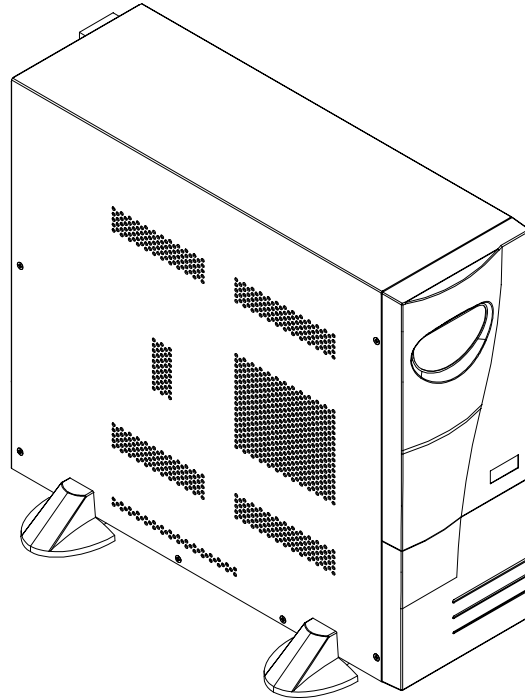

Fig 6-1 Erect the UPS with supporting stands

DELTA

7. TROUBLESHOOTING

<i>Problem</i>	<i>Possible Cause</i>	<i>Solution</i>
UPS is not turned on. (No alarm, No LED lights)	ON/TEST button is not pushed.	Press the 1/TEST button to turn on the UPS. (Refer section 4 to turn on the UPS.)
	Battery low shut down and utility is absent.	Waiting for line recovery.
	The rear panel input circuit breaker is tripped. (Button is tripped out)	1. Reduce some loads connected to the UPS. 2. Reset the circuit breaker. (Push button in)
	UPS fault.	Call for qualified service personnel if above actions do not solve the problem.
UPS does not provide expected back-up time.	Batteries inside the UPS are not fully charged.	Recharge the batteries for at least 8 hours.
	UPS is overloaded.	Remove some unnecessary loads.
	Batteries are weak.	Batteries weak faster when used often or operating at higher temperature. If the battery is near the end of its life, call for service personnel. Replace the battery even if the REPLACE BATTERY LED does not light.
	Charger fault or other reason.	Call for service.
All LEDs light on.	Internal UPS fault.	1. Turn off UPS. 2. Call for service.
“REPLACE BATTERY” LED lights on.	Weak batteries.	1. Recharge the batteries for at least 8 hours. 2. If problem remains Call for service personnel to, replace the batteries.
PC-UPS communication does not work properly.	Incorrect transmission speed.	Re-test after using another different transmission speed.
	Incorrect RS-232 connection.	Refer to communication interface (Section 8) of this manual Re-connect the UPS with COM1 / COM2 on PC again.
UPS operates on battery even though the line is in normal operating condition.	No incoming utility.	Check input power connection.
	The rear panel input circuit breaker is tripped. (Button is out).	1. Reduce some loads connected to the UPS. 2. Reset the circuit breaker. (Push button in)
	Very high, low or distorted utility voltage.	Have qualified electrician check the input voltage.
Site wiring fault LED (fault led flash).	Wiring error such as reversed hot/neutral.	Get wiring checked by electrician.

UPS over temperature.	The exhaust fans and ventilation grills may be obstructed.	Choose a well-ventilated area to position your UPS to allow adequate dissipation of heat.
	The environment temperature exceeds 40°C (104°F).	Position your UPS in cooler area.
“FAULT” LED lights on, alarm beeps	UPS failure.	Call fore service engineer.
“OVERLOAD” LED lights on and buzzer beeps continuously.	Overloaded.	Remove some critical load.

FAULT MESSAGE

Following information indicates various symptoms.

Use this information to determine what factors cause the problem .

1. Alarm will sound to alert user that the UPS requires attention.
2. One or more additional load/battery level LED indicators will illuminate to provide a diagnostic aid to the operator, described as below:

Output temperature protect	D & C LEDs light on
Output over voltage protect	D LED light on
Output under voltage protect	C LED light on
Bus over voltage protect	B LED light on
Bus under voltage protect	A LED light on

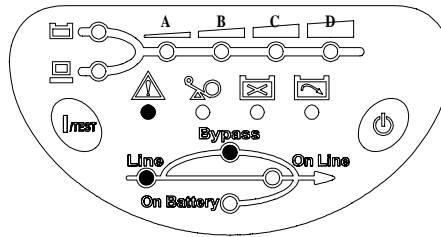

Fig 7-1

In case that failure is happened and utility is too low or too high, the UPS output will disable and the bypass and line led will flash.

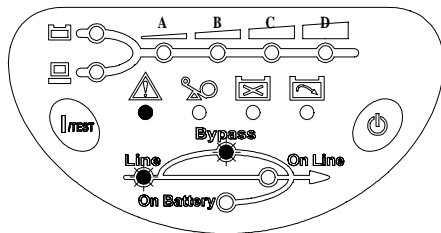

Fig 7-2

If problem continues, contact your local dealer.

8. COMMUNICATION INTERFACE

The UPS provides **RS-232** and **Dry contact** protocols in one D-sub 9 connector. Using proper UPS management software and cable, the UPS can be managed over LAN/intranet/internet environment. The pin assignment of the D-sub 9 connector is defined as follows:

PIN	ASSIGNMENT DESCRIPTION	
	RS-232	Dry Contact
1		Low battery(Open collector)
2	UPS TxD(typical RS-232 level)	
3	UPS RxD(typical RS-232 level)	Remote shutdown(5~12V)
4	Reserved for PNP	
5	GND	GND
6	Reserved for PNP	Reserved
7	Reserved for PNP	Reserved
8		Utility Fail(Open collector)
9		

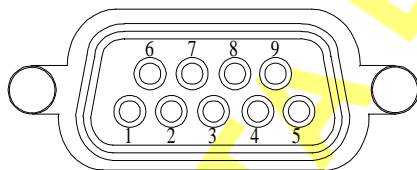

Fig 8-1 Pin Assignment

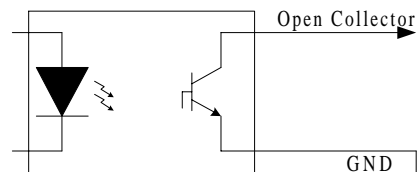

Fig 8-2 Open Collector Circuit

Maximum voltage and current on pin 1,8 is 30VDC, 10mA.

8-1 RS-232

Pin2 : PC receives line **RS-232** data from UPS.

Pin3 : PC transmits line **RS-232** data to UPS.

Pin5 : Signal ground.

Pin4,6,7 : Reserved for plug and play function.

The **RS-232** communication port provides the following functions:

- 1) Monitoring charger status
- 2) Monitoring battery status and condition
- 3) Monitoring inverter status
- 4) Monitoring UPS status
- 5) Monitoring the utility status
- 6) Providing the power switch function for computer to turn on/off the utility on schedule for power saving
- 7) Adjustable Transfer voltage

The UPS data is provided at 2400 bps baud rate and made up of 8-bit, 1 stop-bit and no parity bit. All information is encoded in ASCII format.

HARDWARE:

BAUD RATE-----2400 bps
DATA LENGTH-----8 bits
STOP BIT-----1 bit
PARITY-----NONE

CABLING:

Standard D-sub 9 cable (UPS side: male, PC side: female)

8-2 Dry Contact

- Pin1 : The pin is normally open. When battery low, pin1 and pin5 are connected via photo coupler.
- Pin3 : The UPS will shut down when a high level (5~12V) sustained for at least 3.8 seconds is applied.
- Pin5 : Signal ground.
- Pin6,7 : Reserved.
- Pin8 : The pin is normally open. When utility fails, pin8 and pin5 are connected via photo coupler.

CABLING: The user must use the special cable. The connection is described as follows:

PC (female)	UPS (male)
Pin1-----	Pin1 (battery Low)
Pin3-----	Pin5 (GND)
Pin4-----	Pin3 (Shutdown)
Pin7-----	Pin6
Pin7-----	Pin7
Pin8-----	Pin8 (AC Fail)

The communication port at the back of the UPS may be connected to a computer. This port allows the computer to monitor the UPS and control the operation of the UPS in some cases.

Its major functions normally some or all of following:

- ★ To broadcast a warning when power fails.
- ★ To close the files before the battery is exhausted.
- ★ To turn off the UPS computers.

Some computers may have a special connector to link this communication port, or require a special plug-in card, or need a special UPS monitoring software. Contact your dealer for details of different interface kits.

Caution:

Every time when you connect your UPS and computer, please make sure the utility exists.

DELTA DOC CENTER

Technical specifications

Model		GES701N	GES102N	GES202N	GES302N	
Capacity		700VA/560W	1KVA/800W	2KVA/1600W	3KVA/2400W	
Input	Rated Voltage	100V,110V,120V 200V,208V,220V,230V,240V				
	Voltage Range	80V~138V(Full Load) : 65V~80V(70% Load) 160V~275V(Full Load) : 130V~160V(70% Load)				
	Frequency	50Hz/60Hz (±4.8 Hz)				
	Power Factor	≥0.97				
Output	Voltage	100V,110V,120V 200V,208V,220V,230V,240V				
	Frequency	50Hz/60Hz				
	Voltage Regulation	±2%				
	Frequency Accuracy	±0.05 Hz				
	Wave Form	Pure Sine Wave				
	Transient Response	±5% (10%~90% Linear Load)				
	THD	≤3%(Linear Load); ≤6%(Computer Load)				
	Overload Capacity	105%-125% for 3mins; 125%-150% for 30secs; >150% for 1sec				
	Crest Factor	3:1				
Efficiency (AC-AC)	≥ 86%	≥ 87%	≥ 87%	≥ 87%		
Outlet	Receptacle	NEMA5-15R×2×2 IEC320×2×2		NEMA5-15R×2×2 IEC320×4×2		
	Battery Voltage	36 V	36 V	72V	72V	
Battery	Battery Type (Lead acid)	12V/7Ah			12V/9Ah	
	Back-up Time (Typical)	8mins (420W)	5mins (700W)	5mins (1400W)	5mins (2000W)	
	Recharge Time	8 Hours After Complete Discharge to Recover 90%				
Transfer Time	Transfer Time	Zero				
LED	LED Status	On-line · Bypass · On-battery · Overload · Battery Low · Fault · Battery Replace · Battery Level · Load Level				
	Alarm	Buzzer				
Interface	DB9	RS232/Dry Contact				
	SNMP Slot	Internal				
Environment	Noise (At 1 Meter)	40dBA		42dBA	42dBA	
	Operating Temperature	0~40℃				
	Humidity	0%~90%(Non-Condensing)				
Safety Approval	Safety	UL/cUL TUV/GS				
	EMC	FCC Class A(2,3KVA)/B(1KVA) CISPR PUB 22 Class B; TUV/EMC; CE				
	Lightning	IEEE 62.41 Category A				
Others	Battery Start	Yes				
	Extended Battery Bank	Yes (Optional with Long Time)				
	Long Time Model	Yes (Optional)				
Appearance	Dimension(WxDxH)	140x363x242/mm 5.5x14.2x9.5/inch	140x363x242/mm 5.5x14.2x9.5/inch	140x422x373/mm 5.5x16.6x14.7/inch	140x422x373/mm 5.5x16.6x14.7/inch	
	Weight	Typical	15kg/33 lb	15kg/33 lb	29kg/63.9 lb	29 kg/63.9 lb
		Long Time	8.1kg/17.8 lb	8.1 kg/17.8 lb	15.2kg/33.5 lb	15.2kg/33.5 lb

All specifications are subject to change without prior notice.

P/N: 5011307301

Free Manuals Download Website

<http://myh66.com>

<http://usermanuals.us>

<http://www.somanuals.com>

<http://www.4manuals.cc>

<http://www.manual-lib.com>

<http://www.404manual.com>

<http://www.luxmanual.com>

<http://aubethermostatmanual.com>

Golf course search by state

<http://golfingnear.com>

Email search by domain

<http://emailbydomain.com>

Auto manuals search

<http://auto.somanuals.com>

TV manuals search

<http://tv.somanuals.com>