

Dell PowerEdge M620 Systems Owner's Manual

Regulatory Model: HHB
Regulatory Type: HHB003



Notes, Cautions, and Warnings



NOTE: A NOTE indicates important information that helps you make better use of your computer.



CAUTION: A CAUTION indicates either potential damage to hardware or loss of data and tells you how to avoid the problem.



WARNING: A WARNING indicates a potential for property damage, personal injury, or death.

© 2012 Dell Inc.

Trademarks used in this text: Dell™, the Dell logo, Dell Precision™, OptiPlex™, Latitude™, PowerEdge™, PowerVault™, PowerConnect™, OpenManage™, EqualLogic™, Compellent™, KACE™, FlexAddress™, Force10™ and Vostro™ are trademarks of Dell Inc. Intel®, Pentium®, Xeon®, Core® and Celeron® are registered trademarks of Intel Corporation in the U.S. and other countries. AMD® is a registered trademark and AMD Opteron™, AMD Phenom™ and AMD Sempron™ are trademarks of Advanced Micro Devices, Inc. Microsoft®, Windows®, Windows Server®, Internet Explorer®, MS-DOS®, Windows Vista® and Active Directory® are either trademarks or registered trademarks of Microsoft Corporation in the United States and/or other countries. Red Hat® and Red Hat® Enterprise Linux® are registered trademarks of Red Hat, Inc. in the United States and/or other countries. Novell® and SUSE® are registered trademarks of Novell Inc. in the United States and other countries. Oracle® is a registered trademark of Oracle Corporation and/or its affiliates. Citrix®, Xen®, XenServer® and XenMotion® are either registered trademarks or trademarks of Citrix Systems, Inc. in the United States and/or other countries. VMware®, Virtual SMP®, vMotion®, vCenter® and vSphere® are registered trademarks or trademarks of VMware, Inc. in the United States or other countries. IBM® is a registered trademark of International Business Machines Corporation.

2012 - 06

Rev. A02

Contents

| | |
|--|-----------|
| Notes, Cautions, and Warnings..... | 2 |
| 1 About Your System..... | 7 |
| Front-Panel Features And Indicators..... | 7 |
| Using USB Diskette or USB DVD/CD Drives..... | 7 |
| Hard-Drive/SSD Indicator Patterns..... | 8 |
| Other Information You May Need..... | 8 |
| 2 Using The System Setup And Boot Manager..... | 11 |
| Choosing The System Boot Mode..... | 11 |
| Entering System Setup..... | 12 |
| Responding To Error Messages..... | 12 |
| Using The System Setup Navigation Keys..... | 12 |
| System Setup Options..... | 12 |
| System Setup Main Screen..... | 12 |
| System BIOS Screen..... | 13 |
| System Information Screen..... | 13 |
| Memory Settings Screen..... | 14 |
| Processor Settings Screen..... | 14 |
| SATA Settings Screen..... | 15 |
| Boot Settings Screen..... | 15 |
| Integrated Devices Screen..... | 16 |
| Serial Communications Screen..... | 17 |
| System Profile Settings Screen..... | 17 |
| System Security Screen..... | 18 |
| Miscellaneous Settings..... | 19 |
| System And Setup Password Features..... | 19 |
| Assigning A System And/Or Setup Password..... | 20 |
| Using Your System Password To Secure Your System..... | 20 |
| Deleting Or Changing An Existing System And/Or Setup Password..... | 21 |
| Operating With A Setup Password Enabled..... | 21 |
| Entering The UEFI Boot Manager..... | 21 |
| Using The Boot Manager Navigation Keys..... | 22 |
| Boot Manager Screen..... | 22 |
| UEFI Boot Menu..... | 23 |
| Embedded System Management..... | 23 |
| iDRAC Settings Utility..... | 23 |

| | |
|--|-----------|
| Entering The iDRAC Settings Utility..... | 23 |
| 3 Installing Blade Components..... | 25 |
| Recommended Tools..... | 25 |
| Removing And Installing A Blade..... | 25 |
| Removing The Blade..... | 25 |
| Installing The Blade..... | 26 |
| Opening And Closing The Blade..... | 27 |
| Opening The Blade..... | 27 |
| Closing The Blade..... | 28 |
| Inside The Blade..... | 28 |
| Cooling Shroud..... | 29 |
| Removing The Cooling Shroud..... | 29 |
| Installing The Cooling Shroud..... | 30 |
| System Memory..... | 30 |
| General Memory Module Installation Guidelines..... | 32 |
| Mode-Specific Guidelines..... | 32 |
| Sample Memory Configurations..... | 33 |
| Removing Memory Modules..... | 36 |
| Installing Memory Modules..... | 37 |
| I/O Module Mezzanine Cards..... | 38 |
| Mezzanine Card Installation Guidelines..... | 38 |
| Removing A Mezzanine Card..... | 38 |
| Installing A Mezzanine Card..... | 39 |
| Management Riser Card..... | 40 |
| Replacing The SD Card..... | 40 |
| Internal USB Key..... | 41 |
| SD vFlash Card..... | 42 |
| Replacing The SD vFlash Card..... | 42 |
| Network Daughter Card/LOM Riser Card..... | 43 |
| Removing The Network Daughter Card/LOM Riser Card..... | 43 |
| Installing The Network Daughter Card/LOM Riser Card..... | 44 |
| Processors..... | 44 |
| Removing A Processor..... | 44 |
| Installing A Processor..... | 48 |
| Hard Drives/SSDs..... | 49 |
| Hard Drive/SSD Installation Guidelines..... | 49 |
| Removing A Hard Drive/SSD..... | 49 |
| Installing A Hard Drive/SSD..... | 50 |
| Shutdown Procedure For Servicing a Hard Drive/SSD..... | 50 |
| Configuring The Boot Drive..... | 51 |
| Removing A Hard Drive/SSD From A Hard-Drive/SSD Carrier..... | 51 |

| | |
|---|-----------|
| Installing A Hard Drive/SSD In A Hard-Drive/SSD Carrier..... | 51 |
| Hard-Drive/SSD Backplane..... | 52 |
| Removing The Hard-Drive/SSD Backplane..... | 52 |
| Installing The Hard-Drive/SSD Backplane..... | 53 |
| System Board..... | 53 |
| Removing The System Board..... | 53 |
| Installing The System Board..... | 54 |
| NVRAM Backup Battery..... | 55 |
| Replacing The NVRAM Backup Battery..... | 55 |
| Storage Controller Card..... | 56 |
| Removing The PCIe Extender Card/Storage Controller Card..... | 56 |
| Installing The PCIe Extender Card/Storage Controller Card..... | 57 |
| 4 Troubleshooting Your System..... | 59 |
| Safety First—For You and Your System..... | 59 |
| Troubleshooting System Memory..... | 59 |
| Troubleshooting Hard Drives..... | 60 |
| Troubleshooting USB Devices..... | 60 |
| Troubleshooting An Internal SD Card..... | 60 |
| Troubleshooting Processors..... | 61 |
| Troubleshooting The Blade System Board..... | 61 |
| Troubleshooting The NVRAM Backup Battery..... | 62 |
| 5 Using System Diagnostics..... | 63 |
| Dell Online Diagnostics..... | 63 |
| Dell Embedded System Diagnostics..... | 63 |
| When To Use The Embedded System Diagnostics..... | 63 |
| Running The Embedded System Diagnostics..... | 63 |
| Running Embedded System Diagnostics From An External Media..... | 64 |
| System Diagnostic Controls..... | 64 |
| 6 Jumpers And Connectors..... | 65 |
| System Board Jumper Settings..... | 65 |
| System Board Connectors..... | 66 |
| Disabling A Forgotten Password..... | 67 |
| 7 Technical Specifications..... | 69 |
| 8 System Messages..... | 73 |
| LCD Status Messages..... | 73 |
| Viewing LCD Messages..... | 73 |
| Removing LCD Messages..... | 73 |

| | |
|----------------------------|------------|
| System Error Messages..... | 73 |
| Warning Messages..... | 130 |
| Diagnostic Messages..... | 131 |
| Alert Messages..... | 131 |
| 9 Getting Help..... | 133 |
| Contacting Dell..... | 133 |

About Your System

Front-Panel Features And Indicators

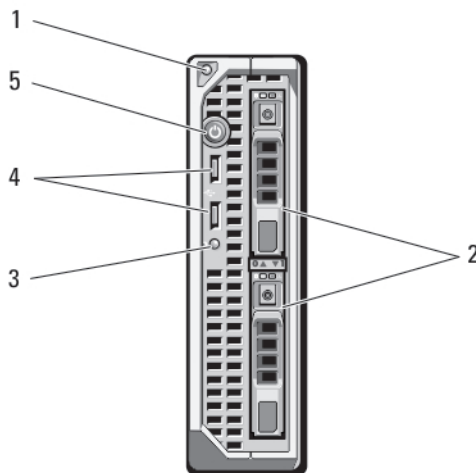



Figure 1. Front-Panel Features and Indicators

1. blade handle release button
2. hard drives (2)
3. status/identification indicator
4. USB connectors (2)
5. blade power button

Using USB Diskette or USB DVD/CD Drives

The blade has USB ports on the front which allow you to connect a USB diskette drive, USB flash drive, USB DVD/CD drive, keyboard, or mouse. The USB drives can be used to configure the blade.

-  **NOTE:** Your blade supports only Dell-branded USB 2.0 drives. Use the optional external drive storage tray to support the drive while in use.
-  **NOTE:** If the drive must be designated as the boot drive, connect the USB drive, restart the system, then enter the System Setup and set the drive as first in the boot sequence. The USB device is displayed in the boot order setup screen only if it is attached to the system before you run the System Setup. You can also select the boot device by pressing <F11> during system start-up and selecting a boot device for the current boot sequence.

Hard-Drive/SSD Indicator Patterns

The hard-drive/SSD indicators display different patterns as drive events occur in the system.

NOTE: The blade must have a hard drive/SSD or a hard-drive blank installed in each drive bay.



Figure 2. Hard-Drive/SSD Indicators

- 1. drive activity indicator (green)
- 2. drive status indicator (green and amber)

NOTE: If the drive is in Advanced Host Controller Interface (AHCI) mode, the status LED (on the right side) does not function and remains off.

Drive-Status Indicator Pattern

Blinks green two times per second

Off

Condition

Identifying drive or preparing for removal

Drive ready for insertion or removal

NOTE: The drive status indicator remains off until all drives are initialized after system power is applied. Drives are not ready for insertion or removal during this time.

Blinks green, amber, and off

Drive predicted failure

Blinks amber four times per second

Drive failed

Blinks green slowly

Drive rebuilding

Steady green

Drive online

Blinks green three seconds, amber three seconds, and off six seconds

Rebuild aborted

Other Information You May Need

WARNING: See the safety and regulatory information that shipped with your system. Warranty information may be included within this document or as a separate document.

- The *Getting Started Guide* provides an overview of system features, setting up your system, and technical specifications.
- The *Rack Installation Instructions* included with your rack solution describes how to install your system into a rack.
- The *Dell PowerEdge M1000e Enclosure Owner's Manual* provides information about enclosure features and describes how to troubleshoot the enclosure and install or replace the enclosure's components.
- The *Dell Chassis Management Controller User's Guide* provides information on installing, configuring and using the Chassis Management Controller (CMC).
- For the full name of an abbreviation or acronym used in this document, see the Glossary at support.dell.com/manuals.
- Dell systems management application documentation provides information about installing and using the systems management software.
- Any media that ships with your system that provides documentation and tools for configuring and managing your system, including those pertaining to the operating system, system management software, system updates, and system components that you purchased with your system.



NOTE: Always check for updates on support.dell.com/manuals and read the updates first because they often supersede information in other documents.

Using The System Setup And Boot Manager

System Setup enables you to manage your system hardware and specify BIOS-level options.

The following keystrokes provide access to system features during startup:

| Keystroke | Description |
|-----------|---|
| <F2> | Enters the System Setup. |
| <F10> | Enters System Services, which opens the Dell Lifecycle Controller 2 (LC2). The Dell LC2 allows you to access utilities such as embedded system diagnostics. For more information, see the Dell LC2 documentation. |
| <F11> | Enters the BIOS Boot Manager or the Unified Extensible Firmware Interface (UEFI) Boot Manager, depending on the system's boot configuration. |
| <F12> | Starts Preboot eXecution Environment (PXE) boot. |

From the System Setup, you can:

- Change the NVRAM settings after you add or remove hardware
- View the system hardware configuration
- Enable or disable integrated devices
- Set performance and power management thresholds
- Manage system security

You can access the System Setup using the:

- Standard graphical browser, which is enabled by default
- Text browser, which is enabled using **Console Redirection**

To enable **Console Redirection**, in **System Setup**, select **System BIOS** → **Serial Communication screen** → **Serial Communication**, select **On with Console Redirection**.

 **NOTE:** By default, help text for the selected field is displayed in the graphical browser. To view the help text in the text browser, you must press <F1>.

Choosing The System Boot Mode

System Setup enables you to specify the boot mode for installing your operating system:

- BIOS boot mode (the default) is the standard BIOS-level boot interface.
- UEFI boot mode is an enhanced 64-bit boot interface based on Unified Extensible Firmware Interface (UEFI) specifications that overlays the system BIOS.

You must select the boot mode in the **Boot Mode** field of the **Boot Settings Screen** of System Setup. Once you specify the boot mode, the system boots in the specified boot mode and you proceed then to install your operating system from that mode. Thereafter, you must boot the system in the same boot mode (BIOS or UEFI) to access the installed operating system. Trying to boot the operating system from the other boot mode will cause the system to halt at startup.

 **NOTE:** Operating systems must be UEFI-compatible to be installed from the UEFI boot mode. DOS and 32-bit operating systems do not support UEFI and can only be installed from the BIOS boot mode.

 **NOTE:** For the latest information on supported operating systems, see dell.com/ossupport.

Entering System Setup

1. Turn on or restart your system.
2. Press <F2> immediately after you see the following message:
<F2> = System Setup

If your operating system begins to load before you press <F2>, allow the system to finish booting, and then restart your system and try again.

Responding To Error Messages

If an error message is displayed while the system is booting, make a note of the message. See System Error Messages section of this manual for an explanation of the message and suggestions for correcting errors.

 **NOTE:** After installing a memory upgrade, it is normal for your system to display a message the first time you start your system.

Using The System Setup Navigation Keys

| Keys | Action |
|------------|---|
| Up arrow | Moves to the previous field. |
| Down arrow | Moves to the next field. |
| <Enter> | Allows you to type in a value in the selected field (if applicable) or follow the link in the field. |
| Spacebar | Expands or collapses a drop-down list, if applicable. |
| <Esc> | Moves to the previous page until you view the main screen. Pressing <Esc> in the main screen exits System Setup. A message prompts you to save any unsaved changes. |
| <F1> | Displays the System Setup help file. |

 **NOTE:** For most of the options, any changes that you make are recorded but do not take effect until you restart the system.

System Setup Options

System Setup Main Screen

 **NOTE:** Press <Alt><F> to reset the BIOS or UEFI settings to their default settings.

| Menu Item | Description |
|-------------|--|
| System BIOS | This option is used to view and configure BIOS settings. |

| Menu Item | Description |
|-----------------|--|
| iDRAC Settings | This option is used to view and configure iDRAC settings. |
| Device Settings | This option is used to view and configure device settings. |

System BIOS Screen

 **NOTE:** The options for System Setup change based on the system configuration.

 **NOTE:** System Setup defaults are listed under their respective options in the following sections, where applicable.

| Menu Item | Description |
|-------------------------|--|
| iDRAC Settings | This option is used to view and configure iDRAC settings. |
| Device Settings | This option is used to view and configure device settings. |
| System Information | Displays information about the system such as the system model name, BIOS version, Service Tag, and so on. |
| Memory Settings | Displays information and options related to installed memory. |
| Processor Settings | Displays information and options related to the processor such as speed, cache size, and so on. |
| SATA Settings | Displays options to enable or disable the integrated SATA controller and ports. |
| Boot Settings | Displays options to specify the boot mode (BIOS or UEFI). Enables you to modify UEFI and BIOS boot settings. |
| Integrated Devices | Displays options to enable or disable integrated device controllers and ports, and to specify related features and options. |
| Serial Communication | Displays options to enable or disable the serial ports and specify related features and options. |
| System Profile Settings | Displays options to change the processor power management settings, memory frequency, and so on. |
| System Security | Displays options to configure the system security settings like, system password, setup password, TPM security, and so on. It also enables or disables support for local BIOS update and the power button on the system. |
| Miscellaneous Settings | Displays options to change the system date, time, and so on. |

System Information Screen

| Menu Item | Description |
|---------------------|--|
| System Model Name | Displays the system model name. |
| System BIOS Version | Displays the BIOS version installed on the system. |
| System Service Tag | Displays the system Service Tag. |
| System Manufacturer | Displays the name of system manufacturer. |

| Menu Item | Description |
|---|--|
| System Manufacturer Contact Information | Displays the contact information of the system manufacturer. |

Memory Settings Screen

| Menu Item | Description |
|-----------------------|---|
| System Memory Size | Displays the amount of memory installed in the system. |
| System Memory Type | Displays the type of memory installed in the system. |
| System Memory Speed | Displays the system memory speed. |
| System Memory Voltage | Displays the system memory voltage. |
| Video Memory | Displays the amount of video memory. |
| System Memory Testing | Specifies whether system memory tests are run during system boot. Options are Enabled and Disabled . By default, the System Memory Testing option is set to Disabled . |
| Memory Operating Mode | Specifies the memory operating mode. The options available depending on the memory configuration of your system are Optimizer Mode , Advanced ECC Mode , Mirror Mode , Spare Mode , and Spare with Advanced ECC Mode . By default, the Memory Operating Mode option is set to Optimizer Mode . |
| Node Interleaving | If this field is Enabled , memory interleaving is supported if a symmetric memory configuration is installed. If Disabled , the system supports Non-Uniform Memory architecture (NUMA) (asymmetric) memory configurations. By default, Node Interleaving option is set to Disabled . |

Processor Settings Screen

| Menu Item | Description |
|---|---|
| Logical Processor | Allows you to enable or disable logical processors and display the number of logical processors. If the Logical Processor option is set to Enabled , the BIOS displays all the logical processors. If this option is set to Disabled , the BIOS only displays one logical processor per core. By default, the Logical Processor option is set to Enabled . |
| QPI Speed | Allows you to set the QuickPath Interconnect data rate settings. By default, the QPI Speed option is set to Maximum data rate . |
| |  NOTE: The QPI Speed option is displayed only when both the processors are installed. |
| Alternate RTID (Requestor Transaction ID) Setting | Allows you to allocate more RTIDs to the remote socket increasing cache performance between the sockets or work in normal mode for NUMA. By default, the Alternate RTID (Requestor Transaction ID) Setting is set to Disabled . |
| Virtualization Technology | Allows you enable or disable the additional hardware capabilities provided for virtualization. By default, the Virtualization Technology option is set to Enabled . |
| Adjacent Cache Line Prefetch | Allows you to optimize the system for applications that require high utilization of sequential memory access. By default, the Adjacent Cache Line Prefetch option is set to Enabled . You |



| Menu Item | Description |
|---|---|
| | can disable this option for applications that require high utilization of random memory access. |
| Hardware Prefetcher | Allows you to enable or disable hardware prefetcher. By default, the Hardware Prefetcher option is set to Enabled . |
| DCU Streamer Prefetcher | Allows you to enable or disable DCU streamer prefetcher. By default, the DCU Streamer Prefetcher option is set to Enabled . |
| DCU IP Prefetcher | Allows you to enable or disable DCU IP prefetcher. By default, the DCU IP Prefetcher option is set to Enabled . |
| Execute Disable | Allows you enable or disable execute disable memory protection technology. By default, the Execute Disable option is set to Enabled . |
| Number of Cores per Processor | Allows you to control the number of enabled cores in each processor. By default, the Number of Cores per Processor option is set to All . |
| Processor 64-bit Support | Specifies if the processor(s) support 64-bit extensions. |
| Processor Core Speed | Displays the maximum core frequency of the processor. |
| Processor Bus Speed | Displays the bus speed of the processors. |
| |  NOTE: The processor bus speed option is displayed only when both the processors are installed. |
| Processor XFamily-Model-Stepping | Displays the family and model number of each processor. A submenu displays the core speed, the amount of cache memory, and the number of cores of the processor(s). |

SATA Settings Screen

| Menu Item | Description |
|----------------------|--|
| Embedded SATA | Allows the embedded SATA to be set to Off, ATA, AHCI, or RAID modes. By default, Embedded SATA is set to AHCI . |
| Port A | Auto enables BIOS support for the device attached to SATA port A. Off disables BIOS support for the device. By default, Port A is set to Auto . |
| Port B | Auto enables BIOS support for the device attached to SATA port B. Off disables BIOS support for the device. By default, Port B is set to Auto . |

Boot Settings Screen

| Menu Item | Description |
|------------------|---|
| Boot Mode | Allows you to set the boot mode of the system. |
| |  CAUTION: Switching the boot mode may prevent the system from booting if the operating system is not installed in the same boot mode. |

| Menu Item | Description |
|----------------------------|--|
| | <p>If the operating system supports UEFI, you can set this option to UEFI. Setting this field to BIOS allows compatibility with non-UEFI operating systems. By default, the Boot Mode option is set to BIOS.</p> <p> NOTE: Setting this field to UEFI disables BIOS Boot Settings menu. Setting this field to BIOS disables the UEFI Boot Settings menu.</p> |
| Boot Sequence Retry | <p>Allows you to enable or disable the boot sequence retry feature. If this field is enabled and the system fails to boot, the system reattempts the boot sequence after 30 seconds. By default, the Boot Sequence Retry option is set to Disabled.</p> |
| BIOS Boot Settings | <p>Allows you to enable or disable BIOS Boot options.</p> <p> NOTE: This option is enabled only if the boot mode is BIOS.</p> |
| UEFI Boot Settings | <p>Allows you to enable or disable UEFI Boot options.</p> <p> NOTE: This option is enabled only if the boot mode is UEFI.</p> |
| One-Time Boot | <p>Allows you to enable or disable a one-time boot from a selected device.</p> |

Integrated Devices Screen

| Menu Item | Description |
|------------------------------------|---|
| Integrated RAID Controller | <p>Allows you to enable or disable the integrated RAID controller. By default, the Integrated RAID Controller option is set to Enabled.</p> |
| User Accessible USB Ports | <p>Allows you to set the user accessible ports. Selecting All Ports Off disables all USB ports. By default, the User Accessible USB Ports option is set to All Ports On.</p> |
| Internal USB Port | <p>Allows you to enable or disable the internal USB port. By default, the Internal USB Port option is set to On.</p> |
| Internal SD Card Redundancy | <p>If set to Mirror mode, data is written on both SD cards. If any one of the SD card fails, data is written to the active SD card. Data from this card is copied to the replacement SD card at the next boot.</p> |
| Internal SD Card Port | <p>Enables or disables the system's internal SD card port.</p> |
| Integrated Network Card 1 | <p>Allows you to enable or disable the integrated network card. By default, the Integrated Network Card 1 option is set to Enabled.</p> |
| OS Watchdog Timer | <p>Allows you to enable or disable the OS watchdog timer. When this field is enabled, the operating system initializes the timer and the OS watchdog timer helps in recovering the operating system. By default, the OS Watchdog Timer option is set to Disabled.</p> |
| Embedded Video Controller | <p>Allows you to enable or disable the Embedded Video Controller. By default, the embedded video controller is Enabled.</p> |
| SR-IOV Global Enable | <p>Allows you to enable or disable the BIOS configuration of Single Root I/O Virtualization (SR-IOV) devices. By default, the SR-IOV Global Enable option is set to Disabled.</p> |



| Menu Item | Description |
|------------------|--|
| Slot Disablement | The Slot Disablement feature controls the configuration of mezzanine cards installed in the specified slots. Only mezzanine card slots that are present on your system are available for control. |

Serial Communications Screen

| Menu Item | Description |
|------------------------|--|
| Serial Communication | Allows you to enable the COM port or Console Redirection options. |
| Serial Port Address | Allows you to set the port address for serial devices. By default, the Serial Port Address option is set to COM1 .  NOTE: Only Serial Device 2 can be used for Serial Over LAN (SOL). To use console redirection by SOL, configure the same port address for console redirection and the serial device. |
| Failsafe Baud Rate | Displays the failsafe baud rate for console redirection. The BIOS attempts to determine the baud rate automatically. This failsafe baud rate is used only if the attempt fails and the value must not be changed. By default, the Failsafe Baud Rate option is set to 11520 . |
| Remote Terminal Type | Allows you to set the remote console terminal type. By default, the Remote Terminal Type option is set to VT 100/VT220 . |
| Redirection After Boot | Allows you to enable or disable to the BIOS console redirection when the operating system is loaded. By default, the Redirection After Boot option is set to Enabled . |

System Profile Settings Screen

| Menu Item | Description |
|----------------------|--|
| System Profile | Allows you to set the system profile. If you set the System Profile option to a mode other than Custom , the BIOS automatically sets the rest of the options. You can only change the rest of the options if the mode is set to Custom . By default, the System Profile option is set to Performance Per Watt Optimized (DAPC) . DAPC is Dell Active Power Controller.  NOTE: The following parameters are available only when the System Profile is set to Custom . |
| CPU Power Management | Allows you to set the CPU power management. By default, the CPU Power Management option is set to System DBPM (DAPC) . DBPM is Demand-Based Power Management. |
| Memory Frequency | Allows you to set the memory frequency. By default, the Memory Frequency option is set to Maximum Performance . |
| Turbo Boost | Allows you to enable or disable the processor to operate in turbo boost mode. By default, the Turbo Boost option is set to Enabled . |
| C1E | Allows you to enable or disable the processor to switch to a minimum performance state when it is idle. By default, the C1E option is set to Enabled . |
| C States | Allows you to enable or disable the processor to operate in all available power states. By default, the C States option is set to Enabled . |

| Menu Item | Description |
|---------------------------------|---|
| Monitor/Mwait | <p>Allows you to enable Monitor/Mwait instructions in the processor. By default, the Monitor/Mwait option is set to Enabled for all system profiles, except Custom.</p> <p> NOTE: This option can be disabled only if the C States option in Custom mode is disabled.</p> <p> NOTE: When C States is enabled in Custom mode, changing the Monitor/Mwait setting does not impact system power/performance.</p> |
| Memory Patrol Scrub | Allows you to set the memory patrol scrub frequency. By default, the Memory Patrol Scrub option is set to Standard . |
| Memory Refresh Rate | Allows you to set the memory refresh rate. By default, the Memory Refresh Rate option is set to 1x . |
| Memory Operating Voltage | Allows you to set the DIMM voltage selection. When set to Auto , the system automatically sets the system voltage to the optimal setting based on the DIMM capacity and the numbers of DIMMs installed. By default, the Memory Operating Voltage option is set to Auto . |

System Security Screen

| Menu Item | Description |
|----------------------------|--|
| Intel AES-NI | The Intel AES-In option improves the speed of applications by performing encryption and decryption using the Advanced Encryption Standard set and is set to Enabled by default. |
| System Password | Allows you to set the system password. This option is read-only if the password jumper is not installed in the system. |
| Setup Password | Allows you to set the setup password. This option is read-only if the password jumper is not installed in the system. |
| Password Status | Allows you to lock the system password. By default, the Password Status option is set to Unlocked . |
| TPM Security | Allows you to control the reporting mode of the Trusted Platform Module (TPM). By default, the TPM Security option is set to Off . You can only modify the TPM Status, TPM Activation , and Intel TXT fields if the TPM Status field is set to either On with Pre-boot Measurements or On without Pre-boot Measurements . |
| TPM Activation | Allows you to change the operational state of the TPM. By default, the TPM Activation option is set to No Change . |
| TPM Status | Displays the TPM status. |
| TPM Clear | <p> CAUTION: Clearing the TPM results in loss of all keys in the TPM. The loss of TPM keys may affect booting to the operating system.</p> <p>Allows you to clear all the contents of the TPM. By default, the TPM Clear option is set to No.</p> |
| Intel TXT | Allows you enable or disable Intel Trusted Execution Technology. To enable Intel TXT, Virtualization Technology must be enabled and TPM Security must be enabled with Pre-boot measurements. By default, the Intel TXT option is set to Off . |
| BIOS Update Control | Allows you to update the BIOS using either DOS or UEFI shell-based flash utilities. For environments that do not require local BIOS updates, it is recommended to set this field to Limited . By default, the Local BIOS Update Support option is set to Unlocked . |

| Menu Item | Description |
|--------------------------|---|
| |  NOTE: BIOS updates using Dell Update Package is not affected by this option. |
| Power Button | Allows you to enable or disable the power button on the front of the system. By default, the Power Button option is set to Enabled . |
| AC Power Recovery | Allows you to set how the system reacts after AC power is restored to the system. By default, the AC Power Recovery option is set to Last . |

Miscellaneous Settings

| Menu Item | Description |
|-----------------------------------|--|
| System Time | Allows you to set the time on the system. |
| System Date | Allows you to set the date on the system. |
| Asset Tag | Displays the asset tag and allows you to modify it for security and tracking purposes. |
| Keyboard NumLock | Allows you to set whether the system boots with the NumLock enabled or disabled. By default the Keyboard NumLock is set to On .  NOTE: This field does not apply to 84-key keyboards. |
| Report Keyboard Errors | Allows you to set whether keyboard-related error messages are reported during system boot. By default, the Report Keyboard Errors field is set to Report . |
| F1/F2 Prompt on Error | Allows you to enable or disable the F1/F2 prompt on error. By default, F1/F2 Prompt on Error is set to Enabled . |
| In-System Characterization | This field enables or disables In-System Characterization . By default, In-System Characterization is set to Enabled . |

System And Setup Password Features

You can create a system password and a setup password to secure your system. To enable creation of the system and setup password, the password jumper must be set to enabled. For more information on the password jumper settings, see System Board Jumper Settings.

System password This is the password that you must enter to log on to your system.

Setup password This is the password that you must enter to access and make changes to the BIOS or UEFI settings of your system.

 **CAUTION:** The password features provide a basic level of security for the data on your system.

 **CAUTION:** Anyone can access the data stored on your system if the system is running and unattended.

 **NOTE:** Your system is shipped with the system and setup password feature disabled.

Assigning A System And/Or Setup Password

 **NOTE:** The password jumper enables or disables the System Password and Setup Password features. For more information on the password jumper settings, see System Board Jumper Settings.

You can assign a new **System Password** and/or **Setup Password** or change an existing **System Password** and/or **Setup Password** only when the password jumper setting is enabled and **Password Status** is **Unlocked**. If the Password Status is **Locked**, you cannot change the System Password and/or Setup Password.

If the password jumper setting is disabled, the existing System Password and Setup Password is deleted and you need not provide the system password to log on to the system.

To assign a system and/or setup password:

1. To enter System Setup, press <F2> immediately after a power-on or reboot.
2. In the **System Setup Main Menu**, select **System BIOS** and press <Enter>. The **System BIOS** screen is displayed.
3. In the **System BIOS** screen, select **System Security** and press <Enter>. The **System Security** screen is displayed.
4. In the **System Security** screen, verify that **Password Status** is **Unlocked**.
5. Select **System Password**, enter your system password, and press <Enter> or <Tab>.

Use the following guidelines to assign the system password:

- A password can have up to 32 characters.
- The password can contain the numbers 0 through 9.
- Only lower case letters are valid, upper case letters are not allowed.
- The following special characters are allowed: space, ("), (+), (,), (-), (.), (/), (;), (!), (\), (]), (').

A message prompts you to re-enter the system password.

6. Re-enter the system password that you entered earlier and click **OK**.
7. Select **Setup Password**, enter your system password and press <Enter> or <Tab>. A message prompts you to re-enter the setup password.
8. Re-enter the setup password that you entered earlier and click **OK**.
9. Press <Esc> to save the changes.

 **NOTE:** Password protection does not take effect until the system reboots.

Using Your System Password To Secure Your System

 **NOTE:** If you have assigned a setup password, the system accepts your setup password as an alternate system password.

1. Turn on or reboot your system.
2. Type your password and press <Enter>.

When **Password Status** is **Locked**, type the password and press <Enter> when prompted at reboot.

If an incorrect system password is entered, the system displays a message and prompts you to re-enter your password. You have three attempts to enter the correct password. After the third unsuccessful attempt, the system displays an error message that the system has halted and must be powered down.

Even after you shut down and restart the system, the error message is displayed until the correct password is entered.

 **NOTE:** You can use the **Password Status** option in conjunction with the **System Password** and **Setup Password** options to protect your system from unauthorized changes.

Deleting Or Changing An Existing System And/Or Setup Password

Ensure that the Password jumper is set to enabled and the **Password Status** is **Unlocked** before attempting to delete or change the existing System and/or Setup password. You cannot delete or change an existing System or Setup password if the **Password Status** is **Locked**.

To delete or change the existing System and/or Setup password:

1. To enter System Setup, press <F2> immediately after a power-on or reboot.
 2. In the **System Setup Main Menu**, select **System BIOS** and press <Enter>. The **System BIOS** screen is displayed.
 3. In the **System BIOS Screen**, select **System Security** and press <Enter>. The **System Security** screen is displayed.
 4. In the **System Security** screen, verify that **Password Status** is **Unlocked**.
 5. Select **System Password**, alter or delete the existing system password and press <Enter> or <Tab>.
 6. Select **Setup Password**, alter or delete the existing setup password and press <Enter> or <Tab>.
-  **NOTE:** If you change the System and/or Setup password a message prompts you to re-enter the new password. If you delete the System and/or Setup password, a message prompts you to confirm the deletion.
7. Press <Esc> to save the changes.

 **NOTE:** You can disable password security while logging on to the system. To disable the password security, turn on or reboot your system, type your password and press <Ctrl><Enter>.

Operating With A Setup Password Enabled

If **Setup Password** is **Enabled**, enter the correct setup password before modifying most of the System Setup options.

If you do not enter the correct password in three attempts, the system displays the message

```
Incorrect Password! Number of unsuccessful password attempts: <x> System  
Halted! Must power down.
```

Even after you shut down and restart the system, the error message is displayed until the correct password is entered.

The following options are exceptions:

- If **System Password** is not **Enabled** and is not locked through the **Password Status** option, you can assign a system password.
- You cannot disable or change an existing system password.

 **NOTE:** You can use the **Password Status** option in conjunction with the **Setup Password** option to protect the system password from unauthorized changes.

Entering The UEFI Boot Manager

 **NOTE:** Operating systems must be 64-bit UEFI-compatible (for example, Microsoft Windows Server 2008 x64 version) to be installed from the UEFI boot mode. DOS and 32-bit operating systems can only be installed from the BIOS boot mode.

The Boot Manager enables you to:

- Add, delete, and arrange boot options
- Access System Setup and BIOS-level boot options without rebooting

To enter the Boot Manager:

1. Turn on or restart your system.
2. Press <F11> after you see the following message:
<F11> = UEFI Boot Manager

If your operating system begins to load before you press <F11>, allow the system to finish booting, and then restart your system and try again.

Using The Boot Manager Navigation Keys

| Key | Description |
|------------|--|
| Up arrow | Moves to the previous field. |
| Down arrow | Moves to the next field. |
| <Enter> | Allows you to type in a value in the selected field (if applicable) or follow the link in the field. |
| Spacebar | Expands or collapses a drop-down list, if applicable. |
| <Esc> | Moves to the previous page till you view the main screen. Pressing <Esc> in the main screen exits System Setup. A message prompts you to save any unsaved changes. |
| <F1> | Displays the System Setup help file. |

 **NOTE:** For most of the options, any changes that you make are recorded but do not take effect until you restart the system.

Boot Manager Screen

| Menu Item | Description |
|-----------------------------|---|
| Continue Normal Boot | The system attempts to boot to devices starting with the first item in the boot order. If the boot attempt fails, the system continues with the next item in the boot order until the boot is successful or no more boot options are found. |
| BIOS Boot Menu | Displays the list of available BIOS boot options (marked with asterisks). Select the boot option you wish to use and press <Enter>. |
| UEFI Boot Menu | Displays the list of available UEFI boot options (marked with asterisks). Select the boot option you wish to use and press <Enter>. The UEFI Boot Menu enables you to Add Boot Option , Delete Boot Option , or Boot From File . |
| Driver Health Menu | Displays a list of the drivers installed on the system and their health status. |
| Launch System Setup | Enables you to access the System Setup. |
| System Utilities | Enables you to access the BIOS Update File Explorer, run the Dell Diagnostics program, and reboot the system. |

UEFI Boot Menu

| Menu Item | Description |
|--------------------------------|---|
| Boot From File | Sets a one-time boot option not included in the boot option list. |
| Select UEFI Boot Option | Displays the list of available UEFI boot options (marked with asterisks), select the boot option you wish to use and press <Enter>. |
| Add Boot Option | Adds a new boot option. |
| Delete Boot Option | Deletes an existing boot option. |

Embedded System Management

The Dell Lifecycle Controller provides advanced embedded systems management throughout the server's lifecycle. The Lifecycle Controller can be started during the boot sequence and can function independently of the operating system.

 **NOTE:** Certain platform configurations may not support the full set of features provided by the Lifecycle Controller.

For more information about setting up the Lifecycle Controller, configuring hardware and firmware, and deploying the operating system, see the Lifecycle Controller documentation at support.dell.com/manuals.

iDRAC Settings Utility

The iDRAC Settings utility is an interface to setup and configure the iDRAC parameters using UEFI. You can enable or disable various iDRAC parameters using the iDRAC7 Settings Utility, for example:

 **NOTE:** Some of the features mentioned in the list may require the iDRAC7 Enterprise License upgrade.

- Configure, enable, or disable the iDRAC local area network through the dedicated iDRAC Enterprise card port or the embedded NIC
- Enable or disable IPMI over LAN
- Enable a LAN Platform Event Trap (PET) destination
- Attach or detach the Virtual Media devices

For more information on using iDRAC7, see the iDRAC7 User's Guide, at support.dell.com/manuals.

Entering The iDRAC Settings Utility

1. Turn on or restart the managed system.
2. Press <F2> during Power-on Self-test (POST).
3. In the **System Setup Main Menu** page, click **iDRAC Settings**.

The iDRAC Settings page is displayed.

Installing Blade Components

Recommended Tools

You may need the following items to perform the procedures in this section:

- #1 and #2 Phillips screwdrivers
- T8 and T10 Torx drivers
- Wrist grounding strap

Removing And Installing A Blade

 **CAUTION:** Many repairs may only be done by a certified service technician. You should only perform troubleshooting and simple repairs as authorized in your product documentation, or as directed by the online or telephone service and support team. Damage due to servicing that is not authorized by Dell is not covered by your warranty. Read and follow the safety instructions that came with the product.

 **NOTE:** These procedures are applicable only for full-height and half-height blades. For information on removing and installing quarter-height blades from a sleeve, see the blade's Owner's Manual at support.dell.com/manuals.

Removing The Blade

1. Power down the blade using OS commands or the CMC, and ensure that the blade's power is off.
When a blade is powered off, its front-panel power indicator is off.
2. Before removing half-height blades 11 or 12, rotate the LCD panel to the storage position to prevent accidental damage to the LCD screen.
3. Press the release button on the handle.
4. Pull out the handle to unlock the blade from the enclosure.
5. Slide the blade out of the enclosure.

 **CAUTION:** To protect the I/O connector pins, install the I/O connector cover any time a blade is removed from the enclosure.

6. Install the I/O connector cover over the I/O connector.

 **CAUTION:** If you are permanently removing the blade, install a blade blank. Operating the system for extended periods of time without a blade blank installed can cause the enclosure to overheat.

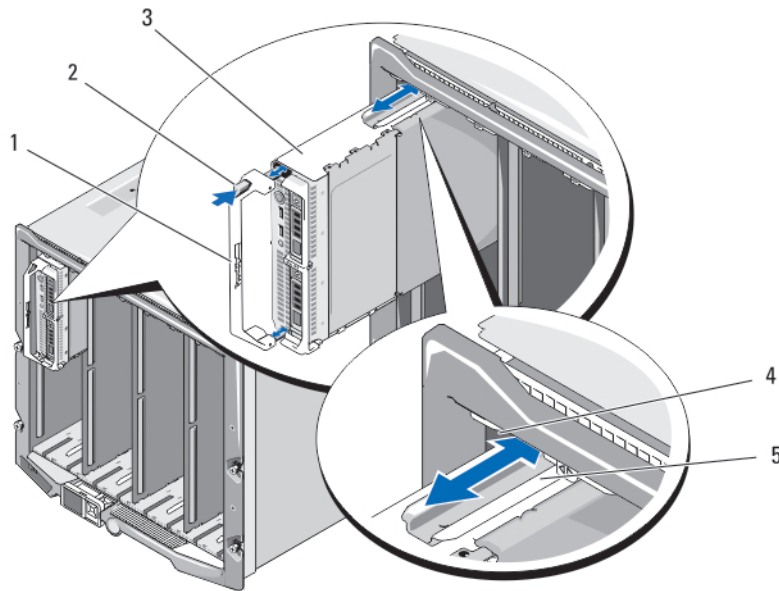

Figure 3. Removing or Installing the Blade

1. blade handle
2. release button
3. blade
4. guide rail on enclosure
5. guide rail on blade (or blade blank)

Installing The Blade

1. If you are installing a new blade, remove the plastic cover from the I/O connector(s) and save for future use.
2. Orient the blade so that the handle is on the left side of the blade.
3. If you are installing a half-height blade in bays 11 or 12, rotate the LCD module to the horizontal storage position to prevent accidental damage to the LCD screen.
4. If you are installing a half-height blade in one of the eight upper bays, align the guide rail on the upper edge of the blade so that the rail fits between the plastic guides on the enclosure.
If you are installing a half-height blade in one of the eight lower bays, align the edge of the blade with the guide rail on the floor of the M1000e enclosure.
5. Slide the blade into the enclosure until the handle engages and locks the blade in place.

Opening And Closing The Blade

Opening The Blade

CAUTION: Many repairs may only be done by a certified service technician. You should only perform troubleshooting and simple repairs as authorized in your product documentation, or as directed by the online or telephone service and support team. Damage due to servicing that is not authorized by Dell is not covered by your warranty. Read and follow the safety instructions that came with the product.

NOTE: It is recommended that you always use a static mat and static strap while working on components in the interior of the system.

1. Remove the blade from the enclosure.
2. Install the I/O connector cover.
3. Press the release button and slide the cover toward the back of the blade.
4. Carefully lift the cover away from the blade.

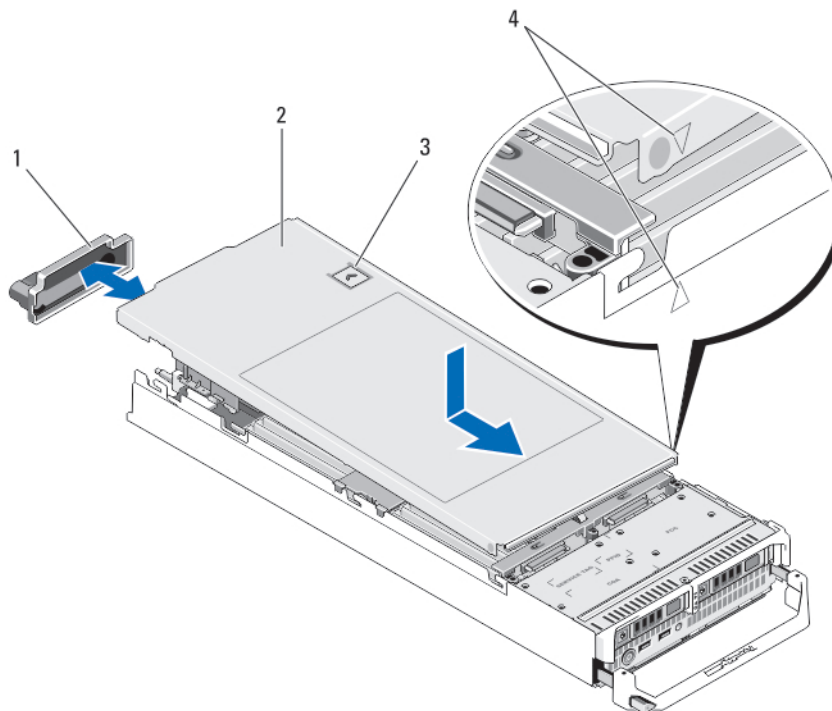

Figure 4. Opening and Closing the Blade

1. I/O connector cover
2. blade cover
3. release button
4. cover alignment pins and notches

Closing The Blade

1. Ensure that no tools or parts are left inside the blade.
2. Align the notches in the edges of the chassis with the cover alignment pins on the inner sides of the cover.
3. Lower the cover onto the chassis.
4. Slide the cover until it clicks into position.
A properly seated cover is flush with the surface of the chassis.

Inside The Blade

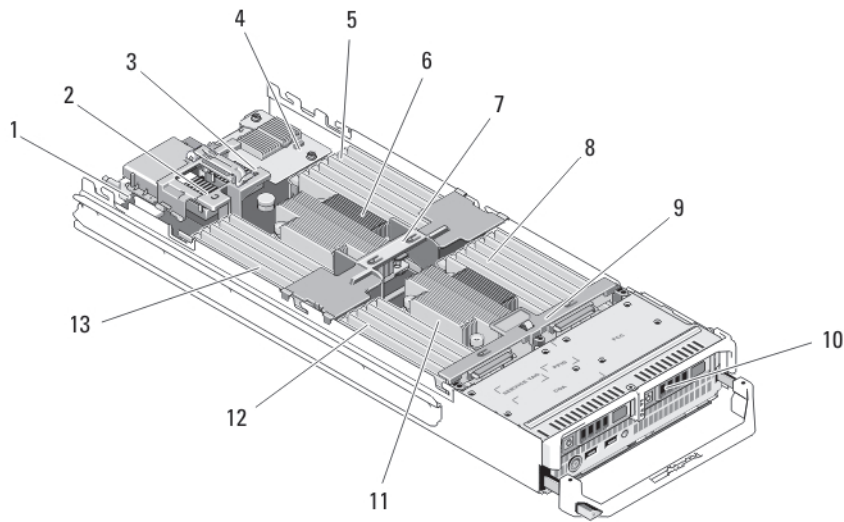

Figure 5. Inside the Blade

- | | |
|---|--------------------------------------|
| 1. management riser card | 8. memory modules (for processor 2) |
| 2. optional mezzanine card 1 - Fabric C | 9. hard-drive/SSD backplane |
| 3. optional mezzanine card 2 - Fabric B | 10. hard drives/SSDs (2) |
| 4. network daughter card | 11. processor 2 and heat sink |
| 5. memory modules (for processor 1) | 12. memory modules (for processor 2) |
| 6. processor 1 and heat sink | 13. memory modules (for processor 1) |
| 7. cooling shroud | |

Cooling Shroud

The cooling shroud covers the memory modules and directs air flow in the system.

Removing The Cooling Shroud

CAUTION: Many repairs may only be done by a certified service technician. You should only perform troubleshooting and simple repairs as authorized in your product documentation, or as directed by the online or telephone service and support team. Damage due to servicing that is not authorized by Dell is not covered by your warranty. Read and follow the safety instructions that came with the product.

CAUTION: Never operate your system with the cooling shroud removed. The system may get overheated quickly, resulting in shutdown and loss of data.

1. Remove the blade from the enclosure.
2. Open the blade.
3. Hold the cooling shroud at both ends near the blade chassis and lift it up and away from the blade.

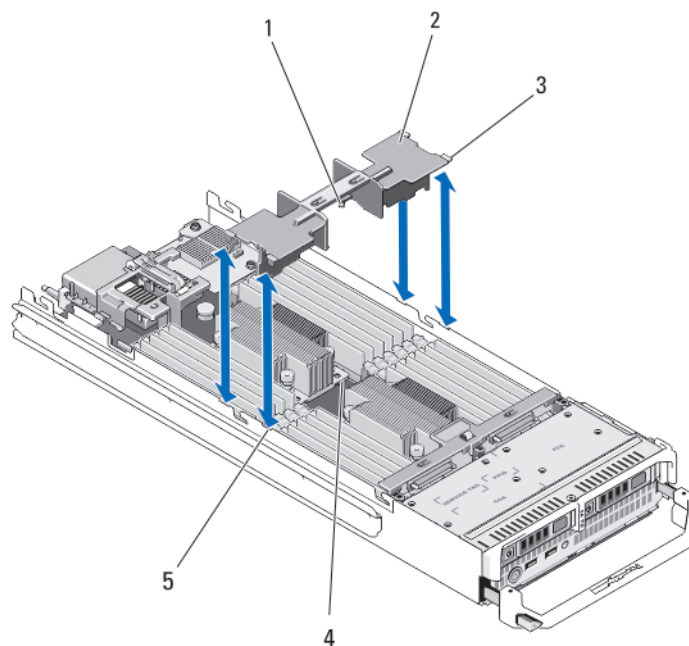



Figure 6. Installing and Removing a Cooling Shroud

1. pins under the cooling shroud (2)
2. cooling shroud
3. tabs (4)
4. holes on the heat sink (2)
5. slots on the chassis (4)

Installing The Cooling Shroud

 **CAUTION:** Many repairs may only be done by a certified service technician. You should only perform troubleshooting and simple repairs as authorized in your product documentation, or as directed by the online or telephone service and support team. Damage due to servicing that is not authorized by Dell is not covered by your warranty. Read and follow the safety instructions that came with the product.

1. Position the tabs below the shroud to align with the holes on the heat sink installed on processor socket CPU1.
2. Lower the cooling shroud into the system until the tabs on the sides of the shroud engage with the slots on the blade chassis and the pins under the shroud engage with the holes on the heat sink.
3. Close the blade.
4. Install the blade in the enclosure.

System Memory

Your system supports DDR3 unbuffered ECC DIMMs (UDIMM ECC) and registered DIMMs (RDIMMs). It supports DDR3 and DDR3L voltage specifications.

 **NOTE:** MT/s indicates DIMM speed in MegaTransfers per second.

Memory bus operating frequency can be 1600 MT/s, 1333 MT/s, 1066 MT/s, or 800 MT/s depending on:

- DIMM type (UDIMM, RDIMM, or LRDIMM)
- DIMM configuration (number of ranks)
- maximum frequency of the DIMMs
- number of DIMMs populated per channel
- DIMM operating voltage
- system profile selected (for example, Performance Optimized, Custom, or Dense Configuration Optimized)
- maximum supported DIMM frequency of the processors

The system contains 24 memory sockets split into two sets of 12 sockets, one set per processor. Each 12-socket set is organized into four channels. In each channel, the release levers of the first socket are marked white, the second socket black, and the third socket green.

 **NOTE:** DIMMs in sockets A1 to A12 are assigned to processor 1 and DIMMs in sockets B1 to B12 are assigned to processor 2.

The following table shows the memory populations and operating frequencies for the supported configurations.

| DIMM Type | DIMMs Populated/ Channel | Operating Frequency (in MT/s) | | Maximum DIMM Rank/ Channel |
|-----------|-----------------------------|-------------------------------|---------------------|-------------------------------|
| | | 1.5 V | 1.35 V | |
| UDIMM ECC | 1 | 1333, 1066, and 800 | 1333, 1066, and 800 | Dual rank |
| | 2 | 1333, 1066, and 800 | 1333, 1066, and 800 | Dual rank |
| RDIMM | 1 | 1600, 1333, 1066, and 800 | 1333, 1066, and 800 | Dual rank |
| | | 1333, 1066, and 800 | 1066 and 800 | Quad rank |
| | 2 | 1600, 1333, 1066, and 800 | 1333, 1066, and 800 | Dual rank |
| | | 1066 and 800 | 1066 and 800 | Quad rank |

| DIMM Type | DIMMs Populated/ Channel | Operating Frequency (in MT/s) | | Maximum DIMM Rank/ Channel |
|-----------|-----------------------------|-------------------------------|---------------|-------------------------------|
| | | 1.5 V | 1.35 V | |
| LRDIMM | 3 | 1333, 1066, and 800 | 1066 and 800 | Dual rank |
| | 1 | 1333 and 1066 | 1333 and 1066 | Quad rank |
| | 2 | 1333 and 1066 | 1333 and 1066 | Quad rank |
| | 3 | 1066 | 1066 | Quad rank |

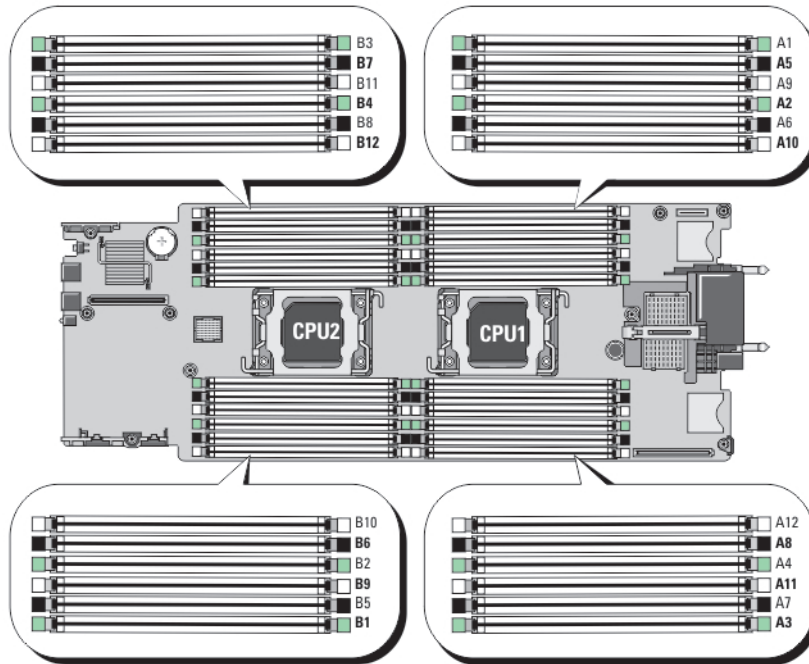



Figure 7. Memory Socket Locations

Memory channels are organized as follows:

- Processor 1**
- channel 0: memory sockets A2, A6, and A10
 - channel 1: memory sockets A1, A5, and A9
 - channel 2: memory sockets A4, A8, and A12
 - channel 3: memory sockets A3, A7, and A11
- Processor 2**
- channel 0: memory sockets B2, B6, and B10
 - channel 1: memory sockets B1, B5, and B9
 - channel 2: memory sockets B4, B8, and B12
 - channel 3: memory sockets B3, B7, and B11

General Memory Module Installation Guidelines

 **NOTE:** Memory configurations that fail to observe these guidelines can prevent your system from starting and producing any video output, hanging during memory configuration, or operating with reduced memory.

This system supports Flexible Memory Configuration, enabling the system to be configured and run in any valid chipset architectural configuration. The following are the recommended guidelines for best performance:

- UDIMMs and RDIMMs must not be mixed.
- x4 and x8 DRAM based DIMMs can be mixed. For more information, see Mode-Specific Guidelines.
- A maximum of two UDIMMs can be populated in a channel.
- Up to two quad-rank RDIMMs and up to three dual- or single-rank RDIMMs can be populated per channel.
- Populate DIMM sockets only if a processor is installed. For single-processor systems, sockets A1 to A12 are available. For dual-processor systems, sockets A1 to A12 and sockets B1 to B12 are available.
- Populate all sockets with white release tabs first, then black, and then green.
- Do not populate the third DIMM socket in a channel with green release tabs, if a quad-rank RDIMM is populated in the first socket with white release tabs.
- Populate the sockets by highest rank count in the following order - first in sockets with white release levers, then black, and then green. For example, if you want to mix quad-rank and dual-rank DIMMs, populate quad-rank DIMMs in the sockets with white release tabs and dual-rank DIMMs in the sockets with black release tabs.
- In a dual-processor configuration, the memory configuration for each processor must be identical. For example, if you populate socket A1 for processor 1, then populate socket B1 for processor 2, and so on.
- Memory modules of different sizes can be mixed provided that other memory population rules are followed (for example, 2 GB and 4 GB memory modules can be mixed).
- Populate four DIMMs per processor (one DIMM per channel) at a time to maximize performance.
- If memory modules with different speeds are installed, they will operate at the speed of the slowest installed memory module(s) or slower depending on system DIMM configuration.
- Populate DIMMs based on the following processor-heat sink configurations.

| Processor Configuration | Processor Type (in Watts) | Heat Sink | Number of DIMMs | |
|-------------------------|---------------------------|-----------|--|--|
| | | | Maximum System Capacity | Reliability, Availability, and Serviceability (RAS) Features |
| Single processor | up to 95 W | 57 mm | 12 | 12 |
| Single processor | 115 W or 130 W | 77 mm | 10 (Three DIMMs in channels 0 and 3 and two DIMMs in channels 1 and 2) | 8 (Two DIMMs per channel) |
| Dual processor | up to 95 W | 57 mm | 24 | 24 |
| Dual processor | 115 W or 130 W | 77 mm | 20 (Three DIMMs in channels 0 and 3 and two DIMMs in channels 1 and 2) | 16 (Two DIMMs per channel) |

Mode-Specific Guidelines

Four memory channels are allocated to each processor. The allowable configurations depend on the memory mode selected.

 **NOTE:** x4 and x8 DRAM based DIMMs can be mixed providing support for RAS features. However, all guidelines for specific RAS features must be followed. x4 DRAM based DIMMs retain Single Device Data Correction (SDDC) in memory optimized (independent channel) mode. x8 DRAM based DIMMs require Advanced ECC mode to gain SDDC.

The following sections provide additional slot population guidelines for each mode.

Advanced ECC (Lockstep)

Advanced ECC mode extends SDDC from x4 DRAM based DIMMs to both x4 and x8 DRAMs. This protects against single DRAM chip failures during normal operation.

Memory installation guidelines:

- Memory modules must be identical in size, speed, and technology.
- DIMMs installed in memory sockets with white release tabs must be identical and similar rule applies for sockets with black and green release tabs. This ensures that identical DIMMs are installed in matched pairs - for example, A1 with A2, A3 with A4, A5 with A6, and so on.

 **NOTE:** Advanced ECC with mirroring is not supported.

Memory Optimized (Independent Channel) Mode

This mode supports SDDC only for memory modules that use x4 device width and does not impose any specific slot population requirements.

Memory Sparing

 **NOTE:** To use memory sparing, this feature must be enabled in the System Setup.

In this mode, one rank per channel is reserved as a spare. If persistent correctable errors are detected on a rank, the data from this rank is copied to the spare rank and the failed rank is disabled.

With memory sparing enabled, the system memory available to the operating system is reduced by one rank per channel. For example, in a dual-processor configuration with sixteen 4 GB dual-rank DIMMs, the available system memory is: $\frac{3}{4}$ (ranks/channel) \times 16 (DIMMs) \times 4 GB = 48 GB, and not 16 (DIMMs) \times 4 GB = 64 GB.

 **NOTE:** Memory sparing does not offer protection against a multi-bit uncorrectable error.

 **NOTE:** Both Advanced ECC/Lockstep and Optimizer modes support Memory Sparing.

Memory Mirroring

Memory Mirroring offers the strongest DIMM reliability mode compared to all other modes, providing improved uncorrectable multi-bit failure protection. In a mirrored configuration, the total available system memory is one half of the total installed physical memory. Half of the installed memory is used to mirror the active DIMMs. In the event of an uncorrectable error, the system will switch over to the mirrored copy. This ensures SDDC and multi-bit protection.

Memory installation guidelines:

- Memory modules must be identical in size, speed, and technology.
- DIMMs installed in memory sockets with white release tabs must be identical and similar rule applies for sockets with black and green release tabs. This ensures that identical DIMMs are installed in matched pairs - for example, A1 with A2, A3 with A4, A5 with A6, and so on.

Sample Memory Configurations

The following tables show sample memory configurations that follow the appropriate memory guidelines stated in this section.

 **NOTE:** 16 GB quad-rank RDIMMs are not supported.



NOTE: 1R, 2R, and 4R in the following tables indicate single-, dual-, and quad-rank DIMMs respectively.

Table 1. Memory Configurations – Single Processor





| System Capacity (in GB) | DIMM Size (in GB) | Number of DIMMs | Organization and Speed | DIMM Slot Population |
|-------------------------|-------------------|-----------------|--------------------------------------|---|
| 2 | 2 | 1 | 1R x8, 1333 MT/s 1R x8, 1600 MT/s | A1 |
| 4 | 2 | 2 | 1R x8, 1333 MT/s 1R x8, 1600 MT/s | A1, A3 |
| 8 | 2 | 4 | 1R x8, 1333 MT/s 1R x8, 1600 MT/s | A1, A2, A3, A4 |
| 12 | 2 | 6 | 1R x8, 1333 MT/s 1R x8, 1600 MT/s | A1, A2, A3, A4, A5, A6 |
| 16 | 2 | 8 | 1R x8, 1333 MT/s | A1, A2, A3, A4, A5, A6, A7, A8 |
| 16 | 4 | 4 | 2R x8, 1333 MT/s 2R x8, 1600 MT/s | A1, A2, A3, A4 |
| 24 | 2 | 12 | 1R x8, 1333 MT/s | A1, A2, A3, A4, A5, A6, A7, A8, A9, A10, A11, A12 |
| 24 | 4 | 6 | 2R x8, 1333 MT/s 2R x8, 1600 MT/s | A1, A2, A3, A4, A5, A6 |
| 48 | 4 | 12 | 2R x8, 1333 MT/s | A1, A2, A3, A4, A5, A6, A7, A8, A9, A10, A11, A12 |
| 48 | 8 | 6 | 2R x4, 1333 MT/s 2R x4, 1600 MT/s | A1, A2, A3, A4, A5, A6 |
| 96 | 8 | 12 | 2R x4, 1333 MT/s | A1, A2, A3, A4, A5, A6, A7, A8, A9, A10, A11, A12 |
| 96 | 16 | 6 | 2R x4, 1333 MT/s 2R x4, 1600 MT/s | A1, A2, A3, A4, A5, A6 |
| 128 | 16 | 8 | 2R x4, 1333 MT/s 2R x4, 1600 MT/s | A1, A2, A3, A4, A5, A6, A7, A8 |
| 144 | 16 and 8 | 10 | 2R x4, 1333 MT/s | A1, A2, A3, A4, A5, A6, A7, A8, A9, A11 |
| | | | | NOTE: 16 GB DIMMs must be installed in the slots numbered A1, A2, A3, A4, A5, A6, A7, and A8 and 8 GB DIMMs must be installed in slots A9 and A11. |
| 256 | 32 | 8 | 4R x4, 1333 MT/s | A1, A2, A3, A4, A5, A6, A7, A8 |
| 384 | 32 | 12 | 4R x4, 1333 MT/s (LRDIMMs only) | A1, A2, A3, A4, A5, A6, A7, A8, A9, A10, A11, A12 |

Table 2. Memory Configurations – Two Processors

| System Capacity (in GB) | DIMM Size (in GB) | Number of DIMMs | Organization and Speed | DIMM Slot Population |
|--|-------------------|-----------------|--------------------------------------|---|
| 16 | 2 | 8 | 1R x8, 1333 MT/s 1R x8, 1600 MT/s | A1, A2, A3, A4, B1, B2, B3, B4 |
| 32 | 2 | 16 | 1R x8, 1333 MT/s | A1, A2, A3, A4, A5, A6, A7, A8, B1, B2, B3, B4, B5, B6, B7, B8 |
| 32 | 4 | 8 | 2R x8, 1333 MT/s 2R x8, 1600 MT/s | A1, A2, A3, A4, B1, B2, B3, B4 |
| 64 | 4 | 16 | 2R x8, 1333 MT/s | A1, A2, A3, A4, A5, A6, A7, A8, B1, B2, B3, B4, B5, B6, B7, B8 |
| 64 | 8 | 8 | 2R x4, 1333 MT/s 2R x4, 1600 MT/s | A1, A2, A3, A4, B1, B2, B3, B4 |
| 96 | 4 | 24 | 2R x8, 1333 MT/s | A1, A2, A3, A4, A5, A6, A7, A8, A9, A10, A11, A12, B1, B2, B3, B4, B5, B6, B7, B8, B9, B10, B11, B12 |
| 96 | 8 | 12 | 2R x8, 1333 MT/s 2R x8, 1600 MT/s | A1, A2, A3, A4, A5, A6, B1, B2, B3, B4, B5, B6 |
| 128 | 8 | 16 | 2R x4, 1333 MT/s | A1, A2, A3, A4, A5, A6, A7, A8, B1, B2, B3, B4, B5, B6, B7, B8 |
| 128 | 16 | 8 | 2R x4, 1333 MT/s 2R x4, 1600 MT/s | A1, A2, A3, A4, B1, B2, B3, B4 |
| 160 | 8 | 20 | 2R x4, 1333 MT/s | A1, A2, A3, A4, A5, A6, A7, A8, A9, A11, B1, B2, B3, B4, B5, B6, B7, B8, B9, B11 |
| 160 | 16 and 8 | 12 | 2R x4, 1333 MT/s 2R x4, 1600 MT/s | A1, A2, A3, A4, A5, A6, B1, B2, B3, B4, B5, B6 |
|  NOTE: 16 GB DIMMs must be installed in the slots numbered A1, A2, A3, A4, B1, B2, B3, and B4 and 8 GB DIMMs must be installed in slots A5, A6, B5 and B6. | | | | |
| 192 | 8 | 24 | 2R x4, 1333 MT/s | A1, A2, A3, A4, A5, A6, A7, A8, A9, A10, A11, A12, B1, B2, B3, B4, B5, B6, B7, B8, B9, B10, B11, B12 |
| 192 | 16 | 12 | 2R x4, 1333 MT/s 2R x4, 1600 MT/s | A1, A2, A3, A4, A5, A6, B1, B2, B3, B4, B5, B6 |
| 256 | 16 | 16 | 2R x4, 1333 MT/s 2R x4, 1600 MT/s | A1, A2, A3, A4, A5, A6, A7, A8, B1, B2, B3, B4, B5, B6, B7, B8 |

| System Capacity (in GB) | DIMM Size (in GB) | Number of DIMMs | Organization and Speed | DIMM Slot Population |
|-------------------------|-------------------|-----------------|---------------------------------|--|
| 384 | 16 | 24 | 2R x4, 1333 MT/s | A1, A2, A3, A4, A5, A6, A7, A8, A9, A10, A11, A12, B1, B2, B3, B4, B5, B6, B7, B8, B9, B10, B11, B12 |
| 512 | 32 | 16 | 4R x4, 1333 MT/s | A1, A2, A3, A4, A5, A6, A7, A8, B1, B2, B3, B4, B5, B6, B7, B8 |
| 768 | 32 | 24 | 4R x4, 1333 MT/s (LRDIMMs only) | A1, A2, A3, A4, A5, A6, A7, A8, A9, A10, A11, A12, B1, B2, B3, B4, B5, B6, B7, B8, B9, B10, B11, B12 |

Removing Memory Modules

-  **WARNING:** The DIMMs are hot to touch for some time after the blade has been powered down. Allow time for the DIMMs to cool before handling them. Handle the DIMMs by the card edges and avoid touching the DIMM components.
-  **CAUTION:** Many repairs may only be done by a certified service technician. You should only perform troubleshooting and simple repairs as authorized in your product documentation, or as directed by the online or telephone service and support team. Damage due to servicing that is not authorized by Dell is not covered by your warranty. Read and follow the safety instructions that came with the product.
-  **CAUTION:** To ensure proper system cooling, memory-module blanks must be installed in any memory socket that is not occupied. Remove memory-module blanks only if you intend to install memory in those sockets.
-  **CAUTION:** If you are permanently removing a processor, you must install a socket protective cap and a processor/DIMM blank in the vacant socket to ensure proper system cooling. The processor/DIMM blank covers the vacant sockets for the DIMMs and the processor.
1. Remove the blade from the enclosure.
 2. Open the blade.
 3. Remove the cooling shroud.
 4. Locate the memory module socket(s).
-  **CAUTION:** Handle each memory module only on either card edge, making sure not to touch the middle of the memory module.
5. Press down and out on the ejectors on each end of the socket until the memory module pops out of the socket.
 6. Install the cooling shroud.
 7. Close the blade.
 8. Install the blade in the enclosure.

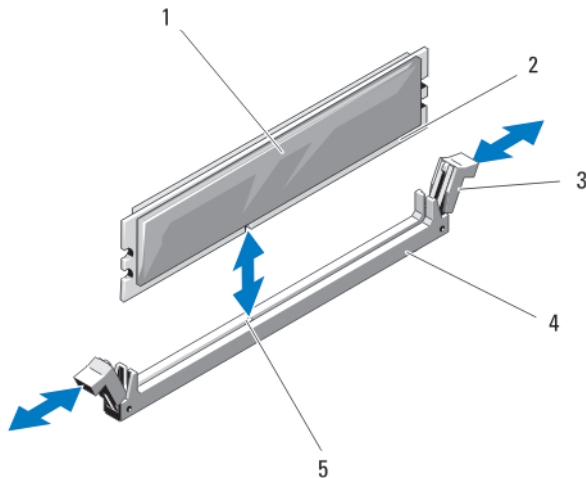

Figure 8. Installing and Removing a Memory Module or Memory Module Blank

1. memory module or memory blank
2. edge connector
3. ejectors (2)
4. socket
5. alignment key

Installing Memory Modules

- ⚠ WARNING:** The memory modules are hot to the touch for some time after the system has been powered down. Allow time for the memory modules to cool before handling them. Handle the memory modules by the card edges and avoid touching the components on the memory module.
- ⚠ CAUTION:** Many repairs may only be done by a certified service technician. You should only perform troubleshooting and simple repairs as authorized in your product documentation, or as directed by the online or telephone service and support team. Damage due to servicing that is not authorized by Dell is not covered by your warranty. Read and follow the safety instructions that came with the product.
- ⚠ CAUTION:** To ensure proper system cooling, memory-module blanks must be installed in any memory socket that is not occupied. Remove memory-module blanks only if you intend to install memory in those sockets.
- ⚠ CAUTION:** If you are permanently removing a processor, you must install a socket protective cap and a processor/DIMM blank in the vacant socket to ensure proper system cooling. The processor/DIMM blank covers the vacant sockets for the DIMMs and the processor.

1. Remove the blade from the enclosure.
2. Open the blade.
3. Remove the cooling shroud.
4. Locate the appropriate memory module socket(s).
5. Press the ejectors on the memory module socket down and out to allow the memory module to be inserted into the socket.

If a memory module blank is installed in the socket, remove it. Retain removed memory-module blank(s) for future use.

 **CAUTION: Handle each memory module only on either card edge, making sure not to touch the middle of the memory module.**

6. Align the memory module's edge connector with the alignment key on the memory module socket, and insert the memory module in the socket.

 **NOTE:** The memory module socket has an alignment key that allows you to install the memory module in the socket in only one way.

7. Press down on the memory module with your thumbs to lock the memory module into the socket.
When the memory module is properly seated in the socket, the ejectors on the memory module socket align with the ejectors on the other sockets that have memory modules installed.
8. Repeat step 5 through step 7 of this procedure to install the remaining memory modules.
9. Install the cooling shroud.
10. Close the blade.
11. Install the blade in the enclosure.
12. (Optional) Press <F2> to enter the System Setup, and check the **System Memory** setting.
The system should have already changed the value to reflect the newly installed memory.
13. If the value is incorrect, one or more of the memory modules may not be installed properly. Check to ensure that the memory modules are firmly seated in their sockets.
14. Run the system memory test in the system diagnostics.

I/O Module Mezzanine Cards

The blade supports a variety of optional mezzanine cards. If installed, the mezzanine card(s) must be used in conjunction with a matching I/O module(s).

For more information on I/O modules, see "Guidelines for Installing I/O Modules" in the *M1000e Enclosure Owner's Manual* at support.dell.com/manuals.

Mezzanine Card Installation Guidelines

The blade supports two mezzanine cards:

- Mezzanine card slot C supports Fabric C. This card must match the fabric type of I/O modules installed in I/O module bays C1 and C2.
- Mezzanine card slot B supports Fabric B. This card must match the fabric type of I/O modules installed in I/O module bays B1 and B2.

The blade supports SFF mezzanine cards. x8 PCIe Gen 3 cards are supported.

Removing A Mezzanine Card

 **CAUTION: Many repairs may only be done by a certified service technician. You should only perform troubleshooting and simple repairs as authorized in your product documentation, or as directed by the online or telephone service and support team. Damage due to servicing that is not authorized by Dell is not covered by your warranty. Read and follow the safety instructions that came with the product.**

1. Remove the blade from the enclosure.
2. Open the blade.
3. Open the mezzanine card latch by pressing the ridged area on the latch with your thumb, and lifting the end of the latch.

 **NOTE:** Hold the mezzanine card by its edges only.

4. Lift the mezzanine card up and away from the system board.
5. Close the retention latch.
6. Close the blade.
7. Install the blade in the enclosure.

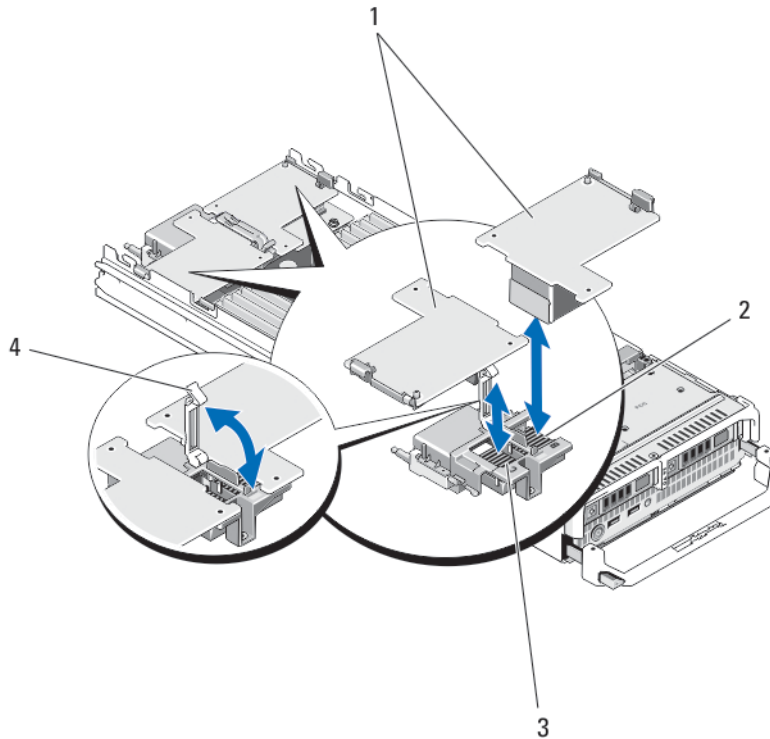



Figure 9. Installing and Removing a Mezzanine Card

1. mezzanine cards (2)
2. Fabric B mezzanine card slot
3. Fabric C mezzanine card slot
4. retention latch

Installing A Mezzanine Card

 **CAUTION:** Many repairs may only be done by a certified service technician. You should only perform troubleshooting and simple repairs as authorized in your product documentation, or as directed by the online or telephone service and support team. Damage due to servicing that is not authorized by Dell is not covered by your warranty. Read and follow the safety instructions that came with the product.

1. Remove the blade from the enclosure.
2. Open the blade.
3. Open the retention latch by pressing the ridged area on the latch with your thumb and lifting the end of the latch.
4. If present, remove the connector cover from the mezzanine card bay.

 **NOTE:** Hold the mezzanine card by its edges only.

5. Mezzanine cards are designed to fit in either card slot. Rotate the card to align the connector on the bottom of the mezzanine card with the corresponding socket on the system board.
6. Lower the card into place until it is fully seated and the plastic clip on the outer edge of the card fits over the side of the blade chassis.
7. Close the retention latch to secure the mezzanine card.
8. Close the blade.
9. Install the blade in the enclosure.

Management Riser Card

The management riser card provides two SD card slots and a USB interface dedicated for the embedded hypervisor. This card offers the following features:

- Internal Dual SD interface — maintains a mirrored configuration using SD cards in both slots and provides redundancy.
- Single card operation — single card operation is supported, but without redundancy.

Replacing The SD Card

 **NOTE:** The SD card in the lower card slot is the primary card (SD1) and the SD card in the upper card slot is the secondary card (SD2).

1. Enter the System Setup and ensure that the **Internal SD Card Port** is enabled.

 **CAUTION:** If the **Internal SD Card Redundancy** option is set to **Mirror Mode** in the **Integrated Devices** screen of the system setup, you must follow the instructions in step 4 through step 6 to avoid loss of data.

 **NOTE:** When an SD card failure occurs, the **Internal SD Card Redundancy** option in the System Setup is set to disabled and the internal dual SD module controller notifies the system. On the next reboot, the system displays a message indicating the failure.

2. Remove the blade from the enclosure.
3. If the **Internal SD Card Redundancy** option is set to **Disabled**, replace the failed SD card with a new SD card.
4. Install the blade in the enclosure.
5. Enter the System Setup and ensure that the **Internal SD Card Port** and **Internal SD Card Redundancy** mode is enabled.
6. Check if the new SD card is functioning properly.
If the problem persists, see [Getting Help](#).

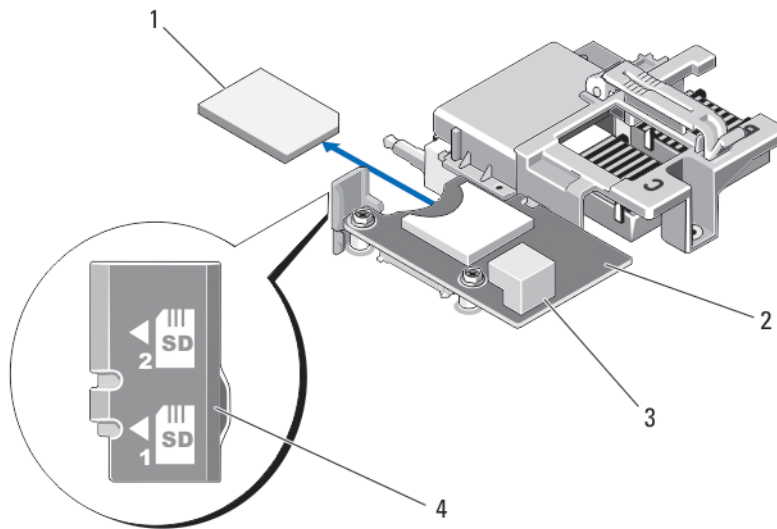

Figure 10. Replacing the SD Card

1. SD card
2. management riser card
3. USB connector
4. SD card slots

Internal USB Key

The blade provides an internal USB connector for a USB flash memory key. The USB memory key can be used as a boot device, security key, or mass storage device. To use the internal USB connector, the **Internal USB Port** option must be enabled in the **Integrated Devices** screen of the System Setup.

To boot from the USB memory key, you must configure the USB memory key with a boot image, and then specify the USB memory key in the boot sequence in the System Setup. For information on creating a bootable file on the USB memory key, see the user documentation that accompanied the USB memory key.

Replacing The Internal USB Key

△ CAUTION: Many repairs may only be done by a certified service technician. You should only perform troubleshooting and simple repairs as authorized in your product documentation, or as directed by the online or telephone service and support team. Damage due to servicing that is not authorized by Dell is not covered by your warranty. Read and follow the safety instructions that came with the product.

△ CAUTION: To avoid interference with other components in the blade, the maximum allowable dimensions of the USB key are 15.9 mm wide x 57.15 mm long x 7.9 mm high.

1. Remove the blade from the enclosure.
2. Open the blade.
3. Locate the USB connector / USB key.
4. If installed, remove the USB key.
5. Insert the new USB memory key into the USB connector.

6. Close the blade.
7. Install the blade in the enclosure.
8. Enter the System Setup and verify that the USB key is detected by the system.

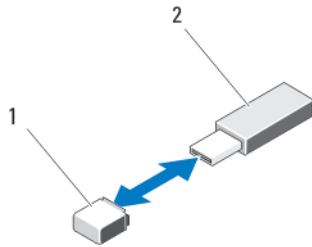



Figure 11. Replacing the USB Memory Key

1. USB memory key connector
2. USB memory key

SD vFlash Card

Replacing The SD vFlash Card

1. Remove the blade from the enclosure.
 2. If installed, remove the SD vFlash card from the card slot.
-  **NOTE:** The SD vFlash card slot is near the Fabric B mezzanine card slot at the back corner of the blade.
3. To install the SD vFlash card, insert the contact-pin end of the SD card into the card slot on the VFlash media unit with the card label side facing up.
-  **NOTE:** The slot is keyed to ensure correct insertion of the card.
4. Press inward on the card to lock it into the slot.
 5. Install the blade in the enclosure.

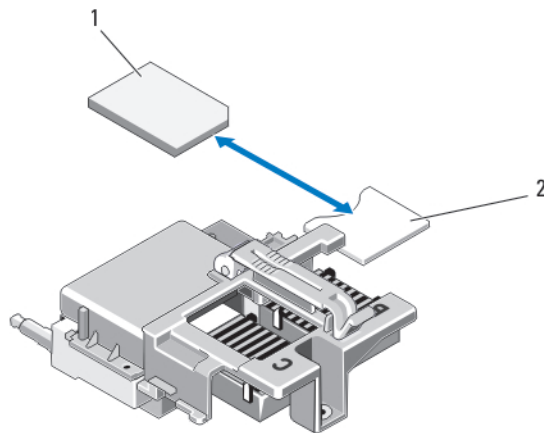

Figure 12. Replacing the SD vFlash Card

1. SD vFlash card

Network Daughter Card/LOM Riser Card

Removing The Network Daughter Card/LOM Riser Card

⚠ CAUTION: Many repairs may only be done by a certified service technician. You should only perform troubleshooting and simple repairs as authorized in your product documentation, or as directed by the online or telephone service and support team. Damage due to servicing that is not authorized by Dell is not covered by your warranty. Read and follow the safety instructions that came with the product.

1. Remove the blade from the enclosure.
2. Open the blade.
3. Remove the two screws that secure the Network Daughter Card/LOM riser card to the system board.
4. Lift the card from the system board.
5. Close the blade.
6. Install the blade in the enclosure.

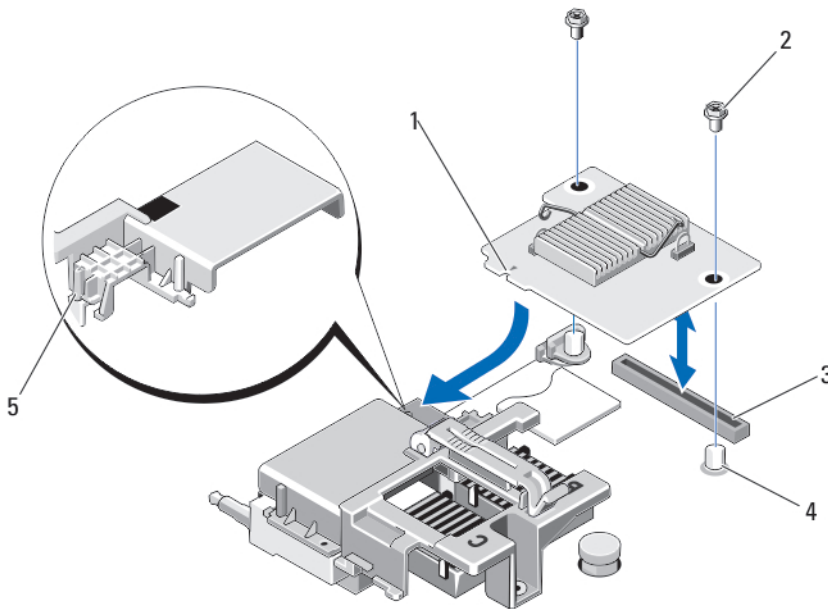



Figure 13. Removing and Installing the Network Daughter Card/LOM Riser Card

1. LOM riser card
2. screws (2)
3. LOM riser card connector
4. standoffs (2)
5. tab projections (on the plastic bracket covering the mezzanine card connectors)

Installing The Network Daughter Card/LOM Riser Card

 **CAUTION:** Many repairs may only be done by a certified service technician. You should only perform troubleshooting and simple repairs as authorized in your product documentation, or as directed by the online or telephone service and support team. Damage due to servicing that is not authorized by Dell is not covered by your warranty. Read and follow the safety instructions that came with the product.

1. Remove the blade from the enclosure.
2. Open the blade.
3. Install the Network Daughter Card/LOM riser card:
 - a) Align the slots on the card edge with the projection tabs on the plastic bracket covering the mezzanine card slots.
 - b) Lower the card into place until the card connector fits into the corresponding connector on the system board.
 - c) Secure the card with the two screws.
4. Close the blade.
5. Install the blade in the enclosure.

Processors

- Your system supports up to two Intel Xeon processor E5-2600 product family.
- Single-processor configuration is supported.
- Use 57 mm heat sinks for processors up to 95 W and 77 mm heat sinks with 115 W/130 W processors.
- Do not mix processors of different Wattages.

Use the following procedure when:

- Installing an additional processor
- Replacing a processor

Removing A Processor

 **CAUTION:** Many repairs may only be done by a certified service technician. You should only perform troubleshooting and simple repairs as authorized in your product documentation, or as directed by the online or telephone service and support team. Damage due to servicing that is not authorized by Dell is not covered by your warranty. Read and follow the safety instructions that came with the product.

1. Remove the blade from the enclosure.
2. Open the blade.

 **WARNING:** The processor and heat sink can become extremely hot. Be sure the processor has had sufficient time to cool before handling.

3. Remove the cooling shroud.

 **CAUTION:** Never remove the heat sink from a processor unless you intend to remove the processor. The heat sink is necessary to maintain proper thermal conditions.

4. Loosen the screws that secure the heat sink to the blade system board.
5. Remove the heat sink.
Set the heat sink upside down on the work surface to avoid contaminating the thermal grease.

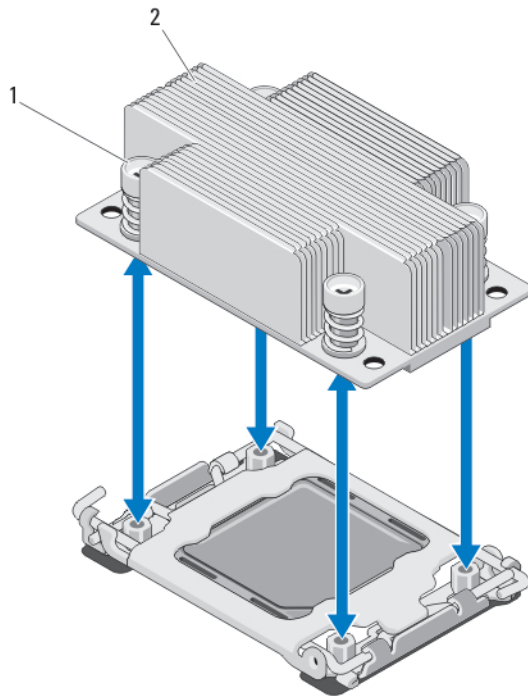

Figure 14. Installing and Removing a Heat Sink

1. screws (4)
2. heat sink

6. Use a clean, lint-free cloth to remove any thermal grease from the surface of the processor shield.

⚠ CAUTION: The processor is held in its socket under strong pressure. Be aware that the release lever can spring up suddenly if not firmly grasped.

7. Position your thumb firmly over the socket-release lever near the label marked OPEN 1st and release the lever from the locked position by pushing down and out from under the tab.
8. Similarly, release the socket-release lever near the label marked CLOSE 1st from the locked position. Rotate the lever 90 degrees upward.

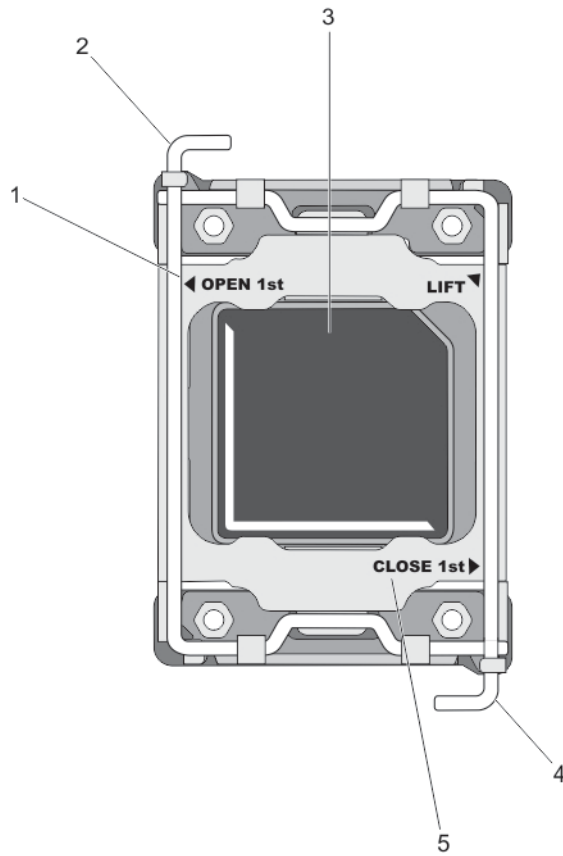





Figure 15. Processor Shield Opening and Closing Lever Sequence

1. OPEN 1st label
 2. open first lever
 3. processor
 4. close first lever
 5. CLOSE 1st label
9. Hold the tab on the processor shield and rotate it upward and out of the way.
 10. If applicable, remove the socket protective cap from the processor shield. To remove the socket protective cap, push the cap from the inside of the processor shield and move it away from the socket pins.
 -  **NOTE:** It is recommended that you install/remove the socket protective cap from the processor shield with the processor shield in the open position.
 -  **CAUTION:** The socket pins are fragile and can be permanently damaged. Be careful not to bend the pins in the socket when removing the processor out of the socket.
 11. Lift the processor out of the socket and leave the release lever up so that the socket is ready for the new processor.
 -  **CAUTION:** If you are permanently removing a processor, you must install a socket protective cap and a processor/DIMM blank in the vacant socket to ensure proper system cooling. The processor/DIMM blank covers the vacant sockets for the DIMMs and the processor.

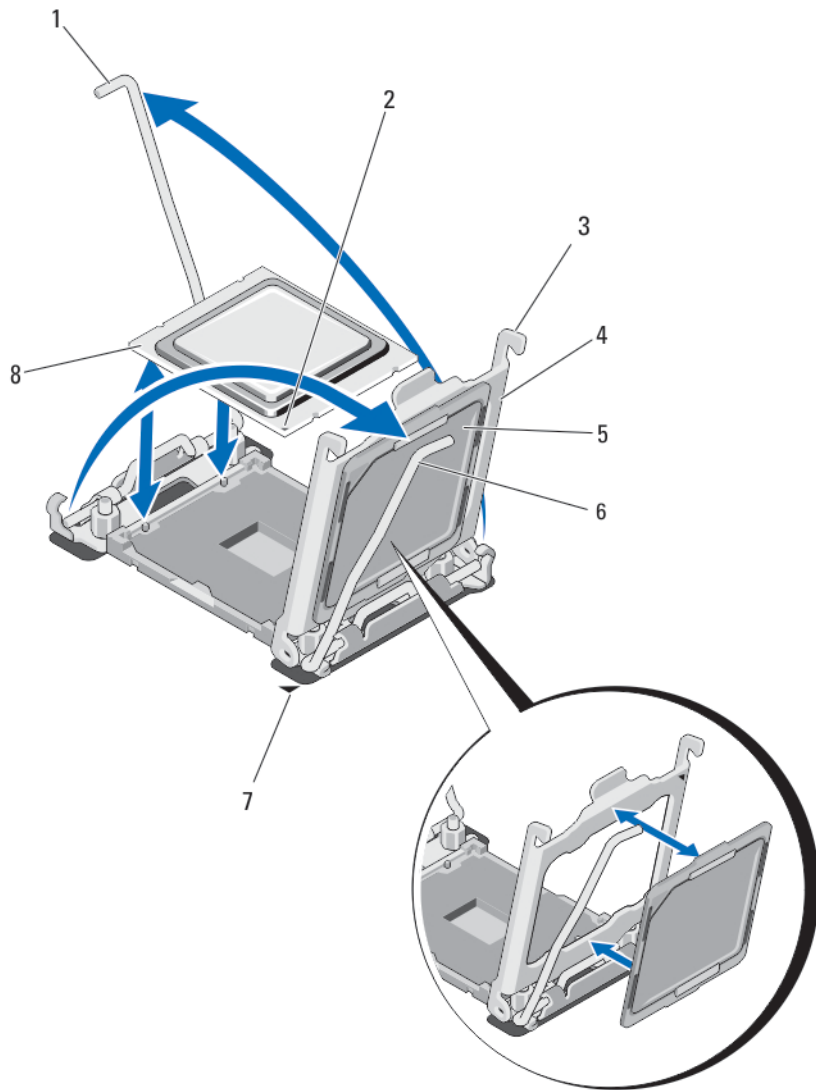



Figure 16. Installing and Removing a Processor

- | | |
|------------------------------|---------------------------------|
| 1. socket-release lever 2 | 6. socket-release lever 1 |
| 2. pin-1 corner of processor | 7. pin-1 corner on system board |
| 3. tabs (2) | 8. processor |
| 4. processor shield | |
| 5. socket protective cap | |

Installing A Processor

 **CAUTION:** Many repairs may only be done by a certified service technician. You should only perform troubleshooting and simple repairs as authorized in your product documentation, or as directed by the online or telephone service and support team. Damage due to servicing that is not authorized by Dell is not covered by your warranty. Read and follow the safety instructions that came with the product.

 **NOTE:** If you are installing just one processor, it must be installed in socket CPU1.

1. If applicable, remove the heat-sink blank.
2. Unlatch and rotate the socket-release levers 90 degrees upward and ensure that the socket-release lever is fully open.
3. Hold the tab near the label marked LIFT on the processor shield and rotate it upward and out of the way.
4. If applicable, remove the socket protective cap from the processor shield. To remove the socket protective cap, push the cap from the inside of the processor shield and move it away from the socket pins.

 **NOTE:** It is recommended that you install/remove the socket protective cap from the processor shield with the processor shield in the open position.

 **CAUTION:** Positioning the processor incorrectly can permanently damage the system board or the processor. Be careful not to bend the pins in the socket.

 **CAUTION:** Do not use force to seat the processor. When the processor is positioned correctly, it engages easily into the socket.

5. Install the processor in the socket:
 - a) Identify the pin-1 corner of the processor by locating the tiny gold triangle on one corner of the processor. Place this corner in the same corner of the ZIF socket identified by a corresponding triangle on the system board.
 - b) Align the pin-1 corner of the processor with the pin-1 corner of the system board.
 - c) Set the processor lightly in the socket.

Because the system uses a ZIF processor socket, do not use force. When the processor is positioned correctly, it drops down into the socket with minimal pressure.
 - d) Close the processor shield.
 - e) Rotate the socket-release lever near the label marked CLOSE 1st until it is locked in position.
 - f) Similarly, rotate the socket-release lever near the label marked OPEN 1st to the locked position.

 **CAUTION:** Applying too much thermal grease can result in excess grease coming in contact with and contaminating the processor socket.

6. Install the heat sink:

If you are:

Reinstalling a heat sink Use a clean, lint-free cloth to remove the existing thermal grease from the heat sink.

Upgrading a processor If a new heat sink was supplied with the processor, install it.

Reinstalling a processor Clean any remnants of thermal grease from the processor.

- a) Open the grease applicator included with your processor kit and apply all of the thermal grease in the applicator to the center of the topside of the new processor.
- b) Place the heat sink onto the processor.
- c) Tighten the four screws to secure the heat sink to the blade board.

 **NOTE:** Do not over-tighten the heat sink retention screws when installing the heat sink. To prevent over-tightening, tighten the retention screw until resistance is felt, and stop once the screw is seated. The screw tension should be no more than 6 in-lb (6.9 kg-cm).

7. Install the cooling shroud.

8. Close the blade.

9. Install the blade in the enclosure.

As the system boots, it detects the presence of the new processor and automatically changes the system configuration information in the System Setup.

10. Press <F2> to enter the System Setup and check that the processor information matches the new system configuration.

11. Run the system diagnostics to verify that the new processor operates correctly.

12. Update the system BIOS.

Hard Drives/SSDs

- The system supports up to two 2.5 inch SAS/SATA/PCIe SSDs or SAS/SATA hard drives.
- All drives connect to the blade system board through the hard-drive/SSD backplane board.
- Hard drives/SSDs are supplied in special hot-swappable drive carriers that fit in the drive bays.
- SAS/SATA/PCIe SSDs or SAS/SATA hard drives cannot be mixed within a blade.

Hard Drive/SSD Installation Guidelines

For a single-drive configuration, a hard-drive blank must be installed in the other drive bay to maintain proper cooling airflow.

Removing A Hard Drive/SSD

 **NOTE:** Not all operating systems support hot-swappable drive installation. See the documentation supplied with your operating system.

1. Take the hard drive/SSD offline and wait until the hard-drive/SSD indicator codes on the drive carrier signal that the drive may be removed safely.

When all indicators are off, the drive is ready for removal.

See your operating system documentation for more information on taking the drive offline.

2. Open the hard-drive/SSD carrier handle to release the drive.

3. Slide the hard drive/SSD out until it is free of the drive bay.

If you are permanently removing the hard drive/SSD, install a blank insert.

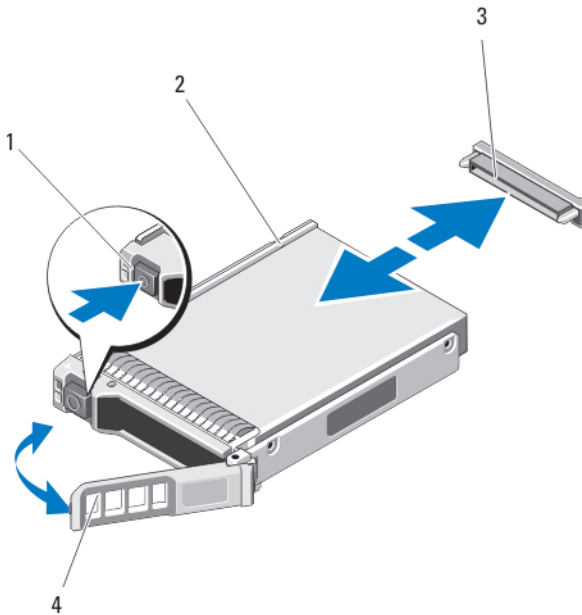

Figure 17. Removing and Installing a Hard Drive/SSD

1. release button
2. hard drive/SSD
3. hard-drive/SSD connector (on backplane)
4. hard-drive/SSD carrier handle

Installing A Hard Drive/SSD

CAUTION: When a replacement hot-swappable hard drive/SSD is installed and the blade is powered on, the drive automatically begins to rebuild. Make absolutely sure that the replacement hard drive/SSD is blank or contains data that you wish to have over-written. Any data on the replacement hard drive/SSD is immediately lost after the drive is installed.

NOTE: Not all operating systems support hot-swappable drive installation. See the documentation supplied with your operating system.

1. Open the hard-drive/SSD carrier handle.
2. Insert the hard-drive/SSD carrier into the drive bay. Carefully align the channel on the hard-drive/SSD carrier with the appropriate drive slot on the blade.
3. Push the drive carrier into the slot until the handle makes contact with the blade.
4. Rotate the carrier handle to the closed position while pushing the carrier into the slot until it locks into place.
The status LED indicator displays a steady green light if the drive is installed correctly. The drive carrier LED green indicator flashes as the drive rebuilds.

Shutdown Procedure For Servicing a Hard Drive/SSD

NOTE: This section applies only to situations where the blade must be powered down to service a hard drive/SSD. In many situations, the hard drive/SSD can be serviced while the blade is powered on.

CAUTION: If you need to power off the blade to service a hard drive/SSD, wait 30 seconds after the blade's power indicator turns off before removing the hard drive/SSD. Otherwise, the hard drive/SSD may not be recognized after it is reinstalled and the blade is powered on again.

Configuring The Boot Drive

The drive or device from which the system boots is determined by the boot order specified in the System Setup.

Removing A Hard Drive/SSD From A Hard-Drive/SSD Carrier

1. Remove the four screws from the slide rails on the hard-drive/SSD carrier.
2. Lift the hard drive/SSD out of the hard-drive/SSD carrier.

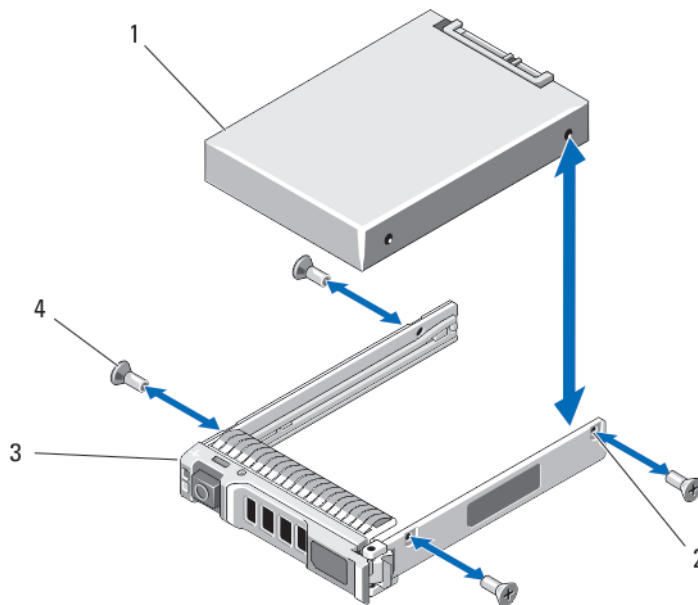

Figure 18. Removing and Installing a Hard Drive/SSD in a Hard-Drive/SSD Carrier

1. hard drive/SSD
2. screw holes (4)
3. hard-drive/SSD carrier
4. screws (4)

Installing A Hard Drive/SSD In A Hard-Drive/SSD Carrier

1. Insert the hard drive/SSD into the hard-drive/SSD carrier with the drive's controller board's connector end of the drive at the back of the carrier.
2. From the back of the carrier, slide the drive into the carrier.
3. Align the screw holes on the hard drive/SSD with the holes on the hard-drive/SSD carrier.

CAUTION: To avoid damaging the drive or the carrier, do not overtighten the screws.

4. Attach the four screws to secure the hard drive/SSD to the hard-drive/SSD carrier.

Hard-Drive/SSD Backplane

Removing The Hard-Drive/SSD Backplane

CAUTION: Many repairs may only be done by a certified service technician. You should only perform troubleshooting and simple repairs as authorized in your product documentation, or as directed by the online or telephone service and support team. Damage due to servicing that is not authorized by Dell is not covered by your warranty. Read and follow the safety instructions that came with the product.

1. Remove the blade from the enclosure.
2. Open the blade.

CAUTION: You must note the number of each hard drive/SSD and temporarily label them before removal so that you can replace them in the same locations.

CAUTION: To prevent damage to the hard drives/SSDs and the hard-drive/SSD backplane, you must remove the hard drives/SSDs from the blade before removing the hard-drive/SSD backplane.

3. Remove the hard drive(s)/SSD(s).
4. Hold both edges of the hard-drive/SSD backplane near the blade chassis and lift the backplane away from the blade.

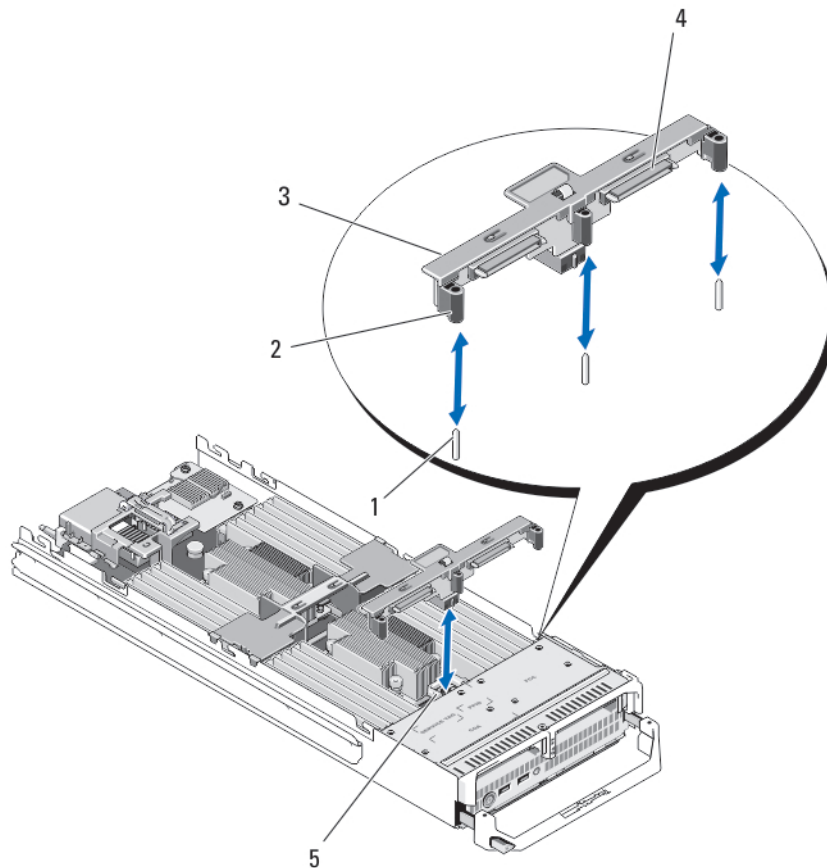

Figure 19. Removing and Installing the Hard-Drive/SSD Backplane

1. guide pins (3)
2. guides (3)
3. hard-drive/SSD backplane
4. hard-drive/SSD connectors (2)
5. hard-drive backplane/SSD connector

Installing The Hard-Drive/SSD Backplane

1. Open the blade.
2. Align the guides on the hard-drive/SSD backplane with the guide pins on the system board.
3. Press down the backplane until the connectors on the backplane and the system board are fully engaged.
4. Install the hard drives/SSDs in their original locations.
5. Close the blade.
6. Install the blade in the enclosure.

System Board

Removing The System Board

 **CAUTION:** Many repairs may only be done by a certified service technician. You should only perform troubleshooting and simple repairs as authorized in your product documentation, or as directed by the online or telephone service and support team. Damage due to servicing that is not authorized by Dell is not covered by your warranty. Read and follow the safety instructions that came with the product.

1. Remove the blade from the enclosure.
2. Open the blade.
3. Install an I/O connector cover on the I/O connector(s) at the back of the board.

 **WARNING:** The processor and heat sink can become extremely hot. Be sure the processor has had sufficient time to cool before handling.

 **WARNING:** The memory modules are hot to the touch for some time after the system has been powered down. Allow time for the memory modules to cool before handling them. Handle the memory modules by the card edges and avoid touching the components.

 **NOTE:** If you are removing more than one hard drive/SSD, label them so you can replace them in their original locations.

4. Remove the hard drives/SSDs.
5. Remove the hard-drive/SSD backplane.
6. Remove the cooling shroud.
7. Remove both mezzanine cards, if present.

 **CAUTION:** Do not lift the system board assembly by grasping a memory module, processor, or other components.

8. Hold the blade chassis with one hand, lift and pull the system board retention latch with the other hand, and then slide the system board out of the open end of the chassis.
9. Ensure that the I/O connector cover is still in place on the I/O connector at the back of the board.
10. Remove the memory modules and memory module blanks.
11. Remove the processor(s).

12. Remove the storage controller card/PCIe extender card.

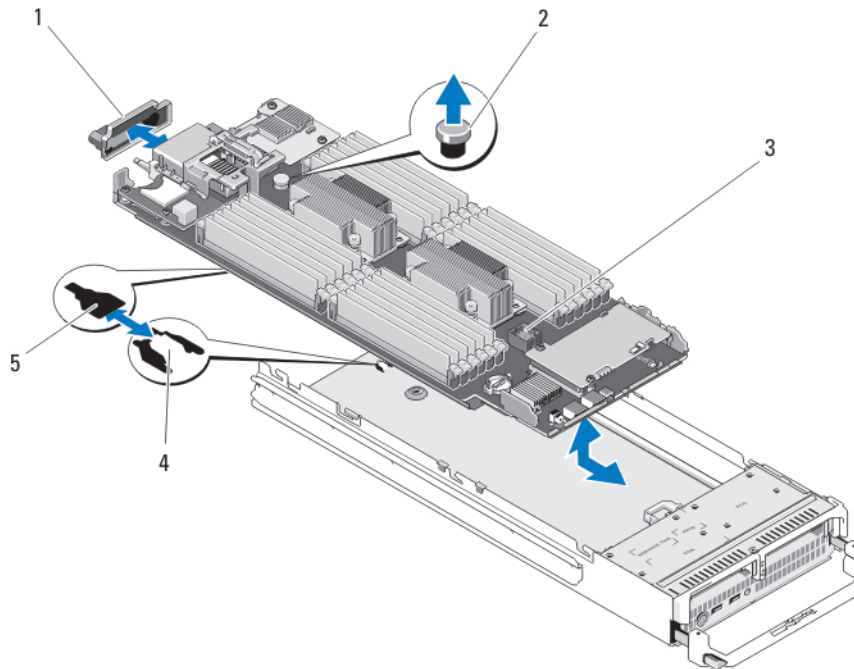

Figure 20. Removing and Installing the System Board

1. I/O connector cover
2. retention latch
3. system board
4. tabs on system chassis
5. slots in system board tray

Installing The System Board

1. Transfer the following components to the new system board:
 - Internal USB key
 - storage controller card/PCIe extender card
 - SD vFlash card
 - Memory modules and memory module blanks
 - Processor(s) and heat sink(s), or processor filler blank
 - network daughter card
2. Slide the new system board into the open end of the blade chassis until the retention latch or retention pin engages.

NOTE: Ensure that the system board plate is parallel with the chassis.

When the board assembly is installed correctly, the tabs on the system board pan fit into the corresponding openings in the floor of the blade chassis.

3. Replace the mezzanine card(s) in their original locations.
4. Reinstall the hard-drive/SSD backplane.

5. Replace the hard drive(s)/SSDs.
Ensure that you reinstall the hard drives/SSDs in their original locations.
6. Reinstall the cooling shroud.
7. Close the blade.
8. Remove the plastic I/O connector covers from the back of the blade.
9. Install the blade in the enclosure.
10. Import your new or existing iDRAC Enterprise license. For more information, see the *iDRAC7 User's Guide* at support.dell.com/manuals.

NVRAM Backup Battery

Replacing The NVRAM Backup Battery

 **WARNING:** There is a danger of a new battery exploding if it is incorrectly installed. Replace the battery only with the same or equivalent type recommended by the manufacturer. Discard used batteries according to the manufacturer's instructions. See the safety instructions that came with your system for additional information.

 **CAUTION:** Many repairs may only be done by a certified service technician. You should only perform troubleshooting and simple repairs as authorized in your product documentation, or as directed by the online or telephone service and support team. Damage due to servicing that is not authorized by Dell is not covered by your warranty. Read and follow the safety instructions that came with the product.

1. Remove the blade from the enclosure.
2. Open the blade.
3. Remove the system board to access the battery.
4. To remove the battery, press down firmly on the positive side of the connector and lift the battery out of the securing tabs at the negative side of the connector.
5. To install a new system battery:
 - a) Support the battery connector by pressing down firmly on the positive side of the connector.
 - b) Hold the battery with the "+" facing up and slide it under the securing tabs at the positive side of the connector.
6. Press the battery straight down into the connector until it snaps into place.
7. Reinstall the system board.
8. Close the blade.
9. Install the blade in the enclosure.
10. Enter the System Setup to confirm that the battery is operating properly.
11. Enter the correct time and date in the System Setup's **Time** and **Date** fields.
12. Exit the System Setup.
13. To test the newly installed battery, remove the blade for at least an hour.
14. After an hour, reinstall the blade.
15. Enter the System Setup and if the time and date are still incorrect, see [Getting Help](#).

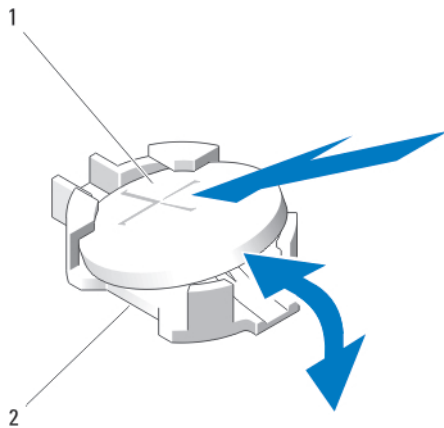



Figure 21. Replacing the NVRAM Backup Battery

1. positive side of battery
2. negative side of battery connector

Storage Controller Card

Your system includes a dedicated expansion-card slot on the blade system board for the storage controller card that provides the integrated storage subsystem for your system's hard drives. The storage controller card supports SAS and SATA hard drives.

 **NOTE:** The storage controller card is located underneath the drive bays.

Removing The PCIe Extender Card/Storage Controller Card

 **CAUTION:** Many repairs may only be done by a certified service technician. You should only perform troubleshooting and simple repairs as authorized in your product documentation, or as directed by the online or telephone service and support team. Damage due to servicing that is not authorized by Dell is not covered by your warranty. Read and follow the safety instructions that came with the product.

1. Remove the blade from the enclosure.
2. Open the blade.
3. Remove the system board and place it on the work surface.
4. Remove the two screws from the PCIe extender/storage controller card.
5. Pull the PCIe extender/storage controller card straight up and out of the connector.

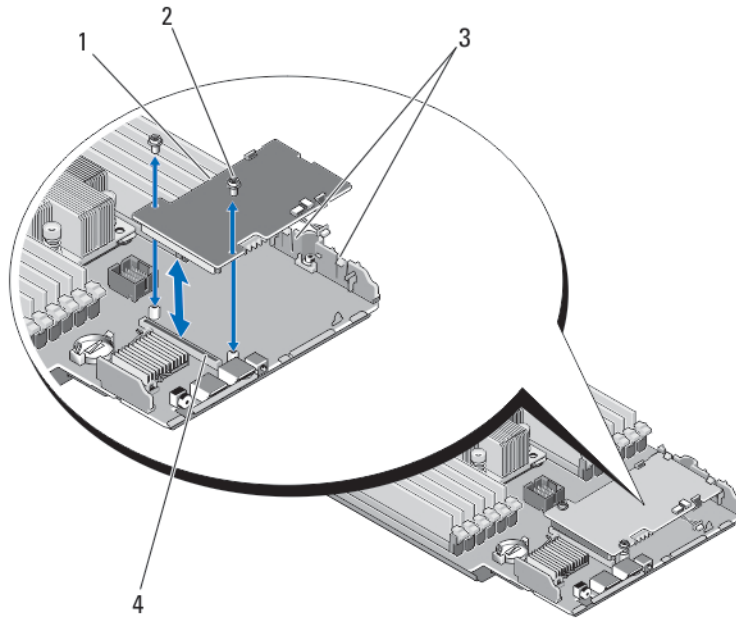

Figure 22. Removing and Installing the PCIe Extender/Storage Controller Card

1. PCIe extender/storage controller card
2. screws (2)
3. tab
4. connector

Installing The PCIe Extender Card/Storage Controller Card

1. Holding by its edges, position the PCIe extender/storage controller card so that the card-connector aligns with the system board connector.
2. Adjust the other end of the card so that the card edge is secured under the two tabs on the plastic bracket.
3. Insert the controller card-connector firmly into the system board connector until the card is fully seated.
4. Install the two screws to secure the PCIe extender/storage controller card to the system board.
5. Reinstall the system board.
6. Install the blade in the enclosure.

Troubleshooting Your System

Safety First—For You and Your System

 **CAUTION:** Many repairs may only be done by a certified service technician. You should only perform troubleshooting and simple repairs as authorized in your product documentation, or as directed by the online or telephone service and support team. Damage due to servicing that is not authorized by Dell is not covered by your warranty. Read and follow the safety instructions that came with the product.

 **NOTE:** For troubleshooting information on the M1000e enclosure components, see “Troubleshooting The Enclosure” in the *Dell PowerEdge M1000e Enclosure Owner’s Manual* at support.dell.com/manuals.

Troubleshooting System Memory

 **CAUTION:** Many repairs may only be done by a certified service technician. You should only perform troubleshooting and simple repairs as authorized in your product documentation, or as directed by the online or telephone service and support team. Damage due to servicing that is not authorized by Dell is not covered by your warranty. Read and follow the safety instructions that came with the product.

 **NOTE:** Before performing the following procedure, ensure that you have installed the memory modules according to the memory installation guidelines for the blade.

1. Restart the blade:
 - a) Press the power button once to turn off the blade
 - b) Press the power button again to apply power to the blade.If no error messages appear, go to step 8.
2. Enter the System Setup and check the system memory setting.
If the amount of memory installed matches the system memory setting, go to step 8.
3. Remove the blade from the enclosure.
4. Open the blade.

 **CAUTION:** The memory modules are hot to touch for some time after the blade has been powered down. Allow time for the memory modules to cool before handling them. Handle the memory modules by the card edges and avoid touching the components.

5. Reseat the memory modules in their sockets.
6. Close the blade.
7. Install the blade in the enclosure.
8. Run the appropriate diagnostic test. For more information, see Using System Diagnostics.
If the test fails, see [Getting Help](#).

Troubleshooting Hard Drives

 **CAUTION:** Many repairs may only be done by a certified service technician. You should only perform troubleshooting and simple repairs as authorized in your product documentation, or as directed by the online or telephone service and support team. Damage due to servicing that is not authorized by Dell is not covered by your warranty. Read and follow the safety instructions that came with the product.

 **CAUTION:** This troubleshooting procedure can destroy data stored on the hard drive. Before you proceed, back up all the files on the hard drive, if possible.

1. Run the appropriate controllers test and the hard drive tests in system diagnostics.
If the tests fail, go to step 3.
2. Take the hard drive offline and wait until the hard-drive indicator codes on the drive carrier signal that the drive may be removed safely, then remove and reseal the drive carrier in the blade.
3. Restart the blade, enter the System Setup and confirm that the drive controller is enabled.
4. Ensure that any required device drivers are installed and are configured correctly.

 **NOTE:** Installing a hard drive into another bay may break the mirror if the mirror state is optimal.

5. Remove the hard drive and install it in the other drive bay.
6. If the problem is resolved, reinstall the hard drive in the original bay.
If the hard drive functions properly in the original bay, the drive carrier could have intermittent problems. Replace the drive carrier.
7. If the hard drive is the boot drive, ensure that the drive is configured and connected properly.
8. Partition and logically format the hard drive.
9. If possible, restore the files to the drive.
If the problem persists, see [Getting Help](#).

Troubleshooting USB Devices

 **CAUTION:** Many repairs may only be done by a certified service technician. You should only perform troubleshooting and simple repairs as authorized in your product documentation, or as directed by the online or telephone service and support team. Damage due to servicing that is not authorized by Dell is not covered by your warranty. Read and follow the safety instructions that came with the product.

1. Ensure that the blade is turned on.
2. Check the USB device connection to the blade.
3. Swap the USB device with a known-working USB device.
4. Connect the USB devices to the blade using a powered USB hub.
5. If another blade is installed, connect the USB device to that blade. If the USB device works with a different blade, the first blade may be faulty. See [Getting Help](#).

Troubleshooting An Internal SD Card

 **CAUTION:** Many repairs may only be done by a certified service technician. You should only perform troubleshooting and simple repairs as authorized in your product documentation, or as directed by the online or telephone service and support team. Damage due to servicing that is not authorized by Dell is not covered by your warranty. Read and follow the safety instructions that came with the product.

1. Enter the System Setup and ensure that the **Internal SD Card Port** is enabled.
2. Note the **Internal SD Card Redundancy** option enabled in the **Integrated Devices** screen of the System Setup (Mirror or Disabled).
3. Remove the blade from the enclosure.
4. If the **Internal SD Card Redundancy** option in the **Integrated Devices** screen of the System Setup is set to Mirror mode and SD card 1 has failed:
 - a) Remove the SD card from SD card slot 1.
 - b) Remove the SD card present in SD card slot 2 and insert it into SD card slot 1.
 - c) Install a new SD card in slot 2.
5. If the **Internal SD Card Redundancy** option in the **Integrated Devices** screen of the System Setup is set to Mirror mode and SD card 2 has failed, insert the new SD card into SD card slot 2.
6. If the **Internal SD Card Redundancy** option in **Integrated Devices** screen of the System Setup is set to Disabled, replace the failed SD card with a new SD card.
7. Install the blade in the enclosure.
8. Enter the System Setup and ensure that the **Internal SD Card Port** option is enabled and **Internal SD Card Redundancy** option is set to Mirror mode.
9. Check if the SD card is functioning properly.
If the problem persists, see [Getting Help](#).

Troubleshooting Processors

1. Remove the blade from the enclosure.
2. Open the blade.
3. Ensure that the processor(s) and heat sink(s) are properly installed.
4. If your system only has one processor installed, ensure that it is installed in the primary processor socket (CPU1).
5. Close the blade.
6. Install the blade in the enclosure.
7. Run the appropriate diagnostic test. For more information, see Using System Diagnostics.
If the problem persists, see [Getting Help](#).

Troubleshooting The Blade System Board

 **CAUTION:** Many repairs may only be done by a certified service technician. You should only perform troubleshooting and simple repairs as authorized in your product documentation, or as directed by the online or telephone service and support team. Damage due to servicing that is not authorized by Dell is not covered by your warranty. Read and follow the safety instructions that came with the product.

1. Remove the blade from the enclosure.
2. Open the blade.
3. Clear the blade NVRAM.
4. If there is a still a problem with the blade, remove and reinstall the blade in the enclosure.
5. Turn on the blade.
6. Run the appropriate diagnostic test. For more information, see Using System Diagnostics.
If the tests fail, see [Getting Help](#).

Troubleshooting The NVRAM Backup Battery

 **CAUTION:** Many repairs may only be done by a certified service technician. You should only perform troubleshooting and simple repairs as authorized in your product documentation, or as directed by the online or telephone service and support team. Damage due to servicing that is not authorized by Dell is not covered by your warranty. Read and follow the safety instructions that came with the product.

The battery maintains the blade configuration, date, and time information in the NVRAM when the blade is turned off. You may need to replace the battery if an incorrect time or date is displayed during the boot routine.

You can operate the blade without a battery; however, the blade configuration information maintained by the battery in NVRAM is erased each time you remove power from the blade. Therefore, you must re-enter the system configuration information and reset the options each time the blade boots until you replace the battery.

1. Re-enter the time and date through the System Setup.
2. Remove the blade from the enclosure for at least one hour.
3. Install the blade in the enclosure.
4. Enter the System Setup.

If the date and time are not correct in the System Setup, replace the battery. If the problem is not resolved by replacing the battery, see [Getting Help](#).

 **NOTE:** If the blade is turned off for long periods of time (for weeks or months), the NVRAM may lose its system configuration information. This situation is caused by a defective battery.

 **NOTE:** Some software may cause the blade's time to speed up or slow down. If the blade operates normally except for the time maintained by the System Setup, the problem may be caused by a software rather than by a defective battery.

Using System Diagnostics

If you experience a problem with your system, run the system diagnostics before contacting Dell for technical assistance. The purpose of running system diagnostics is to test your system hardware without requiring additional equipment or risking data loss. If you are unable to fix the problem yourself, service and support personnel can use the diagnostics results to help you solve the problem.

Dell Online Diagnostics

Dell Online Diagnostics, a stand-alone suite of diagnostic programs or test modules, allows you to run diagnostic tests on the systems in a production environment, and helps you ensure maximum uptime of your systems. Online Diagnostics allows you to run diagnostic tests on chassis and storage components such as hard drives, physical memory, and network interface cards (NICs). You can use the graphical user interface (GUI) or the command line interface (CLI) to run diagnostic tests on the hardware that Online Diagnostics discovers on your system. For information about using diagnostics, see the *Dell Online PowerEdge Diagnostics User's Guide* under **Software** → **Serviceability Tools**, at support.dell.com/manuals.

Dell Embedded System Diagnostics

 **NOTE:** Also known as Enhanced Pre-boot System Assessment (ePSA) diagnostics.

The embedded system diagnostics provides a set of options for particular device groups or devices allowing you to:

- Run tests automatically or in an interactive mode
- Repeat tests
- Display or save test results
- Run thorough tests to introduce additional test options to provide extra information about the failed device(s)
- View status messages that inform you if tests are completed successfully
- View error messages that inform you of problems encountered during testing

When To Use The Embedded System Diagnostics

If a major component or device in the system does not operate properly, running the embedded system diagnostics may indicate component failure.

Running The Embedded System Diagnostics

The embedded system diagnostics program is run from the Dell Lifecycle Controller.

 **CAUTION:** Use the embedded system diagnostics to test only your system. Using this program with other systems may cause invalid results or error messages.

1. As the system boots, press <F11>.
2. Use the up and down arrow keys to select **System Utilities** → **Launch Dell Diagnostics**.

The **ePSA Pre-boot System Assessment** window is displayed, listing all devices detected in the system. The diagnostics starts executing the tests on all the detected devices.

Running Embedded System Diagnostics From An External Media

1. Format the external resource media (USB flash drive or CDRROM) to emulate a hard drive.
See the documentation that came with the resource media for instructions.
2. Configure the resource media to be a bootable device.
3. Create a directory for the system diagnostics on the resource media.
4. Copy the system diagnostics files into the directory.
To download the Dell diagnostics utility, go to **support.dell.com**.
5. Connect the resource media on your system.
6. As the system boots, press <F11>.
7. When prompted, select the media to perform a one-time boot.
If diagnostics does not start automatically after the diagnostic media is booted, enter **psa** at the command prompt.

System Diagnostic Controls

| Menu | Description |
|----------------------|---|
| Configuration | Displays the configuration and status information of all detected devices. |
| Results | Displays the results of all tests that are executed. |
| System Health | Provides the current overview of the system performance. |
| Event Log | Displays a time-stamped log of the results of all tests run on the system. This is displayed if at least one event description is recorded. |

For information about embedded system diagnostics, see the *Dell Enhanced Pre-boot System Assessment User Guide* at **support.dell.com/manuals**.





Jumpers And Connectors

System Board Jumper Settings

△ CAUTION: Many repairs may only be done by a certified service technician. You should only perform troubleshooting and simple repairs as authorized in your product documentation, or as directed by the online or telephone service and support team. Damage due to servicing that is not authorized by Dell is not covered by your warranty. Read and follow the safety instructions that came with the product.

For information on resetting the password jumper to disable a password, see [Disabling A Forgotten Password](#).

Table 3. System Board Jumper Settings

| Jumper | Setting | Description |
|-----------|---|---|
| PWRD_EN |  (default) | The password feature is enabled. |
| |  | The password feature is disabled. |
| NVRAM_CLR |  (default) | The configuration settings are retained at system boot. |
| |  | The configuration settings are cleared at the next system boot. (If the configuration settings become corrupted to the point where the system does not boot, install the jumper and boot the system. Remove the jumper before restoring the configuration information.) |

System Board Connectors

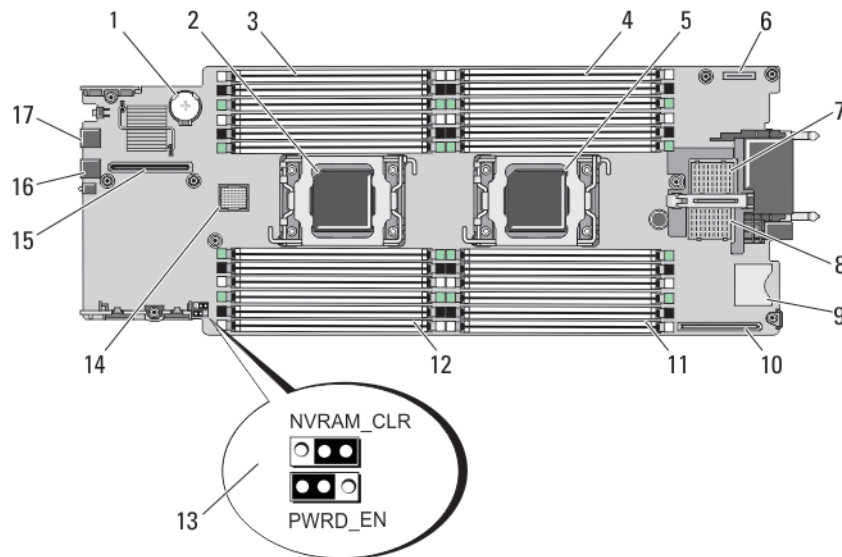



Figure 23. System Board Connectors

Table 4. System Board Connectors

| Item | Connector | Description |
|------|---|---|
| 1 | BATTERY | Connector for the 3.0 V coin cell battery |
| 2 | CPU2 | Processor socket 2 |
| 3 | B3, B7, B11, B4, B8, B12 | Memory module sockets (for processor 2) |
| 4 | A1, A5, A9, A2, A6, A10 | Memory module sockets (for processor 1) |
| 5 | CPU1 | Processor socket 1 |
| 6 | MANAGEMENT RISER | Management riser card connector |
| 7 | MEZZ1_FAB_C | Mezzanine card connector for Fabric C |
| 8 | MEZZ2_FAB_B | Mezzanine card connector for Fabric B |
| 9 | vFLASH | SD vFlash card connector |
| 10 | NETWORK DAUGHTER CARD | Network daughter card connector |
| 11 | A3, A7, A11, A4, A8, A12 | Memory module sockets (for processor 1) |
| 12 | B1, B5, B9, B2, B6, B10 | Memory module sockets (for processor 2) |
| 13 | PWRD_EN, NVRAM_CLR | System configuration jumpers |
| |  NOTE: Access requires removal of system board. | |
| 14 | HD_BP | Hard-drive/SSD backplane connector |

| Item | Connector | Description |
|------|-----------|--|
| 15 | STORAGE | PCIe extender card/storage controller card connector |
| 16 | USB2 | USB connector |
| 17 | USB1 | USB connector |

Disabling A Forgotten Password

The blade's software security features include a system password and a setup password. The password jumper enables these password features or disables them, and clears any password(s) currently in use.



CAUTION: Many repairs may only be done by a certified service technician. You should only perform troubleshooting and simple repairs as authorized in your product documentation, or as directed by the online or telephone service and support team. Damage due to servicing that is not authorized by Dell is not covered by your warranty. Read and follow the safety instructions that came with the product.

1. Remove the blade from the enclosure.
2. Open the blade.
3. Remove the system board to gain access to the jumpers.
4. Relocate the jumper plug to disable the password feature.
5. Reinstall the system board.
6. Close the blade.
7. Install the blade in the enclosure.

When the blade is on, the power-on indicator is solid green. Allow the blade to finish booting.

The existing passwords are not disabled (erased) until the system boots with the password removed. However, before you assign a new system and/or setup password, you must reinstall the password jumper.



NOTE: If you assign a new system and/or setup password with the jumper removed, the system disables the new password(s) the next time it boots.

8. Remove the blade from the enclosure.
9. Open the blade.
10. Remove the system board to gain access to the jumpers.
11. Relocate the jumper plug to enable the password feature.
12. Reinstall the system board.
13. Close the blade.
14. Install the blade in the enclosure.
15. Assign a new system and/or setup password.

Technical Specifications

| Processor | |
|--------------------------|---|
| Processor type | One or two Intel Xeon processor E5-2600 product family |
| Memory | |
| Architecture | 1600 MT/s, 1333 MT/s, 1066 MT/s, or 800 MT/s DDR3 and LV-DDR3 DIMMs |
| Memory module sockets | Twenty-four 240-pin |
| Memory module capacities | |
| RDIMMs | 2 GB (single-rank), 4 GB (single- and dual-rank), 8 GB (dual-rank), 16 GB (dual-rank), and 32 GB (quad-rank) |
| UDIMMs | 2 GB (single-rank) and 4 GB (dual-rank) |
| LRDIMMs | 32 GB (quad-rank) |
| Minimum RAM | 2 GB (single processor configuration) |
| Maximum RAM | 768 GB (with 32 GB LRDIMMs) |
| Drives | |
| Hard drives | Up to two 2.5-inch, hot-swappable SAS/SATA hard drives or two 2.5-inch, hot-swappable SAS/SATA/PCIe SSDs |
| Optical drive | External optional USB DVD |
| |  NOTE: DVD devices are data only. |
| Flash drive | Internal optional USB Internal optional SD card Optional vFlash card (with integrated iDRAC7 Enterprise) |
| Connectors | |
| Front | |
| USB | Two 4-pin, USB 2.0-compliant |
| Internal | |
| SD | Two internal SD cards dedicated for the hypervisor One dedicated for future vFlash support |

Mezzanine Cards

| | |
|-----------------|--|
| Mezzanine slots | Two mezzanine PCIe x8 Gen 3 slots supporting dual-port Gb Ethernet, 10 Gb Ethernet, FC8 Fibre Channel, or Infiniband mezzanine cards |
|-----------------|--|

Video

| | |
|--------------|---|
| Video type | Matrox G200 integrated with iDRAC |
| Video memory | MB shared with iDRAC application memory |

Battery

| | |
|----------------------|---------------------------------|
| NVRAM backup battery | CR 2032 3.0 V Lithium coin cell |
|----------------------|---------------------------------|

Environmental

 **NOTE:** For additional information about environmental measurements for specific system configurations, see dell.com/environmental_datasheets.

| | |
|--------------------------------|--|
| Storage temperature | –40 °C to 65 °C (–40 °F to 149 °F) with a maximum temperature gradation of 20 °C per hour. |
| Standard operating temperature | Continuous operation: 10 °C to 35 °C at 10% to 80% relative humidity (RH), with 26 °C max dew point. De-rate maximum allowable dry bulb temperature at 1 °C per 300 m above 900 m (1 °F per 550 ft). |

Expanded operating temperature

 **NOTE:** When operating in the expanded temperature range, system performance may be impacted.

 **NOTE:** When operating in the expanded temperature range, ambient temperature warnings may be reported on the LCD and in the System Event Log.

≤ 10% of annual operating hours

5 °C to 40 °C at 5% to 85% RH with 26 °C dew point.

 **NOTE:** Outside the standard operating temperature (10 °C to 35 °C), the system can operate down to 5 °C or up to 40 °C for a maximum of 10% of its annual operating hours.

For temperatures between 35 °C and 40 °C, de-rate maximum allowable dry bulb temperature by 1 °C per 175 m above 950 m (1 °F per 319 ft).

≤ 1% of annual operating hours

–5 °C to 45 °C at 5% to 90% RH with 26 °C dew point.

 **NOTE:** Outside the standard operating temperature (10 °C to 35 °C), the system can operate down to –5 °C or up to 45 °C for a maximum of 1% of its annual operating hours.

For temperatures between 40 °C and 45 °C, de-rate maximum allowable dry bulb temperature by 1 °C per 125 m above 950 m (1 °F per 228 ft).

Expanded operating temperature restrictions

- Do not perform a cold startup below 5 °C.
- Maximum 95 W processor is supported.
- The following do not support the expanded operating temperature range:
 - PCIe SSDs
 - LRDIMMs
 - Non Dell-qualified peripheral cards and/or peripheral cards greater than 25 W
 - Dell PowerEdge RAID Controller (PERC) H710/H710P cards (in dual-processor configurations)
- When populating the blade slots in the M1000e enclosure with only PowerEdge M620 blades:
 - Install only 97 mm wide heat sink(s).
 - Dual-processor blades with PERC H310 cards cannot be mixed with single-processor blades.
 - If you install a blade with two processors and a PERC H310 card in the M1000e enclosure, all blade slots in the enclosure must have PowerEdge M620 blades with the same configuration (PowerEdge M620 blades with two processors and a PERC H310 card). However, vacant blade slots in the enclosure can be installed with blade blanks.

System Messages

LCD Status Messages

The LCD messages consist of brief text messages that refer to events recorded in the System Event Log (SEL). For information on the SEL and configuring system management settings, see the systems management software documentation.

Viewing LCD Messages

If a system error occurs, the LCD screen will turn amber. Press the **Select** button to view the list of errors or status messages. Use the left and right buttons to highlight an error number, and press **Select** to view the error.

Removing LCD Messages

For faults associated with sensors, such as temperature, voltage, fans, and so on, the LCD message is automatically removed when that sensor returns to a normal state. For other faults, you must take action to remove the message from the display:

- Clear the SEL — You can perform this task remotely, but you will lose the event history for the system.
- Power cycle — Turn off the system and disconnect it from the electrical outlet; wait approximately 10 seconds, reconnect the power cable, and restart the system.

System Error Messages

System messages appear on the monitor to notify you of a possible problem with the system. These messages refer to events recorded in the System Event Log (SEL). For information on the SEL and configuring system management settings, see the systems management software documentation.

Some messages are also displayed in abbreviated form on the system's LCD, if the system includes that feature.

 **NOTE:** The LCD error messages listed here are displayed in the simple format. See Setup Menu to select the format in which the messages are displayed.

 **NOTE:** If you receive a system message not listed here, check the documentation for the application that was running when the message was displayed or the operating system's documentation for an explanation of the message and recommended action.

 **NOTE:** In some messages, a particular system component is identified by name ("*<name>*"), component number ("*<number>*"), or location ("*bay*").

Error Code Message Information

| | | |
|----------------|----------------|--|
| AMP0300 | Message | The system board <i><name></i> current is less than the lower warning threshold. |
| | Details | System board <i><name></i> current is outside of the optimum range. |

Error Code Message Information

- Action**
1. Review system power policy.
 2. Check system logs for power related failures.
 3. Review system configuration changes.
 4. If the issue persists, see [Getting Help](#).

AMP0301 Message The system board <name> current is less than the lower warning threshold.

LCD Message System board <name> current is outside of range.

Details System board <name> current is outside of the optimum range.

- Action**
1. Review system power policy.
 2. Check system logs for power related failures.
 3. Review system configuration changes.
 4. If the issue persists, see [Getting Help](#).

AMP0302 Message The system board <name> current is greater than the upper warning threshold.

Details System board <name> current is outside of the optimum range.

- Action**
1. Review system power policy.
 2. Check system logs for power related failures.
 3. Review system configuration changes.
 4. If the issue persists, see [Getting Help](#).

AMP0303 Message The system board <name> current is greater than the upper critical threshold.

LCD Message System board <name> current is outside of range.

Details System board <name> current is outside of the optimum range.

- Action**
1. Review system power policy.
 2. Check system logs for power related failures.
 3. Review system configuration changes.
 4. If the issue persists, see [Getting Help](#).

AMP0304 Message The system board <name> current is outside of range.

LCD Message System board <name> current is outside of range.

Details System board <name> current is outside of the optimum range.

- Action**
1. Review system power policy.
 2. Check system logs for power related failures.
 3. Review system configuration changes.

Error Code Message Information

4. If the issue persists, see [Getting Help](#).

| | | |
|----------------|--------------------|---|
| AMP0306 | Message | Disk drive bay <name> current is less than the lower warning threshold. |
| | Details | Disk drive bay <name> current is outside of the optimum range. |
| | Action | <ol style="list-style-type: none">1. Review system power policy.2. Check system logs for power related failures.3. Review system configuration changes.4. If the issue persists, see Getting Help. |
| AMP0307 | Message | Disk drive bay <name> current is less than the lower critical threshold. |
| | LCD Message | Disk drive bay <name> current is outside of range. |
| | Details | Disk drive bay <name> current is outside of the optimum range. |
| | Action | <ol style="list-style-type: none">1. Review system power policy.2. Check system logs for power related failures.3. Review system configuration changes.4. If the issue persists, see Getting Help. |
| AMP0308 | Message | Disk drive bay <name> current is greater than the upper warning threshold. |
| | Details | Disk drive bay <name> current is outside of the optimum range. |
| | Action | <ol style="list-style-type: none">1. Review system power policy.2. Check system logs for power related failures.3. Review system configuration changes.4. If the issue persists, see Getting Help. |
| AMP0309 | Message | Disk drive bay <name> current is greater than the upper critical threshold. |
| | LCD Message | Disk drive bay <name> current is outside of range. |
| | Details | Disk drive bay <name> current is outside of the optimum range. |
| | Action | <ol style="list-style-type: none">1. Review system power policy.2. Check system logs for power related failures.3. Review system configuration changes.4. If the issue persists, see Getting Help. |
| AMP0310 | Message | Disk drive bay <name> current is outside of range. |
| | LCD Message | Disk drive bay <name> current is outside of range. |

Error Code Message Information

| | | |
|----------------|--------------------|---|
| | Details | Disk drive bay <name> current is outside of the optimum range. |
| | Action | <ol style="list-style-type: none">1. Review system power policy.2. Check system logs for power related failures.3. Review system configuration changes.4. If the issue persists, see Getting Help. |
| AMP0312 | Message | System level current is less than the lower warning threshold. |
| | Details | System level current is outside of the optimum range. |
| | Action | <ol style="list-style-type: none">1. Review system power policy.2. Check system logs for power related failures.3. Review system configuration changes.4. If the issue persists, see Getting Help. |
| AMP0313 | Message | System level current is less than the lower warning threshold. |
| | LCD Message | System level current is outside of range. |
| | Details | System level current is outside of the optimum range. |
| | Action | <ol style="list-style-type: none">1. Review system power policy.2. Check system logs for power related failures.3. Review system configuration changes.4. If the issue persists, see Getting Help. |
| AMP0314 | Message | System level current is greater than the upper warning threshold. |
| | Details | System level current is outside of the optimum range. |
| | Action | <ol style="list-style-type: none">1. Review system power policy.2. Check system logs for power related failures.3. Review system configuration changes.4. If the issue persists, see Getting Help. |
| AMP0315 | Message | System level current is greater than the upper critical threshold. |
| | LCD Message | System level current is outside of range. |
| | Details | System level current is outside of the optimum range. |
| | Action | <ol style="list-style-type: none">1. Review system power policy.2. Check system logs for power related failures.3. Review system configuration changes. |

Error Code Message Information

4. If the issue persists, see [Getting Help](#).

| | | |
|----------------|--------------------|---|
| AMP0316 | Message | System level current is outside of range. |
| | LCD Message | System level current is outside of range. |
| | Details | System level current is outside of the optimum range. |
| | Action | <ol style="list-style-type: none">1. Review system power policy.2. Check system logs for power related failures.3. Review system configuration changes.4. If the issue persists, see Getting Help. |
| AMP0318 | Message | Chassis power level current is less than the lower warning threshold. |
| | Details | Chassis power level current is outside of the optimum range. |
| | Action | <ol style="list-style-type: none">1. Review system power policy.2. Check system logs for power related failures.3. Review system configuration changes.4. If the issue persists, see Getting Help. |
| AMP0319 | Message | Chassis power level current is less than the lower critical threshold |
| | Details | Chassis power level current is outside of the optimum range. |
| | Action | <ol style="list-style-type: none">1. Review system power policy.2. Check system logs for power related failures.3. Review system configuration changes.4. If the issue persists, see Getting Help. |
| AMP0320 | Message | Chassis power level current is greater than the upper warning threshold. |
| | Details | Chassis power level current is outside of the optimum range. |
| | Action | <ol style="list-style-type: none">1. Review system power policy.2. Check system logs for power related failures.3. Review system configuration changes.4. If the issue persists, see Getting Help. |
| AMP0321 | Message | Chassis power level current is greater than the upper critical threshold. |
| | Details | Chassis power level current is outside of the optimum range. |
| | Action | <ol style="list-style-type: none">1. Review system power policy. |

Error Code Message Information

2. Check system logs for power related failures.
3. Review system configuration changes.
4. If the issue persists, see [Getting Help](#).

| | | |
|----------------|----------------|---|
| AMP0322 | Message | Chassis power level current is outside of range. |
| | Details | Chassis power level current is outside of the optimum range. |
| | Action | <ol style="list-style-type: none">1. Review system power policy.2. Check system logs for power related failures.3. Review system configuration changes.4. If the issue persists, see Getting Help. |
| ASR0000 | Message | The watchdog timer expired. |
| | Details | The operating system or an application failed to communicate within the time-out period. |
| | Action | Check the operating system, application, hardware, and system event log for exception events. |
| ASR0001 | Message | The watchdog timer reset the system. |
| | Details | The operating system or an application failed to communicate within the time-out period. The system was reset. |
| | Action | Check the operating system, application, hardware, and system event log for exception events. |
| ASR0002 | Message | The watchdog timer powered off the system. |
| | Details | The operating system or an application failed to communicate within the time-out period. The system was shut down. |
| | Action | Check the operating system, application, hardware, and system event log for exception events. |
| ASR0003 | Message | The watchdog timer power cycled the system. |
| | Details | The operating system or an application failed to communicate within the time-out period. The system was power-cycled. |
| | Action | Check the operating system, application, hardware, and system event log for exception events. |
| ASR0008 | Message | The watchdog timer interrupt was initiated. |
| | Details | The operating system or an application failed to communicate within the time-out period. No action was taken. |

Error Code Message Information

Action Check the operating system, application, hardware, and system event log for exception events.

ASR0100 Message The BIOS watchdog timer reset the system.

Details The operating system or an application failed to communicate within the time-out period. The system was reset.

Action Check the operating system, application, hardware, and system event log for exception events.

ASR0101 Message The OS watchdog timer reset the system.

Details The operating system or an application failed to communicate within the time-out period. The system was reset.

Action Check the operating system, application, hardware, and system event log for exception events.

ASR0102 Message The OS watchdog timer shutdown the system.

Details The operating system or an application failed to communicate within the time-out period. The system was shutdown.

Action Check the operating system, application, hardware, and system event log for exception events.

ASR0103 Message The OS watchdog timer powered down the system.

Details The operating system or an application failed to communicate within the time-out period. The system was powered down.

Action Check the operating system, application, hardware, and system event log for exception events.

ASR0104 Message The OS watchdog timer power-cycled the system.

Details The operating system or an application failed to communicate within the time-out period. The system was power-cycled.

Action Check the operating system, application, hardware, and system event log for exception events.

ASR0105 Message The operating system watchdog timer powered off the system.

Details The operating system or an application failed to communicate within the time-out period. The system was powered off.

Action Check the operating system, application, hardware, and system event log for exception events.

Error Code Message Information

| | | |
|---------|--------------------|--|
| ASR0106 | Message | The watchdog timer expired. |
| | Details | The operating system or an application failed to communicate within the time-out period. |
| | Action | Check the operating system, application, hardware, and system event log for exception events. |
| ASR0107 | Message | The watchdog timer pre-timeout interrupt was initiated. |
| | Details | The operating system or an application failed to communicate within the time-out period. |
| | Action | Check the operating system, application, hardware, and system event log for exception events. |
| BAT0000 | Message | The system board battery is low. |
| | Details | The system board battery is either missing, bad, or unable to charge due to thermal issues. |
| | Action | Check system fans. Replace the system board battery. |
| BAT0002 | Message | The system board battery has failed. |
| | LCD Message | The system board battery has failed. Check battery. |
| | Details | The system board battery is either missing or bad. |
| | Action | See Getting Help . |
| BAT0004 | Message | The system board battery is absent. |
| | LCD Message | The system board battery is absent. Check battery. |
| | Action | Reinstall the system board battery. |
| BAT0005 | Message | The storage battery is low. |
| | Details | System has to remain powered on to charge the battery. |
| | Action | Allow the battery to charge. If the issue persists, see Getting Help . |
| BAT0007 | Message | The storage battery has failed. |
| | LCD Message | The storage battery has failed. Check battery. |
| | Details | Verify the cable connection between the storage battery and the controller. |
| | Action | Verify the storage battery installation. |
| BAT0010 | Message | The storage battery for disk drive bay <bay> is low. |
| | Details | System has to remain powered on to charge the storage battery. |
| | Action | Allow the storage battery to charge. If the issue persists, see Getting Help . |

Error Code Message Information

| | | |
|---------|--------------------|--|
| BAT0012 | Message | The storage battery for disk drive bay <bay> has failed. |
| | LCD Message | Battery for disk drive bay <bay> has failed. Check battery. |
| | Details | Verify the cable connection between the storage battery and the controller. |
| | Action | Verify the storage battery installation. |
| BAT0014 | Message | The storage battery for disk drive bay <bay> is absent. |
| | LCD Message | Battery for disk drive bay <bay> is absent. Check battery. |
| | Details | Verify the cable connection between the storage battery and the controller. |
| | Action | Verify the storage battery installation. |
| BAT0015 | Message | The <name> battery is low. |
| | Details | The low <name> battery may impact system performance negatively. |
| | Action | Recharge the <name> battery if possible. If the problem continues replace the <name> battery. |
| BAT0017 | Message | The <name> battery has failed. |
| | LCD Message | The <name> battery has failed. Check battery. |
| | Details | The <name> battery is either missing, bad, or unable to charge due to thermal issues. |
| | Action | Check system fans. Replace the <name> battery. |
| BAT0019 | Message | The <name> battery is absent. |
| | LCD Message | The <name> battery is absent. Check battery. |
| | Details | The failed or missing <name> battery may reduce system performance. |
| | Action | Check system fans. Replace the <name> battery. |
| CBL0006 | Message | Multiple storage controllers are incorrectly connected to the same backplane <Bay ID>. |
| | Details | Unsupported backplane configuration. |
| | Action | Check backplane configuration. Reconnect cable. If the issue persists, see Getting Help . |
| CPU0000 | Message | CPU <number> has an internal error (IERR). |
| | LCD Message | CPU <number> has an internal error (IERR). |
| | Details | System event log and OS logs may indicate that the exception is external to the processor. |
| | Action | Review System Event Log and Operating System Logs. If the issue persists, see Getting Help . |

Error Code Message Information

| | | |
|---------|--------------------|---|
| CPU0001 | Message | CPU <number> has a thermal trip (over-temperature) event. |
| | LCD Message | CPU <number> has a thermal trip. Check CPU heat sink. |
| | Details | The processor temperature increased beyond the operational range. |
| | Action | Review logs for fan failures, replace failed fans. If no fan failures are detected, check inlet temperature (if available) and reinstall processor heat-sink. |
| CPU0002 | Message | CPU <number> has failed the built-in self-test (BIST). |
| | Action | <ol style="list-style-type: none">1. Turn system off and remove input power for one minute. Reapply input power and turn system on.2. Make sure the processor is seated correctly.3. If the issue persists, see Getting Help. |
| CPU0003 | Message | CPU <number> is stuck in POST. |
| | Action | <ol style="list-style-type: none">1. Turn system off and remove input power for one minute. Reapply input power and turn system on.2. Reduce system configuration to minimum memory and remove all PCI devices. If system completes POST, update system BIOS. reinstall memory and PCI one component at a time to meet the original configuration.3. If the issue persists, see Getting Help. |
| CPU0004 | Message | CPU <number> failed to initialize. |
| | Action | <ol style="list-style-type: none">1. Turn system off and remove input power for one minute. Reapply input power and turn system on.2. Make sure the processor is seated correctly.3. If the issue persists, see Getting Help. |
| CPU0005 | Message | CPU <number> configuration is unsupported. |
| | LCD Message | CPU <number> configuration is unsupported. Check CPU or BIOS revision. |
| | Details | System is unable to boot or may run in a degraded state. |
| | Action | Review the technical specifications for supported processor types. |
| CPU0006 | Message | Unrecoverable CPU complex error detected on CPU <number>. |
| | Details | System is unable to boot or may run in a degraded state. |
| | Action | <ol style="list-style-type: none">1. Turn system off and remove input power for one minute. Reapply input power and turn system on.2. Make sure the processor is seated correctly.3. If the issue persists, see Getting Help. |

Error Code Message Information

| | | |
|---------|--------------------|--|
| CPU0008 | Message | CPU <number> is disabled. |
| | Details | System is unable to boot or may run in a degraded state. |
| | Action | If unexpected, check presence, and system setup (BIOS) configuration. |
| CPU0010 | Message | CPU <number> is throttled. |
| | Details | The CPU is throttled due to thermal or power conditions. |
| | Action | Review system logs for power or thermal exceptions. |
| CPU0023 | Message | CPU <number> is absent. |
| | LCD Message | CPU <number> is absent. Check CPU. |
| | Action | Verify processor installation. If present, re-seat the processor. |
| CPU0100 | Message | CPU <number> temperature is less than the lower warning threshold. |
| | Details | System performance may be degraded. |
| | Action | Check system operating environment. |
| CPU0101 | Message | CPU <number> temperature is less than the lower critical threshold. |
| | LCD Message | CPU <number> temperature is outside of range. |
| | Details | System performance may be degraded. |
| | Action | Check system operating environment, fans, and heat-sinks. |
| CPU0102 | Message | CPU <number> temperature is greater than the upper warning threshold. |
| | Details | System performance may be degraded. |
| | Action | Check system operating environment, fans, and heat-sinks. |
| CPU0103 | Message | CPU <number> temperature is greater than the upper critical threshold. |
| | LCD Message | CPU <number> temperature is outside of range. Check fans. |
| | Details | System performance may be degraded. |
| | Action | Check system operating environment, fans, and heat-sinks. |
| CPU0104 | Message | CPU <number> temperature is outside of range. |
| | LCD Message | CPU <number> temperature is outside of range. Check fans. |
| | Details | System performance may be degraded. |
| | Action | Check system operating environment, fans, and heat-sinks. |
| CPU0200 | Message | CPU <number> <name> voltage is less than the lower warning threshold. |

Error Code Message Information

| | | |
|----------------|--------------------|---|
| | Details | Low voltages may be the result of a problem with the voltage regulator or a problem with the processor. The low voltage may cause the processor to fail to operate. |
| | Action | <ol style="list-style-type: none">1. Turn system off and remove input power for one minute.2. Reapply input power and turn system on.3. Ensure the processor is seated correctly.4. If the issue persists, see Getting Help. |
| CPU0201 | Message | CPU <number> <name> voltage is less than the lower critical threshold. |
| | LCD Message | CPU <number> <name> voltage is outside of range. Re-seat CPU. |
| | Details | Low voltages may be the result of a problem with the voltage regulator or a problem with the processor. When the critical threshold is crossed, the processor will fail to operate. The system may power down. |
| | Action | <ol style="list-style-type: none">1. Turn system off and remove input power for one minute.2. Reapply input power and turn system on.3. Ensure the processor is seated correctly.4. If the issue persists, see Getting Help. |
| CPU0202 | Message | CPU <number> <name> voltage is greater than the upper warning threshold. |
| | Details | High voltages may be the result of problem with the voltage regulator or a problem with the processor. Elevated voltages may result in damage to the processor or other electronic components in side the system. |
| | Action | <ol style="list-style-type: none">1. Turn system off and remove input power for one minute.2. Reapply input power and turn system on.3. Ensure the processor is seated correctly.4. If the issue persists, see Getting Help. |
| CPU0203 | Message | CPU <number> <name> voltage is greater than the upper critical threshold. |
| | LCD Message | CPU <number> <name> voltage is outside of range. Re-seat CPU. |
| | Details | High voltages may be the result of problem with the voltage regulator or a problem with the processor. Elevated voltages may result in damage to the processor or other system electrical components. The system may power down. |
| | Action | <ol style="list-style-type: none">1. Turn system off and remove input power for one minute.2. Reapply input power and turn system on.3. Ensure the processor is seated correctly.4. If the issue persists, see Getting Help. |
| CPU0204 | Message | CPU <number> <name> voltage is outside of range. |

Error Code Message Information

| | | |
|----------------|--------------------|---|
| | LCD Message | CPU <number> <name> voltage is outside of range. Re-seat CPU. |
| | Details | Voltages outside the allowable range may damage electrical components or may cause the system to shutdown. |
| | Action | <ol style="list-style-type: none">1. Turn system off and remove input power for one minute.2. Ensure the processor is seated correctly.3. Reapply input power and turn system on.4. If the issue persists, see Getting Help. |
| CPU0700 | Message | CPU <number> initialization error detected. |
| | LCD Message | CPU <number> initialization error detected. Power cycle system. |
| | Details | System BIOS was unable to initialize the processor. |
| | Action | <ol style="list-style-type: none">1. Turn system off and remove input power for one minute.2. Ensure the processor is seated correctly.3. Reapply input power and turn system on.4. If the issue persists, see Getting Help. |
| CPU0701 | Message | CPU <number> protocol error detected. |
| | LCD Message | CPU <number> protocol error detected. Power cycle system. |
| | Details | System event log and operating system logs may indicate that the exception is external to the processor. |
| | Action | <ol style="list-style-type: none">1. Check system and operating system logs for exceptions. If no exceptions are found, continue.2. Turn system off and remove input power for one minute.3. Ensure the processor is seated correctly.4. Reapply input power and turn system on.5. If the issue persists, see Getting Help. |
| CPU0702 | Message | CPU bus parity error detected. |
| | LCD Message | CPU bus parity error detected. Power cycle system. |
| | Details | System event log and operating system logs may indicate that the exception is external to the processor. |
| | Action | <ol style="list-style-type: none">1. Check system and operating system logs for exceptions. If no exceptions are found, continue.2. Turn system off and remove input power for one minute.3. Ensure the processor is seated correctly.4. Reapply input power and turn system on. |

Error Code Message Information

5. If the issue persists, see [Getting Help](#).

| | | |
|----------------|--------------------|---|
| CPU0703 | Message | CPU bus initialization error detected. |
| | LCD Message | CPU bus initialization error detected. Power cycle system. |
| | Details | System event log and operating system logs may indicate that the exception is external to the processor. |
| | Action | <ol style="list-style-type: none">1. Check system and operating system logs for exceptions. If no exceptions are found, continue.2. Turn system off and remove input power for one minute.3. Ensure the processor is seated correctly.4. Reapply input power and turn system on.5. If the issue persists, see Getting Help. |
| CPU0704 | Message | CPU <number> machine check error detected. |
| | LCD Message | CPU <number> machine check error detected. Power cycle system. |
| | Details | System event log and operating system logs may indicate that the exception is external to the processor. |
| | Action | <ol style="list-style-type: none">1. Check system and operating system logs for exceptions. If no exceptions are found, continue.2. Turn system off and remove input power for one minute.3. Ensure the processor is seated correctly.4. Reapply input power and turn system on.5. If the issue persists, see Getting Help. |
| CPU0801 | Message | CPU <number> voltage regulator module failed. |
| | LCD Message | CPU <number> voltage regulator module failed. Re-seat module. |
| | Details | System performance may be degraded or the system may fail to operate. |
| | Action | <ol style="list-style-type: none">1. Turn system off and remove input power for one minute.2. Reapply input power and turn system on.3. Ensure the processor is seated correctly.4. If the issue persists, see Getting Help. |
| CPU0802 | Message | A predictive failure detected on CPU <number> voltage regulator module. |
| | Details | System performance may be degraded or the system may fail to operate. |
| | Action | <ol style="list-style-type: none">1. Turn system off and remove input power for one minute.2. Reapply input power and turn system on. |

Error Code Message Information

| | | |
|---------|--------------------|---|
| | | <ol style="list-style-type: none">3. Ensure the processor is seated correctly.4. If the issue persists, see Getting Help. |
| CPU0803 | Message | The power input for CPU <number> voltage regulator module is lost. |
| | LCD Message | Lost power input for CPU <number>voltage regulator module. Re-seat module. |
| | Details | System performance may be degraded or the system may fail to operate. |
| | Action | <ol style="list-style-type: none">1. Turn system off and remove input power for one minute.2. Reapply input power and turn system on.3. Ensure the processor is seated correctly.4. If the issue persists, see Getting Help. |
| CPU0804 | Message | The power input for CPU <number> voltage regulator module is outside of range. |
| | LCD Message | The power input for CPU <number> voltage regulator module is outside of range. Re-seat module. |
| | Details | System performance may be degraded or the system may fail to operate. |
| | Action | <ol style="list-style-type: none">1. Turn system off and remove input power for one minute.2. Reapply input power and turn system on.3. Ensure the processor is seated correctly.4. If the issue persists, see Getting Help. |
| CPU0805 | Message | The power input for CPU <number> voltage regulator module is outside of range, but it is attached to the system. |
| | Details | System performance may be degraded or the system may fail to operate. |
| | Action | <ol style="list-style-type: none">1. Turn system off and remove input power for one minute.2. Reapply input power and turn system on.3. Ensure the processor is seated correctly.4. If the issue persists, see Getting Help. |
| CPU0806 | Message | CPU <number> voltage regulator module is incorrectly configured. |
| | LCD Message | CPU <number> voltage regulator module incorrectly configured. Check configuration. |
| | Details | System performance may be degraded or the system may fail to operate. |
| | Action | Review this manual for proper configuration and installation procedures. |
| CPU0816 | Message | CPU <number> voltage regulator module is absent. |
| | LCD Message | CPU <number> voltage regulator module absent. Check module. |

Error Code Message Information

| | | |
|----------------|--------------------|--|
| | Details | System performance may be degraded or the system may fail to operate. |
| | Action | If removal was unintended, check presence and reinstall. |
| HWC1001 | Message | The <name> is absent. |
| | LCD Message | The <name> is absent. Check hardware. |
| | Details | The absent device may be necessary for proper operation. System functionality may be degraded. |
| | Action | Reinstall or reconnect the hardware. |
| HWC1002 | Message | The <name> is disabled. |
| | Action | If device disabled unexpectedly, re-enable device. |
| HWC1005 | Message | The storage adapter is absent. |
| | LCD Message | The storage adapter is absent. Check hardware. |
| | Details | The storage adapter may be necessary for proper operation. System functionality may be degraded. |
| | Action | Install storage adapter. |
| HWC1006 | Message | The storage adapter is disabled. |
| | Action | If adapter disabled unexpectedly, re-enable the storage adapter. |
| HWC1009 | Message | The backplane is absent. |
| | LCD Message | The backplane is absent. Check hardware. |
| | Details | The backplane may be necessary for proper operation. System functionality may be degraded. |
| | Action | If removal was unintended, check presence, then reinstall or reconnect. |
| HWC1010 | Message | The backplane is disabled. |
| | Action | If disabled unexpectedly, re-enable backplane. |
| HWC1015 | Message | The mezzanine card <number> is absent. |
| | Details | The mezzanine card may be necessary for proper operation. System functionality may be degraded. |
| | Action | If removal was unintended, check presence, then reinstall or reconnect. |
| HWC2006 | Message | The <name> is not installed correctly. |
| | LCD Message | The <name> is not installed correctly. Check connection. |

Error Code Message Information

| | | |
|----------------|--------------------|---|
| | Details | The device may be necessary for proper operation. System functionality may be degraded. |
| | Action | Check presence, then re-install or reconnect. |
| HWC2008 | Message | A fabric mismatch detected between IOM and mezzanine card <number>. |
| | Details | The fabric type for the IOM and mezzanine cards must match. |
| | Action | Check chassis fabric type in CMC GUI and compare to the type of IOM or mezzanine card. |
| HWC2011 | Message | The riser board cable or interconnect is not connected, or is improperly connected. |
| | LCD Message | Riser board cable or interconnect failure. Check connection. |
| | Details | The riser blade cable may be necessary for proper operation. System functionality may be degraded. |
| | Action | Check the riser board or interconnect presence, then reinstall or reconnect. |
| HWC3000 | Message | The <name> is removed. |
| | Details | The removed device may be necessary for proper operation. System functionality may be degraded. |
| | Action | If removal was unintended, check presence of the removed device, then reinstall or reconnect |
| HWC3002 | Message | Server <number> is removed. |
| | Action | If removal was unintended, check presence of the server, then reinsert. |
| HWC3004 | Message | IO module <number> is removed. |
| | Action | If removal was unintended, check presence of the IO module, then reinsert. |
| HWC4000 | Message | A hardware incompatibility detected between BMC/iDRAC firmware and CPU. |
| | LCD Message | Incompatibility between BMC/iDRAC firmware and CPU. Update firmware. |
| | Details | A hardware incompatibility was detected between BMC/iDRAC firmware and Processor(s). An iDRAC or BMC firmware update is needed. |
| | Action | Update the BMC/iDRAC firmware. If the issue persists, see Getting Help . |
| HWC4002 | Message | A hardware incompatibility detected between BMC/iDRAC firmware and other hardware. |
| | Details | A hardware incompatibility was detected between BMC/iDRAC firmware and other hardware. An iDRAC or BMC firmware update is needed. |
| | Action | Update the BMC/iDRAC firmware. If the issue persists, see Getting Help . |
| HWC4011 | Message | Hardware unsuccessfully updated for mezzanine card <number>. |

Error Code Message Information

| | | |
|----------------|----------------|--|
| | Action | Check presence of the hardware, reinstall or reconnect, then reattempt the update. If the issue persists, see Getting Help . |
| HWC4013 | Message | Hardware unsuccessfully updated for embedded NIC. |
| | Action | Check presence, reinstall or reconnect, then reattempt the update. If the issue persists, see Getting Help . |
| HWC4015 | Message | Link Tuning error detected. |
| | Details | CMC has old firmware. After updating the firmware the CMC will recognize the device. |
| | Action | Update the CMC firmware. If the issue persists, see Getting Help . |
| HWC5001 | Message | <name> is offline. |
| | Action | If unexpected, check presence, then reinstall or reconnect. |
| HWC5002 | Message | A fabric mismatch detected on <name>. |
| | Details | The fabric type for the IOM and mezzanine cards must match. |
| | Action | Check chassis fabric type in CMC GUI and compare to the type of IOM or mezzanine card. |
| HWC5004 | Message | A link tuning failure detected on <name>. |
| | Details | CMC has old firmware. After updating the firmware the CMC will recognize the device. |
| | Action | Update the CMC firmware. If the issue persists, see Getting Help . |
| HWC5006 | Message | A failure is detected on <name>. |
| | Action | If the issue persists, see Getting Help . |
| HWC5008 | Message | Console is not available for the <name>. |
| | Action | If the issue persists, see Getting Help . |
| HWC5010 | Message | <name> cannot detect any hosts. |
| | Action | If the issue persists, see Getting Help . |
| HWC5014 | Message | <name> is not functional and is powered off. |
| | Action | If the issue persists, see Getting Help . |
| HWC5031 | Message | IO module <number> is offline. |
| | Details | The CMC has powered off the IOM. |
| | Action | If the issue persists, see Getting Help . |

Error Code Message Information

| | | |
|---------|----------------|---|
| HWC5032 | Message | A fabric mismatch detected on IO module <number>. |
| | Details | The fabric type for IOM's on the same chassis fabric must match. |
| | Action | Check chassis fabric type in CMC GUI and compare to the type of both IOM's. |
| HWC5034 | Message | A link tuning failure detected on IO module <number>. |
| | Details | Link tuning table not supported for this IO modular. |
| | Action | Update the CMC firmware. If the issue persists, see Getting Help . |
| HWC5036 | Message | A failure is detected on IO module <number>. |
| | Details | The IOM module performance may be impacted. |
| | Action | If the issue persists, see Getting Help . |
| HWC6000 | Message | The <name> controller is offline. |
| | Details | Information and status from the controller is unavailable. |
| | Action | Remove and reapply input power. If the issue persists, see Getting Help . |
| HWC6002 | Message | The <name> controller is stuck in boot mode. |
| | Details | Information and status from the controller is unavailable. |
| | Action | Remove and reapply input power. If the issue persists, see Getting Help . |
| HWC6003 | Message | The <name> controller is booting. |
| HWC6004 | Message | Cannot communicate with <name> controller. |
| | Details | Information and status from the controller is unavailable. |
| | Action | Remove and reapply input power. If the issue persists, see Getting Help . |
| HWC7002 | Message | Server <number> health changed to a warning state from a normal state. |
| | Details | Server <number> health changed to a warning state from a normal state. |
| | Action | Review System Log or front panel for additional information. |
| HWC7004 | Message | Server <number> health changed to a critical state from either a normal or warning state. |
| | Details | Server <number> health changed to a warning state from a normal state. |
| | Action | Review System Log or front panel for additional information. |
| HWC7006 | Message | Server <number> health changed to a nonrecoverable state from a less severe state. |
| | Details | Server <number> health changed to a warning state from a normal state. |

Error Code Message Information

| | | |
|----------------|--------------------|---|
| | Action | Review System Log or front panel for additional information. |
| HWC7008 | Message | Server <number> health changed to a warning state from more severe state. Server <number> health changed to a critical state from a non-recoverable state. |
| | Details | Server <number> health changed to a warning state from a normal state. |
| | Action | Review System Log or front panel for additional information. |
| HWC7010 | Message | Server <number> health changed to a critical state from a nonrecoverable state. |
| | Details | Server <number> health changed to a warning state from a normal state. |
| | Action | Review System Log or front panel for additional information. |
| HWC7012 | Message | Server <number> health changed to a nonrecoverable state. |
| | Details | Server <number> health changed to a warning state from a normal state. |
| | Action | Review System Log or front panel for additional information. |
| LNK2700 | Message | The <name> LAN heartbeat is lost. |
| | Details | CMC has lost network connection. |
| | Action | Check network cable and network connections. |
| MEM0000 | Message | Persistent correctable memory errors detected on a memory device at location(s) <location>. |
| | Details | This is an early indicator of a possible future uncorrectable error. |
| | Action | Re-seat the memory modules. If the issue persists, see Getting Help . |
| MEM0001 | Message | Multi-bit memory errors detected on a memory device at location(s) <location>. |
| | LCD Message | Multi-bit memory error on <location>. Re-seat memory. |
| | Details | The memory module has encountered a uncorrectable error. System performance may be degraded. The operating system and/or applications may fail as a result. |
| | Action | Re-seat the memory modules. If the issue persists, see Getting Help . |
| MEM0002 | Message | Parity memory errors detected on a memory device at location <location>. |
| | Details | The memory is operational. This an early indicator of a possible future uncorrectable error. |
| | Action | Re-seat the memory modules. If the issue persists, see Getting Help . |
| MEM0003 | Message | Stuck bit memory error detected on a memory device at location <location>. |
| | Details | This is an early indicator of a possible future uncorrectable error. |

Error Code Message Information

| | | |
|----------------|--------------------|---|
| | Action | Re-seat the memory modules. If the issue persists, see Getting Help . |
| MEM0004 | Message | Memory device at location <i><location></i> is disabled. |
| | Details | The memory may not be seated correctly, misconfigured, or has failed. Memory size is reduced. |
| | Action | Re-seat the memory modules. If the issue persists, see Getting Help . |
| MEM0005 | Message | Persistent correctable memory error limit reached for a memory device at location(s) <i><location></i> . |
| | LCD Message | Persistent correctable memory error limit reached for <i><location></i> . Re-seat memory. |
| | Details | The memory is operational. This an early indicator of a possible future uncorrectable error. |
| | Action | Re-seat the memory modules. If the issue persists, see Getting Help . |
| MEM0007 | Message | Unsupported memory configuration; check memory device at location <i><location></i> . |
| | LCD Message | Unsupported memory configuration. Check memory <i><location></i> . |
| | Details | The memory may not be seated correctly, misconfigured, or has failed. Memory size is reduced. |
| | Action | Check the memory configuration. Re-seat the memory modules. If the issue persists, see Getting Help . |
| MEM0009 | Message | Memory device at location <i><location></i> is throttled. |
| | Details | System performance is degraded. |
| | Action | If unexpected, review system logs for power or thermal exceptions. |
| MEM0010 | Message | Memory device at location <i><location></i> is over heating. |
| | LCD Message | Memory device <i><location></i> is over heating. Check fans. |
| | Details | System performance is degraded. |
| | Action | If unexpected, review system logs for power or thermal exceptions. |
| MEM0022 | Message | Memory device at location <i><location></i> is absent. |
| | Details | The memory may not be seated correctly, misconfigured, or has failed. Memory size is reduced. |
| | Action | Re-seat the memory modules. If the issue persists, see Getting Help . |
| MEM0701 | Message | Correctable memory error rate exceeded for <i><location></i> . |

Error Code Message Information

| | | |
|----------------|--------------------|---|
| | Details | The memory may not be operational. This an early indicator of a possible future uncorrectable error. |
| | Action | Re-seat the memory modules. If the issue persists, see Getting Help . |
| MEM0702 | Message | Correctable memory error rate exceeded for <i><location></i> . |
| | LCD Message | Correctable memory error rate exceeded for <i><location></i> . Re-seat memory. |
| | Details | The memory may not be operational. This an early indicator of a possible future uncorrectable error. |
| | Action | Re-seat the memory modules. If the issue persists, see Getting Help . |
| MEM1001 | Message | Memory device at location <i><location></i> failed to transition to a running state. |
| | LCD Message | Memory device <i><location></i> failed to transition to a running state. Re-seat memory |
| | Details | The memory may not be operational. This an early indicator of a possible future uncorrectable error. |
| | Action | Re-seat the memory modules. If the issue persists, see Getting Help . |
| MEM1003 | Message | Memory device at location <i><location></i> failed to transition to in test. |
| | Details | The memory may not be operational. This an early indicator of a possible future uncorrectable error. |
| | Action | Re-seat the memory modules. If the issue persists, see Getting Help . |
| MEM1012 | Message | Memory device at location <i><location></i> is in a degraded state. |
| | Details | The memory may not be operational. This an early indicator of a possible future uncorrectable error. |
| | Action | Re-seat the memory modules. If the issue persists, see Getting Help . |
| MEM1016 | Message | Memory device at location <i><location></i> is not installed correctly. |
| | LCD Message | Memory <i><location></i> is not installed correctly. Reinstall. |
| | Details | The memory may not be seated correctly, misconfigured, or has failed. Memory size is reduced. |
| | Action | Check the memory configuration. Re-seat the memory modules. If the issue persists, see Getting Help . |
| MEM1205 | Message | Memory mirror redundancy is lost. Check memory device at location(s) <i><location></i> . |
| | LCD Message | Memory mirror lost on <i><location></i> . Power cycle system. |
| | Details | The memory may not be seated correctly, misconfigured, or has failed. |

Error Code Message Information

| | | |
|----------------|--------------------|---|
| | Action | Check the memory configuration. Re-seat the memory modules. If the issue persists, see Getting Help . |
| MEM1206 | Message | Memory mirror redundancy is degraded. Check memory device at location <i><location></i> . |
| | Details | The memory may not be seated correctly, misconfigured, or has failed. |
| | Action | Check the memory configuration. Re-seat the memory modules. If the issue persists, see Getting Help . |
| MEM1208 | Message | Memory spare redundancy is lost. Check memory device at location <i><location></i> . |
| | LCD Message | Memory spare lost on <i><location></i> . Power cycle system. |
| | Details | Memory sparing is no longer available. |
| | Action | Re-seat the memory modules. If the issue persists, see Getting Help . |
| MEM1212 | Message | Memory redundancy is lost. |
| | Details | The memory may not be seated correctly, misconfigured, or has failed. |
| | Action | Review system logs for memory exceptions. reinstall memory at location <i><location></i> |
| MEM1214 | Message | Memory redundancy is degraded. |
| | Details | The memory may not be seated correctly, misconfigured, or has failed. |
| | Action | Check the memory configuration. Re-seat the memory modules. If the issue persists, see Getting Help . |
| MEM7002 | Message | A hardware mismatch detected for memory riser. |
| | LCD Message | Memory riser mismatch detected. Check memory riser. |
| | Details | Memory riser is installed incorrectly, or failed. |
| | Action | Check that the memory riser is installed correctly. If the issue persists, see Getting Help . |
| MEM8000 | Message | Correctable memory error logging disabled for a memory device at location <i><location></i> . |
| | LCD Message | SBE log disabled on <i><location></i> . Re-seat memory. |
| | Details | Errors are being corrected but no longer logged. |
| | Action | Review system logs for memory exceptions. reinstall memory at location <i><location></i> . |
| OSE0000 | Message | A critical stop occurred during OS load. |
| | Details | The system halted due to an exception during operating system load or operating system initialization. |
| | Action | Review operating system logs and system video for additional information. |

Error Code Message Information

| | | |
|----------------|----------------|--|
| OSE0001 | Message | A runtime critical stop occurred. |
| | Details | The system halted due to an exception while the operating system was running. This is a kernel panic or bug check event. |
| | Action | Review operating system logs and system video for additional information. |
| OSE0004 | Message | A soft shut-down initiated by platform event filter. |
| | Details | A separate exception or status condition shutdown the operating system. (IPMI sensor type 20h - offset 04h). |
| | Action | Review system event log for platform events capable of shutting the system down. |
| OSE0005 | Message | Agent is not responding. |
| | Details | Graceful shutdown request to an agent via the BMC did not occur due to a system hardware or software exception. |
| | Action | Review operating system logs and system video for additional information. |
| OSE1001 | Message | Failed to boot from A. |
| | Action | Review system boot configuration and boot media. Verify the media in a: is bootable. See system video for additional information. |
| OSE1003 | Message | Failed to boot from C. |
| | Action | Review system boot configuration and boot media. Verify the media in C: is bootable. See system video for additional information. |
| OSE1005 | Message | PXE boot failed. |
| | Action | Review system boot configuration, local PXE configuration, and PXE server configuration. |
| OSE1007 | Message | Diagnostic boot failed. |
| | Action | Review system boot configuration and boot media. See system video for additional information. |
| OSE1009 | Message | Failed to boot from CD-ROM. |
| | Action | Review system boot configuration and boot media. Verify the media in the CDROM is bootable. See system video for additional information. |
| OSE1011 | Message | Failed to boot from ROM. |
| | Action | Check system event logs for additional exception information. Power down the system and attempt to boot again. |
| OSE1013 | Message | Failed to boot. |

Error Code Message Information

| | | |
|---------|--------------------|---|
| | Action | Review system boot configuration and boot media. See system video for additional information. |
| PCI1302 | Message | A bus time-out was detected on a component at bus <i><bus></i> device <i><device></i> function <i><func></i> . |
| | Details | System performance may be degraded. The device has failed to respond to a transaction. |
| | Action | Cycle input power, update component drivers, if device is removable, reinstall the device. |
| PCI1304 | Message | An I/O channel check error was detected. |
| | LCD Message | I/O channel check error detected. Power cycle system. |
| | Action | Cycle input power, update component drivers, if device is removable, reinstall the device. |
| PCI1306 | Message | A software error was detected on a component at bus <i><bus></i> device <i><device></i> function <i><func></i> . |
| | Action | Reboot the system and update the component drivers. |
| PCI1308 | Message | A PCI parity error was detected on a component at bus <i><bus></i> device <i><device></i> function <i><func></i> . |
| | LCD Message | PCI parity error on bus <i><bus></i> device <i><device></i> function <i><func></i> . Power cycle system. |
| | Details | System performance may be degraded, PCI device may fail to operate, or system may fail to operate. |
| | Action | Cycle input power, update component drivers, if device is removable, reinstall the device. |
| PCI1310 | Message | A PCI system error was detected on a component at bus <i><bus></i> device <i><device></i> function <i><func></i> . |
| | LCD Message | PCI system error on bus <i><bus></i> device <i><device></i> function <i><func></i> . Power cycle system. |
| | Details | System performance may be degraded, or system may fail to operate. |
| | Action | Cycle input power, update component drivers, if device is removable, reinstall the device. |
| PCI1314 | Message | A bus correctable error was detected on a component at bus <i><bus></i> device <i><device></i> function <i><func></i> . |
| | Details | System performance may be degraded. |
| | Action | Cycle input power, update component drivers, if device is removable reinstall the device at the next scheduled service time. |
| PCI1316 | Message | A bus uncorrectable error was detected on a component at bus <i><bus></i> device <i><device></i> function <i><func></i> . |

Error Code Message Information

Details System performance may be degraded, or system may fail to operate.
Action Cycle input power, update component drivers, if device is removable, reinstall the device.

PCI1318 Message A fatal error was detected on a component at bus *<bus>* device *<device>* function *<func>*.

LCD Message Fatal error on bus *<bus>* device *<device>* function *<func>*. Power cycle system.

Details System performance may be degraded, or system may fail to operate.

Action Cycle input power, update component drivers, if device is removable, reinstall the device.

PCI1320 Message A bus fatal error was detected on a component at bus *<bus>* device *<device>* function *<func>*.

LCD Message Bus fatal error on bus *<bus>* device *<device>* function *<func>*. Power cycle system.

Details System performance may be degraded, or system may fail to operate.

Action Cycle input power, update component drivers, if device is removable, reinstall the device.

PCI1322 Message Bus performance degraded for a component at bus *<bus>* device *<device>* function *<func>*.

Details System performance may be degraded. The bus is not operating at maximum speed or width.

Action Cycle input power, update component drivers, if device is removable, reinstall the device.

PCI1342 Message A bus time-out was detected on a component at slot *<number>*.

Details System performance may be degraded, or system may fail to operate.

Action Cycle input power, update component drivers, if device is removable, reinstall the device.

PCI1344 Message An I/O channel check error was detected.

LCD Message An I/O channel check error was detected. Power cycle system.

Action Cycle input power, update component drivers, if device is removable, reinstall the device.

PCI1346 Message A software error was detected on a component at slot *<number>*.

Action Reboot the system and update the component drivers.

PCI1348 Message A PCI parity error was detected on a component at slot *<number>*.

LCD Message PCI parity error on slot *<number>*. Re-seat PCI card.

Details System performance may be degraded, or system may fail to operate.

Error Code Message Information

| | | |
|---------|--------------------|--|
| | Action | Cycle input power, update component drivers, if device is removable, reinstall the device. |
| PCI1350 | Message | A PCI system error was detected on a component at slot <number>. |
| | LCD Message | PCI parity error on slot <number>. Re-seat PCI card. |
| | Details | System performance may be degraded, or system may fail to operate. |
| | Action | Cycle input power, update component drivers, if device is removable, reinstall the device. |
| PCI1354 | Message | A bus correctable error was detected on a component at slot <number>. |
| | Details | System performance may be degraded. |
| | Action | Cycle input power, update component drivers, remove and reinstall the device at the next scheduled service time. |
| PCI1356 | Message | A bus uncorrectable error was detected on a component at slot <number>. |
| | Details | System performance may be degraded, or system may fail to operate. |
| | Action | Cycle input power, update component drivers, if device is removable, reinstall the device. |
| PCI1358 | Message | A fatal error was detected on a component at slot <number>. |
| | LCD Message | Fatal error on slot <number>. Re-seat PCI card. |
| | Details | System performance may be degraded, or system may fail to operate. |
| | Action | Cycle input power, update component drivers, if device is removable, reinstall the device. |
| PCI1360 | Message | A bus fatal error was detected on a component at slot <number>. |
| | LCD Message | Bus fatal error on slot <number>. Re-seat PCI card. |
| | Details | System performance may be degraded, or system may fail to operate. |
| | Action | Cycle input power, update component drivers, if device is removable, reinstall the device. |
| PCI1362 | Message | Bus performance degraded for a component at slot <number>. |
| | Details | System performance may be degraded. The bus is not operating at maximum speed or width. |
| | Action | Cycle input power, update component drivers, remove and reinstall the device at the next scheduled service time. |
| PCI2000 | Message | A fatal IO error detected on a component at bus <bus>device<device>function <func>. |

Error Code Message Information

| | | |
|----------------|--------------------|--|
| | LCD Message | Fatal IO error on bus <i><bus></i> device <i><device></i> function <i><func></i> . |
| | Details | System performance may be degraded, or system may fail to operate. |
| | Action | Cycle input power, update component drivers, remove and reinstall the device. |
| PCI2002 | Message | A fatal IO error detected on a component at slot <i><number></i> . |
| | LCD Message | Fatal IO error on slot <i><number></i> . |
| | Details | System performance may be degraded, or system may fail to operate. |
| | Action | Cycle input power, update component drivers, remove and reinstall the device. |
| PCI3000 | Message | Device option ROM on embedded NIC failed to support Link Tuning or FlexAddress. |
| | Details | Either the BIOS, BMC/iDRAC, or LOM firmware is out of date and does not support FlexAddress. |
| | Action | Update BIOS, BMC/iDRAC, and LOM firmware. If the issue persists, see Getting Help . |
| PCI3002 | Message | Failed to program virtual MAC address on a component at bus <i><bus></i> device <i><device></i> function <i><func></i> . |
| | Details | Either the BIOS, BMC/iDRAC, LOM, or NIC firmware is out of date and does not support FlexAddress. |
| | Action | Update BIOS, BMC/iDRAC, LOM, and mezzanine card firmware. If the issue persists, see Getting Help . |
| PCI3004 | Message | Device option ROM on mezzanine card <i><number></i> failed to support Link Tuning or FlexAddress. |
| | Details | Either the BIOS, BMC/iDRAC, or mezzanine card firmware is out of date and does not support FlexAddress. |
| | Action | Update BIOS, BMC/iDRAC, and mezzanine card firmware. If the issue persists, see Getting Help . |
| PCI3006 | Message | Failed to get Link Tuning or FlexAddress data from iDRAC. |
| | Details | Either the BIOS or BMC/iDRAC firmware is out of date and does not support FlexAddress. |
| | Action | Update BIOS, and BMC/iDRAC firmware. If the issue persists, see Getting Help . |
| PCI3008 | Message | A non-fatal PCIe error detected on a component at bus <i><bus></i> device <i><device></i> function <i><func></i> . |
| | Details | System performance may be degraded. |
| | Action | Cycle input power, update component drivers, remove and reinstall the device at the next service window. |

Error Code Message Information

| | | |
|---------|--------------------|--|
| PCI3010 | Message | A non-fatal IO error detected on a component at bus <i><bus></i> device <i><device></i> function <i><func></i> . |
| | Details | System performance may be degraded. |
| | Action | Cycle input power, update component drivers, remove and reinstall the device at the next service window. |
| PCI3012 | Message | The QuickPath Interconnect (QPI) width degraded. |
| | Details | System performance may be degraded. The bus is not operating at maximum speed or width. |
| | Action | Reset the system, if the problem persists reinstall processors. |
| PCI3014 | Message | A non-fatal PCIe error detected on a component at slot <i><number></i> . |
| | Details | System performance may be degraded. |
| | Action | Cycle input power, update component drivers, remove and reinstall the device at the next scheduled service time. |
| PDR0001 | Message | Fault detected on drive <i><number></i> . |
| | LCD Message | Fault detected on drive <i><number></i> . Check drive. |
| | Details | The controller detected a failure on the disk and has taken the disk offline. |
| | Action | Remove and re-seat the failed disk. If the issue persists, see Getting Help . |
| PDR0002 | Message | A predictive failure detected on drive <i><number></i> . |
| | Details | The controller received a SMART error from the drive. The drive is operational but needs replacement. |
| | Action | The drive will need replacement at the next service window. |
| PDR0016 | Message | Drive <i><number></i> is removed. |
| | LCD Message | Drive <i><number></i> is removed. Check drive. |
| | Details | The controller detected a drive removal. |
| | Action | If unintended, verify drive installation. Remove and re-seat the indicated disk. If the issue persists, see Getting Help . |
| PDR1001 | Message | Fault detected on drive <i><number></i> in disk drive bay <i><bay></i> . |
| | LCD Message | Fault detected on drive <i><number></i> in disk drive bay <i><bay></i> . Check drive. |
| | Details | The controller detected a failure on the disk and has taken the disk offline. |
| | Action | Re-seat the failed drive. If the issue persists, see Getting Help . |
| PDR1002 | Message | A predictive failure detected on drive <i><number></i> in disk drive bay <i><bay></i> . |

Error Code Message Information

Details The controller received a SMART error from the drive. The drive is operational but needs replacement.

Action The drive will need replacement at the next service window.

PDR1016

Message Drive <number> is removed from disk drive bay <bay>.

LCD Message Drive <number> removed from disk drive bay <bay>. Check drive.

Details The controller detected that the drive was removed.

Action Verify drive installation. Re-seat the failed drive. If the issue persists, see [Getting Help](#).

PDR1024

Message Drive mismatch detected for drive <number> in disk drive bay <bay>.

LCD Message Drive mismatch detected for drive <number> in bay <bay>. Install correct drive type.

Details The installed disk does not meet the array requirements, for example a SATA disk may not operate in an array containing SAS drives.

Action Verify that the disk meets the array requirements.

PST0128

Message No memory is detected.

LCD Message No memory is detected. Inspect memory devices.

Details System BIOS was unable to detect memory in the system .

Action Re-seat the memory modules. If the issue persists, see [Getting Help](#).

PST0129

Message Memory is detected, but is not configurable.

LCD Message Memory is detected, but is not configurable. Check memory devices.

Details System BIOS detected memory, but was unable to configure the memory for system operation.

Action Compare system memory installation to supported system memory configurations.

PST0130

Message Memory is configured, but not usable.

LCD Message Memory is configured, but not usable. Check memory devices

Details The system BIOS encountered device failures or speed configurations that resulted in unused memory.

Action Re-seat the memory modules. If the issue persists, see [Getting Help](#).

PST0131

Message System BIOS shadow failed.

LCD Message System BIOS shadow failed. Check memory devices.

Details Memory errors occurred copying BIOS image into system memory.

Error Code Message Information

| | | |
|---------|--------------------|---|
| | Action | Remove input power. Reduce system memory to minimum configuration and apply input power. |
| PST0132 | Message | CMOS failed. |
| | LCD Message | CMOS failed. Power cycle system. |
| | Details | System BIOS detected a failure with CMOS memory during system POST. |
| | Action | Check system event log for CMOS battery exceptions. Remove and reapply input power. If the issue persists, see Getting Help . |
| PST0133 | Message | DMA controller failed. |
| | LCD Message | DMA controller failed. Power cycle system. |
| | Details | System BIOS detected a failure with the DMA controller during system POST. |
| | Action | Remove and reapply input power. |
| PST0134 | Message | Interrupt controller failed. |
| | LCD Message | Interrupt controller failed. Power cycle system. |
| | Details | System BIOS detected a failure with the interrupt controller during system POST. |
| | Action | Remove and reapply input power. If the issue persists, see Getting Help . |
| PST0135 | Message | Timer refresh failed. |
| | LCD Message | Timer refresh failed. Power cycle system.. |
| | Details | System BIOS detected a timer refresh failure during system POST. |
| | Action | Remove and reapply input power. If the issue persists, see Getting Help . |
| PST0136 | Message | Programmable interval timer error. |
| | LCD Message | Programmable interval timer error. Power cycle system. |
| | Details | System BIOS detected an failure with the programmable interval timer during POST. |
| | Action | Remove and reapply input power. If the issue persists, see Getting Help . |
| PST0137 | Message | Parity error. |
| | LCD Message | Parity error. Power cycle system. |
| | Details | System BIOS detected a parity error during post. |
| | Action | Remove and reapply input power. If the issue persists, see Getting Help . |
| PST0138 | Message | SuperIO failed. |
| | LCD Message | SuperIO failure. Power cycle system. |

Error Code Message Information

| | | |
|----------------|--------------------|---|
| | Details | System BIOS detected a failure with the SIO. |
| | Action | Remove and reapply input power. If the issue persists, see Getting Help . |
| PST0139 | Message | Keyboard controller failed. |
| | LCD Message | Keyboard controller failed. Power cycle system. |
| | Details | System BIOS detected a failure with the Keyboard Controller. |
| | Action | Remove and reapply input power. If the issue persists, see Getting Help . |
| PST0140 | Message | System management interrupt initialization failed. |
| | LCD Message | SMI initialization failed. Power cycle system. |
| | Details | System BIOS failed to initialize the system management interrupt. |
| | Action | Remove and reapply input power. If the issue persists, see Getting Help . |
| PST0141 | Message | QuickPath Interconnect (QPI) fatal error. |
| | LCD Message | QuickPath Interconnect (QPI) fatal error. |
| | Details | Quick Path Interconnect failed during system POST. |
| | Action | Reboot the system. If problem persists, remove input power and re-seat processors. |
| PST0142 | Message | MRC fatal error. |
| | LCD Message | Memory initialization error. |
| | Details | BIOS Memory testing failed. |
| | Action | Compare system memory installation to supported system memory configurations. Reduce system configuration to minimum memory configuration. |
| PST0143 | Message | Intel Trusted Execution Technology (TXT) fatal error. |
| | LCD Message | Intel Trusted Execution Technology (TXT) fatal error. |
| | Details | TXT boot failed. This could be related to memory errors or an error with the system TXT configuration. A socketed TPM module may have been removed. |
| | Action | Check TPM presence. Remove and reapply input power. If the issue persists, see Getting Help . |
| PST0192 | Message | Shut-down test failed. |
| | LCD Message | Shut-down test failed. Power cycle system. |
| | Details | System BIOS shutdown test failed during POST. |
| | Action | Check system event log for CMOS battery exceptions. Remove and reapply input power. If the issue persists, see Getting Help . |

Error Code Message Information

| | | |
|---------|--------------------|---|
| PST0193 | Message | BIOS POST memory test failed. |
| | LCD Message | BIOS POST memory test failed. Check memory devices. |
| | Details | System BIOS POST memory test failed. |
| | Action | Compare system memory installation to supported system memory configurations. Reduce system configuration to minimum memory configuration. |
| PST0194 | Message | Remote access controller configuration failed. |
| | LCD Message | Remote access controller configuration failed. Check screen message. |
| | Details | System BIOS could not configure the Remote Access controller. |
| | Action | Cycle input power and power on the system. If the issue persists, see Getting Help . |
| PST0195 | Message | CPU configuration failed. |
| | LCD Message | CPU configuration failed. Check screen message. |
| | Details | The current processor configuration is unsupported or encountered a fatal exception during POST. |
| | Action | Review system processor configuration and reduce the system to the minimum configuration. |
| PST0196 | Message | Incorrect memory configuration. |
| | LCD Message | Incorrect memory configuration. Review User Guide. |
| | Details | System BIOS detected an invalid memory population. |
| | Action | Reinstall memory to match supported memory configuration. |
| PST0254 | Message | General failure after video. |
| | LCD Message | General failure after video. Check screen message. |
| | Details | System BIOS detected a functional or configuration issue during system POST. |
| | Action | Check system video and review event log for additional information. |
| PST0256 | Message | POST fatal error detected. |
| | LCD Message | POST fatal error detected. |
| | Details | System BIOS detected a functional or configuration issue during system POST. |
| | Action | Check system video and review event log for additional information. |
| PSU0001 | Message | Power supply <number> failed. |
| | LCD Message | PSU <number> failed. Check PSU. |
| | Action | Remove and reinstall the power supply. If the issue persists, see Getting Help . |

Error Code Message Information

| | | |
|----------------|--------------------|---|
| PSU0002 | Message | A predictive failure detected on power supply <number>. |
| | LCD Message | Predictive failure on PSU <number>. Check PSU. |
| | Details | System performance and power redundancy may be degraded or lost. |
| | Action | Remove and reinstall the power supply at the next service window. If the issue persists, see Getting Help . |
| PSU0003 | Message | The power input for power supply <number> is lost. |
| | LCD Message | Power input for PSU <number> is lost. Check PSU cables. |
| | Details | The power supply is installed correctly but an input source is not connected or is not functional. |
| | Action | Verify the input source is attached to the power supply. Verify the input power is within the operating requirements for the power supply. |
| PSU0004 | Message | The power input for power supply <number> is outside of the allowable range. |
| | LCD Message | Power input for PSU <number> is outside of range. Check PSU cables. |
| | Details | The operating requirements for the power supply may be found in this manual or on the power supply itself. |
| | Action | Verify the input source is attached to the power supply. Verify the input power is within the operating requirements for the power supply. |
| PSU0005 | Message | The power input for power supply <number> is outside of the allowable range, but it is attached to the system. |
| | Details | The operating requirements for the power supply may be found in this manual or on the power supply itself. |
| | Action | Verify the input power is within the operating requirements for the power supply. |
| PSU0006 | Message | Power supply <number> type mismatch. |
| | LCD Message | Power supply <number> is incorrectly configured. Check PSU. |
| | Details | Power supplies should be of the same input type and power rating. |
| | Action | Install matched power supplies and review proper configuration in this manual. |
| PSU0007 | Message | Power supply <number> is operating at 110 volts, and could cause a circuit breaker fault. |
| | Details | A power supply that is designed to operate at 220V, but is connected to a 110V power source requires additional current for operation. The additional current may trip circuit-breakers or cause other electrical issues with the input source. |
| | Action | Check input power source and cabling. Use recommended input power. Review this Manual. If the issue persists, see Getting Help . |

Error Code Message Information

| | | |
|---------|--------------------|--|
| PSU0008 | Message | Power supply <number> voltage rating does not match the system's requirements. |
| | Details | The system does not support mixed voltage power supplies. |
| | Action | Install a power supply with the correct voltage rating. |
| PSU0016 | Message | Power supply <number> is absent. |
| | LCD Message | PSU <number> is absent. Check PSU. |
| | Details | The supply has been removed or has failed. |
| | Action | <ol style="list-style-type: none">1. Remove and reinstall the power supply.2. Check cables and subsystem components in the system for damage.3. If the issue persists, see Getting Help. |
| PSU0031 | Message | Cannot communicate with power supply <number>. |
| | LCD Message | Cannot communicate with PSU <number>. Re-seat PSU. |
| | Details | The power supply may operate, however power supply monitoring will be degraded. System performance may be degraded. |
| | Action | Remove and reinstall the power supply. If the issue persists, see Getting Help . |
| PSU1201 | Message | Power supply redundancy is lost. |
| | Details | The power supply will try to operate in a degraded state. System Performance and power redundancy may be degraded or lost. |
| | Action | Check input power. Reinstall the power supply. If the issue persists, see Getting Help . |
| PSU1202 | Message | Power supply redundancy is degraded. |
| | Details | The power supply will try to operate in a degraded state. System Performance and power redundancy may be degraded or lost. |
| | Action | Remove input power and reinstall supply at the next service window. |
| PSU1203 | Message | The power supplies are not redundant. |
| | LCD Message | Lost PSU redundancy. Check PSU cables. |
| | Details | The current power operational mode is non-redundant because of a power supply exception, a power supply inventory change, or a system power inventory change. |
| | Action | Check the event log for power supply failures. Review system configuration and power consumption. |
| PSU1204 | Message | The power supplies are not redundant. Insufficient resources to maintain normal operations. |
| | LCD Message | PSU redundancy degraded. Check PSU cables. |

Error Code Message Information

| | | |
|----------------|--------------------|---|
| | Details | The current power operational mode is non-redundant because of a power supply exception, a power supply inventory change, or a system power inventory change. |
| | Action | Check the event log for power supply failures. Review system configuration and power consumption. |
| PWR1001 | Message | The system performance was degraded. |
| | LCD Message | System performance degraded. Check PSUs and system configuration. |
| | Details | To avoid shutdown, system performance has been degraded. |
| | Action | Review system configuration and system logs for thermal or environmental failures and warnings. |
| PWR1002 | Message | The system performance degraded because of thermal protection. |
| | Details | To avoid shutdown, system performance has been degraded. |
| | Action | Review system configuration and system logs for thermal or environmental failures and warnings. |
| PWR1003 | Message | The system performance degraded because cooling capacity has changed. |
| | Details | The current power supply configuration does not meet the platform requirements to enable redundancy. If a power supply fails the system may shutdown. |
| | Action | If unintended, review system configuration and power consumption and install power supplies accordingly. Check power supply status for failures. |
| PWR1004 | Message | The system performance degraded because power capacity has changed. |
| | Details | The system may power down or operate in a performance degraded state. |
| | Action | Check the event log for power supply failures. Review system configuration and power consumption and upgrade or install power supplies accordingly. |
| PWR1005 | Message | The system performance degraded because the user-defined power capacity has changed. |
| | Details | The user-defined power settings have affected system operation. |
| | Action | If unintended, review system configuration changes and power policy. |
| PWR1006 | Message | The system halted because system power exceeds capacity. |
| | LCD Message | System power demand exceeds capacity. System halted. |
| | Details | The system halted because system power exceeds capacity. |
| | Action | Review system configuration, upgrade power supplies or reduce system power consumption. |
| PWR1007 | Message | The system performance degraded because power exceeds capacity. |

Error Code Message Information

| | | |
|----------------|--------------------|--|
| | LCD Message | System power exceeds capacity. Performance degraded. Check PSU configuration. |
| | Details | The system is currently operating in a performance degraded state to attempt protect from a power shutdown. |
| | Action | Review system configuration, upgrade power supplies or reduce system power consumption. |
| PWR1008 | Message | The system performance degraded because power draw exceeds the power threshold. |
| | LCD Message | System power exceeds threshold. Performance degraded. Check PSU configuration. |
| | Details | The power threshold is configured by the user or automatically by software based on system configuration. |
| | Action | Review system configuration, upgrade power supplies or reduce system power consumption. |
| RFM1003 | Message | Removable Flash Media <name> is not IPMI-function ready. |
| | Details | The removable flash media is installed but improperly configured or failed to initialize. |
| | Action | If unintended, reinstall the flash media and module. |
| RFM1005 | Message | Removable Flash Media <name> is not ready. |
| | Details | The media is being prepared or is under maintenance. If the problem persists, reinstall the card. |
| | Action | Wait for the media to be ready. |
| RFM1006 | Message | Removable Flash Media <name> is offline. |
| | Details | At boot, the Card Identification (CID) signature of the card is different from the Non-volatile (NV) storage value or the card is the destination of a copy operation that is in-progress. |
| | Action | If unintended, reinstall the flash media. |
| RFM1008 | Message | Failure detected on Removable Flash Media <name>. |
| | LCD Message | Removable Flash Media <name> failed. Check SD Card. |
| | Details | An error was reported during a SD card read or write. |
| | Action | Reseat the flash media, if the issue persists replace the media. |
| RFM1014 | Message | Removable Flash Media <name> is write protected. |
| | LCD Message | Removable Flash Media <name> is write protected. Check SD Card. |
| | Details | The card is write-protected by the physical latch on the SD card. A write-protected card cannot be used. |
| | Action | If unintended, remove the media and disable write protection. |

Error Code Message Information

| | | |
|----------------|--------------------|--|
| RFM1016 | Message | Media not present for Removable Flash Media <name>. |
| | Details | The SD card is not detected or not installed. |
| | Action | If unintended, reinstall the flash media. |
| RFM1021 | Message | Removable Flash Media is not IPMI-function ready. |
| | Details | The removable flash media is installed but improperly configured or failed to initialize. |
| | Action | If unintended, reinstall the flash media. |
| RFM1022 | Message | Removable Flash Media is ready. |
| | Action | If unintended, reinstall the flash media. |
| RFM1023 | Message | Removable Flash Media is not ready. |
| | Details | The media is being prepared or is under maintenance. If the problem persists, reinstall the card. |
| | Action | If unintended, reinstall the flash media. |
| RFM1024 | Message | Removable Flash Media is offline. |
| | Details | At boot, the Card Identification (CID) signature of the card is different from the Non-volatile (NV) storage value or the card is the destination of a copy operation that is in-progress. |
| | Action | If unintended, reinstall the flash media. |
| RFM1026 | Message | Failure detected on Removable Flash Media. |
| | Details | An error is reported during a SD card read or write. |
| | Action | Reinstall the flash media, if the issue persists replace the media. |
| RFM1032 | Message | Removable Flash Media is write protected. |
| | Details | The card is write-protected by the physical latch on the SD card. IDSDM cannot use a write-protected card. |
| | Action | If unintended, remove the media and disable write protection. |
| RFM1034 | Message | Media not present for Removable Flash Media. |
| | Details | The SD card is not detected or not installed. |
| | Action | If unintended, reinstall the flash media. |
| RFM1201 | Message | Internal Dual SD Module redundancy is lost. |
| | LCD Message | Internal Dual SD Module redundancy is lost. Check SD Card. |
| | Details | Either one of the SD card or both the SD cards are not functioning properly. |

Error Code Message Information

| | | |
|---------|--------------------|---|
| | Action | Replace the failed SD card. |
| RFM1202 | Message | Internal Dual SD Module redundancy is degraded. |
| | Details | Either one of the SD card or both the SD cards are not functioning properly. |
| | Action | Replace the failed SD card. |
| RFM1203 | Message | Internal Dual SD Module is not redundant. |
| | Details | Internal Dual SD Module is not redundant. |
| | Action | Install additional SD card and configure for redundancy if redundancy is desired. |
| RFM1205 | Message | Internal Dual SD Module is not redundant. Insufficient resources to maintain normal operations. |
| | LCD Message | Internal Dual SD Module is not redundant. Insufficient resources. Check SD Card. |
| | Details | The current operating configuration cannot maintain redundancy. The unit may operate in a degraded state. |
| | Action | Review this manual and SD card configuration. |
| RFM2001 | Message | Internal Dual SD Module <name> is absent. |
| | LCD Message | Internal Dual SD Module <name> is absent. Check SD Card. |
| | Details | The SD card module is not detected or not installed. |
| | Action | If unintended, reinstall the SD module. |
| RFM2002 | Message | Internal Dual SD Module <name> is offline. |
| | Details | The SD card module is installed but may be improperly installed or configured incorrectly. |
| | Action | Reinstall the SD module. |
| RFM2004 | Message | Failure detected on Internal Dual SD Module <name>. |
| | LCD Message | Internal Dual SD Module <name> failed. Check SD Card. |
| | Details | The SD card module is installed but improperly configured or failed to initialize. |
| | Action | Reinstall the SD module and remove and reinstall SD cards. |
| RFM2006 | Message | Internal Dual SD Module <name> is write protected. |
| | Details | The module is write-protected. Changes may not be written to the media. |
| | Action | If unintended, remove the media and disable write protection. |
| SEC0000 | Message | The chassis is open. |

Error Code Message Information

| | | |
|----------------|--------------------|--|
| | LCD Message | Intrusion detected. Check chassis cover. |
| | Details | The chassis is open. System performance may be degraded, and security may be compromised. |
| | Action | Close the chassis. Check system logs. |
| SEC0001 | Message | The drive bay is open. |
| | Details | The drive bay is open. A drive may be added or removed. System performance may be degraded. |
| | Action | Close the drive bay. Check system logs. |
| SEC0002 | Message | The I/O card area is open. |
| | Details | The I/O card area is open. I/O cards may be added or removed. System performance may be degraded. |
| | Action | Close the I/O card area. Check system logs. |
| SEC0003 | Message | The processor area is open. |
| | Details | The processor area is open. A drive may be added or removed. System performance may be degraded. |
| | Action | Close the processor area. Check system logs. |
| SEC0004 | Message | The LAN is disconnected. |
| | Details | The LAN is disconnected. Network performance may be degraded. |
| | Action | If unintentional, connect network cable. |
| SEC0005 | Message | Unauthorized docking is detected. |
| | Details | A removable component may have been tampered with, or installed incorrectly, or does not meet system requirements. |
| | Action | Check removable hardware components for correct installation. Review installation documentation. |
| SEC0006 | Message | The fan area is open. |
| | Details | The fan area is open. System performance may be degraded. |
| | Action | Close the fan area. Check system logs. |
| SEC0031 | Message | The chassis is open while the power is on. |
| | LCD Message | Intrusion detected. Check chassis cover. |

Error Code Message Information

| | | |
|----------------|--------------------|--|
| | Details | The chassis is open. System performance may be degraded, and security may be compromised. |
| | Action | Close the chassis. Check system logs. |
| SEC0033 | Message | The chassis is open while the power is off. |
| | LCD Message | Intrusion detected. Check chassis cover. |
| | Details | The chassis was opened while the power was off. System security may have been comprised. |
| | Action | Close the chassis and verify hardware inventory. Check system logs. |
| SEC0040 | Message | A critical stop occurred during OS load. |
| | Details | Operating system generated critical stop IPMI event. (Sensor type code = 20H) |
| | Action | Check video and operating system logs for additional information |
| SEC0041 | Message | BIOS detected an error configuring the Intel Trusted Execution Technology (TXT). |
| | LCD Message | BIOS detected an error configuring TXT. Check system configuration. |
| | Details | TXT initialization failure. System configuration may have changed. |
| | Action | Check system hardware inventory and software configuration. |
| SEC0042 | Message | Processor detected an error while performing an Intel Trusted Execution Technology (TXT) operation. |
| | LCD Message | CPU detected an error while performing a TXT operation. Check system configuration. |
| | Details | TXT CPU microcode boot failure. System configuration may have changed. |
| | Action | Check system hardware inventory and software configuration. |
| SEC0043 | Message | BIOS Authenticated Code Module detected an Intel Trusted Execution Technology (TXT) error during POST. |
| | LCD Message | BIOS detected a TXT error during POST. Check system configuration. |
| | Details | TXT Post failure. System configuration may have changed. |
| | Action | Check system hardware inventory and software configuration. |
| SEC0044 | Message | SINIT Authenticated Code Module detected an Intel Trusted Execution Technology (TXT) error at boot. |
| | LCD Message | SINIT detected a TXT error at boot. Check system configuration. |
| | Details | TXT initialization failure. System configuration may have changed. |
| | Action | Check system hardware inventory and software configuration. |

Error Code Message Information

| | | |
|----------------|----------------|--|
| SEC0600 | Message | A secure mode violation detected. |
| | Details | This may apply to a physical or remote access attempt. |
| | Action | Check system logs for intrusion attempts, and ensure strong password policies. |
| SEC0602 | Message | User password violation detected. |
| | Details | This may apply to a physical or remote access attempt. |
| | Action | Check system logs for intrusion attempts, and ensure strong password policies. |
| SEC0604 | Message | A setup password violation detected. |
| | Details | This may apply to a physical or remote access attempt. |
| | Action | Check system logs for intrusion attempts, and ensure strong password policies. |
| SEC0606 | Message | The network boot password violation detected. |
| | Details | This may apply to a physical or remote access attempt. |
| | Action | Check system logs for intrusion attempts, and ensure strong password policies. |
| SEC0608 | Message | A password violation detected. |
| | Details | This may apply to a physical or remote access attempt. |
| | Action | Check system logs for intrusion attempts, and ensure strong password policies. |
| SEC0610 | Message | An Out-of-band password violation detected. |
| | Details | This may apply to a remote access attempt. |
| | Action | Check system logs for intrusion attempts, and ensure strong password policies. |
| SEL0002 | Message | Logging is disabled. |
| | Details | This message is displayed when event logging of a specific type is disabled by the user. |
| | Action | If unintended, re-enable logging. |
| SEL0006 | Message | All event logging is disabled. |
| | Details | This message is displayed when all event logging has been disabled by the user. |
| | Action | If unintended, re-enable logging. |
| SEL0008 | Message | Log is full. |
| | Details | When the event log is full, additional events are not written to the log. Older events may be overwritten and lost. This message may also appear if the user disabled event logging. |
| | Action | Backup and clear log. |

Error Code Message Information

| | | |
|---------|--------------------|---|
| SEL0010 | Message | Log is almost full. |
| | Details | When the event log is full, additional events are not written to the log. Older events may be overwritten and lost. |
| | Action | Backup and clear log at the next maintained time. |
| SEL0012 | Message | Could not create or initialize the system event log. |
| | Details | If the system event log fails to initialize, platform status and failure events are not captured. Some management software do not report platform exceptions. |
| | Action | Reboot the management controller or iDRAC. Cycle system input power. If problem persists call support. |
| SEL1204 | Message | An unknown system hardware failure detected. |
| | LCD Message | Unknown system hardware failure. |
| | Details | If the system event log failed to initialize platform status and failure events are not captured. Some management software will not report platform exceptions. |
| | Action | Re-configure system to minimum supported configuration. If issues persists, contact support. |
| SEL1209 | Message | The platform event filter action failed. |
| | Details | System policies or permissions may prevent the action from executing. If configured, the system does not execute the action on a platform event (such as power down, cycle, interrupt, and send alert). |
| | Action | Review platform event configuration. |
| SEL1211 | Message | The time-stamp clock could not be synchronized. |
| | Details | The time stamp on system event log events may not correlate to the system time. |
| | Action | Cycle system input power. If problem persists, contact support. |
| SEL1300 | Message | No bootable media found. |
| | Details | System setup displays the system boot order. The local video screen may also show additional information. (IPMI sensor type code 1eh - offset 00h). |
| | Action | Check system boot settings. Check if mass storage controller configuration settings are applicable. |
| SEL1302 | Message | Non-bootable diskette detected. |
| | Details | The disk in the drive is not formatted correctly or does not contain the necessary operating system files. |
| | Action | Replace diskette with a bootable disk. |

Error Code Message Information

| | | |
|---------|----------------|---|
| SEL1304 | Message | The PXE server not found. |
| | Details | PXE is one way to boot a system from the network. |
| | Action | Check the network and PXE server configuration. |
| SEL1306 | Message | Invalid boot sector found. |
| | Details | The disk in the drive is not formatted correctly or does not contain the necessary operating system files. |
| | Action | Replace diskette with a bootable disk. |
| SEL1308 | Message | A time-out occurred while waiting for user to select a boot source. |
| | Details | The system has failed to boot to an operating system and needs the user to select a boot source. |
| | Action | Select boot source within the time allowed. |
| SEL1501 | Message | Chassis management controller (CMC) redundancy is lost. |
| | Details | An action or failure has taken place that breaks CMC redundancy. |
| | Action | Check the CMC network cables and network connections. Check that CMC firmware versions match. |
| SEL1502 | Message | Chassis management controller (CMC) redundancy is degraded. |
| | Details | An action or failure has taken place that breaks CMC redundancy. |
| | Action | Check the CMC network cables and network connections. Check that CMC firmware versions match. |
| SEL1504 | Message | The chassis management controller (CMC) is not redundant. Insufficient resources to maintain normal operations. |
| | Details | There is not enough available power for two CMC's to operate. |
| | Action | Check the overall power consumption and power status. |
| SEL1506 | Message | Lost communications with Chassis Group Member <number>. |
| | Details | The primary CMC has lost communication with the indicated member CMC. |
| | Action | Check the network cable and network connections. |
| SEL1508 | Message | Member <number> could not join the Chassis Group. |
| | Details | The indicated member CMC is a leader of a different CMC stacking group. |
| | Action | Check if member CMC is a leader of a different chassis group. |

Error Code Message Information

| | | |
|---------|--------------------|---|
| SEL1510 | Message | An authentication error detected for Chassis Group Member <number>. |
| | Details | Group master CMC could not log into the group member CMC. |
| | Action | Check the login credentials of CMC. |
| SEL9900 | Message | An unsupported event occurred. |
| | Details | The current software version cannot decode this event. You may need to review this event using a tool which displays raw data such as Ipmitool with the -vvv option or Racadm with the -E option. |
| | Action | Upgrade the management software. |
| SWC4004 | Message | A firmware or software incompatibility detected between iDRAC in slot <number> and CMC. |
| | Details | FlexAddress is not implemented in one of the versions of firmware. |
| | Action | Check the firmware versions of iDRAC and CMC. Update with the latest version. |
| SWC4006 | Message | A firmware or software incompatibility detected between system BIOS in slot <number> and CMC. |
| | Details | FlexAddress is not implemented in one of the versions of firmware. |
| | Action | Check the firmware versions of BIOS and CMC. Update with the latest version. |
| SWC4008 | Message | A firmware or software incompatibility detected between CMC 1 and CMC 2. |
| | Details | FlexAddress is not implemented in one of the versions of firmware. Please update the firmware. |
| | Action | Check firmware versions. Update CMC 1 and CMC 2 firmware to match. |
| SWC5001 | Message | <name> upgrade failed. |
| | Action | Reboot the system and attempt the upgrade again. |
| TMP0100 | Message | The system board <name> temperature is less than the lower warning threshold. |
| | LCD Message | System board <name> temperature is outside of range. |
| | Details | Ambient air temperature is too cool. |
| | Action | Check the system operating environment. |
| TMP0101 | Message | The system board <name> temperature is less than the lower critical threshold. |
| | LCD Message | System board <name> temperature is outside of range. |
| | Details | Ambient air temperature is too cool. |
| | Action | Check the system operating environment. |

Error Code Message Information

| | | |
|----------------|--------------------|--|
| TMP0102 | Message | The system board <name> temperature is greater than the upper warning threshold |
| | LCD Message | System board <name> temperature is outside of range. |
| | Details | Ambient air temperature is too warm or one or more fans may have failed. |
| | Action | The system board <name> temperature is outside of the optimum range. Check the fans. |
| TMP0103 | Message | The system board <name> temperature is greater than the upper critical threshold. |
| | LCD Message | System board <name> temperature is outside of range. |
| | Details | Ambient air temperature is too warm or one or more fans may have failed. |
| | Action | The system board <name> temperature is outside of the optimum range. Check the fans. |
| TMP0104 | Message | The system board <name> temperature is outside of range. |
| | LCD Message | System board <name> temperature is outside of range. |
| | Details | Ambient air temperature is too warm or cool. |
| | Action | The system board <name> temperature is outside of the optimum range. Check Fans. |
| TMP0106 | Message | The memory module <number> temperature is less than the lower warning threshold. |
| | LCD Message | Memory module <number> temperature is outside of range. |
| | Details | Ambient air temperature is too cool. |
| | Action | Check the system operating environment. |
| TMP0107 | Message | The memory module <number> temperature is less than the lower critical threshold. |
| | LCD Message | Memory module <number> temperature is outside of range. |
| | Details | Ambient air temperature is too cool. |
| | Action | Check the system operating environment. |
| TMP0108 | Message | The memory module <number> temperature is greater than the upper warning threshold. |
| | LCD Message | Memory module <number> temperature is outside of range. Check Fans. |
| | Details | Ambient air temperature is too warm or one or more fans may have failed. |
| | Action | The system board <name> temperature is outside of the optimum range. Check Fans. |
| TMP0109 | Message | The memory module <number> temperature is greater than the upper critical threshold. |
| | LCD Message | Memory module <number> temperature is outside of range. Check Fans. |
| | Details | Ambient air temperature is too warm or one or more fans may have failed. |

Error Code Message Information

| | | |
|---------|--------------------|---|
| | Action | The system board <i><name></i> temperature is outside of the optimum range. Check Fans. |
| TMP0110 | Message | The memory module <i><number></i> temperature is outside of range. |
| | LCD Message | Memory module <i><number></i> temperature is outside of range. Check Fans. |
| | Details | Ambient air temperature is too warm or cool. |
| | Action | Check the system operating environment. |
| TMP0112 | Message | The <i><name></i> temperature is less than the lower warning threshold. |
| | LCD Message | The <i><name></i> temperature is outside of range. |
| | Details | Ambient air temperature is too cool. |
| | Action | Check the system operating environment. |
| TMP0113 | Message | The <i><name></i> temperature is less than the lower critical threshold. |
| | LCD Message | The <i><name></i> temperature is outside of range. |
| | Details | Ambient air temperature is too cool. |
| | Action | Check the system operating environment. |
| TMP0114 | Message | The <i><name></i> temperature is greater than the upper warning threshold. |
| | LCD Message | The <i><name></i> temperature is outside of range. Check Fans |
| | Details | Ambient air temperature is too warm or one or more fans may have failed. |
| | Action | Check the system operating environment and review event log for fan failures. |
| TMP0115 | Message | The <i><name></i> temperature is greater than the upper critical threshold. |
| | LCD Message | The <i><name></i> temperature is outside of range. Check Fans |
| | Details | Ambient air temperature is too warm or one or more fans may have failed. |
| | Action | Check the system operating environment and review event log for fan failures. |
| TMP0116 | Message | The <i><name></i> temperature is outside of range. |
| | LCD Message | The <i><name></i> temperature is outside of range. Check Fans |
| | Action | Check the system operating environment and review event log for fan failures. |
| TMP0118 | Message | The system inlet temperature is less than the lower warning threshold. |
| | LCD Message | System inlet temperature is outside of range. |
| | Details | Ambient air temperature is too cool. |
| | Action | Check the system operating environment. |

Error Code Message Information

| | | |
|----------------|--------------------|---|
| TMP0119 | Message | The system inlet temperature is less than the lower critical threshold. |
| | LCD Message | System inlet temperature is outside of range. |
| | Details | Ambient air temperature is too cool. |
| | Action | Check the system operating environment. |
| TMP0120 | Message | The system inlet temperature is greater than the upper warning threshold. |
| | LCD Message | System inlet temperature is outside of range. |
| | Details | Ambient air temperature is too warm or one or more fans may have failed. |
| | Action | Check the system operating environment and review event log for fan failures. |
| TMP0121 | Message | The system inlet temperature is greater than the upper critical threshold. |
| | LCD Message | System inlet <name> temperature is outside of range. Check Fans. |
| | Details | Ambient air temperature is too warm or one or more fans may have failed. |
| | Action | Check the system operating environment and review event log for fan failures. |
| TMP0122 | Message | The system inlet temperature is outside of range. |
| | LCD Message | System inlet <name> temperature is outside of range. Check Fans. |
| | Details | Ambient air temperature is too warm or cool. |
| | Action | Check the system operating environment and review event log for fan failures. |
| TMP0100 | Message | Disk drive bay temperature is less than the lower warning threshold. |
| | Details | Ambient air temperature is too cool. |
| | Action | Check the system operating environment. |
| TMP0104 | Message | Disk drive bay temperature is less than the lower critical threshold. |
| | LCD Message | Disk drive bay temperature is outside of range. Check Fans. |
| | Details | Ambient air temperature is too cool. |
| | Action | Check the system operating environment. |
| TMP0126 | Message | Disk drive bay temperature is greater than the upper warning threshold. |
| | LCD Message | Disk drive bay temperature is outside of range. Check Fans. |
| | Details | Ambient air temperature is too warm or one or more fans may have failed. |
| | Action | Check the system operating environment and review event log for fan failures. |
| TMP0128 | Message | Disk drive bay temperature is outside of the allowable range. |

Error Code Message Information

| | | |
|----------------|--------------------|--|
| | LCD Message | Disk drive bay temperature is outside of range. Check Fans. |
| | Details | Ambient air temperature is too warm or cool. |
| | Action | Check the system operating environment and review event log for fan failures. |
| TMP0130 | Message | The control panel temperature is less than the lower warning threshold. |
| | LCD Message | Control panel temperature is outside of range. |
| | Details | Ambient air temperature is too cool. |
| | Action | Check the system operating environment. |
| TMP0132 | Message | The control panel temperature is greater than the upper warning threshold. |
| | LCD Message | Control panel temperature is outside of range. |
| | Details | Ambient air temperature is too warm or one or more fans may have failed. |
| | Action | Check the system operating environment and review event log for fan failures. |
| TMP0134 | Message | The control panel temperature is outside of the allowable range. |
| | LCD Message | Control panel temperature is outside of range. |
| | Details | Ambient air temperature is too warm or cool. |
| | Action | Check the system operating environment and review event log for fan failures. |
| VLT0100 | Message | Processor module <name> voltage is less than the lower warning threshold. |
| | LCD Message | Processor module <name> voltage is outside of range. |
| | Details | System hardware detected an over voltage or under voltage condition. If multiple voltage exceptions occur consecutively the system may power down in fail-safe mode. |
| | Action | <ol style="list-style-type: none">1. Review system logs for power supply exceptions.2. Remove the processor module. Inspect processor socket for bent pins.3. If the issue persists, see Getting Help. |
| VLT0101 | Message | Processor module <name> voltage is less than the lower critical threshold. |
| | LCD Message | Processor module <name> voltage is outside of range. |
| | Details | System hardware detected an over voltage or under voltage condition. If multiple voltage exceptions occur consecutively the system may power down in fail-safe mode. |
| | Action | <ol style="list-style-type: none">1. Review system logs for power supply exceptions.2. Remove the processor module. Inspect processor socket for bent pins. |

Error Code Message Information

3. If the issue persists, see [Getting Help](#).

| | | |
|----------------|--------------------|--|
| VLT0102 | Message | Processor module <i><name></i> voltage is greater than the upper warning threshold. |
| | LCD Message | Processor module <i><name></i> voltage is outside of range. |
| | Details | System hardware detected an over voltage or under voltage condition. If multiple voltage exceptions occur consecutively the system may power down in fail-safe mode. |
| | Action | <ol style="list-style-type: none">1. Review system logs for power supply exceptions.2. Remove the processor module. Inspect processor socket for bent pins.3. If the issue persists, see Getting Help. |
| VLT0103 | Message | Processor module <i><name></i> voltage is greater than the upper critical threshold. |
| | LCD Message | Processor module <i><name></i> voltage is outside of range. |
| | Details | System hardware detected an over voltage or under voltage condition. If multiple voltage exceptions occur consecutively the system may power down in fail-safe mode. |
| | Action | <ol style="list-style-type: none">1. Review system logs for power supply exceptions.2. Remove the processor module. Inspect processor socket for bent pins.3. If the issue persists, see Getting Help. |
| VLT0104 | Message | Processor module <i><name></i> voltage is outside of the allowable range. |
| | LCD Message | Processor module <i><name></i> voltage is outside of range. |
| | Details | System hardware detected an over voltage or under voltage condition. If multiple voltage exceptions occur consecutively the system may power down in fail-safe mode. |
| | Action | <ol style="list-style-type: none">1. Review system logs for power supply exceptions.2. Remove the processor module. Inspect processor socket for bent pins.3. If the issue persists, see Getting Help. |
| VLT0200 | Message | The system board <i><name></i> voltage is less than the lower critical threshold. |
| | LCD Message | System board voltage is outside of range. |
| | Details | System hardware detected an over voltage or under voltage condition. If multiple voltage exceptions occur consecutively the system may power down in fail-safe mode. |
| | Action | <ol style="list-style-type: none">1. Review system logs for power supply exceptions. |

Error Code Message Information

2. Remove the processor module. Inspect processor socket for bent pins.
3. If the issue persists, see [Getting Help](#).

| | | |
|---------|--------------------|--|
| VLT0201 | Message | The system board <i><name></i> voltage is less than the lower warning threshold. |
| | LCD Message | System board voltage is outside of range. |
| | Details | System hardware detected an over voltage or under voltage condition. If multiple voltage exceptions occur consecutively the system may power down in fail-safe mode. |
| | Action | <ol style="list-style-type: none">1. Review system logs for power supply exceptions.2. Re-configure the system to minimum configuration, inspect and reinstall system cables.3. If the issue persists, see Getting Help. |
| VLT0202 | Message | The system board <i><name></i> voltage is greater than the upper warning threshold. |
| | LCD Message | System board voltage is outside of range. |
| | Details | System hardware detected an over voltage or under voltage condition. If multiple voltage exceptions occur consecutively the system may power down in fail-safe mode. |
| | Action | <ol style="list-style-type: none">1. Review system logs for power supply exceptions.2. Re-configure the system to minimum configuration, inspect and reinstall system cables.3. If the issue persists, see Getting Help. |
| VLT0203 | Message | The system board <i><name></i> voltage is greater than the upper critical threshold. |
| | LCD Message | System board voltage is outside of range. |
| | Details | System hardware detected an over voltage or under voltage condition. If multiple voltage exceptions occur consecutively the system may power down in fail-safe mode. |
| | Action | <ol style="list-style-type: none">1. Review system logs for power supply exceptions.2. Re-configure the system to minimum configuration, inspect and reinstall system cables.3. If the issue persists, see Getting Help. |
| VLT0204 | Message | The system board <i><name></i> voltage is outside of the allowable range. |
| | LCD Message | System board voltage is outside of range. |
| | Details | System hardware detected an over voltage or under voltage condition. |

Error Code Message Information

| | | |
|----------------|--------------------|--|
| | | If multiple voltage exceptions occur consecutively the system may power down in fail-safe mode. |
| | Action | <ol style="list-style-type: none">1. Review system logs for power supply exceptions.2. Re-configure the system to minimum configuration, inspect and reinstall system cables.3. If the issue persists, see Getting Help. |
| VLT0206 | Message | The memory module <number> <name> voltage is less than the lower warning threshold. |
| | LCD Message | Memory module <number> <name> voltage is outside of range. |
| | Details | System hardware detected an over voltage or under voltage condition. If multiple voltage exceptions occur consecutively the system may power down in fail-safe mode. |
| | Action | <ol style="list-style-type: none">1. Review system logs for power supply exceptions.2. Re-configure the system to minimum configuration, inspect and reinstall system cables.3. If the issue persists, see Getting Help. |
| VLT0207 | Message | The memory module <number> <name> voltage is less than the lower critical threshold. |
| | LCD Message | Memory module <number> <name> voltage is outside of range. |
| | Details | System hardware detected an over voltage or under voltage condition. If multiple voltage exceptions occur consecutively the system may power down in fail-safe mode. |
| | Action | <ol style="list-style-type: none">1. Review system logs for power supply exceptions.2. Re-configure the system to minimum configuration, inspect and reinstall system cables.3. If the issue persists, see Getting Help. |
| VLT0208 | Message | The memory module <number> <name> voltage is greater than the upper warning threshold. |
| | LCD Message | Memory module <number> <name> voltage is outside of range. |
| | Details | System hardware detected an over voltage or under voltage condition. If multiple voltage exceptions occur consecutively the system may power down in fail-safe mode. |
| | Action | <ol style="list-style-type: none">1. Review system logs for power supply exceptions.2. Re-configure the system to minimum configuration, inspect and reinstall system cables. |

Error Code Message Information

3. If the issue persists, see [Getting Help](#).

| | | |
|---------|--------------------|--|
| VLT0209 | Message | The memory module <i><number></i> <i><name></i> voltage is greater than the upper critical threshold. |
| | LCD Message | Memory module <i><number></i> <i><name></i> voltage is outside of range. |
| | Details | System hardware detected an over voltage or under voltage condition. If multiple voltage exceptions occur consecutively the system may power down in fail-safe mode. |
| | Action | <ol style="list-style-type: none">1. Review system logs for power supply exceptions.2. Re-configure the system to minimum configuration, inspect and reinstall system cables.3. If the issue persists, see Getting Help. |
| VLT0210 | Message | The memory module <i><number></i> <i><name></i> voltage is outside of range. |
| | LCD Message | Memory module <i><number></i> <i><name></i> voltage is outside of range. |
| | Details | System hardware detected an over voltage or under voltage condition. If multiple voltage exceptions occur consecutively the system may power down in fail-safe mode. |
| | Action | <ol style="list-style-type: none">1. Review system logs for power supply exceptions.2. Re-configure the system to minimum configuration, inspect and reinstall system cables.3. If the issue persists, see Getting Help. |
| VLT0212 | Message | The disk drive bay <i><name></i> voltage is less than the lower warning threshold. |
| | LCD Message | The disk drive bay <i><name></i> voltage is outside of range. |
| | Details | System hardware detected an over voltage or under voltage condition. If multiple voltage exceptions occur consecutively the system may power down in fail-safe mode. |
| | Action | <ol style="list-style-type: none">1. Review system logs for power supply exceptions.2. Re-configure the system to minimum configuration, inspect and reinstall system cables.3. If the issue persists, see Getting Help. |
| VLT0213 | Message | The disk drive bay <i><name></i> voltage is less than the lower critical threshold. |
| | LCD Message | The disk drive bay <i><name></i> voltage is outside of range. |
| | Details | System hardware detected an over voltage or under voltage condition. |

Error Code Message Information

| | | |
|----------------|--------------------|--|
| | | If multiple voltage exceptions occur consecutively the system may power down in fail-safe mode. |
| | Action | <ol style="list-style-type: none">1. Review system logs for power supply exceptions.2. Re-configure the system to minimum configuration, inspect and reinstall system cables.3. If the issue persists, see Getting Help. |
| VLT0214 | Message | The disk drive bay <name> voltage is greater than the upper critical threshold. |
| | LCD Message | The disk drive bay <name> voltage is outside of range. |
| | Details | System hardware detected an over voltage or under voltage condition. If multiple voltage exceptions occur consecutively the system may power down in fail-safe mode. |
| | Action | <ol style="list-style-type: none">1. Review system logs for power supply exceptions.2. Re-configure the system to minimum configuration, inspect and reinstall system cables.3. If the issue persists, see Getting Help. |
| VLT0215 | Message | The disk drive bay <name> voltage is greater than the upper critical threshold. |
| | LCD Message | The disk drive bay <name> voltage is outside of range. |
| | Details | System hardware detected an over voltage or under voltage condition. If multiple voltage exceptions occur consecutively the system may power down in fail-safe mode. |
| | Action | <ol style="list-style-type: none">1. Review system logs for power supply exceptions.2. Re-configure the system to minimum configuration, inspect and reinstall system cables.3. If the issue persists, see Getting Help. |
| VLT0216 | Message | The <name> voltage is outside of range. |
| | LCD Message | The <name> voltage is outside of range. |
| | Details | System hardware detected an over voltage or under voltage condition. If multiple voltage exceptions occur consecutively the system may power down in fail-safe mode. |
| | Action | <ol style="list-style-type: none">1. Review system logs for power supply exceptions.2. Re-configure the system to minimum configuration, inspect and reinstall system cables.3. If the issue persists, see Getting Help. |

Error Code Message Information

| | | |
|---------|--------------------|--|
| VLT0218 | Message | The <name> voltage is less than the lower warning threshold. |
| | LCD Message | The <name> voltage is outside of range. |
| | Details | System hardware detected an over voltage or under voltage condition. If multiple voltage exceptions occur consecutively the system may power down in fail-safe mode. |
| | Action | <ol style="list-style-type: none">1. Review system logs for power supply exceptions.2. Re-configure the system to minimum configuration, inspect and reinstall system cables.3. If the issue persists, see Getting Help. |
| VLT0219 | Message | The <name> voltage is less than the lower critical threshold. |
| | LCD Message | The <name> voltage is outside of range. |
| | Details | System hardware detected an over voltage or under voltage condition. If multiple voltage exceptions occur consecutively the system may power down in fail-safe mode. |
| | Action | <ol style="list-style-type: none">1. Review system logs for power supply exceptions.2. Re-configure the system to minimum configuration, inspect and reinstall system cables.3. If the issue persists, see Getting Help. |
| VLT0220 | Message | The <name> voltage is greater than the upper warning threshold. |
| | LCD Message | The <name> voltage is outside of range. |
| | Details | System hardware detected an over voltage or under voltage condition. If multiple voltage exceptions occur consecutively the system may power down in fail-safe mode. |
| | Action | <ol style="list-style-type: none">1. Review system logs for power supply exceptions.2. Re-configure the system to minimum configuration, inspect and reinstall system cables.3. If the issue persists, see Getting Help. |
| VLT0221 | Message | The <name> voltage is greater than the upper critical threshold. |
| | LCD Message | The <name> voltage is outside of range. |
| | Details | System hardware detected an over voltage or under voltage condition. If multiple voltage exceptions occur consecutively the system may power down in fail-safe mode. |
| | Action | <ol style="list-style-type: none">1. Review system logs for power supply exceptions. |

Error Code Message Information

2. Re-configure the system to minimum configuration, inspect and reinstall system cables.
3. If the issue persists, see [Getting Help](#).

| | | |
|---------|--------------------|--|
| VLT0222 | Message | The <name> voltage is outside of range. |
| | LCD Message | The <name> voltage is outside of range. |
| | Details | System hardware detected an over voltage or under voltage condition. If multiple voltage exceptions occur consecutively the system may power down in fail-safe mode. |
| | Action | <ol style="list-style-type: none">1. Review system logs for power supply exceptions.2. Re-configure the system to minimum configuration, inspect and reinstall system cables.3. If the issue persists, see Getting Help. |
| VLT0224 | Message | The memory module <name> voltage is less than the lower warning threshold. |
| | LCD Message | Memory module <number> <name> voltage is outside of range. |
| | Details | System hardware detected an over voltage or under voltage condition. If multiple voltage exceptions occur consecutively the system may power down in fail-safe mode. |
| | Action | <ol style="list-style-type: none">1. Review system logs for power supply exceptions.2. Re-configure the system to minimum configuration, inspect and reinstall system cables.3. If the issue persists, see Getting Help. |
| VLT0225 | Message | The memory module <name> voltage is less than the lower critical threshold. |
| | LCD Message | Memory module <number> <name> voltage is outside of range. |
| | Details | System hardware detected an over voltage or under voltage condition. If multiple voltage exceptions occur consecutively the system may power down in fail-safe mode. |
| | Action | <ol style="list-style-type: none">1. Review system logs for power supply exceptions.2. Re-configure the system to minimum configuration, inspect and reinstall system cables.3. If the issue persists, see Getting Help. |
| VLT0226 | Message | The memory module <name> voltage is greater than the upper warning threshold. |
| | LCD Message | Memory module <number> <name> voltage is outside of range. |

Error Code Message Information

| | | |
|----------------|--------------------|--|
| | Details | System hardware detected an over voltage or under voltage condition. If multiple voltage exceptions occur consecutively the system may power down in fail-safe mode. |
| | Action | <ol style="list-style-type: none">1. Review system logs for power supply exceptions.2. Re-configure the system to minimum configuration, inspect and reinstall system cables.3. If the issue persists, see Getting Help. |
| VLT0227 | Message | The memory module <name> voltage is greater than the upper critical threshold. |
| | LCD Message | Memory module <number> <name> voltage is outside of range. |
| | Details | System hardware detected an over voltage or under voltage condition. If multiple voltage exceptions occur consecutively the system may power down in fail-safe mode. |
| | Action | <ol style="list-style-type: none">1. Review system logs for power supply exceptions.2. Re-configure the system to minimum configuration, inspect and reinstall system cables.3. If the issue persists, see Getting Help. |
| VLT0228 | Message | The memory module <name> voltage is outside of range. |
| | LCD Message | Memory module <number> <name> voltage is outside of range. |
| | Details | System hardware detected an over voltage or under voltage condition. If multiple voltage exceptions occur consecutively the system may power down in fail-safe mode. |
| | Action | <ol style="list-style-type: none">1. Review system logs for power supply exceptions.2. Re-configure the system to minimum configuration, inspect and reinstall system cables.3. If the issue persists, see Getting Help. |
| VLT0230 | Message | The mezzanine card <number> <name> voltage is less than the lower warning threshold. |
| | Details | System hardware detected an over voltage or under voltage condition. If multiple voltage exceptions occur consecutively the system may power down in fail-safe mode. |
| | Action | <ol style="list-style-type: none">1. Review system logs for power supply exceptions.2. Re-seat the mezzanine card.3. If the issue persists, see Getting Help. |
| VLT0231 | Message | The mezzanine card <number> <name> voltage is less than the lower critical threshold. |

Error Code Message Information

| | | |
|----------------|----------------|---|
| | Details | System hardware detected an over voltage or under voltage condition. If multiple voltage exceptions occur consecutively the system may power down in fail-safe mode. |
| | Action | <ol style="list-style-type: none">1. Review system logs for power supply exceptions.2. Re-seat the mezzanine card.3. If the issue persists, see Getting Help. |
| VLT0232 | Message | The mezzanine card <number> <name> voltage is greater than the upper warning threshold. |
| | Details | System hardware detected an over voltage or under voltage condition. If multiple voltage exceptions occur consecutively the system may power down in fail-safe mode. |
| | Action | <ol style="list-style-type: none">1. Review system logs for power supply exceptions.2. Re-seat the mezzanine card.3. If the issue persists, see Getting Help. |
| VLT0233 | Message | The mezzanine card <number> <name> voltage is greater than the upper critical threshold. |
| | Details | System hardware detected an over voltage or under voltage condition. If multiple voltage exceptions occur consecutively the system may power down in fail-safe mode. |
| | Action | <ol style="list-style-type: none">1. Review system logs for power supply exceptions.2. Re-seat the mezzanine card.3. If the issue persists, see Getting Help. |
| VLT0234 | Message | The mezzanine card <number> <name> voltage is outside of range. |
| | Details | System hardware detected an over voltage or under voltage condition. If multiple voltage exceptions occur consecutively the system may power down in fail-safe mode. |
| | Action | <ol style="list-style-type: none">1. Review system logs for power supply exceptions.2. Re-seat the mezzanine card.3. If the issue persists, see Getting Help. |

Warning Messages

A warning message alerts you to a possible problem and prompts you to respond before the system continues a task. For example, before you format a hard drive, a message warns you that you may lose all data on the hard drive. Warning messages usually interrupt the task and require you to respond by typing y (yes) or n (no).



NOTE: Warning messages are generated by either the application or the operating system. For more information, see the documentation that accompanied the operating system or application.

Diagnostic Messages

The system diagnostic utilities may issue messages if you run diagnostic tests on your system. See [Running The Embedded System Diagnostics](#) for more information about system diagnostics.

Alert Messages

Systems management software generates alert messages for your system. Alert messages include information, status, warning, and failure messages for drive, temperature, fan, and power conditions. For more information, see the systems management software documentation.

Getting Help

Contacting Dell

 **NOTE:** If you do not have an active Internet connection, you can find contact information on your purchase invoice, packing slip, bill, or Dell product catalog.

Dell provides several online and telephone-based support and service options. Availability varies by country and product, and some services may not be available in your area. To contact Dell for sales, technical support, or customer service issues:

1. Visit **support.dell.com**.
2. Select your support category.
3. If you are not a U.S. customer, select your country code at the bottom of the **support.dell.com** page, or select **All** to see more choices.
4. Select the appropriate service or support link based on your need.

Free Manuals Download Website

<http://myh66.com>

<http://usermanuals.us>

<http://www.somanuals.com>

<http://www.4manuals.cc>

<http://www.manual-lib.com>

<http://www.404manual.com>

<http://www.luxmanual.com>

<http://aubethermostatmanual.com>

Golf course search by state

<http://golfingnear.com>

Email search by domain

<http://emailbydomain.com>

Auto manuals search

<http://auto.somanuals.com>

TV manuals search

<http://tv.somanuals.com>