

## 2-Mbit (128K x 16) Static RAM

### Features

- **Temperature Ranges**
  - Industrial: -40°C to 85°C
  - Automotive-A: -40°C to 85°C
  - Automotive-E: -40°C to 125°C
- **High speed: 55 ns**
- **Wide voltage range: 2.7V–3.6V**
- **Ultra-low active, standby power**
- **Easy memory expansion with  $\overline{CE}$  and  $\overline{OE}$  features**
- **TTL-compatible inputs and outputs**
- **Automatic power-down when deselected**
- **CMOS for optimum speed/power**
- **Available in standard Pb-free 44-pin TSOP Type II, Pb-free and non Pb-free 48-ball FBGA packages**

### Functional Description<sup>[1]</sup>

The CY62136VN is a high-performance CMOS static RAM organized as 128K words by 16 bits. This device features advanced circuit design to provide ultra-low active current. This is ideal for providing More Battery Life™ (MoBL®) in

portable applications such as cellular telephones. The device also has an automatic power-down feature that significantly reduces power consumption by 99% when addresses are not toggling. The device can also be put into standby mode when deselected ( $\overline{CE}$  HIGH). The input/output pins (I/O<sub>0</sub> through I/O<sub>15</sub>) are placed in a high-impedance state when: deselected ( $\overline{CE}$  HIGH), outputs are disabled ( $\overline{OE}$  HIGH), BHE and BLE are disabled (BHE, BLE HIGH), or during a write operation ( $\overline{CE}$  LOW, and WE LOW).

Writing to the device is accomplished by taking Chip Enable ( $\overline{CE}$ ) and Write Enable (WE) inputs LOW. If Byte Low Enable (BLE) is LOW, then data from I/O pins (I/O<sub>0</sub> through I/O<sub>7</sub>), is written into the location specified on the address pins (A<sub>0</sub> through A<sub>16</sub>). If Byte High Enable (BHE) is LOW, then data from I/O pins (I/O<sub>8</sub> through I/O<sub>15</sub>) is written into the location specified on the address pins (A<sub>0</sub> through A<sub>16</sub>).

Reading from the device is accomplished by taking Chip Enable ( $\overline{CE}$ ) and Output Enable ( $\overline{OE}$ ) LOW while forcing the Write Enable (WE) HIGH. If Byte Low Enable (BLE) is LOW, then data from the memory location specified by the address pins will appear on I/O<sub>0</sub> to I/O<sub>7</sub>. If Byte High Enable (BHE) is LOW, then data from memory will appear on I/O<sub>8</sub> to I/O<sub>15</sub>. See the Truth Table at the back of this data sheet for a complete description of read and write modes.

### Logic Block Diagram

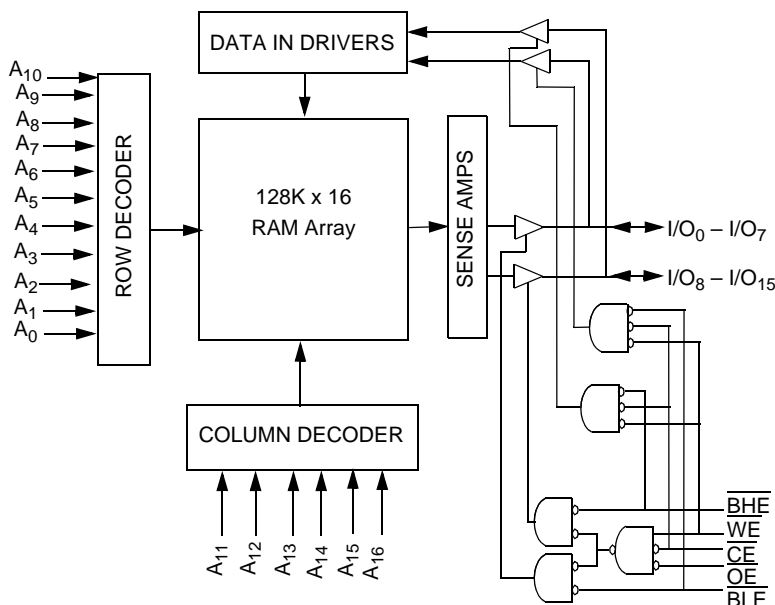

### PinConfigurations<sup>[3]</sup>

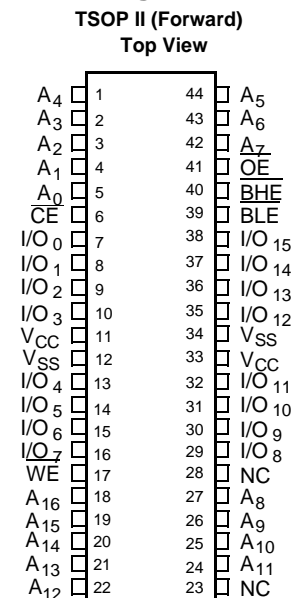

**Note:**

1. For best practice recommendations, please refer to the Cypress application note "System Design Guidelines" on <http://www.cypress.com>.

**Product Portfolio**

Product	V <sub>CC</sub> Range (V)			Speed	Ranges	Power Dissipation			
	Min	Typ. <sup>[2]</sup>	Max			Operating, I <sub>CC</sub> (mA)		Standby, I <sub>SB2</sub> (μA)	
						Typ. <sup>[2]</sup>	Maximum	Typ. <sup>[2]</sup>	Maximum
CY62136VNLL	2.7	3.0	3.6	55	Industrial	7	20	1	15
				55	Automotive-A	7	20	1	15
				70	Industrial	7	15	1	15
				70	Automotive-A	7	15	1	15
				70	Automotive-E	7	20	1	20

**Pin Configurations<sup>[3]</sup>**

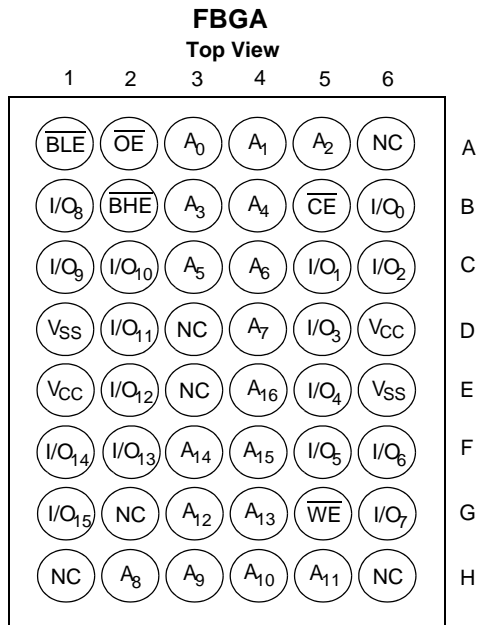

**Notes:**

2. Typical values are included for reference only and are not guaranteed or tested. Typical values are measured at V<sub>CC</sub> = V<sub>CC</sub> Typ, T<sub>A</sub> = 25°C.
3. NC pins are not connected on the die.

## Maximum Ratings

(Above which the useful life may be impaired. For user guidelines, not tested.)

Storage Temperature .....	-65°C to +150°C
Ambient Temperature with Power Applied.....	-55°C to +125°C
Supply Voltage to Ground Potential .....	-0.5V to +4.6V
DC Voltage Applied to Outputs in High-Z State <sup>[4]</sup> .....	-0.5V to $V_{CC} + 0.5V$
DC Input Voltage <sup>[4]</sup> .....	-0.5V to $V_{CC} + 0.5V$

Output Current into Outputs (LOW).....	20 mA
Static Discharge Voltage.....	> 2001V (per MIL-STD-883, Method 3015)
Latch-up Current.....	> 200 mA

## Operating Range

Range	Ambient Temperature [T <sub>A</sub> ] <sup>[5]</sup>	V <sub>CC</sub>
Industrial	-40°C to +85°C	2.7V to 3.6V
Automotive-A	-40°C to +85°C	
Automotive-E	-40°C to +125°C	

## Electrical Characteristics Over the Operating Range

Parameter	Description	Test Conditions	-55			-70			Unit		
			Min.	Typ. <sup>[2]</sup>	Max.	Min.	Typ. <sup>[2]</sup>	Max.			
V <sub>OH</sub>	Output HIGH Voltage	V <sub>CC</sub> = 2.7V, I <sub>OH</sub> = -1.0 mA	2.4			2.4			V		
V <sub>OL</sub>	Output LOW Voltage	V <sub>CC</sub> = 2.7V, I <sub>OL</sub> = 2.1 mA			0.4			0.4	V		
V <sub>IH</sub>	Input HIGH Voltage	V <sub>CC</sub> = 3.6V	2.2		V <sub>CC</sub> + 0.5V	2.2		V <sub>CC</sub> + 0.5V	V		
V <sub>IL</sub>	Input LOW Voltage	V <sub>CC</sub> = 2.7V	-0.5		0.8	-0.5		0.8	V		
I <sub>IX</sub>	Input Leakage Current	GND ≤ V <sub>I</sub> ≤ V <sub>CC</sub>	Ind'l	-1		+1	-1		+1	μA	
			Auto-A	-1		+1	-1		+1	μA	
			Auto-E				-10		+10	μA	
I <sub>OZ</sub>	Output Leakage Current	GND ≤ V <sub>O</sub> ≤ V <sub>CC</sub> , Output Disabled	Ind'l	-1		+1	-1		+1	μA	
			Auto-A	-1		+1	-1		+1	μA	
			Auto-E				-10		+10	μA	
I <sub>CC</sub>	V <sub>CC</sub> Operating Supply Current	f = f <sub>MAX</sub> = 1/t <sub>RC</sub>	V <sub>CC</sub> = 3.6V, I <sub>OUT</sub> = 0 mA, CMOS Levels	Ind'l		7	20		7	15	mA
				Auto-A		7	20		7	15	
				Auto-E					7	20	
		f = 1 MHz	Ind'l		1	2		1	2	mA	
			Auto-A		1	2		1	2		
			Auto-E					1	2		
I <sub>SB1</sub>	Automatic CE Power-down Current—CMOS Inputs	CE ≥ V <sub>CC</sub> - 0.3V, V <sub>IN</sub> ≥ V <sub>CC</sub> - 0.3V or V <sub>IN</sub> ≤ 0.3V, f = f <sub>MAX</sub>	Ind'l			100			100	μA	
			Auto-A			100			100	μA	
			Auto-E						100	μA	
I <sub>SB2</sub>	Automatic CE Power-down Current—CMOS Inputs	CE ≥ V <sub>CC</sub> - 0.3V, V <sub>IN</sub> ≥ V <sub>CC</sub> - 0.3V or V <sub>IN</sub> ≤ 0.3V, f = 0	Ind'l		1	15		1	15	μA	
			Auto-A		1	15		1	15		
			Auto-E					1	20		

## Capacitance<sup>[6]</sup>

Parameter	Description	Test Conditions	Max.	Unit
C <sub>IN</sub>	Input Capacitance	T <sub>A</sub> = 25°C, f = 1 MHz, V <sub>CC</sub> = V <sub>CC(typ)</sub>	6	pF
C <sub>OUT</sub>	Output Capacitance		8	pF

### Notes:

- V<sub>IL(min)</sub> = -2.0V for pulse durations less than 20 ns.
- T<sub>A</sub> is the "Instant-On" case temperature.
- Tested initially and after any design or process changes that may affect these parameters.

**Thermal Resistance<sup>[6]</sup>**

Parameter	Description	Test Conditions	TSOPII	FBGA	Unit
$\Theta_{JA}$	Thermal Resistance (Junction to Ambient)	Still Air, soldered on a 4.25 x 1.125 inch, 4-layer printed circuit board	60	55	°C/W
$\Theta_{JC}$	Thermal Resistance (Junction to Case)		22	16	°C/W

**AC Test Loads and Waveforms**

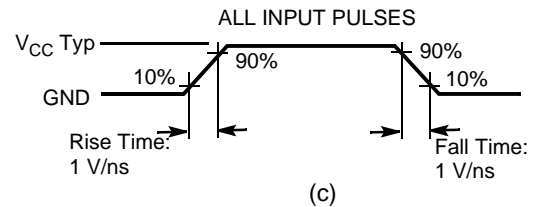
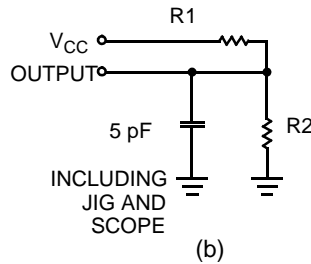
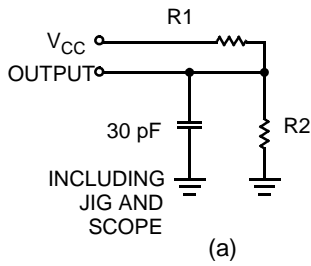

Equivalent to: THÉVENIN EQUIVALENT

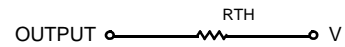

Parameters	Value	Unit
R1	1105	Ohms
R2	1550	Ohms
$R_{TH}$	645	Ohms
$V_{TH}$	1.75	Volts

**Data Retention Characteristics (Over the Operating Range)**

Parameter	Description	Conditions <sup>[9]</sup>	Min.	Typ. <sup>[2]</sup>	Max.	Unit
$V_{DR}$	$V_{CC}$ for Data Retention		1.0			V
$I_{CCDR}$	Data Retention Current	$V_{CC} = 1.0V, \overline{CE} \geq V_{CC} - 0.3V,$ $V_{IN} \geq V_{CC} - 0.3V$ or $V_{IN} \leq 0.3V,$		0.5	7.5	$\mu A$
$t_{CDR}^{[6]}$	Chip Deselect to Data Retention Time		0			ns
$t_R^{[7]}$	Operation Recovery Time		70			ns

**Data Retention Waveform**

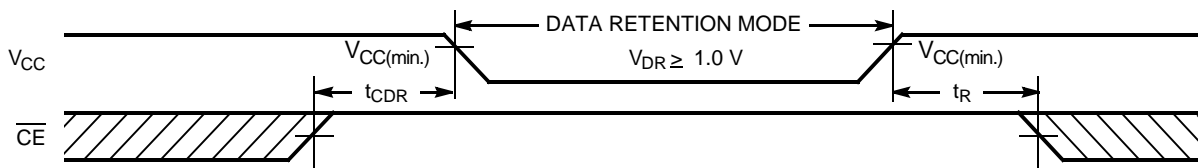

**Note:**

- 7. Full device operation requires linear  $V_{CC}$  ramp from  $V_{DR}$  to  $V_{CC(min)} \geq 100$  ms or stable at  $V_{CC(min)} \geq 100$  ms.
- 8. No input may exceed  $V_{CC} + 0.3V$

**Switching Characteristics** Over the Operating Range <sup>[9]</sup>

Parameter	Description	55 ns		70 ns		Unit
		Min.	Max.	Min.	Max.	
<b>Read Cycle</b>						
t <sub>RC</sub>	Read Cycle Time	55		70		ns
t <sub>AA</sub>	Address to Data Valid		55		70	ns
t <sub>OHA</sub>	Data Hold from Address Change	10		10		ns
t <sub>ACE</sub>	$\overline{CE}$ LOW to Data Valid		55		70	ns
t <sub>DOE</sub>	$\overline{OE}$ LOW to Data Valid		25		35	ns
t <sub>LZOE</sub>	$\overline{OE}$ LOW to Low-Z <sup>[10]</sup>	5		5		ns
t <sub>HZOE</sub>	$\overline{OE}$ HIGH to High-Z <sup>[10, 11]</sup>		25		25	ns
t <sub>LZCE</sub>	$\overline{CE}$ LOW to Low-Z <sup>[10]</sup>	10		10		ns
t <sub>HZCE</sub>	$\overline{CE}$ HIGH to High-Z <sup>[10, 11]</sup>		25		25	ns
t <sub>PU</sub>	$\overline{CE}$ LOW to Power-up	0		0		ns
t <sub>PD</sub>	$\overline{CE}$ HIGH to Power-down		55		70	ns
t <sub>DBE</sub>	$\overline{BLE} / \overline{BHE}$ LOW to Data Valid		25		35	ns
t <sub>LZBE</sub>	$\overline{BLE} / \overline{BHE}$ LOW to Low-Z <sup>[10, 11]</sup>	5		5		ns
t <sub>HZBE</sub>	$\overline{BLE} / \overline{BHE}$ HIGH to High-Z <sup>[12]</sup>		25		25	ns
<b>Write Cycle<sup>[12, 13]</sup></b>						
t <sub>WC</sub>	Write Cycle Time	55		70		ns
t <sub>SCE</sub>	$\overline{CE}$ LOW to Write End	45		60		ns
t <sub>AW</sub>	Address Set-up to Write End	45		60		ns
t <sub>HA</sub>	Address Hold from Write End	0		0		ns
t <sub>SA</sub>	Address Set-up to Write Start	0		0		ns
t <sub>PWE</sub>	$\overline{WE}$ Pulse Width	40		50		ns
t <sub>BW</sub>	$\overline{BLE} / \overline{BHE}$ LOW to Write End	50		60		ns
t <sub>SD</sub>	Data Set-up to Write End	25		30		ns
t <sub>HD</sub>	Data Hold from Write End	0		0		ns
t <sub>HZWE</sub>	$\overline{WE}$ LOW to High-Z <sup>[10, 11]</sup>		20		25	ns
t <sub>LZWE</sub>	$\overline{WE}$ HIGH to Low-Z <sup>[10]</sup>	5		10		ns

**Notes:**

9. Test conditions assume signal transition time of 5 ns or less, timing reference levels of 1.5V, input pulse levels of 0 to V<sub>CC</sub> typ., and output loading of the specified I<sub>OL</sub>/I<sub>OH</sub> and 30-pF load capacitance.
10. At any given temperature and voltage condition, t<sub>HZCE</sub> is less than t<sub>LZCE</sub>, t<sub>HZOE</sub> is less than t<sub>LZOE</sub>, and t<sub>HZWE</sub> is less than t<sub>LZWE</sub> for any given device.
11. t<sub>HZOE</sub>, t<sub>HZCE</sub>, and t<sub>HZWE</sub> are specified with C<sub>L</sub> = 5 pF as in (b) of AC Test Loads. Transition is measured ±500 mV from steady-state voltage.
12. The internal write time of the memory is defined by the overlap of  $\overline{CE}$  LOW and  $\overline{WE}$  LOW. Both signals must be LOW to initiate a write and either signal can terminate a write by going HIGH. The data input set-up and hold timing should be referenced to the rising edge of the signal that terminates the write.
13. The minimum write cycle time for write cycle 3 ( $\overline{WE}$  controlled,  $\overline{OE}$  LOW) is the sum of t<sub>HZWE</sub> and t<sub>SD</sub>.

### Switching Waveforms

#### Read Cycle No. 1<sup>[14, 15]</sup>

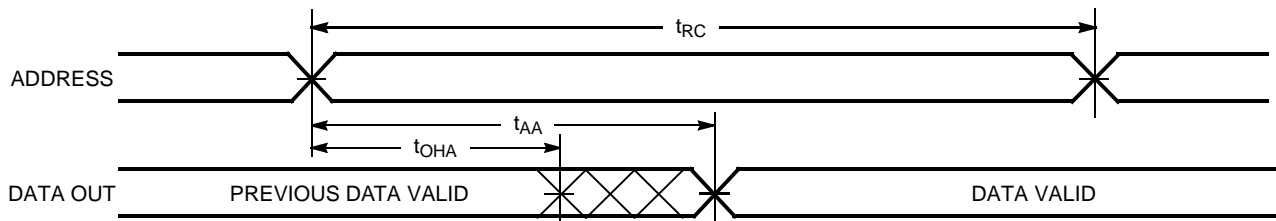

#### Read Cycle No. 2<sup>[15, 16]</sup>

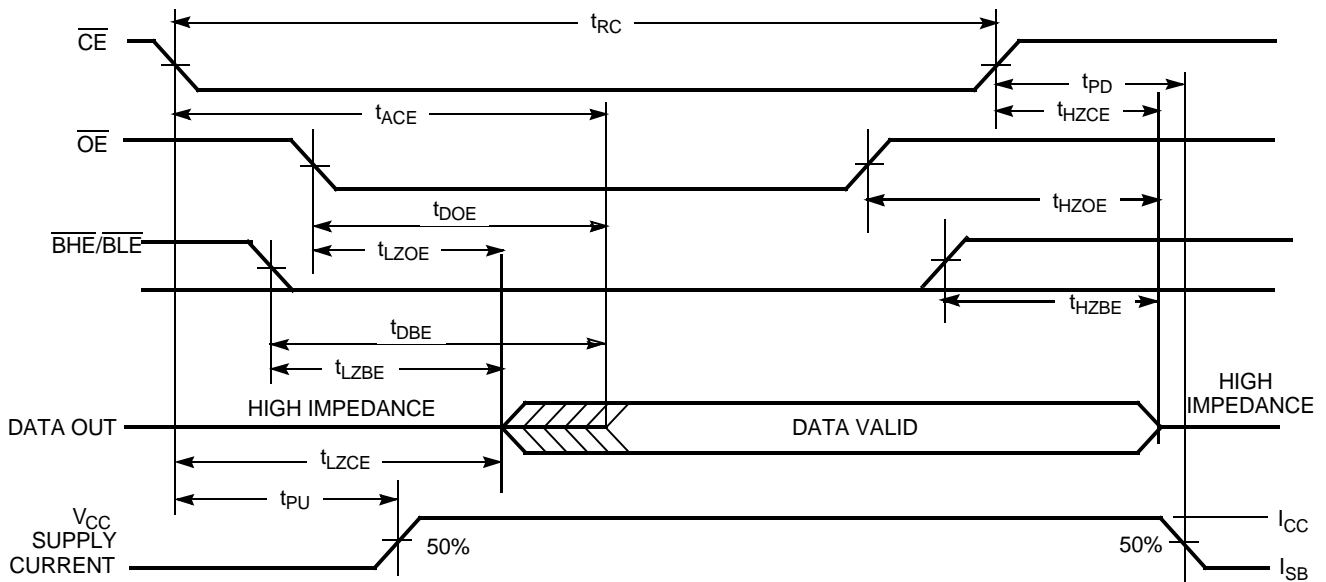

- Notes:**  
 14. Device is continuously selected.  $\overline{OE}, \overline{CE} = V_{IL}$ .  
 15.  $\overline{WE}$  is HIGH for read cycle.  
 16. Address valid prior to or coincident with  $\overline{CE}$  transition LOW.

Switching Waveforms (continued)

Write Cycle No. 1 ( $\overline{WE}$  Controlled)<sup>[12, 17, 18]</sup>

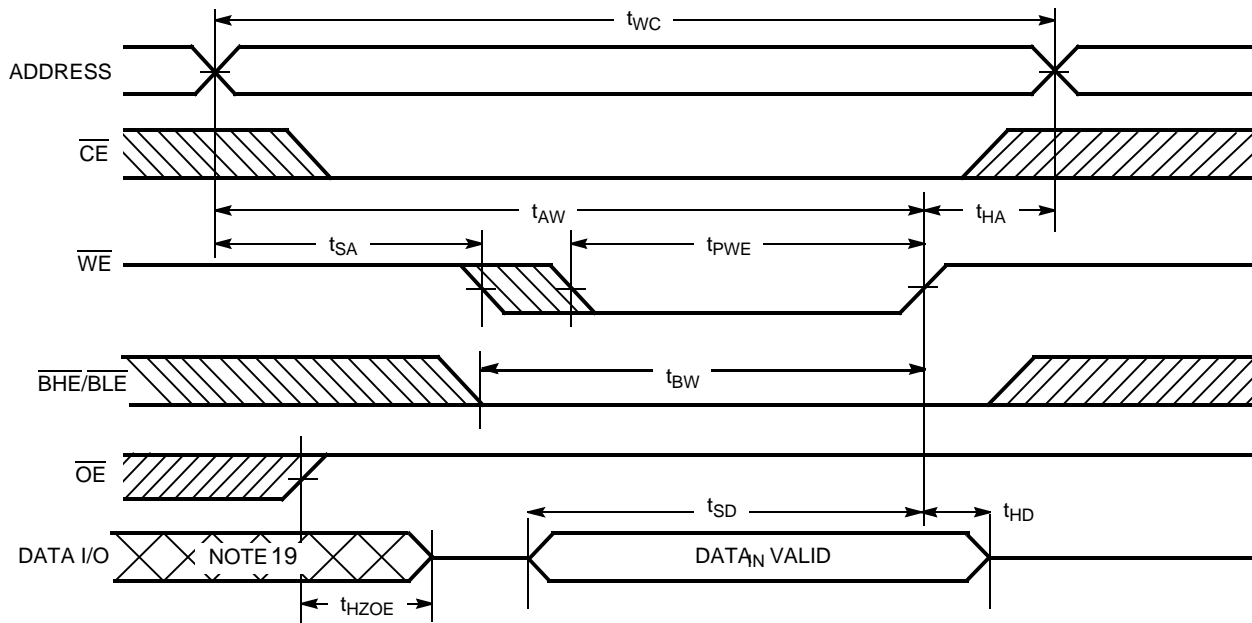

Write Cycle No. 2 ( $\overline{CE}$  Controlled)<sup>[12, 17, 18]</sup>

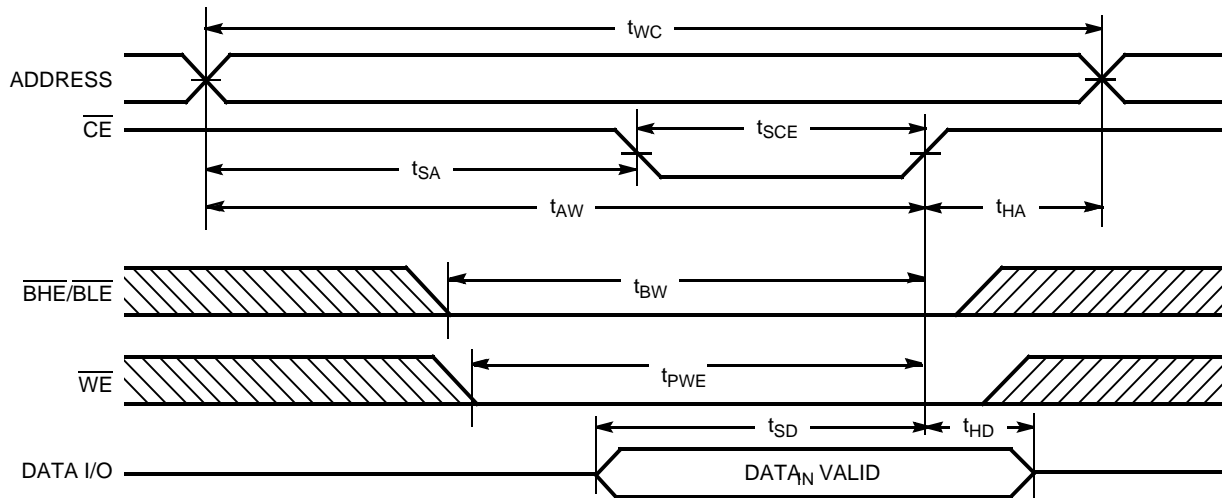

Notes:

- 17. Data I/O is high impedance if  $\overline{OE} = V_{IH}$ .
- 18. If  $\overline{CE}$  goes HIGH simultaneously with  $\overline{WE}$  HIGH, the output remains in a high-impedance state.
- 19. During this period, the I/Os are in output state and input signals should not be applied.

**Switching Waveforms** (continued)

**Write Cycle No. 3 ( $\overline{\text{WE}}$  Controlled,  $\overline{\text{OE}}$  LOW)<sup>[13, 18]</sup>**

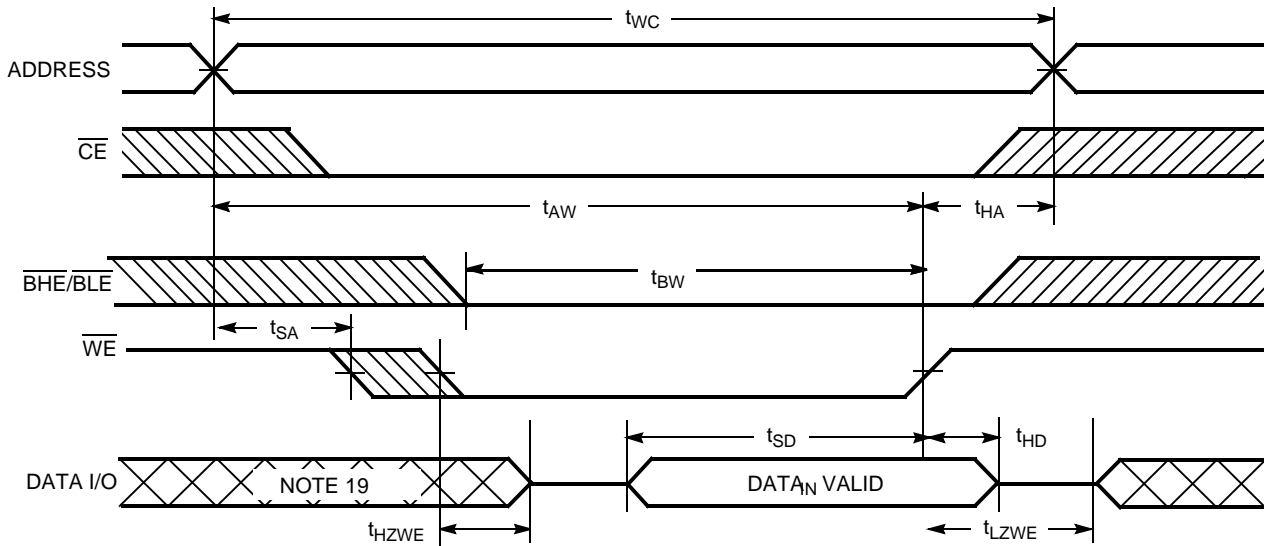

**Write Cycle No. 4 ( $\overline{\text{BHE/BLE}}$  Controlled,  $\overline{\text{OE}}$  LOW)<sup>[19]</sup>**

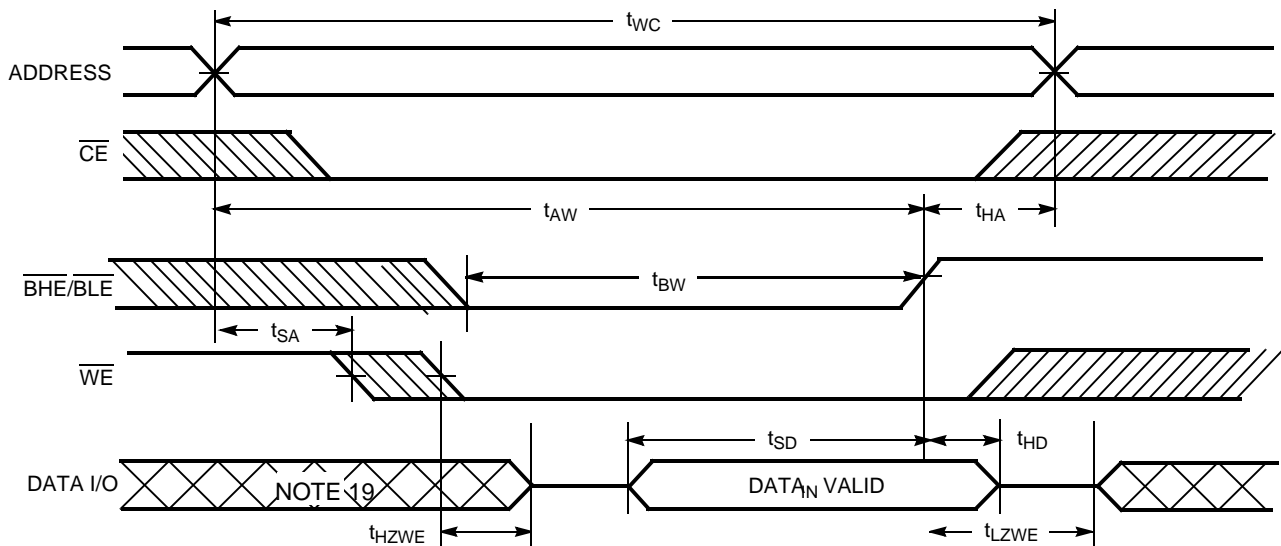



**Typical DC and AC Characteristics**

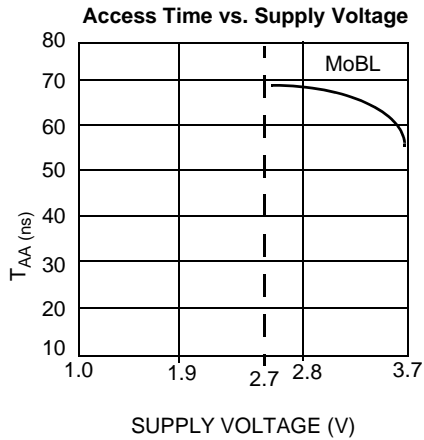
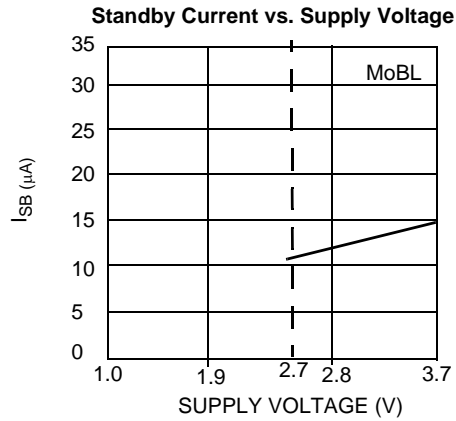
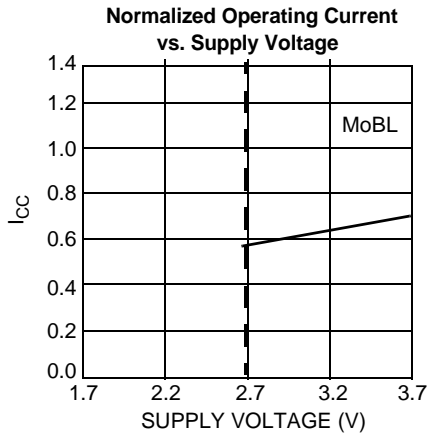

**Truth Table**

$\overline{\text{CE}}$	$\overline{\text{WE}}$	$\overline{\text{OE}}$	$\overline{\text{BHE}}$	$\overline{\text{BLE}}$	Inputs/Outputs	Mode	Power
H	X	X	X	X	High-Z	Deselect/Power-down	Standby ( $I_{\text{SB}}$ )
L	H	L	L	L	Data Out ( $I/O_0$ – $I/O_7$ )	Read	Active ( $I_{\text{CC}}$ )
L	H	L	H	L	Data Out ( $I/O_0$ – $I/O_7$ ); $I/O_8$ – $I/O_{15}$ in High-Z	Read	Active ( $I_{\text{CC}}$ )
L	H	L	L	H	Data Out ( $I/O_8$ – $I/O_{15}$ ); $I/O_0$ – $I/O_7$ in High-Z	Read	Active ( $I_{\text{CC}}$ )
L	H	L	H	H	High-Z	Deselect/Output Disabled	Active ( $I_{\text{CC}}$ )
L	H	H	L	L	High-Z	Deselect/Output Disabled	Active ( $I_{\text{CC}}$ )
L	H	H	H	L	High-Z	Deselect/Output Disabled	Active ( $I_{\text{CC}}$ )
L	H	H	L	H	High-Z	Deselect/Output Disabled	Active ( $I_{\text{CC}}$ )
L	L	X	L	L	Data In ( $I/O_0$ – $I/O_{15}$ )	Write	Active ( $I_{\text{CC}}$ )
L	L	X	H	L	Data In ( $I/O_0$ – $I/O_7$ ); $I/O_8$ – $I/O_{15}$ in High-Z	Write	Active ( $I_{\text{CC}}$ )
L	L	X	L	H	Data In ( $I/O_8$ – $I/O_{15}$ ); $I/O_0$ – $I/O_7$ in High-Z	Write	Active ( $I_{\text{CC}}$ )

Ordering Information

Speed (ns)	Ordering Code	Package Diagram	Package Type	Operating Range
55	CY62136VNLL-55ZXI	51-85087	44-pin TSOP II (Pb-Free)	Industrial
	CY62136VNLL-55BAI	51-85096	48-Ball (7.00 mm x 7.00 mm) FBGA	
	CY62136VNLL-55ZSXA	51-85087	44-pin TSOP II (Pb-Free)	Automotive-A
70	CY62136VNLL-70ZXI	51-85087	44-pin TSOP II (Pb-Free)	Industrial
	CY62136VNLL-70BAI	51-85096	48-Ball (7.00 mm x 7.00 mm) FBGA	Automotive-A
	CY62136VNLL-70BAXA	51-85096	48-Ball (7.00 mm x 7.00 mm) FBGA (Pb-Free)	
	CY62136VNLL-70ZSXA	51-85087	44-pin TSOP II (Pb-Free)	
	CY62136VNLL-70ZSXE	51-85087	44-pin TSOP II (Pb-Free)	Automotive-E

Please contact your local Cypress sales representative for availability of these parts

Package Diagrams

44-pin TSOP II (51-85087)

DIMENSION IN MM (INCH)  
MAX  
MIN

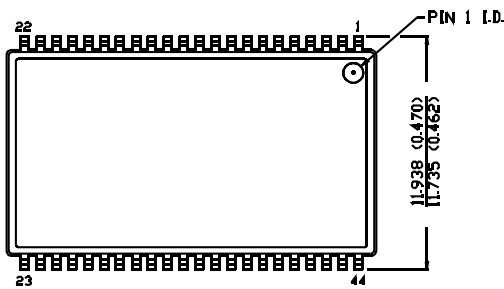

TOP VIEW

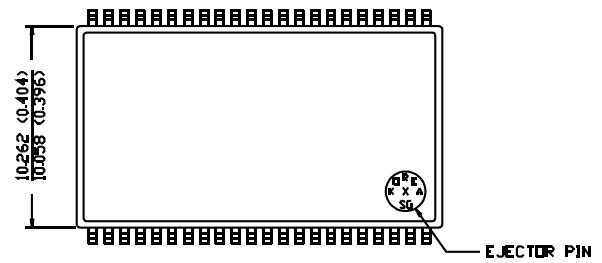

BOTTOM VIEW

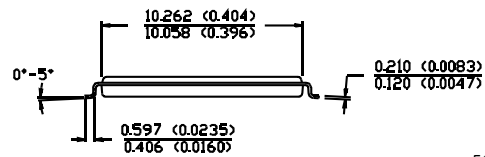
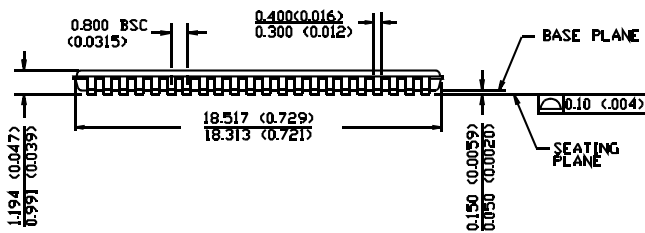

51-85087-\*A

**Package Diagrams (continued)**

**48-Ball (7.00 mm x 7.00 mm) FBGA (51-85096)**

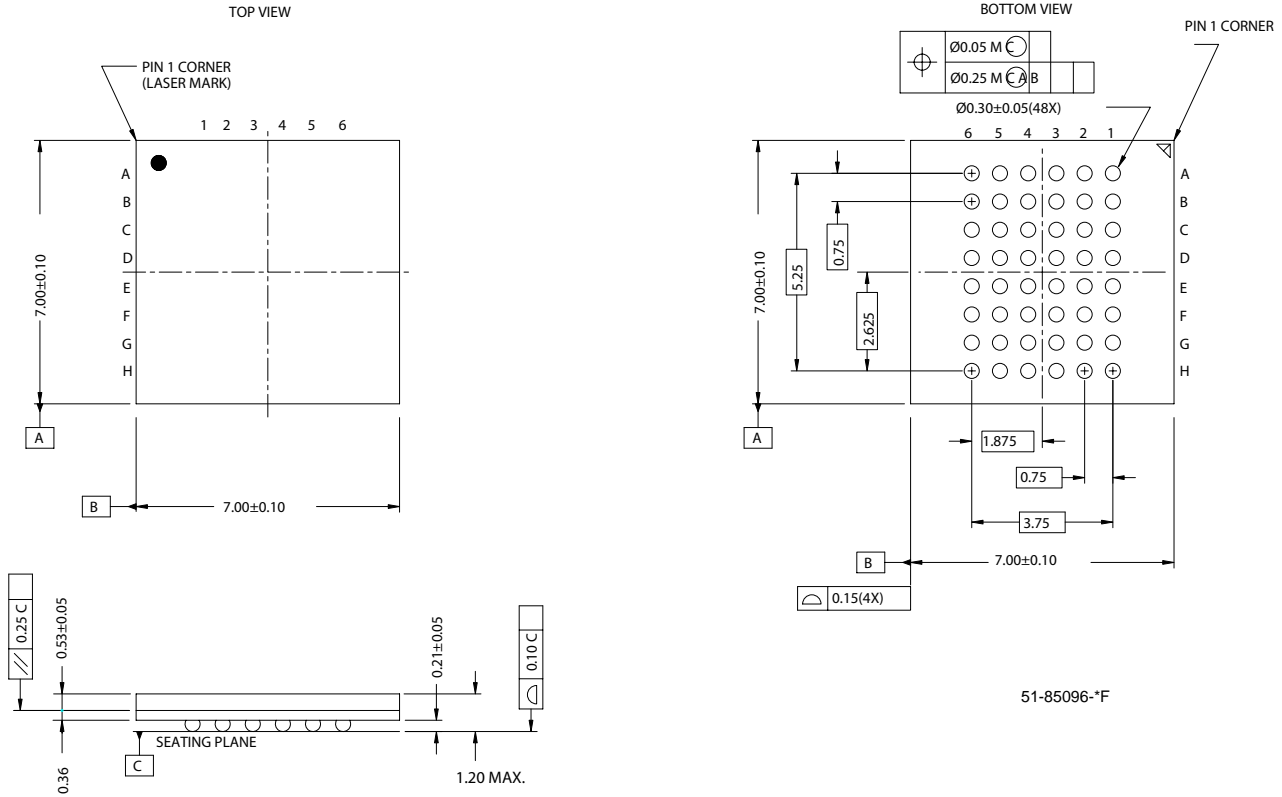

MoBL is a registered trademark, and More Battery Life is a trademark, of Cypress Semiconductor Corporation. All product and company names mentioned in this document are the products of their respective holders.

## Document History Page

Document Title: CY62136VN MoBL <sup>®</sup> 2-Mbit (128K x 16) Static RAM				
Document Number: 001-06510				
REV.	ECN NO.	Issue Date	Orig. of Change	Description of Change
**	426503	See ECN	RXU	New Data Sheet
*A	488954	See ECN	NXR	Added Automotive product Updated ordering Information table

## Free Manuals Download Website

<http://myh66.com>

<http://usermanuals.us>

<http://www.somanuals.com>

<http://www.4manuals.cc>

<http://www.manual-lib.com>

<http://www.404manual.com>

<http://www.luxmanual.com>

<http://aubethermostatmanual.com>

Golf course search by state

<http://golfingnear.com>

Email search by domain

<http://emailbydomain.com>

Auto manuals search

<http://auto.somanuals.com>

TV manuals search

<http://tv.somanuals.com>