

SBC Series

Single Board Computer
Full Size PICMG
with LANx2, VGA, Audio

SPI-8451-LLVA

SPI-8452-LLVA

with LAN, VGA, Audio

SPI-8451-LVA

User's Manual

CONTEC CO.,LTD.

Check Your Package

Thank you for purchasing the CONTEC product.

The product consists of the items listed below.

Check, with the following list, that your package is complete. If you discover damaged or missing items, contact your retailer.

Product Configuration List

- Board (One of the following)
[SPI-8451-LLVA/-LVA or SPI-8452-LLVA] ...1
 - Product Guide ...1
 - IPC Precaution List ...1
 - CD-ROM (Driver disk utilities) ...1 * 1
 - IDE 80 pin Ribbon Cable ...1
 - IDE 40 pin Ribbon Cable ...1
 - FDD Ribbon Cable ... 1
 - 2 serial ports (9 pin D-SUB male x 2) ribbon cable (with bracket) ...1
 - Parallel port (25 pin D-SUB female x 1) ribbon cable (with bracket) ...1
 - Audio jack cable (with bracket) ...1
 - 6 pin mini-DIN cable (2 in 1 for PS2 Mouse & Keyboard functions) ...1
 - DVI - Analog RGB conversion adapter
(SPI-8451-LLVA, SPI-8452-LLVA only) ...1
 - +12V power supply cable ...1
 - Jumper short pin (2 mm) ...5
- * 1 The CD-ROM contains the driver software and User's Manual (this Manual)

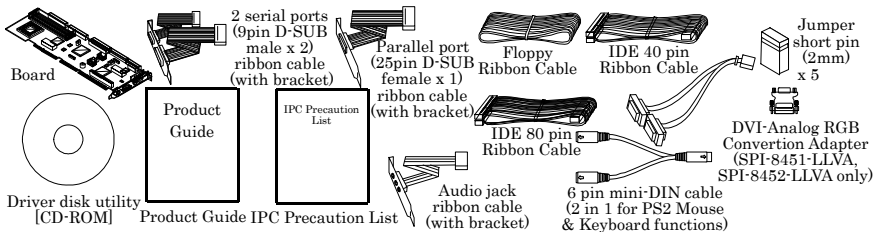

Copyright

Copyright 2007 CONTEC CO., LTD. ALL RIGHTS RESERVED.

No part of this document may be copied or reproduced in any form by any means without prior written consent of CONTEC CO., LTD.

CONTEC CO., LTD. makes been considered in the preparation of this document. Should you notice an omission or any questionable item in this document, please feel free to notify CONTEC CO. LTD.

All relevant issues have been considered in the preparation of this document. Should you notice an omission or any questionable item in this document, please feel free to notify CONTEC CO., LTD.

Regardless of the foregoing statement, CONTEC assumes no responsibility for any errors that may appear in this document nor for results obtained by the user as a result of using this product.

Trademarks

Intel, Celeron and Pentium are registered trademarks of Intel Corporation.

MS, Microsoft, Windows and Windows NT are trademarks of Microsoft Corporation. Other brand and product names are trademarks of their respective holder.

All Other product names or trademarks are properties of their respective owners.

Caution about Battery

Replace only with the same or equivalent type recommended by the manufacturer.

Dispose of used batteries according to the local ordinances or regulations.

Table of Contents

Check Your Package	i
Copyright	ii
Trademarks	ii
Caution about Battery	ii
Table of Contents.....	iii

1. INTRODUCTION 1

Features.....	1
Option List.....	2
Customer Support.....	3
Web Site	3
Limited One Year warranty.....	3
How to Obtain Service	3
Liability.....	3
Safety Precautions	3
Safety Information.....	4
Handling Precautions.....	4
Environments.....	5
Inspection.....	5
Storage.....	5
Disposal	5

2. SYSTEM REFERENCE 7

Specification	7
Power Requirements.....	11
Power Consumption	11
Connector & Jumper Location	12
Block Diagram.....	13

3. HARDWARE INSTALLATIONS 15

Installation procedure	15
CPU Installation:	16
Main Memory Installation: DIMM1, DIMM2.....	17
ATX Power Control Connector: CN1	18
Front Panel Connector: CN2	19
Floppy Disk Connector: CN3.....	20
Primary / Secondary IDE Connector: CN13/CN4	21
Parallel Port Connector: CN5.....	22
Serial Port connector: CN6, CN7.....	23

RS-422 / RS-485 specifications	24
IDE RAID Connector: CN14, CN8 (SPI-8451-LLVA only)	25
Audio Connector: CN9	26
CD-IN Connector: JCDIN	26
DVI-I Connector: CN15	27
VGA Connector: CN24 (SPI-8451-LVA only)	28
LVDS LCD panel Connector: CN11 / CN12 (SPI-8451-LLVA, SPI-8452-LLVA only)	29
LCD Backlight Connector: CN10 (SPI-8451-LLVA, SPI-8452-LLVA only)	30
GIGA LAN Connector: CN16 (SPI-8451-LLVA, SPI-8452-LLVA only)	31
10/100 BASE-TX LAN Connector: CN17	31
USB Connector: CN18, CN19, CN20	32
External Battery Connector: CN21 (SPI-8451-LVA only)	32
Keyboard / Mouse Connector: CN22	33
EXT. Keyboard Connector: CN23	33
+12V Power supply Connector: PW1	34
CPU FAN Connector: FAN1	34
System FAN Connector: FAN2	34

4.	JUMPER SETTING	35
-----------	-----------------------	-----------

RS-232/422/485 Selector: JP1, JP3	35
RS-422 Setting	36
RS-485 Setting	37
I/O addresses and instructions	37
RS-422/485 Terminator: JP2	38
Clear CMOS Content: JBAT1	38

5.	BOARD RESOURCES	39
-----------	------------------------	-----------

System address map	39
PCI Routing Information	40

6.	RAID CONTROLLER	41
-----------	------------------------	-----------

Creating Your Disk Array	43
Creating an Array for Performance	44
Creating a Security Array with new drives	44
Creating a Security Array with An Existing Data Drive	45
Using FastBuild™ Configuration Utility	46
Viewing the BIOS Screen	46
Using the Main Menu	47
Creating Arrays Automatically	48
Viewing Drive Assignments	49
Viewing Array	49

Deleting an array	50
Rebuilding a mirrored Array	51
Viewing Controller Settings	52
Installing the drivers Windows 2000/XP	53
Using the FastCheck Monitoring Utility	55
Installing FastCheck	55
Running FastCheck	55
Closing FastCheck	56
Using FastCheck Array Windows	57
Viewing Arrayed Drive Information	58
Rebuilding An Array	61
Using Controller Windows	63
Using Options Windows	65

7. WATCH-DOG-TIMER (WDT) SETTING	71
---	-----------

8. BIOS SETUP	75
----------------------	-----------

Introduction.....	75
Starting Setup	75
Using Setup.....	76
Getting Help	76
In Case of Problems.....	76
A Final Note About Setup	76
Main Menu.....	77
Standard CMOS Setup	79
IDE Adapters	80
Advanced BIOS Features Setup	81
Virus Warning	81
Advanced Chipset Features Setup	85
Integrated Peripherals	89
Power Management Setup	95
PnP/PCI Configuration Setup.....	100
IRQ n Resources	102
PC Health Status	103
Frequency / Voltage Control	104
Defaults Menu	105
Supervisor/User Password Setting	105
Exit Selecting.....	106
POST Messages	106
POST Beep	106
Error Messages	106
POST Codes.....	111

1. Introduction

This product is a full-size PICMG single-board computer that uses the Intel(R) 845GV chipset and can mount a 1.7G - 2.8GHz (FSB400/533MHz) Intel(R) Pentium(R) 4 processor. The board supports a maximum of 2GB DDR SDRAM and features an all-in-one design that incorporates a range of different interfaces.

The SPI-8451-LLVA supports Dual View with two LAN ports (one of which provides GigaBit support) and an LVDS interface. The board also incorporates a RAID controller (PDC2065R from Promise Technology Inc.) for RAID 0 and RAID 1 support.

The SPI-8452-LLVA supports Dual View with two LAN ports (one of which provides GigaBit support) and an LVDS interface.

The SPI-8451-LVA is provided with one LAN port.

When connecting external devices or building the system, please read this manual carefully.

Features

[Common]

- The corresponding CPU is as follows :
Intel(R) Pentium(R) 4 processor 1.7G - 2.8GHz(FSB400/533MHz),
Intel(R) Celeron(R) processor 1.7G - 2.6GHz (FSB400MHz),
Intel(R) Celeron(R) D processor 2.26G - 2.8GHz (FSB533MHz)
- Full size CPU board that complies with the PICMG specification and is equipped with a range of standard interfaces including EIDE, 6 x USB 2.0 ports, audio, serial, parallel, and PS/2.
- Intel(R) 845GV chipset
- Max. 2GB DDR SDRAM

[SPI-8451-LLVA]

- Equipped with DVI-I and LDVS, supports Dual View.
- Incorporates an LVDS interface that can connect directly to an LCD display.
- Incorporates a RAID controller (Promise PDC2065R) that supports both data striping (RAID 0) and data mirroring (RAID 1).
- GIGA bit LAN using Intel 82541 controller

[SPI-8452-LLVA]

- Equipped with DVI-I and LDVS, supports Dual View.
- Incorporates an LVDS interface that can connect directly to an LCD display.
- GIGA bit LAN using Intel 82541 controller

[SPI-8451-LVA]

- Equipped with analog RGB interface

Option List

CPU

PCP4-28S	Pentium 4 2.8GHz CPU with HeatSink-FAN *1
PCP4-28	Pentium 4 2.8 GHz CPU with HeatSink-FAN *2
PCP4-24	Pentium 4 2.4GHz CPU with HeatSink-FAN *2
PCP4C-20S	Celeron 2.0GHz CPU with HeatSink-FAN *1
PCP4C-20	Celeron 2.0GHz CPU with HeatSink-FAN *2

*1 This board requires the width for 2 slots (except CPU heatsink-fan height). Furthermore, since a heatsink-fan interferes to board, the next 3 slots can not use full size board (length of 200mm max.).

*2 This board requires the width for 2 slots (except CPU heatsink-fan height). Furthermore, since a heatsink-fan interferes to board, the next 2 slots can not use full size board (length of 200mm max.).

Memory

PC-MDD256-184A	184-Pin DDR-Memory (PC2700 , 256MB)
PC-MDD512-184A	184-Pin DDR-Memory (PC2700 , 512MB)

Cable

USB Connector Cable	USB Connector shielded cable
IDE-66 Cable	IDE Ultra ATA 100/66 ribbon cable

Customer Support

CONTEC provides the following support services for you to use CONTEC products more efficiently and comfortably.

Web Site

Japanese <http://www.contec.co.jp/>

English <http://www.contec.com/>

Chinese <http://www.contec.com.cn/>

Latest product information

CONTEC provides up-to-date information on products.

CONTEC also provides product manuals and various technical documents in the PDF.

Free download

You can download updated driver software and differential files as well as sample programs available in several languages.

Note! For product information

Contact your retailer if you have any technical question about a CONTEC product or need its price, delivery time, or estimate information.

Limited One Year warranty

CONTEC products are warranted by CONTEC CO. LTD. To be free from defects in material and workmanship for up to one year from the date of purchase by the original purchaser.

Repair will be free of charge only when this device is returned freight prepaid with a copy of the original invoice boards. The warranty is not applicable if the device has been tampered with or damaged through abuse, mistreatment, neglect, or unreasonable use, or original invoice is not included, in which case repairs will be considered beyond the warranty policy.

How to Obtain Service

For replacement or repair, return the device freight prepaid, with a copy of the original invoice. Please obtain a Return Merchandise Authorization Number (RMA) from our Sales Administration Department before returning any product.

* No product will be accepted by CONTEC group without a RMA number.

Liability



The obligation of the warrantor is solely to repair or replace the product. In no event will the warrantor be liable for any incidental or consequential damages due to such defect or consequences that arise from inexperienced usage, misuse, or malfunction of this device.

Safety Precautions

Understand the following definitions and precautions to use the product safely.

Safety Information

This document provides safety information using the following symbols to prevent accidents resulting in injury or death and the destruction of equipment and resources. Understand the meanings of these labels to operate the equipment safely.

 DANGER	DANGER indicates an imminently hazardous situation which, if not avoided, will result in death or serious injury.
 WARNING	WARNING indicates a potentially hazardous situation which, if not avoided, could result in death or serious injury.
 CAUTION	CAUTION indicates a potentially hazardous situation which, if not avoided, may result in minor or moderate injury or in property damage.

Handling Precautions

CAUTION

- Do not modify the product. CONTEC will bear no responsibility for problems, etc., resulting from modifying this product.
 - Do not strike or bend this product.
 - Otherwise, this product may malfunction, overheat, cause a failure or breakage.
 - Do not touch this product's metal plated terminals (edge connector) with your hands.
 - Otherwise, this product may malfunction, overheat, or cause a failure. If the terminals are touched by someone's hands, clean the terminals with industrial alcohol.
 - There are switches and jumpers on this product that need to be set in advance. Be sure to check these before installing to the expansion slot.
 - Only set the switches and jumpers on this product to the specified settings.
 - Otherwise, this product may malfunction, overheat, or cause a failure.
-

DANGER

- Danger of explosion if battery is incorrectly replaced. Replace only with the same or equivalent type recommended by the manufacturer. Dispose of used batteries according to the manufacturer's instructions.
-

Environments

Use this product in the following environment. If used in an unauthorized environment, the board may overeat, malfunction, or cause a failure.

Operating temperature

0 - 60°C

Operating humidity

10 - 90%RH (No condensation)

Corrosive gases

None

Floating dust particles

Not to be excessive

Inspection

Inspection the product periodically as follows to use it safely.

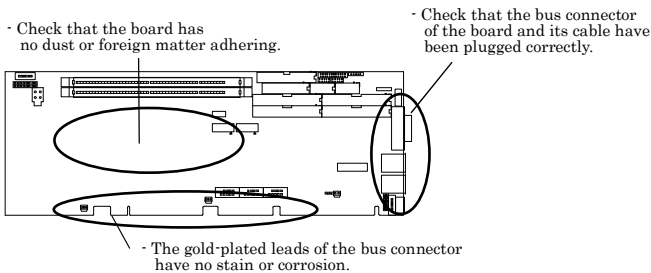

Storage

- (1) When storing this product, keep it in its original packing form.
- (2) Put the board in the storage bag.
- (3) Wrap it in the packing material, then put it in the box.
- (4) Store the package at room temperature at a place free from direct sunlight, moisture, shock, vibration magnetism, and static electricity.

Disposal

When disposing of the product, follow the disposal procedures stipulated under the relevant laws and municipal ordinances.

2. System Reference

Specification

Table 2.1. Functional Specifications [SPI-8451-LLVA, SPI-8452-LLVA] < 1 / 2 >

Type	Specifications	
	SPI-8451-LLVA	SPI-8452-LLVA
CPU(Optional)	Intel(R) Pentium(R) 4 Processor 1.7G - 2.8GHz (FSB400/533MHz) Intel(R) Celeron(R) Processor 1.7G - 2.6GHz (FSB 400 MHz) (Only corresponding to the Northwood core) Intel(R) Celeron(R) D Processor 2.26G - 2.8GHz (FSB 533MHz)	
Cache	Built in CPU	
Processor socket	Socket 478	
Memory (Option)	Two DIMM 184 pin socket for PC2700 DDR SDRAM up to 2GB.	
Chipset	Intel(R) 845GV Chipset includes GMCH (Graphics and Memory Controller Hub) ICH4 (I/O Controller Hub) and FWH (Firm Ware Hub)	
BIOS	Award BIOS, PnP support	
VGA	Graphics controller built in Intel 845GV chipset One Analog RGB/Panel Link I/F (One DVI-I connector), One LVDS(18bit) I/F (Two box-header 20-pin connectors)	
Multi I/O	Winbond W83627HF	
Keyboard / Mouse connector	One PS/2 keyboard/Mouse connector (Bundled the 2 in 1 cable), One box-header 5-pin connector for external keyboard.	
Serial I/F	16550 UART 10-pin connector box-header x 2 (RS-232C x 1, RS-232C/422A/485 x 1) Baud rate: 50 - 115,200bps (programmable)	
Parallel I/F	One box-header 26-pin connector, One high-speed parallel port, support SPP/EPP/ECP mode	
On board expansion bus	-	
LAN Port	1000BASE-T/100BASE-TX/10BASE-T Intel 82541PI controller 100BASE-TX/10BASE-T, Intel ICH4 integrated controller Two RJ-45 connectors, Wake On LAN support	
IDE I/F	Two EIDE ports, up to four IDE devices, Two box-header 40-pin connectors, support Ultra DMA 33/66/100	
SATA I/F	-	
FDD I/F	One FDD port, up to two floppy drives (360KB, 720KB, 1.2MB, 1.44MB, 2.88MB), One box-header 34-pin connector, 3.5inch 2mode I/F.	
Compact Flash Slot	-	
SSD Socket	-	
USB Port	6ch USB2.0 compliant ports, Three box-header 10-pin connector	
RAID *1	Support RAID 0 or 1, Two box-header 40-pin connectors (PDC2026R controller chip) Support Ultra DMA 33/66/100	None
Audio	AC97 CODEC., One pin-header 10-pin connector for speaker-out, line-in, microphone-in.	
Watchdog Timer	Software programmable 255 levels (1 - 255sec). Reset occurrence at the time of time up.	
General-purpose I/F	-	
Hardware Monitor	Monitoring of the temperature of CPU and board, power supply voltage, and fan speed	

Table 2.1. Functional Specifications [SPI-8451-LLVA, SPI-8452-LLVA] < 2 / 2 >

Type	Specifications									
	SPI-8451-LLVA	SPI-8452-LLVA								
RTC/CMOS	The RTC (real-time clock) and CMOS data backup by the lithium battery. The Lithium battery specification is shown in table <table border="1" data-bbox="348 261 707 371"> <thead> <tr> <th>Specification</th> <th>BR-2/3AC2P</th> </tr> </thead> <tbody> <tr> <td>Voltage</td> <td>3V</td> </tr> <tr> <td>Capacity</td> <td>1200mAh</td> </tr> <tr> <td>Weigh</td> <td>15.5g</td> </tr> </tbody> </table>		Specification	BR-2/3AC2P	Voltage	3V	Capacity	1200mAh	Weigh	15.5g
Specification	BR-2/3AC2P									
Voltage	3V									
Capacity	1200mAh									
Weigh	15.5g									
	* Backup time: Over 10 years at none AC power 25°C. * Real Time Clock accurate: ±3 minutes/month at 25°C.									
Power Management	Power management setup via BIOS Modem Ring On/Wake One LAN Supports PC98/PC99 ACPI Power management									
Bus specification/Size (mm)	PCI/ISA (PICMG) *2 / 338 (L) x 122 (H) x 28(W) *3									
DC Power Requirements	+5VDC±5% +12VDC±5% +5VSB (Stand by) ±5% (only when using the ATX power supply)									
Power supply specifications (Max.)	Intel Pentium 4 Processor 2.8 GHz : +5VDC, 5.4A +12VDC, 7.0A +5VSB, 0.5A									
Operating temperature / Operating Humidity	0 - 60°C (It depends on the specification of CPU and heat sink.) / 10 - 90%RH (No condensation)									
Storage temperature	-20 - 80°C									
Floating dust particles	Not to be excessive									
Corrosive gases	None									
Weight	517g									
Operating System Support	Windows XP Professional Windows XP Home Edition Windows 2000 Professional									

*1 : The RAID is not supported Hot Swap. The PC-SDD series is not able to use for the RAID drives.

*2 : ISA master and ISA memory refresh are not supported.

*3 : This board requires the width for 2slots (except CPU heatsink-fan high).

Table 2.2. Functional Specifications[SPI-8451-LVA] < 1 / 2 >

Type	Specifications								
CPU(Optional)	Intel(R) Pentium(R) 4 Processor 1.7G - 2.8GHz (FSB400/533MHz) Intel(R) Celeron(R) Processor 1.7G - 2.6GHz (FSB 400 MHz) (Only corresponding to the Northwood core) Intel(R) Celeron(R) D Processor 2.26G - 2.8GHz (FSB 533MHz)								
Cache	Built in CPU								
Processor socket	Socket 478								
Memory (Option)	Two DIMM 184 pin socket for PC2700 DDR SDRAM up to 2GB.								
Chipset	Intel(R) 845GV Chipset includes GMCH (Graphics and Memory Controller Hub) ICH4 (I/O Controller Hub) and FWH (Firm Ware Hub)								
BIOS	Award BIOS, PnP support								
VGA	Graphics controller built in Intel 845GV chipset VGA (Analog RGB) I/F: One H-DSUB 15-pin connector								
Multi I/O	Winbond W83627HF								
Keyboard / Mouse connector	One PS/2 keyboard/Mouse connector (Bundled the 2 in 1 cable), One box-header 5-pin connector for external keyboard.								
Serial I/F	16550 UART Two box-header 10-pin connector (RS-232C x 1, RS-232C/422A/485 x 1) Baud rate: 50 - 115,200bps (programmable)								
Parallel I/F	One box-header 26-pin connector, One high-speed parallel port, support SPP/EPP/ECP mode								
On board expansion bus	-								
LAN Port	100BASE-TX/10BASE-T, Intel ICH4 integrated controller One RJ-45 connectors, Wake On LAN support								
IDE I/F	Two EIDE ports, up to four IDE devices, Two box-header 40-pin connectors, support Ultra DMA 33/66/100								
SATA I/F	-								
FDD I/F	One FDD port, up to two floppy drives (360KB, 720KB, 1.2MB, 1.44MB, 2.88MB), One box-header 34-pin connector, 3.5inch 2mode I/F.								
Compact Flash Slot	-								
SSD Socket	-								
USB Port	6ch USB2.0 compliant ports, Three box-header 10-pin connector								
RAID	-								
Audio	AC97 CODEC., One pin-header 10-pin connector for speaker-out, line-in, microphone-in.								
Watchdog Timer	Software programmable 255 levels (1 - 255sec). Reset occurrence at the time of time up.								
General-purpose I/F	-								
Hardware Monitor	Monitoring of the temperature of CPU and board, power supply voltage, and fan speed								
RTC/CMOS	The RTC (real-time clock) and CMOS data backup by the lithium battery. The coin type Lithium battery specification is shown in table <table border="1" data-bbox="416 1225 776 1337"> <thead> <tr> <th>Specification</th> <th>CR2032</th> </tr> </thead> <tbody> <tr> <td>Voltage</td> <td>3V</td> </tr> <tr> <td>Capacity</td> <td>220mAh</td> </tr> <tr> <td>Weigh</td> <td>3.1g</td> </tr> </tbody> </table> <p>* Backup time: Over 4 years at none AC power 25°C. * Real Time Clock accurate: ±3 minutes/month at 25°C.</p>	Specification	CR2032	Voltage	3V	Capacity	220mAh	Weigh	3.1g
Specification	CR2032								
Voltage	3V								
Capacity	220mAh								
Weigh	3.1g								

Table 2.2. Functional Specifications [SPI-8451-LVA] < 2 / 2 >

Type	Specifications
Power Management	Power management setup via BIOS Modem Ring On/Wake One LAN Supports PC98/PC99 ACPI Power management
Bus specification/Size (mm)	PCI/ISA (PICMG) *1 / 338 (L) x 122 (H) x 28(W) *2
DC Power Requirements	+5VDC±5% +12VDC±5% +5VSB (Stand by) ±5% (only when using the ATX power supply)
Power supply specifications (Max.)	Intel Pentium 4 Processor 2.8 GHz : +5VDC, 5.4A +12VDC, 7.0A +5VSB, 0.5A
Operating temperature / Operating Humidity	0 - 60°C (It depends on the specification of CPU and heat sink.) 10 - 90%RH (No condensation)
Storage temperature	-20 - 80°C
Floating dust particles	Not to be excessive
Corrosive gases	None
Weight	463g
Operating System Support	Windows XP Professional Windows XP Home Edition Windows 2000 Professional

*1 ISA master and ISA memory refresh are not supported.

*2 This board requires the width for 2slots (except CPU heatsink-fan height).

Power Requirements

Your system requires a clean, steady power source for reliable performance of the high frequency CPU on the product, the quality of the power supply is even more important.

Power Consumption

For typical configurations, the CPU board is designed to operate with at least a 250W power supply. A higher-wattage power supply should be used for heavily-loaded configurations. The power supply must meet the following requirements:

- Rise time for power supply: 2 ms - 20 ms
- Minimum delay for reset to Power Good: 100ms
- Minimum Power down warning: 1 ms

The following table lists the power supply's tolerances for DC voltages:

Table 2.3. DC voltage tolerance

DC Voltage	Acceptable Tolerance
+ 5V	$\pm 5\%$
+ 5VSB (Stand by)	$\pm 5\%$
+ 12V	$\pm 5\%$

Connector & Jumper Location

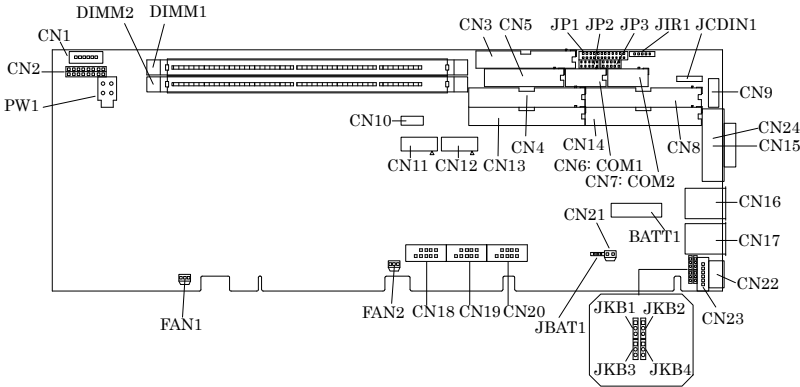

Figure 2.1. Connector & Jumper Location

Item	Content	Item	Content
CN1	ATX power control Connector	CN21	External Battery Connector (SPI-8451-LVA only)
CN2	Front Panel Connector	BATT1	Battery Holder (SPI-8451-LVA only)
CN3	Floppy Disk Drive Connector	CN22	Keyboard / Mouse Connector
CN13, CN4	Primary / Secondary IDE Connector	CN23	External Keyboard Connector
CN5	Parallel Port Connector	DIMM1, DIMM2	DIMM Memory Socket
CN6, CN7	Serial Port Connector	FAN1	CPU FAN Connector
CN14, CN8	Primary / Secondary IDE RAID Connector (SPI-8451-LLVA only)	FAN2	System FAN Connector
CN9	Audio Connector	PW1	+12V power supply Connector
CN10	Backlight connector (SPI-8451-LLVA, SPI-8452-LLVA only)	JCDIN	CD-IN Connector
CN11, CN12	LVDS Connector (SPI-8451-LLVA, SPI-8452-LLVA only)	JBAT1	Clear CMOS
CN15	DVI-I Connector (SPI-8451-LLVA, SPI-8452-LLVA only)	JIR1	IrDA Connector
CN24	VGA Connector (SPI-8451-LVA only)	JP1, JP3	RS-232C/422/485 selector
CN16	100/1000 BASE-TX LAN connector (SPI-8451-LLVA, SPI-8452-LLVA only)	JP2	RS-422/485 Terminator
CN17	10/100 BASE-TX LAN connector	JKB1, JKB2, JKB3, JKB4	Keyboard/Mouse signal selector
CN18, CN19, CN20	USB Connector		

Block Diagram

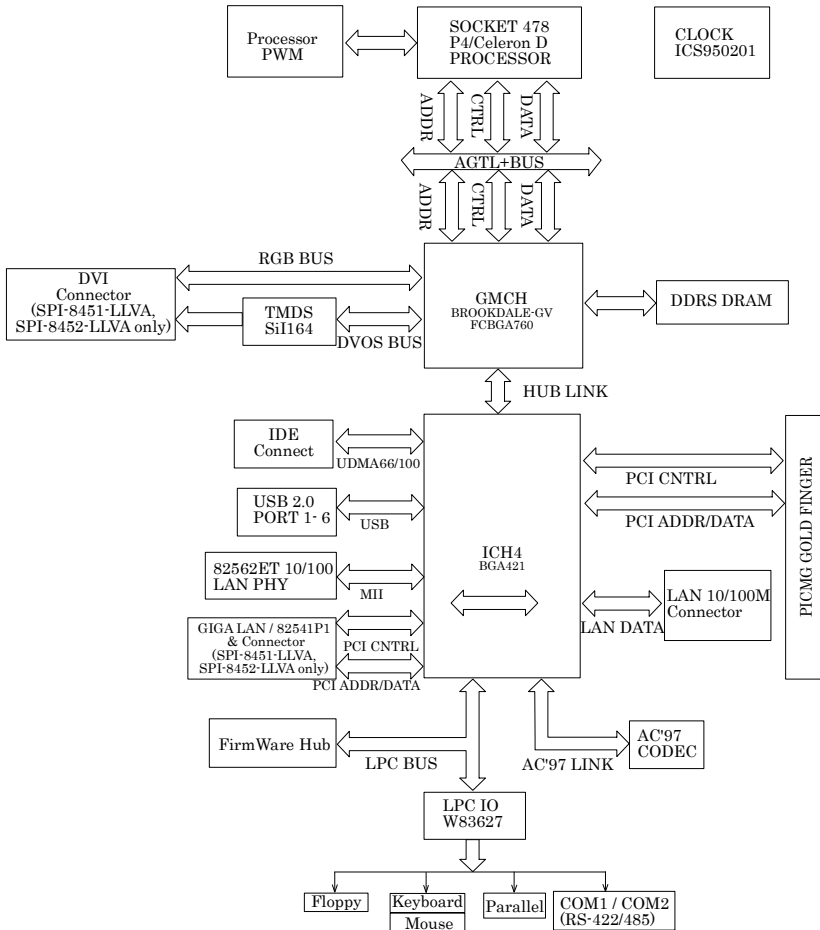

Figure 2.2. Block Diagram

3. Hardware Installations

This chapter provides information on how to use the jumpers and connectors on this product in order to set up a workable system.

Installation procedure

- (1) Confirm the power supply is off.
- (2) Install the processor with correct orientation.
- (3) Insert the DRAM module with correct orientation.
- (4) Mount the fan on the top of the processor and connect it to FAN1 connector.
- (5) Insert +12V Power Supply cable to PW1 connector.
- (6) The jumpers are set up according to the conditions to be used.
- (7) Insert all external cables except for flat panel. (Hard disk, floppy, keyboard, Mouse, LAN, etc.).
- (8) Insert CRT or LCD monitor to VGA connector.
- (9) Turn on the power.
- (10) Enter the BIOS setup mode by pressing 'Del' key during boot up.
- (11) Use the "Load BIOS Optimal Defaults" feature.
- (12) Configure the Peripheral Setup and the Standard Setup correctly.



CAUTION

The CMOS memory may be in an undefined state at power-on after a period of no battery backup.

CPU Installation:

This product supports a single Intel 478pin FC-PGA2 type **Pentium 4, Celeron D or Celeron** processor. The processor's VID pins automatically program the voltage regulator on the CPU board to the required processor voltage. The host bus speed is automatically selected. The processor connects to the CPU board through the 478-pins socket.

The CPU board supports the processors listed in table below:

Table 3.1. CPU list

Celeron processor	
Host Bus frequency	Cache size
400MHz	128KB
Celeron D processor	
Host Bus frequency	Cache size
533MHz	256KB
Pentium 4 processor	
Host Bus frequency	Cache size
400MHz/533MHz	256K/512K/1MB

The socket-478 comes with a lever to secure the CPU. Make sure the notch on the corner of the CPU corresponds with the notch on the inside of the socket.

The CPU should always have a Heat Sink and a cooling fan attached to prevent overheating.

CAUTION

Ensure that the CPU heat sink and the CPU top surface are in total contact to avoid CPU overheating problem that would cause your system to hang or be unstable.

The heights of the heat sink that optional CPU.

PCP4-24, PCP4C-20: 70mm

PCP4-28S, PCP4C-20S: 83mm

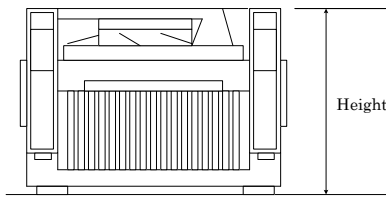

Main Memory Installation: DIMM1, DIMM2

This product's PICMG Industrial CPU Board supports one single-side or double-sided DDR200 (PC1600)/266(PC2100)/333(PC2700) unregistered DIMM, 184-pin DIMM sockets for a maximum memory of 2GB. Using the non-ECC DDR SDRAM DIMM.

The CPU board supports the following memory features:

- 184-pin DDR SDRAM DIMM with gold-plated contacts
- 200MHz (PC1600) / 266MHz (PC2100) / 333MHz (PC2700) DDR SDRAM (333MHz limited in 533MHz FSB speed)
- Non-ECC function support.
- Un-buffer single or double-sided DIMM in the following sizes:

The CPU board supports single or double-sided DIMMs in the following sizes:

Table 3.2. DDR SDRAM

DIMM Capacity	DDR SDRAM Density	DDR SDRAM Organization Front side / Back side	Number of Devices
64MB	64Mbit	8M x8 / None	8
64MB	128Mbit	8M x16 / None	4
128MB	64Mbit	8M x8 / 8M x8	16
128MB	128Mbit	16M x8 / None	8
128MB	256Mbit	32M x8 / None	4
256MB	128Mbit	16M x8 / 16M x8	16
256MB	256Mbit	32M x8 / None	8
256MB	512Mbit	32M x16 / None	4
512MB	256Mbit	32M x8 / 32M x8	16
512MB	512Mbit	64M x8 / None	8
1GB	512Mbit	64M x8 / 64M x8	16

CAUTION

All memory components and DIMM used with this product's CPU board must comply with the PC SDRAM Specification. These include: the PC SDRAM Specification (memory component specific), the PC Un-buffered DIMM Specification, and the PC Serial Presence Detect Specification.

ATX Power Control Connector: CN1

When used with an ATX-compliant power supply that supports remote power on/off, the CPU board can turn off the system power through software control.

To enable soft-off control in software, advanced power management must be enabled in the Setup program and in the operation system. When the system BIOS receives the correct APM command from the operating system, the BIOS turns off power to the computer.

Table 3.3. ATX power control Connector

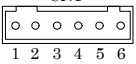
	
Pin No.	Function
6	PCI_PME#
5	GND
4	PSWIN
3	GND
2	PS_ON
1	5VSB

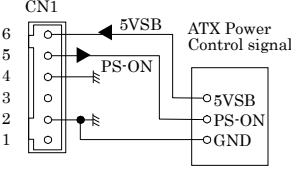

Housing : XHP-6 (JST)
 Contact : SXH-001T-P0.6 (JST)

- 5VSB : Input 5V standby power from ATX power supply.
- PS_ON : Output for ATX power supply On/Off control.
- PSWIN : Connect power push switch. The same function as CN2-1pin (PowerBT).
- PCI_PME# : Connect to PME# signal of PCI bus, this CPU board can wake up from the PCI board which supports PME (Power Management Event) function. When you do not use this function, please keep open.

Front Panel Connector: CN2

This header can be connected to a front panel power switch. The front panel connector includes headers for these I/O connections:

Power switch

This header can be connected the power on switch when ATX power supply use.

Power LED

This header can be connected to an LED that will light when the computer is powered on.

Hard drive activity LED

This header can be connected to an LED to provide a visual indicator that data is being read from or written to an IDE hard drive. For the LED to function properly, the IDE drive must be connected to the onboard IDE controller.

Speaker

A speaker can be installed on this product as a manufacturing option. The speaker is enabled by a jumper on pins 9, 11, 13, 15 of the front panel connector. The speaker (onboard or offboard) provides error beep code information during the POST in the event that the computer cannot use the video interface. The speaker is not connected to the audio subsystem and does not receive output from the audio subsystem.

Table 3.4. Front Panel Connector

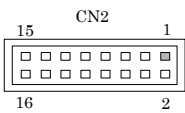
			
Pin No.	Function	Pin No.	Function
1	Power BT	2	VCC
3	GND	4	IDE ACT
5	RESET	6	N.C.
7	GND	8	VCC
9	VCC	10	VCC
11	GND	12	Power LED
13	GND	14	N.C.
15	BUZZER	16	N.C.

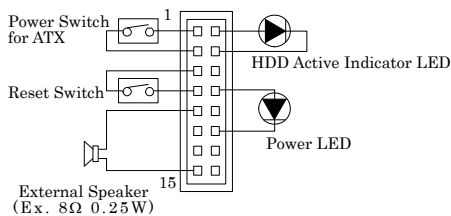

Speaker	9, 11, 13, 15	Power Button	1, 3
Reset Button	5, 7	HDD LED	2, 4
Power LED	8, 10, 12		

Floppy Disk Connector: CN3

The floppy interface can be configured for the following floppy drive capacities and sizes:

- 360 KB, 5.25-inch
- 1.2 MB, 5.25-inch
- 720 KB, 3.5-inch
- 1.44 MB, 3.5-inch
- 2.88 MB, 3.5-inch

This connector supports the provided floppy drive ribbon cable. After connecting the single end to the board, connect the two plugs on the other end to the floppy drives.

Table 3.5. Floppy Disk Drive Connector

Pin No.	Function	Pin No.	Function
1	GND	2	RWC
3	GND	4	N.C.
5	GND	6	N.C.
7	GND	8	INDEX
9	GND	10	DS0
11	GND	12	DS1
13	GND	14	DS2
15	GND	16	MOT ON
17	GND	18	DIR
19	GND	20	STEP
21	GND	22	WD
23	GND	24	WG
25	GND	26	TRCK 0
27	GND	28	WP
29	GND	30	RD
31	GND	32	SIDE 1
33	GND	34	DSK CHG

Primary / Secondary IDE Connector: CN13/CN4

This product provides two bus-mastering PCI IDE interface. This interface support PIO Mode 3, PIO Mode 4, ATAPI devices (e.g., CD-ROM), and Ultra DMA/33/66/100 synchronous-DMA mode transfers. The BIOS supports logical block addressing (LBA) and extended cylinder head sector (ECHS) translation modes. The BIOS automatically detects the IDE device transfer rate and translation mode.

This connector supports the provided IDE hard disk ribbon cable. After connecting the single end to the board, connect the two plugs at the other end to your hard disk(s). If you install two hard disks, you must configure the second drive to Slave mode by setting its jumper accordingly. Please refer to your hard disk documentation for the jumper setting

Table 3.6. Primary/Secondary IDE Connector

CN13/CN4			
39			1
40			2
Pin No.	Function	Pin No.	Function
1	RESET	2	GND
3	D7	4	D8
5	D6	6	D9
7	D5	8	D10
9	D4	10	D11
11	D3	12	D12
13	D2	14	D13
15	D1	16	D14
17	D0	18	D15
19	GND	20	N.C.
21	DREQ	22	GND
23	IOW	24	GND
25	IOR	26	GND
27	IRDY	28	ALE
29	DACK	30	GND
31	IRQ	32	N.C.
33	A1	34	P66DET
35	A0	36	A2
37	CS0	38	CS1
39	HD ACT	40	GND

Parallel Port Connector: CN5

The parallel port bracket can be used to add an additional parallel port for additional parallel devices. There are four options for parallel port operation:

- Compatible (Standard mode)
- Bi-Directional (PS/2 compatible)
- Bi-Directional EPP. A driver from the peripheral manufacturer is required for operation.
- Bi-Directional High-speed ECP

Table 3.7. Parallel Port Connector

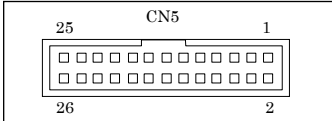

Pin No.	Function	Pin No.	Function
1	STROBE	2	ALF
3	PD0	4	ERROR
5	PD1	6	INIT
7	PD2	8	SLCT IN
9	PD3	10	GND
11	PD4	12	GND
13	PD5	14	GND
15	PD6	16	GND
17	PD7	18	GND
19	ACK	20	GND
21	BUSY	22	GND
23	PE	24	GND
25	SLCT	26	N.C.

Serial Port connector: CN6, CN7

Serial1 (CN6) and Serial2 (CN7) are 10-pins box-headers. Both are on board serial ports of the product. The following table shows the pin assignments of these connectors. RS-232C/422/485 assigned for Serial2 (CN7) connector only.

Table 3.8. Serial Port connector

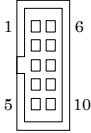
	Pin No.	RS-232C	RS-422*	RS-485*
	1	DCD	TX-	TX-
2	RXD	TX+	TX+	
3	TSD	RX+	RX+	
4	DTR	RX-	RX-	
5	GND	GND	GND	
6	DST	RTS-	N.C.	
7	RTS	RTS+	N.C.	
8	CTS	CTS+	N.C.	
9	RI	CTS-	N.C.	
10	N.C.	N.C.	N.C.	

*RS-422/485 assigned for Serial2(CN7) connector only.

Pin assignment after conversion by attached cable (D-SUB 9Pin Male Connector, No.4-40UNC)

Table 3.9. Attached cable (9pin D-SUB) pin assignment

Pin No.	RS-232C	RS-422	RS-485
1	DCD	TX-	TX-
2	RXD	TX+	TX+
3	TXD	RX+	RX+
4	DTR	RX-	RX-
5	GND	GND	GND
6	DSR	RTS-	N.C.
7	RTS	RTS+	N.C.
8	CTS	CTS+	N.C.
9	RI	CTS-	N.C.

CAUTION

- For RS-485, TX+(pin 2) and RX+ (pin 3) must jumper together inside the D type connector.
- TX- (pin 1) and RX- (pin 4) is the same.

RS-422 / RS-485 specifications

- Transmission system: Asynchronous, half-/full-duplex serial transmission conforming to RS-422/RS-485
- Baud rate: 50 - 115,200bps (programmable)
- Signal extensible distance: 1.2km Max.

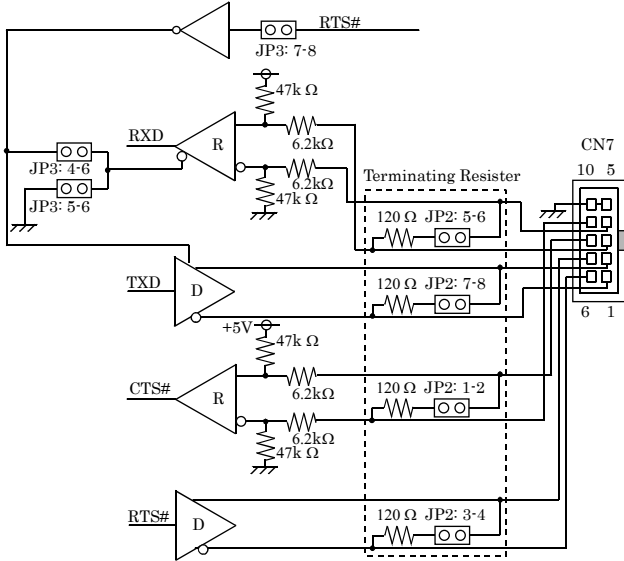

Figure 3.1. RS-422 / RS-485

IDE RAID Connector: CN14, CN8 (SPI-8451-LLVA only)

The CPU board SPI-8451-LLVA using the chipset of Promise PDC20265R for IDE RAID port that with the bus-mastering design takes full advantage of multi-tasking, multi-threading operating systems and greatly improves performance.

Provides scatter/gather DMA mechanism that complies with Revision 1.0 of the programming interface for Bus Master IDE Controller.

Scatter/Gather mechanism supports both DMA and PIO IDE drives and ATAPI devices. Allows byte-boundary memory region during Bus Master DMA transfers which benefits operating systems or applications, which has odd byte boundary memory transfers.

Dual independent data paths with read ahead and write posting for each channel supported for dual IDE channels to balanced bus loading and optimal performance.

Table 3.10. IDE RAID Connector

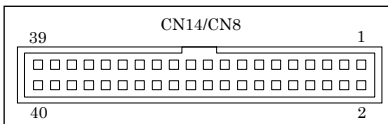

Pin No.	Function	Pin No.	Function
1	RESET	2	GND
3	D7	4	D8
5	D6	6	D9
7	D5	8	D10
9	D4	10	D11
11	D3	12	D12
13	D2	14	D13
15	D1	16	D14
17	D0	18	D15
19	GND	20	N.C.
21	DREQ	22	GND
23	IOW	24	GND
25	IOR	26	GND
27	IORDY	28	ALE
29	DACK	30	GND
31	IRQ	32	N.C.
33	A1	34	P66DET
35	A0	36	A2
37	CS0	38	CS1
39	HD ACT	40	GND

Audio Connector: CN9

This connector connects the Audio jack cable.

Table 3.11. Audio Connector

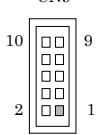
	Pin No.	Function	Pin No.	Function
		1	LINE-OUT-R	2
	3	GND	4	N.C.
	5	N.C.	6	MIC-IN
	7	GND	8	GND
	9	LINE-IN-R	10	LINE-IN-L

CD-IN Connector: JCDIN

This connector is used to connect CD Audio cable from CD-ROM or DVD drive to onboard sound.

Table 3.12. CD-IN Connector

	Pin No.	Function
		1
	2	GND
	3	GND
	4	Audio-R

DVI-I Connector: CN15

(SPI-8451-LLVA, SPI-8452-LLVA only)

This connector is DVI-I connector for CRT/LCD. The pin assignment is shown below.

In use the CRT (Analog RGB display), need the DVI-I-Analog RGB conversion adapter.

20 pin and 21 pin are connecting to Serial1 for the touch panel signal. CN6 cannot be used when using this signal.

Table 3.13. DVI-Analog RGB converter

Connector type		DVI-I 29pin			
Pin No.	Signal name	Pin No.	Signal name	Pin No.	Signal name
1	DATA2-	13	N.C.	C1	RED
2	DATA2+	14	+5V	C2	GREEN
3	DATA2 SHIELD	15	GND	C3	BLUE
4	N.C.	16	HPD	C4	HSYNC
5	N.C.	17	DATA0-	C5	GND
6	DDC CLK	18	DATA0+		
7	DDC DATA	19	DATA0 SHIELD		
8	VSYNC	20	FPS_OUT(TxD)		
9	DATA1-	21	FPS_IN(RxD)		
10	DATA1+	22	DATA0 SHIELD		
11	DATA1 SHIELD	23	CLK+		
12	N.C.	24	CLK-		

VGA Connector: CN24 (SPI-8451-LVA only)

It is a VGA CRT connector. The pin assignments are as follows:

Table 3.14. VGA Connector (CN24)

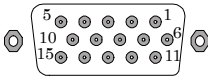
	PIN No.	Function	PIN No.	Function
	1	Red	2	Green
	3	Blue	4	N.C
	5	GND	6	GND
	7	GND	8	GND
	9	VCC	10	GND
	11	N.C	12	DDC data
	13	H-Sync	14	V-Sync
	15	DDC clock	16	N.C

LVDS LCD panel Connector: CN11 / CN12 (SPI-8451-LLVA, SPI-8452-LLVA only)

CN11 and CN12 consist of 20-pin connectors that using the Hirose's DF13A-20DP-1.25V. This product supports LVDS LCD panel display.

LVDS 18bit output, VGA (640×480), SVGA (800 x 600), XGA (1024 x 768), SXGA (1280 x 1024)

Please ask us the connectable display.

Table 3.15. LVDS LCD panel Connector

Pin No.	Function	Pin No.	Function
2	TX0-	1	TX0+
4	GND	3	GND
6	TX1-	5	TX1+
8	VDD	7	GND
10	TX3-	9	TX3+
12	TX2-	11	TX2+
14	GND	13	GND
16	CLK1-	15	CLK1+
18	B_DATA	17	B_CLK
20	VDD	19	GND

Pin No.	Function	Pin No.	Function
2	TX4-	1	TX4+
4	GND	3	GND
6	XT5-	5	TX5+
8	VDD	7	GND
10	XT7-	9	TX7+
12	TX6-	11	TX6+
14	GND	13	GND
16	CLK2-	15	CLK2+
18	N/C	17	N/C
20	VDD	19	GND

VDD : +3.3V LCD power out (1A Max.)

Housing: DF13-20DS-1.25C (HIROSE)

Contact: DF13-2630SCF (HIROSE)

LCD Backlight Connector: CN10 (SPI-8451-LLVA, SPI-8452-LLVA only)

This is a 5-pin connector for backlight connector.

Table 3.16. LCD Backlight Connector

CN10	
	
1 2 3 4 5	
Pin No.	Function
1	Backlight
2	GND
3	N.C.
4	GND
5	VCC

Housing: PHR-5 (JST)

Contact: SPH-002T-P0.5S (JST)

Backlight : +12V Backlight power out (1A Max.)

VCC : +5V power out (500mA Max.)

GIGA LAN Connector: CN16

(SPI-8451-LLVA, SPI-8452-LLVA only)

This connector is for the 10/100/1000 Base-TX LAN I/F that has LED indicated the Transfer rate / Link / Act status of Ethernet capability of the CPU board. The follow table shows the pin assignments of this connector.

Table 3.17. GIGA LAN connector (CN16)

CN16 Speed LED 	Pin No.	Function	Pin No.	Function
		1	TD0+	5
	2	TD0-	6	TD2-
	3	TD1+	7	TD3+
	4	TD1-	8	TD3-

Left LED: Speed LED

10M: OFF, 100M: Green, 1000M: Yellow

Right LED: Link/Act LED

Link: Green, Act: Blink

10/100 BASE-TX LAN Connector: CN17

This connector is for the 10/100BASE-TX LAN I/F that has LED indicated the 10/100Mbps transfer rate / Link / Act status of Ethernet capability of the product. The follow table shows the pin assignments of this connector.

Table 3.18. 10/100 BASE-TX LAN Connector (CN17)

CN17 Speed LED 	Pin No.	Function	Pin No.	Function
		1	TX+	5
	2	TX-	6	RX-
	3	RX+	7	N.C.
	4	N.C.	8	N.C.

Left LED: Speed LED

10M: OFF, 100M: Orange

Right LED: Link/Act LED

Link: Green, Act: Blink

USB Connector: CN18, CN19, CN20

This product have three USB (v2.0 compliant) pin-header connector (USB0/1: CN18, USB2/3: CN19, USB4/5: CN20).

Table 3.19. USB Pin-header Connector (CN18, CN19, CN20)

	Pin No.	Function	Pin No.	Function
	1	VCC0	2	VCC1
	3	USBP0-	4	USBP1-
	5	USBP0+	6	USBP1+
	7	USBG	8	USBG
	9	N.C.	10	GND

* Pin 9 is reverse-of the connector and empty pin of prevention.

* Optional USB Cable: USB Connector Cable

⚠ CAUTION
 Computer systems that have an unshielded cable attached to a USB port may not meet FCC Class requirements, even if no device or a low-speed USB device is attached to the cable. Use shielded cable that meets the requirements for full-speed devices.

External Battery Connector: CN21 (SPI-8451-LVA only)

It is a 2 Pin connector used for external battery. An external battery power for used of Real-time clock and CMOS memory.

Table 3.20. External Battery Connector

	Pin No.	Function	Housing: IL-2S-S3L-(N) (JAE) Contact: IL-C2-1-10000 (JAE)
	1	GND	
	2	External battery (3V)	

SPI-8451-LLVAS / SPI-8452-LLVAS has the large capacity battery connected to this connector as standard.

Keyboard / Mouse Connector: CN22

The CPU board provides a standard PS/2 keyboard/mouse connector for attaching a PS/2 keyboard/mouse. You will connect with an add-on cable for a PS/2 keyboard/mouse. You can select that plug a PS/2 mouse directly, PS/2 keyboard directly or both (use Y-cable) by jumper setting.

The PS2 Connector pin definition is shown below:

Table 3.21. Keyboard / Mouse Connector (CN22)











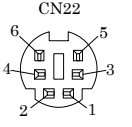

	Pin No.	Function
	1	KB or MS Data
	2	MS or KB DATA
	3	GND
	4	+5VSB
	5	KB or MS Clock
6	MS or KB Clock	

Table 3.22. K/B & M/S Select Jumpers: JKB1, JKB2, JKB3, JKB4

Select the function	JKB1	JKB2	JKB3	JKB4
Plug Keyboard	 1 2 3	 1 2 3	 1 2 3	 1 2 3
Plug PS/2 Mouse	 1 2 3	 1 2 3	 1 2 3	 1 2 3
Plug Keyboard & Mouse * (Y-cable to connection)	 1 2 3	 1 2 3	 1 2 3	 1 2 3

* Default factory setting

EXT. Keyboard Connector: CN23

This is a 5-pin connector for external keyboard.

Table 3.23. External Keyboard Connector

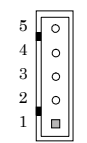
	Pin No.	Function
	5	VCC
	4	GND
	3	N.C.
	2	KB Data
1	KBClock	

Housing: XHP-5(JST)
Contact : SXH-001T-P06(JST)

+12V Power supply Connector: PW1

The power supply that conformed for ATX12V is used, this connector connect 4Pin +12V cable directly from power supply. Use the +12V power cable of the accessories, when other power supplies are used.

Table 3.24. +12V power supply Connector

	Pin No.	Function	Pin No.	Function
		2	GND	4
	1	GND	3	+12V

CPU FAN Connector: FAN1

FAN1 is a 3-pins box-header for the CPU cooling fan power connector. The fan must be a 12V fan. Pin 3 is for Fan speed sensor input.

Table 3.25. CPU FAN Connector

	Pin No.	Function
		1
	2	POWER
	3	FAN

Housing : 5102-03 (molex)
Contact : 5103 (molex)

System FAN Connector: FAN2

FAN2 is a 3-pins box-header for the system cooling fan power connector. The fan must be a 12V fan. Pin 3 is for Fan speed sensor input. Pin 2 is for +12V power supply.

Table 3.26. System FANConnector

	Pin No.	Function
		1
	2	POWER
	3	FAN

Housing : 5102-03 (molex)
Contact : 5103 (molex)

4. Jumper Setting

RS-232/422/485 Selector: JP1, JP3

Table 4.1. RS-232C/422/485 Selector (JP1, JP3)

RS-232C (Default)	JP1 23 21 19 17 15 13 11 9 7 5 3 1 25 22 20 18 16 14 12 10 8 6 4 2	JP3 9 7 5 3 1 10 8 6 4 2
	JP1 23 21 19 17 15 13 11 9 7 5 3 1 25 22 20 18 16 14 12 10 8 6 4 2	JP3 9 7 5 3 1 10 8 6 4 2
RS-485	JP1 23 21 19 17 15 13 11 9 7 5 3 1 25 22 20 18 16 14 12 10 8 6 4 2	JP3 9 7 5 3 1 10 8 6 4 2
<ol style="list-style-type: none"> 1. For RS-485, TX+(pin 2) and RX+ (pin 3) must jumper together inside the D type connector. 2. TX- (pin 1) and RX- (pin 4) is the same. 		

Transmit data control in half-duplex mode

In half-duplex mode, the transmission buffer must be controlled to prevent transmit data from causing a collision. This product uses the RTS signal and bit 1 in the modem control register to control transmit data.

Modem control register

(Setting I/O address +4H) bit 1: 0 ... RTS High (Disables transmission)
 1 ... RTS low (Enables transmission)

Setting the RS-422/RS-485 receiver disable control jumper

When the RS-422/RS-485 port is used, the RTS signal is used for driver enable control. Connecting JP1 Pins 4 and 6 disables the receiver at the same time, preventing the port from receiving output data to an external device.

RS-422 Setting

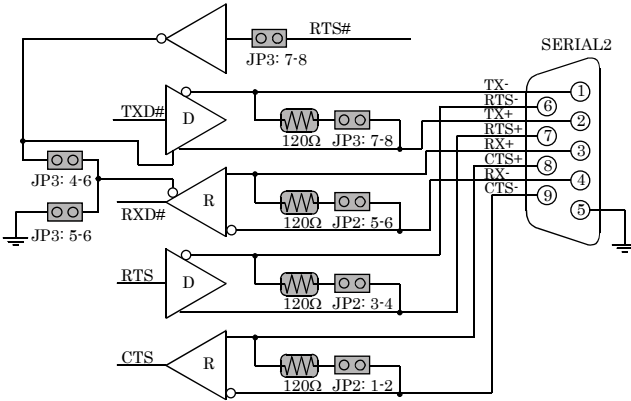

Figure 4.1. RS-422 Setting

RS-485 Setting

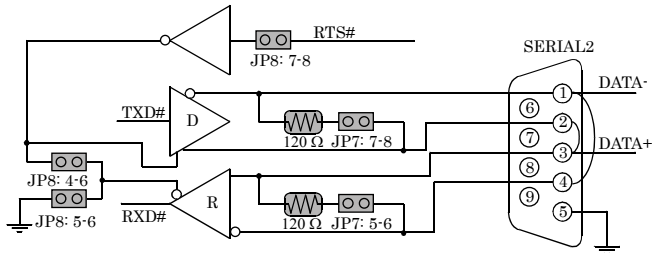

Figure 4.2. RS-485 Setting

I/O addresses and instructions





The table below lists I/O addresses for use as SERIAL2.

Table 4.2. I/O Addresses and instructions

I/O address	DLAB	Read/Write	Register	
02F8H	0	W	Transmitter holding Register	THR
		R	Receiver buffer Register	RBR
02F9H	1	W	Divisor latch Register (LSB)	DLL
		W	Divisor latch Register (MSB)	DLM
02FAH	0	W	Interrupt enable Register	IER
02FAH	X	R	Interrupt ID Register	IIR
02FBH	X	W	Line control Register	LCR
02FCH	X	W	Modem Control Register	MCR
02FDH	X	R	Line status Register	LSR
02FEH	X	R	Modem Status Register	MSR
02FFH	X	R/W	Scratch Register	SCR

RS-422/485 Terminator: JP2



Table 4.3. RS-422/485 Terminator (JP2)

JP2	Terminator	Function
	---	No terminating resistor (Default)
	CTS for RS-422	Terminating resistor provided
	RTS for RS-422	Terminating resistor provided
	RXD for RS-422/485	Terminating resistor provided
	TXD for RS-422/485	Terminating resistor provided

Clear CMOS Content: JBAT1

The time, date, and CMOS values can be specified in the Setup program. The CMOS values can be returned to their defaults by using the Setup program. The RAM data contains the password information is powered by the onboard battery. User can erase the CMOS memory content by short pin2 and pin3 of JBAT1.

Table 4.4. Clear CMOS Content (JBAT1)

JBAT1	Function
	Normal Operation(Default)
	Clear CMOS Content

5. Board Resources

System address map

The GMCH memory map includes a number of programmable ranges. All of these ranges must be unique and non-overlapping. There are no hardware interlocks to prevent problems in the case of overlapping ranges. Accesses to overlapped ranges may produce indeterminate results.

Table 5.1. Compatibility Area

Address	Description
0 - 640KB	DOS area
640 - 768KB	Video Buffer area
768 - 896KB	Expansion Area
896 - 960KB	Extended System BIOS Area
960 - 1MB	System BIOS Area

Table 5.2. Memory Segment

Memory Segments	Comments
00000h - 9FFFFh	0 - 640K DOS Region
A0000h - BFFFFh	Video Buffer
B0000h - B7FFFh	Monochrome Adapter range
C0000h - CBFFFh	Video BIOS
CC000h - CFFFFh	Reserved
D0000h - DFFFFh	Expansion Area
E0000h - EFFFFh	Extended System BIOS Area
F0000 - FFFFFh	System BIOS Area
100000h - 7FFFFFFFh	Extended Memory Area
00100000 to Top of Main Memory	Main DRAM Address Range
Top of Main Memory	Extended SMRAM Address Range
Top of Main Memory To 4GB	PCI Memory Address Range
FEC0000h - FECFFFFFFh, FEE00000h - FEEFFFFFFh	APIC configuration space
FFE0000h - FFFFFFFFh	High BIOS Area

PCI Routing Information

Tabled 5.3. PCI Routing Information

IDSEL	INT	Onboard Function
AD23	INT F	LAN Intel 82541
AD25	INT G	RAID: PDC20265R

6. RAID Controller

Important data protection information

You should back up all data before installing any drive controller or storage peripheral. We are not responsible for any loss of data resulting from the use, disuse or misuse of the RAID device.

⚠ CAUTION

When you need to use RAID function, you must connect compatible IDE device with connector CN8 and CN14.

⚠ DANGER

- Before installing the driver into an existing existing system, backup any necessary data. Failure to follow this accepted PC practice could result in data loss.
- When installing the hard drives, if you wish to include your current bootable drive using the Windows 2000 operating system as part of a bootable Mirrored (RAID1) array on your RAID device, do NOT connect the hard drive to the RAID connector yet. You MUST install the Windows 2000 driver software first to this drive while it is still attached to your existing hard drive controller.
- This board is not supporting the hot swap of the drive.

Hard drives must be Ultra ATA/100, Ultra ATA/66, Ultra ATA/33, EIDE and / or Fast ATA-2 compatible to operate with the RAID controller. For optimal performance, install all identical drives of the same model and capacity. The drive's matched performance allows the array to function better as a single drive.

1. We recommend using identical drive as part of a "FastTrak1000-Lite" array. If striping for performance, use two new drives. If mirroring for protection, you can use two new drives OR use an existing drive and a new drive (the new drive must be the same size or larger than the existing drive).
2. Configure the jumpers of the hard drive you're preparing to connect to the RAID device connector using the correct "Master / Slave" or "Cable-Select" settings in the positions described in the table below.

⚠ CAUTION

Sometimes the Master drive with no slave attached is called "Single". The master slave setting differentiates two drives chained

Jumper Settings		
# of Drives	IDE Channel 1	IDE Channel 2
1	M	----
2	M	M
3	M & S	M
4	M & S	M & S

M = Master, S = Slave

3. Install the hard drives into the hard drive bays of your system, including the power cables.
4. Attach one Ultra ATA cable to each hard drive. Then attach one cable to each of the IDE connector on the SPI-8451-LLVA board. The colored edge of the cable(s) indicates pin 1, and the blue cable connector must be attached to the SPI-8451-LLVA connector.



CAUTION

You must use an 80-wire, 40-pin cable when connecting an Ultra ATA66/100 hard drive to the SPI-8451-LLVA connector

Creating Your Disk Array

You will now use the FastBuild™ BIOS utility to create your array using the attached drives. There are three different scenarios in creating this array. You can create an array for performance, you can create a Security array using new hard drives (recommended), or you can create a Security array using an existing hard drive and a new hard drive.

⚠ DANGER

If creating a Security array using an existing hard drive, backup any necessary data. Failure to follow this accepted PC practice could result in data loss.

1. Boot your system. If this is the first time you have booted with the RAID controller and drives installed, the Promise onboard BIOS will display the following screen.

```
FastTrak100 (tm) "Lite" BIOS Version 2.xx.x.xx
(c) 1995-2001 Promise Technology, Inc. All rights reserved.

No array defined . . .

Press <Ctrl-F> to enter FastBuild (tm) Utility or
Press <ESC> to continue booting...
```

2. Press <Ctrl-F> keys to display the FastBuild™ Utility Main Menu.
3. Press "1" to display the Auto Setup Menu below. This is the fastest and easiest method to creating your first array.

FastBuild (tm) Utility 1.xx © 1996-2001 Promise Technology, Inc.

```
[Auto Setup Options Menu]
Optimize Array for:      Performance
Typical Application to use:  DESKTOP
```

```
[ Auto Setup Configuration ]
Mode.....Stripe
Spare Drive .....0
Drive(s) Used in Array.....2
Array Disk Capacity (size in MB).....16126
```

[Keys Available]

[↑] Up [↓] Down [←, , Space] Change Option [ESC] Exit [CTRL-Y] Save

Creating an Array for Performance

CAUTION

RAID controller allows users to create striped arrays with 1, 2 drives.

To create an array for best performance, follow these steps:

1. Using the Spacebar, choose “Performance” under the **Optimize Array** for section.
2. Select how you will use your PC most under the **Typical Application to use** section. The choices are A/V Editing, SERVER, and DESKTOP (the default).
3. Press <Ctrl-Y> keys to Save and create the array.
4. Reboot your system.
5. Once the array has been created, you will need to FDISK and format the array as if it were a new single hard drive.
6. Proceed to Installing Drivers section of the manual.

Creating a Security Array with new drives

CAUTION

RAID controller permit only two drives to be used for a single Mirrored array in Auto Setup.

To create an array for data protection using new hard drives, follow these steps:

1. Using the Spacebar, choose “Security” under the Optimize Array for section.
2. Press <Ctrl-Y> keys to save your selection.
3. The window below will appear.

Do you want the disk image to be duplicated to another? (Yes/No)

Y - Create and Duplicate

N - Create Only

4. Press “N” for the Create Only option.
5. A window will appear almost immediately confirming that your Security array has been created. Press any key to reboot the system.

Array has been created.

<Press Any Key to Reboot>

6. Proceed with normal FDISK and format procedures as if you had just installed a new hard drive.
7. Once the arrayed drives have been formatted, proceed to the Installing Driver your operating system.

Creating a Security Array with An Existing Data Drive

⚠ CAUTION

RAID controller permit only two drives to be used for a single Mirrored array in Auto Setup.

You would use this method if you wish to use a drive that already contains data and / or is the bootable system drive in your system. You will need another drive of identical or larger storage capacity. Follow these steps:

1. Using the Spacebar, choose "Security" under the **Optimize Array** for section.
2. Press <Ctrl-Y> keys to Save your selection. The window below will appear.

Do you want the disk image to be duplicated to another? (Yes/No) Y - Create and Duplicate N - Create Only

3. Press "Y" for the Create and Duplicate option. The window below will appear asking you to select the Source drive to use. FastBuild™ will copy all data from the Source drive to the Target drive.

Channel:ID	Source Disk Drive Model	Capacity (MB)
	Target Disk Drive Model	Capacity (MB)
[Please Select A Source Disk]		
Channel:ID	Drive Model	Capacity (MB)
1 :Master	QUANTUMCR8.4A	8063
2 :Master	QUANTUMCR8.4A	8063
[↑] Up [↓] [ESC] Exit [Ctrl-Y] Save		

4. Use the arrow keys to choose which drive contains the existing data to be copied.
5. Press <Ctrl-Y> keys to save selection and start duplication. The following progress screen will appear.

Start to duplicate the image . . . Do you want to continue? (Yes/No) Y - Continue N - Abort

6. Select "Y" to continue. If you choose "N", you will be returned to step 1.
7. Once complete, the following screen will appear confirming that your Security array has been created. Press any key to reboot the system

Array has been created. <Press Any Key to Reboot>
--

8. Proceed to the Installing Driver on your operating system

Using FastBuild™ Configuration Utility

The FastBuild™ Configuration Utility offers several menu choice to create an manage the drive array on the RAID controller. For purposes of this manual, it is assumed you have already created an array in the previous chapter and now wish to make a change to the array or view other options.

Viewing the BIOS Screen

When you boot your system with the RAID controller and drives installed, the Promise onboard BIOS will detect the drives attached and show the following screen.

```
FastTrak100 (tm) "Lite" BIOS Version 2.xx.x.xx
(c) 1995-2001 Promise Technology, Inc. All rights
reserved.
```

```
Scanning IDE drives . . . . .
```

If an array exists already, the BIOS will display the following screen showing the board's BIOS version and status of the array.

```
FastTrak100 (tm) "Lite" BIOS Version 2.xx.x.xx
(c) 1995-2001 Promise Technology, Inc. All rights reserved.
```

ID	MODE	SIZE	TRACK-MAPPING	STATUS
1	2+0 Stripe	16126M	611/128/32	Functional

```
Press <Ctrl-F> to enter FastBuild (tm) Utility....
```

The array status consists of three possible conditions: Functional, Critical, Offline.

Functional – The array is operational.

Critical – A mirrored array contains a drive that has failed or disconnected. The remaining drive member in the array is functional. However, the array has temporarily lost its ability to provide fault tolerance. The user should identify the failed drive through the FastBuild™ Setup utility, and then replace the problem drive.

Offline – A striped array has 1 drive that has failed or been disconnected. When the array condition is "offline", the user must replace the failed drive(s), and then restore data from a backup source.

Navigating the FastBuild™ Setup Menu

When using the menus, these are some of the basic navigation tips: Arrow keys highlights through choices, <Space> bar key allows to cycle through options, <Enter> selects an options; <ESC> key is used to abort or exit the current menu.

Using the Main Menu

This is the first option screen when entering the FastBuild™ Setup.

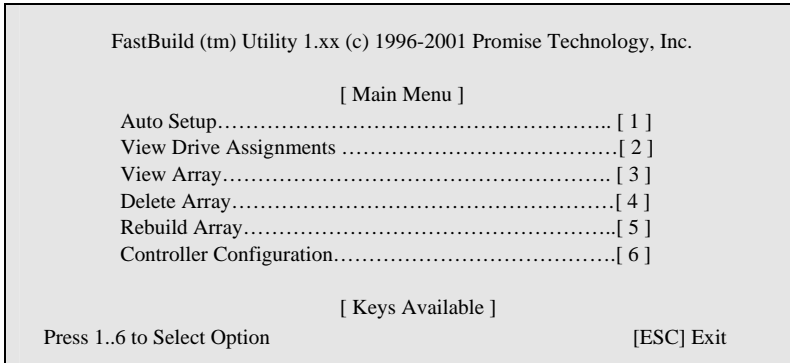

1. To create a new array automatically, follow the steps under “Creating arrays Automatically”. We recommend this option for most users.
2. To view drives assigned to arrays, see “Viewing Drive assignments”.
3. To delete an array (but not delete the data contained on the array), select “Deleting an array”. To rebuild a mirrored array, see “Rebuilding an Array”.
4. To view controller settings, see “Viewing Controller Configuration”.



CAUTION

After configuring an array using FastBuild™, you should FDISK and format the arrayed drive(s) if you are using new, blank drives. Depending on the type of array you are using.

Creating Arrays Automatically

The auto Setup <1> selection from the Main Menu can intuitively help create your disk array. It will assign all available drives appropriate for the disk array you are creating. After making all selections, use Ctrl-Y to save selections. FastBuild™ will automatically build the array.

```

FastBuild (tm) Utility 1.xx © 1996-2001 Promise Technology, Inc.

      [Auto Setup Options Menu]
Optimize Array for:      Performance
Typical Application to use:  DESKTOP

      [ Auto Setup Configuration ]
Mode.....Stripe
Spare Drive .....0
Drive(s) Used in Array.....2
Array Disk Capacity (size in MB).....16126

      [ Keys Available ]

[↑] Up [↓] Down [←, , Space] Change Option [ESC] Exit [CTRL-Y] Save

```

Optimize Array for:

Select whether you want Performance (RAID 0), Security (RAID 1) under the “Optimize Array for” setting.

Performance (RAID 0 Striping)

Supports the maximum performance. The storage capacity equals the number of drives times the capacity of the smallest drive in the disk array.

NOTE: Raid controller permits striped arrays using 1, 2 drive attached in Auto Setup mode.

Security (RAID 1 Mirroring)

Creates a mirrored (or fault tolerant) array for data security.

NOTE: Under the Security setting, Raid controller permits two drives to be used for a single Mirrored array only.

Defining Typical Application Usage:

Allows the user to choose the type of PC usage that will be performed in order to optimize how FastTrak100-Lite handles data blocks to enhance performance. Your choice will determine the block size used. You may choose from: A/V Editing (for audio/video applications, or any similar application that requires large file transfers), Server (for numerous small file transfers), or DESKTOP (a combination of large and small file sizes).

CAUTION

If you wish to customize the settings of individual disk arrays (such as block size), you must manually create disk arrays with the Define Array <3> option from the Main Menu.

Viewing Drive Assignments

The View Drive Assignments <2> option in the Main Menu displays whether drives are assigned to a disk arrays or are unassigned.

Under the “Assignment” column, drives are labeled with their assigned disk array or shown as “Free” if unassigned. Such “Free” drives can be used for a future array or used as a spare drive when a drive fails in a mirrored array. Unassigned drives are not accessible by the OS. The menu also displays the data transfer mode that relates to speed used by each drive (U5 refers to 100MB/sec transfers, U4 refers to 66MB/sec transfer, etc...)

FastBuild (tm) Utility 1.xx (c) 1996-2001 Promise Technology, Inc.				
[View Drive Assignments]				
Channel:ID	Drive Model	Capacity(MB)	Assignment	Mode
1 : Mas	QUANTUMCR8.4A	8063	Array 1	U5
1 : Sla	QUANTUMCR8.4A	8063	Free	U5
2 : Mas	QUANTUMCR8.4A	8063	Array 1	U5

[Keys Available]

[↑] Up [↓] Down [ESC] Exit Mode (U=UDMA, P=PIO, D=DMA)

Viewing Array

The Define Array <3> option in the Main Menu displays the define array.

FastBuild (tm) Utility 1.xx (c) 1996-2001 Promise Technology, Inc.				
[Define Array Menu]				
Array No	RAID Mode	Total Drv	Capacity(MB)	Status
Array 1	Stripe	2	16126	
Functional				
Array 2	---	---	---	---
Array 3	---	---	---	---
Array 4	---	---	---	---

[Keys Available]

Note: * — Bootable Array

[↑] Up [↓] Down [ESC] Exit [Enter] Select [Space] Change Boot Drive

Deleting an array

The Delete Array <4> Menu option allows for deletion of disk array assignments. This is not the same as deleting data from the drives themselves. If you delete an array by accident (and before it has been used again), the array can normally be recovered by defining the array identically as the deleted array.

⚠ DANGER

Deleting an existing disk array could result in its data loss. Make sure to record all array information including the array type, the disk members, and stripe block size in case you wish to undo a deletion.

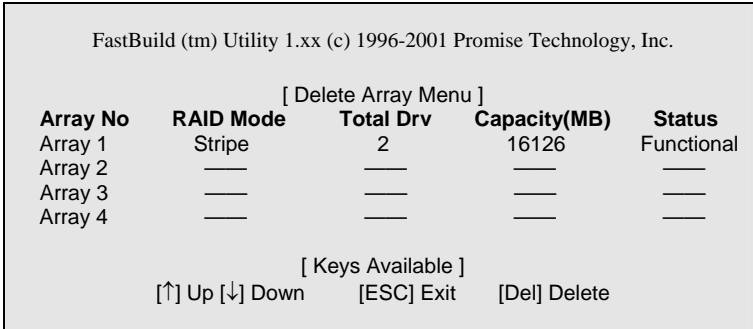

1. To delete an array, highlight the Array you wish to delete and press the [Del] key.
2. The View Array Definition menu will appear (see below) showing which drives are assigned to this array.

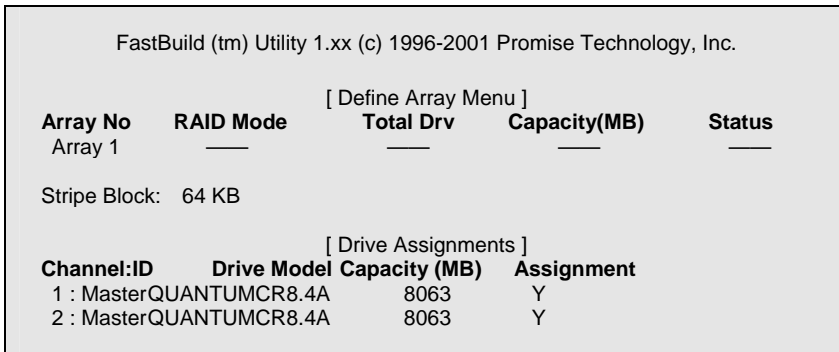

3. Confirm yes to the following warning message with the <Ctrl-Y> key to continue array deletion:

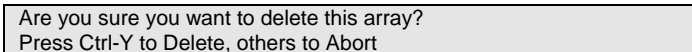

4. After deleting the array, you should create a new array using Auto Setup or the Define Array menu from the FastBuild™ Main Menu.

Rebuilding a mirrored Array

Rebuild Array <5> Menu option is necessary to recover from an error in a mirrored disk array. You will receive an error message when booting your system from the FastTrak BIOS.



CAUTION

Drives **MUST** be replaced if they contain any physical errors.

Follow these steps **BEFORE** using the Rebuild Array menu option:

1. On boot up, the FasTrak100-Lite Startup BIOS will display an error message identifying which drive has failed.
2. Press <Ctrl-F> keys to enter FastBuild Main Menu.
3. Select submenu Define Array <3>.
4. Select the failed array and identify the Channel and ID of the failed drive.
5. Power off and physically remove the failed drive.
6. Replace the drive with an identical model.
7. Reboot the system and enter the FastBuild™ Main Menu.
8. Select the <5> Rebuild Array option. The following screen will appear.

```

FastBuild (tm) Utility 1.xx (c) 1996-2001 Promise Technology, Inc.

                                [ Rebuild Array Menu ]
Array No    RAID Mode    Total Drv    Capacity(MB)    Status
Array 1      Mirror        2              16126            Critical
Array 2      _____            _____            _____
Array 3      _____            _____            _____
Array 4      _____            _____            _____

                                [ Keys Available ]
                [↑] Up [↓] Down    [ESC] Exit    [Enter] Select
  
```

9. Highlight the array whose Status is Critical.
10. Press [Enter]. The following screen will then appear.

```

FastBuild (tm) Utility 1.xx (c) 1996-2001 Promise Technology, Inc.

                                [ Rebuild Array Menu ]
Array No    RAID Mode    Total Drv    Capacity(MB)    Status
Array 1      Mirror        2              16126            Critical

Stripe Block: Not Available

                                [ Select Drive for Rebuild ]
Channel:ID    Drive Model          Capacity (MB)
1 : Slave    QUANTUMCR8.4A        8063

                                [ Keys Available ]
                [↑] Up [↓] Down    [ESC] Exit    [Enter] Select
  
```

11. Under [Select Drive for Rebuild], highlight the replacement drive.

12. Press [Enter] and confirm that the data will be copied on to the selected drive. All data on the replacement drive will be written over with mirrored information from the array drive.

A progress bar will appear as below.

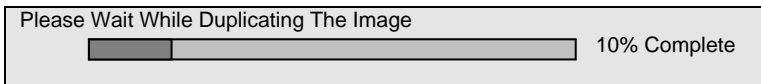

13. Once the rebuild process is complete, the user will be asked to reboot the system.

Viewing Controller Settings

The Controller Configuration <6> menu selection allows you to enable or disable the RAID controller BIOS from halting (the default) if it detects an error on boot up. You may also view the system resources (Interrupt and I/O port address) of FastTrak's data channels.

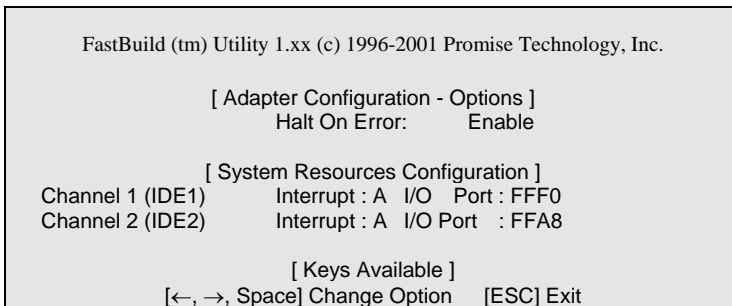

Halting RAID controller BIOS on Boot up Errors

The [Adapter Configuration – Options] section allows you to enable or disable RAID controller to Halt operation at the BIOS startup screen should an error be detected. This is the only option that can be changed on this screen.

Viewing RAID Controller System Resource

The [System Resources Configurations] section of this submenu displays the PCI slot interrupt and port address used by the RAID controller. The resources used are determined by the SPI-8451-LLVA PCI PnP BIOS for the PCI device resides.

In the rare case that there is a resource conflict, refer to the SPI-8451-LLVA BIOS documentation on changes on resources allocated to the RAID Controller.

Installing the drivers Windows 2000/XP

Installing Driver During New windows 2000/XP Installation

CAUTION

Before the Windows 2000/XP installing, please copy the whole files and folder in the folder as follows "RAID\Win2000\" ("RAID\Winxp\") of the Driver CD-ROM to a floppy disk.

1. Floppy Install: Boot the computer with the Windows 2000 installation diskettes.
2. Floppyless Install: Boot from floppy and type "WINNT". After files have been copied, the system will reboot. On the reboot, press <F6> after the message "Setup is inspecting your computer's hardware configuration ..." appears.
3. OS CD-ROM Install: Boot from the OS CD-ROM. Press <F6> after message "Press F6 if you need to install third party SCSI or RAID driver" appears.
4. When the "Windows 2000(XP) Setup" window is generated, press "S" to specify an additional device(s).
5. Press "O" to select "Other" and press the "Enter" key.
6. Insert the Promise Technology driver diskette into drive A: and press "Enter" key.
7. Choose "Win2000 Promise FastTrak100™-Lite Controller" (Windows XP Promise FastTrak100™ Controller (PDC20265)) from the list that appears on screen and then press the "Enter" key.
8. The Windows 2000/XP Setup screen will appear again say in "Setup will load support for the following mass storage devices." The list will include "Wind2000 Promise FastTrak100-Lite Controller" ("Windows XP Promise FastTrak100™ Controller (PDC20265)").

CAUTION

If you need to specify any additional devices to be installed, do so at this time. Once all devices are specified, continue to next

9. From the windows 2000/XP Setup screen press the [Enter] key. Setup will now load all device files and then continue the Windows 2000/XP installation.

Installing Driver in Existing windows 2000/XP System

WARNING

If you will be moving the boot drive containing the existing Windows 2000/XP operating system to a mirrored RAID 1 array on the controller, the controller driver MUST be loaded to the hard drive while it is still attached to your existing hard drive controller. Do not attach this drive or any other hard drive to the controller before completing this step.

After installing the FastTrak100-Lite and rebooting your system, Windows 2000/XP setup will show a “New Hardware Found” dialog box. Under Windows 2000/XP, the “PCI RAID Controller” will be displayed.

1. In the dialog box, choose “Driver from disk provided by hardware manufacturer” button.
2. Insert the Driver CD-ROM into the your CD-ROM drive.
3. Type “D:\RAID\Win2000” (RAID\Winxp”) in the text box. Press [Enter]
* This case the CD-ROM drive is D:
4. Choose “Win2000 Promise FastTrak100-Lite Controller” (“Windows XP Promise FastTrak100 controller (PDC20265)”) from the list that appears on screen and then press the [Enter] key.
5. The Windows 2000/XP Setup screen will show again “Setup will load support for the following mass storage devices – “Win2000 Promise FastTrak100™-Lite Controller” (“Windows XP Promise FastTrak100™ controller (PDC20265)”). The driver will now be copied on to the system and entered into the Windows 2000/XP driver database.
6. When the “System Settings Change” dialog box appears, remove the floppy diskette and click on [Yes] to restart the system. Windows 2000/XP will then restart for the driver installation to take effect.
7. Power off your system, and then attach your hard drives to the SPI-8451-LLVA’s RAID connectors.

Confirming Windows 2000/XP Installation

1. From Windows 2000/XP, open the Control Panel from “My Computer” followed by the system icon.
2. Choose the “Hardware” tab, click the “Device Manager” tab.
3. Click the [+] in front of “SCSI & RAID Controllers hardware type.” The driver “Win2000 Promise FastTrak/FastTrak100-Lite Controller” (“Windows XP Promise FastTrak100™ controller (PDC20165)”) should appear.

Using the FastCheck Monitoring Utility

You can monitor the operating status of all arrays and drives configured on the RAID controller using the supplied FastCheck monitoring utility for Windows-based operating system (Windows 2000 / XP).

FastCheck generates visual and audible messages alerting you of possible problems with the disk array or controller.

FastCheck visually identifies the physical location of attached drives on the RAID controller by IDE channel (1 or 2) and setting (Master / Slave / Cable-select). It also displays which drives are included as part of individual arrays. Administrators can customize FastCheck to maintain operating logs and event notification, set Password access to the utility, and schedule maintenance on Mirrored (RAID 1) arrays.

Installing FastCheck

1. Insert the Driver CD-ROM into the CD-ROM drive.
2. Double-click the "Setup" icon inside the "RAID\Utility" folder.
3. Follow the directions from the setup program.
2. During installation, click YES when prompted to run the utility on every startup. If NO is selected, FastCheck™ will not initialize during startup. You may manually execute the utility via the Start button.

CAUTION

We recommend to have FastCheck load during Startup. This insures you that it will be ready to post alerts on errors.

Running FastCheck

As described in the Installation section, the default option for FastCheck is to load during startup of Win2000/XP. It appears minimized on the taskbar under Win2000/XP.

1. From the Start Button on the Windows Taskbar, choose Run.



To start FastCheck™, double-click on the FastCheck icon on the taskbar or you may also use the Taskbar Start/Promise/FastTrak/FastCheck menus shown below.



Closing FastCheck

Once FastCheck is opened (either automatically on startup or manually), the monitoring utility remains running in the background even if go user “closes” the FastCheck windows. To completely shut down FastCheck icon on the Taskbar.

1. Right-click the FastCheck icon on the Taskbar.
2. Select Exit from the pop-up window.
3. FastCheck™ no longer be running and will no longer be monitoring the array.

Using FastCheck Array Windows

Once FastCheck is selected, the FastCheck Monitoring Utility window will appear. The main pane has three information window tabs: Array, Controller, and Options. The user can switch screens by clicking on the tab. The Array window is the active screen by default as shown below:

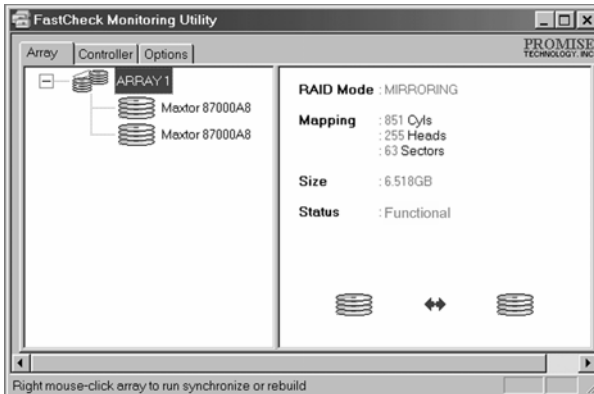

The Array Window (see above) displays information about the arrays configured on your FastTrak100-Lite through the FastBuild BIOS. From this window, you can also perform data Synchronization of mirrored arrays, or Rebuild data from one drive to a replacement drive within a mirrored array.

While the Array Window does not allow you to change the array configurations directly, it clearly identifies which drives are associated with each array shown in the left pane.

Viewing Array Information

By left-clicking on the Array#, the right pane shows the following information categories for the array:

RAID mode: (Striping, Mirroring)

Mapping: (similar to physical drive specifications) describing # of cylinders, heads, and sectors of the array's "virtual" drive as seen by the system

Size: Storage capacity of the array

Status: (Functional, Critical, Offline)

Functional: Means the array is providing full functionality.

Critical: Used only in reference to a Mirroring array (RAID 1). A problem has been detected in one of the drives of the array and the drive has been taken "Offline." However, a "critical" array will continue to save and retrieve data from the remaining working drive(s). Promise recommends replacing the failed drive as soon as possible since a "Critical" array offers no data redundancy.

Offline: This would appear most commonly within a RAID 0. The "Offline" results from a drive having failed which has taken the entire array "offline". In this case, you have likely lost data. Fix/replace the drive that has failed, and then restore data from a backup source.

Viewing Arrayed Drive Information

By left-clicking on a drive member of an array in the left pane, the right pane shows the following information categories for that drive:

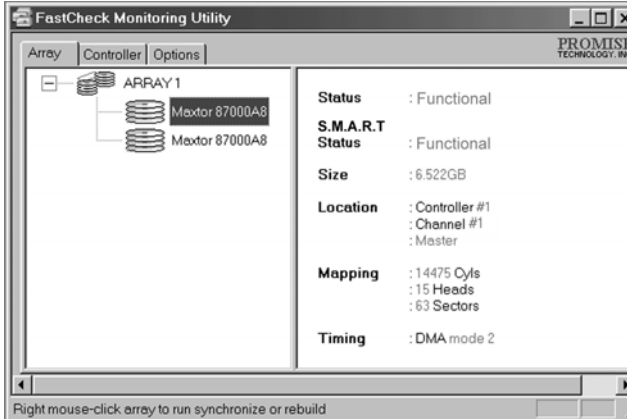

Status: (also shown under the Array Window) can be Functional, Critical, or Offline. The meanings are shown below.

Functional: Means the drive is working normally.

Critical: A problem has been detected in the drive and the drive taken offline as part of a mirroring array. Mirrored arrays will continue to function without the drive. Fix/replace the drive that has failed, and then restore data from a backup source.

Offline: Drives that are NOT identified as “bad” may be taken offline if part of a Striping or spanning array containing a “bad” drive. These drives do NOT need to be replaced, however.

S.M.A.R.T. Status: Indicates whether attached hard drive implements Self-Monitoring analysis & Reporting Technology to predict drive failure

Size: Indicates capacity of individual drive

Location: Shows physical location of drive. Indicates on which IDE channel (1 or 2), and whether drive is Master or Slave on cable. This allows user to identify drives for removal/replacement.

Mapping: Indicates physical parameters of drive (cylinders, heads, sectors)

Timing: Shows selection of drive timing (directly related to burst speed) based on type of drive and cable used.

Using Array Pull-down Menu

At the bottom of the Array window, it indicates to right-click on an Array to perform synchronization or rebuild operations. Right-clicking displays the following pull-down menu:

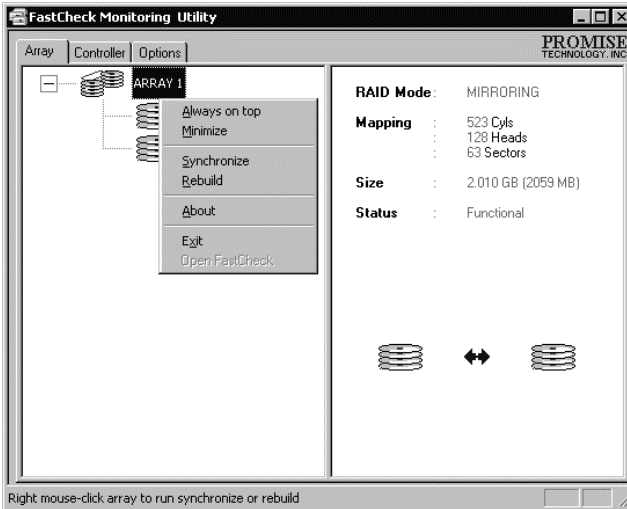

From this menu, users may choose to have the window **Always Appear** on Top of applications, **Minimize**, **Synchronize** mirrored drives, **Rebuild** a mirrored array, use **About** to check FastCheck version#, or Exit the on screen window.

Synchronizing an Array

Synchronization is a periodic maintenance procedure for Mirroring (RAID 1) arrays to maintain data consistency on all mirrored drives. In operation, array synchronization compares data on the mirrored drives for any differences. If there are differences detected, data from the primary drive(s) is automatically copied to the secondary drive(s). This assures that all mirrored drives will contain the exact information.

⚠ CAUTION

You may instead choose to schedule array synchronization automatically under the Options Tab view versus manually initiating synchronization

To synchronize, choose the Array Tab View.

Right-click on the array you wish to synchronize and choose “Synchronize” from the context menu.

Click “Yes” to initiate Synchronization (see below) when the Confirmation window appears. To cancel this option, click the NO button.

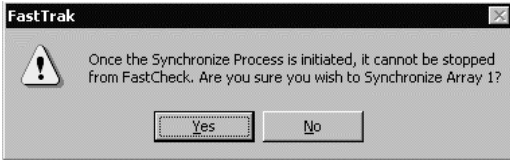

⚠ WARNING

Once initiated, synchronization can NOT be halted in order to prevent data errors.

Once Synchronization is confirmed, the following information screen appears. Click OK button or close the window to proceed.

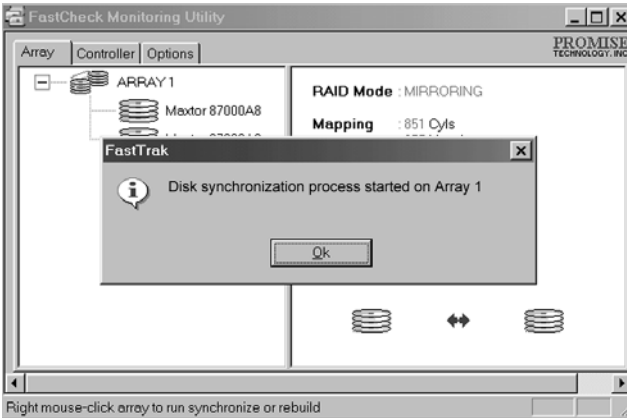

⚠ CAUTION

During Array Synchronization, users may continue to access the working array and perform normal PC functions. However, system performance will be slightly degraded and the process will take longer.

A progress bar will appear at the bottom of the FastCheck Monitoring window showing synchronization in progress and the percentage that has been completed.



Rebuilding An Array

This command effectively copies or overwrites data from an existing data drive in the array on to a blank drive. The operation will be typically used when a failed drive has been replaced with a new drive as part of a mirrored array.

To perform a Rebuild, choose the Array Tab View.

Right click the array number and choose Rebuild from the context menu.

Once Rebuild is selected, you will be asked to "Initialize Rebuild process on Array #" by clicking OK.

Using Rebuild wizard

Initiating rebuild array will open the Rebuild Wizard step 1 screen shown below.

Select the Target drive which will receive data. Make sure you select the blank new or replacement drive. The unselected drive will contain "good" data. It will be the remaining working drive of an array, or a system drive containing existing data that you wish to mirror.

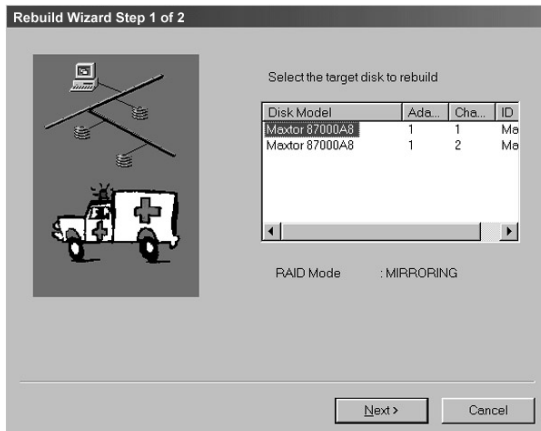

⚠ WARNING

Make absolutely sure and double check the drive which is target. If data exists on the target drive, it will be over written.

Click the Next button to proceed to Rebuild Wizard Step 2 or Cancel button to stop.



Rebuild Wizard Step 2 confirms the Target or “Rebuild” disk by Array # and drive ID.

Click Finish button to initiate physical Rebuild, Back button to review Step 2, or Cancel button to Stop. A final confirmation window appears as below:

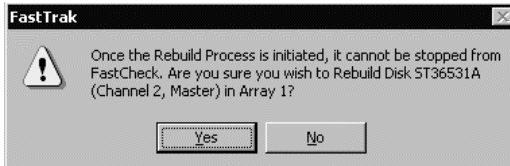

Click “Yes” to initiate Rebuild. To cancel this option, click the No button.

⚠ WARNING
Once initiated, Array Rebuild can NOT be halted in order to prevent data errors.

⚠ CAUTION
During Array Rebuild, users may continue to access the array and perform normal PC functions however the array will NOT provide data redundancy until Rebuild is completed. If you choose to continue using the PC during rebuild, system performance will be slightly degraded and the process will take longer.

Once Array Rebuild has begun, users are returned to the FastCheck Monitoring window. A progress bar showing the rebuild progress in percentage will appear at the bottom of the FastCheck Monitoring window.



⚠ CAUTION
When a “spare” unassigned drive is present on the FastTrak100-Lite, a rebuild will automatically be performed from the remaining working drive.

Using Controller Windows

Clicking on the Controller tab, will reveal the Controller Window. This displays physical information about the location of FastTrak100-Lite, data channels on the card, and the attached drives.

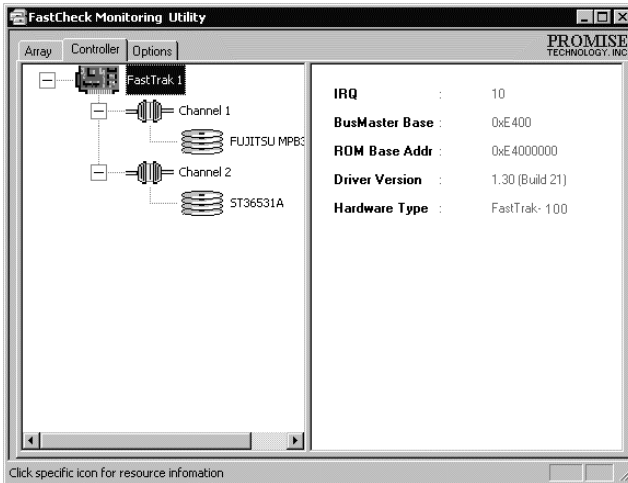

Viewing Controller Card Information

By left-clicking on the FastTrak controller icon, the right pane shows the following information categories for that array:

IRQ: Identifies interrupt request assigned to PCI slot

Bus Master Base: Shows base address in hex numbering for board's bus master Input/Output function

ROM Base Address: Shows base address in hex numbering for FastTrak's Flash ROM chip

Driver Version: Identifies which version of the Promise FastTrak100-Lite driver you have installed.

Hardware Type: Identifies which FastTrak product is installed.

Viewing IDE Channel Information

Left-clicking on a given Channel icon or # in the left pane, will show the Base IO addresses of the channel in the right pane (used for troubleshooting).

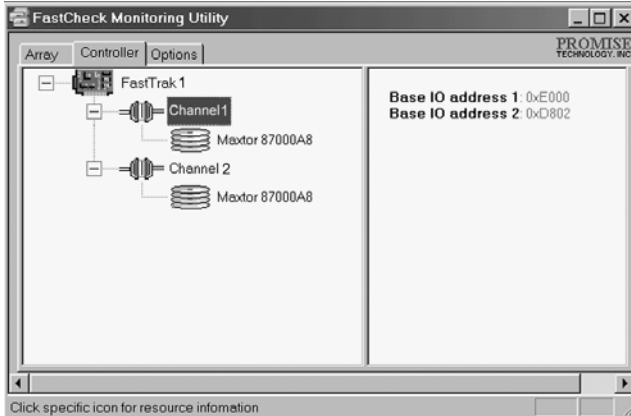

Viewing Drive Information

Left-clicking on a given Drive icon or ID in the left pane, will show similar information categories as the Array Window Drive Information in the right pane.

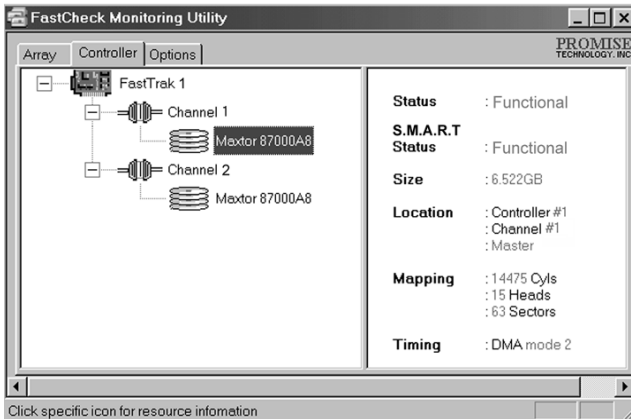

Status (also shown under the Array Window) can be Functional, Critical, or Offline. The meanings are shown below.

Functional: Means the drive is working normally

Critical: A problem has been detected in the drive and the drive taken offline as part of a mirroring array. Mirrored arrays will continue to function without the drive. Fix/replace the drive that has failed, and then restore data from a backup source.

Offline: Drives that are NOT identified as “bad” may be taken offline if part of a Striping or Spanning array containing a “bad” drive. These drives do NOT need to be replaced, however.

S.M.A.R.T. Status: Indicates whether attached hard drive implements Self-Monitoring Analysis & Reporting Technology to predict drive failure

Size: Indicates capacity of individual drive

Location: Shows physical location of drive. Indicates on which IDE channel (1 or 2), and whether drive is Master or Slave on cable. This allows user to identify drives for removal/replacement.

Mapping: Indicates physical parameters of drive (cylinders, heads, sectors)

Timing: Shows selection of drive timing (directly related to burst speed) based on type of drive and cable used.

Using Options Windows

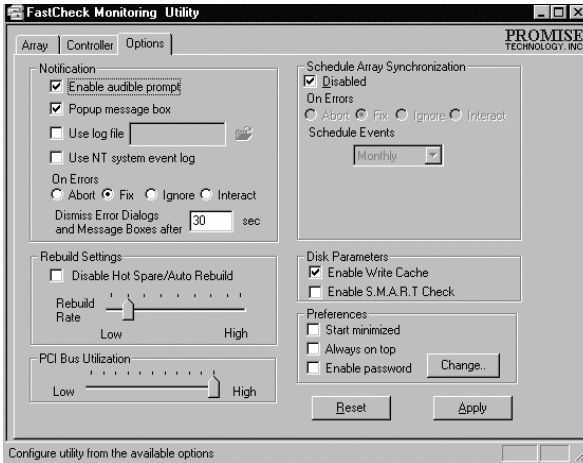

Clicking on the Options tab reveals the Options Window. Array administrators can customize the FastCheck™ Monitoring Utility in four major areas: Notification, Array Synchronization Scheduling, setting Password, Desktop Appearance. Most options relate to Mirroring arrays (RAID 1).

Selecting Notification Options

This section of the Options windows allows users to select how they are notified of a system event. A System Event includes driver-initiated Rebuilds (automatic rebuild using a “hot” spare standby drive), user-initiated manual Rebuilds or manual Synchronization, and Error-Handling reporting for these processes.

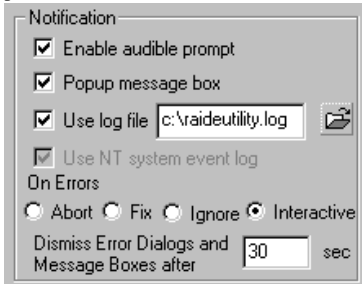

Enable audible prompt checkbox turns on/off an audible alarm of an event (typically a drive failure, or completion of rebuild or synchronization).

Popup message box checkbox turns on/off the appearance of an event message box that would typically indicate a drive failure, or completion of rebuild or synchronization.

Use log file checkbox allows writing operating event logs of the array activity (alerts and status reports) to a given file name and directory. If a file name is used but the path left blank, the default directory is the same as the FastCheck Utility (typically C:\Program Files\Promise\FastTrak100-Lite).

Use NT system event log checkbox is grayed out under Windows 95/98/2000/XP automatically. Under Windows NT4, it permits user to write array logging to NT's own event log.

To view FastCheck™ events under Windows NT, go to Start / Programs / Administrative Tools / Event Viewer.

In the Event Viewer, choose “Log” from the menu bar, then check “Application.” Any events generated by FastCheck will appear under the Source column as “FastCheck.”

On Errors section offers four radio button choices for the user to select what procedure they would like to perform if an Error is detected during automatic/manual Rebuild or manual Synchronization.

There are three types of errors that FastTrak100-Lite detects -- a data mismatch between the primary and secondary drive, a physical media error on source or target drive, or a total disk failure. The options for handling Errors are as follows:

Abort: stops any Synchronization or Rebuild process if an error is encountered.

Fix: in most cases, FastTrak100-Lite automatically can correct errors. The method of correction varies depending on the type of error.

Ignore: FastTrak100-Lite will log the event error and continue the rebuild or synchronization process. Use this setting if you want to detect the presence of errors, but do not want to fix these errors at the time. The user may then decide what to do about the error(s) detected.

WARNING

This may result in mismatched drives under RAID 1

Interactive: By checking this option, a selection window will appear each time an error is detected asking the user whether they want to Abort, Fix, or Ignore the error (see Troubleshooting section).

Dismiss Error Dialogs designates the length of time (in seconds) that a Message box or Error Dialog box appears on screen.

Scheduling Array Synchronization

This section of the Options Window allows a user to schedule when and how often FastTrak100-Lite will perform synchronization maintenance of a mirrored array.

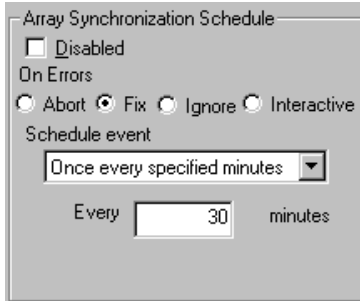

Disable checkbox is checked (the default) to turn off automated scheduling of synchronization. When unchecked, the Scheduling section will be highlighted (see above).

On Errors section offers four radio button choices for the user to select what procedure they would like to perform if an Error is detected during a scheduled Synchronization. There are three types of errors that FastTrak100-Lite detects -- a data mismatch between the primary and secondary drive, a physical media error on source or target drive, or a total disk failure. The options for handling Errors are as follows:

Abort: stops the Synchronization process if an error is encountered.

Fix: in most cases, FastTrak100-Lite automatically can correct errors. The method of correction varies depending on the type of error.

Ignore: FastTrak100-Lite will log the event error and continue the synchronization process. (Warning: this may result in mismatched drives under RAID 1). Use this setting if you want to detect the presence of errors, but do not want to fix these errors at the time. The user may then decide what to do about the error(s) detected.

Interactive: By checking this option, a selection window will appear each time an error is detected asking the user whether they want to Abort, Fix, or Ignore the error (see Troubleshooting for more details).

Schedule event drop down box allows scheduling synchronization by minute, by hour, by day, by week, or by month. If enabled, the default is By Month. This allows synchronization to take place during an off-hour when the system is either not in use or not at peak demand.

Start time designates hr/min/ am/pm

On the designate day of week or by ordinal (1st, 2nd, 3rd....) selection.

Setting Rebuild Options

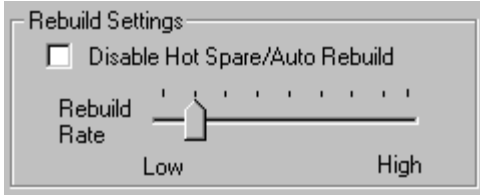

Disable Hot Spare/Auto Rebuild checkbox turns off the use of a “hot” spare drive and automatic rebuilding of a mirrored array. The default is unchecked (or enable Hot Spare/Auto Rebuild).

Rebuild Rate assigns the amount of importance that FastTrak100-Lite gives to mirroring data from one drive to another in the background. A “high” setting assigns most of FastTrak100-Lite’s resources to the rebuild process at the expense of responding to ongoing read/write data requests by the operating system. A “low” setting gives priority to ongoing read/write data requests by the operating system at the expense of the rebuild process and will typically result in longer rebuild times. The setting shown above is the default.

Setting PCI Bus Utilization Option

⚠ CAUTION

In most cases, a user does not need to change this setting since FastTrak100-Lite’s data handling rarely conflicts with another PCI device. However, certain brands of video capture cards can produce a “glitch” on play back of A/V files that may require adjusting the default setting devices (see Tips for Audio/Video Editing for more information).

This section of the Options Window allows a user to change how much time the FastTrak100-Lite holds on to the PCI bus to transfer data.

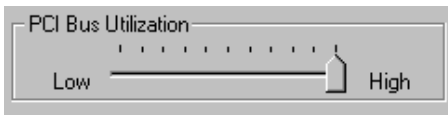

The default setting of “High” on the slider bar means FastTrak100-Lite holds on to the PCI bus longer for data transfers to occur. A setting of “Less” reduces the time which FastTrak100-Lite occupies on the PCI bus and frees that time for use by other PCI devices.

Once a bus setting has been selected, click the Apply button on the Options window to implement changes immediately.

Setting Disk Parameters Option

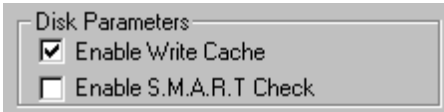

Enable Write Cache checkbox allows user to enable/disable write cache for hard drives that include this performance feature. FastCheck automatically recognizes such drives and enables the feature as the default setting. For drives that do not use write caching, this option is automatically grayed out.

Enable S.M.A.R.T. Check checkbox tells FastCheck to regularly monitor each drive to assure that drive failure prediction is functioning. The default is unchecked, meaning FastCheck will not monitor this function.

Setting Screen Preferences

This section controls how the FastCheck utility screen is displayed and sets the security password to protect the administrative settings.

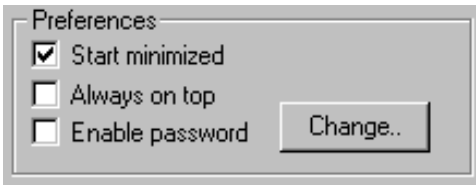

Start Minimized checkbox allows user to have FastCheck appear on the toolbar only on startup. Click on the icon to see the FastCheck™ utility screen.

Always on Top checkbox tells the Utility to appear above all programs until closed or minimized manually.

Enable Password checkbox in the Preferences section turns on/off use of a Password every time the FastCheck™ Monitoring Utility icon is selected or the program is run from the Start menu. Disabling use of a current password requires password entry (see Creating Password on next page).

Creating Password

To create a password, check the **Enable Password** checkbox in the Preferences section. The “Set Password” window will appear.

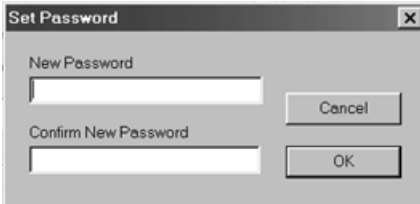

Type the password you want to use. Press the Tab key or click to retype the same password in the “Confirm New Password” section. Click the OK button.

CAUTION

Remember to record the password you use in a secure place in case you forget it.

A confirmation screen will appear shown that “Password Checking is Enabled”. Click the OK button.

Once the password feature is enabled, the following menu will appear before the FastCheck™ window can be opened is enabled, the following menu will appear on each use of FastCheck.

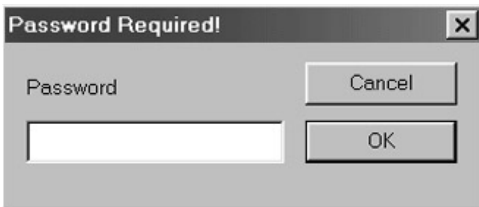

Changing Password

1. Input the original password you first created to gain access to FastCheck.
2. Click on Options tab, and then click on the Change button in the Password section. The Set Password screen will appear.
3. Type the password you want to use. Press the Tab key or click to retype the same password in the “Confirm New Password” section.
4. Click OK button.

Disabling Password

1. Input the original password you first created to gain access to FastCheck.
2. Click on Options tab
3. Uncheck the “Enable Password” checkbox. Click Apply button on Options window.

7. Watch-Dog-Timer (WDT) Setting

The watchdog timer serves as a safeguard against possible system lock-up in your industrial computer system. In most industrial environments, there are heavy equipment, generators, high-voltage power lines, or power drops that have adverse effects on your computer system. For instance, when a power drop occurs, it could cause the CPU to come to a halt state or enter into an infinite loop, resulting in a system lock-up.

The application software created by user with the watchdog timer enabled, a RESET automatically generated unless the software periodically triggers the timer within the setting time-out interval. That is, while the system gets hung up, the running program can't trigger the timer periodically. The timer will generate a reset signal to reboot the system. This feature allows a running program to restart in an orderly way when a power glitch or any abnormal condition occurs.

The watchdog timer comes with 255-level time-out interval, 1 - 255 seconds per interval, which can be adjusted by software setting. There is a tolerance of 2 second for this time-out interval. For example, if the time-out interval has been set to 32 seconds, your program should trigger the watchdog timer before 28 seconds are escaped. Otherwise, after 28-32 seconds are escaped, the system will automatically reboot. To keep the system running normally, your program should trigger the watchdog timer every 28 seconds.

The I/O port is defined at address 2e/2fH. You can trigger/enable/disable the timer by writing address 2e/2fH.

Here is an example for flow chart and programming how to use the watch-dog-timer.

(1) Example flow chart

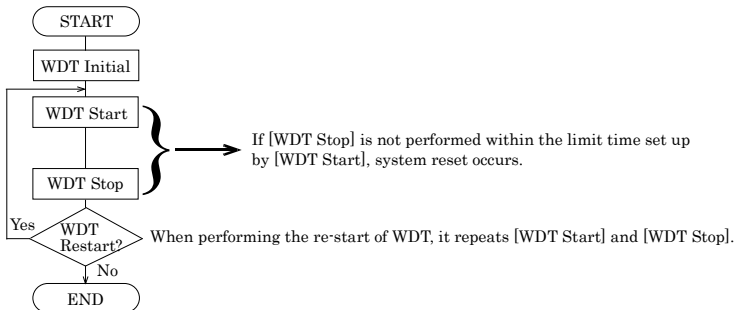

- * It is also possible not to perform [WDT Stop] instead of performing [WDT Stop] to [WDT Start], but to perform [WDT Start] continuously at the time of a re-start.

(2) Example programming

The following example is written in Intel8086 assembly language.

```
=====
;<WDT Initial>
=====
;-----
;Enter the extended function mode
;-----
MOV DX,2EH
MOV AL,87H
OUT DX,AL
OUT DX,AL
;-----
;Set WDT function at pin89
;-----
MOV DX,2EH
MOV AL,2BH
OUT DX,AL
MOV DX,2FH
MOV AL,0DH
OUT DX,AL
;-----
;Select logical device WDT(number 8)
;-----
MOV DX,2EH
MOV AL,07H
OUT DX,AL
MOV DX,2FH
MOV AL,08H
OUT DX,AL
;-----
;Activate logical device WDT(number 8)
;-----
MOV DX,2EH
MOV AL,30H
OUT DX,AL
MOV DX,2FH
MOV AL,01H
OUT DX,AL
;-----
;Set timer unit : second
;-----
MOV DX,2EH
MOV AL,F5H
OUT DX,AL
MOV DX,2FH
MOV AL,00H
OUT DX,AL
```

```

;-----
;Exit the extended function mode
;-----
MOV DX,2EH
MOV AL,AAH
OUT DX,AL

;=====
;<WDT START : counter set and a start >
;=====
;-----
;Enter the extended function mode
;-----
MOV DX,2EH
MOV AL,87H
OUT DX,AL
OUT DX,AL

;-----
;Select logical device WDT(number 8)
;-----
MOV DX,2EH
MOV AL,07H
OUT DX,AL
MOV DX,2FH
MOV AL,08H
OUT DX,AL

;-----
;Set time of WDT and start to count down
;-----
MOV DX,2EH
MOV AL,F6H
OUT DX,AL
MOV DX,2FH

;-----
;The data of an example is 15 seconds.(01H=1sec.- FFH=255sec.)
MOV AL,0FH ; 0FH = 15Sec.
;-----
OUT DX,AL

;-----
;Exit the extended function mode
;-----
MOV DX,2EH
MOV AL,AAH
OUT DX,AL

```



```
;=====
;<WDT STOP>
;=====
;-----
;Enter the extended function mode
;-----
MOV DX,2EH
MOV AL,87H
OUT DX,AL
OUT DX,AL
;-----
;Select logical device WDT(number 8)
;-----
MOV DX,2EH
MOV AL,07H
OUT DX,AL
MOV DX,2FH
MOV AL,08H
OUT DX,AL
;-----
;Stop count down of WDT
;-----
MOV DX,2EH
MOV AL,F6H
OUT DX,AL
MOV DX,2FH
;-----
;The data of 00H is stop WDT
MOV AL,00H
;-----
OUT DX,AL
;-----
;Exit the extended function mode
;-----
MOV DX,2EH
MOV AL,AAH
OUT DX,AL
```

CAUTION

The timer's intervals have a tolerance of ± 2 seconds.

8. BIOS Setup

Introduction

This chapter discusses Award's Setup program built into the FLASH ROM BIOS. The Setup program allows users to modify the basic system configuration. This special information is then stored in battery-backed RAM so that it retains the Setup information when the power is turned off.

The rest of this chapter is intended to guide you through the process of configuring your system using Setup.

Starting Setup

The Award BIOS is immediately activated when you first power on the computer. The BIOS reads the system information contained in the CMOS and begins the process of checking out the system and configuring it. When it finishes, the BIOS will seek an operating system on one of the disks and then launch and turn control over to the operating system.

While the BIOS is in control, the Setup program can be activated in one of two ways:

1. By pressing immediately after switching the system on, or
2. by pressing the key when the following message appears briefly at the bottom of the screen during the POST (Power On Self-Test).

Press DEL to enter SETUP.

If the message disappears before you respond and you still wish to enter Setup, restart the system to try again by turning it OFF then ON or pressing the "RESET" button on the system case. You may also restart by simultaneously pressing <Ctrl>, <Alt>, and <Delete> keys. If you do not press the keys at the correct time and the system does not boot, an error message will be displayed and you will again be asked to...

Press F1 to continue, DEL to enter SETUP

* Notes that the BIOS title of the start screen of SPI-8452-LLVA is displayed as "SPI-8451-LLVA···".

The item might be different according to the version of BIOS.

Using Setup

In general, you use the arrow keys to highlight items, press <Enter> to select, use the PageUp and PageDown keys to change entries, press <F1> for help and press <Esc> to quit. The following table provides more detail about how to navigate in the Setup program using the keyboard.

Table 8.1. Using Setup

Key	Function
Up Arrow	Move to the previous item
Down Arrow	Move to the next item
Left Arrow	Move to the item on the left (menu bar)
Right Arrow	Move to the item on the right (menu bar)
Esc	Main Menu: Quit without saving changes Submenus: Exit Current page to the next higher level menu
Move Enter	Move to the item you desired
PgUp key	Increase the numeric value or make changes
PgDn key	Decrease the numeric value or make changes
+ key	Increase the numeric value or make changes
- key	Decrease the numeric value or make changes
Esc key	Main Menu -- Quit and not save changes into CMOS Status Page Setup Menu and Option Page Setup Menu -- Exit current page and return to Main Menu
F1 key	General help on Setup navigation keys
F5 key	Load previous values from CMOS
F6 key	Load the fail-safe defaults from BIOS default table
F7 key	Load the optimized defaults
F10 key	Save all the CMOS changes and exit

Getting Help

Press F1 to pop up a small help window that describes the appropriate keys to use and the possible selections for the highlighted item. To exit the Help Window press <Esc> or the F1 key again.

In Case of Problems

If, after making and saving system changes with Setup, you discover that your computer no longer is able to boot, the AwardBIOS™ supports an override to the CMOS settings which resets your system to its defaults.

The best advice is to only alter settings which you thoroughly understand. To this end, we strongly recommend that you avoid making any changes to the chipset defaults. These defaults have been carefully chosen by both Award and your systems manufacturer to provide the absolute maximum performance and reliability. Even a seemingly small change to the chipset setup has the potential for causing you to use the override.

A Final Note About Setup

The information in this chapter is subject to change without notice.

Main Menu

Once you enter the Award BIOS CMOS Setup Utility, the Main Menu will appear on the screen. The Main Menu allows you to select from several setup functions and two exit choices. Use the arrow keys to select among the items and press <Enter> to accept and enter the sub-menu.

Note that a brief description of each highlighted selection appears at the bottom of the screen.

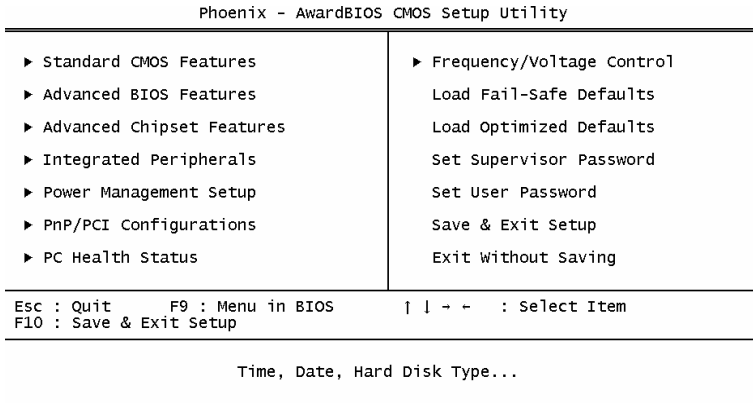

Figure 8.1. Main Menu

Setup Items

The main menu includes the following main setup categories. Recall that some systems may not include all entries.

Standard CMOS Features

Use this menu for basic system configuration.

Advanced BIOS Features

Use this menu to set the Advanced Features available on your system.

Advanced Chipset Features

Use this menu to change the values in the chipset registers and optimize your system's performance.

Integrated Peripherals

Use this menu to specify your settings for integrated peripherals.

Power Management Setup

Use this menu to specify your settings for power management.

PnP / PCI Configuration

This entry appears if your system supports PnP / PCI.

Load Fail-Safe Defaults

Use this menu to load the BIOS default values for the minimal/stable performance for your system to operate.

Load Optimized Defaults

Use this menu to load the BIOS default values that are factory settings for optimal performance system operations. While Award has designed the custom BIOS to maximize performance, the factory has the right to change these defaults to meet their needs.

Supervisor / User Password

Use this menu to set User and Supervisor Passwords.

Save & Exit Setup

Save CMOS value changes to CMOS and exit setup.

Exit Without Save

Abandon all CMOS value changes and exit setup.

Standard CMOS Setup

Phoenix - AwardBIOS CMOS Setup Utility
Standard CMOS Features

Date (mm:dd:yy)	Thu, Jan 1 2001	Item Help
Time (hh:mm:ss)	10 : 22 : 30	
▶ IDE Primary Master	[None]	Menu Level ▶ Press [Enter] to enter next page for detail hard drive settings
▶ IDE Primary Slave	[None]	
▶ IDE Secondary Master	[None]	
▶ IDE Secondary Slave	[None]	
Drive A	[1.44M, 3.5 in.]	
Drive B	[None]	
Video	[EGA/VGA]	
Halt On	[All , But Keyboard]	
Base Memory	640K	
Extended Memory	64512K	
Total Memory	65536K	

↑↓←→:Move Enter:Select +/-/PU/PD:Value F10:Save ESC:Exit F1:General Help
F5: Previous Values F6: Fail-Safe Defaults F7: Optimized Defaults

Figure 8.2. Standard CMOS Setup

The items in Standard CMOS Setup Menu are divided into 10 categories. Each category includes no, one or more than one setup items. Use the arrow keys to highlight the item and then use the <PgUp> or <PgDn> keys to select the value you want in each item.

Main Menu Selections

This table shows the selections that you can make on the Main Menu

Item	Options	Description
Date	Month DD YYYY	Set the system date. Note that the 'Day' automatically changes when you set the date
Time	HH : MM : SS	Set the system time
IDE Primary Master	Options are in its sub menu	Press <Enter> to enter the sub menu of detailed options
IDE Primary Slave	Options are in its sub menu	Press <Enter> to enter the sub menu of detailed options
IDE Secondary Master	Options are in its sub menu	Press <Enter> to enter the sub menu of detailed options
IDE Secondary Master	Options are in its sub menu	Press <Enter> to enter the sub menu of detailed options
Drive A Drive B	None 360K, 5.25 in 1.2M, 5.25 in 720K, 3.5 in 1.44M, 3.5 in 2.88M, 3.5 in	Select the type of floppy disk drive installed in your system
Video	EGA/VGA CGA 40 CGA 80 MONO	Select the default video device

Item	Options	Description
Halt On	All Errors No Errors All, but Keyboard All, but Diskette All, but Disk/Key	Select the situation in which you want the BIOS to stop the POST process and notify you
Base Memory	N/A	Displays the amount of conventional memory detected during boot up
Extended Memory	N/A	Displays the amount of extended memory detected during boot up
Total Memory	N/A	Displays the total memory available in the system

IDE Adapters

The IDE adapters control the hard disk drive. Use a separate sub menu to configure each hard disk drive.

Use the legend keys to navigate through this menu and exit to the main menu.

Item	Options	Description
IDE HDD Auto-detection	Press Enter	Press Enter to auto-detect the HDD on this channel. If detection is successful, it fills the remaining fields on this menu.
IDE Primary Master	None Auto Manual	Selecting 'manual' lets you set the remaining fields on this screen. Selects the type of fixed disk. "User Type" will let you select the number of cylinders, heads, etc. Note: PRECOMP=65535 means NONE!
Capacity	Auto Display your disk drive size	Disk drive capacity (Approximated). Note that this size is usually slightly greater than the size of a formatted disk given by a disk checking program.
Access Mode	CHS LBA Large Auto	Choose the access mode for this hard disk
The following options are selectable only if the 'IDE Primary Master' item is set to 'Manual'		
Cylinder	Min = 0 Max = 65535	Set the number of cylinders for this hard disk.
Head	Min = 0 Max = 255	Set the number of read/write heads
Precomp	Min = 0 Max = 65535	Hard disk
Landing zone	Min = 0 Max = 65535	****
Sector	Min = 0 Max = 255	Number of sectors per track

Advanced BIOS Features Setup

This section allows you to configure your system for basic operation. You have the opportunity to select the system's default speed, boot-up sequence, keyboard operation, shadowing and security.

Phoenix - AwardBIOS CMOS Setup Utility
Advanced BIOS Features

Virus Warning	[Disabled]	Item Help
CPU L1 & L2 Cache	[Enabled]	Menu Level ▶
Quick Power On Self Test	[Enabled]	
First Boot Device	[Floppy]	
Second Boot Device	[HDD-0]	Allows you to choose the VIRUS warning feature for IDE Hard Disk boot sector protection. If this function is enabled and someone attempt to write data into this area , BIOS will show a warning message on screen and alarm beep
Third Boot Device	[LS120]	
Boot Other Device	[Enabled]	
Swap Floppy Drive	[Disabled]	
Boot Up Floppy Seek	[Enabled]	
Boot Up NumLock Status	[On]	
Gate A20 Option	[Fast]	
Typeomatic Rate Setting	[Disabled]	
x Typeomatic Rate (Chars/Sec)	6	
x Typeomatic Delay (Msec)	250	
Security Option	[Setup]	
APIC Mode	[Enabled]	
MPS Version Control For OS	[1.4]	
OS Select For DRAM > 64MB	[Non-OS2]	
Report No FDD For WIN 95	[No]	

↑↓←→:Move Enter:Select +/-/PU/PD:Value F10:Save ESC:Exit F1:General Help
F5: Previous Values F6: Fail-Safe Defaults F7: Optimized Defaults

Figure 8.3. Advanced BIOS Features Setup

Virus Warning

When enabled, you receive a warning message if a program (specifically, a virus) attempts to write to the boot sector or the partition table of the hard disk drive. You should then run an anti-virus program. Keep in mind that this feature protects only the boot sector, not the entire hard drive.

⚠ CAUTION

Many disk diagnostic programs that access the boot sector table can trigger the virus warning message. If you plan to run such a program, we recommend that you first disable the virus warning.

Enabled	Activates automatically when the system boots up causing a warning message to appear when anything attempts to access the boot sector or hard disk partition table.
Disabled	No warning message will appear when anything attempts to access the boot sector or hard disk partition table.

Description	Choice
<p>CPU L1 & L2 Cache</p> <p>CPU L1/L2 Cache Enabled/Disabled select. Usually, select Enabled.</p>	<div style="border: 1px solid black; padding: 5px;"> <p>CPU L1 & L2 Cache</p> <hr/> <p>Enabled <input checked="" type="checkbox"/></p> <p>Disabled <input type="checkbox"/></p> <hr/> <p>↑↓:Move ENTER:Accept ESC:Abort</p> </div>
<p>Quick Power On Self Test</p> <p>Select Enabled to reduce the amount of time required to run the power-on self-test (POST). A quick POST skips certain steps.</p>	<div style="border: 1px solid black; padding: 5px;"> <p>Quick Power On Self Test</p> <hr/> <p>Enabled <input type="checkbox"/></p> <p>Disabled <input checked="" type="checkbox"/></p> <hr/> <p>↑↓:Move ENTER:Accept ESC:Abort</p> </div>
<p>First/Second/Third/Other Boot Device</p> <p>The BIOS attempts to load the operating system from the devices in the sequence selected in these items.</p>	<div style="border: 1px solid black; padding: 5px;"> <p>First Boot Device</p> <hr/> <p>Floppy <input checked="" type="checkbox"/></p> <p>LS120 <input type="checkbox"/></p> <p>HDD-0 <input type="checkbox"/></p> <p>SCSI <input type="checkbox"/></p> <p>CDROM <input type="checkbox"/></p> <p>HDD-1 <input type="checkbox"/></p> <p>HDD-2 <input type="checkbox"/></p> <p>HDD-3 <input type="checkbox"/></p> <p>ZIP100 <input type="checkbox"/></p> <p>USB-FDD <input type="checkbox"/></p> <p>USB-ZIP <input type="checkbox"/></p> <p>USB-CDROM <input type="checkbox"/></p> <p>USB-HDD <input type="checkbox"/></p> <p>LAN <input type="checkbox"/></p> <p>Disabled <input type="checkbox"/></p> <hr/> <p>↑↓:Move ENTER:Accept ESC:Abort</p> </div>
<p>Swap Floppy Drive</p> <p>This field is effective only in systems with two floppy drives. Selecting Enabled assigns physical drive B to logical drive A, and physical drive A to logical drive B.</p> <p>If the system has two floppy drives, you can swap the logical drive name assignments.</p>	<div style="border: 1px solid black; padding: 5px;"> <p>Swap Floppy Drive</p> <hr/> <p>Disabled <input checked="" type="checkbox"/></p> <p>Enabled <input type="checkbox"/></p> <hr/> <p>↑↓:Move ENTER:Accept ESC:Abort</p> </div>

Description	Choice
<p>Boot Up Floppy Seek</p> <p>When Enabled, the BIOS tests (seeks) floppy drives to determine whether they have 40 or 80 tracks. Only 360-KB floppy drives have 40 tracks; drives with 720 KB, 1.2 MB, and 1.44 MB capacity all have 80 tracks. Because very few modern PCs have 40-track floppy drives, we recommend that you set this field to Disabled to save time.</p> <p>Seeks disk drives during boot up. Disabling speeds boot up.</p>	<div style="border: 1px solid black; padding: 5px;"> <p>Boot Up Floppy Seek</p> <hr/> <p>Disabled <input type="checkbox"/></p> <p>Enabled <input checked="" type="checkbox"/></p> <hr/> <p>↑↓:Move ENTER:Accept ESC:Abort</p> </div>
<p>Boot Up NumLock Status</p> <p>Toggle between On or Off to control the state of the NumLock key when the system boots. When toggled On, the numeric keypad generates numbers instead of controlling cursor operations.</p>	<div style="border: 1px solid black; padding: 5px;"> <p>Boot Up NumLock Status</p> <hr/> <p>On <input type="checkbox"/></p> <p>Off <input checked="" type="checkbox"/></p> <hr/> <p>↑↓:Move ENTER:Accept ESC:Abort</p> </div>
<p>Gate A20 option</p> <p>Gate A20 refers to the way the system addresses memory above 1 MB (extended memory). When set to Fast, the system chipset controls Gate A20. When set to Normal, a pin in the keyboard controller controls Gate A20. Setting Gate A20 to Fast improves system speed, particularly with OS/2 and Windows</p>	<div style="border: 1px solid black; padding: 5px;"> <p>Gate A20 Option</p> <hr/> <p>Normal <input type="checkbox"/></p> <p>Fast <input checked="" type="checkbox"/></p> <hr/> <p>↑↓:Move ENTER:Accept ESC:Abort</p> </div>
<p>Typematic Rate Setting</p> <p>When Disabled, the following two items (Typematic Rate and Typematic Delay) are irrelevant. Keystrokes repeat at a rate determined by the keyboard controller in your system. When Enabled, you can select a typematic rate and typematic delay.</p>	<div style="border: 1px solid black; padding: 5px;"> <p>Typematic Rate Setting</p> <hr/> <p>Disabled <input type="checkbox"/></p> <p>Enabled <input checked="" type="checkbox"/></p> <hr/> <p>↑↓:Move ENTER:Accept ESC:Abort</p> </div>
<p>Typematic Rate (Chars/Sec)</p> <p>When the typematic rate setting is enabled, you can select a typematic rate (the rate at which character repeats when you hold down a key) of 6, 8, 10, 12, 15, 20, 24 or 30 characters per second.</p>	<div style="border: 1px solid black; padding: 5px;"> <p>Typematic Rate (Chars/Sec)</p> <hr/> <p>6 <input checked="" type="checkbox"/></p> <p>8 <input type="checkbox"/></p> <p>10 <input type="checkbox"/></p> <p>12 <input type="checkbox"/></p> <p>15 <input type="checkbox"/></p> <p>20 <input type="checkbox"/></p> <p>24 <input type="checkbox"/></p> <p>30 <input type="checkbox"/></p> <hr/> <p>↑↓:Move ENTER:Accept ESC:Abort</p> </div>

8. BIOS Setup

Description	Choice
<p>Typematic Delay (Msec)</p> <p>When the typematic rate setting is enabled, you can select a typematic delay (the delay before key strokes begin to repeat) of 250, 500, 750 or 1000 milliseconds.</p>	<div style="border: 1px solid black; padding: 5px;"> <p>Typematic Delay (Msec)</p> <hr/> <p>250 [■] 500 [] 750 [] 1000 []</p> <hr/> <p>↑↓:Move ENTER:Accept ESC:Abort</p> </div>
<p>Security Option</p> <p>Select whether the password is required every time the system boots or only when you enter setup. If you have set a password, select whether the password is required every time the System boots, or only when you enter Setup.</p> <p>System: The system will not boot and access to Setup will be denied if the correct password is not entered at the prompt.</p> <p>Setup: The system will boot, but access to Setup will be denied if the correct password is not entered at the prompt.</p>	<div style="border: 1px solid black; padding: 5px;"> <p>Security Option</p> <hr/> <p>Setup [■] System []</p> <hr/> <p>↑↓:Move ENTER:Accept ESC:Abort</p> </div>
<p>Note: To disable security, select PASSWORD SETTING at Main Menu and then you will be asked to enter password. Do not type anything and just press <Enter>, it will disable security. Once the security is disabled, the system will boot and you can enter Setup freely.</p>	
<p>S Select For DRAM > 64MB</p> <p>Select OS2 only if you are running OS/2 operating system with greater than 64 MB of RAM on your system.</p>	<div style="border: 1px solid black; padding: 5px;"> <p>OS Select For DRAM > 64MB</p> <hr/> <p>Non-OS2 [■] OS2 []</p> <hr/> <p>↑↓:Move ENTER:Accept ESC:Abort</p> </div>
<p>Report No FDD For Win 95</p> <p>Select Yes to release IRQ6 when the system contains no floppy drive, for compatibility with Windows 95 logo certification. In the Integrated Peripherals screen, select Disabled for the Onboard FDC Controller field.</p>	<div style="border: 1px solid black; padding: 5px;"> <p>Report No FDD For WIN 95</p> <hr/> <p>No [■] Yes []</p> <hr/> <p>↑↓:Move ENTER:Accept ESC:Abort</p> </div>

Advanced Chipset Features Setup

Phoenix - AwardBIOS CMOS Setup Utility
Advanced Chipset Features

DRAM Timing Selectable [By SPD] CAS Latency Time [2.5] Active to Precharge Delay [7] DRAM RAS# to CAS# Delay [3] DRAM RAS# Precharge [3] Memory Frequency For [Auto] System BIOS Cacheable [Enabled] Video BIOS Cacheable [Disabled] Memory Hole At 15M-16M [Disabled] Delayed Transaction [Enabled] Delay Prior to Thermal [16 Min] AGP Aperture Size (MB) [64] ** On-Chip VGA Setting ** On-Chip VGA [Enabled] On-Chip Frame Buffer Size [8MB] Boot Display [Auto] Panel Number [1024 x 768]	Item Help Menu Level ▶
--	---------------------------

↑↓: Move Enter: Select +/-/PU/PD: Value F10: Save ESC: Exit F1: General Help
 F5: Previous Values F6: Fail-Safe Defaults F7: Optimized Defaults

Figure 8.4. Advanced Chipset Features Setup

This section allows you to configure the system based on the specific features of the installed chipset. This chipset manages bus speeds and access to system memory resources, such as DRAM and the external cache. It also coordinates communications between the conventional ISA bus and the PCI bus. It must be stated that these items should never need to be altered. The default settings have been chosen because they provide the best operating conditions for your system. The only time you might consider making any changes would be if you discovered that data was being lost while using your system.

Description	Choice
DRAM Timing Selectable The value in this field depends on performance parameters of the installed memory chips (DRAM). Do not change the value from the factory setting unless you install new memory that has a different performance rating than the original DRAMs	<div style="border: 1px solid black; padding: 5px;"> DRAM Timing Selectable Manual [] By SPD [■] </div> <p>↑↓: Move ENTER: Accept ESC: Abort</p>
CAS Latency Time When synchronous DRAM is installed, the number of clock cycles of CAS latency depends on the DRAM timing. Do not reset this field from the default value specified by the system designer. installed DRAM or the installed CPU.	<div style="border: 1px solid black; padding: 5px;"> CAS Latency Time 1.5 [■] 2 [] 2.5 [] </div> <p>↑↓: Move ENTER: Accept ESC: Abort</p>

Description	Choice
<p>Active to Precharge delay</p> <p>Select the precharge delay timer.</p>	<p>Active to Precharge Delay</p> <hr/> <p>7 [■] 6 [] 5 []</p> <hr/> <p>↑↓:Move ENTER:Accept ESC:Abort</p>
<p>DRAM RAS# to CAS# delay</p> <p>This field lets you insert a timing delay between the CAS and RAS strobe signals, used when DRAM is written to, read from, or refreshed. Fast gives faster performance; and Slow gives more stable performance. This field applies only when synchronous DRAM is installed in the system.</p>	<p>DRAM RAS# to CAS# Delay</p> <hr/> <p>3 [■] 2 []</p> <hr/> <p>↑↓:Move ENTER:Accept ESC:Abort</p>
<p>DRAM RAS# Precharge</p> <p>The precharge time is the number of cycles it takes for the RAS to accumulate its charge before DRAM refresh. If insufficient time is allowed, refresh may be incomplete and the DRAM may fail to retain data.</p>	<p>DRAM RAS# Precharge</p> <hr/> <p>3 [■] 2 []</p> <hr/> <p>↑↓:Move ENTER:Accept ESC:Abort</p>
<p>Memory Frequency for</p> <p>Select the memory frequency for DDR200 when install the memory with specification of DDR200, or when install the memory with specification of DDR266, or Auto define by the BIOS.</p>	<p>Memory Frequency For</p> <hr/> <p>DDR200 [] DDR266 [] Auto [■]</p> <hr/> <p>↑↓:Move ENTER:Accept ESC:Abort</p>
<p>System BIOS Cacheable</p> <p>Selecting Enabled allows caching of the system BIOS ROM at F0000h-FFFFFh, resulting in better system performance. However, if any program writes to this memory area, a system error may result.</p>	<p>System BIOS Cacheable</p> <hr/> <p>Disabled [] Enabled [■]</p> <hr/> <p>↑↓:Move ENTER:Accept ESC:Abort</p>

Description	Choice
<p>Video BIOS Cacheable</p> <p>Selecting Enabled allows caching of the video BIOS ROM at C0000h to CBFFFh, resulting in better video performance. However, if any program writes to this memory area, a system error may result.</p>	<p>Video BIOS Cacheable</p> <p>Disabled <input checked="" type="checkbox"/></p> <p>Enabled <input type="checkbox"/></p> <p>↑↓:Move ENTER:Accept ESC:Abort</p>
<p>Memory Hole At 15M-16M</p> <p>You can reserve this area of system memory for ISA adapter ROM. When this area is reserved, it cannot be cached. The user information of peripherals that need to use this area of system memory usually discusses their memory requirements.</p>	<p>Memory Hole At 15M-16M</p> <p>Disabled <input checked="" type="checkbox"/></p> <p>Enabled <input type="checkbox"/></p> <p>↑↓:Move ENTER:Accept ESC:Abort</p>
<p>Delay Transaction</p> <p>The chipset has an embedded 32-bit posted write buffer to support delay transactions cycles. Select Enabled to support compliance with PCI specification version 2.1.</p>	<p>Delayed Transaction</p> <p>Disabled <input type="checkbox"/></p> <p>Enabled <input checked="" type="checkbox"/></p> <p>↑↓:Move ENTER:Accept ESC:Abort</p>
<p>Delay Prior to Thermal</p> <p>Select the interval to setup the delay timer for CPU Thermal-Throttling.</p>	<p>Delay Prior to Thermal</p> <p>4 Min <input type="checkbox"/></p> <p>8 Min <input type="checkbox"/></p> <p>16 Min <input checked="" type="checkbox"/></p> <p>32 Min <input type="checkbox"/></p> <p>↑↓:Move ENTER:Accept ESC:Abort</p>
<p>AGP Aperture Size (MB)</p> <p>Select the size of the Accelerated Graphics Port (AGP) aperture. The aperture is a portion of the PCI memory address range dedicated for graphics memory address space. Host cycles that hit the aperture range are forwarded. Host cycles that hit the aperture range are forwarded to the AGP without any translation.</p>	<p>AGP Aperture Size (MB)</p> <p>4 <input type="checkbox"/></p> <p>8 <input type="checkbox"/></p> <p>16 <input type="checkbox"/></p> <p>32 <input type="checkbox"/></p> <p>64 <input checked="" type="checkbox"/></p> <p>128 <input type="checkbox"/></p> <p>256 <input type="checkbox"/></p> <p>↑↓:Move ENTER:Accept ESC:Abort</p>
On-Chip VGA setting	

Description	Choice
<p>On-Chip VGA</p> <p>When Enabled to choice the on-board VGA function, otherwise disabled the on-board VGA function.</p>	<p>On-Chip VGA</p> <hr/> <p>Enabled [■] Disabled []</p> <hr/> <p>↑↓:Move ENTER:Accept ESC:Abort</p>
<p>On chip Frame buffer size</p> <p>When Enabled, a fixed VGA frame buffer from A000h to BFFFh and a CPU-to-PCI write buffer are implemented.</p>	<p>On-Chip Frame Buffer Size</p> <hr/> <p>1MB [] 8MB [■]</p> <hr/> <p>↑↓:Move ENTER:Accept ESC:Abort</p>
<p>Boot Display</p> <p>Select the boot display device.</p> <p>CRT: Analog RGB Display LFP: LVDS Display EFP: DVI Display</p> <p>(Only SPI-8451-LLVA and SPI-8452-LLVA are effective.)</p>	<p>Boot Display</p> <hr/> <p>Auto [■] CRT [] LFP [] CRT+LFP [] EFP [] CRT+EFP []</p> <hr/> <p>↑↓:Move ENTER:Accept ESC:Abort</p>
<p>Panel Number</p> <p>Select the panel device resolution.</p>	<p>Panel Number</p> <hr/> <p>640 × 480 [] 800 × 600 [] 1024 × 768 [■] 1280 × 1024 []</p> <hr/> <p>↑↓:Move ENTER:Accept ESC:Abort</p>

Integrated Peripherals

Phoenix - AwardBIOS CMOS Setup Utility
Integrated Peripherals

<pre> On-Chip Primary PCI IDE [Enabled] IDE Primary Master PIO [Auto] IDE Primary Slave PIO [Auto] IDE Primary Master UDMA [Auto] IDE Primary Slave UDMA [Auto] On-Chip Secondary PCI IDE [Enabled] IDE Secondary Master PIO [Auto] IDE Secondary Slave PIO [Auto] IDE Secondary Master UDMA [Auto] IDE Secondary Slave UDMA [Auto] USB Controller [Enabled] USB 2.0 Controller [Enabled] USB Keyboard Support [Disabled] USB Mouse Support [Disabled] AC97 Audio [Auto] Init Display First [Onboard/AGP] Onboard LAN [Enabled] Internal LAN [Enabled] RAID Function [Enabled] IDE HDD Block Mode [Enabled] Onboard FDC Controller [Enabled] Onboard Serial Port 1 [3F8/IRQ4] Onboard Serial Port 2 [2F8/IRQ3] Onboard Parallel Port [378/IRQ7] Parallel Port Mode [SPP] EPP Mode Select [EPP1.7] ECP Mode Use DMA [3] </pre>	<pre> Item Help Menu Level ▶ </pre>
---	-------------------------------------

↑↓:Move Enter:Select +/-/PU/PD:Value F10:Save ESC:Exit F1:General Help
F5: Previous Values F6: Fail-Safe Defaults F7: Optimized Defaults

Figure 8.5. Integrated Peripherals

Description	Choice
<p>On-Chip Primary PCI IDE</p> <p>The integrated peripheral controller contains an IDE interface with support for two IDE channels. Select Enabled to activate each channel separately.</p>	<pre> On-Chip Primary PCI IDE ----- Disabled [] Enabled [■] </pre> <p>↑↓:Move ENTER:Accept ESC:Abort</p>
<p>IDE Primary Master/Slave PIO</p> <p>The four IDE PIO (Programmed Input/Output) fields let you set a PIO mode (0 - 4) for each of the four IDE devices that the onboard IDE interface supports. Modes 0 through 4 provide successively increased performance. In Auto mode, the system automatically determines the best mode for each device.</p>	<pre> IDE Primary Master PIO ----- Auto [■] Mode 0 [] Mode 1 [] Mode 2 [] Mode 3 [] Mode 4 [] </pre> <p>↑↓:Move ENTER:Accept ESC:Abort</p>

Description	Choice
<p>IDE Primary Master/Slave UDMA</p> <p>UDMA (Ultra DMA) is a DMA data transfer protocol that utilizes ATA commands and the ATA bus to allow DMA commands to transfer data at a maximum burst rate of 33 MB/s. When you select Auto in the four IDE UDMA fields (for each of up to four IDE devices that the internal PCI IDE interface supports), the system automatically determines the optimal data transfer rate for each IDE device.</p>	<p>IDE Primary Master UDMA</p> <hr/> <p>Disabled [] Auto [■]</p> <hr/> <p>↑↓:Move ENTER:Accept ESC:Abort</p>
<p>On-Chip Secondary PCI IDE</p> <p>The integrated peripheral controller contains an IDE interface with support for two IDE channels. Select Enabled to activate each channel separately.</p>	<p>On-Chip Secondary PCI IDE</p> <hr/> <p>Disabled [] Enabled [■]</p> <hr/> <p>↑↓:Move ENTER:Accept ESC:Abort</p>
<p>IDE Secondary Master/Slave PIO</p> <p>The four IDE PIO (Programmed Input/Output) fields let you set a PIO mode (0-4) for each of the four IDE devices that the onboard IDE interface supports. Modes 0 through 4 provide successively increased performance. In Auto mode, the system automatically determines the best mode for each device.</p>	<p>IDE Secondary Master PIO</p> <hr/> <p>Auto [■] Mode 0 [] Mode 1 [] Mode 2 [] Mode 3 [] Mode 4 []</p> <hr/> <p>↑↓:Move ENTER:Accept ESC:Abort</p>
<p>IDE Secondary Master/Slave UDMA</p> <p>UDMA (Ultra DMA) is a DMA data transfer protocol that utilizes ATA commands and the ATA bus to allow DMA commands to transfer data at a maximum burst rate of 33 MB/s. When you select Auto in the four IDE UDMA fields (for each of up to four IDE devices that the internal PCI IDE interface supports), the system automatically determines the optimal data transfer rate for each IDE device.</p>	<p>IDE Secondary Slave PIO</p> <hr/> <p>Auto [■] Mode 0 [] Mode 1 [] Mode 2 [] Mode 3 [] Mode 4 []</p> <hr/> <p>↑↓:Move ENTER:Accept ESC:Abort</p>
<p>USB Controller</p> <p>Select Enabled if your system contains a Universal Serial Bus (USB) controller and you have USB peripherals.</p>	<p>USB Controller</p> <hr/> <p>Enabled [■] Disabled []</p> <hr/> <p>↑↓:Move ENTER:Accept ESC:Abort</p>

Description	Choice
<p>USB 2.0 controller</p> <p>Select Enabled if your system contains a Universal Serial Bus (USB 2.0) controller and you have USB peripherals.</p>	<div style="border: 1px solid black; padding: 5px;"> <p>USB 2.0 Controller</p> <hr/> <p>Enabled [■] Disabled []</p> <hr/> <p>↑↓:Move ENTER:Accept ESC:Abort</p> </div>
<p>USB Init Delay (SPI-8452-LLVA only)</p> <p>It is a setting that delays the initialization of USB.</p>	<p>Disable(Default)</p> <p>3 sec 5 sec 8 sec 10 sec</p>
<p>USB Keyboard Support</p> <p>Select Enabled if your system contains a Universal Serial Bus (USB) controller and you have a USB keyboard.</p>	<div style="border: 1px solid black; padding: 5px;"> <p>USB Keyboard Support</p> <hr/> <p>Enabled [■] Disabled []</p> <hr/> <p>↑↓:Move ENTER:Accept ESC:Abort</p> </div>
<p>USB Mouse support</p> <p>Select Enabled if your system contains a Universal Serial Bus (USB) controller and you have a USB mouse.</p>	<div style="border: 1px solid black; padding: 5px;"> <p>USB Mouse Support</p> <hr/> <p>Enabled [■] Disabled []</p> <hr/> <p>↑↓:Move ENTER:Accept ESC:Abort</p> </div>
<p>AC'97 Audio</p> <p>Select Enabled to use the audio capabilities of your system.</p>	<div style="border: 1px solid black; padding: 5px;"> <p>AC97 Audio</p> <hr/> <p>Auto [■] Disabled []</p> <hr/> <p>↑↓:Move ENTER:Accept ESC:Abort</p> </div>

Description	Choice
<p>Init Display First</p> <p>Initialize the on board video display before initializing any other display device on the system. Thus the on board display becomes the primary display.</p> <p>(Only SPI-8451-LLVA and SPI-8452-LLVA are effective.)</p>	<p>Init Display First</p> <hr/> <p>PCI Slot [] Onboard/AGP <input checked="" type="checkbox"/></p> <hr/> <p>↑↓:Move ENTER:Accept ESC:Abort</p>
<p>Onboard LAN</p> <p>Select Enabled to active the onboard GIGA-LAN controller, select Disabled to turn-off the onboard GIGA-LAN controller when you do not want to use this function.</p> <p>(Only SPI-8451-LLVA and SPI-8452-LLVA are effective.)</p>	<p>Onboard LAN</p> <hr/> <p>Disabled [] Enabled <input checked="" type="checkbox"/></p> <hr/> <p>↑↓:Move ENTER:Accept ESC:Abort</p>
<p>Intrernal LAN</p> <p>Select Enabled to active the onboard 10/100-LAN controller, select Disabled to turn-off the onboard 10/100-LAN controller when you do not want to use this function.</p>	<p>Internal LAN</p> <hr/> <p>Disabled [] Enabled <input checked="" type="checkbox"/></p> <hr/> <p>↑↓:Move ENTER:Accept ESC:Abort</p>
<p>RAID Function</p> <p>Select Enabled to active the onboard RAID controller, select Disabled to turn-off the onboard RAID controller when you do not want to use this function.</p> <p>(Only SPI-8451-LLVA is effective.)</p>	<p>RAID Function</p> <hr/> <p>Disabled [] Enabled <input checked="" type="checkbox"/></p> <hr/> <p>↑↓:Move ENTER:Accept ESC:Abort</p>
<p>IDE HDD Block mode</p> <p>Block mode is also called block transfer, multiple commands, or multiple sector read/write. If your IDE hard drive supports block mode (most new drives do), select Enabled for automatic detection of the optimal number of block read/writes per sector the drive can support.</p>	<p>IDE HDD Block Mode</p> <hr/> <p>Disabled [] Enabled <input checked="" type="checkbox"/></p> <hr/> <p>↑↓:Move ENTER:Accept ESC:Abort</p>

Description	Choice
<p>Onboard FDC Controller</p> <p>Select Enabled if your system has a floppy disk controller (FDC) installed on the system board and you wish to use it. If you install and-in FDC or the system has no floppy drive, select Disabled in this field.</p>	<p>Onboard FDC Controller</p> <hr/> <p>Disabled [] Enabled [■]</p> <hr/> <p>↑↓:Move ENTER:Accept ESC:Abort</p>
<p>Onboard Serial Port 1</p> <p>Select an address and corresponding interrupt for the first serial port.</p>	<p>Onboard Serial Port 1</p> <hr/> <p>Disabled [] 3F8/IRQ4 [■] 2F8/IRQ3 [] 3E8/IRQ4 [] 2E8/IRQ3 [] Auto []</p> <hr/> <p>↑↓:Move ENTER:Accept ESC:Abort</p>
<p>Onboard Serial Port 2</p> <p>Select an address and corresponding interrupt for the second serial port.</p>	<p>Onboard Serial Port 2</p> <hr/> <p>Disabled [] 3F8/IRQ4 [] 2F8/IRQ3 [■] 3E8/IRQ4 [] 2E8/IRQ3 [] Auto []</p> <hr/> <p>↑↓:Move ENTER:Accept ESC:Abort</p>
<p>Onboard Parallel Port</p> <p>Select a logical LPT port name and matching address for the physical parallel (printer) port</p>	<p>Onboard Parallel Port</p> <hr/> <p>Disabled [] 378/IRQ7 [■] 278/IRQ5 [] 3BC/IRQ7 []</p> <hr/> <p>↑↓:Move ENTER:Accept ESC:Abort</p>
<p>Parallel Port Mode</p> <p>Selected an operating mode for the onboard parallel port. Select Compatible or extended unless you are certain both your hardware and software support EPP or ECP mode.</p>	<p>Parallel Port Mode</p> <hr/> <p>SPP [■] EPP [] ECP [] ECP+EPP [] Normal []</p> <hr/> <p>↑↓:Move ENTER:Accept ESC:Abort</p>

Description	Choice						
ECP Mode Use DMA Select a DMA channel for the port	<table border="1"><thead><tr><th colspan="2">ECP Mode Use DMA</th></tr></thead><tbody><tr><td>1</td><td>..... []</td></tr><tr><td>3</td><td>..... [■]</td></tr></tbody></table> <p>↑↓:Move ENTER:Accept ESC:Abort</p>	ECP Mode Use DMA		1 []	3 [■]
ECP Mode Use DMA							
1 []						
3 [■]						

Power Management Setup

The Power Management Setup allows you to configure you system to most effectively save energy while operating in a manner consistent with your own style of computer use.

Phoenix - AwardBIOS CMOS Setup Utility Power Management Setup

Power-Supply Type	[AT]	Item Help
ACPI Function	[Disabled]	Menu Level ▶
ACPI Suspend Type	[S1(POS)]	
x Run VGABIOS if S3 Resume	Auto	Item Help
Power Management	[User Define]	
Video Off Method	[DPMS]	Menu Level ▶
Video Off In Suspend	[Yes]	
Suspend Type	[Stop Grant]	
MODEM Use IRQ	[3]	
HDD Power Down	[Disabled]	
Soft-Off by PWR-BTTN	[Instant-Off]	
Wake-Up by PCI card	[Enabled]	
Power On by Ring	[Enabled]	
x USB KB Wake-Up From S3	Disabled	
Resume by Alarm	[Disabled]	
x Date(of Month) Alarm	0	
x Time(hh:mm:ss) Alarm	0 : 0 : 0	
** Reload Global Timer Events **		
Primary IDE 0	[Disabled]	
Primary IDE 1	[Disabled]	
Secondary IDE 0	[Disabled]	
Secondary IDE 1	[Disabled]	
FDD,COM,LPT Port	[Disabled]	
PCI PIRQ[A-D]#	[Disabled]	

↑↓:Move Enter:Select +/-/PU/PD:Value F10:Save ESC:Exit F1:General Help
F5: Previous Values F6: Fail-Safe Defaults F7: Optimized Defaults

Figure 8.6. Power Management Setup

Description	Choice								
Power-Supply Type Select the power supply type.	<table border="1"> <tr> <td colspan="2">Power-Supply Type</td> </tr> <tr> <td>AT</td> <td>..... [■]</td> </tr> <tr> <td>ATX</td> <td>..... []</td> </tr> <tr> <td colspan="2">↑↓:Move ENTER:Accept ESC:Abort</td> </tr> </table>	Power-Supply Type		AT [■]	ATX []	↑↓:Move ENTER:Accept ESC:Abort	
Power-Supply Type									
AT [■]								
ATX []								
↑↓:Move ENTER:Accept ESC:Abort									
ACPI function Select to Enabled the ACPI function and select Disabled to disable the ACPI.	<table border="1"> <tr> <td colspan="2">ACPI Function</td> </tr> <tr> <td>Enabled</td> <td>..... []</td> </tr> <tr> <td>Disabled</td> <td>..... [■]</td> </tr> <tr> <td colspan="2">↑↓:Move ENTER:Accept ESC:Abort</td> </tr> </table>	ACPI Function		Enabled []	Disabled [■]	↑↓:Move ENTER:Accept ESC:Abort	
ACPI Function									
Enabled []								
Disabled [■]								
↑↓:Move ENTER:Accept ESC:Abort									

Description	Choice
<p>Power management</p>	<div style="border: 1px solid black; padding: 5px;"> <p>Power Management</p> <hr/> <p>User Define <input checked="" type="checkbox"/></p> <p>Min Saving <input type="checkbox"/></p> <p>Max Saving <input type="checkbox"/></p> <hr/> <p>↑↓:Move ENTER:Accept ESC:Abort</p> </div>
<p>Video Off Method</p> <p>This determines the manner in which the monitor is blanked.</p> <p>V/H SYNC+Blank</p> <p>This selection will cause the system to turn off the vertical and horizontal synchronization ports and write blanks to the video buffer.</p> <p>DPMS</p> <p>Initial display power management signaling.</p>	<div style="border: 1px solid black; padding: 5px;"> <p>Video Off Method</p> <hr/> <p>Blank Screen <input checked="" type="checkbox"/></p> <p>V/H SYNC+Blank <input type="checkbox"/></p> <p>DPMS <input type="checkbox"/></p> <hr/> <p>↑↓:Move ENTER:Accept ESC:Abort</p> </div>
<p>Video Off In Suspend</p> <p>This determines the manner in which the monitor is blanked.</p>	<div style="border: 1px solid black; padding: 5px;"> <p>Video Off In Suspend</p> <hr/> <p>No <input type="checkbox"/></p> <p>Yes <input checked="" type="checkbox"/></p> <hr/> <p>↑↓:Move ENTER:Accept ESC:Abort</p> </div>
<p>Suspend Type</p> <p>Select the Suspend Type.</p>	<div style="border: 1px solid black; padding: 5px;"> <p>Suspend Type</p> <hr/> <p>Stop Grant <input checked="" type="checkbox"/></p> <p>PwrOn Suspend <input type="checkbox"/></p> <hr/> <p>↑↓:Move ENTER:Accept ESC:Abort</p> </div>
<p>MODEM Use IRQ</p> <p>Name the interrupt request (IRQ) line assigned to the modem (if any) on your system. Activity of the selected IRQ always awakens the system.</p>	<div style="border: 1px solid black; padding: 5px;"> <p>MODEM Use IRQ</p> <hr/> <p>NA <input type="checkbox"/></p> <p>3 <input checked="" type="checkbox"/></p> <p>4 <input type="checkbox"/></p> <p>5 <input type="checkbox"/></p> <p>7 <input type="checkbox"/></p> <p>9 <input type="checkbox"/></p> <p>10 <input type="checkbox"/></p> <p>11 <input type="checkbox"/></p> <hr/> <p>↑↓:Move ENTER:Accept ESC:Abort</p> </div>

Description	Choice
Suspend Mode	<div style="border: 1px solid black; padding: 5px;"> <p style="text-align: center;">Suspend Mode</p> <hr/> <p>Disabled [■]</p> <p>1 Min []</p> <p>2 Min []</p> <p>4 Min []</p> <p>8 Min []</p> <p>12 Min []</p> <p>20 Min []</p> <p>30 Min []</p> <p>40 Min []</p> <p>1 Hour []</p> <hr/> <p style="text-align: center;">↑↓:Move ENTER:Accept ESC:Abort</p> </div>
<p>HDD Power Down</p> <p>When enabled and after the set time of system inactivity, the hard disk drive will be powered down while all other devices remain active.</p>	<div style="border: 1px solid black; padding: 5px;"> <p style="text-align: center;">HDD Power Down</p> <hr/> <p>Disabled [■]</p> <p>1 Min []</p> <p>2 Min []</p> <p>3 Min []</p> <p>4 Min []</p> <p>5 Min []</p> <p>6 Min []</p> <p>7 Min []</p> <p>8 Min []</p> <p>9 Min []</p> <p>10 Min []</p> <p>11 Min []</p> <p>12 Min []</p> <p>13 Min []</p> <p>14 Min []</p> <p>15 Min []</p> <hr/> <p style="text-align: center;">↑↓:Move ENTER:Accept ESC:Abort</p> </div>
<p>Soft-Off by PWR-BTTN</p> <p>When "Instant-off", immediate system is turn off if a power button is pushed. When "Delay 4 Sec.",system is off if a power button is pushed over about 4sec.</p>	<div style="border: 1px solid black; padding: 5px;"> <p style="text-align: center;">Soft-Off by PWR-BTTN</p> <hr/> <p>Instant-Off [■]</p> <p>Delay 4 Sec. []</p> <hr/> <p style="text-align: center;">↑↓:Move ENTER:Accept ESC:Abort</p> </div>

Description	Choice
<p>Power after PWR Fail</p> <p>Select a Power On status by the BIOS setup when power fails. When use ATX power supply and the setup jumper on the back plane is "AT mode", select this setting is "on".</p>	<p>PWRON After PWR-Fail</p> <hr/> <p>Off <input checked="" type="checkbox"/></p> <p>On <input type="checkbox"/></p> <p>Former-Sts <input type="checkbox"/></p> <hr/> <p>↑↓:Move ENTER:Accept ESC:Abort</p>
<p>CPU THRM-Throttling</p> <p>To select throttling ration for CPU speed down active when CPU temperature up to over specification.</p>	<p>CPU THRM-Throttling</p> <hr/> <p>87.5% <input type="checkbox"/></p> <p>75.0% <input type="checkbox"/></p> <p>62.5% <input type="checkbox"/></p> <p>50.0% <input checked="" type="checkbox"/></p> <p>37.5% <input type="checkbox"/></p> <p>25.0% <input type="checkbox"/></p> <p>12.5% <input type="checkbox"/></p> <hr/> <p>↑↓:Move ENTER:Accept ESC:Abort</p>
<p>Wake up by PCI card</p> <p>When Enabled, your can awakens the system from Suspend mode from PCI card event.</p>	<p>Wake-Up by PCI card</p> <hr/> <p>Disabled <input type="checkbox"/></p> <p>Enabled <input checked="" type="checkbox"/></p> <hr/> <p>↑↓:Move ENTER:Accept ESC:Abort</p>
<p>Power On by Ring</p> <p>An input signal on the serial Ring Indicator (RI) line (in other words, an incoming call on the modem) awakens the system from a soft off state.</p>	<p>Power On by Ring</p> <hr/> <p>Disabled <input type="checkbox"/></p> <p>Enabled <input checked="" type="checkbox"/></p> <hr/> <p>↑↓:Move ENTER:Accept ESC:Abort</p>

Description	Choice
<p>Resume by Alarm</p> <p>When Enabled, you can set the date and time at which the RTC (real-time clock) alarm awakens the system from Suspend mode.</p>	<p>Resume by Alarm</p> <p>Disabled []</p> <p>Enabled [■]</p> <p>↑↓:Move ENTER:Accept ESC:Abort</p>
<p>Date(of Month) Alarm</p> <p>Min= 0</p> <p>Max= 31</p> <p>Key in a DEC number :</p> <p>↑↓:Move ENTER:Accept ESC:Abort</p>	<p>Time(hh:mm:ss) Alarm</p> <p>Min= 0</p> <p>Max= 23</p> <p>Key in a DEC number :</p> <p>↑↓:Move ENTER:Accept ESC:Abort</p>
<p>Reload Global Timer Events: When Enabled, an event occurring on each listed device restarts the global timer for Standby mode.</p>	
<p>Primary IDE 0/1</p> <p>Disabled [■]</p> <p>Enabled []</p> <p>↑↓:Move ENTER:Accept ESC:Abort</p>	<p>Secondary IDE 0/1</p> <p>Disabled [■]</p> <p>Enabled []</p> <p>↑↓:Move ENTER:Accept ESC:Abort</p>
<p>FDD,COM,LPT Port</p> <p>Disabled [■]</p> <p>Enabled []</p> <p>↑↓:Move ENTER:Accept ESC:Abort</p>	<p>PCI PIRQ[A-D]#</p> <p>Disabled [■]</p> <p>Enabled []</p> <p>↑↓:Move ENTER:Accept ESC:Abort</p>

PnP/PCI Configuration Setup

This section describes configuring the PCI bus system. PCI, or Personal Computer Interconnect, is a system which allows I/O devices to operate at speeds nearing the speed the CPU itself uses when communicating with its own special components. This section covers some very technical items and it is strongly recommended that only experienced users should make any changes to the default settings.

Phoenix - AwardBIOS CMOS Setup Utility				
PnP/PCI Configurations				
PNP OS Installed [No] Reset Configuration Data [Disabled] Resources Controlled By [Manual] ▶ IRQ Resources [Press Enter] PCI/VGA Palette Snoop [Disabled] Assert PCI Device SERR# [Enabled]	<table border="1" style="width: 100%; border-collapse: collapse;"> <tr> <th style="text-align: center;">Item Help</th> </tr> <tr> <td>Menu Level ▶</td> </tr> <tr> <td>Select Yes if you are using a Plug and Play capable operating system Select No if you need the BIOS to configure non-boot devices</td> </tr> </table>	Item Help	Menu Level ▶	Select Yes if you are using a Plug and Play capable operating system Select No if you need the BIOS to configure non-boot devices
Item Help				
Menu Level ▶				
Select Yes if you are using a Plug and Play capable operating system Select No if you need the BIOS to configure non-boot devices				
↑↓:Move Enter:Select +/-/PU/PD:Value F10:Save ESC:Exit F1:General Help F5: Previous Values F6: Fail-Safe Defaults F7: Optimized Defaults				

Figure 8.7. PnP/PCI Configuration Setup

Description	Choices				
PNP OS Installed Select Yes if the system operating environment is Plug-and-Play aware (e.g. Windows 95).	<table border="1" style="width: 100%; border-collapse: collapse;"> <tr> <th style="text-align: left;">PNP OS Installed</th> </tr> <tr> <td>No []</td> </tr> <tr> <td>Yes []</td> </tr> <tr> <td style="text-align: center;">↑↓:Move ENTER:Accept ESC:Abort</td> </tr> </table>	PNP OS Installed	No []	Yes []	↑↓:Move ENTER:Accept ESC:Abort
PNP OS Installed					
No []					
Yes []					
↑↓:Move ENTER:Accept ESC:Abort					
Reset Configuration Data Normally, you leave this field Disabled. Select Enabled to reset Extended System Configuration Data (ESCD) when you exit Setup if you have installed a new add-on and the system reconfiguration has caused such a serious conflict that the operating system can not boot.	<table border="1" style="width: 100%; border-collapse: collapse;"> <tr> <th style="text-align: left;">Reset Configuration Data</th> </tr> <tr> <td>Disabled []</td> </tr> <tr> <td>Enabled []</td> </tr> <tr> <td style="text-align: center;">↑↓:Move ENTER:Accept ESC:Abort</td> </tr> </table>	Reset Configuration Data	Disabled []	Enabled []	↑↓:Move ENTER:Accept ESC:Abort
Reset Configuration Data					
Disabled []					
Enabled []					
↑↓:Move ENTER:Accept ESC:Abort					

Description	Choices
<p>Resource Controlled by</p> <p>The Award Plug and Play BIOS can automatically configure all the boot and Plug and Play – compatible devices. If you select Auto, all the interrupt request (IRQ) and DMA assignment fields disappear, as the BIOS automatically assigns them</p>	<div style="border: 1px solid black; padding: 5px;"> <p>Resources Controlled By</p> <hr/> <p>Auto <ESCD> [■]</p> <p>Manual []</p> <hr/> <p>↑↓:Move ENTER:Accept ESC:Abort</p> </div>

IRQ n Resources

Phoenix - AwardBIOS CMOS Setup Utility
IRQ Resources

IRQ-3 assigned to IRQ-4 assigned to IRQ-5 assigned to IRQ-7 assigned to IRQ-9 assigned to IRQ-10 assigned to IRQ-11 assigned to IRQ-12 assigned to IRQ-14 assigned to IRQ-15 assigned to	[PCI/ISA PnP] [PCI/ISA PnP] [PCI/ISA PnP] [PCI/ISA PnP] [PCI/ISA PnP] [PCI/ISA PnP] [PCI/ISA PnP] [PCI/ISA PnP] [PCI/ISA PnP]	Item Help Menu Level ▶▶ Legacy ISA for devices compliant with the original PC AT bus specification, PCI/ISA PnP for devices compliant with the Plug and Play standard whether designed for PCI or ISA bus architecture
---	---	--

↑↓:Move Enter:Select +/-/PU/PD:Ualue F10:Save ESC:Exit F1:General Help
 F5: Previous Values F6: Fail-Safe Defaults F7: Optimized Defaults

Figure 8.8. IRQ n Resources

When resources are controlled manually, assign each system interrupt as on of the following type, depending on the type of device using the interrupt.

Legacy ISA Devices compliant with the original PC AT bus specification, requiring a specific interrupt (Such as IRQ4 for serial port 1)

PCI/ISA PnP Devices compliant with the Plug and Play standard, whether designed for PCI or ISA bus architecture.

The Choice: Legacy ISA and PCI/ISA PnP.

Description	Choices
PCI/VGA Palette Snoop Leave this field at Disabled.	PCI/VGA Palette Snoop Disabled [■] Enabled [] ↑↓:Move ENTER:Accept ESC:Abort
Assert PCI Device SERR#	Assert PCI Device SERR# Disabled [] Enabled [■] ↑↓:Move ENTER:Accept ESC:Abort

PC Health Status

Phoenix - AwardBIOS CMOS Setup Utility
PC Health Status

Current System Temp. Current CPU1 Temperature Current CPUFAN1 Speed Current CPUFAN2 Speed Vcore VCCP +3.3V +5V +12V VBAT(V) 5VSB(V)	Item Help Menu Level ▶
---	---------------------------

↑↓←→:Move Enter:Select +/-/PU/PD:Value F10:Save ESC:Exit F1:General Help
F5: Previous Values F6: Fail-Safe Defaults F7: Optimized Defaults

Figure 8.9. PC Health Status

The BIOS shows the PC health status in this window.

Item	Description
Current System Temp.	This field displays the current system temperature, if your computer contains a monitoring system.
Current CPU1 Temp.	This field displays the current CPU temperature, if your computer contains a monitoring system.
Current CPUFAN1 / CPUFAN2 Speed	These fields display the current speed of up to three CPU fans, if your computer contains a monitoring system.
Vcore / VCCP / +12V / +5V / +3.3V / VBAT / 5VSB	These fields display the current voltage of input lines, if your computer contains a monitoring system.

Frequency / Voltage Control

Phoenix - AwardBIOS CMOS Setup Utility
Frequency/Voltage Control

Spread Spectrum	[Disabled]	Item Help
		Menu Level ▶

↑↓←→:Move Enter:Select +/-/PU/PD:Value F10:Save ESC:Exit F1:General Help
F5: Previous Values F6: Fail-Safe Defaults F7: Optimized Defaults

Figure 8.10. Frequency/Voltage Control

Description	Choices				
<p>Spread Spectrum</p> <p>When the system clock generator pulses, the extreme values of the pulse generate excess EMI. Enabling pulse spectrum spread modulation changes the extreme values from spikes to flat curves, thus reducing EMI. This benefit may in some cases be outweighed by problems with timing-critical devices, such as a clock-sensitive SCSI device.</p>	<table border="1"> <tr> <td>Spread Spectrum</td> </tr> <tr> <td>Enabled []</td> </tr> <tr> <td>Disabled [■]</td> </tr> <tr> <td>↑↓:Move ENTER:Accept ESC:Abort</td> </tr> </table>	Spread Spectrum	Enabled []	Disabled [■]	↑↓:Move ENTER:Accept ESC:Abort
Spread Spectrum					
Enabled []					
Disabled [■]					
↑↓:Move ENTER:Accept ESC:Abort					

Defaults Menu

Selecting “Defaults” from the main menu shows you two options which are described below

Load Fail-Safe Defaults

When you press <Enter> on this item you get a confirmation dialog box with a message similar to:

Load Fail-Safe Defaults (Y/N) ? N

Pressing ‘Y’ loads the BIOS default values for the most stable, minimal-performance system operations.

Load Optimized Defaults

When you press <Enter> on this item you get a confirmation dialog box with a message similar to:

Load Optimized Defaults (Y/N) ? N

Pressing ‘Y’ loads the default values that are factory settings for optimal performance system operations.

Supervisor/User Password Setting

You can set either supervisor or user password, or both of them. The differences between are:

SUPERVISOR PASSWORD: can enter and change the options of the setup menus.

USER PASSWORD: just can only enter but do not have the right to change the options of the setup menus. When you select this unction, the following message will appear at the center of the screen to assist you in creating a password.

ENTER PASSWORD:

Type the password, up to eight characters in length, and press <Enter>. The password typed now will clear any previously entered password from CMOS memory. You will be asked to confirm the password. Type the password again and press <Enter>. You may also press <Esc> to abort the selection and not enter a password.

To disable a password, just press <Enter> when you are prompted to enter the password. A message will confirm the password will be disabled. Once the password is disabled, the system will boot and you can enter Setup freely.

PASSWORD DISABLED.

When a password has been enabled, you will be prompted to enter it every time you try to enter Setup. This prevents an unauthorized person from changing any part of your system configuration.

Additionally, when a password is enabled, you can also require the BIOS to request a password every time your system is rebooted. This would prevent unauthorized use of your computer.

You determine when the password is required within the BIOS Features Setup Menu and its Security option (see Section 3). If the Security option is set to “System”, the password will be required both at boot and at entry to Setup. If set to “Setup”, prompting only occurs when trying to enter Setup.

Exit Selecting

Load Fail-Safe Defaults

Save & Exit Setup

Pressing <Enter> on this item asks for confirmation:

Save to CMOS and EXIT (Y/N)? **Y**

Pressing “Y” stores the selections made in the menus in CMOS – a special section of memory that stays on after you turn your system off. The next time you boot your computer, the BIOS configures your system according to the Setup selections stored in CMOS. After saving the values the system is restarted again.

Exit Without Saving

Pressing <Enter> on this item asks for confirmation:

Quit without saving (Y/N)? **Y**

This allows you to exit Setup without storing in CMOS any change. The previous selections remain in effect. This exits the Setup utility and restarts your computer.

POST Messages

During the Power on Self-Test (POST), if the BIOS detects an error requiring you to do something to fix, it will either sound a beep code or display a message.

If a message is displayed, it will be accompanied by:

PRESS F1 TO CONTINUE, CTRL-ALT-ESC OR DEL TO ENTER SETUP

POST Beep

Currently there are two kinds of beep codes in BIOS. This code indicates that a video error has occurred and the BIOS cannot initialize the video screen to display any additional information. This beep code consists of a single long beep followed by two short beeps. The other code indicates that your DRAM error has occurred. This beep code consists of a single long beep repeatedly.

Error Messages

One or more of the following messages may be displayed if the BIOS detects an error during the POST. This list includes messages for both the ISA and the EISA BIOS.

CMOS battery has failed

CMOS battery is no longer functional. It should be replaced.

CMOS checksum error

Checksum of CMOS is incorrect. This can indicate that CMOS has become corrupt. This error may have been caused by a weak battery. Check the battery and replace if necessary.

DISK BOOT failure**INSERT SYSTEM DISK AND PRESS ENTER**

No boot device was found. This could mean that either a boot drive was not detected or the drive does not contain proper system boot files. Insert a system disk into Drive A: and press <Enter>. If you assumed the system would boot from the hard drive, make sure the controller is inserted correctly and all cables are properly attached. Also be sure the disk is formatted as a boot device. Then reboot the system.

Diskette drives or types mismatch error**RUN SETUP**

Type of diskette drive installed in the system is different from the CMOS definition. Run Setup to reconfigure the drive type correctly.

Display switch is set incorrectly

Display switch on the motherboard can be set to either monochrome or color. This indicates the switch is set to a different setting than indicated in Setup. Determine which setting is correct, and then either turn off the system and change the jumper, or enter Setup and change the VIDEO selection.

Display type has changed since last BOOT

Since last powering off the system, the display adapter has been changed. You must configure the system for the new display type.

EISA configuration checksum error***PLEASE RUN EISA CONFIGURATION UTILITY***

The EISA non-volatile RAM checksum is incorrect or cannot correctly read the EISA slot. This can indicate either the EISA non-volatile memory has become corrupt or the slot has been configured incorrectly. Also be sure the card is in-stalled firmly in the slot.

EISA configuration is not complete***PLEASE RUN EISA CONFIGURATION UTILITY***

The slot configuration information stored in the EISA non-volatile memory is incomplete.

Note: When either of these errors appear, the system will boot in ISA mode, which allows you to run the EISA Configuration Utility.

Error encountered initializing hard drive

Hard drive cannot be initialized. Be sure the adapter is installed correctly and all cables are correctly and firmly attached. Also be sure the correct hard drive type is selected in Setup.

Error initializing hard disk controller

Cannot initialize controller. Make sure the cord is correctly and firmly installed in the bus. Be sure the correct hard drive type is selected in Setup. Also check to see if any jumper needs to be set correctly on the hard drive.

Floppy disk controller error or no controller present

Cannot find or initialize the floppy drive controller. Make sure the controller is installed correctly and firmly. If there are no floppy drives installed, be sure the Diskette Drive selection in Setup is set to NONE.

Invalid EISA configuration

PLEASE RUN EISA CONFIGURATION UTILITY

The non-volatile memory containing EISA configuration information was programmed incorrectly or has become corrupt. Re-run EISA configuration utility to correctly program the memory.

NOTE: When this error appears, the system will boot in ISA mode, which allows you to run the EISA Configuration Utility.

Keyboard error or no keyboard present

Cannot initialize the keyboard. Make sure the keyboard is attached correctly and no keys are being pressed during the boot.

If you are purposely configuring the system without a keyboard, set the error halt condition in Setup to HALT ON ALL, BUT KEYBOARD. This will cause the BIOS to ignore the missing keyboard and continue the boot.

Memory address error at ...

Indicates a memory address error at a specific location. You can use this location along with the memory map for your system to find and replace the bad memory chips.

Memory parity error at ...

Indicates a memory parity error at a specific location. You can use this location along with the memory map for your system to find and replace the bad memory chips.

Memory size has changed since last BOOT

Memory has been added or removed since the last boot. In EISA mode use Configuration Utility to reconfigure the memory configuration. In ISA mode enter Setup and enter the new memory size in the memory fields.

Memory verify error at ...

Indicates an error verifying a value already written to memory. Use the location along with your system's memory map to locate the bad chip.

Offending address not found

This message is used in conjunction with the I/O CHANNEL CHECK and RAM PARITY ERROR messages when the segment that has caused the problem cannot be isolated.

Offending segment

This message is used in conjunction with the I/O CHANNEL CHECK and RAM PARITY ERROR messages when the segment that has caused the problem has been isolated.

Press a key to REBOOT

This will be displayed at the bottom screen when an error occurs that requires you to reboot. Press any key and the system will reboot.

Press F1 to disable NMI, F1 to REBOOT

When BIOS detects a Non-maskable Interrupt condition during boot, this will allow you to disable the NMI and continue to boot, or you can reboot the system with the NMI enabled.

RAM parity error***CHECKING FOR SEGMENT ...***

Indicates a parity error in Random Access Memory.

Should be empty but EISA board found***PLEASE RUN EISA CONFIGURATION UTILITY***

A valid board ID was found in a slot that was configured as having no board ID.

NOTE: When this error appears, the system will boot in ISA mode, which allows you to run the EISA Configuration Utility.

Should have EISA board but not found***PLEASE RUN EISA CONFIGURATION UTILITY***

The board installed is not responding to the ID request, or no board ID has been found in the indicated slot.

NOTE: When this error appears, the system will boot in ISA mode, which allows you to run the EISA Configuration Utility.

Slot not empty

Indicates that a slot designated as empty by the EISA Configuration Utility actually contains a board.

NOTE: When this error appears, the system will boot in ISA mode, which allows you to run the EISA Configuration Utility.

System halted, (CTRL-ALT-DEL) to REBOOT ...

Indicates the present boot attempt has been aborted and the system must be rebooted. Press and hold down the CTRL and ALT keys and press DEL.

Wrong board in slot***PLEASE RUN EISA CONFIGURATION UTILITY***

The board ID does not match the ID stored in the EISA non-volatile memory.

NOTE: When this error appears, the system will boot in ISA mode, which allows you to run the EISA Configuration Utility.

Floppy disk(s) fail (80)

Unable to reset floppy subsystem.

Floppy disk(s) fail (40)

Floppy Type mismatch.

Hard disk(s) fail (80)

HDD reset failed.

Hard disk(s) fail (40)

HDD controller diagnostics failed.

Hard disk(s) fail (20)

HDD initialization error.

Hard disk(s) fail (10)

Unable to recalibrate fixed disk.

Hard disk(s) fail (08)

Sector Verify failed.

Keyboard is locked out – Unlock the key

Unlock the key. BIOS detect the keyboard is locked. P17 of keyboard controller is pulled low.

Keyboard error or no keyboard present

Cannot initialize the keyboard. Make sure the keyboard is attached correctly and no keys are being pressed during the boot.

Manufacturing POST loop

System will repeat POST procedure infinitely while the P15 of keyboard controller is pull low. This is also used for M/B burn in test.

BIOS ROM checksum error – System halted

The checksum of ROM address F0000H-FFFFFH is bad.

Memory test fail

BIOS reports the memory tests fail if the onboard memory is tested error.

POST Codes

POST (hex)	Description
CFh	Test CMOS R/W functionality.
C0h	Early chipset initialization: -Disable shadow RAM -Disable L2 cache (socket 7 or below) -Program basic chipset registers
C1h	Detect memory -Auto-detection of DRAM size, type and ECC. -Auto-detection of L2 cache (socket 7 or below)
C3h	Expand compressed BIOS code to DRAM
C5h	Call chipset hook to copy BIOS back to E000 & F000 shadow RAM.
01h	Expand the Xgroup codes locating in physical address 1000:0
02h	Reserved
03h	Initial Superio_Early_Init switch.
04h	Reserved
05h	Call chipset hook to copy BIOS back to E000 & F000 shadow RAM.
06h	Expand the Xgroup codes locating in physical address 1000:0
07h	Reserved
08h	Initial Superio_Early_Init switch.
09h	Reserved
0Ah	1. Blank out screen 2. Clear CMOS error flag
0Bh	Reserved
0Ch	1. Clear 8042 interface 2. Initialize 8042 self-test
0Dh	Reserved
0Eh	Test F000h segment shadow to see whether it is R/W-able or not. If test fails, keep beeping the speaker.
0Fh	Reserved
10h	Auto detect flash type to load appropriate flash R/W codes into the run time area in F000 for ESCD & DMI support.
11h	Reserved
12h	Use walking 1's algorithm to check out interface in CMOS circuitry. Also set real-time clock power status, and then check for override.
13h	Reserved
14h	Program chipset default values into chipset. Chipset default values are MODBINable by OEM customers.
15h	Reserved
16h	Initial Early_Init_Onboard_Generator switch.
17h	Reserved
18h	Detect CPU information including brand, SMI type (Cyrix or Intel®) and CPU level (586 or 686).
19h	Reserved
1Ah	Reserved
1Bh	Initial interrupts vector table. If no special specified, all H/W interrupts are directed to SPURIOUS_INT_HDLR & S/W interrupts to SPURIOUS_soft_HDLR.
1Ch	Reserved
1Dh	Initial EARLY_PM_INIT switch.
1Eh	Reserved
1Fh	Load keyboard matrix (notebook platform)

8. BIOS Setup

POST (hex)	Description
20h	Reserved
21h	HPM initialization (notebook platform)
22h	Reserved
23h	<ol style="list-style-type: none"> 1. Check validity of RTC value: e.g. a value of 5Ah is an invalid value for RTC minute. 2. Load CMOS settings into BIOS stack. If CMOS checksum fails, use default value instead. 3. Prepare BIOS resource map for PCI & PnP use. If ESCD is valid, take into consideration of the ESCD's legacy information. 4. Onboard clock generator initialization. Disable respective clock resource to empty PCI & DIMM slots. 5. Early PCI initialization: <ul style="list-style-type: none"> -Enumerate PCI bus number -Assign memory & I/O resource -Search for a valid VGA device & VGA BIOS, and put it into C000:0.
24h	Reserved
25h	Reserved
26h	Reserved
27h	Initialize INT 09 buffer
28h	Reserved
29h	<ol style="list-style-type: none"> 1. Program CPU internal MTRR (P6 & PII) for 0~640K memory address. 2. Initialize the APIC for Pentium class CPU. 3. Program early chipset according to CMOS setup. Example: onboard IDE controller. 4. Measure CPU speed. 5. Invoke video BIOS.
2Ah	Reserved
2Bh	Reserved
2Ch	Reserved
2Dh	<ol style="list-style-type: none"> 1. Initialize multi-language 2. Put information on screen display, including Award title, CPU type, CPU speed
2Eh	Reserved
2Fh	Reserved
30h	Reserved
31h	Reserved
32h	Reserved
33h	Reset keyboard except Winbond 977 series Super I/O chips.
34h	Reserved
35h	Reserved
36h	Reserved
37h	Reserved
38h	Reserved
39h	Reserved
3Ah	Reserved
3Bh	Reserved
3Ch	Test 8254
3Dh	Reserved
3Eh	Test 8259 interrupt mask bits for channel 1.
3Fh	Reserved
40h	Test 8259 interrupt mask bits for channel 2.
41h	Reserved
42h	Reserved
43h	Test 8259 functionality.
44h	Reserved

POST (hex)	Description
45h	Reserved
46h	Reserved
47h	Initialize EISA slot
48h	Reserved
49h	<ol style="list-style-type: none"> 1. Calculate total memory by testing the last double word of each 64K page. 2. Program writes allocation for AMD K5 CPU.
4Ah	Reserved
4Bh	Reserved
4Ch	Reserved
4Dh	Reserved
4Eh	<ol style="list-style-type: none"> 1. Program MTRR of M1 CPU 2. Initialize L2 cache for P6 class CPU & program CPU with proper cacheable range. 3. Initialize the APIC for P6 class CPU. 4. On MP platform, adjust the cacheable range to smaller one in case the cacheable ranges between each CPU are not identical.
4Fh	Reserved
50h	Initialize USB
51h	Reserved
52h	Test all memory (clear all extended memory to 0)
53h	Reserved
54h	Reserved
55h	Display number of processors (multi-processor platform)
56h	Reserved
57h	<ol style="list-style-type: none"> 1. Display PnP logo 2. Early ISA PnP initialization -Assign CSN to every ISA PnP device.
58h	Reserved
59h	Initialize the combined Trend Anti-Virus code.
5Ah	Reserved
5Bh	(Optional Feature) Show message for entering AWDFLASH.EXE from FDD (optional)
5Ch	Reserved
5Dh	<ol style="list-style-type: none"> 1. Initialize Init_Onboard_Super_IO switch. 2. Initialize Init_Onboard_AUDIO switch.
5Eh	Reserved
5Fh	Reserved
60h	Okay to enter Setup utility; i.e. not until this POST stage can users enter the CMOS setup utility.
61h	Reserved
62h	Reserved
63h	Reserved
64h	Reserved
65h	Initialize PS/2 Mouse
66h	Reserved
67h	Prepare memory size information for function call: INT 15h ax=E820h
68h	Reserved
69h	Turn on L2 cache
6Ah	Reserved
6Bh	Program chipset registers according to items described in Setup & Auto-configuration table.
6Ch	Reserved

8. BIOS Setup

POST (hex)	Description
6Dh	<ol style="list-style-type: none"> 1. Assign resources to all ISA PnP devices. 2. Auto assign ports to onboard COM ports if the corresponding item in Setup is set to "AUTO".
6Eh	Reserved
6Fh	<ol style="list-style-type: none"> 1. Initialize floppy controller 2. Set up floppy related fields in 40:hardware.
70h	Reserved
71h	Reserved
72h	Reserved
73h	(Optional Feature) Enter AWDFLASH.EXE if : -AWDFLASH is found in floppy drive. -ALT+F2 is pressed
74h	Reserved
75h	Detect & install all IDE devices: HDD, LS120, ZIP, CDROM.....
76h	Reserved
77h	Detect serial ports & parallel ports.
78h	Reserved
79h	Reserved
7Ah	Detect & install co-processor
7Bh	Reserved
7Ch	Reserved
7Dh	Reserved
7Eh	Reserved
7Fh	<ol style="list-style-type: none"> 1. Switch back to text mode if full screen logo is supported. -If errors occur, report errors & wait for keys -If no errors occur or F1 key is pressed to continue: ♦Clear EPA or customization logo.
80h	Reserved
81h	Reserved
82h	<ol style="list-style-type: none"> 1. Call chipset power management hook. 2. Recover the text fond used by EPA logo (not for full screen logo) 3. If password is set, ask for password.
83h	Save all data in stack back to CMOS
84h	Initialize ISA PnP boot devices
85h	<ol style="list-style-type: none"> 1. USB final Initialization 2. NET PC: Build SYSID structure 3. Switch screen back to text mode 4. Set up ACPI table at top of memory. 5. Invoke ISA adapter ROMs 6. Assign IRQs to PCI devices 7. Initialize APM 8. Clear noise of IRQs.
86h	Reserved
87h	Reserved
88h	Reserved
89h	Reserved
90h	Reserved
91h	Reserved
92h	Reserved
93h	Read HDD boot sector information for Trend Anti-Virus code

POST (hex)	Description
94h	<ol style="list-style-type: none">1. Enable L2 cache2. Program boot up speed3. Chipset final initialization.4. Power management final initialization5. Clear screen & display summary table6. Program K6 write allocation7. Program P6 class write combining
95h	<ol style="list-style-type: none">1. Program daylight saving2. Update keyboard LED & typematic rate
96h	<ol style="list-style-type: none">1. Build MP table2. Build & update ESCD3. Set CMOS century to 20h or 19h4. Load CMOS time into DOS timer tick5. Build MSIRQ routing table.
FFh	Boot attempt (INT 19h)

SPI-8451-LLVA SPI-8451-LVA SPI-8452-LLVA User's Manual

CONTEC CO.,LTD.

July 2009 Edition

3-9-31, Himesato, Nishiyodogawa-ku, Osaka 555-0025, Japan

Japanese <http://www.contec.co.jp/>

English <http://www.contec.com/>

Chinese <http://www.contec.com.cn/>

No part of this document may be copied or reproduced in any form by any means without prior written consent of CONTEC CO., LTD. [07172009]

[12082005]

[07172009_rev6]

Management No. A-51-117

Parts No. LYFM363

Free Manuals Download Website

<http://myh66.com>

<http://usermanuals.us>

<http://www.somanuals.com>

<http://www.4manuals.cc>

<http://www.manual-lib.com>

<http://www.404manual.com>

<http://www.luxmanual.com>

<http://aubethermostatmanual.com>

Golf course search by state

<http://golfingnear.com>

Email search by domain

<http://emailbydomain.com>

Auto manuals search

<http://auto.somanuals.com>

TV manuals search

<http://tv.somanuals.com>