

9084

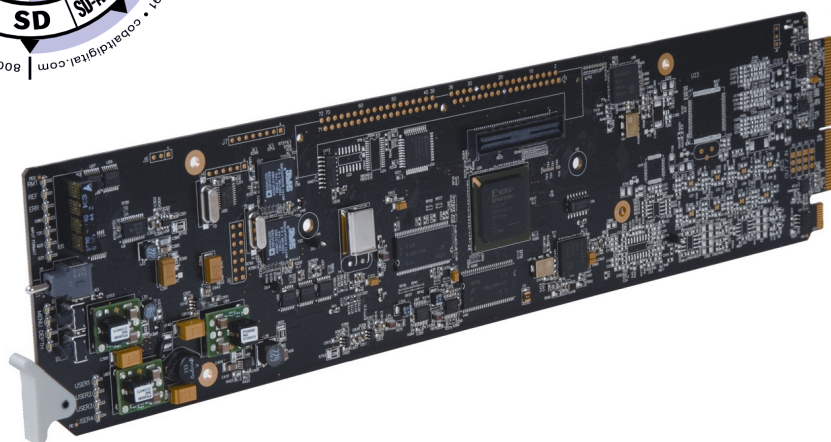

HD/SD-SDI RGB Color Corrector with YCbCr Video Proc and Frame Sync

Product Manual



Cobalt Digital Inc.

2406 E. University Ave.
Urbana, IL 61802
Voice 217.344.1243 • Fax 217.344.1245
www.cobaltdigital.com

9084-OM (V4.0)

Copyright

©Copyright 2009, Cobalt Digital Inc. All Rights Reserved.

Duplication or distribution of this manual and any information contained within is strictly prohibited without the express written permission of Cobalt Digital Inc. This manual and any information contained within, may not be reproduced, distributed, or transmitted in any form, or by any means, for any purpose, without the express written permission of Cobalt Digital Inc. Reproduction or reverse engineering of software used in this device is prohibited.

Disclaimer

The information in this document has been carefully examined and is believed to be entirely reliable. However, no responsibility is assumed for inaccuracies. Furthermore, Cobalt Digital Inc. reserves the right to make changes to any products herein to improve readability, function, or design. Cobalt Digital Inc. does not assume any liability arising out of the application or use of any product or circuit described herein.

Trademark Information

Cobalt[®] is a registered trademark of Cobalt Digital Inc.

COMPASS[™] is a trademark of Cobalt Digital Inc.

DashBoard[™] and **openGear**[™] are trademarks of Ross Video Limited. **Tektronix**[®] is a registered trademark of Tektronix, Inc. Other product names or trademarks appearing in this manual are the property of their respective owners.

Congratulations on choosing the Cobalt[®] 9084 HD/SD-SDI RGB Color Corrector with YCbCr Video Proc and Frame Sync. The 9084 is part of a full line of processing and modular conversion gear for broadcast TV environments. The Cobalt Digital Inc. line includes video decoders and encoders, audio embedders and de-embedders, distribution amplifiers, format converters, remote control systems and much more. Should you have questions pertaining to the installation or operation of your 9084, please contact us at the contact information on the front cover.

Manual No.:	9084-OM
Document Version:	4.0
Release Date:	November 6, 2009
Applicable for 9084 Software Version:	4.0 / 2740

Table of Contents

Chapter 1	Introduction	1-1
	Overview	1-1
	9084 Card Software Versions and this Manual	1-2
	Manual Conventions	1-3
	Warnings, Cautions, and Notes	1-3
	Labeling Symbol Definitions.....	1-4
	Safety Summary	1-4
	Warnings.....	1-4
	Cautions	1-4
	9084 Functional Description	1-5
	9084 Input/Outputs	1-5
	Color Corrector	1-7
	Video Processor	1-7
	Frame Sync Function.....	1-7
	AFD Inserter	1-7
	User Control Interface	1-8
	9084 Rear I/O Modules	1-10
	Video Formats Supported by the 9084	1-10
	Technical Specifications	1-11
	Warranty and Service Information	1-14
	Cobalt Digital Inc. Limited Warranty.....	1-14
	Contact Cobalt Digital Inc.....	1-15
Chapter 2	Installation and Setup	2-1
	Overview	2-1
	Installing the 9084 Into a Frame Slot	2-1
	Installing a Rear I/O Module	2-3
	Setting Up 9084 Network Remote Control	2-4

Chapter 3	Operating Instructions	3-1
	Overview	3-1
	Control and Display Descriptions	3-1
	Function Submenu/Parameter Submenu Overview	3-2
	9084 Card Edge Controls, Indicators, and Display	3-3
	DashBoard™ User Interface	3-7
	Cobalt® Remote Control Panel User Interfaces	3-9
	Accessing the 9084 Card via Remote Control	3-10
	Accessing the 9084 Card Using DashBoard™	3-10
	Accessing the 9084 Card Using a Cobalt® Remote Control Panel	3-11
	Checking 9084 Card Information.....	3-12
	Ancillary Data Line Number Locations and Ranges	3-13
	9084 Function Submenu List and Descriptions	3-14
	Video Proc	3-15
	AFD	3-18
	Color Correction	3-19
	Framesync	3-22
	Presets	3-25
	Color and Video Correction Examples Using the 9084.....	3-27
	On-Set Monitor Color Correction Example	3-27
	Miscellaneous Color and Video Correction Examples	3-31
	Troubleshooting	3-34
	Error and Failure Indicator Overview	3-34
	Basic Troubleshooting Checks.....	3-38
	9084 Processing Error Troubleshooting.....	3-39
	Troubleshooting Network/Remote Control Errors.....	3-40
	In Case of Problems	3-40

Introduction

Overview

This manual provides installation and operating instructions for the 9084 HD/SD-SDI RGB Color Corrector with YCbCr Video Proc and Frame Sync card (also referred to herein as the 9084).

This manual consists of the following chapters:

- **Chapter 1, “Introduction”** – Provides information about this manual and what is covered. Also provides general information regarding the 9084.
- **Chapter 2, “Installation and Setup”** – Provides instructions for installing the 9084 in a frame, and optionally installing a Rear I/O Module.
- **Chapter 3, “Operating Instructions”** – Provides overviews of operating controls and instructions for using the 9084.

This chapter contains the following information:

- **9084 Card Software Versions and this Manual (p. 1-2)**
- **Manual Conventions (p. 1-3)**
- **Safety Summary (p. 1-4)**
- **9084 Functional Description (p. 1-5)**
- **Technical Specifications (p. 1-11)**
- **Warranty and Service Information (p. 1-14)**
- **Contact Cobalt Digital Inc. (p. 1-15)**

9084 Card Software Versions and this Manual

When applicable, Cobalt Digital Inc. provides for continual COMPASS™ card product enhancements through software updates. As such, functions described in this manual may pertain specifically to cards loaded with a particular software build. **If you received your 9084 and this manual at the same time, this manual reflects all facets of your card.**

This manual (9084-OM (V4.0)) was specifically written for
Software Version: 4.0 / 2740

If your 9084 was purchased **earlier** than receiving this manual, you can check the Software Release Number/Software Build Number of your 9084 and see if it matches the Software Version covered by this manual.

If necessary, the Software Release Number/Software Build Number of your 9084 can be checked by viewing this information as displayed on the **Info** submenu on the card-edge display, or by checking the **Card Info** menu in DashBoard™. See Checking 9084 Card Information (p. 3-12) in Chapter 3, “Operating Instructions” for more information.

Proceed as follows if your card’s software does not match this manual:

<p>Card Software earlier than version in manual</p>	<p>Card is not loaded with the latest software. Not all functions described in this manual may be available.</p> <p>If desired, contact Cobalt Digital Inc. to receive the latest Update software for your card. Software is typically sent by e-mail.</p> <p>You can update your card by uploading the new Update software by going to the Support>Downloads link at www.cobaltdigital.com. Then, go to the listing for your card and download “COMPASS™ Firmware Update Guide”.</p>
<p>Card Software newer than version in manual</p>	<p>A new manual is expediently released whenever a card’s software is updated and specifications and/or functionality have changed as compared to an earlier version (a new manual is not necessarily released if specifications and/or functionality have not changed). A manual earlier than a card’s software version may not completely or accurately describe all functions available for your card.</p> <p>If your card shows features not described in this manual, you can check for the latest manual (if applicable) and download it by going to the Support>Downloads link at www.cobaltdigital.com.</p>

Manual Conventions

In this manual, display messages and connectors are shown using the exact name shown on the 9084 itself. Examples are provided below.

- Card-edge display messages are shown like this:

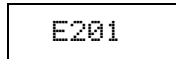

E201

- Connector names are shown like this: **SDI IN**

In this manual, the terms below are applicable as follows:

- **9084** refers to the 9084 HD/SD-SDI RGB Color Corrector with YCbCr Video Proc and Frame Sync card.
- **Frame** refers to the 8310 (or similar) frame that houses the Cobalt® COMPASS™ cards.
- **Device** and/or **Card** refers to a COMPASS™ card.
- **System** and/or **Video System** refers to the mix of interconnected production and terminal equipment in which the 9084 and COMPASS™ cards operate.

Warnings, Cautions, and Notes

Certain items in this manual are highlighted by special messages. The definitions are provided below.

Warnings

Warning messages indicate a possible hazard which, if not avoided, could result in personal injury or death.



Cautions

Caution messages indicate a problem or incorrect practice which, if not avoided, could result in improper operation or damage to the product.

Notes

Notes provide supplemental information to the accompanying text. Notes typically precede the text to which they apply.

Labeling Symbol Definitions

	Attention, consult accompanying documents.
	<p>Electronic device or assembly is susceptible to damage from an ESD event. Handle only using appropriate ESD prevention practices.</p> <p>If ESD wrist strap is not available, handle card only by edges and avoid contact with any connectors or components.</p>
	<p>Symbol (WEEE 2002/96/EC)</p> <p>For product disposal, ensure the following:</p> <ul style="list-style-type: none"> • Do not dispose of this product as unsorted municipal waste. • Collect this product separately. • Use collection and return systems available to you.

Safety Summary

Warnings

! WARNING !

To reduce risk of electric shock do not remove line voltage service barrier cover on frame equipment containing an AC power supply. **NO USER SERVICEABLE PARTS INSIDE. REFER SERVICING TO QUALIFIED SERVICE PERSONNEL.**

Cautions

CAUTION

This device is intended for environmentally controlled use only in appropriate video terminal equipment operating environments.

CAUTION

This product is intended to be a component product of an openGear™ frame. Refer to the openGear™ frame Owner's Manual for important safety instructions regarding the proper installation and safe operation of the frame as well as its component products.

CAUTION

Heat and power distribution requirements within a frame may dictate specific slot placement of cards. Cards with many heat-producing components should be arranged to avoid areas of excess heat build-up, particularly in frames using only convection cooling. The 9084 has a moderate power dissipation (15 W max.). As such, avoiding placing the card adjacent to other cards with similar dissipation values if possible.

CAUTION

If required, make certain Rear I/O Module(s) are installed before installing the 9084 into the frame slot. Damage to card and/or Rear I/O Module can occur if module installation is attempted with card already installed in slot.

CAUTION

If card resists fully engaging in rear I/O module mating connector, check for alignment and proper insertion in slot tracks. Damage to card and/or rear I/O module may occur if improper card insertion is attempted.

9084 Functional Description

Figure 1-1 shows a functional block diagram of the 9084. The 9084 provides HD/SD-SDI RGB color correction with frame synchronization that supports all popular SD and HD video formats including 525i, 625i, 720p, 720f, 1080i, 1080p, and 1080psF. Input video format is auto-detected by the card. The 9084 accepts either an HD SDI input (1.485 Gbit) or an SD SDI input (270 Mbit) and automatically equalizes for cable loss. The 9084 also provides processing-bypassed reclocked SDI outputs.

Processed video is synchronized to either a frame-wide reference or a local reference. For further flexibility in resolving system timing problems, additional fixed delay can be added to the video. Ancillary Data (VANC) is protected, and is passed from input to output ensuring data is not lost during the frame sync operation.

9084 Input/Outputs

The 9084 provides the following video inputs and outputs:

- **Inputs:**
 - **HD/SD-SDI IN** – dual-rate HD/SD-SDI input
- **Outputs:**
 - **HD/SD-SDI OUT** – four dual-rate HD/SD-SDI buffered video outputs
 - **RCK OUT** – four dual-rate HD/SD-SDI reclocked buffered video outputs

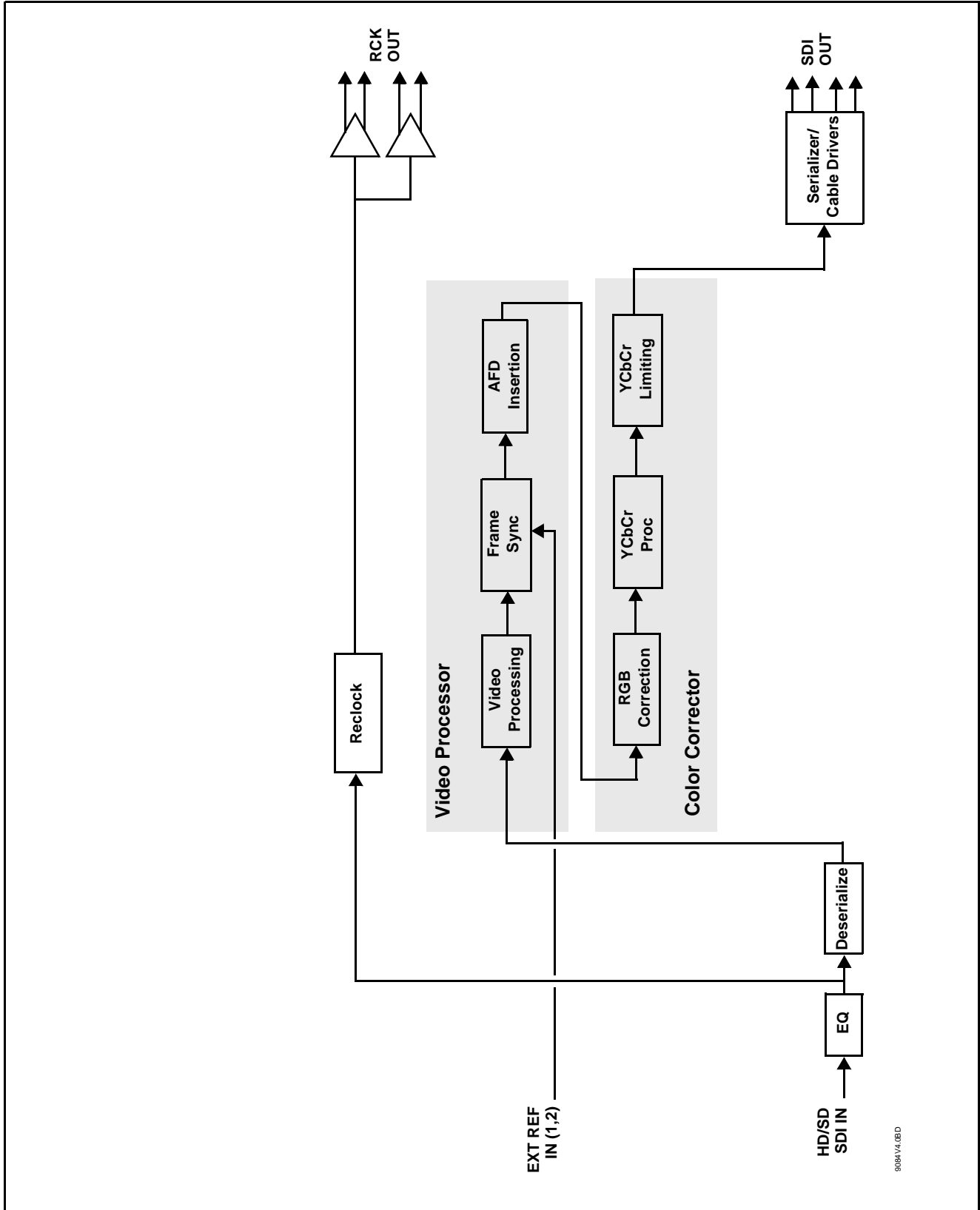

Figure 1-1 9084 Functional Block Diagram

Color Corrector

The 9084 color corrector converts the YCbCr SDI input video to the 4:4:4 RGB color space (where the color correction is applied), and then back to YCbCr SDI on the output. Controls are available to adjust each RGB level independently for both white levels (gain) and black levels (offset). Gamma can also be independently adjusted for each RGB channels. Various controls can be ganged to provide adjustment for all three color channels simultaneously.

Video Processor

The 9084 provides full video processing control (luma gain and lift, chroma gain, and color phase) of the output video. The 9084 video processor also provides white, black, and chroma clip control. Clipping can be applied with either a hard or soft white clip and also a chroma saturation clip. Luma and chroma gain controls can be ganged to provide adjustment for both gain controls.

Frame Sync Function

This function provides for frame sync control using either one of two external **EXT REF IN (1,2)** reference signals distributed with the card frame, or the input video as a frame sync reference.

This function allows horizontal and/or vertical offset to be added between the output video and the frame sync reference.

A Reset Framesync function resets the frame sync following any horizontal or vertical offset changes, clearing any buffered video and re-establishing the frame sync.

In the event of input video loss of signal, this function provides for disabling the video, going to a desired color raster, or freezing to the last intact frame (frame having valid SAV and EAV codes).

AFD Inserter

This function provides for assignment and insertion of AFD codes into the SDI output video. Using this function, AFD codes in accordance with the standard 4-bit AFD code designations can be applied to the output video.

This function checks for any existing AFD code within the received video input. If a code is present, the code is displayed. When used in conjunction with a separate downstream card capable of providing AFD-directed scaling, the image can in turn be scaled in accordance with the AFD coding embedded by this card.

The function also allows the selection/changing of the AFD code and ancillary data line number for the outputted AFD code.

User Control Interface

Figure 1-2 shows the user control interface options for the 9084. These options are individually described below.

Note: All user control interfaces described here are cross-compatible and can operate together as desired. Where applicable, any control setting change made using a particular user interface is reflected on any other connected interface.

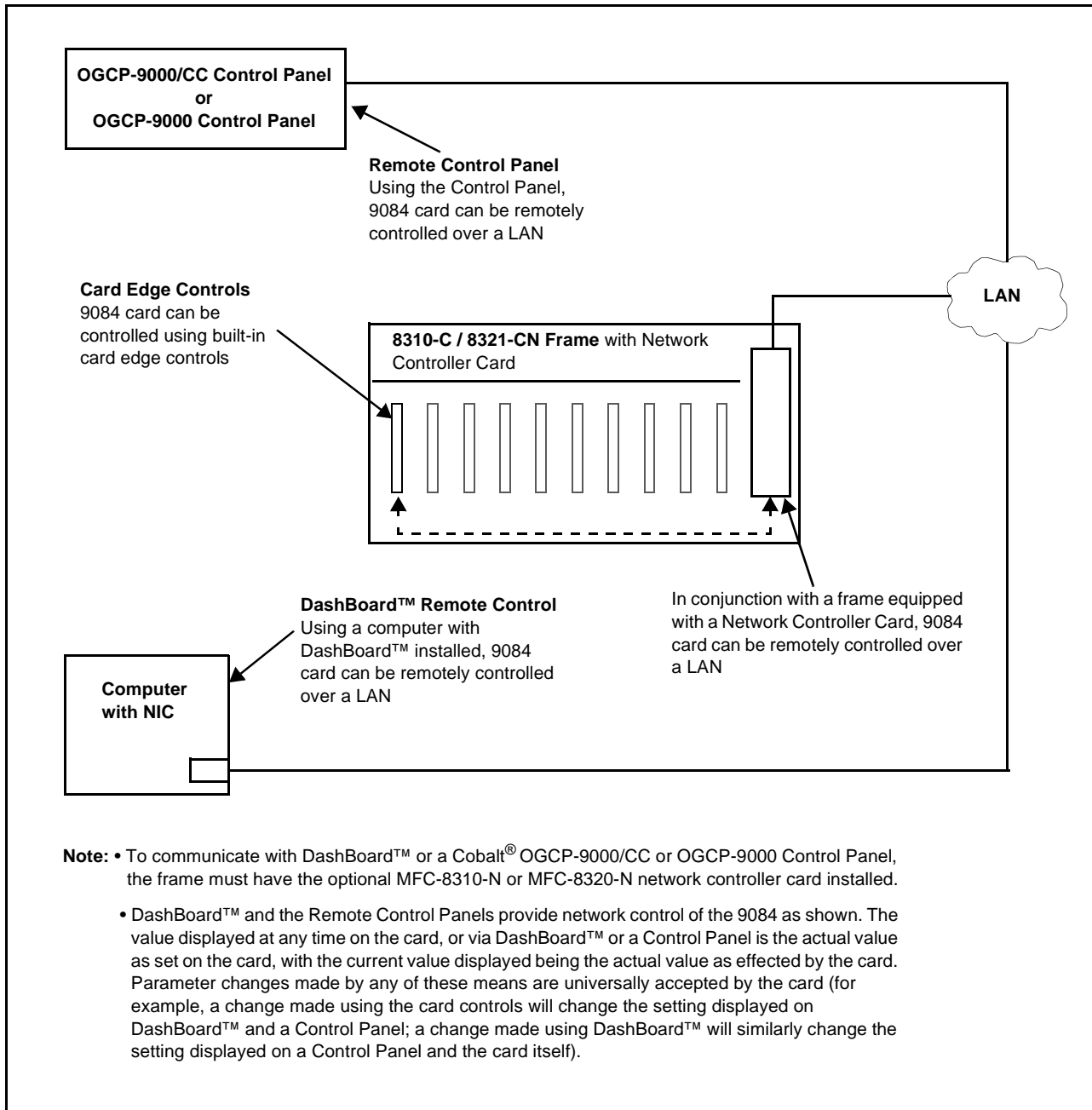

Figure 1-2 9084 User Control Interface

- **Built-in Card Edge User Interface** – Using the built-in card edge controls and display, card control settings can be set using a front panel menu which is described in Chapter 3, “Operating Instructions”.

Note: Some of the 9084 functions described in this manual are available only when using the DashBoard™, or Cobalt® OGCP-9000 or OGCP-9000/CC Control Panels user interfaces.

- **DashBoard™ User Interface** – Using DashBoard™, the 9084 and other cards installed in openGear™ frames such as the Cobalt® 8310-C Frame can be controlled from a computer and monitor.

DashBoard™ allows users to view all frames on a network with control and monitoring for all populated slots inside a frame. This simplifies the setup and use of numerous modules in a large installation and offers the ability to centralize monitoring. Cards define their controllable parameters to DashBoard™, so the control interface is always up to date.

The DashBoard™ software can be downloaded from the Cobalt Digital Inc. website: www.cobaltdigital.com (enter “DashBoard” in the search window). The DashBoard™ user interface is described in Chapter 3, “Operating Instructions”.

Note: If network remote control is to be used for the frame and the frame has not yet been set up for remote control, Cobalt® reference guide **COMPASS™ Remote Control User Guide” (PN 9000RCS-RM)** provides thorough information and step-by-step instructions for setting up network remote control of COMPASS™ cards using DashBoard™.

Download a copy of this guide by clicking on the **Support>Downloads** link at www.cobaltdigital.com and then select DashBoard Remote Control Setup Guide as a download, or contact Cobalt® as listed in Contact Cobalt Digital Inc. (p. 1-15).

- **Cobalt® OGCP-9000/CC and OGCP-9000 Remote Control Panels** – The OGCP-9000/CC and OGCP-9000 Remote Control Panels conveniently and intuitively provide parameter monitor and control of the 9084 and other video and audio processing terminal equipment meeting the open-architecture Cobalt COMPASS™ cards for openGear™ standard.

In addition to circumventing the need for a computer to monitor and control signal processing cards, the Control Panels allow quick and intuitive access to hundreds of cards in a facility, and can monitor and allow adjustment of multiple parameters at one time.

The Remote Control Panels are totally compatible with the openGear™ control software DashBoard™; any changes made with either system are reflected on the other. The Remote Control Panel user interface is described in Chapter 3, “Operating Instructions”.

Note: Although the OGCP-9000 Remote Control Panel can be used with the 9084, the OGCP-9000/CC Remote Control Panel is specifically designed for use with 9084 cards and provides the most intuitive and simplest interface of all the methods described.

9084 Rear I/O Modules

The 9084 physically interfaces to system video connections at the rear of its frame using a Rear I/O Module.

All inputs and outputs shown in the 9084 Functional Block Diagram (Figure 1-1) enter and exit the card via the card edge backplane connector. The Rear I/O Module breaks out the 9084 card edge connections to BNC connectors that interface with other components and systems in the signal chain.

These required BNC connections are provided by either an 8310-BNC or 8310-C-BNC frame (which both have a built-in BNC connector backplane module), or by using an optional RM-9084-A Rear I/O Module.

Video Formats Supported by the 9084

The 9084 supports all current SMPTE standard SD and HD video formats. Table 1-1 lists the video formats supported by the 9084.

Table 1-1 Supported Video Formats

Raster Structure	Frame Rate
1080psF	23.98; 24
1080p	23.98; 24
1080i ⁽¹⁾	25; 29.97; 30
720p	23.98; 24; 25; 29.97; 30; 50; 59.94; 60
486i ⁽¹⁾	29.97
575i ⁽¹⁾	25
(1) All rates displayed as frame rates; interlaced ("i") field rates are two times the rate value shown.	

Technical Specifications

Table 1-2 lists the technical specifications for the 9084 HD/SD-SDI RGB Color Corrector with YCbCr Video Proc and Frame Sync card.

Table 1-2 Technical Specifications

Item	Characteristic
Part number, nomenclature	9084 HD/SD-SDI RGB Color Corrector with YCbCr Video Proc and Frame Sync
Installation/usage environment	Intended for installation and usage in frame meeting openGear™ modular system definition.
Power consumption	< 15 Watts maximum
Environmental: Operating temperature: Relative humidity (operating or storage):	32° – 104° F (0° – 40° C) < 95%, non-condensing
Frame communication	10/100 Mbps Ethernet with Auto-MDIX.
Indicators	Card edge display and indicators as follows: <ul style="list-style-type: none"> • 4-character alphanumeric display • Status/Error LED indicator • Input Format LED indicator
Controls	Card edge switches as follows: <ul style="list-style-type: none"> • Menu Enter pushbutton switch • Menu Exit pushbutton switch • Up/down selection toggle switch
Serial Digital Video Input	Data Rates Supported: SMPTE 292 HD-SDI: 1.485 Gbps or 1.485/1.001 Gbps SMPTE 259M-C SD-SDI: 270 Mbps HD Frame Rates Supported: 720p 23.98; 24; 25; 29.97; 30; 50; 59.94 1080i 25; 29.97 1080p 23.98; 24; 25; 29.97; 30 1080p/sF 23.98; 24

Table 1-2 Technical Specifications — continued

Item	Characteristic
Serial Digital Video Input (cont.)	SD Frame Rates Supported: 486i 29.97 (NTSC) 575i 25 (PAL) Impedance: 75 Ω terminating Equalization (HD): 328 ft (100 m) Belden 1694A Equalization (SD): 1000 ft (305 m) Belden 1694A Return Loss: > 15 dB at 5 MHz – 1.485 GHz
Post-Processor Serial Digital Video Outputs	Number of Outputs: Four HD/SD-SDI BNC per IEC 60169-8 Amendment 2 Impedance: 75 Ω Return Loss: > 15 dB at 5 MHz – 270 MHz > 12 dB at 270 MHz – 1.485 GHz Signal Level: 800 mV \pm 10% DC Offset: 0 V \pm 50 mV Jitter (HD): < 0.15 UI (all outputs) Jitter (SD): < 0.10 UI (all outputs) Overshoot: < 0.2% of amplitude
Pre-Processor (Reclocked) Serial Digital Video Outputs	Number of Outputs: Four HD/SD-SDI BNC per IEC 60169-8 Amendment 2 Impedance: 75 Ω

Table 1-2 Technical Specifications — continued

Item	Characteristic
Pre-Processor (Reclocked) Serial Digital Video Outputs (cont.)	Return Loss: > 15 dB at 5 MHz – 270 MHz > 12 dB at 270 MHz – 1.485 GHz Signal Level: 800 mV ± 10% DC Offset: 0 V ± 50 mV Jitter (HD): < 0.15 UI (all outputs) Jitter (SD): < 0.10 UI (all outputs) Overshoot: < 0.2% of amplitude
Reference Video Input	Number of Inputs: Two Non-Terminating (looping) Frame Reference Inputs Standards Supported (HD): 720p 24; 25; 29.97; 30; 50; 59.94 1080i 25; 29.97 1080p 23.98; 24; 25; 29.97; 30 1080psF 23.98; 24 Standards Supported (SD): 486i 29.97 (NTSC) 575i 25 (PAL) Signal Level: 1 Vp-p nominal Signal Type: Analog video sync (black burst or tri-level) Impedance: 75 Ω Return Loss: > 30 dB to 30 MHz Allowable Maximum DC on Ref Input: ±1.0 V

Warranty and Service Information

Cobalt Digital Inc. Limited Warranty

This product is warranted to be free from defects in material and workmanship for a period of five (5) years from the date of shipment to the original purchaser, except that 4000, 5000, 6000, 8000 series power supplies, and Dolby® modules (where applicable) are warranted to be free from defects in material and workmanship for a period of one (1) year.

Cobalt Digital Inc.'s ("Cobalt") sole obligation under this warranty shall be limited to, at its option, (i) the repair or (ii) replacement of the product, and the determination of whether a defect is covered under this limited warranty shall be made at the sole discretion of Cobalt.

This limited warranty applies only to the original end-purchaser of the product, and is not assignable or transferrable therefrom. This warranty is limited to defects in material and workmanship, and shall not apply to acts of God, accidents, or negligence on behalf of the purchaser, and shall be voided upon the misuse, abuse, alteration, or modification of the product. Only Cobalt authorized factory representatives are authorized to make repairs to the product, and any unauthorized attempt to repair this product shall immediately void the warranty. Please contact Cobalt Technical Support for more information.

To facilitate the resolution of warranty related issues, Cobalt recommends registering the product by completing and returning a product registration form. In the event of a warrantable defect, the purchaser shall notify Cobalt with a description of the problem, and Cobalt shall provide the purchaser with a Return Material Authorization ("RMA"). For return, defective products should be double boxed, and sufficiently protected, in the original packaging, or equivalent, and shipped to the Cobalt Factory Service Center, postage prepaid and insured for the purchase price. The purchaser should include the RMA number, description of the problem encountered, date purchased, name of dealer purchased from, and serial number with the shipment.

Cobalt Digital Inc. Factory Service Center

2406 E. University Avenue
Urbana, IL 61802 USA
www.cobaltdigital.com

Office: (217) 344-1243
Fax: (217) 344-1245
Email: info@cobaltdigital.com

THIS LIMITED WARRANTY IS EXPRESSLY IN LIEU OF ALL OTHER WARRANTIES EXPRESSED OR IMPLIED, INCLUDING THE WARRANTIES OF MERCHANTABILITY AND FITNESS FOR A PARTICULAR PURPOSE AND OF ALL OTHER OBLIGATIONS OR LIABILITIES ON COBALT'S PART. ANY SOFTWARE PROVIDED WITH, OR FOR USE WITH, THE PRODUCT IS PROVIDED "AS IS." THE BUYER OF THE PRODUCT ACKNOWLEDGES THAT NO OTHER REPRESENTATIONS WERE MADE OR RELIED UPON WITH RESPECT TO THE QUALITY AND FUNCTION OF THE GOODS HEREIN SOLD. COBALT PRODUCTS ARE NOT AUTHORIZED FOR USE IN LIFE SUPPORT APPLICATIONS.

COBALT'S LIABILITY, WHETHER IN CONTRACT, TORT, WARRANTY, OR OTHERWISE, IS LIMITED TO THE REPAIR OR REPLACEMENT, AT ITS OPTION, OF ANY DEFECTIVE PRODUCT, AND SHALL IN NO EVENT INCLUDE SPECIAL, INDIRECT, INCIDENTAL, OR CONSEQUENTIAL DAMAGES (INCLUDING LOST PROFITS), EVEN IF IT HAS BEEN ADVISED OF THE POSSIBILITY OF SUCH DAMAGES.

Contact Cobalt Digital Inc.

Feel free to contact our friendly and professional support representatives for any of the following:

- Name and address of your local dealer
- Product information and pricing
- Technical support
- Upcoming trade show information

Phone:	(217) 344-1243
Fax:	(217) 344-1245
Web:	www.cobaltdigital.com
General Information:	info@cobaltdigital.com
Technical Support:	support@cobaltdigital.com

This page intentionally blank

Installation and Setup

Overview

This chapter contains the following information:

- Installing the 9084 Into a Frame Slot (p. 2-1)
- Installing a Rear I/O Module (p. 2-3)
- Setting Up 9084 Network Remote Control (p. 2-4)

Installing the 9084 Into a Frame Slot

CAUTION

Heat and power distribution requirements within a frame may dictate specific slot placement of cards. Cards with many heat-producing components should be arranged to avoid areas of excess heat build-up, particularly in frames using only convection cooling. The 9084 has a moderate power dissipation (15 W max.). As such, avoiding placing the card adjacent to other cards with similar dissipation values if possible.

CAUTION



This device contains semiconductor devices which are susceptible to serious damage from Electrostatic Discharge (ESD). ESD damage may not be immediately apparent and can affect the long-term reliability of the device.

Avoid handling circuit boards in high static environments such as carpeted areas, and when wearing synthetic fiber clothing. Always use proper ESD handling precautions and equipment when working on circuit boards and related equipment.

- Note:**
- **If installing the 9084 in an 8310-C-BNC or 8310-BNC frame** (which is pre-equipped with a 100-BNC rear I/O module installed across the entire backplane) or a slot already equipped with a suitable I/O module, proceed to card installation steps below.
 - **If installing the 9084 in a slot with no rear I/O module, an optional RM-9084-A Rear I/O Module is required** before cabling can be connected. Install the Rear I/O Module as described in Installing a Rear I/O Module (p. 2-3).

CAUTION

If required, make certain Rear I/O Module(s) are installed before installing the 9084 into the frame slot. Damage to card and/or Rear I/O Module can occur if module installation is attempted with card already installed in slot.

- Note:** Check the packaging in which the 9084 was shipped for any extra items such as a Rear I/O Module connection label. In some cases, this label is shipped with the card and to be installed on the Rear I/O connector bank corresponding to the slot location of the card.

Install the 9084 into a frame slot as follows:

1. Determine the slot in which the 9084 is to be installed.
2. Open the frame front access panel.
3. While holding the card by the card edges, align the card such that the plastic ejector tab is on the bottom.
4. Align the card with the top and bottom guides of the slot in which the card is being installed.
5. Gradually slide the card into the slot. When resistance is noticed, gently continue pushing the card until its rear printed circuit edge terminals engage fully into the rear I/O module mating connector.

CAUTION

If card resists fully engaging in rear I/O module mating connector, check for alignment and proper insertion in slot tracks. Damage to card and/or rear I/O module may occur if improper card insertion is attempted.

6. Verify that the card is fully engaged in rear I/O module mating connector.
7. Close the frame front access panel.
8. Connect the input and output cables as shown in Figure 2-1.
9. Repeat steps 1 through 8 for other 9084 cards.

- Note:** The 9084 BNC inputs are internally 75-ohm terminated. It is not necessary to terminate unused BNC inputs or outputs.

Note: To remove a card, press down on the ejector tab to unseat the card from the rear I/O module mating connector. Evenly draw the card from its slot.

10. If network remote control is to be used for the frame and the frame has not yet been set up for remote control, perform setup in accordance with Setting Up 9084 Network Remote Control (p. 2-4).

Note: If installing a card in a frame already equipped for, and connected to DashBoard™, no network setup is required for the card. The card will be discovered by DashBoard™ and be ready for use.

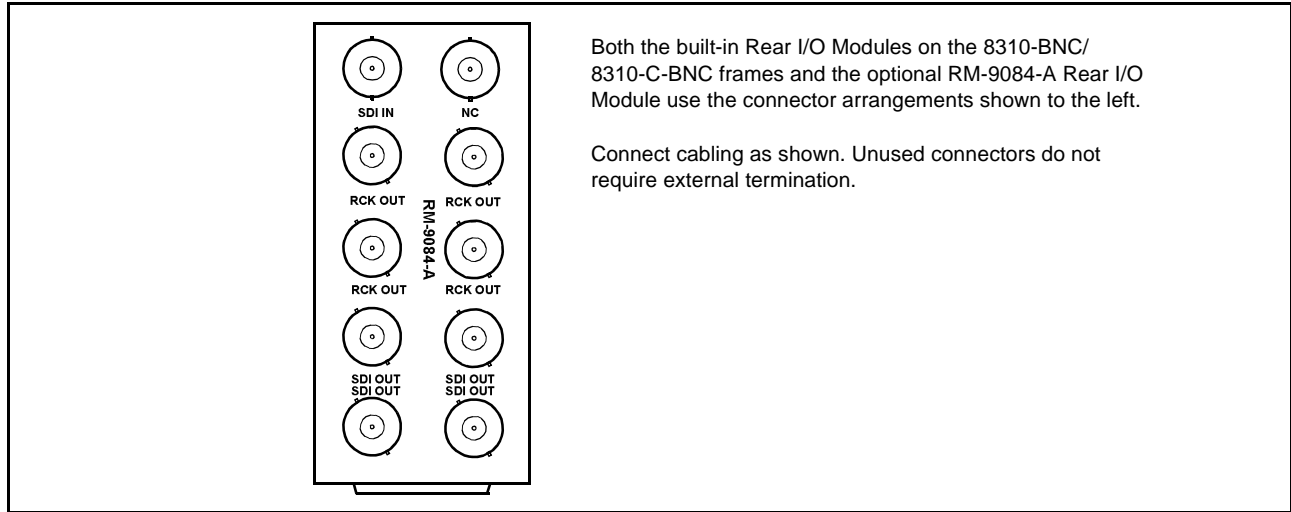

Figure 2-1 9084 Rear I/O Module Connections

Installing a Rear I/O Module

Note: This procedure is applicable **only if a Rear I/O Module is not currently installed** in the slot where the 9084 is to be installed.

If installing the 9084 in a 8310-C-BNC or 8310-BNC frame (which is pre-equipped with a 100-BNC rear I/O module installed across the entire backplane) or a slot already equipped with a suitable I/O module, omit this procedure and go to Installing the 9084 Into a Frame Slot (p. 2-1).

Install a Rear I/O Module as follows:

1. On the 8310 frame, determine the slot in which the 9084 is to be installed.
2. In the mounting area corresponding to the slot location, install Rear I/O Module as shown in Figure 2-2.

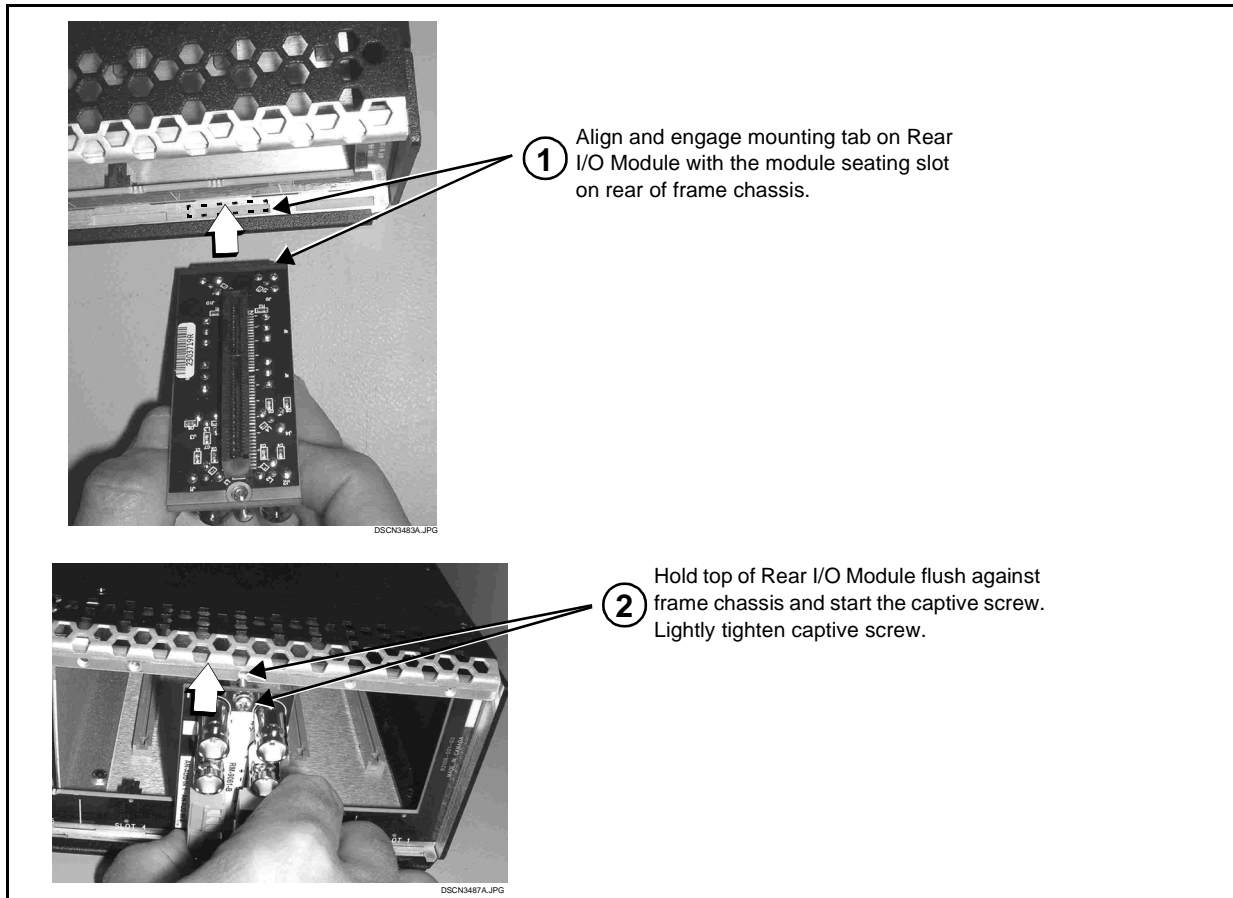

Figure 2-2 Rear I/O Module Installation

Setting Up 9084 Network Remote Control

Perform remote control setup in accordance with Cobalt® reference guide “COMPASS™ Remote Control User Guide” (PN 9000RCS-RM).

- Note:**
- If network remote control is to be used for the frame and the frame has not yet been set up for remote control, Cobalt® reference guide **COMPASS™ Remote Control User Guide (PN 9000RCS-RM)** provides thorough information and step-by-step instructions for setting up network remote control of COMPASS™ cards using DashBoard™. (Cobalt® OGCP-9000 and OGCP-9000/CC Remote Control Panel product manuals have complete instructions for setting up remote control using a Remote Control Panel.)

Download a copy of this guide by clicking on the **Support>Downloads** link at www.cobaltdigital.com and then select DashBoard Remote Control Setup Guide as a download, or contact Cobalt® as listed in Contact Cobalt Digital Inc. (p. 1-15).

- If installing a card in a frame already equipped for, and connected to DashBoard™, no network setup is required for the card. The card will be discovered by DashBoard™ and be ready for use.

Operating Instructions

Overview

This chapter contains the following information:

- Control and Display Descriptions (p. 3-1)
- Accessing the 9084 Card via Remote Control (p. 3-10)
- Checking 9084 Card Information (p. 3-12)
- Ancillary Data Line Number Locations and Ranges (p. 3-13)
- 9084 Function Submenu List and Descriptions (p. 3-14)
- Color and Video Correction Examples Using the 9084 (p. 3-27)
- Troubleshooting (p. 3-34)

Control and Display Descriptions

This section describes the user interface controls, indicators, and displays (both on-card and remote controls) for using the 9084 card. The 9084 functions can be accessed and controlled using any of the user interfaces described here.

The format in which the 9084 functional controls, indicators, and displays appear and are used varies depending on the user interface being used. Regardless of the user interface being used, access to the 9084 functions (and the controls, indicators, and displays related to a particular function) follows a general arrangement of Function Submenus under which related parameters can be accessed (as described in Function Submenu/Parameter Submenu Overview below).

After familiarizing yourself with the arrangement described in Function Submenu/Parameter Submenu Overview, proceed to the subsection for the particular user interface being used. Descriptions and general instructions for using each of the three user interfaces are individually described in the following subsections:

- 9084 Card Edge Controls, Indicators, and Display (p. 3-3)
- DashBoard™ User Interface (p. 3-7)
- Cobalt® Remote Control Panel User Interfaces (p. 3-9)

Note: Instructions provided here are applicable for all available user control methods. However, DashBoard™ and the Remote Control Panel provide greatly simplified user interfaces as compared to using the 9084 card edge controls. For this reason, **it is strongly recommended** that DashBoard™ or a Remote Control Panel be used for all 9084 applications other than the most basic cases.

Note: Not all functions available using DashBoard™ or the Control Panel are available using the card edge controls.

Note: When a setting is changed, settings displayed on DashBoard™ (or the Remote Control Panel) are the settings as effected by the 9084 card itself and reported back to the remote control; the value displayed at any time is the actual value as set on the card.

Function Submenu/Parameter Submenu Overview

The functions and related parameters available on the 9084 card are organized into function **submenus**, which consist of parameter groups as shown below.

Figure 3-1 shows how the 9084 card and its submenus are organized, and also provides an overview of how navigation is performed between cards, function submenus, and parameters.

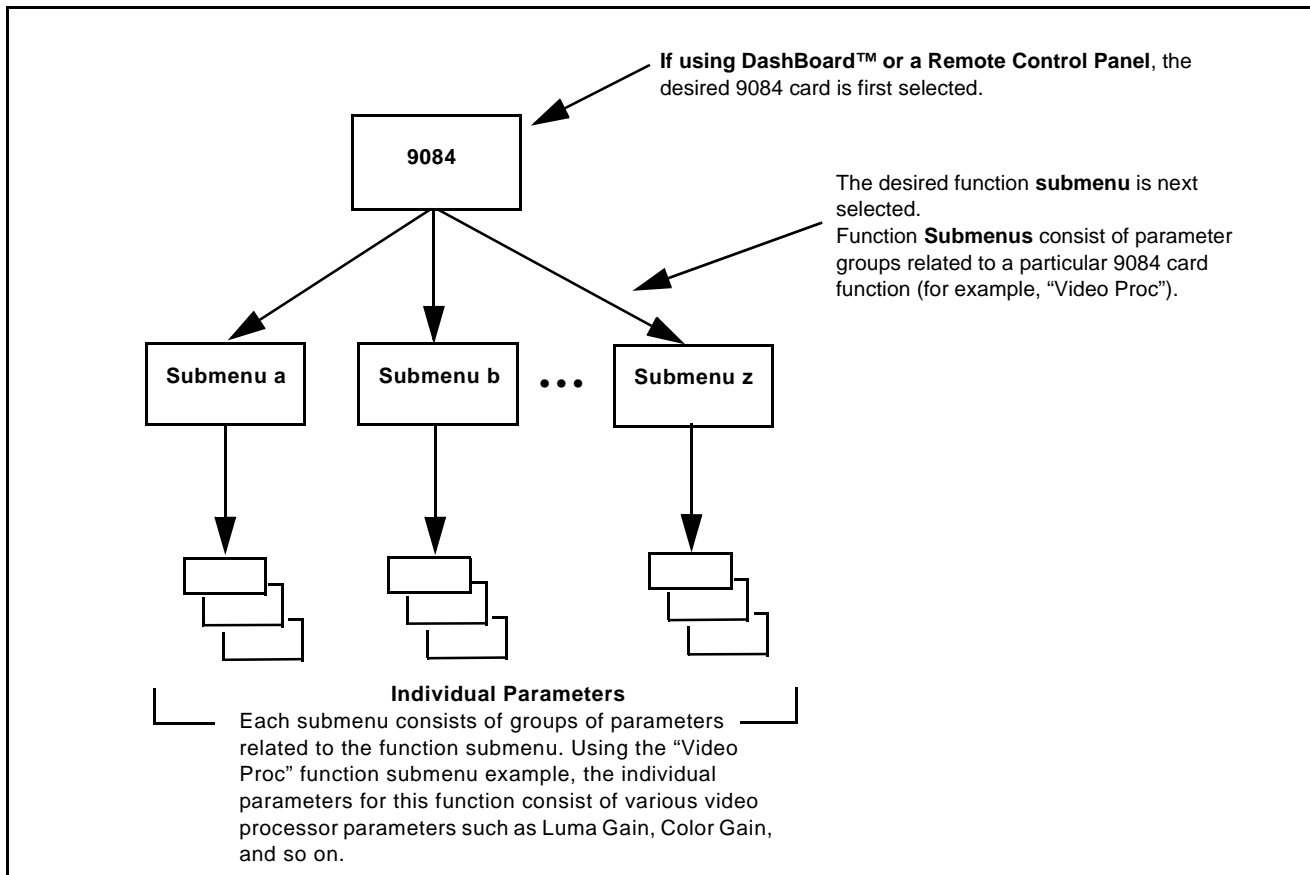

Figure 3-1 Function Submenu/Parameter Submenu Overview

9084 Card Edge Controls, Indicators, and Display

Figure 3-2 shows and describes the 9084 card edge controls, indicators, and display.

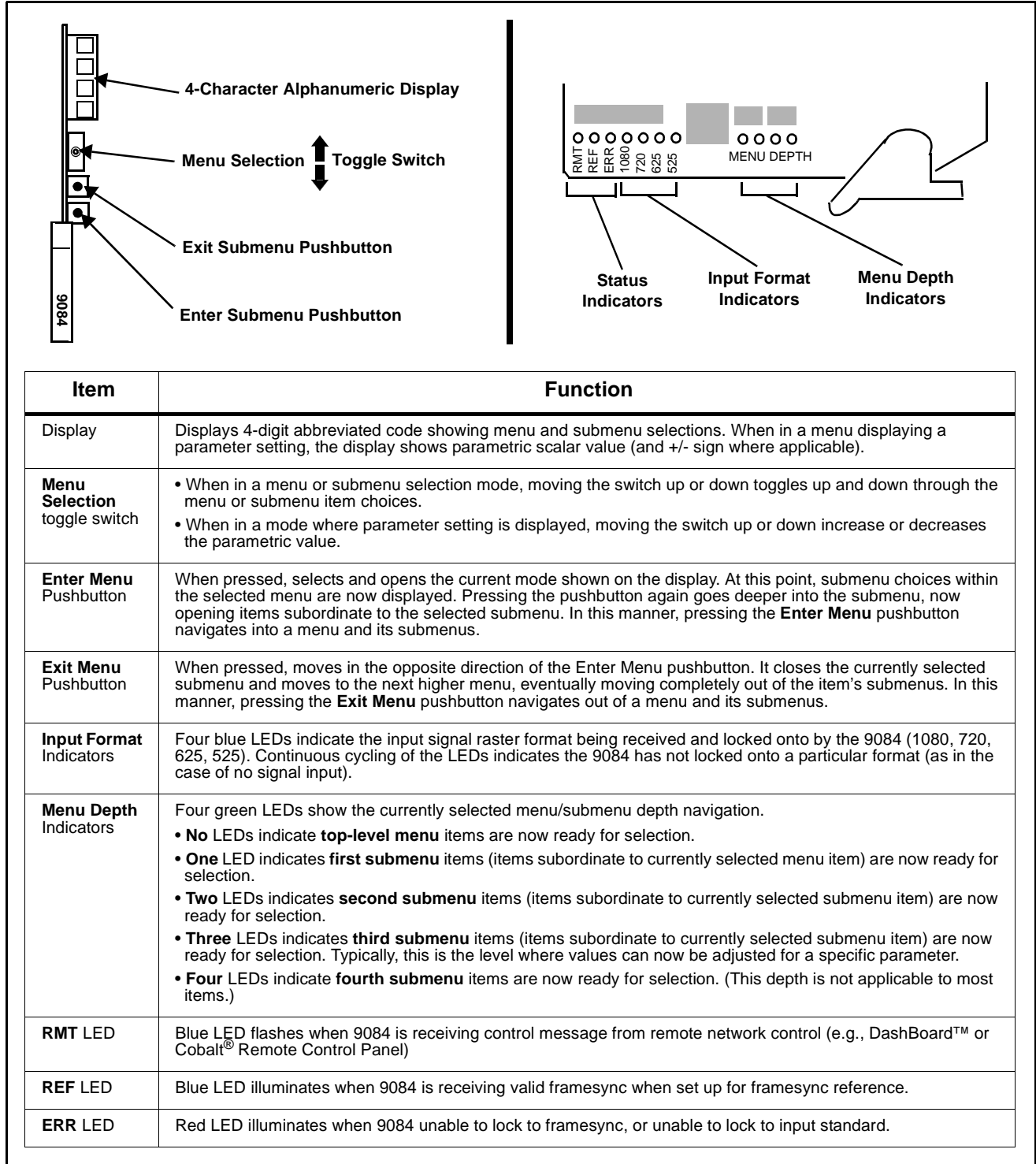

Figure 3-2 9084 Controls, Indicators, and Display

9084 Card Edge Control Menu/Submenu Structure

(See below.) Using the menu system of group menus and submenus described earlier, the 9084 parameters/controls are organized into menus and submenus. As appropriate, a submenu similarly may have its own further additional subordinate submenus.

Menu Group Item	Menu Depth	Menu depth (as indicated by 9084 Menu Depth LEDs)
		none
Submenu 1 (Submenu 1 selection items)	1	● ○ ○ ○
Submenu 2 (Submenu 2 selection items)	2	● ● ○ ○
Submenu 3 (Submenu 3 selection items and/or parameter values)	3	● ● ● ○
Submenu 4 (Submenu 4 selection items and/or parameter values)	4	● ● ● ●

Figure 3-3 shows an example of using the card edge controls to access the Color Correction menu (along with some of its submenus) to adjust color channel gain and 0-levels. (A) through (I) in Figure 3-3 denote the discrete tasks required in performing the example setup using the 9084 card edge controls.

In this example, the following adjustment is being performed:

- White Adjust Blue (Blue channel gain) is changed from default unity to 94.0.
- Black Adjust Red (Red channel 0-level) is changed from default unity to -10.0.

Due to the limited control available when using the card edge control user interface, the navigation into and out of submenus shown in Figure 3-3 is required to perform the adjustments described above.

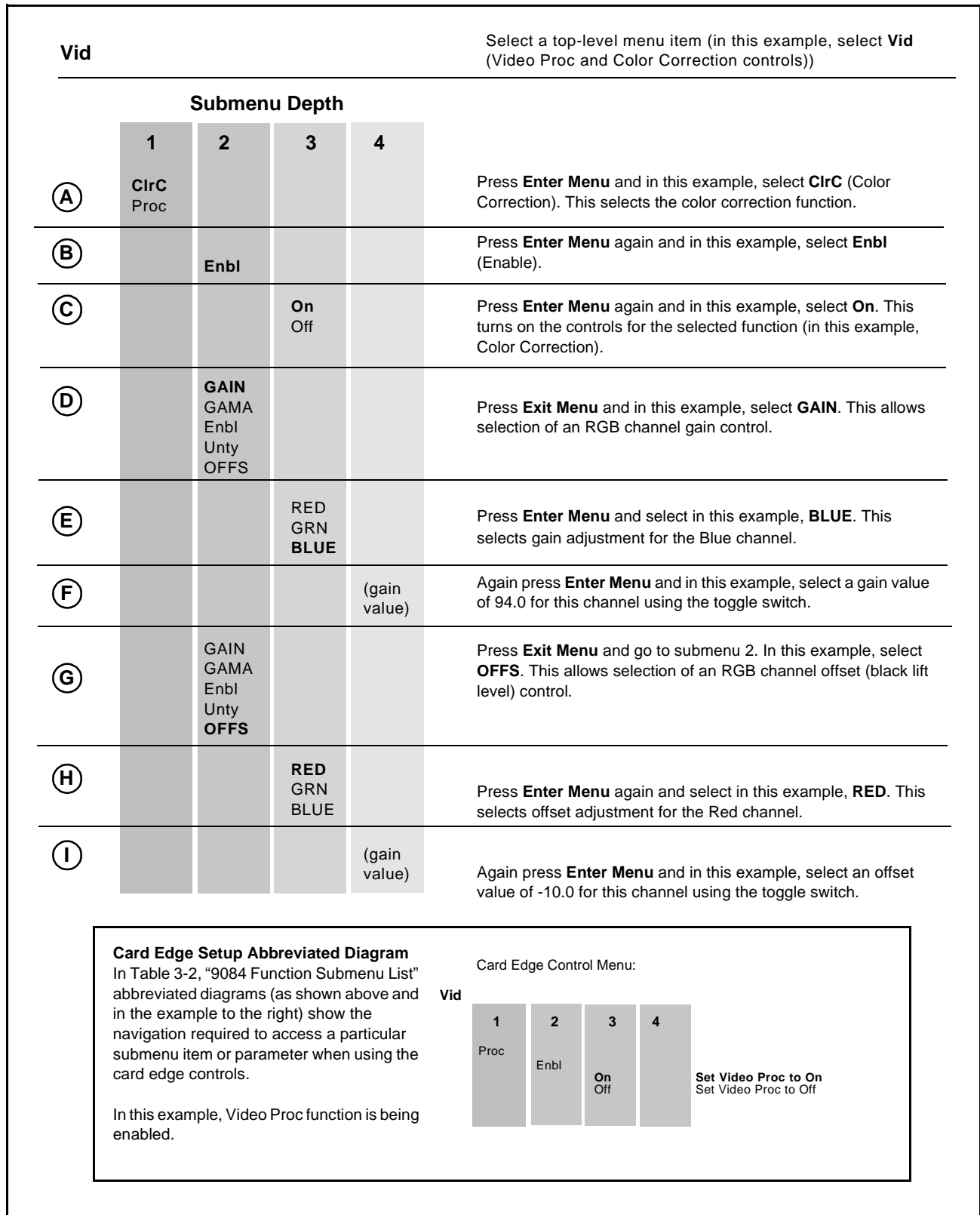

Figure 3-3 Card Edge Controls Setup of Example Color Correction Function

Card Edge Display Orientation, Brightness, and Timeout Adjust

The card edge 4-Character Alphanumeric Display can be changed between vertical or horizontal character orientation to suit the mounting position of the card as shown and described below.

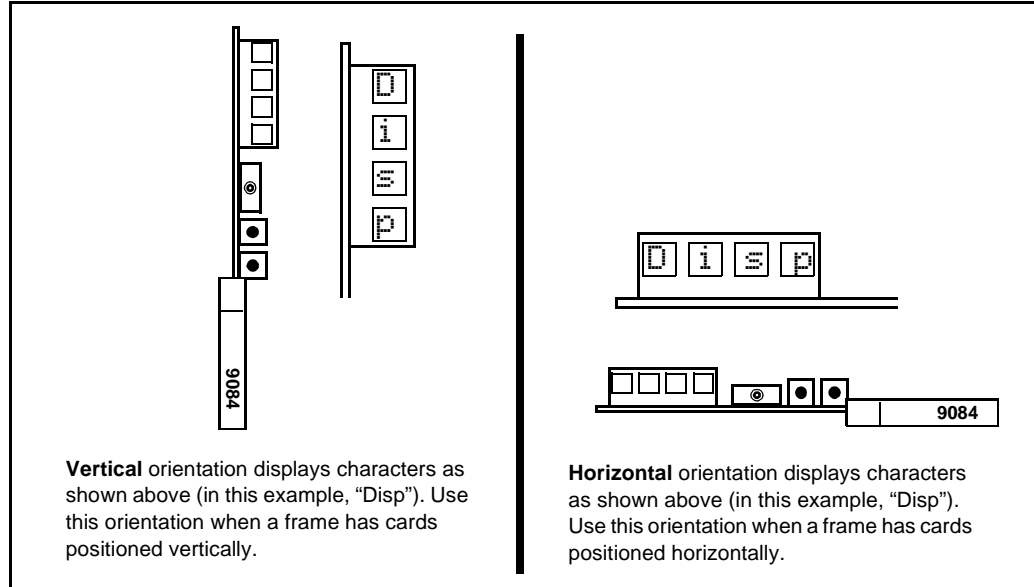
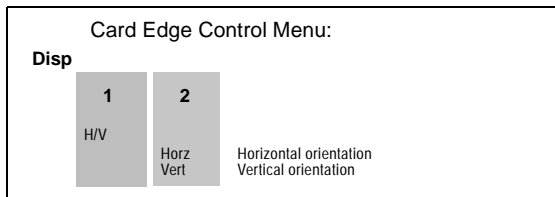

Figure 3-4 Card Edge Display Orientation

1. Access the **Displ** (Display) menu.
2. Select between Horizontal or Vertical as shown below.



Adjust the display brightness as described below.

1. Access the **Displ** (Display) menu.
2. Select from the relative brightness levels as shown below.

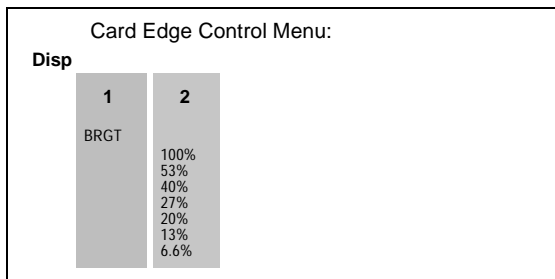

The timeout period from when a menu is entered to when the display times out (reverts to the default card model display) can be adjusted from 5 to 9999 seconds (166.7 minutes) as described below.

1. Access the **Displ** (Display) menu.
2. Use the up/down switch to enter the desired timeout value as shown below.

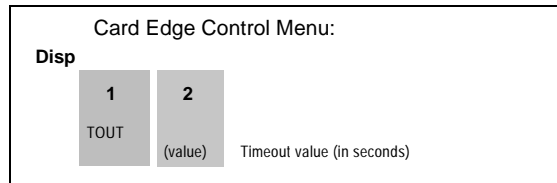

DashBoard™ User Interface

(See Figure 3-5.) The 9084 function submenus are organized in DashBoard™ using tabs (for example, “Color Correction” in Figure 3-5). When a tab is selected, each parametric control or selection list item associated with the function is displayed. Scalar (numeric) parametric values can then be adjusted as desired using the GUI slider controls. Items in a list can then be selected using GUI drop-down lists. (In this manner, the setting effected using controls and selection lists displayed in DashBoard™ are comparable to the submenu items accessed and committed using the 9084 card edge controls.)

Figure 3-5 shows the same setup described in Figure 3-3 as performed using DashBoard™. Note how this setup is greatly simplified using DashBoard™ with most of the discrete tasks ((A) through (I) in Figure 3-3) performed with the card edge controls now rolled into simple actions using DashBoard™.

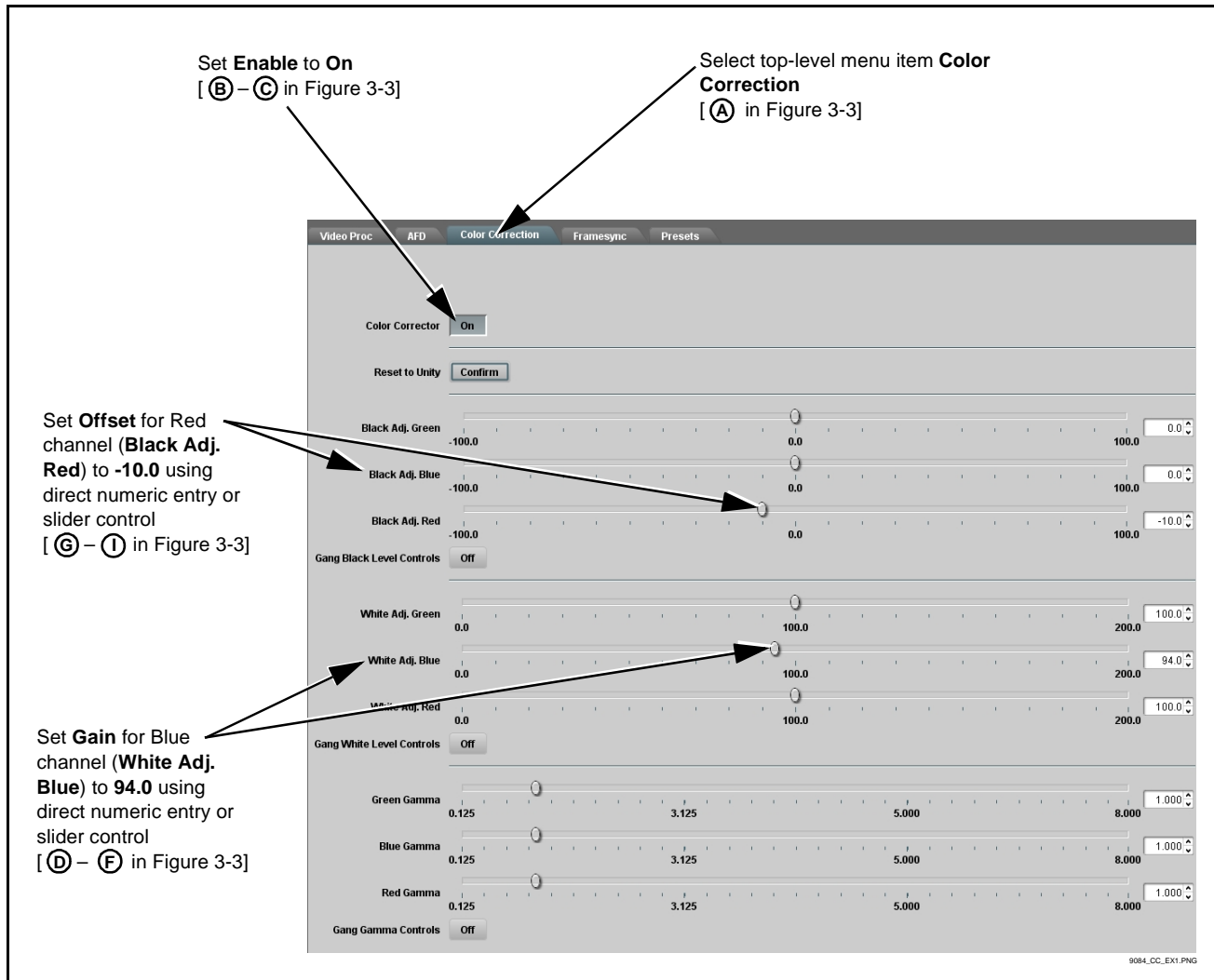

Figure 3-5 DashBoard™ Setup of Example Color Correction Function

Cobalt® Remote Control Panel User Interfaces

(See Figure 3-6.) Similar to the function submenu tabs using DashBoard™, the Remote Control Panels have a Select Submenu key that is used to display a list of function submenus. From this list, a control knob on the Control Panel is used to select a function from the list of displayed function submenu items.

When the desired function submenu is selected, each parametric control or selection list item associated with the function is displayed. Scalar (numeric) parametric values can then be adjusted as desired using the control knobs, which act as potentiometers. Items in a list can then be selected using the control knobs which correspondingly act as rotary switches. (In this manner, the setting effected using controls and selection lists displayed on the Control Panel are comparable to the submenu items accessed and committed using the 9084 card edge controls.)

Figure 3-6 shows accessing a function submenu and its parameters (in this example, “Color Corrector”) using the Control Panel as compared to using the card edge controls.

Note: Refer to “OGCP-9000 Remote Control Panel Product Manual” (PN OGCP-9000-OM) or “OGCP-9000/CC Remote Control Panel Product Manual” (PN OGCP-9000/CC-OM) for complete instructions on using the Control Panels.

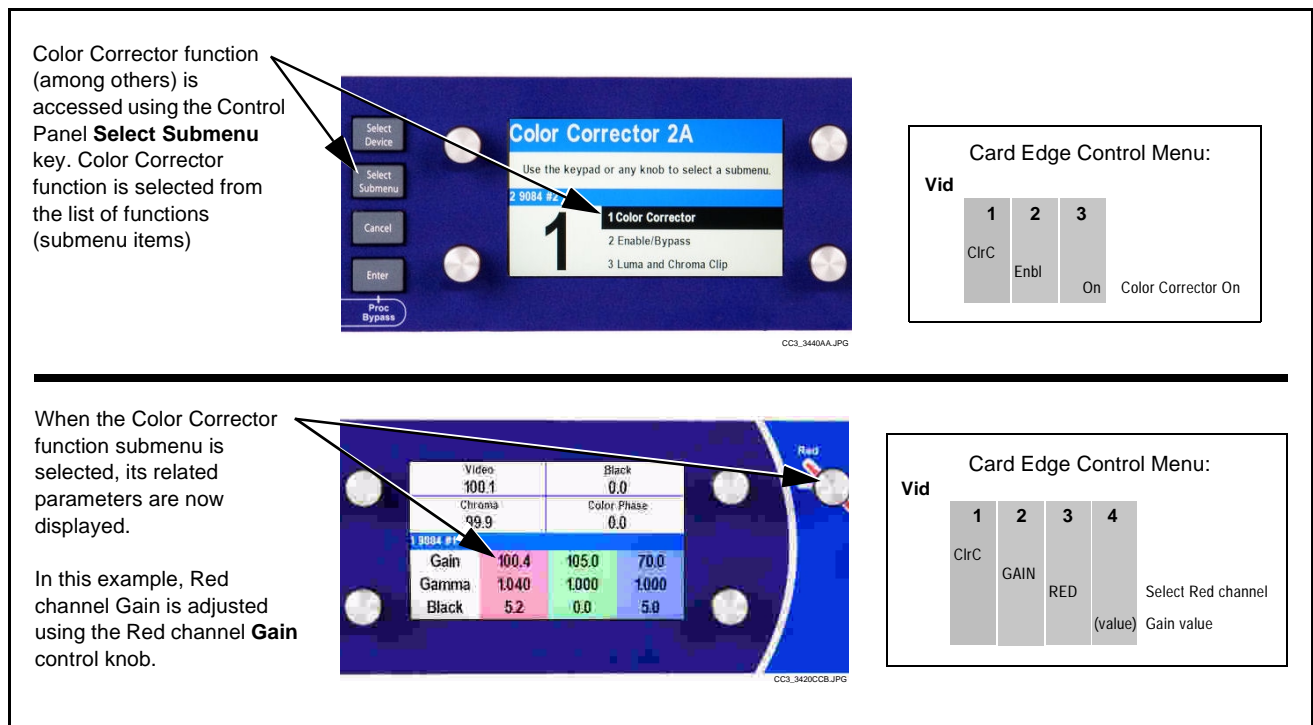

Figure 3-6 Control Panel Setup of Example Video Proc Function

Accessing the 9084 Card via Remote Control

Access the 9084 card using DashBoard™ or Cobalt® Remote Control Panel as described below.

Accessing the 9084 Card Using DashBoard™

1. On the computer connected to the frame LAN, open DashBoard™.
2. As shown below, in the left side Basic View Tree locate the Network Controller Card associated with the frame containing the 9084 card to be accessed (in this example, “MFC-8310-N SN: 00108053”).

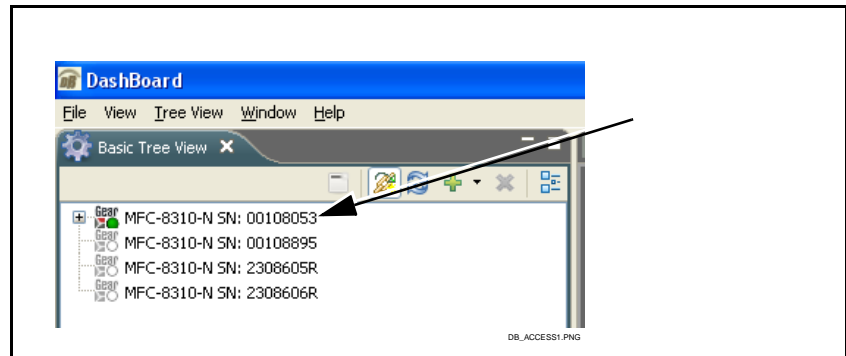

3. As shown below, expand the tree to access the cards within the frame. Click on the card to be accessed (in this example, “Slot 7: CDI-9084 Color Corrector 1A”).

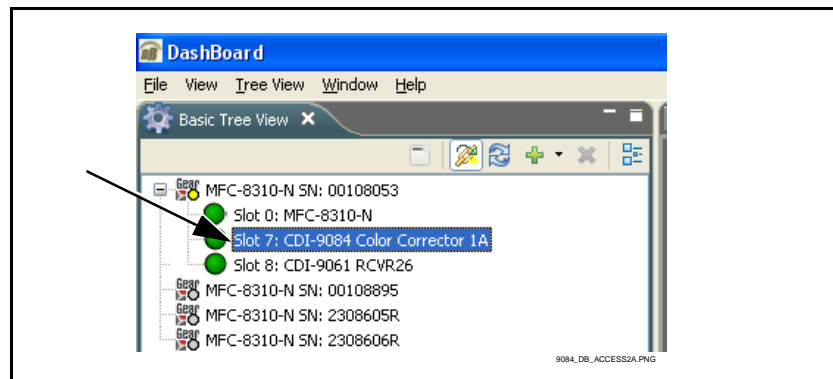

As shown on the next page, when the card is accessed a DashBoard™ function submenu screen is displayed. (The particular submenu screen displayed is the previously displayed screen from the last time the card was accessed by DashBoard™).

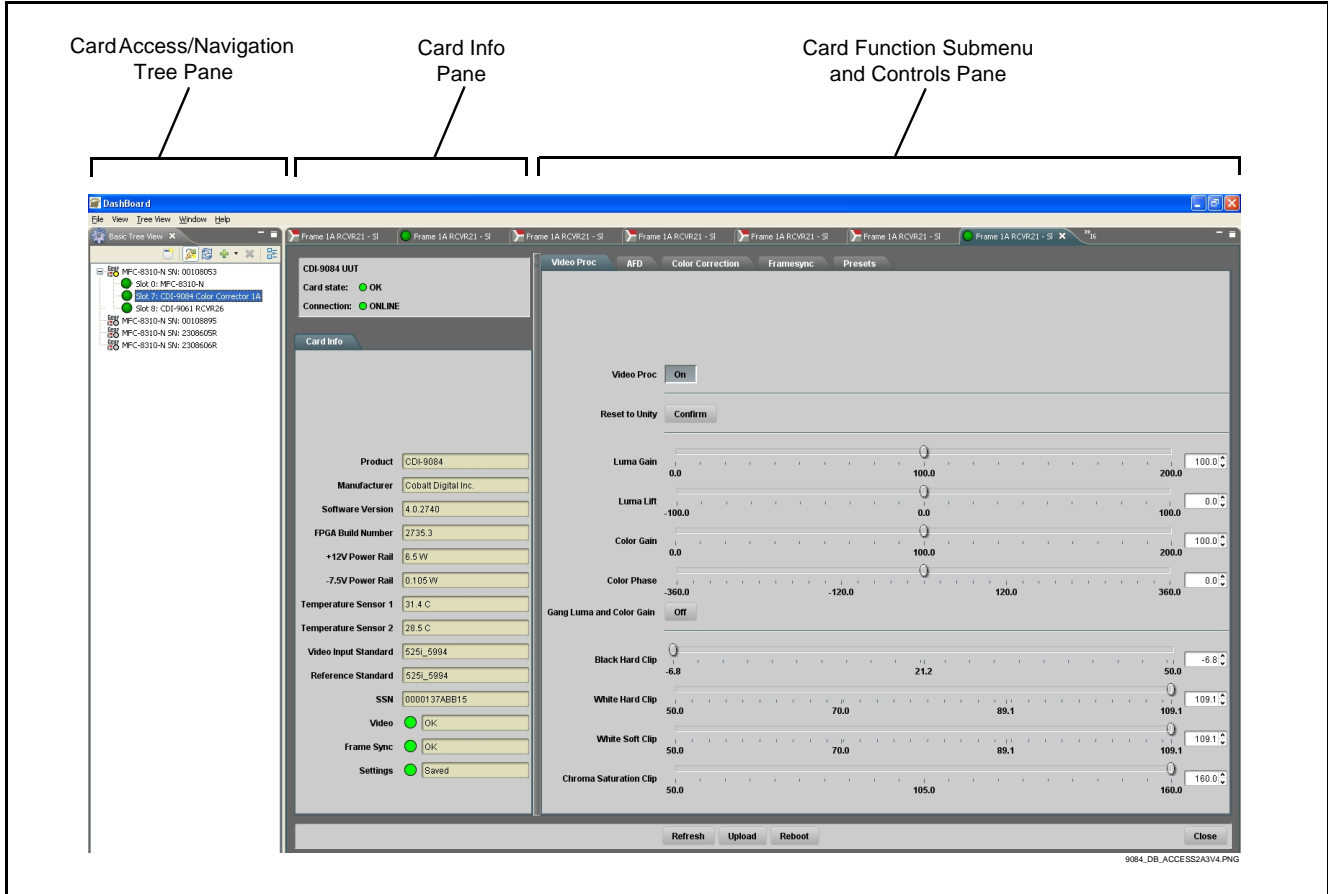

Accessing the 9084 Card Using a Cobalt® Remote Control Panel

Press the **Select Device** key and select a card as shown in the example below.

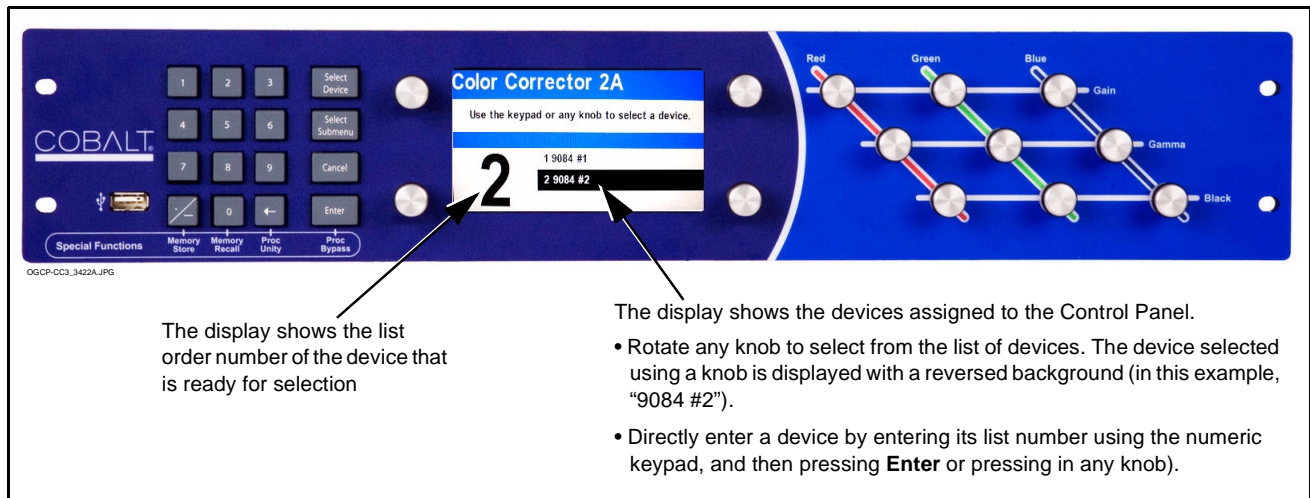

Checking 9084 Card Information

The operating status and software version the 9084 card can be checked using the card edge control user interface or DashBoard™. Figure 3-7 shows and describes the 9084 card information screen using DashBoard™ and accessing card information using the card edge control user interface.

Note: Proper operating status in DashBoard™ is denoted by green icons for the status indicators shown in Figure 3-7. Yellow or red icons respectively indicate an alert or failure condition. Refer to Troubleshooting (p. 3-34) for corrective action.

The **Tree View** shows the cards seen by DashBoard™. In this example, Network Controller Card MFC-8310-N (serial number ...8055) is hosting a 9084 card in slot 7.

Software Version Number
Refer to these numbers to check that documentation (such as this manual) matches the card's Software Release Number and Software Build Number. Use these numbers also when communicating to Cobalt® regarding this card.

Power Consumption and Temperature Displays
This display shows the power consumed by the 9084 for both the +12V and -7.5V rails, as well as key device temperatures.

Status Displays
These displays show the status the signal being received by the 9084. Green Settings icon shows that any changes made on DashBoard™ are successfully saved on the card's memory.

Checking Card Using Card Edge Controls

Info	1	2
+POW	(value)	+12V Watts consumed
-POW	(value)	- 7.5V Watts consumed
SWR#	(value)	Software Release Number
SWB#	(value)	Software Build Number

Figure 3-7 9084 Card Info Utility

Ancillary Data Line Number Locations and Ranges

Table 3-1 lists the default output video VANC line number locations for various ancillary data items processed or passed by the card.

Table 3-1 9084 Ancillary Data Line Number Locations/Ranges

Item	Default Line No. / Range	
	SD	HD
AFD	12 (Note 2)	9 (Note 2)
ATC_VITC	12 (locked)	9/8 (Note 2)
ATC_LTC	—	10 (Note 2)
SDI VITC Waveform	14/16 (Note 2)	—
Closed Captioning	21 (locked)	10 (Note 2)

Notes:

- The card does not check for conflicts on a given line number. Make certain the selected line is available and carrying no other data.
- While range indicated by drop-down list on GUI may allow a particular range of choices, the actual range is automatically clamped (limited) to certain ranges to prevent inadvertent conflict with active picture area depending on video format. Limiting ranges for various output formats are as follows:

Format	Line No. Limiting	Format	Line No. Limiting	Format	Line No. Limiting
525i	12-19	720p	9-25	1080p	9-41
625i	9-22	1080i	9-20		

Because line number allocation is not standardized for all ancillary items, consideration should be given to all items when performing set-ups. Figure 3-8 shows an example of improper and corrected VANC allocation within a 525i5994 SD-SDI stream.

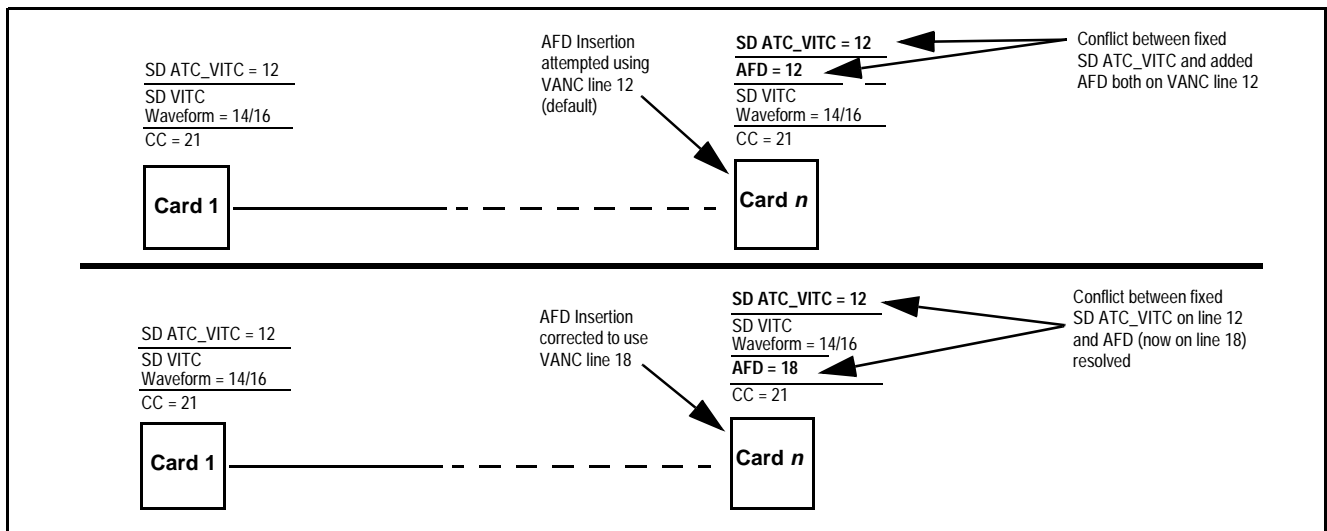



Figure 3-8 Example VANC Line Number Allocation Example

9084 Function Submenu List and Descriptions

Table 3-2 individually lists and describes each 9084 function submenu “tab” and its related list selections, controls, and parameters. Where helpful, examples showing usage of a function are also provided. Table 3-2 is primarily based upon using DashBoard™ to access each function and its corresponding submenus and parameters.

Note: All numeric (scalar) parameters displayed on DashBoard™ can be changed using the slider controls,  arrows, or by numeric keypad entry in the corresponding numeric field. (When using numeric keypad entry, add a return after the entry to commit the entry.)

Note: Table 3-2 also provides abbreviated menu structure charts showing the menu structure for accessing the function/parameter using the card edge controls. Where this is not shown for a particular control, this indicates the control is **not** available using card edge controls.

If using card edge controls, refer to 9084 Card Edge Control Menu/Submenu Structure (p. 3-4) and Figure 3-3 for an explanation and an example of card edge control menu structure navigation.

On DashBoard™ itself and in Table 3-2, the function submenu items are organized using tabs as shown below.



The table below provides a quick-reference to the page numbers where each function submenu item can be found.

Function Submenu Item	Page	Function Submenu Item	Page
Video Proc	3-15	Framesync	3-22
AFD	3-18	Presets	3-25
Color Correction	3-19		

Table 3-2 9084 Function Submenu List





	<p>Provides the following Video Proc parametric controls.</p>						
<p>• Video Proc</p>  <div style="border: 1px solid black; padding: 5px; margin-top: 10px;"> <p>Card Edge Control Menu:</p> <p>Vid</p> <table border="1" style="width: 100%; text-align: center;"> <tr> <td style="width: 33%;">1</td> <td style="width: 33%;">2</td> <td style="width: 33%;">3</td> </tr> <tr> <td>Proc</td> <td>Enbl</td> <td>On Off</td> </tr> </table> <p>Video Proc On Video Proc Off</p> </div>	1	2	3	Proc	Enbl	On Off	<p>Video Proc (On/Off) provides master on/off control of all Video Proc functions.</p> <ul style="list-style-type: none"> • When set to Off, Video Proc is bypassed. • When set to On, currently displayed parameter settings take effect.
1	2	3					
Proc	Enbl	On Off					
<p>• Reset to Unity</p>  <div style="border: 1px solid black; padding: 5px; margin-top: 10px;"> <p>Card Edge Control Menu:</p> <p>Vid</p> <table border="1" style="width: 100%; text-align: center;"> <tr> <td style="width: 33%;">1</td> <td style="width: 33%;">2</td> <td style="width: 33%;">3</td> </tr> <tr> <td>Proc</td> <td>Unty</td> <td>Y?</td> </tr> </table> <p>Move toggle switch in either direction to confirm unity reset. Reject reset by pressing Exit Menu pushbutton.</p> </div>	1	2	3	Proc	Unty	Y?	<p>Reset to Unity provides unity reset control of all Video Proc functions. When Confirm is clicked, a Confirm? pop-up appears, requesting confirmation.</p> <ul style="list-style-type: none"> • Click Yes to proceed with the unity reset. • Click No to reject unity reset.
1	2	3					
Proc	Unty	Y?					
<p>• Luma Gain</p>  <div style="border: 1px solid black; padding: 5px; margin-top: 10px;"> <p>Card Edge Control Menu:</p> <p>Vid</p> <table border="1" style="width: 100%; text-align: center;"> <tr> <td style="width: 33%;">1</td> <td style="width: 33%;">2</td> <td style="width: 33%;">3</td> </tr> <tr> <td>Proc</td> <td>Gain</td> <td>(gain value)</td> </tr> </table> <p>Luma gain in percent</p> </div>	1	2	3	Proc	Gain	(gain value)	<p>Adjusts gain percentage applied to Luma (Y channel). (0% to 200% range in 0.1% steps; unity = 100%)</p>
1	2	3					
Proc	Gain	(gain value)					
<p>• Luma Lift</p>  <div style="border: 1px solid black; padding: 5px; margin-top: 10px;"> <p>Card Edge Control Menu:</p> <p>Vid</p> <table border="1" style="width: 100%; text-align: center;"> <tr> <td style="width: 33%;">1</td> <td style="width: 33%;">2</td> <td style="width: 33%;">3</td> </tr> <tr> <td>Proc</td> <td>Lift</td> <td>(lift value)</td> </tr> </table> <p>Luma lift in percent</p> </div>	1	2	3	Proc	Lift	(lift value)	<p>Adjusts lift applied to Luma (Y-channel). (-100% to 100% range in 0.1% steps; null = 0.0%)</p>
1	2	3					
Proc	Lift	(lift value)					

Table 3-2 9084 Function Submenu List — continued



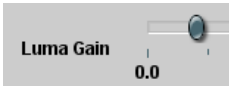

	(continued)															
<p>• Color Gain</p>  <p>Color Gain 0.0</p> <p>Card Edge Control Menu:</p> <table border="1" data-bbox="250 510 644 695"> <tr> <td colspan="4">Vid</td> </tr> <tr> <td>1</td> <td>2</td> <td>3</td> <td></td> </tr> <tr> <td>Proc</td> <td>Sat</td> <td>(sat value)</td> <td>Color gain in percent</td> </tr> </table>	Vid				1	2	3		Proc	Sat	(sat value)	Color gain in percent	<p>Adjusts gain percentage (saturation) applied to Chroma (C-channel).</p> <p>(0% to 200% range in 0.1% steps; unity = 100%)</p>			
Vid																
1	2	3														
Proc	Sat	(sat value)	Color gain in percent													
<p>• Color Phase</p>  <p>Color Phase -360.0</p> <p>Card Edge Control Menu:</p> <table border="1" data-bbox="250 877 644 1087"> <tr> <td colspan="4">Vid</td> </tr> <tr> <td>1</td> <td>2</td> <td>3</td> <td></td> </tr> <tr> <td>Proc</td> <td>Phas</td> <td>(phase value)</td> <td>Color phase angle applied in degrees</td> </tr> </table>	Vid				1	2	3		Proc	Phas	(phase value)	Color phase angle applied in degrees	<p>Adjusts phase angle applied to Chroma.</p> <p>(-360° to 360° range in 0.1° steps; null = 0°)</p>			
Vid																
1	2	3														
Proc	Phas	(phase value)	Color phase angle applied in degrees													
<p>• Gang Luma and Color Gain</p>  <p>Gang Luma and Color Gain On</p> <p>Card Edge Control Menu:</p> <table border="1" data-bbox="250 1257 591 1446"> <tr> <td colspan="4">Vid</td> </tr> <tr> <td>1</td> <td>2</td> <td>3</td> <td></td> </tr> <tr> <td>Proc</td> <td>Gang</td> <td>On Off</td> <td>Ganging On Ganging Off</td> </tr> </table>	Vid				1	2	3		Proc	Gang	On Off	Ganging On Ganging Off	<p>When set to On, changing either the Luma Gain or Color Gain controls increases or decreases both the luma and chroma levels by equal amounts.</p>			
Vid																
1	2	3														
Proc	Gang	On Off	Ganging On Ganging Off													
<p>• Black Hard Clip</p>  <p>Black Hard Clip -6.8</p> <p>Card Edge Control Menu:</p> <table border="1" data-bbox="250 1644 636 1850"> <tr> <td colspan="5">Vid</td> </tr> <tr> <td>1</td> <td>2</td> <td>3</td> <td>4</td> <td></td> </tr> <tr> <td>Proc</td> <td>Clip</td> <td>BHCL</td> <td>(value)</td> <td>Clip value in percent; 0.1% precision</td> </tr> </table>	Vid					1	2	3	4		Proc	Clip	BHCL	(value)	Clip value in percent; 0.1% precision	<p>Applies black hard clip (limiting) at specified percentage.</p> <p>(-6.8% to 50.0%; null = -6.8%)</p>
Vid																
1	2	3	4													
Proc	Clip	BHCL	(value)	Clip value in percent; 0.1% precision												

Table 3-2 9084 Function Submenu List — continued

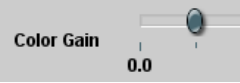

	(continued)								
<p>• White Hard Clip</p>  <p>White Hard Clip 50.0</p> <div data-bbox="272 522 662 730" style="border: 1px solid black; padding: 5px;"> <p>Card Edge Control Menu:</p> <p>Vid</p> <table border="1" style="width: 100%; text-align: center;"> <tr> <td>1</td> <td>2</td> <td>3</td> <td>4</td> </tr> <tr> <td>Proc</td> <td>Clip</td> <td>WHCL</td> <td>(value)</td> </tr> </table> <p>Clip value in percent; 0.1% precision</p> </div>	1	2	3	4	Proc	Clip	WHCL	(value)	<p>Applies white hard clip (limiting) at specified percentage. (50.0% to 109.1%; null = 109.1%)</p>
1	2	3	4						
Proc	Clip	WHCL	(value)						
<p>• White Soft Clip</p>  <p>White Soft Clip 50.0</p> <div data-bbox="272 945 662 1157" style="border: 1px solid black; padding: 5px;"> <p>Card Edge Control Menu:</p> <p>Vid</p> <table border="1" style="width: 100%; text-align: center;"> <tr> <td>1</td> <td>2</td> <td>3</td> <td>4</td> </tr> <tr> <td>Proc</td> <td>Clip</td> <td>WSCL</td> <td>(value)</td> </tr> </table> <p>Clip value in percent; 0.1% precision</p> </div>	1	2	3	4	Proc	Clip	WSCL	(value)	<p>Applies white soft clip (limiting) at specified percentage. (50.0% to 109.1%; null = 109.1%)</p>
1	2	3	4						
Proc	Clip	WSCL	(value)						
<p>• Chroma Saturation Clip</p>  <p>Chroma Saturation Clip 50.0</p> <div data-bbox="277 1371 667 1583" style="border: 1px solid black; padding: 5px;"> <p>Card Edge Control Menu:</p> <p>Vid</p> <table border="1" style="width: 100%; text-align: center;"> <tr> <td>1</td> <td>2</td> <td>3</td> <td>4</td> </tr> <tr> <td>Proc</td> <td>Clip</td> <td>CSAT</td> <td>(value)</td> </tr> </table> <p>Clip value in percent; 0.1% precision</p> </div>	1	2	3	4	Proc	Clip	CSAT	(value)	<p>Applies chroma saturation clip (limiting) chroma saturation at specified percentage. (50.0% to 160.0%; null = 160.0%)</p>
1	2	3	4						
Proc	Clip	CSAT	(value)						

Table 3-2 9084 Function Submenu List — continued

	<p>Allows assignment of AFD (Active Format Description) codes to the SDI output video.</p>																																																																
<p>Note: This function only marks the SDI output with an AFD code. Actual AFD processing must be performed by a downstream card or system that recognizes an AFD code assigned here.</p>																																																																	
<p>• Incoming AFD</p> 	<p>Displays incoming AFD setting as follows:</p> <ul style="list-style-type: none"> • If AFD code is present, one of the 11, four-bit AFD codes is displayed (as shown in the example to the left). Also displayed is the VANC line number of the incoming AFD code. • If no AFD setting is present in the video signal, No AFD Present is displayed. 																																																																
<p>• Output Mode</p> 	<p>Drop-down selection determines action to take in presence or absence of existing AFD code on input video.</p>																																																																
<p>• Output Code</p> 	<p>Drop-down list assigns desired AFD to output SDI.</p> <table border="1" data-bbox="740 905 1386 1192"> <thead> <tr> <th colspan="4">4:3 Coded Frame</th> </tr> <tr> <th>AFD Code⁽¹⁾</th> <th>Description</th> <th>AFD Code⁽¹⁾</th> <th>Description</th> </tr> </thead> <tbody> <tr> <td>–</td> <td>No code present</td> <td>1001</td> <td>Full frame</td> </tr> <tr> <td>0000</td> <td>Undefined</td> <td>1010</td> <td>16:9 (center)</td> </tr> <tr> <td>0010</td> <td>Box 16:9 (top)</td> <td>1011</td> <td>14:9 (center)</td> </tr> <tr> <td>0011</td> <td>Box 14:9 (top)</td> <td>1101</td> <td>4:3 (with alternate 14:9 center)</td> </tr> <tr> <td>0100</td> <td>Box > 16:9 (center)</td> <td>1110</td> <td>16:9 (with alternate 14:9 center)⁽²⁾</td> </tr> <tr> <td>1000</td> <td>Full frame</td> <td>1111</td> <td>16:9 (with alternate 4:3 center)⁽²⁾</td> </tr> </tbody> </table> <table border="1" data-bbox="740 1192 1386 1499"> <thead> <tr> <th colspan="4">16:9 Coded Frame</th> </tr> <tr> <th>AFD Code⁽¹⁾</th> <th>Description</th> <th>AFD Code⁽¹⁾</th> <th>Description</th> </tr> </thead> <tbody> <tr> <td>–</td> <td>No code present</td> <td>1001</td> <td>4:3 (center)</td> </tr> <tr> <td>0000</td> <td>Undefined</td> <td>1010</td> <td>16:9 (image protected)⁽²⁾</td> </tr> <tr> <td>0010</td> <td>Full frame</td> <td>1011</td> <td>14:9 (center)</td> </tr> <tr> <td>0011</td> <td>4:3 (center)</td> <td>1101</td> <td>4:3 (with alternate 14:9 center)</td> </tr> <tr> <td>0100</td> <td>Box > 16:9 (center)</td> <td>1110</td> <td>16:9 (with alternate 14:9 center)⁽²⁾</td> </tr> <tr> <td>1000</td> <td>Full frame</td> <td>1111</td> <td>16:9 (with alternate 4:3 center)⁽²⁾</td> </tr> </tbody> </table> <p>1: AFD codes numbering and definitions conform to SMPTE 2016-1-2007. 2: Image Protected implies picture content that must not be cropped by conversion processes or display devices. Alternate center formats may have protected center areas, with areas outside of the protected area not containing mandatory content.</p>	4:3 Coded Frame				AFD Code ⁽¹⁾	Description	AFD Code ⁽¹⁾	Description	–	No code present	1001	Full frame	0000	Undefined	1010	16:9 (center)	0010	Box 16:9 (top)	1011	14:9 (center)	0011	Box 14:9 (top)	1101	4:3 (with alternate 14:9 center)	0100	Box > 16:9 (center)	1110	16:9 (with alternate 14:9 center) ⁽²⁾	1000	Full frame	1111	16:9 (with alternate 4:3 center) ⁽²⁾	16:9 Coded Frame				AFD Code ⁽¹⁾	Description	AFD Code ⁽¹⁾	Description	–	No code present	1001	4:3 (center)	0000	Undefined	1010	16:9 (image protected) ⁽²⁾	0010	Full frame	1011	14:9 (center)	0011	4:3 (center)	1101	4:3 (with alternate 14:9 center)	0100	Box > 16:9 (center)	1110	16:9 (with alternate 14:9 center) ⁽²⁾	1000	Full frame	1111	16:9 (with alternate 4:3 center) ⁽²⁾
4:3 Coded Frame																																																																	
AFD Code ⁽¹⁾	Description	AFD Code ⁽¹⁾	Description																																																														
–	No code present	1001	Full frame																																																														
0000	Undefined	1010	16:9 (center)																																																														
0010	Box 16:9 (top)	1011	14:9 (center)																																																														
0011	Box 14:9 (top)	1101	4:3 (with alternate 14:9 center)																																																														
0100	Box > 16:9 (center)	1110	16:9 (with alternate 14:9 center) ⁽²⁾																																																														
1000	Full frame	1111	16:9 (with alternate 4:3 center) ⁽²⁾																																																														
16:9 Coded Frame																																																																	
AFD Code ⁽¹⁾	Description	AFD Code ⁽¹⁾	Description																																																														
–	No code present	1001	4:3 (center)																																																														
0000	Undefined	1010	16:9 (image protected) ⁽²⁾																																																														
0010	Full frame	1011	14:9 (center)																																																														
0011	4:3 (center)	1101	4:3 (with alternate 14:9 center)																																																														
0100	Box > 16:9 (center)	1110	16:9 (with alternate 14:9 center) ⁽²⁾																																																														
1000	Full frame	1111	16:9 (with alternate 4:3 center) ⁽²⁾																																																														
<p>• Output Line</p> 	<p>Allows selecting the line location of the AFD data within the video signal Ancillary Data space. (Range is 9 thru 41.)</p> <p>Note:</p> <ul style="list-style-type: none"> • Although the output line drop-down will allow any choice within the 9 thru 41 range, the actual range is automatically clamped (limited) to certain ranges to prevent inadvertent conflict with active picture area depending on video format. See Ancillary Data Line Number Locations and Ranges (p. 3-13) for more information. • The card does not check for conflicts on a given line number. Make certain the selected line is available and carrying no other data. 																																																																

Table 3-2 9084 Function Submenu List — continued

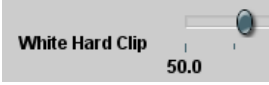

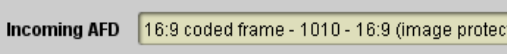
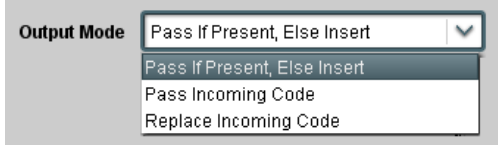
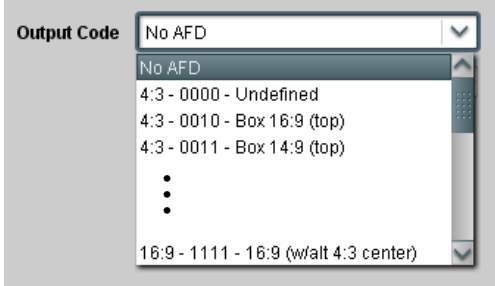
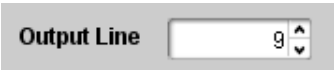

	<p>Provides color corrector functions for the individual RGB channels of the received SD/HD SDI signal.</p>
<p>• Color Corrector</p>  <p>Color Corrector On</p> <p>Card Edge Control Menu:</p>  <p>Vid</p> <p>1 2 3</p> <p>CirC Enbl On Off</p> <p>Color Corrector On Color Corrector Off</p>	<p>Color Corrector (On/Off) provides master on/off control of all Color Corrector functions.</p> <ul style="list-style-type: none"> • When set to Off, all processing is bypassed. • When set to On, currently displayed parameters settings take effect.
<p>• Reset to Unity</p>  <p>Reset to Unity Confirm</p> <p>Card Edge Control Menu:</p>  <p>Vid</p> <p>1 2 3</p> <p>CirC Unty Y?</p> <p>Move toggle switch in either direction to confirm unity reset. Reject reset by pressing Exit Menu pushbutton.</p>	<p>Reset to Unity provides unity reset control of all Color Corrector functions.</p> <p>When Confirm is clicked, a Confirm? pop-up appears, requesting confirmation.</p> <ul style="list-style-type: none"> • Click Yes to proceed with the unity reset. • Click No to reject unity reset.
<p>• Black Adj. (Green – Red – Blue)</p>  <p>Black Adj. Green -100.0</p> <p>Black Adj. Blue -100.0</p> <p>Black Adj. Red -100.0</p> <p>Card Edge Control Menu:</p>  <p>Vid</p> <p>1 2 3 4</p> <p>CirC OFFS GRN BLUE RED</p> <p>Select Green channel Select Blue channel Select Red channel</p> <p>(value) Black (offset/lift) value in percent (0.1% precision)</p>	<p>Separate red, green, and blue black level controls respectively apply lift value for R, G, and B channels.</p> <p>(-100.0 to 100.0% range in 0.1% steps; null = 0.0)</p>

Table 3-2 9084 Function Submenu List — continued

<div style="background-color: #333; color: white; padding: 5px; text-align: center; font-weight: bold;">Color Correction</div>	(continued)								
<p>• Gang Black Level Controls</p> <div style="border: 1px solid gray; padding: 5px; margin-bottom: 10px;"> <p>Gang Black Level Controls <input type="checkbox" value="On"/></p> </div> <div style="border: 1px solid gray; padding: 5px;"> <p>Card Edge Control Menu:</p> <p>Vid</p> <table border="1" style="width: 100%; text-align: center; border-collapse: collapse;"> <tr> <td style="width: 25%;">1</td> <td style="width: 25%;">2</td> <td style="width: 25%;">3</td> <td style="width: 25%;">4</td> </tr> <tr> <td>ClrC</td> <td>OFFS</td> <td>GANG</td> <td>On Off</td> </tr> </table> <p style="font-size: small;">Ganging On Ganging Off</p> </div>	1	2	3	4	ClrC	OFFS	GANG	On Off	<p>When set to On, changing any of the Black Adj. controls increases or decreases R, G, and B black levels by equal amounts.</p>
1	2	3	4						
ClrC	OFFS	GANG	On Off						
<p>• White Adj. (Green – Red – Blue)</p> <div style="border: 1px solid gray; padding: 5px; margin-bottom: 10px;"> <p>White Adj. Green <input type="text" value="0.0"/></p> <p>White Adj. Blue <input type="text" value="0.0"/></p> <p>White Adj. Red <input type="text" value="0.0"/></p> </div> <div style="border: 1px solid gray; padding: 5px;"> <p>Card Edge Control Menu:</p> <p>Vid</p> <table border="1" style="width: 100%; text-align: center; border-collapse: collapse;"> <tr> <td style="width: 25%;">1</td> <td style="width: 25%;">2</td> <td style="width: 25%;">3</td> <td style="width: 25%;">4</td> </tr> <tr> <td>ClrC</td> <td>GAIN</td> <td>GRN BLUE RED</td> <td>(value)</td> </tr> </table> <p style="font-size: small;">Select Green channel Select Blue channel Select Red channel Gain value in percent (0.1% precision)</p> </div>	1	2	3	4	ClrC	GAIN	GRN BLUE RED	(value)	<p>Separate red, green, and blue gain controls respectively apply gain percentage for R, G, and B channels. (0.0 to 200.0% range in 0.1% steps; unity = 100.0)</p>
1	2	3	4						
ClrC	GAIN	GRN BLUE RED	(value)						
<p>• Gang White Level Controls</p> <div style="border: 1px solid gray; padding: 5px; margin-bottom: 10px;"> <p>Gang White Level Controls <input type="checkbox" value="On"/></p> </div> <div style="border: 1px solid gray; padding: 5px;"> <p>Card Edge Control Menu:</p> <p>Vid</p> <table border="1" style="width: 100%; text-align: center; border-collapse: collapse;"> <tr> <td style="width: 25%;">1</td> <td style="width: 25%;">2</td> <td style="width: 25%;">3</td> <td style="width: 25%;">4</td> </tr> <tr> <td>ClrC</td> <td>GAIN</td> <td>GANG</td> <td>On Off</td> </tr> </table> <p style="font-size: small;">Ganging On Ganging Off</p> </div>	1	2	3	4	ClrC	GAIN	GANG	On Off	<p>When set to On, changing any of the White Adj. (gain) controls increases or decreases R, G, and B gain levels by equal amounts.</p>
1	2	3	4						
ClrC	GAIN	GANG	On Off						

Table 3-2 9084 Function Submenu List — continued

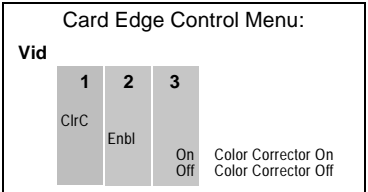
<div style="background-color: #444; color: white; padding: 5px; text-align: center; font-weight: bold;">Color Correction</div>	(continued)										
<p>• Gamma (Green – Red – Blue)</p>  <p>Green Gamma 0.125 Blue Gamma 0.125 Red Gamma 0.125</p> <div style="border: 1px solid black; padding: 5px; margin-top: 10px;"> <p style="text-align: center;">Card Edge Control Menu:</p> <p>Vid</p> <table border="1" style="width: 100%; border-collapse: collapse;"> <tr> <td style="width: 25%;"></td> <td style="width: 25%; text-align: center;">1</td> <td style="width: 25%; text-align: center;">2</td> <td style="width: 25%; text-align: center;">3</td> <td style="width: 25%; text-align: center;">4</td> </tr> <tr> <td style="text-align: center;">ClrC</td> <td></td> <td style="text-align: center;">GAMA</td> <td style="text-align: center;">GRN BLUE RED</td> <td style="text-align: center;">(value)</td> </tr> </table> <p style="font-size: small;">Select Green channel Select Blue channel Select Red channel Gamma value in percent (0.001% precision)</p> </div>		1	2	3	4	ClrC		GAMA	GRN BLUE RED	(value)	<p>Separate red, green, and blue gamma controls respectively apply gamma curve adjustment for R, G, and B channels. (0.125 to 8.000 range in thousandths steps; unity = 1.000)</p>
	1	2	3	4							
ClrC		GAMA	GRN BLUE RED	(value)							
<p>• Gang Gamma Controls</p> <div style="background-color: #ccc; padding: 5px; margin-bottom: 10px;"> <p>Gang Gamma Controls <input checked="" type="checkbox"/></p> </div> <div style="border: 1px solid black; padding: 5px; margin-bottom: 10px;"> <p style="text-align: center;">Card Edge Control Menu:</p> <p>Vid</p> <table border="1" style="width: 100%; border-collapse: collapse;"> <tr> <td style="width: 25%;"></td> <td style="width: 25%; text-align: center;">1</td> <td style="width: 25%; text-align: center;">2</td> <td style="width: 25%; text-align: center;">3</td> <td style="width: 25%; text-align: center;">4</td> </tr> <tr> <td style="text-align: center;">ClrC</td> <td></td> <td style="text-align: center;">GAMA</td> <td style="text-align: center;">GANG</td> <td style="text-align: center;">On Off</td> </tr> </table> <p style="font-size: small;">Ganging On Ganging Off</p> </div>		1	2	3	4	ClrC		GAMA	GANG	On Off	<p>When set to On, changing any of the Gamma controls increases or decreases all Gamma settings by equal amounts.</p>
	1	2	3	4							
ClrC		GAMA	GANG	On Off							

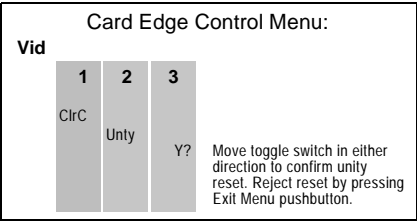
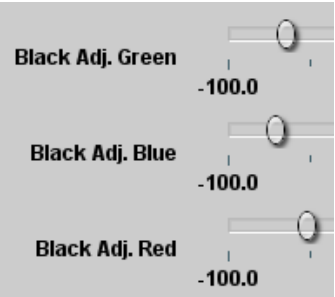
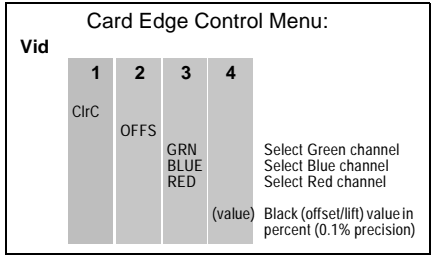
Table 3-2 9084 Function Submenu List — continued





	<p>Provides video Frame Sync and delay control tools.</p>
<p>• Framesync Enable</p> 	<p>Disables the Frame Sync function, or selects from choices below.</p> <ul style="list-style-type: none"> • Off: Disables Frame Sync function; output video timing matches the input video timing. • Reference 1: Allows Frame Sync function to use external Reference 1 as the reference standard. • Reference 2: Allows Frame Sync function to use external Reference 2 as the reference standard. <p>Note: If Reference 1 or Reference 2 is selected and an appropriate external reference is not received, the  indication appears in the Card Info status portion of DashBoard™, indicating invalid frame sync reference error. (Additionally, the card edge ERR indicator illuminates indicating the same.) External reference signals Reference 1 and Reference 2 are distributed to the card and other cards via an 8310 frame bus.</p> <ul style="list-style-type: none"> • Input Video: Uses the input video signal as the reference standard. <p>Note: If Input Video is used for framesync, any timing instability on the input video will result in corresponding instability on the output video.</p>
<p>• Vertical Delay Control</p> 	<p>When Framesync is enabled, sets vertical delay (in number of lines of output video/format) between the output video and the frame sync reference.</p> <p>(Range is -1124 thru 1124 lines.)</p> <p>Note: Lines refer to lines in the output video format, and not to the reference format.</p>
<p>• Horizontal Delay Control</p> 	<p>When Framesync is enabled, sets (in usec of output video timing) horizontal delay between the output video and the frame sync reference.</p> <p>(Range is -64.000 thru 64.000 μsec)</p> <p>Note: When an external framesync reference is used, the card will not produce a framesync reset until the variance between framesync reference and output video exceeds ± 2 clock periods. Therefore, a framesync reset will not result if offsets within this window are applied.</p> <p>To apply an offset/framesync reset within this window, first apply a relatively large offset, then apply the target smaller offset.</p> <p>Example: To apply a 1-period offset, first apply a 10-period positive offset and then apply a 9-period negative offset. This results in the target 1-period offset being applied to the output video.</p>

Table 3-2 9084 Function Submenu List — continued



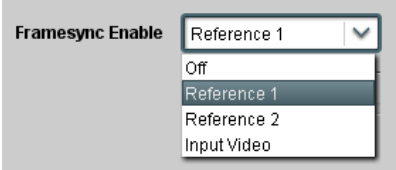



	(continued)
<p>• Minimum Latency Frames Control</p> 	<p>When Framesync is enabled, specifies the smallest amount of latency allowed by the frame sync (latency measurement in output video frames). The frame sync will not output a frame unless the specified number of frames are captured in the buffer. The operational latency of the frame sync is always between the specified minimum latency and minimum latency plus one frame (not one field). (Maximum range is 0 to 13.)</p> <p>Note: Due to card memory limits, the maximum available Minimum Latency Frames is related to the output video format selected. For example, with a 1080i59.94 output, the maximum allowed setting is 5. For a 1080i film (23.98) output, the maximum allowed setting is 3. Conversely, greater maximum settings are allowed for SD formats such as 525i59.94, where the practical maximum limit is 13.</p> <p>When using this control, be sure to check the Framesync Status display as follows:</p>  <ul style="list-style-type: none"> • Latency frames selection within limits.  <ul style="list-style-type: none"> • Latency frames selection exceeds limits.
<p>• Video Delay Display</p> 	<p>Displays the current input-to-output video delay (in msec units) as well as in terms of Frames/fractional frame (in number of lines).</p>
<p>• Framesync Status Display</p> 	<p>Displays the current framesync status as follows:</p>  <ul style="list-style-type: none"> • Framesync status OK.  <ul style="list-style-type: none"> • Framesync Enable set to Off.  <ul style="list-style-type: none"> • Improper or missing framesync reference.  <ul style="list-style-type: none"> • Latency frames selection exceeds limits. <p>Note: See Minimum Latency Frames Control (p. 3-23) for more information about this message.</p>
<p>• Loss of Input Signal Selection</p> 	<p>In the event of input video Loss of Signal (LOS), determines action to be taken as follows:</p> <ul style="list-style-type: none"> • Disable Outputs: Disable all outputs. • Freeze Last Frame: Freeze image to last good frame (last frame having valid SAV and EAV codes). • Freeze to Color: Freeze image to a color raster (as selected using Framesync LOS Freeze Color control). <p>Note: If this card is used to also pass embedded audio, note that audio noise will occur upon loss of input with "Freeze Last Frame" selected.</p>

Table 3-2 9084 Function Submenu List — continued

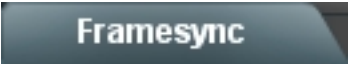

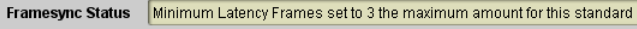
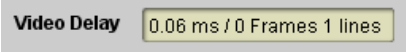

	(continued)
<p>• Framesync LOS Freeze Color</p> 	<p>In the event of LOS with Freeze to Color enabled above, sets the image raster color from choices shown to the left.</p>
<p>• Custom Color Hue</p> 	<p>Adjusts raster hue (phase angle) for custom LOS color. (-360° to 360° range in 0.1° steps; null = 0°)</p>
<p>• Custom Color Saturation</p> 	<p>Adjusts raster saturation level for custom LOS color. (0% to 100% range in 0.1% steps)</p>
<p>• Custom Color Y Level</p> 	<p>Adjusts raster luma level for custom LOS color. (64 to 940 range)</p>
<p>• Reset Framesync</p> 	<p>Resets the frame sync, clearing any buffered video. When Confirm is clicked, a Confirm? pop-up appears, requesting confirmation.</p> <ul style="list-style-type: none"> • Click Yes to reset the frame sync. • Click No to reject reset.

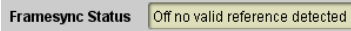
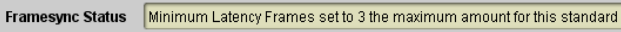
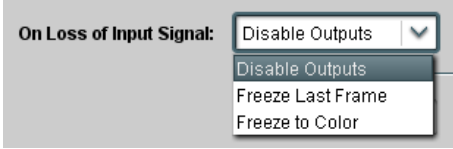
Table 3-2 9084 Function Submenu List — continued



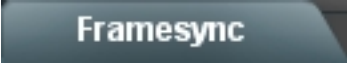
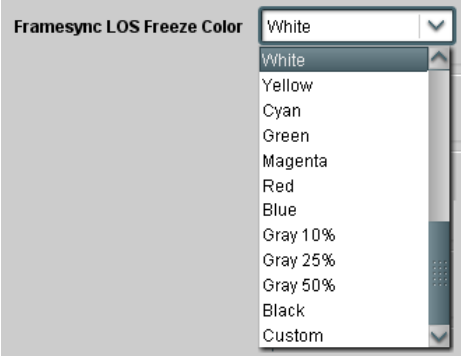

	<p>This function allows up to 16 card user settings configuration presets to be saved in a Preset and then recalled (loaded) as desired. All current settings (including list selections and scalar (numeric) control settings such as Gain, etc.) are saved when a Preset Save is invoked.</p>
	<p>The Preset Name field and Preset Save button allow custom user setting configurations to be labeled and saved to a Preset for future use.</p> <p>The Preset Load button and the Selected Preset drop-down list allow saved presets to be selected and loaded as desired. When a preset is loaded, it immediately becomes active with all user settings now automatically set as directed by the preset.</p> <p>Saved presets can be uploaded to a computer for use with other same-model COMPASS™ cards.</p> <p>Each of the items to the left are described in detail on the following pages.</p>
<p>• Preset Save and Load</p> 	<ul style="list-style-type: none"> • Preset Save stores all current card control settings to the currently selected preset. (For example, if Preset 1 is selected in the Selected Preset drop-down list, clicking and confirming Preset Save will then save all current card control settings to Preset 1) • Preset Load loads (applies) all card control settings defined by whatever preset (Preset 1 thru Preset 16) is currently selected in the Selected Preset drop-down list. (For example, if Preset 3 is selected in the Selected Preset drop-down list, clicking and confirming Preset Load will then apply all card control settings defined in Preset 3) <p>The above buttons have a Confirm? pop-up that appears, requesting confirmation.</p> <p>Note: Applying a change to a preset using the buttons described above rewrites the previous preset contents with the invoked contents. Make certain change is desired before confirming preset change.</p>
<p>• Selected Preset</p> 	<p>Selected Preset 1 thru Selected Preset 16 range in drop-down list selects one of 16 stored presets as ready for Save (being written to) or for Load (being applied to the card).</p> <p>Note: The preset names shown to the left are the default (unnamed) preset names. All 16 presets in this case are loaded identically with the factory default settings.</p>
<p>• Card Name</p> 	<p>Text entry field provides for optional entry of card name, function, etc. (as shown in this example).</p> <p>Note: Card name can be 31 ASCII characters maximum.</p>

Table 3-2 9084 Function Submenu List — continued

	(continued)								
<p>• Reset Current Preset</p> 	<p>• Reset Current Preset resets all parameters (including preset custom name entered) of the currently selected Preset (as displayed in the Selected Preset field) to factory default settings.</p> <p>The above button has a Confirm? pop-up that appears, requesting confirmation.</p> <p>The factory default settings are as follows:</p> <table border="1" data-bbox="755 571 1370 827"> <thead> <tr> <th>Function</th> <th>Parameter/Setting</th> </tr> </thead> <tbody> <tr> <td>Video Proc</td> <td>All parameters set to unity/null settings.</td> </tr> <tr> <td>Framesync</td> <td>Framesync is disabled; Reference 1 or 2 must be selected to enable the frame sync.</td> </tr> <tr> <td>Color Correction</td> <td>All parameters set to unity/null settings.</td> </tr> </tbody> </table>	Function	Parameter/Setting	Video Proc	All parameters set to unity/null settings.	Framesync	Framesync is disabled; Reference 1 or 2 must be selected to enable the frame sync.	Color Correction	All parameters set to unity/null settings.
Function	Parameter/Setting								
Video Proc	All parameters set to unity/null settings.								
Framesync	Framesync is disabled; Reference 1 or 2 must be selected to enable the frame sync.								
Color Correction	All parameters set to unity/null settings.								
<p>• Preset Name</p> 	<p>With one of 16 presets selected, provides for entry of custom name for the preset (as shown in example below).</p>  <p>Entering text in Preset Name field (in this example, "RCVR21") applies custom name to selected Preset (in this example, Preset 2)</p> <p>Note:</p> <ul style="list-style-type: none"> • Preset name can be seven ASCII characters maximum. • The Preset ID number does not need to be entered; it is added automatically. 								
<p>• Download Presets</p> 	<p>Download Presets allows all 16 presets to be stored to a specified location on a network computer for use with other same-model COMPASS™ cards.</p> <p>Refer to Cobalt® reference guide "COMPASS™ Remote Control User Guide" (PN 9000RCS-RM) for instructions on using the Download Presets function.</p>								

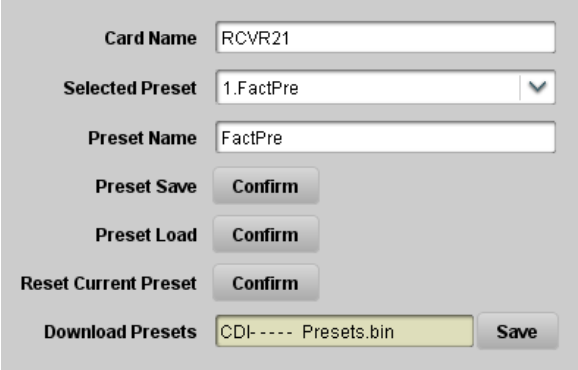
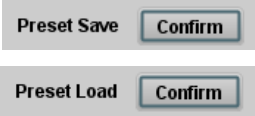
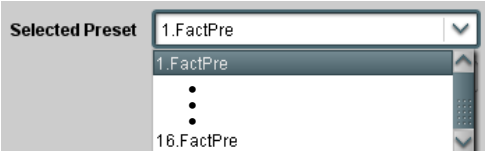
Color and Video Correction Examples Using the 9084

Shown below are examples of using the 9084 to provide parametric color and video correction.

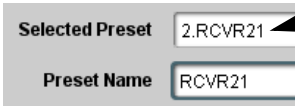
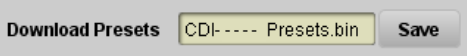
On-Set Monitor Color Correction Example

A typical use for the 9084 Color Corrector function is to provide color correction for a monitor when an anchor desk set includes a monitor, as shown in Figure 3-9.

In the example setup shown in Figure 3-9, a monitor is located behind the anchor desk. When the camera includes the monitor in its shot, typically the color balance of the monitor will appear to be incorrect due to the characteristics of the camera responding differently to the spectral light emissions from the monitor as compared to the natural light spectra emissions that exist across the set overall. This monitor color balance problem is a function of the camera(s), and can vary with different camera models.

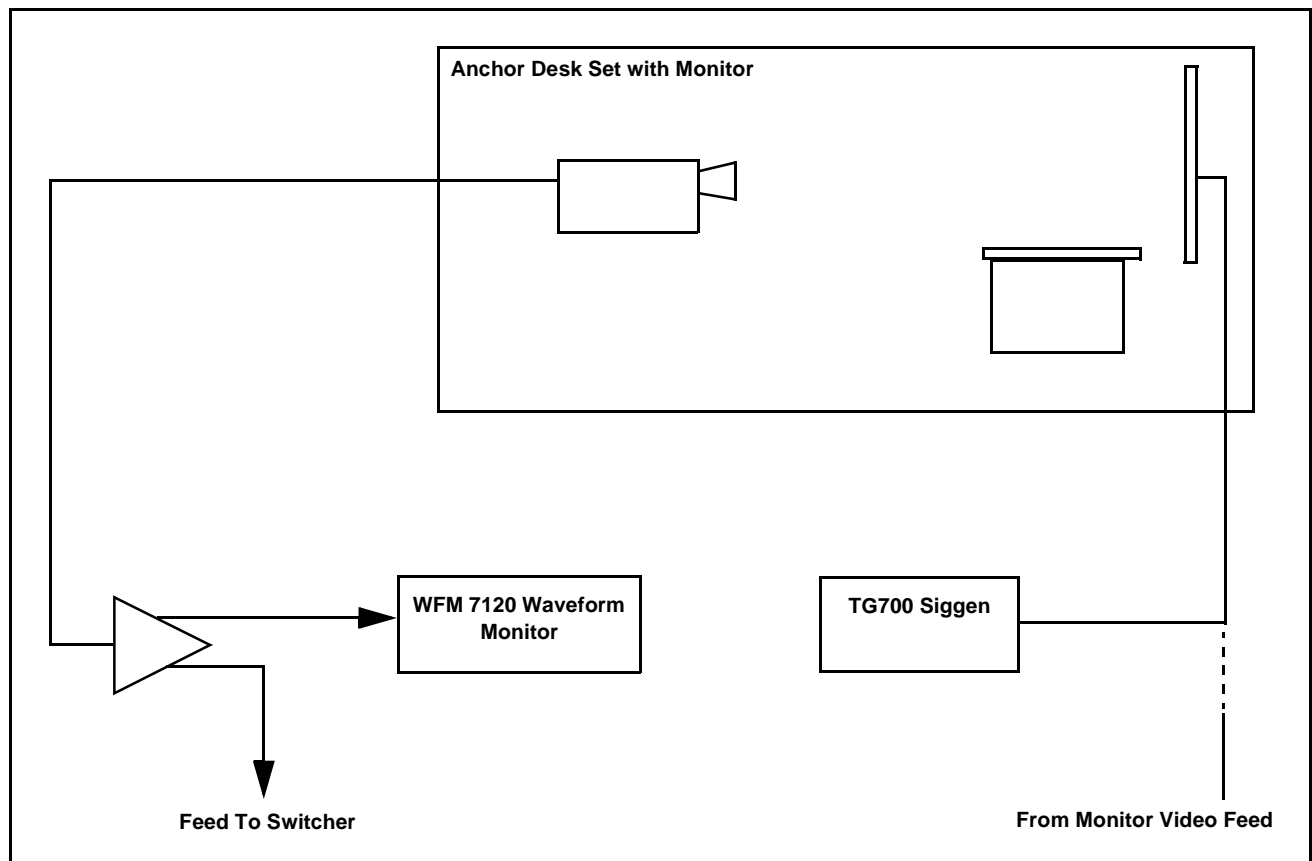

Figure 3-9 Example Uncompensated Setup

Ideally, this display would essentially result in a waveform showing identical RGB components corresponding to the grayscale monochrome bar spectrum being fed to the set monitor. However, as shown in Figure 3-10 with no correction applied, the waveform monitor shows imbalance between the RGB channels due to the reasons discussed above. Note the excessive offset, level, and deviation from an ideal gamma curve for the blue channel.

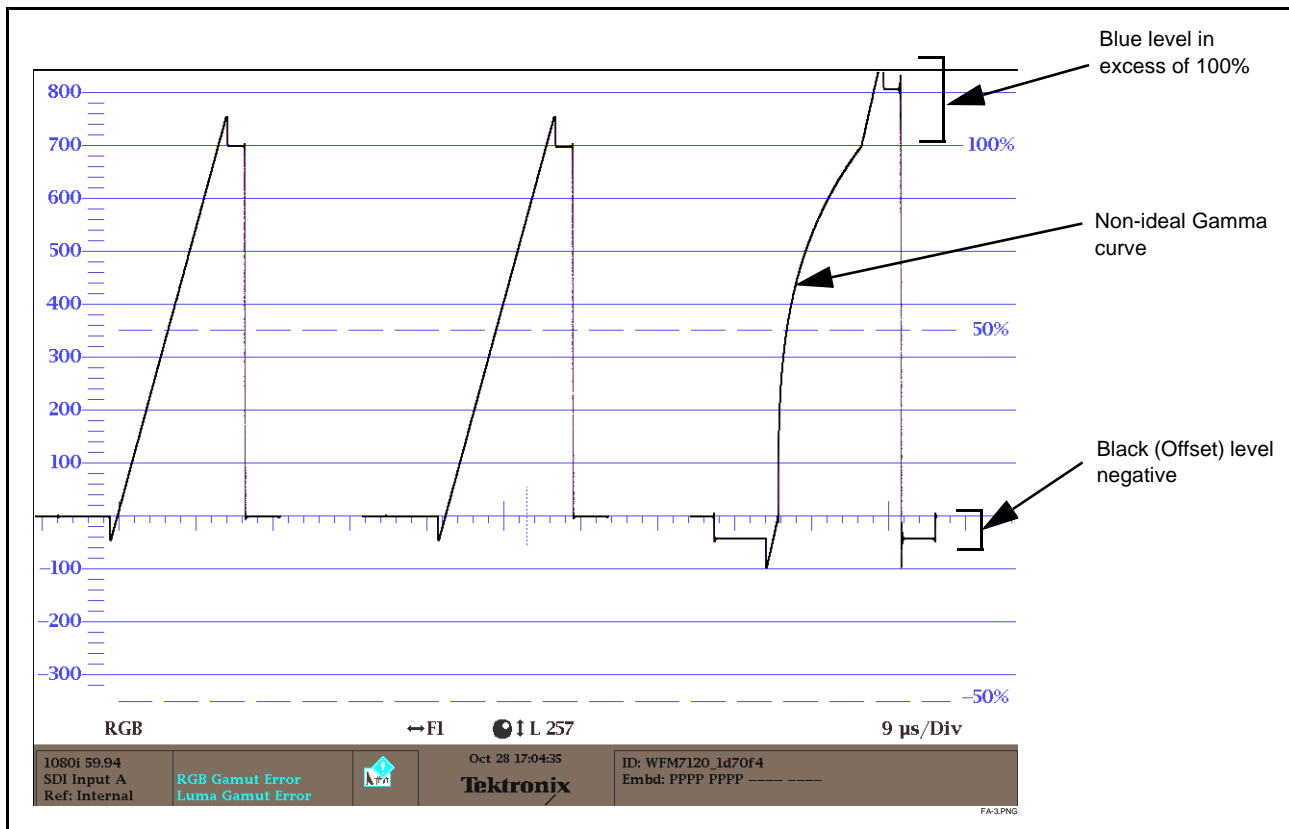

Figure 3-10 Uncorrected (Uncompensated) Monitor Waveform

Figure 3-11 shows the same setup using the 9084 Color Corrector function, along with the appropriate signal source standard and a video waveform monitor to assess and determine the color correction required. In the calibration setup shown in Figure 3-11 the feed to the switcher is monitored by a WFM 7120 Waveform Monitor, with the set monitor being fed a monochrome linear limit ramp by a TG700 siggen.

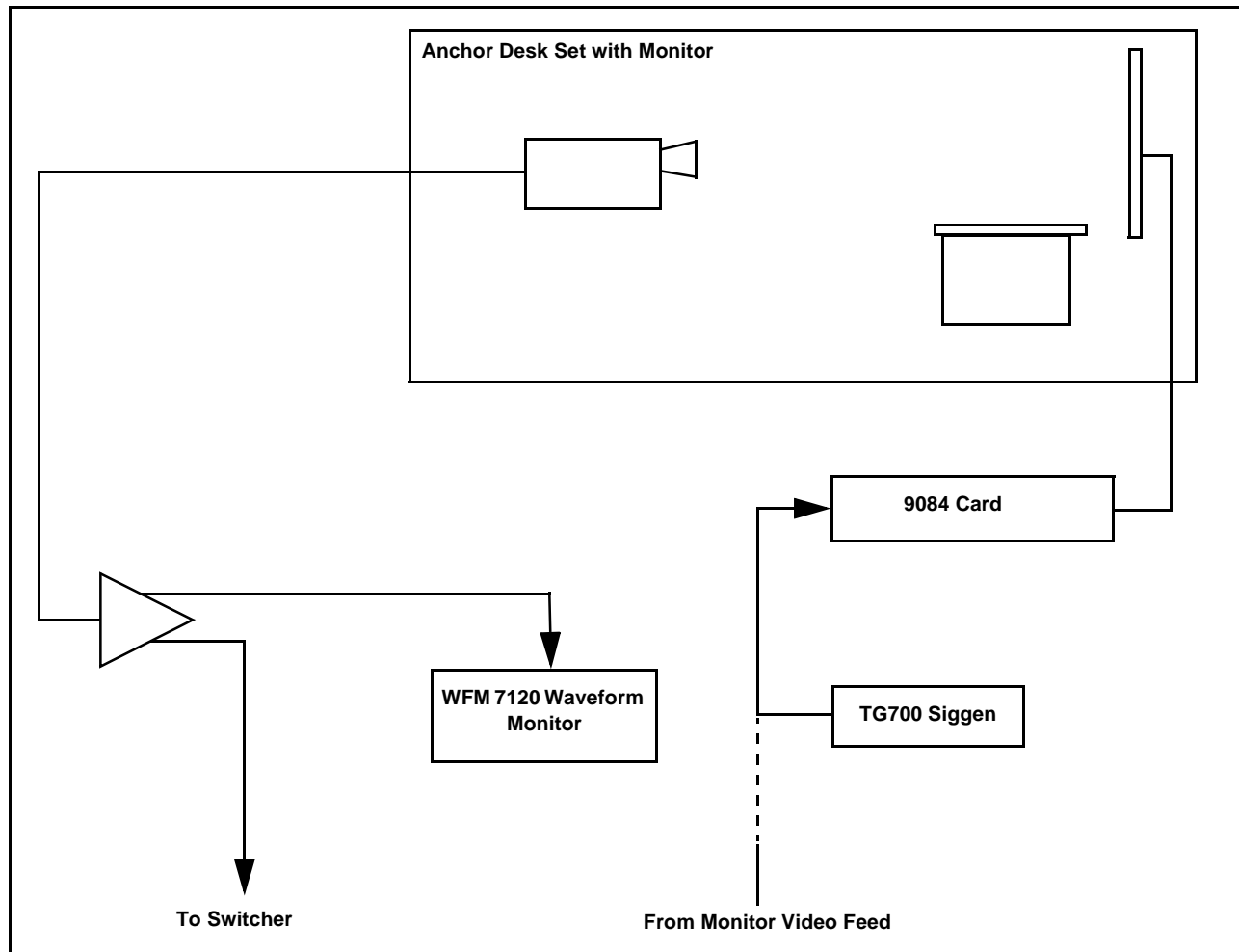
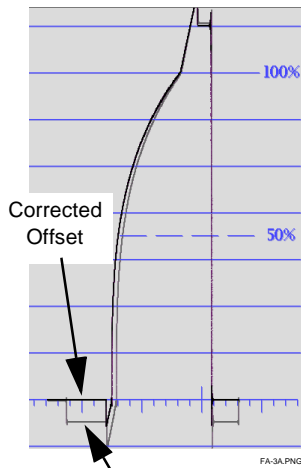

Figure 3-11 Example Setup Using Control Panel Color Corrector Function

Using the 9084 Color Corrector function and setup shown in Figure 3-11, this condition can be corrected through compensation using the 9084 Color Corrector function as shown in Figure 3-12.

Note: As shown in Figure 3-12, a recommended approach to performing color corrections is to first apply offset correction, then gain correction, and finally gamma correction.



Uncompensated black Offset

(Left) Noting that the uncompensated black offset for the blue channel is negative, a correspondingly equivalent positive setting is applied using the blue channel **Black** offset control (in this example, adjusting the Black offset from unity to 5.0 provides compensation).

(Right) Noting that the uncompensated blue Gain exceeds ideal 100% level, a correspondingly smaller gain percentage setting is applied using the blue channel **Gain** control until the gain is observed as 100% (in this example, adjusting blue **Gain** from unity to 87.5% provides compensation).

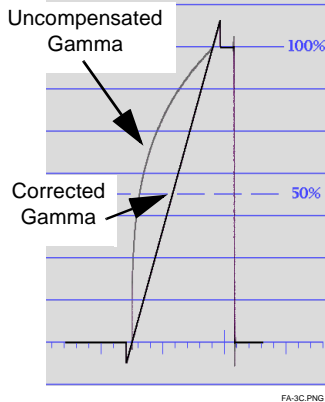
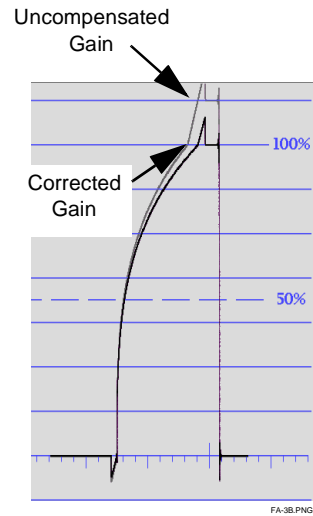

(Left) Noting that the uncompensated blue Gamma curve indicates gamma factor is less than ideal 1.000, a correspondingly greater numeric gamma factor is applied using the blue channel **Gamma** control until the blue gamma function is observed as linear (in this example, adjusting blue **Gamma** from unity to 3.333 provides compensation).

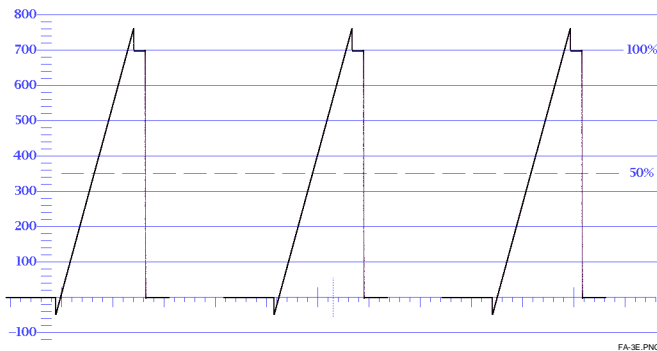

(Left) Compensated Offset, Gain, and Gamma are now symmetrical across all three color channels, resulting in proper monitor appearance in the OTA feed.

Figure 3-12 Applying Correction to Example Monitor Waveform Signal

Miscellaneous Color and Video Correction Examples

Table 3-3 provides examples showing and describing various color and video condition corrections using the 9084.

Note: Signal generator and waveform monitor used in these examples are Tektronix® models TG700 and WFM 7120, respectively.

Table 3-3 Color and Video Corrections Using the 9084

Condition Observed On Waveform Monitor	Correction Using 9084
<p>Excessive red channel Gamma (as shown below for SMPTE color bars on vectorscope display)</p> 	<p>Using the red channel Gamma control to reduce Gamma factor, vectorscope display now shows correction with no knee or curvature at intersection of axes.</p> 
<p>Excessive green channel lift/offset (as shown below for SMPTE color bars on vectorscope display)</p> 	<p>Using the green channel Black control to reduce green channel lift/offset, vectorscope display now shows no droop along axis.</p> 

Table 3-3 Color and Video Corrections Using the 9084 — continued

Condition Observed On Waveform Monitor	Correction Using 9084
<p>White (luma) level exceeding 100% level (as shown below for limit ramp monochrome bars on waveform monitor display)</p> 	<p>Using the White Hard Clip control, a lowered white hard clipping threshold is applied to now limit the level to 100%.</p> 
<p>White (luma) level exceeding 100% level (as shown below for limit ramp monochrome bars on waveform monitor display)</p> 	<p>Using the White Soft Clip control, a lowered white soft clipping threshold is applied to now limit the level to 100%.</p> 
<p>Luma gain less than 100% level (as shown below for 100% color bars on YPbPr waveform monitor display)</p> 	<p>Using the Luma Gain control to increase luma gain, luma gain is now restored to 100%.</p> 

Table 3-3 Color and Video Corrections Using the 9084 — continued

Condition Observed On Waveform Monitor	Correction Using 9084
<p>Chroma gain exceeds 100% level (as shown below for 100% color bars on YPbPr waveform monitor display)</p>  <p>VAR10.PNG</p>	<p>Using the Color Gain (Chroma) control to reduce chroma gain, chroma gain is now restored to 100% level.</p>  <p>VAR10A.PNG</p>
<p>Leading color phase condition (as shown below for SMPTE color bars on vector display)</p>  <p>Vector → FI ● 1 L 257 Bars: 75% VAR8.PNG</p> <p>Vectors are advanced and do not coincide with 0° points</p>	<p>Using the Color Phase control to provide phase lag, color phase condition is now corrected.</p>  <p>Vector → FI ● 1 L 257 Bars: 75% VAR8A.PNG</p> <p>Vectors coincide with 0° points</p>

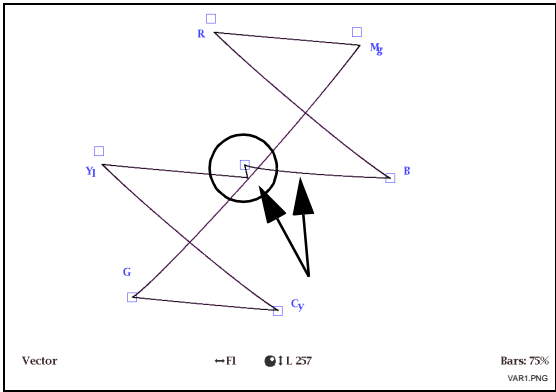
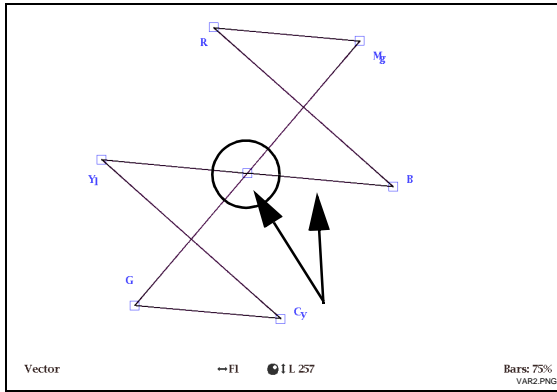
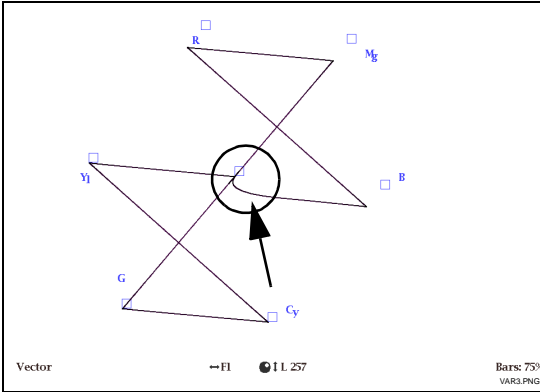
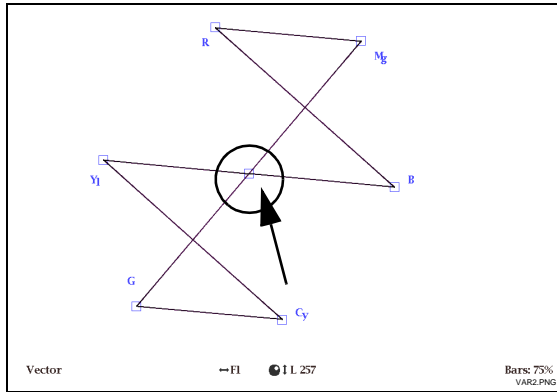
Troubleshooting

This section provides general troubleshooting information and specific symptom/corrective action for the 9084 card. The 9084 card requires no periodic maintenance in its normal operation; if any error indication (as described in this section) occurs, use this section to correct the condition.

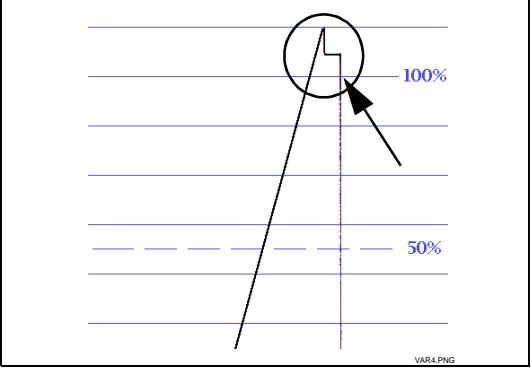
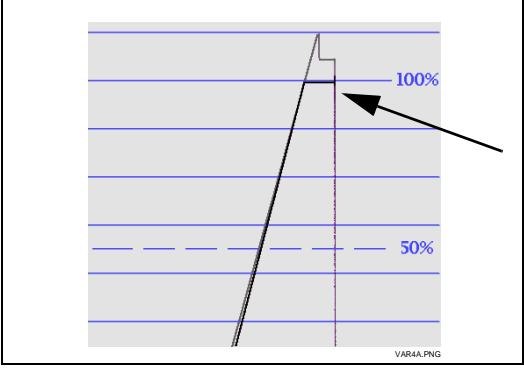
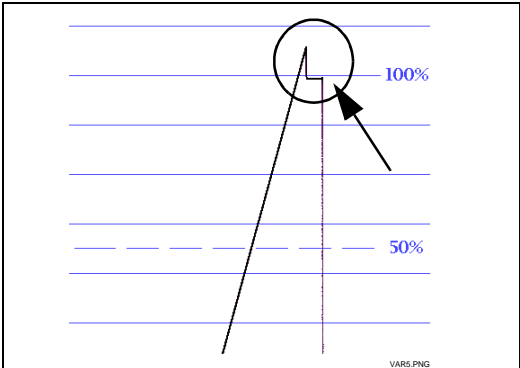
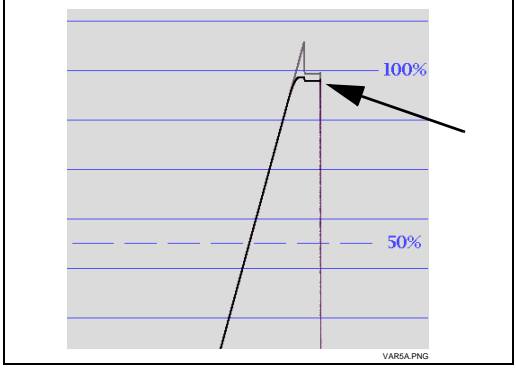
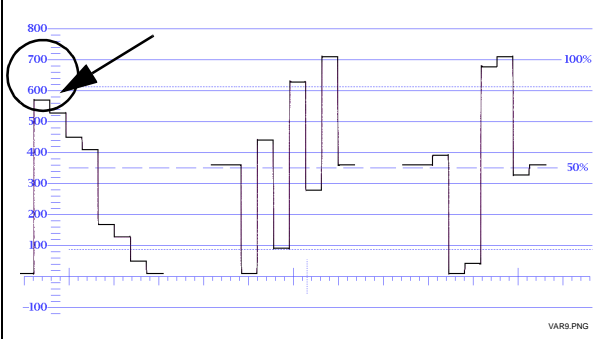
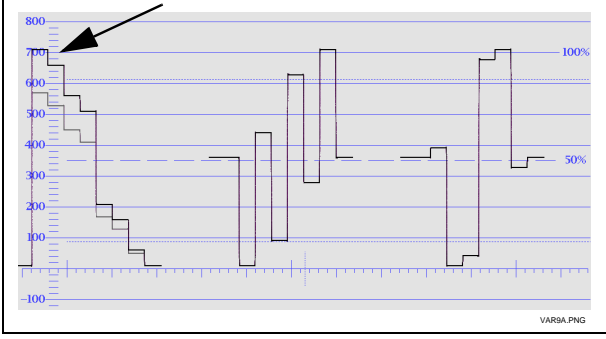
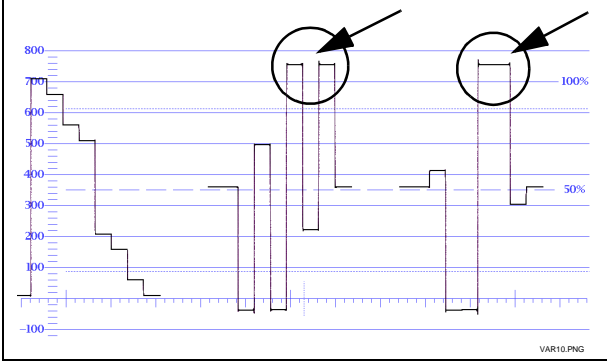
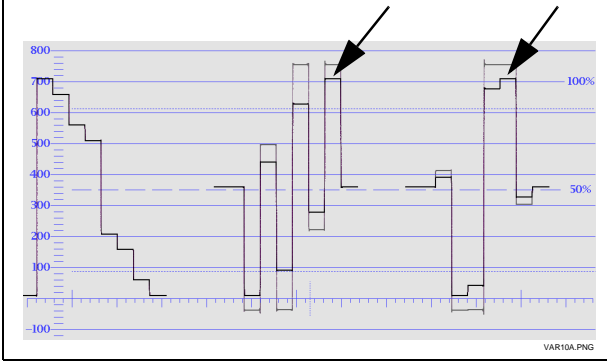
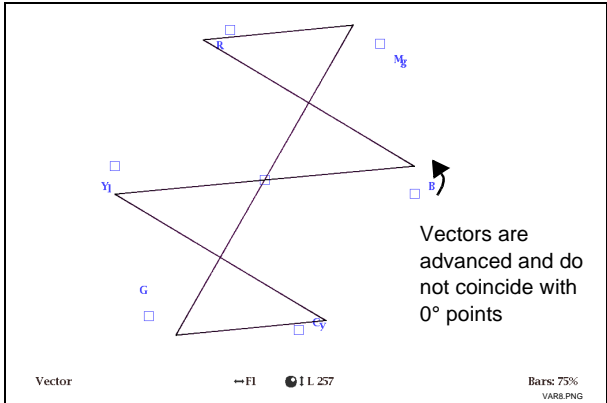
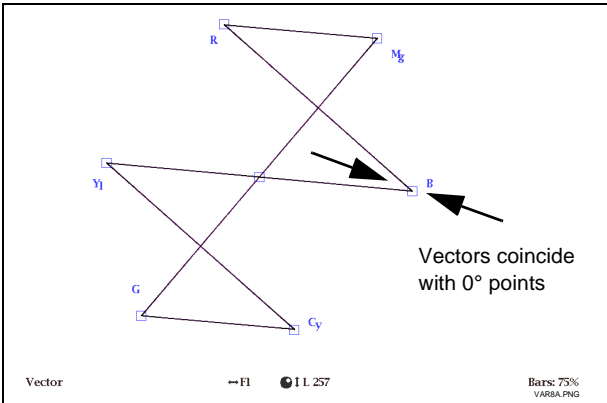
Error and Failure Indicator Overview

The 9084 card itself and its remote control systems all (to varying degrees) provide error and failure indications. Depending on how the 9084 card is being used (i.e, standalone or network controlled through DashBoard™ or a Remote Control Panel), check all available indications in the event of an error or failure condition.

The various 9084 card and remote control error and failure indicators are individually described below.

Note: The descriptions below provide general information for the various status and error indicators. For specific failures, also use the appropriate subsection listed below.

- Basic Troubleshooting Checks (p. 3-38)
- 9084 Processing Error Troubleshooting (p. 3-39)
- Troubleshooting Network/Remote Control Errors (p. 3-40)

9084 Card Edge Status/Error Indicators and Display

Figure 3-13 shows and describes the 9084 card edge status indicators and display. These indicators and the display show status and error conditions relating to the card itself and remote (network) communications (where applicable). Because these indicators are part of the card itself and require no external interface, the indicators are particularly useful in the event of communications problems with external devices such as network remote control devices.

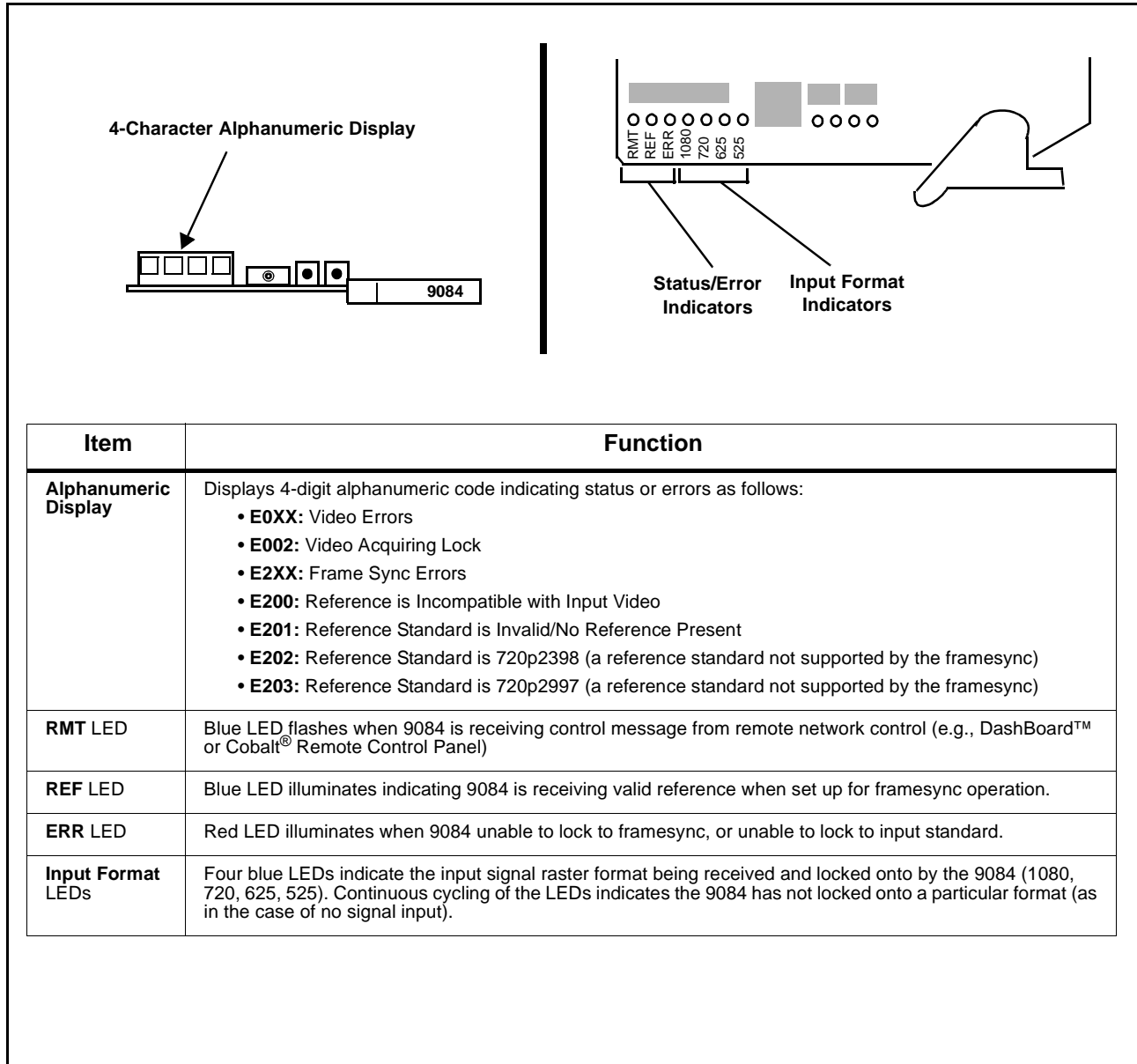

Figure 3-13 9084 Card Edge Status Indicators and Display

DashBoard™ Status/Error Indicators and Displays

Figure 3-14 shows and describes the DashBoard™ status indicators and display. These indicator icons and displays show status and error conditions relating to the 9084 card itself and remote (network) communications.

Indicator Icon or Display	Error Description
	<p>Red indicator icon in Card Access/Navigation Tree pane shows card with Error condition (in this example, the Card Access/Navigation Tree pane shows a general error issued by the 9084 card in slot 7).</p> <p>Specific errors are displayed in the Card Info pane (in this example “No connection to device” indicating 9084 card is not connecting to frame/LAN).</p> <p>If the 9084 card is not connecting to the frame or LAN, all controls are grayed-out (as shown in the example here).</p>
	<p>Gray indicator icon in Card Access/Navigation Tree pane shows card(s) are not being seen by DashBoard™ due to lack of connection to frame LAN (in this example, both a 9084 card in slot 7 and the MFC-8310-N Network Controller Card for its frame in slot 0 are not being seen).</p>
	<p>Yellow indicator icon in Card Access/Navigation Tree pane shows card with Alert condition (in this example, the Card Access/Navigation Tree pane shows a general alert issued by the MFC-8310-N Network Controller Card).</p> <p>Clicking the card slot position in the Card Access/Navigation Tree (in this example Network Controller Card “Slot 0: MFC-8310-N”) opens the Card Info pane for the selected card. In this example, a “Fan Door Open” specific error is displayed.</p>
	<p>Yellow indicator icon in 9084 Card Info pane shows error alert, along with cause for alert (in this example, the 9084 is receiving no video input, or a video input that is invalid for the card and/or its current settings).</p>
	<p>Where available, error messages within a function submenu pane show highly specific information relating to detected errors (in this example, message shows an invalid or missing Framesync Enable reference selection).</p>

Figure 3-14 DashBoard™ Status Indicator Icons and Display

Access Card Info panes for specific cards by clicking the card slot position in the Card Access/Navigation Tree pane (as shown in the example in Figure 3-15).

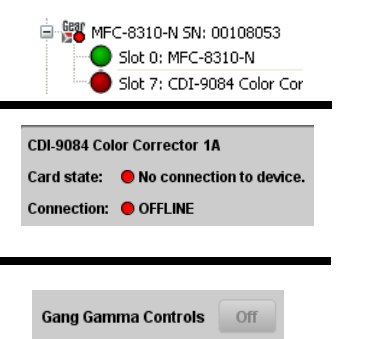
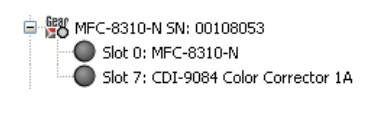
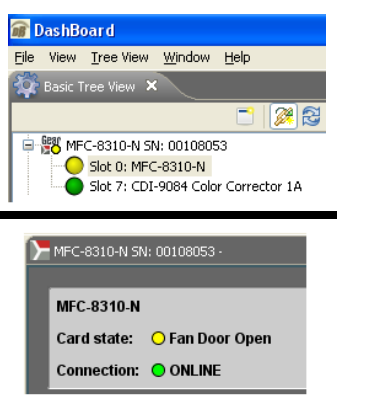
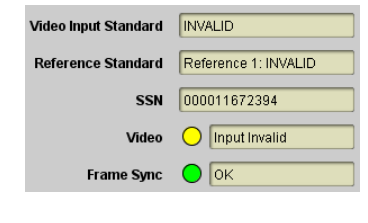
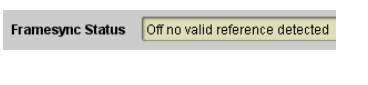
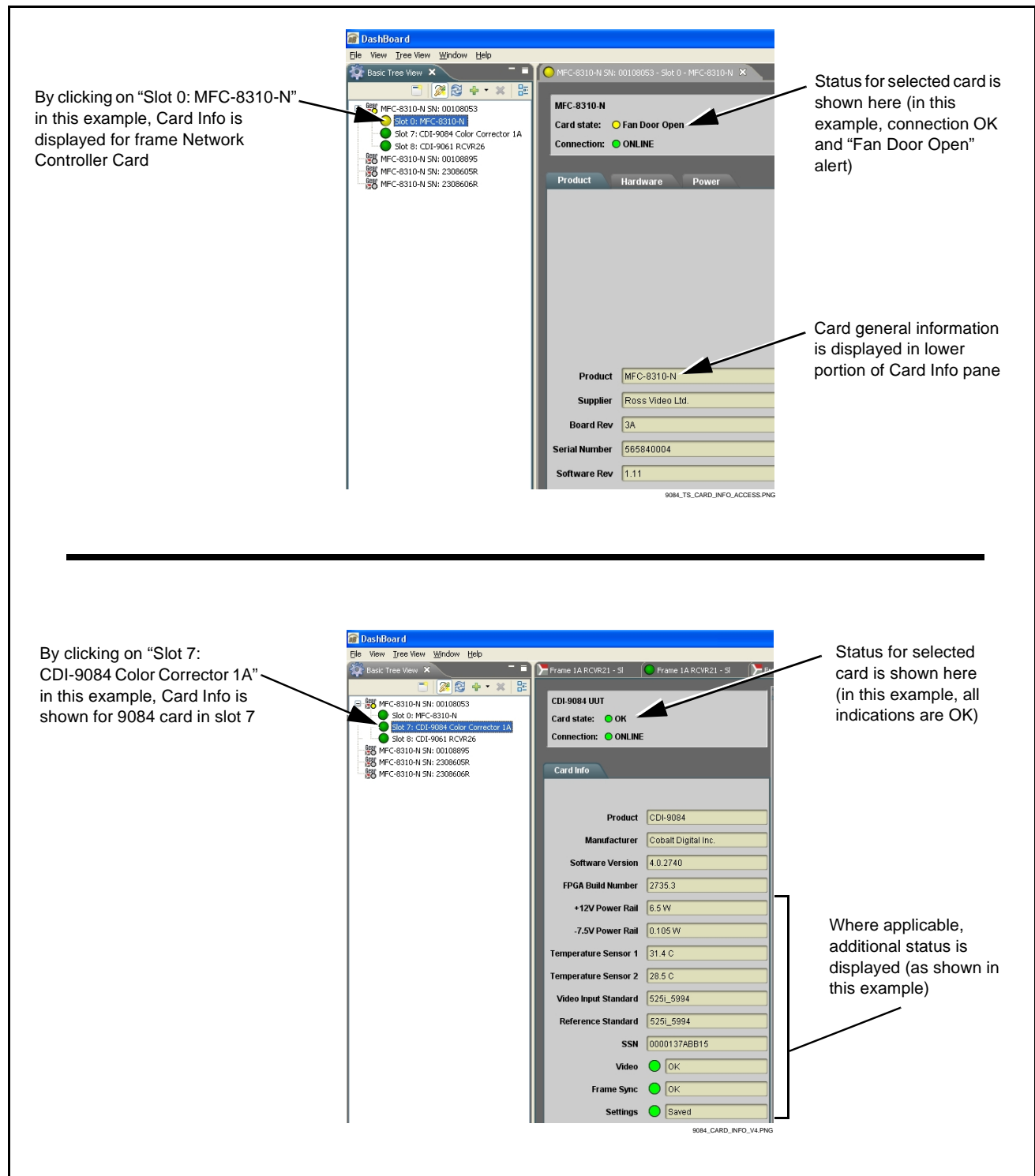

Figure 3-15 Selecting Specific Cards for Card Info Status Display

Basic Troubleshooting Checks

Failures of a general nature (affecting many cards and/or functions simultaneously), or gross inoperability errors are best addressed first by performing basic checks before proceeding further. Table 3-4 provides basic system checks that typically locate the source of most general problems. If required and applicable, perform further troubleshooting in accordance with the other troubleshooting tables in this section.

Table 3-4 Basic Troubleshooting Checks

Item	Checks
Verify power presence and characteristics	<ul style="list-style-type: none"> • On both the frame Network Controller Card and the 9084, in all cases when power is being properly supplied there is always at least one indicator illuminated. Any card showing no illuminated indicators should be cause for concern. • Check the Power Consumed indications for both the +12 V and -7.5 V supply rails for the 9084 card. This can be observed using the DashBoard™ Card Info pane, or using the card edge controls and indicators as shown in Figure 3-7 on page 3-12. <ul style="list-style-type: none"> • If either of the rail supplies show no power being consumed, either the frame power supply, connections, or the 9084 card itself is defective. • If either of the rail supplies show excessive power being consumed (see Technical Specifications (p. 1-11) in Chapter 1, "Introduction"), the 9084 card may be defective.
Check Cable connection secureness and connecting points	<p>Make certain all cable connections are fully secure (including coaxial cable attachment to cable ferrules on BNC connectors). Also, make certain all connecting points are as intended. Make certain the selected connecting points correlate to the intended card inputs and/or outputs. Cabling mistakes are especially easy to make when working with large I/O modules.</p>
Card seating within slots	<p>Make certain all cards are properly seated within its frame slot. (It is best to assure proper seating by ejecting the card and reseating it again.)</p>
Check status indicators and displays	<p>On both DashBoard™ and the 9084 card edge indicators, red indications signify an error condition. If a status indicator signifies an error, proceed to the following tables in this section for further action.</p>
Troubleshoot by substitution	<p>All cards within the frame can be hot-swapped, replacing a suspect card or module with a known-good item.</p>

9084 Processing Error Troubleshooting

Table 3-5 provides 9084 processing troubleshooting information. If the 9084 card exhibits any of the symptoms listed in Table 3-5, follow the troubleshooting instructions provided.

In the majority of cases, most errors are caused by simple errors where the 9084 is not appropriately set for the type of signal being received by the card.

Note: The error indications shown below are typical for the corresponding error conditions listed. Other error indications not specified here may also be displayed on DashBoard™ and/or the 9084 card edge status indicators.

Note: Where errors are displayed on both the 9084 card and network remote controls, the respective indicators and displays are individually described in this section.

Table 3-5 Troubleshooting Processing Errors by Symptom



Symptom	Error/Condition	Corrective Action
<ul style="list-style-type: none"> DashBoard™ shows Video yellow icon and Input Invalid message in 9084 Card Info pane.  <ul style="list-style-type: none"> Card edge Input Format LEDs show continuous cycling. 	No video input present	Make certain intended video source is connected to appropriate 9084 card video input. Make certain BNC cable connections between frame Rear I/O Module for the card and signal source are OK.
<ul style="list-style-type: none"> DashBoard™ shows Frame Sync red icon and Reference Invalid message in 9084 Card Info pane.  <ul style="list-style-type: none"> Card edge red ERR indicator illuminated. 	Frame sync reference not properly selected or not being received	<ul style="list-style-type: none"> If external frame sync reference is not intended to be used, make certain the Framesync Enable selection list is set to Off or Input Video as desired. If external frame sync reference is intended to be used, make certain selected external frame sync reference is active on frame sync 8310 frame bus. (External reference signals Reference 1 and Reference 2 are distributed to the 9084 and other cards via an 8310 frame bus.) Refer to Framesync function submenu tab on page 3-22 for more information.

Table 3-5 Troubleshooting Processing Errors by Symptom — continued

Symptom	Error/Condition	Corrective Action
<p>DashBoard™ shows Framesync Status error message in 9084 Framesync function submenu screen.</p> 	Specified Minimum Latency Frames setting exceeds 9084 card buffer space for the selected output video format	<ul style="list-style-type: none"> Reduce the Minimum Latency Frames setting as specified in the error message to correct the error. <p>Note: Due to card memory limits, the maximum available Minimum Latency Frames is related to the output video format. For example, with a 1080i59.94 output, the maximum allowed setting is 5. For a 1080i film (23.98) output, the maximum allowed setting is 3. Conversely, greater maximum settings are allowed for SD formats such as 525i59.94, where the practical maximum limit is 13.</p>
Ancillary data (closed captioning, timecode, AFD, etc.) not transferred through 9084.	<ul style="list-style-type: none"> Control(s) not enabled 	<ul style="list-style-type: none"> Make certain respective control is set to On or Enabled (as appropriate).
	<ul style="list-style-type: none"> VANC line number conflict between two or more ancillary data items 	<ul style="list-style-type: none"> Make certain each ancillary data item to be passed is assigned a unique line number (see Ancillary Data Line Number Locations and Ranges on page 3-13).

Troubleshooting Network/Remote Control Errors

Refer to Cobalt® reference guide “COMPASS™ Remote Control User Guide” (PN 9000RCS-RM) for network/remote control troubleshooting information.

In Case of Problems

Should any problem arise with this product that was not solved by the information in this section, please contact the Cobalt Digital Inc. Technical Support Department.

If required, a Return Material Authorization number (RMA) will be issued to you, as well as specific shipping instructions. If required, a temporary replacement item will be made available at a nominal charge. Any shipping costs incurred are the customer’s responsibility. All products shipped to you from Cobalt Digital Inc. will be shipped collect.

The Cobalt Digital Inc. Technical Support Department will continue to provide advice on any product manufactured by Cobalt Digital Inc., beyond the warranty period without charge, for the life of the product.

See Contact Cobalt Digital Inc. (p. 1-15) in Chapter 1, “Introduction” for contact information.



Cobalt Digital Inc.

2406 E. University Ave.
Urbana, IL 61802
Voice 217.344.1243 • Fax 217.344.1245
www.cobaltdigital.com

Free Manuals Download Website

<http://myh66.com>

<http://usermanuals.us>

<http://www.somanuals.com>

<http://www.4manuals.cc>

<http://www.manual-lib.com>

<http://www.404manual.com>

<http://www.luxmanual.com>

<http://aubethermostatmanual.com>

Golf course search by state

<http://golfingnear.com>

Email search by domain

<http://emailbydomain.com>

Auto manuals search

<http://auto.somanuals.com>

TV manuals search

<http://tv.somanuals.com>