

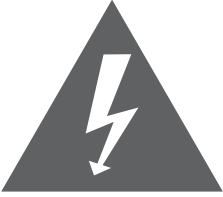

Precautions

	CAUTION WARNING: SHOCK HAZARD. DO NOT OPEN. AVIS: RISQUE DE CHOC ELECTRIQUE. NE PAS OUVRIR	
CAUTION: TO REDUCE THE RISK OF FIRE AND ELECTRIC SHOCK, DO NOT REMOVE THE COVER (OR BACK) OF THE UNIT. REFER SERVICING ONLY TO QUALIFIED SERVICE PERSONNEL.		



The lightning flash with arrowhead symbol within an equilateral triangle is intended to alert the user to the presence of uninsulated "dangerous voltage" within the product's enclosure that may be of sufficient magnitude to constitute a risk of electric shock.



The exclamation point within an equilateral triangle is intended to alert the user to the presence of important operation and servicing instructions in the literature accompanying the appliance.



For recycling or disposal information about this product, please contact your local authorities or the Electronics Industries Alliance: www.eiae.org.

For Customer Use:

Enter below the serial number that is located on the rear of the unit. Retain this information for future reference.

Model No. TFDVD2495/2295S2/1995S2/1595S3

Serial No. _____

Precautions

WARNING: To prevent fire or shock hazard, do not expose this device to rain or moisture. Dangerous high voltage is present inside the enclosure. Do not open the cabinet.

Note: If the product suddenly has no response or powers off, an electrostatic discharge may be the cause. In this circumstance, please follow the procedures below for recovery:

- Unplug the unit. Wait 30 seconds.
- After 30 seconds, plug the unit in and turn it on again.

FCC Statement:

This device complies with Part 15 of the FCC Rules. Operation is subject to the following two conditions:

- This device may not cause harmful interference, and
- This device must accept any interference received, including interference that may cause undesired operation.

Note:

This equipment has been tested and found to comply with the limits for Class B digital devices, pursuant to Part 15 of the FCC rules. These limits are designed to provide reasonable protection against harmful interference in a residential installation. This equipment generates, uses and can radiate radio frequency energy and, if not installed and used in accordance with the instructions, may cause harmful interference to radio communications. However, there is no guarantee that interference will not occur in a particular installation. If this equipment does cause harmful interference to radio or television reception, which can be determined by turning the equipment off and on, the user is encouraged to try to correct the interference by one or more of the following measures:

- Reorient or relocate the receiving antenna.
- Increase the separation between the equipment and receiver.
- Connect the equipment into an outlet on a circuit different from that to which the receiver is connected.
- Consult the dealer or an experienced radio/TV technician for help

Use of shielded cable is required to comply with Class B limits in Subpart B of Part 15 of the FCC rules. Do not make any changes or modifications to the equipment unless otherwise specified in the manual. If such changes or modifications should be made, you could be required to stop operation of the equipment.

Important Safety Instructions

Warnings and precautions

To prevent any injuries, the following safety precautions should be observed in the installation, use, servicing and maintenance of this equipment. Before operating this equipment, please read this manual completely, and keep it nearby for future reference.

Important Safety Instructions

1. Read Instructions: All the safety and operating instructions should be read before the product is operated.
2. Retain Instructions: The safety and operating instructions should be retained for future reference.
3. Heed Warnings: All warnings on the product and in the operating instructions should be adhered to.
4. Follow Instructions: All operating and usage instructions should be followed.
5. Do not place the equipment on uneven or unstable carts, stands, tables, shelves etc. The equipment may fall, causing serious injury to children or adults and serious damage to the equipment itself. Always place the equipment on the floor or on a surface that is sturdy, level, stable and strong enough to support the weight of the equipment.
6. Use only a cart or stand recommended by the manufacturer. This equipment and recommended cart or stand should be handled with care. Quick stops, excessive force, and uneven surfaces may cause the equipment and cart/stand to overturn.
7. Do not disable the 3-wire grounding type plug. The grounding pin on the 3-prong plug is an important feature. Removing the grounding pin will increase the risk of damaging the equipment.
8. If you can not fit the plug into the electrical outlet, contact an electrician to install a grounding outlet.
9. Always operate this equipment from the type of power source indicated on the rear of the serial/model plate.
10. Never overload wall outlets and extensions.
11. Use and handle the power cord with care. Do not place any heavy objects on the AC power cord.
12. Do not pull the AC power cord. Do not handle the AC power cord with a wet hand.
13. Do not touch the power cord and antenna cable during lightning.
14. Remove the plug from the wall outlet, if the equipment will not be used for a long period of time.
15. Do not place, use or handle this equipment near water.
16. Never expose the equipment to liquid, rain, or moisture. Seek service if any of the above is spilled into the equipment.
17. Do not expose the equipment to extreme temperature or to direct sunlight, as the equipment may heat up and suffer damage.
18. Do not install the equipment near any heat sources such as radiators, heat registers, stoves, or any other apparatus that might produce heat.
19. Do not attempt to service the equipment yourself.
20. Opening and removing the covers may expose you to dangerous voltage or other hazards and may void your warranty. Refer service to qualified personnel.
21. Do not place or drop any other objects on top.
22. Do not insert anything into the ventilation holes of your equipment. Inserting any metal or flammable objects may result to fire or electric shock.
23. Protect the power cord from being walked on or pinched particularly at plugs ,convenience receptacles, and the point where they exit
24. Refer all servicing to qualified service personnel. Servicing is required when the apparatus has been damaged in any way, such as power-supply cord or plug is damaged, liquid has been spilled or objects have fallen into the apparatus, the apparatus has been exposed to rain or moisture, does not operate normally, or has been dropped.
25. Always remove the power cord from the outlet before cleaning the equipment.
26. Never use liquid or aerosol cleaners on the equipment. Clean only with a soft dry cloth.
27. Only use attachments/accessories specified by the manufacturer.
28. Where the mains plug or an appliance coupler is used as the disconnected device, the disconnect device shall remain readily operable.

Important Safety Instructions

Antenna Safety Instructions

If an outdoor antenna is connected, follow the precautions below:

- An outdoor antenna should not be located in any area where it could come in contact with overhead power lines, or any other electric light or power circuits.
- When installing an outdoor antenna system, extreme caution should be taken to prevent contact with power lines. Direct contact with power lines may be fatal and should be avoided at all costs.

Section 810 of National Electrical Code (NEC) provides information with respect to proper grounding of the mast and supporting structure, grounding of the lead-in wire to an antenna discharge unit, size of grounding conductors, location of antenna discharge unit, connection to grounding electrodes, and requirements for the grounding electrode.

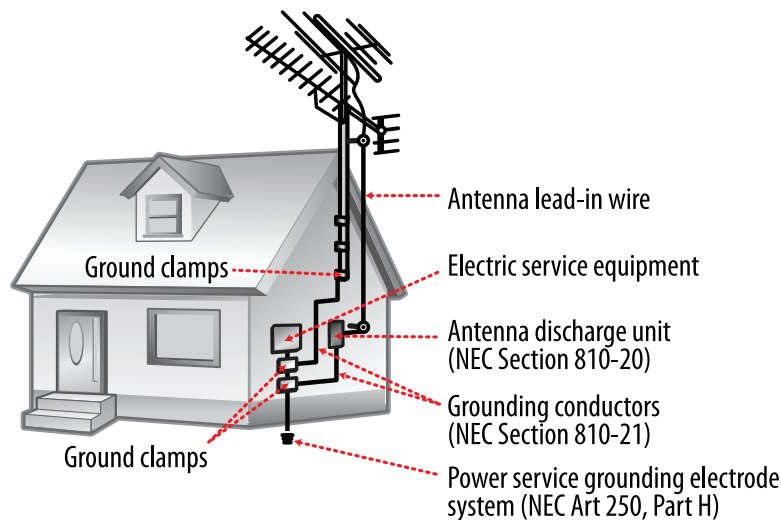

Listening with Earphones

- Listen at moderate Volumes to avoid hearing damage.
- If you hear no sound during playback, do not turn the Volume up as the music may suddenly begin at a high Volume. Excessive sound pressure from earphones and headphones can cause hearing loss.
- To avoid damaging your ears, adjust the Volume to the lowest level before playback, and turn up to the desired level when playback has started.

Legal and Trademark Notices

Coby is a registered trademark of Coby Electronics Corporation. All other trademarks and logos are property of their respective owners unless indicated otherwise.

Manufactured under license from Dolby Laboratories. "Dolby" and the double-D symbol are trademarks of Dolby Laboratories. Confidential unpublished works. © 1992 -1997 Dolby Laboratories, Inc. All rights reserved.

This TV incorporates High-Definition Multimedia Interface (HDMI™) technology. HDMI, the HDMI logo and High-Definition Multimedia Interface are trademarks or registered trademarks of HDMI Licensing LLC.

Note: This product contains electrical or electronic materials. The presence of these materials may, if not disposed of properly, have potential adverse effects on the environment and human health. Presence of this label on the product means it should not be disposed of as unsorted waste and must be collected separately. As a consumer, you are responsible for ensuring that this product is disposed of properly.

Table of Contents

Table Of Contents

Precautions

Important Safety Instructions

Main Feature-----	1
Package Contents-----	2
Unit View-----	3
Remote Control -----	4
Cable Connections-----	7
TV Function-----	11
AV Function-----	15
PC Function-----	16
DVD Operation-----	17
USB/Card Access-----	18
DVD Playback Function-----	19
DVD Setup-----	21
Troubleshooting -----	23
Specifications -----	24

Main Features

This product incorporates the LCD display and the TV receiver in one system.

Multiple Mode

TV
AV
S-VIDEO
COMPONENT
DVD
VGA
HDMI

High Quality Property

High Resolution

Adopt an MPEG2 decoding format to achieve horizontal resolution more than 500 lines.

Superior sound

Built-in Dolby Digital decoder to output high quality sound effects.

Screen

Support the picture size of a normal screen (4:3) and a wide screen (16:9)

LCD (Liquid Crystal Display)

Designed with color TFT liquid crystal display clearly shows the data.

LCD Information

The LCD panel used in this television contains millions of thin film transistors that have been manufactured using a high-technology process to deliver a crisp, clear, and detailed picture. Occasionally, a few of these transistors may become stuck or non-active; please note that this does not affect the performance of the television.

NOTE: It is normal for a TFT screen to experience some light or dark spots appearing on the LCD screen.

Advanced Playing Features

Compatibility

DVD, CD, MP3, CD-R, CD-RW, JPEG discs compatible.

All Playback Functions

Fast forward and reverse, repeat playback, program playback.

Power Supply:

Connect one end of the supplied power cord to the power jack on the unit rear panel and the other end to the AC100-240V wall outlet. If the unit will not be used for a long time, disconnect the plug from the outlet.

Power Management:

- Before plugging the power cord into the AC outlet, make sure that all necessary connections have been properly made.
- If the unit will not be used for a long period of time, disconnect the power and remove the batteries from the remote.

Package Contents

Please make sure the following items are included with your LCD TV/monitor. If any item is missing, contact your dealer.

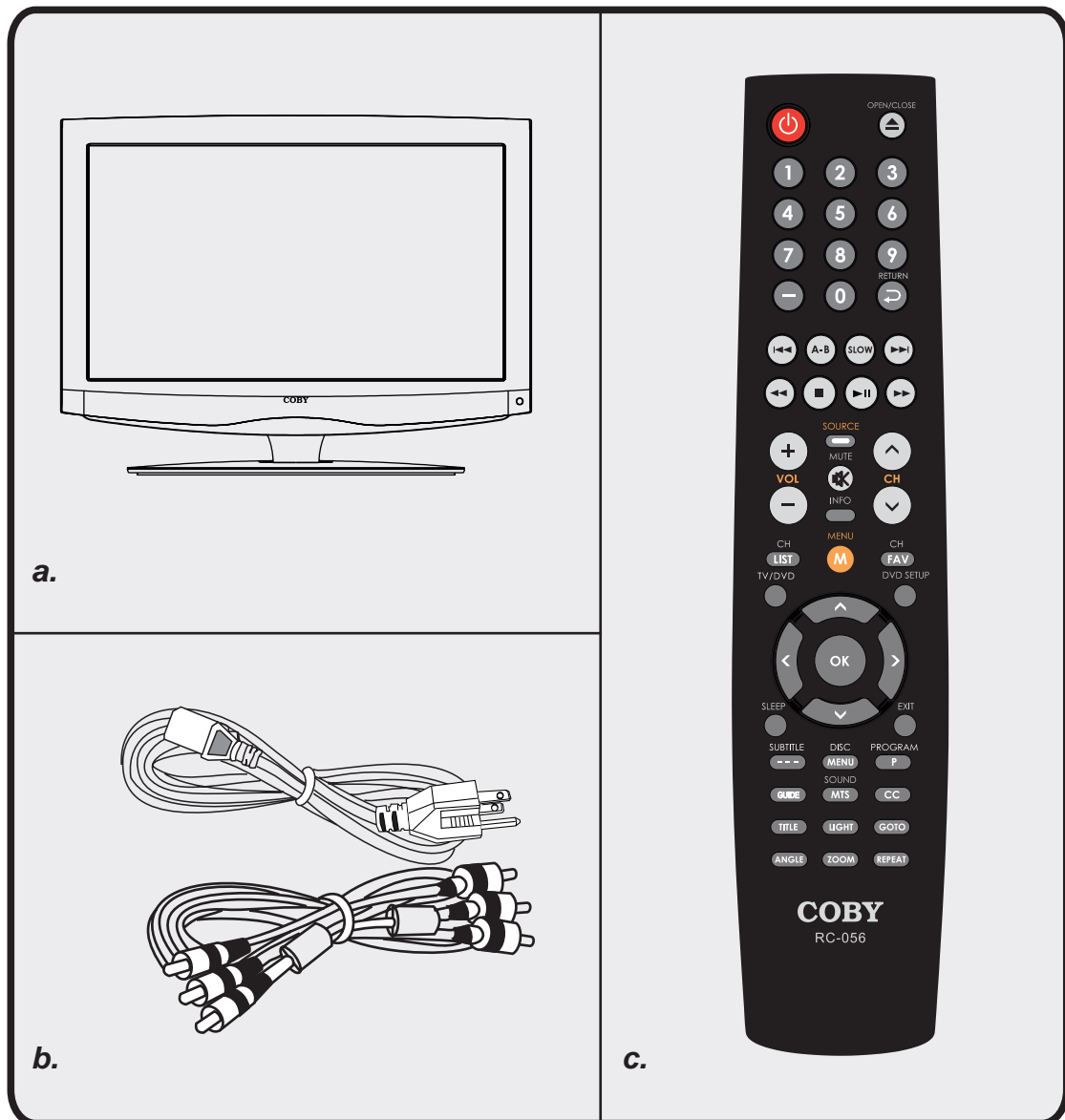

a, Main Unit

b, Power Cord & RCA Cable

c, Remote Control Unit

Unit View

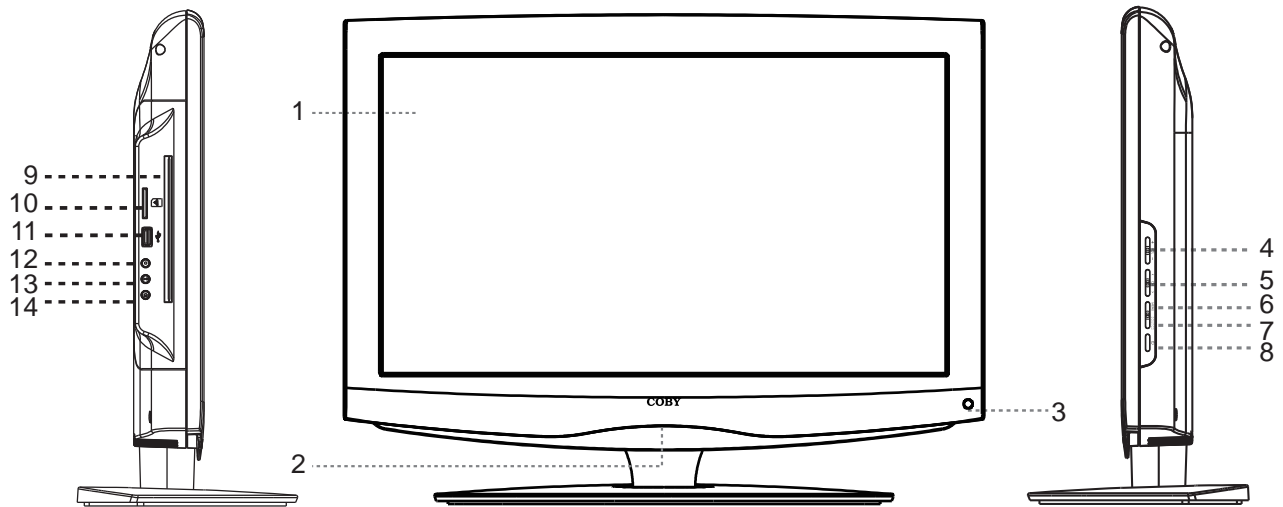

1. TFT SCREEN
Present high resolution pictures
2. POWER INDICATOR
The indicator lights bright blue when the TV is on, it will dim when the TV is turned off (standby mode).
3. REMOTE SENSOR
Sense the remote control signal.
4. VOL+/-
Adjust sound output level.
5. CH+/-
Press to skip channels.
6. MENU
Display the system setup menu.
7. SOURCE
Press this button to switch modes.
8. POWER
Press to turn on/off the player.
9. Disc Slot
10. Card Slot
11. USB Port
12. STOP - Stop disc playback.
13. PLAY/PAUSE - Start/hold disc playback.
14. OPEN/CLOSE - Open/close the disc room.
15. Wall Mounting Thread X 4
16. Connector Panel
17. Unit Stand
18. Screw - This screw is connecting the TV case to the unit stand-base.

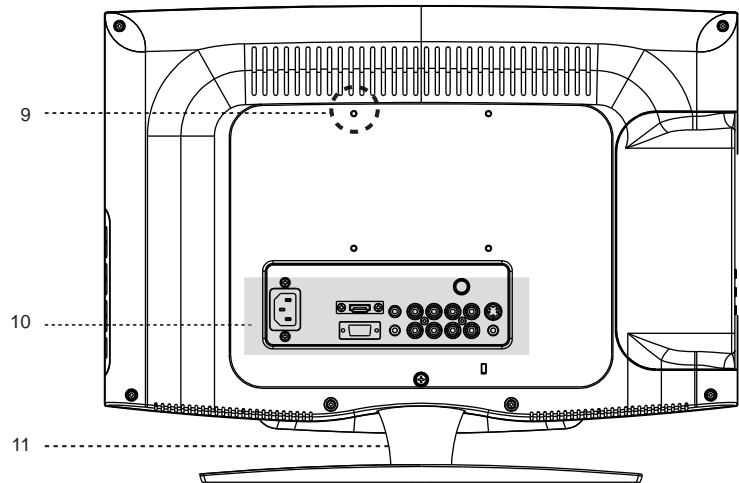

NOTE: See "Cable Connections" section for detailed description on connectors.

Wall Mounting - Attach the TV case to the wall

- Separate the TV case and the stand-base by removing screws before installation.
- Use the VESA standard mountings to fix the unit on the wall. Take care when mounting, it may cause damage or serious injury should it fall from its mountings. See the Specification page for VESA information. A variety of mounts are available in your local retailer, see instructions when installing the unit.

NOTE: 10 mm is the maximum depth that screws could be driven inside the unit cabinet without damaging the player.

Remote Control

Remote Control Drawing

1. POWER
Turn the unit on or off (standby).
2. Numeric Keypad
Input numeric data. Access the TV channel directly.
3. Sub-channel Selector <->
This button is usually used with the numeric keypad to tune to a channel substation (e.g., 4-1, 4-2).
e.g. To tune to channel 13-2, press these keys in sequence: <1>, <3>, <->, <2>.
4. Skip Backward
Repeatedly press this button to skip backward through DVD playback.
5. A-B
Repeat specified playback A to B in the DVD mode.
6. Fast Reverse
Search fast backward through DVD playback.
7. Stop
Stop disc playback.
8. VOL+/-
Adjust the volume level up and down.
9. INFO
Display system current working information.
10. CH/LIST
Display the TV program list, use the up/down direction button to select the desired program in the list, press OK to access.
11. TV/DVD
Switch between the TV mode and the DVD mode.
12. Direction & OK
This set of buttons is usually used when working with system setup menu, use arrow buttons to select an option in the menu, press OK to confirm settings.
13. SLEEP
Cycle through the sleep timer options.
14. SUBTITLE
Display available DVD subtitles.
15. DISC MENU
Access the DVD root menu.
16. GUIDE
Display TV electronic program guide.
17. MTS
Set the audio mode.
18. TITLE
Access the DVD title menu.
19. LIGHT
Turn the front panel light on/off.

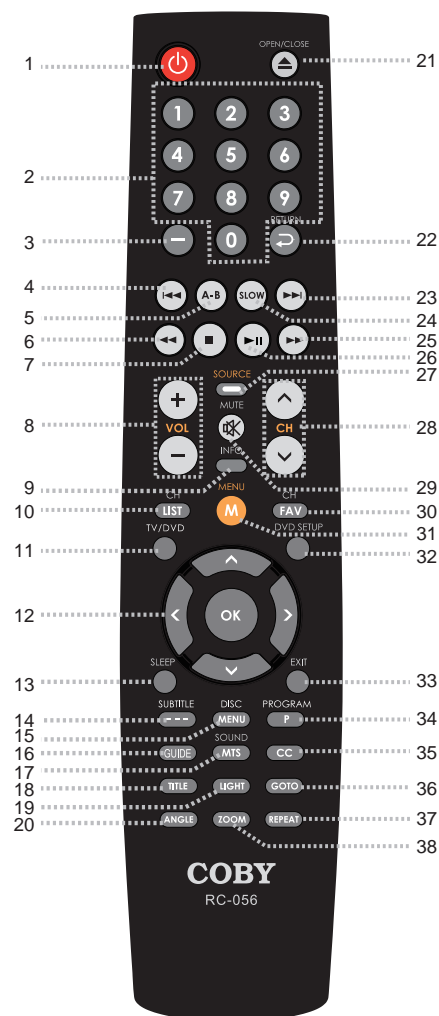

Remote Control

20. ANGEL
Some discs are recorded with Multi-angle, press this button to chose the desired viewing angle.
21. OPEN/CLOSE
In the DVD mode, press this button to take in/out disc automatically.
22. RETURN
Reveal the previously viewed channel.
23. Skip Forward
Repeatedly press this button to skip forward through DVD playback.
24. SLOW
Press this button to have current playback advanced in a slow motion, repeatedly press this button to change advance speed. You can press Play/Pause to pause current playback, and then repeatedly press this button to have playback moved step by step forward. To resume normal playback, press Play/Pause.
25. Fast Forward
Search fast forward through DVD playback.
26. Play/Pause
Press this button to start/hold DVD playback.
27. SOURCE
Display the working mode menu, use the up/down direction button to select a desired working mode, press OK to enter.
28. CH+/-
Tune to a higher or lower channel.
29. MUTE
Disable/enable audio output.
30. CH FAV
Display the TV favorite channels list.
31. MENU
Access the TV's main menu to adjust system options.
32. DVD SETUP
Display the DVD system menu.
33. EXIT
Exit the TV system menu.
34. PROGRAM
Display the DVD program menu.
35. CC
Repeatedly press this button to select a desired TV closed caption mode.
36. GOTO
Go to a desired section on a disc via information input.
37. REPEAT
Repeat DVD title/chaptor or CD tracks.
38. ZOOM
Repeatedly press this button to zoom in/out DVD images.

Remote Control

Remote Control

Preparation

- Remove the battery compartment cover located on the rear of the remote control. Insert 2 x “AAA” batteries, making sure to match their polarities (+/-) to the markings on the inside of the compartment. Replace the cover.
- Batteries in the remote will last for approximately 6 months under the normal use. Replace the batteries if the remote control does not work. Do not mix old with new batteries, or different types of batteries.
- Remove the batteries from the remote if it will not be used for a long period of time.

Warnings:

The battery used in this device may present a fire or chemical burn if mistreated. Do not recharge, disassemble, incinerate, or heat the battery (~212°F). Keep batteries away from children.

Using the Remote Control

To use the remote, point it at the remote sensor of the player. Operate the remote within 20 feet of the sensor and at an angle of ± 30 degrees.

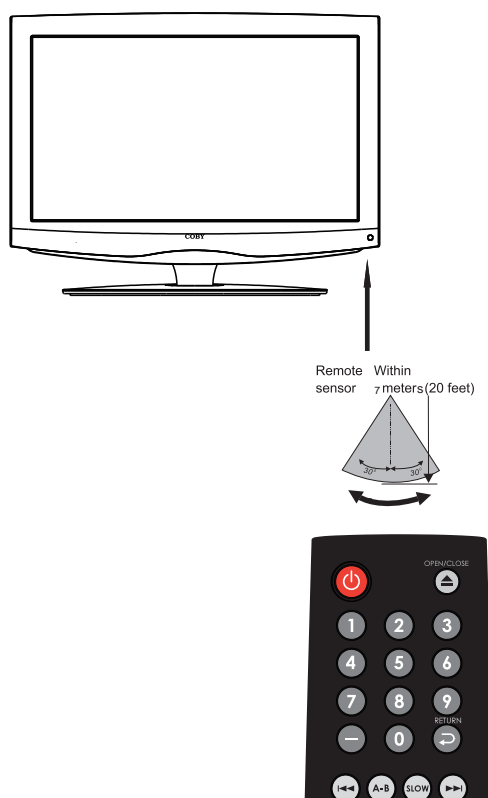

The operating distance may vary depending on the brightness around.

Notes:

1. Do not point bright lights directly at the remote control sensor.
2. Do not place objects between the remote control unit and the remote control sensor.
3. Do not use this remote control unit while simultaneously operating the remote control unit of any other equipment.

Cable Connections

Antenna/Power Connection

1. Connect TV RF sources to the Coaxial TV Antenna In jack. TV RF signals include: receiving antenna/ CATV net. You can use 75 Ohm coaxial cable to connect outdoor antenna.
2. Insert one end of the supplied power cord to the player's power jack and the other end to a 110-240V AC wall outlet.

Note: Antenna requirements for good digital TV reception are more important than those for analog NTSC TV reception. For this reason, a high-quality outdoor antenna is strongly recommended.

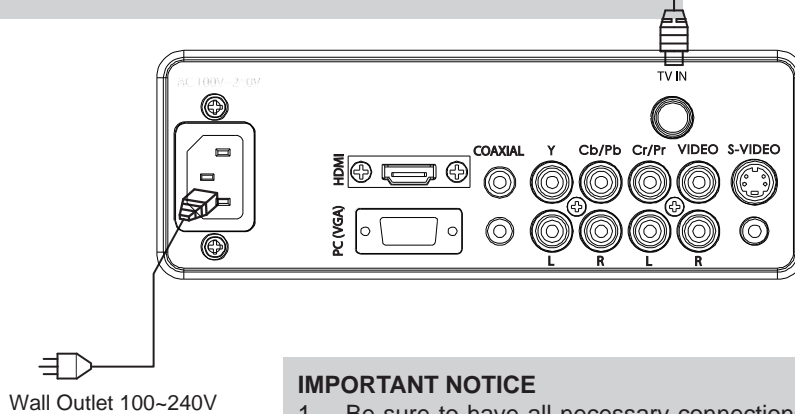

IMPORTANT NOTICE

1. Be sure to have all necessary connections properly done before connect the power supply.
2. If you have difficulty inserting the plug, turn it over and re-insert it.
3. If the product will not be used for a long period of time, disconnect the power. Note that the [POWER] button on the TV/remote control will place the TV into the standby mode, it does not disconnect the device from the main voltage. To completely disconnect the main voltage, please disconnect the power plug from the wall socket.

VGA Input - PC Connection

The VGA port of the TV is capable of accepting high-definition signals from computers with a VGA output jack. When used as a computer monitor, turn off both units, connect the VGA jack and the PC Audio In jack with a 15-Pin D-Sub cable and a 3.5mm stereo audio cable. The mentioned cables are not included with this product. After all necessary connections have been properly made, turn on both units and use the SOURCE button to select VGA.

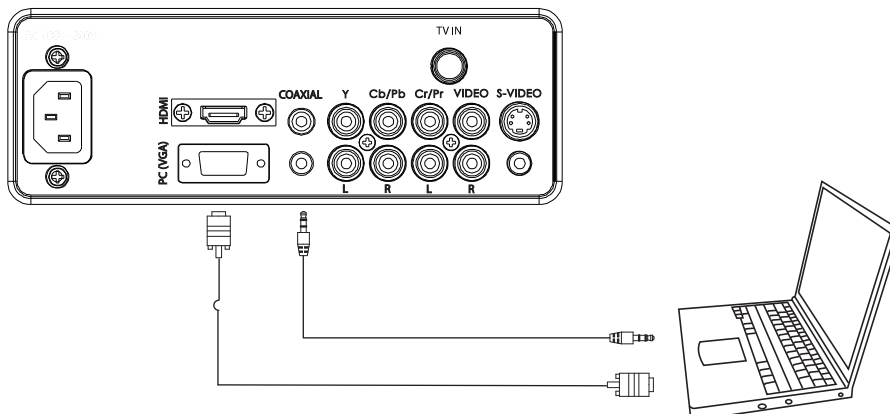

Cable Connections

Coaxial Output - Digital Audio Output Connector

If you are using the built-in TV tuner, you may want to play the TV audio through your stereo system for better sound quality. Select TV from the Input source menu to use this connection to watch TV with digital audio sound. (If this connection is inactive, sound will be output from the built-in speakers of the TV.)

A coaxial digital audio cable is required for this connection. After all necessary connections have been properly made, turn on both units, select the VGA mode with the SOURCE button. The coaxial cable is not included with this product.

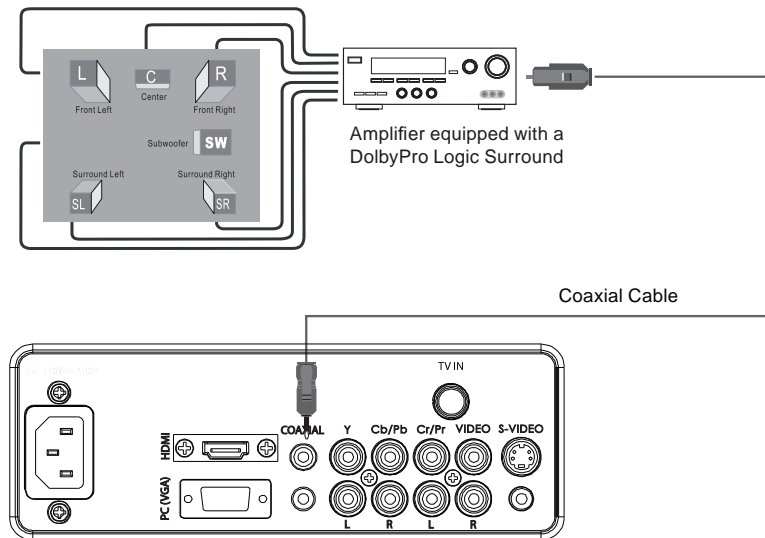

External Audio and Video Signal Input - HDMI, RCA, S-VIDEO, COMPONENT.

The player's AV function would enable users to view programs from external signal sources.

Four input modes are available for you to choose from, it ranks as below in regard to image definition: HDMI/ COMPONENT/S-VIDEO/RCA

NOTE:

We supply one set of AV cable and one piece of power cord with this product.

The white/red plug of the AV cable is for the audio L/R connection and the yellow plug for the video connection. The white/red plug of the AV cable can also be used separately to input the audio signal in the S-video/Component connection.

The rest of cable needed for other necessary connections are not included with this product, please check with electronic store.

IMPORTANT NOTICE - When work with external device,

- Be sure to have all necessary connections properly done before connect the power supply.
- Set the unit into the relative input/output mode to enable the signal pass.
- Refer to the manual of external sources as well.

Cable Connections

HDMI Input

HDMI (High Definition Multimedia Interface) is a new type of connection that transmits digital audio and video signals simultaneously over a single cable. A HDMI cable is required for the HDMI connection. This cable has a male HDMI Type-A connector on each end, carrying both digital video and audio.

These HDMI input connectors are capable of receiving video at resolutions up to 1080p (1080-progressive). After all necessary connections have been properly made, turn on both units, select the HDMI mode with the SOURCE button.

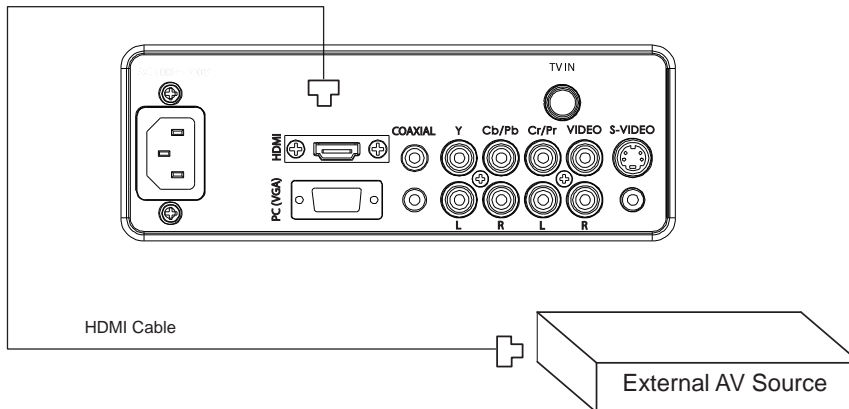

Component Input (Y Cb/Pb Cr/Pr)

The component port is capable of accepting high-definition signals from standard video sources. (e.g., cable/satellite boxes, DVD players, VCRs, etc.) A component cable is required to make this connection. The component video cable has three RCA plugs (red/blue/green) on each end and carries the video signal.

1. Connect the Y, Cb/Pb, Cr/Pr port by the component cable. Component cable is not included with this product.
2. Use the red and white plug of supplied AV cable to connect the R,L port for audio transmission.
3. After all necessary connections have been properly made, turn on both units, select the Component mode in the source menu with the SOURCE button.

Note: The component video jacks on your A/V device are sometimes labeled YPbPr, or YCbCr. For an explanation of component video, see your A/V device's user guide.

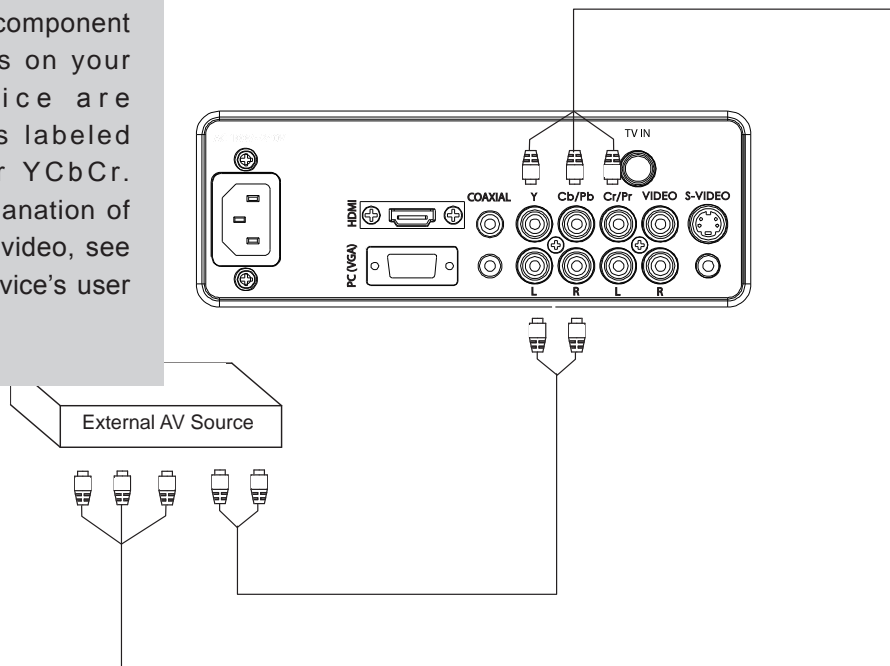

Cable Connections

S-Video Input

The S-Video port is capable of accepting signals from standard video sources. (e.g., cable/satellite boxes, DVD players, VCRs, etc.)

1. Connect the S-Video port by the S-Video cable to input the video signal. S-Video cable is not included with this product
2. Connect the L, R port by the white/red plug of the supplied AV cable to input the audio signal.
3. After all necessary connections have been properly made, turn on both units, select the S-Video mode with the SOURCE button.

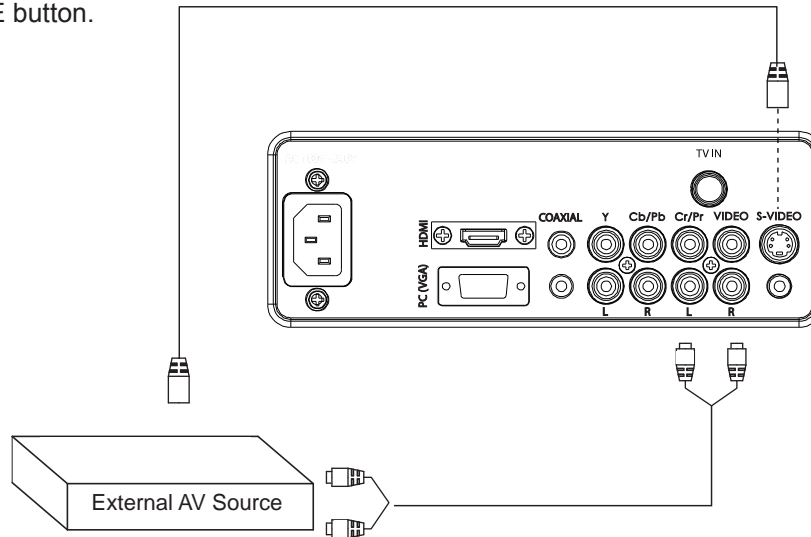

RCA Input

The CVBS port is capable of accepting signals from standard video sources (e.g., cable/satellite boxes, DVD players, VCRs, etc.) A composite A/V is required to make this connection. A composite A/V cable has a (yellow/white/red) on each end. The yellow plug is used for the video signal, and the white and red plugs are used for audio.

1. Connect the VIDEO port with the yellow plug of the supplied AV cable.
2. Connect the L, R port with the white/red plug of the supplied AV cable.
3. After all necessary connections have been properly made, turn on both units, select the AV mode with the SOURCE button.

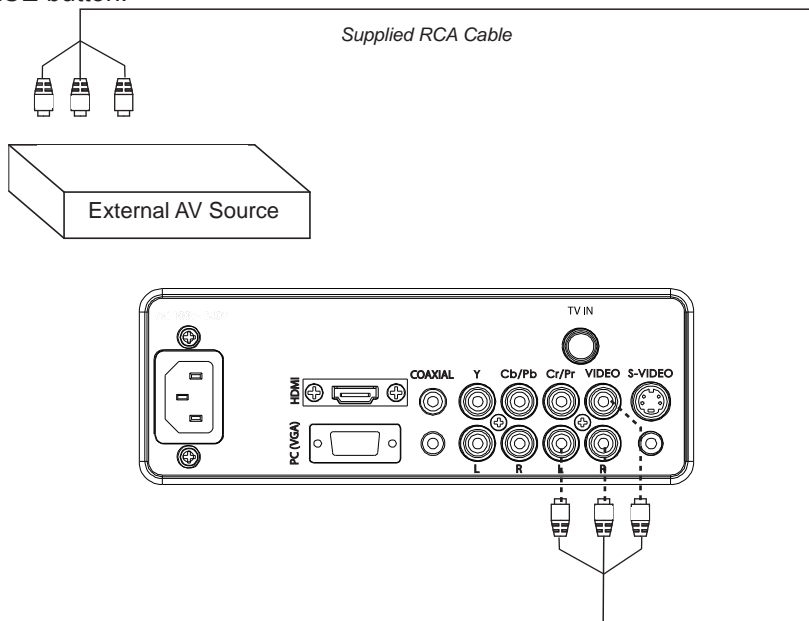

TV Function

Preparations

1. Connect cables.(Refer to the “Cable Connections” section for details).
2. Press the POWER button to turn on the player.
3. Select the TV signal mode, using the SOURCE button.
4. Press the CH+/- buttons to skip channels. Or you can press the number buttons to input channels directly. For an initial use, you need to scan channels under the Channels Menu.
In the Channels menu, select "Auto Channels Search", press OK to enter - - > Set the TV source as Antenna/Cable (ATV/DTV) - - > Select "Start", press OK to scan. To quit, press MENU.

System Setup Menu

Various features can be preset through the setup menu,

please read this section carefully.

- Press MENU to display the system menu window.
- Press the left/right direction button to select the desired menu, press the down direction button or the OK button to enter.

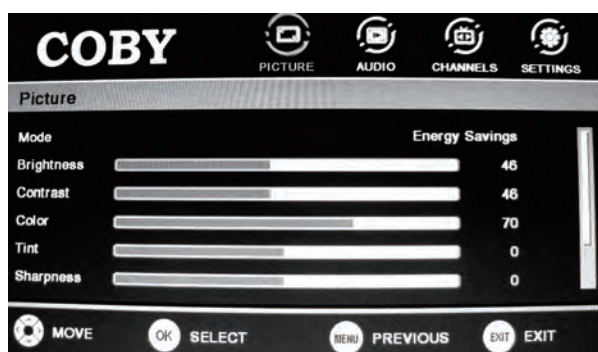

While working with the menu,

Always use direction buttons to select an option, press OK to confirm. Press MENU to back up/exit the setup menu, or press EXIT to quit.

Note: Menu option availability is dependent on the TV's current input source mode. Options that are grayed out are not selectable from the current mode.

Picture Menu

ITEM	DESCRIPTION
Mode	- Setup the picture mode as Custom/Sports/Theater/Energy Savings/Standard/Vivid.
Brightness/Contrast/Color/Tint/Sharpness	- Press the left/right direction button to adjust settings. When you select a picture Mode other than "Custom", these items are automatically given parameters to correspond with the chosen preset mode, so any change to these parameters would return the Mode setting to "Custom"
Advanced Video	- Press the right button to enter this option. Aspect Ratio - Set the screen aspect ratio as Normal/Zoom/Wide/Cinema. Color Temperature - Set color preference as Cool/Normal/Warm. Noise Reduction - Set the noise reduction function as Off/Low/Middle/Right. Adaptive Contrast - Set the adaptive contrast function on/off.
Reset Picture Settings	- Select this item and press OK or the right direction button to set all items under this menu to the factory default.

TV Function

Audio Menu

ITEM	DESCRIPTION
Mode	Set the audio mode as Custom/Standard/Theater/Music/News.
Treble/Bass/Balance	Press the left/right direction button to adjust settings. When you select an audio Mode other than "Custom", these items are automatically given parameters to correspond with the chosen preset mode, so any change to these parameters would return the Mode setting to "Custom"
Digital Audio/SPDIF	Set Digital Audio/SPIDIF as RAW/PCM.
MTS/SAP	Set the ATV audio mode as Mono/Stereo/SAP.
Audio Language	Set DTV audio languages.
Reset Audio Settings	Select this item and press OK or the right direction button to set all items under this menu to the factory default.

Channel Menu

ITEM	DESCRIPTION
Auto Channels Search	Scan and save all available channels automatically, overwriting previously stored channels. Select this item, press OK to enter - - > Set the TV source as Antenna/Cable - - > Select "Start", press OK to search. To quit, press MENU.
Add/Skip Channels	This option would enable users to avoid unwanted programs. Select this option, press OK to enter - - > Use direction buttons to select a channel you want to skip, press OK to confirm. To reveal the hidden channel, press OK again.
Favorite	Make a favorite channels collection. Select this option, press OK to enter - - > Use direction buttons to select a channel, press OK to mark it as a favorite channel. To disable the setting, press OK again.
Channel Labels	This option provides users with the ability to name their own programs. Select this option, press OK to enter - - > Locate a channel you want to put a label - - > When edit labels, use the left/right direction button to move left/right, use the up/down direction button to change characters - -> Press OK to display "Yes/No" box, select "Yes", press OK.
Channel Strength	Display the DTVsignal intensity.
Audio Only	Set audio output on/off.

TV Function

Settings Menu

ITEM	DESCRIPTION
Parental Controls	<p>You are required to enter the 4-digit password to access this option. The initial password is 0000.</p> <p>Button Lock - This option would enable users to lock buttons on the unit panel.</p> <p>Block Unrated TV -The option would enable users to lock unrated TV program.</p> <p>USA Parental Locks - Setup the US parental control. Select this option, press OK to enter, there are TV Rating and Movie Rating, Use direction buttons to select the rating level, press OK to confirm, press MENU to back up menu. TV(TV Rating) - Y, Y7, G, PG, 14, MA. MPAA(Movie Rating) - PG-13, R, NC-17, X, N/A, G, PG)</p> <p>Canadian Parental Locks - Setup the Canada parental control. Select this option, press OK to enter. There are English Rating and French Rating. Use direction buttons to select the rating level, press OK to confirm, press MENU to back up menu. English Rating - E, C, C8+, G, PG, 14+, 18+. French Rating - E, G, 8ans+, 13ans+, 16ans+, 18ans+.</p> <p>Change Password - To change the password, input the new password - - > Verify again. Please remember the password since the player's reset function would not revert the password.</p> <p>RRT5 Settings - Set the rating region table.</p>
Closed Caption	<p>Select this option, press the right direction button to access the Closed Caption menu. There are four options listed under the Closed Caption menu.</p> <p>Mode - Set the closed caption mode as CC Off/CC On/CC On Mute.</p> <p>Analog Caption - Set the analog caption type as CC1~3/Text1~4/Off.</p> <p>Digital Caption - Set the digital caption type as CS1~6/Off.</p> <p>Digital CC Settings - Press the right direction button to enter CC Settings menu, set "Style" as "Custom" to edit CC type to your own preference. Press MENU to back up.</p>

TV Function

Settings Menu

ITEM	DESCRIPTION
Time	<p>This option would enable users to adjust Date/Time information as well as to setup the sleep timer.</p> <p>Date/Time - Enter this option, set "Mode" as "Auto" / "Custom". When Mode is set as "Auto", system would adjust date/time information automatically after you select a desired Time Zone. When Mode is set as "Custom", you may customize year/month/day/Hour information by your own standards, using direction buttons to write in data.</p> <p>Sleep Timer - Unit will shut down automatically on Sleep Time. The available option is 5/10/15/30/45/60/90/120/180/240 min/ Off. The count down would start immediately after setting. You can access this function by repeatedly pressing the SLEEP button on the remote also. To check the timer left, press the SLEEP button on the remote once. To cancel the sleep timer, set the timer to Off.</p>
Menu Settings	<p>Transparency - Set OSD (On-Screen-Display) transparency.</p> <p>Language - Set OSD languages.</p>
Computer Settings	<p>This option is available for the VGA mode and to be used to adjust PC parameters.</p>
Reset to Default	<p>Set the unit to the factory default.</p>

AV Function

The player's AV input function would enable user to view programs from external signal sources. When input AV signals, read the user's manual of the external device as well.

1. Connect the external AV signal source. Refer to the "Cable Connection" section for details
2. Use the SOURCE button to select the relevant AV mode (AV, S-Video, Component, HDMI).

System Setup Menu

Various features can be preset through the setup menu, please read this section carefully.

- Press MENU to display the system menu window.
- Press the left/right direction button to select the desired menu, press the down direction button or the OK button to enter.

While working with the menu,

Always use direction buttons to select an option, press OK to confirm. Press MENU to back up/exit the setup menu, or press EXIT to quit.

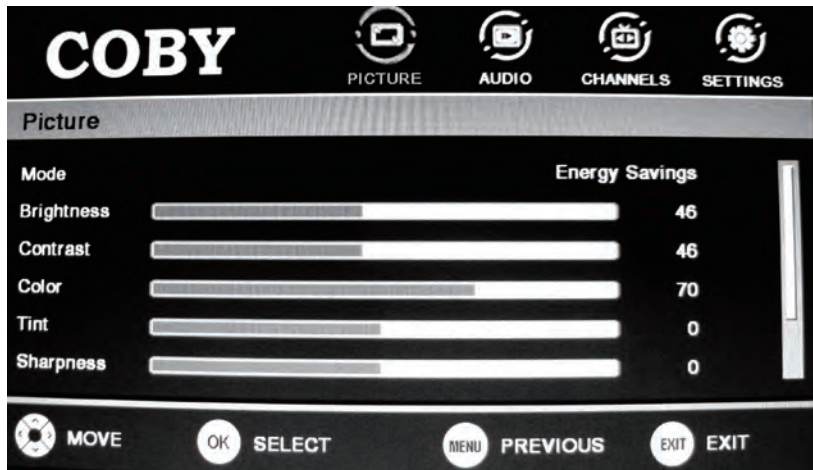

NOTE: Please see the TV section for menu descriptions.

Note: Menu option availability is dependent on the TV's current input source mode. Options that are grayed out are not selectable from the current mode.

PC Function

You can use the unit's TFT LCD as your computer's monitor.

1. Shut down the unit and the computer, connect the VGA jack and PC Audio In jack. See the "Cable Connection" section.
2. Turn on units and use the SOURCE button to select VGA

System Setup Menu

Various features can be preset through the setup menu, please read this section carefully.

- Press MENU to display the system menu window.
- Press the left/right direction button to select the desired menu, press the down direction button or the OK button to enter.

While working with the menu,

Always use direction buttons to select an option, press OK to confirm. Press MENU to back up/exit the setup menu, or press EXIT to quit.



Adjust the PC Screen

Upon switching to the PC mode, the monitor will be automatically regulated for a proper functioning. If the result is not up to your expectation, please adjust the monitor manually via the "Computer Settings" menu which is listed under the "Settings" menu.

DVD Operation

Preparation

After all necessary connections have been made, press POWER to turn on the player and then press the MODE button to select DVD. The following discs can be read by the player : DVD /CD / MP3 /JPEG.

Disc Loading

1. Put the disc slightly into the disc tray.
2. The disc will be taken automatically into the tray.

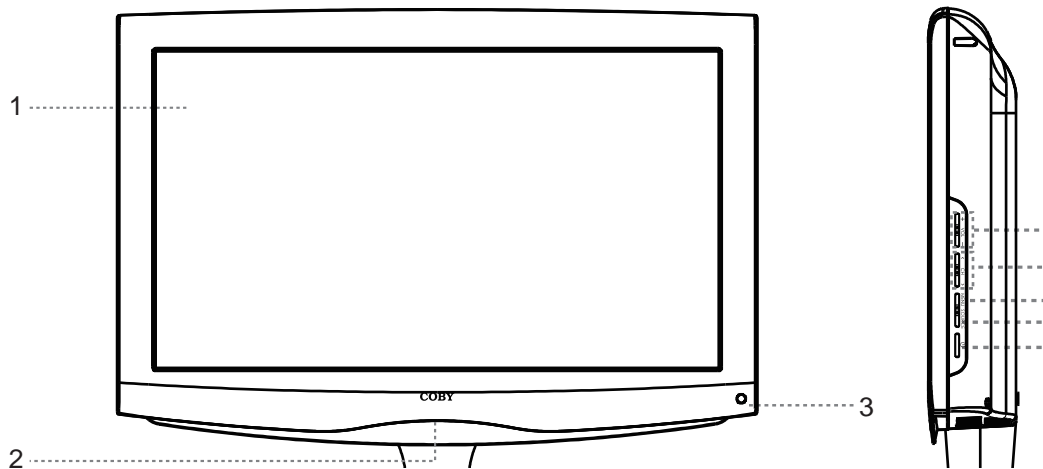

Warning: Do not play poor quality discs that may damage the player's lens.

DVD Playback

MENU

Normally a DVD disc consists of several titles and chapters. Once disc data is recognized by the player, a root menu will be displayed on the screen . Press the direction buttons to select the desired title/chapter from the menu and press OK to play. During playback, press DISC MENU to return to the root menu. Some discs start playback automatically.

SUBTITLE

Press the SUBTITLE button to select subtitle languages for multi-subtitle discs.

ANGLE

Press the ANGLE button to select the available viewing angle. Some discs are recorded from various camera positions, which lets you enjoy the same scene from different perspectives. In this case, you'll usually find a marking on the DVD sleeve.

VOLUME

During playback, press the VOL+ button to increase the volume and press the VOL- button to decrease the volume.

DVD Operation

CD Playback

The player will play all tracks on a CD disc by default.

MP3 Playback

1. Load a disc into the disc tray.
2. It will start playback automatically. Or press direction buttons to select a file from the menu and press OK or PLAY/PAUSE button to start playback. Press left/right button to enter /exit file folders.
3. Press the STOP button to stop playback.

JPEG Playback

JPEG is a common picture format that requires small amounts of storage per image and has low loss in resolution. Hundreds of pictures can be stored on a disc in this format. In order to view JPEG photo albums, you can ask your film development company to make a "PICTURE CD" when they develop your film.

Normal Playback

Load a JPEG disc in.

Press the direction buttons to select the target file and press OK to access.

Picture Rotation

There are four kinds of rotational modes: Inversion, Enantiomorphism, rotate left and rotate right.

Press direction buttons to select:

"UP" ----- Inversion/Normal

"DOWN" ----- Enantiomorphism/Normal

"LEFT" ----- Rotate left

"RIGHT" ----- Rotate right

Zoom

Press ZOOM button to zoom in/out picture.

Press direction buttons to move the zoomed picture.

During playback, press the STOP button to return to the previous menu.

NOTE: Depending on how the disc was made, a JPEG disc may allow playback, but not rotation or zooming of the images.

USB/Card Access

Set the unit into the DVD mode, plug the USB or Card into the corresponding slot, the player starts reading data. When the USB/Card is detected, the screen displays a working menu, press the direction buttons to select the file, press OK to start playback. To disconnect the device, just unplug it from the port when it is not in working.

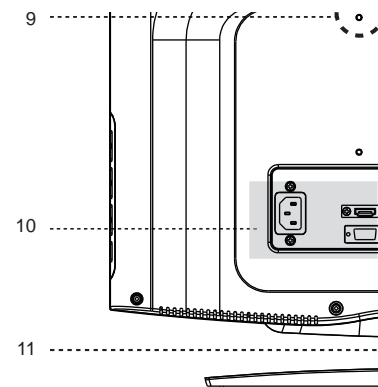

Playback Function

Slow Playback

Slow Motion

Press the SLOW button on the remote to have current playback advanced in a slow motion, repeatedly press this button to change speed as below.

PLAY — SF1/2 — SF1/3 — SF1/4 — SF1/5 — SF1/6 — SF1/7

Step by Step

Press Play/Pause to pause current playback, and then repeatedly press SLOW to have playback moved step by step forward. To resume normal playback, press Play/Pause.

Zoom Function

Repeatedly press the ZOOM button to achieve the following zoom effect.

ZOOM 2 - ZOOM3 - ZOOM 4 - ZOOM1/2 - ZOOM1/3 - ZOOM1/4 - ZOOM:OFF

NOTE: There is no zoom function for MP3 or CD discs.

Programming Chapters/Tracks

You can store up to 16 programs.

1. Press the PROGRAM (P) button to display the program menu.

e.g. DVD Mode

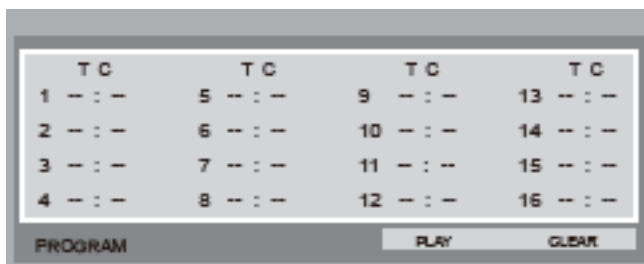

2. Press direction buttons to move between input fields and press number buttons to input data.
3. Press direction buttons to select "Play " and press OK to start playback.
4. To clear, select "CLEAR" from the menu and press OK.
5. To quit, press the Program button.

DVD Setup

Various features can be preset through the DVD setup menu. Press the DVD SETUP button to show the DVD menu.

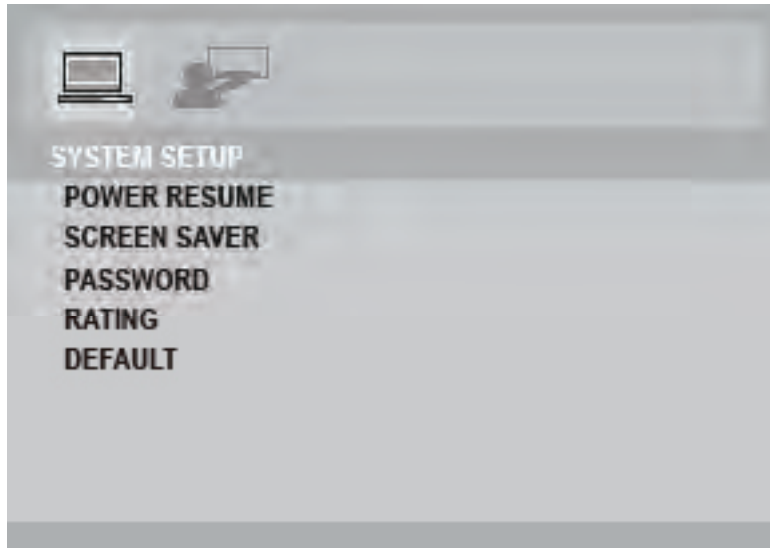

While working with the setup menu:

1. Press the direction buttons to select the desired item.
2. Press the right direction button or the OK button to confirm settings.
3. To exit, press DVD SETUP again.

System Setup

1. **Power Resume** - Set the power resume function On/Off. The default setting is Off.
2. **Screen Saver** - Set the Screen Saver ON/OFF. The default setting is On. The screen saver is useful to prevent your display from becoming damaged. If the Screen Saver is set ON, the screen saver picture appears when you leave the player in the stop mode for about a few minutes. Press any button on the unit/remote to exit the screen saver.
3. **Password** - Move the cursor to the PASSWORD prompt and press OK. Input the password 8888, if it is the first use. After confirmation, you will be required to input a new 4-digit code, and verify again.
4. **Rating** - There are eight levels of Parental Control. Level one opens discs to people of all ages, level eight is suitable only for adults. To change the parental control setting, a 4-digit code is required to be input first. (The default code is 8888). When the input code is confirmed, the level setting menu will appear, select the appropriate level by the UP/DOWN button and press OK to confirm.
5. **Default** - This function allows you to set the unit back to the factory default.

DVD Setup

Language Setup

Item	Instruction	Default
OSD Language	Setup the OSD language.	English
Audio Lang	Setup the audio language.	English
Subtitle Lang	Setup the subtitle language. When OFF is selected, the subtitle will not be displayed.	English
Menu Lang	Setup the menu language.	English

Specification

TFDVD 2425

TFT Panel Characteristic	Active Area	23.6"	
	Resolution	1920x1080	
	Display Color	16.7M	
	Pixel Pitch	0.2715(H) x 0.2715(V)	
TV Charactoristic	TV System	ATSC/NTSC	
	Antenna Impedance	75Ω	
Standard	Standby Power Consumption	<1W	
	Power Consumption	AC100-240V 50/60Hz	
		On Working	55W(Max)
		Speaker	2x(4Ω,5W)
	Operating Temperature Range	0°C-40°C	
	Wall Mounting	VESA M 4	

TFDVD1995(S2)

TFT Panel Characteristic	Active Area	18.5"	
	Resolution	1366X768	
	Display Color	6 bit -16.7 M	
	Pixel Pitch	0.3(H) x 0.3(V)	
TV Charactoristic	TV System	ATSC/NTSC	
	Antenna Impedance	75Ω	
Standard	Standby Power Consumption	<1W	
	Power Consumption	100-240V 50/60Hz	
		On Working	45W(Max)
		Speaker	2x(4Ω,5W)
	Operating Temperature Range	0°C-40°C	
	Wall Mounting	VESA M 4	

Specification

TFDVD2295(S2)

TFT Panel Characteristic	Active Area	21.6"	
	Resolution	1366X768	
	Display Color	8 bit - 16.7M	
	Pixel Pitch	0.345(H) x 0.345(V)	
TV Charactoristic	TV System	ATSC/NTSC	
	Antenna Impedance	75Ω	
Standard	Standby Power Consumption	<1W	
	Power Consumption	100-240V 50/60Hz	
		On Working	50W(Max)
		Speaker	2x(4Ω,5W)
	Operating Temperature Range	0°C-40°C	
Wall Mounting	VESA M 4		

TFDVD1595(S3)

TFT Panel Characteristic	Active Area	15.6"	
	Resolution	1366X768	
	Display Color	6-bit, 262.144 colors	
	Pixel Pitch	0.252(H) x 0.252(V)	
TV Charactoristic	TV System	ATSC/NTSC	
	Antenna Impedance	75Ω	
Standard	Power Consumption	100-240V 50/60Hz	
		On Working	30W(Max)
		Speaker	2x(4Ω,3W)
	Operating Temperature Range	0°C-40°C	
	Wall Mounting	VESA M4 75X75 MM	

COBY®

TFT LCD Widescreen Television

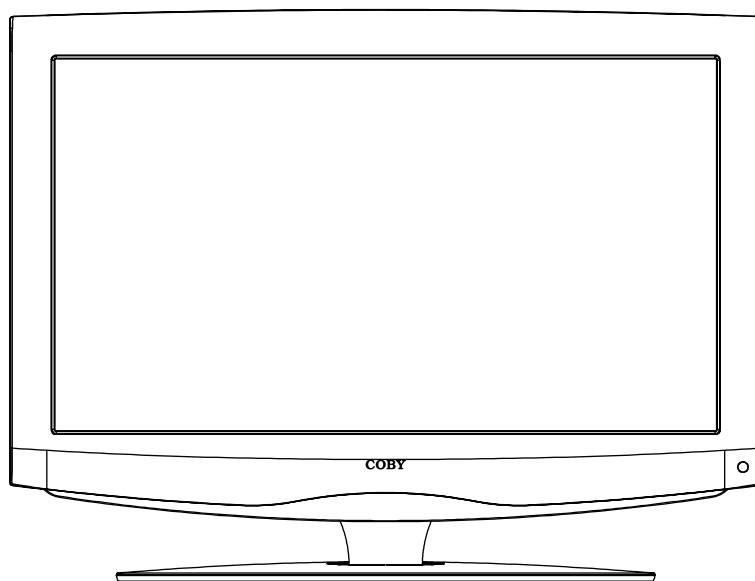

Instruction Manual

TFDVD2495/2295(S2)/1995(S2)/1595(S3)

Please read this manual carefully before connection and use

Free Manuals Download Website

<http://myh66.com>

<http://usermanuals.us>

<http://www.somanuals.com>

<http://www.4manuals.cc>

<http://www.manual-lib.com>

<http://www.404manual.com>

<http://www.luxmanual.com>

<http://aubethermostatmanual.com>

Golf course search by state

<http://golfingnear.com>

Email search by domain

<http://emailbydomain.com>

Auto manuals search

<http://auto.somanuals.com>

TV manuals search

<http://tv.somanuals.com>