

DREMEL®

Instructional Safety Manual

300 Series

High Speed Rotary Tool



DREMEL®

03-5415317

<http://www.dremel.com>

Dremel brand products are manufactured and sold by the
Dremel Division of Robert Bosch Tool Corporation

GENERAL SAFETY RULES

⚠ WARNING Read all instructions. Failure to follow all instructions listed below may result in electric shock, fire and/or serious injury. The term “power tool” in all of the warnings listed below refers to your mains-operated (corded) power tool or battery-operated (cordless) power tool.

SAVE THESE INSTRUCTIONS

Work area safety

Keep work area clean and well lit. Cluttered or dark areas invite accidents.

Do not operate power tools in explosive atmospheres, such as in the presence of flammable liquids, gases or dust. Power tools create sparks which may ignite the dust or fumes.

Keep children and bystanders away while operating a power tool. Distractions can cause you to lose control.

Electrical safety

Power tool plugs must match the outlet. Never modify the plug in any way. Do not use any adapter plugs with earthed (grounded) power tools. Unmodified plugs and matching outlets will reduce risk of electric shock.

Avoid body contact with earthed or grounded surfaces such as pipes, radiators, ranges and refrigerators. There is an increased risk of electric shock if your body is earthed or grounded.

Do not expose power tools to rain or wet conditions. Water entering a power tool will increase the risk of electric shock.

Do not abuse the cord. Never use the cord for carrying, pulling or unplugging the power tool. Keep cord away from heat, oil, sharp edges or moving parts. Damaged or entangled cords increase the risk of electric shock.

When operating a power tool outdoors, use an extension cord suitable for outdoor use. Use of a cord suitable for outdoor use reduces the risk of electric shock.

Do not use AC only rated tools with a DC power supply. While the tool may appear to work, the electrical components of the AC rated tool are likely to fail and create a hazard to the operator.

If operating the power tool in damp locations is unavoidable a Ground Fault

Circuit Interrupter (GFCI) must be used to supply the power to your tool. GFCI and personal protection devices like electrician's rubber gloves and footwear will further enhance your personal safety.

Personal safety

Stay alert, watch what you are doing and use common sense when operating a power tool. Do not use a power tool while you are tired or under the influence of drugs, alcohol or medication. A moment of inattention while operating power tools may result in serious personal injury.

Use safety equipment. Always wear eye protection. Safety equipment such as dust mask, non-skid safety shoes, hard hat, or hearing protection used for appropriate conditions will reduce personal injuries.

Avoid accidental starting. Ensure the switch is in the off-position before plugging in. Carrying power tools with your finger on the switch or plugging in power tools that have the switch on invites accidents.

Remove any adjusting key or wrench before turning the power tool on. A wrench or a key left attached to a rotating part of the power tool may result in personal injury.

Do not overreach. Keep proper footing and balance at all times. This enables better control of the power tool in unexpected situations.

Dress properly. Do not wear loose clothing or jewelry. Keep your hair, clothing and gloves away from moving parts. Loose clothes, jewelry or long hair can be caught in moving parts.

If devices are provided for the connection of dust extraction and collection facilities, ensure these are connected and properly used. Use of these devices can reduce dust-related hazards.

Keep handles dry, clean and free from oil and grease. Slippery hands cannot safely control the power tool.

Power tool use and care

Do not force the power tool. Use the correct power tool for your application. The correct power tool will do the job better and safer at the rate for which it was designed.

Do not use the power tool if the switch does not turn it on and off. Any power tool that cannot be controlled with the switch is dangerous and must be repaired.

Disconnect the plug from the power source and/or the battery pack from the power tool before making any adjustments, changing accessories, or storing power tools. Such preventive safety measures reduce the risk of starting the power tool accidentally.

Store idle power tools out of the reach of children and do not allow persons unfamiliar with the power tool or these instructions to operate the power tool. Power tools are dangerous in the hands of untrained users.

Maintain power tools. Check for misalignment or binding of moving parts, breakage of parts and any other condition that may affect the power tool operation. If damaged, have the power tool repaired before use. Many accidents are caused by poorly maintained power tools.

Keep cutting tools sharp and clean. Properly maintained cutting tools with sharp cutting edges are less likely to bind and are easier to control.

Use the power tool, accessories and tool bits etc., in accordance with these instructions and in the manner intended for the particular type of power tool, taking into account the working conditions and the work to be performed. Use of the power tool for operations different from those intended could result in a hazardous situation.

Use clamps or other practical way to secure and support the workpiece to a stable platform. Holding the work by hand or against your body is unstable and may lead to loss of control.

Service

Have your power tool serviced by a qualified repair person using only identical replacement parts. This will ensure that the safety of the power tool is maintained.

Develop a periodic maintenance schedule for your tool. When cleaning a tool be careful not to disassemble any portion of the tool since internal wires may be misplaced or pinched or safety guard return springs may be improperly mounted. Certain cleaning agents such as gasoline, carbon tetrachloride, ammonia, etc. may damage plastic parts.

SAVE THESE INSTRUCTIONS

SAFETY RULES FOR ROTARY TOOL

Hold tool by insulated gripping surfaces when performing an operation where the cutting tool may contact hidden wiring or its own cord. Contact with a "live" wire will make exposed metal parts of the tool "live" and shock the operator.

Use clamps or other practical way to secure and support the workpiece to a stable platform. Holding the work by hand or against your body is unstable and may lead to loss of control.

Accessories must be rated for at least the speed recommended on the tool warning label. Wheels and other accessories run-

ning over rated speed can fly apart and cause injury.

If cutting into existing walls or other blind areas where electrical wiring may exist is unavoidable, disconnect all fuses or circuit breakers feeding this worksite.

Do not operate the flexible shaft with a sharp bend. Over bending the shaft can generate excessive heat on the jacket or hand piece. The recommended minimum is 6" radius.

Always disconnect the power cord from the power source before making any adjustments or attaching any acces-

SAFETY RULES FOR ROTARY TOOL (CONTINUED)

sories. You may unexpectedly cause the tool to start leading to serious personal injury.

Be aware of the switch location, when placing the tool down or when picking the tool up. You may accidentally activate the switch.

Always hold the hand piece firmly in your hands during the start-up. The reaction torque of the motor, as it accelerates to full speed, can cause the shaft to twist.

Always wear safety goggles and dust mask. Use only in well ventilated area. Using personal safety devices and working in safe environment reduces risk of injury.

After changing the bits or making any adjustments, make sure the collet nut and any other adjustment devices are securely tightened. Loose adjustment device can unexpectedly shift, causing loss of control, loose rotating components will be violently thrown.

Do not reach in the area of the spinning bit. The proximity of the spinning bit to your hand may not always be obvious.

Allow brushes to run at operating speed for at least one minute before using wheel. During this time no one is to stand in front or in line with the brush. Loose bristles or wires will be discharged during the run-in time.

Wire and bristle brushes must never be operated at speeds greater than 15,000/min. Direct the discharge of the spinning wire brush away from you. Small particles and tiny wire fragments may be discharged at high velocity during the "cleaning" action with these brushes and may become imbedded in your skin. Bristles or wires will be discharged from the brush at high speeds.

Carefully handle both the tool and individual grinding wheels to avoid chipping or cracking. Install a new wheel if tool is dropped while grinding. Do not use a wheel that may be damaged. Fragments from a wheel that bursts during operation will fly away at great velocity possibly striking you or bystanders.

Never use dull or damaged bits. Sharp bits must be handled with care. Damaged bits can snap during use. Dull bits require more force to push the tool, possibly causing the bit to break.

Use clamps to support workpiece whenever practical. Never hold a small work-

piece in one hand and the tool in the other hand while in use. Allow for sufficient space, at least 6", between your hand and the spinning bit. Round material such as dowel rods, pipes or tubing have a tendency to roll while being cut, and may cause the bit to "bite" or jump toward you. Clamping a small workpiece allows you to use both hands to control the tool.

Inspect your workpiece before cutting. When cutting irregularly shaped workpieces, plan your work so it will not slip and pinch the bit and be torn from your hand. For example, if carving wood, make sure there are no nails or foreign objects in the workpiece. Nails or foreign objects can cause the bit to jump.

Never start the tool when the bit is engaged in the material. The bit cutting edge may grab the material causing loss of control of the cutter.

Avoid bouncing and snagging the wheel, especially when working corners, sharp edges etc. This can cause loss of control and kick-back.

The direction of feed with the bit into the material when carving, routing or cutting is very important. Always feed the bit into the material in the same direction as the cutting edge is exiting from the material (which is the same direction as the chips are thrown). Feeding the tool in the wrong direction, causes the cutting edge of the bit to climb out of the work and pull the tool in the direction of this feed.

If the workpiece or bit becomes jammed or bogged down, turn the tool "OFF" by the switch. Wait for all moving parts to stop and unplug the tool, then work to free the jammed material. If the switch to the tool is left "ON" the tool could restart unexpectedly causing serious personal injury.

Do not leave a running tool unattended, turn power off. Only when tool comes to a complete stop it is safe to put it down.

Do not grind or sand near flammable materials. Sparks from the wheel could ignite these materials.

Do not touch the bit or collet after use. After use the bit and collet are too hot to be touched by bare hands.

Regularly clean the tool's air vents with compressed air. Excessive accumulation of powdered metal inside the motor housing may cause electrical failures.

SAFETY RULES FOR ROTARY TOOL (CONTINUED)

Do not allow familiarity gained from frequent use of your rotary tool to become commonplace. Always remember that a careless fraction of a second is sufficient to inflict severe injury.

Do not alter or misuse tool. Any alteration or modification is a misuse and may result in serious personal injury.

This product is not intended for use as a dental drill, in human or veterinary medical applications. Serious injury may result.

When using the steel saws, cutoff wheels, high speed cutters or tungsten carbide cutters, always have the work securely clamped. Never attempt to hold the work with one hand while using any of these accessories. The reason is that these wheels will grab if they become slightly canted in the groove, and can kickback causing loss of control resulting in serious injury. Your second hand should be used to steady and guide the hand holding the tool. When a cutoff wheel grabs, the wheel itself usually

breaks. When the steel saw, high speed cutters or tungsten carbide cutter grab, it may jump from the groove and you could lose control of the tool.

⚠ WARNING Some dust created by power drilling and other construction activities, contains chemicals known to cause cancer, birth defects or other reproductive harm. Some examples of these chemicals are:

- Lead from lead-based paints,
- Crystalline silica from bricks and cement and other masonry products, and
- Arsenic and chromium from chemically treated lumber.

Your risk from these exposures varies, depending on how often you do this type of work. To reduce your exposure to these chemicals, work in a well ventilated area, and work with approved safety equipment, such as those dust masks that are specially designed to filter out microscopic particles.

GETTING TO KNOW YOUR ROTARY TOOL

Unpacking & Checking Contents

▲ WARNING To avoid injury from unexpected starting or electrical shock, always remove plug from wall outlet when tool is not in use.

Separate all loose parts from packing materials and check each item with the contents listed on the carton to make sure all items are accounted for before discarding any packing material.

Description

The 300 Series rotary tool consists of a small, but effective AC universal motor construction that incorporates high speed to complete cutting, drilling, carving, sharpening, etching, grinding, sanding, shaping, polishing, cleaning and much more.

The 300 Series rotary tool has high speeds of 10,000 – 37,000 rpms, while a typical drill only has a top speed of 2,500 rpms. The high speeds allows your Dremel rotary tool to

perform with high performing results. There is no need to apply pressure to your tool, it is the speed of rotary tool that will complete even the toughest task.

Your Dremel's rotary tool performance does depend upon the accessories that you use. Due to the high speeds of your rotary tool, we highly recommend that you always use Dremel accessories and attachments for the best results. Dremel's accessories and attachments go through very controlled and extensive testing and must meet very high standards before being approved. From drill bits to router bits, felt wheels to wire and nylon brushes, cut-off wheels to sanding bands, engravers to cutting bits and more.

Thus, the success you will experience with your Dremel rotary tool system – rotary tool, accessories and attachments; unlimited versatility for you and your projects no matter where you are.

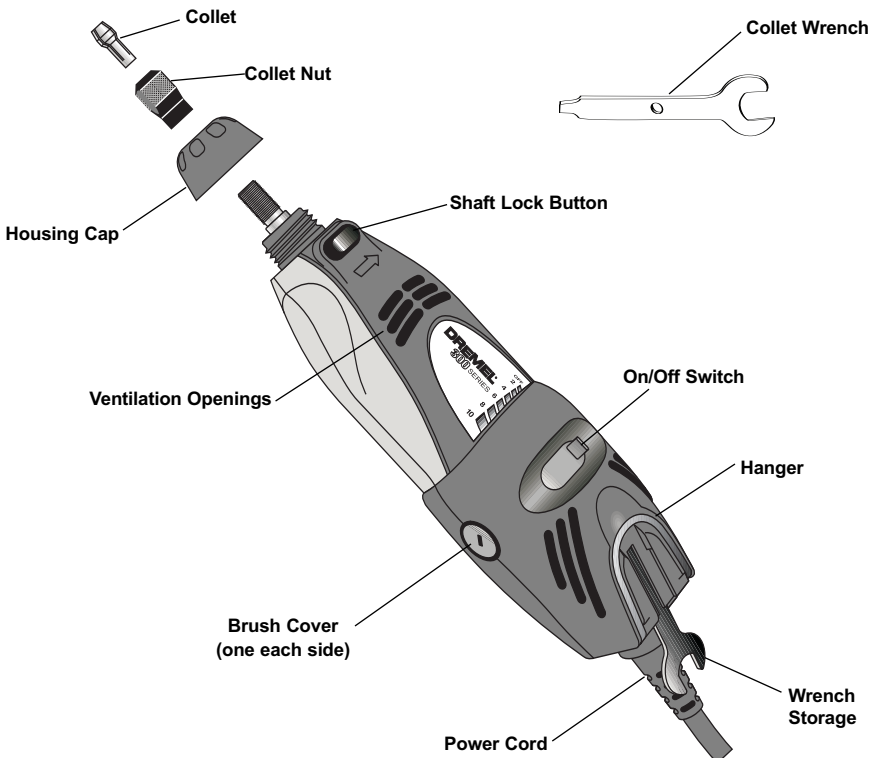

SPECIFICATIONS

General Specifications

Voltage Rating . . . 230-240 V ~, 50-60 Hz
 Amperage Rating 1.15 A
 No Load Speed . . . N₀ 10,000-37,000/min
 Collet Capacity 1/32", 1/16", 3/32", 1/8"

Motor Specifications

This Rotary Tool utilizes a variable high-speed RPM motor. It is wired for operation on 230-240 volts, 50-60 Hz. alternating current. Before connecting the motor cord to wall outlet, make certain the power switch is in the OFF position and be sure the electric current is of the same characteristics as stamped on the Rotary Tool nameplate.

Connection To A Power Source

⚠ DANGER To avoid electric shock, do not touch the metal prongs on the plug when installing or removing the plug to or from the outlet.

⚠ DANGER If power cord is worn, cut or damaged in any way, have it replaced immediately to avoid shock or fire hazard.

Extension Cords

If an extension cord is necessary, a cord with adequate size conductors that is capable of carrying the current necessary for your tool must be used. This will prevent excessive voltage drop, loss of power or overheating.

RECOMMENDED SIZES OF EXTENSION CORDS









240 VOLT ALTERNATING CURRENT TOOLS

NOTE: The smaller the gauge number, the heavier the cord.

Tool's Ampere Rating	Cord Size in A.W.G.				Wire Sizes in mm ²			
	Cord Length in Feet				Cord Length in Meters			
	25	50	100	150	15	30	60	120
1-6	18	16	16	14	.75	.75	1.5	2.5
6-8	18	16	14	12	.75	1.0	2.5	4.0
8-10	18	16	14	12	.75	1.0	2.5	4.0
10-12	16	16	14	12	1.0	2.5	4.0	—
12-16	14	12	—	—	—	—	—	—

SYMBOLS

IMPORTANT! Some of the following symbols may be used on your tool. Please study them and learn their meaning. Proper interpretation of these symbols will allow you to operate the tool better and safer.

Symbol	Name	Designation/Explanation
V	Volts	Voltage (potential)
A	Amperes	Current
Hz	Hertz	Frequency (cycles per second)
W	Watt	Power
kg	Kilograms	Weight
min	Minutes	Time
s	Seconds	Time
∅	Diameter	Size of drill bits, grinding wheels, etc.
n₀	No load speed	Rotational speed, at no load
.../min	Revolutions or reciprocation per minute	Revolutions, strokes, surface speed, orbits etc. per minute
0	Off position	Zero speed, zero torque...
1, 2, 3, ... I, II, III,	Selector settings	Speed, torque or position settings. Higher number means greater speed
	Infinitely variable selector with off	Speed is increasing from 0 setting
	Arrow	Action in the direction of arrow
	Alternating current	Type or a characteristic of current
	Direct current	Type or a characteristic of current
	Alternating or direct current	Type or a characteristic of current
	Class II construction	Designates Double Insulated Construction tools.
	Earthing terminal	Grounding terminal
	Warning symbol	Alerts user to warning messages
	Ni-Cad RBRC seal	Designates Ni-Cad battery recycling program



This symbol designates that this tool is listed by Underwriters Laboratories.



This symbol designates that this tool is listed to Canadian Standards by Underwriters Laboratories.



N 153

This symbol designates that this tool complies to Australian Standards.



This symbol designates that this tool is listed by the Canadian Standards Association, and is listed to US Standards by CSA.



This symbol designates that this tool is listed by Underwriters Laboratories, and listed to Canadian Standards by Underwriters Laboratories.

ASSEMBLY

⚠ WARNING Always unplug rotary tool before changing accessories, changing collets, or servicing the tool.

Collets

The Dremel™ accessories available for the rotary tool come with various shank sizes.

Four size collets are available to accommodate the different shank sizes. Collet sizes are identified by the rings on the back of the collet:

- 1/32" collet has 1 ring (No. 483)
- 1/16" collet has 2 rings (No. 482)
- 3/32" collet has 3 rings (No. 481)
- 1/8" collet has no rings (No. 480)

NOTE: Some rotary tool kits may not include all four collet sizes. Collets are available separately.

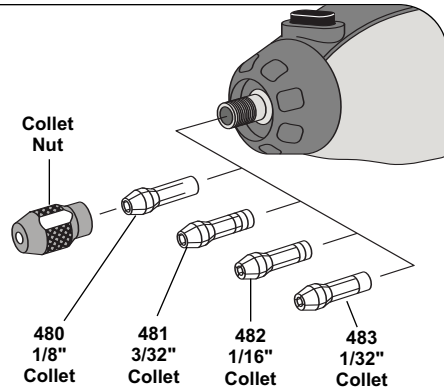

⚠ CAUTION Always use the collet which matches the shank size of the accessory you plan to use. Do not force a larger diameter shank into a smaller collet.

Changing Collets

1. Press the shaft lock button, hold down and rotate the shaft by hand until it engages the shaft.

⚠ WARNING Do not engage the shaft lock button while rotary tool is running.

2. With the shaft lock button engaged, loosen and remove the collet nut. Use the collet wrench if necessary.
3. Remove the collet by pulling it free from the shaft.
4. Install the appropriate size collet fully into the shaft and reinstall the collet nut finger tight. Do not fully tighten the nut when there is no bit or accessory installed.

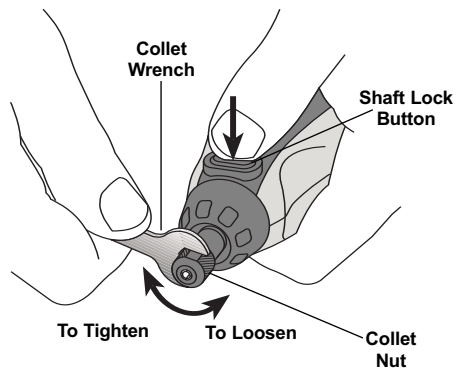

Changing Accessories

1. Press the shaft lock button and rotate the shaft by hand until it engages the shaft lock.

⚠ WARNING Do not engage the shaft lock button while rotary tool is running.

2. With the shaft lock button engaged, loosen (do not remove) the collet nut. Use the collet wrench if necessary.
3. Insert the bit or accessory shank fully into the collet.
4. With the shaft lock button engaged, finger tighten the collet nut until the bit or accessory shank is gripped by the collet.

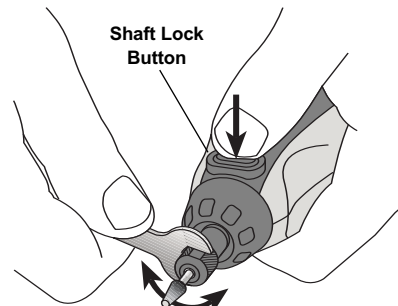

NOTE: Be sure to read the instructions supplied with your Dremel™ accessory for further information on its use.

OPERATION

Learning To Use the Rotary Tool

Getting the most out of your rotary tool is a matter of learning how to let the speed and the feel of the tool in your hands work for you.



The first step in learning to use the rotary tool is to get the “feel” of it. Hold it in your hand and feel its weight and balance. Feel the taper of the

housing. This taper permits the tool to be grasped much like a pen or pencil. The unique comfort grip on the nose allows for added comfort and control during use.

WARNING Always hold the tool away from your face. Accessories can be damaged during handling and can fly apart as they come up to speed. This is not common, but it does happen.

CAUTION When holding tool, do not cover the air vents with your hand. Blocking the air vents could cause the motor to overheat.

IMPORTANT! Practice on scrap material first to see how the tool's high-speed action performs. Keep in mind that your rotary tool will perform best by allowing the speed, along with the correct Dremel™ accessory and attachment, to do the work for you. Do not put pressure on the tool during use, if possible.

Instead, lower the spinning accessory lightly to the work surface and allow it to touch the point at which you want to begin. Concentrate on guiding the tool over the work using very little pressure from your hand. Allow the accessory to do the work.

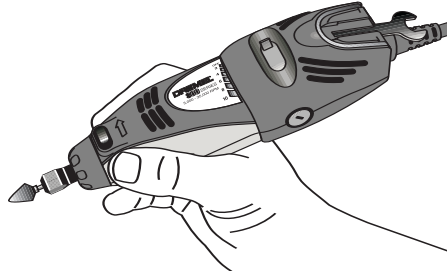

For best control in close work, grip the rotary tool like a pencil between your thumb and forefinger.

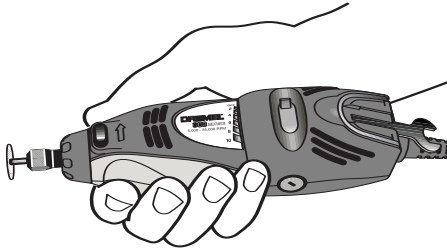

The “golf” grip method is used for more aggressive operations such as grinding or cutting.

Usually it is better to make a series of passes with the tool rather than to do the entire job with one pass. A gentle touch gives the best control and reduces the chance for error.

OPERATION (CONTINUED)

Operating Speeds

To achieve the best results when working with different materials, set the variable speed control to suit the job. To select the right speed for the accessory in use, practice with scrap material first.

NOTE: Speed is affected by voltage changes. A reduced incoming voltage will slow the RPM of the tool, especially at the lowest setting. If your tool appears to be running slowly, increase the speed setting accordingly. The tool may not start at the lowest switch setting in areas where outlet voltage is less than 120 volts. Simply move the speed setting to a higher position to begin operation.

The 300 Series Rotary Tool switch settings are marked "near" the speed control switch on the front tool label. Refer to the Speed Settings chart on pages 12 thru 14 to help determine the proper speed for the material being worked on and the accessory to use.

Most jobs can be accomplished using the tool at the highest setting. However, certain materials (some plastics and metals) can be damaged by high-speed generated heat and should be worked on at relatively slow speeds.

Slow speed operation (15,000 RPM or less) is usually best for polishing operations employing the felt polishing accessories, delicate wood carving and fragile model parts. All brushing applications require lower speeds to avoid wire discharge from the holder. Let the performance of the tool do the work for you when using lower speed settings.

Higher speeds are better for drilling, carving, cutting, routing, shaping, cutting dadoes or rabbets in wood. Hardwoods, metals and glass require high speed operation also.

The settings for approximate RPM's are:

Switch Setting	Speed Range RPM
1-2	10,000-14,000
3-4	15,000-19,000
5-6	20,000-24,000
7-8	25,000-29,000
9-10	30,000-37,000

Set the Speed Control to the desired setting.

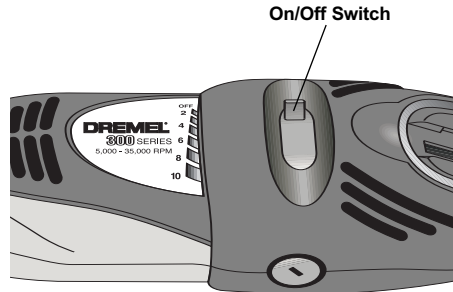

Some guidelines regarding tool speed:

- There is no accessory for the Dremel Rotary tool that will drill or cut glass.
- Plastic and other materials that melt at low temperatures should be cut at low speeds.
- Polishing, buffing and cleaning with a wire brush must be done at speeds not greater than 15,000 RPM to prevent damage to the brush and your material.
- Wood should be cut at high speed.
- Iron or steel should be cut at high speed.
- If a high speed steel cutter starts to vibrate, it usually indicates that it is running too slow.
- Aluminum, copper alloys, lead alloys, zinc alloys and tin may be cut at various speeds, depending on the type of cutting being done. Use a paraffin (not water) or other suitable lubricant on the cutter to prevent the cut material from adhering to the cutter teeth.

NOTE: Increasing pressure on the tool is not the answer when it is not performing properly. Try a different accessory or speed setting to achieve the desired result. Please refer to the following Speed Setting charts or simply contact Dremel Consumer Service at:

Phone: 03-5415317

Fax: 03-5415441

or at www.Dremel.com.

SPEED SETTINGS

Use only Dremel™ tested, high performance accessories.

* Speed for light cuts; Caution - burning on deep grooves.

• Depending on cutting direction relative to grain.

High Speed Cutters

Catalog Number	Soft Wood	Hard Wood	Laminates Plastic	Steel	Aluminum, Brass, etc.	Shell Stone	Ceramic	Glass
100, 121, 131	10	10	6	6	8	-	-	-
114, 124, 134, 144	10	6	4	6	6	-	-	-
190	10	10	4	8	10	-	-	-
118, 191, 192, 193, 194	10	10	4	6	10	-	-	-
116, 117, 125, 196	10	6	4	6	6	-	-	-
115	10	10	4	6	6	-	-	-
198	10	8	4	6	6	-	-	-
199	10	8	4	6	6	-	-	-

Engraving Cutters

Catalog Number	Soft Wood	Hard Wood	Laminates Plastic	Steel	Aluminum, Brass, etc.	Shell Stone	Ceramic	Glass
105, 108	10	10	8	8	6	-	-	-
106, 109	10	10	6	8	6	-	-	-
107, 110	10	10	6	8	6	-	-	-
111	10*	10*	8*	8	6	-	-	-
112	10*	10*	6*	8	6	-	-	-
113	10*	10*	6*	8	6	-	-	-

Diamond Wheel Points

Catalog Number	Soft Wood	Hard Wood	Laminates Plastic	Steel	Aluminum, Brass, etc.	Shell Stone	Ceramic	Glass
7103, 7105, 7117, 7120, 7122, 7123, 7134, 7144	10	8	-	-	-	10	10	10

Structured Tooth Tungsten Carbide Cutters

Catalog Number	Soft Wood	Hard Wood	Laminates Plastic	Steel	Aluminum, Brass, etc.	Shell Stone	Ceramic	Glass
9931, 9932, 9933, 9934, 9935, 9936	10	8	4	-	6	-	-	-

Tungsten Carbide Cutters

Catalog Number	Soft Wood	Hard Wood	Laminates Plastic	Steel	Aluminum, Brass, etc.	Shell Stone	Ceramic	Glass
9901, 9902, 9903, 9904, 9905, 9906, 9909, 9910, 9911, 9912	10	8	4	10	6	8	8-10	8-10

SPEED SETTINGS (CONTINUED)

Use only Dremel™ tested, high performance accessories.

* Speed for light cuts; Caution - burning on deep grooves.

• Depending on cutting direction relative to grain.

High Speed Router Bits

Catalog Number	Soft Wood	Hard Wood	Laminates Plastic	Steel	Aluminum, Brass, etc.	Shell Stone	Ceramic	Glass
612, 640	10*	8•	-	-	-	-	-	-
615, 617, 618, 650, 652	10*	10•	-	-	-	-	-	-
654	10*	8•	-	-	-	-	-	-

Silicon Carbide Grinding Stones

Catalog Number	Soft Wood	Hard Wood	Laminates Plastic	Steel	Aluminum, Brass, etc.	Shell Stone	Ceramic	Glass
83142, 83322, 83702, 84922, 85422, 85602, 85622	-	-	6	10	4	6	10	10

Abrasive Points

Catalog Number	Soft Wood	Hard Wood	Laminates Plastic	Steel	Aluminum, Brass, etc.	Shell Stone	Ceramic	Glass
516, 517, 518,	4-6	4-6	-	8	6	-	-	-
500	4-6	4-6	-	8	6	-	-	-

Aluminum Oxide Grinding Stones

Catalog Number	Soft Wood	Hard Wood	Laminates Plastic	Steel	Aluminum, Brass, etc.	Shell Stone	Ceramic	Glass
903, 911, 921, 932, 941, 945, 952, 953, 954, 971, 997, 8153, 8175, 8193, 8215	10	10	-	8	4	6	10	-
541	10	10	-	8	4	6	10	-

Chain Saw Sharpening Stones

Catalog Number	Soft Wood	Hard Wood	Laminates Plastic	Steel	Aluminum, Brass, etc.	Shell Stone	Ceramic	Glass
453, 454, 455	-	-	-	10	-	-	-	-

SPEED SETTINGS (CONTINUED)

Use only Dremel™ tested, high performance accessories.

* Speed for light cuts; Caution - burning on deep grooves. • Depending on cutting direction relative to grain.

Cutting Accessories

Catalog Number	Soft Wood	Hard Wood	Laminates Plastic	Steel	Aluminum, Brass, etc.	Shell Stone	Ceramic	Glass
409, 420, 426, 540	-	-	1-4	10	10	10	10	-
542	10	8-10	2-4	10	10	10	10	-
545	8-10	8	-	-	-	-	-	-
560	For use on drywall. For best results, use at 35,000 rpm.							
561	6-10	6-10	2-4	-	10	-	-	-
562	-	-	-	-	-	-	10	-

Polishing Accessories

Catalog Number	Soft Wood	Hard Wood	Laminates Plastic	Steel	Aluminum, Brass, etc.	Shell Stone	Ceramic	Glass
461, 462, 463	-	-	-	8	8	8	8	8
414, 422, 429	-	-	-	6	6	6	6	6
425, 427	-	-	-	8	8	-	-	-
423	-	-	-	8	8	8	8	8
403, 404, 405	4	4	1-4	6	6	-	-	-
530, 531, 532	-	4	-	4	-	-	-	-
428, 442, 443	4	4	2	4	-	-	-	-
535, 536, 537	4	4	-	4	4	4	-	-

Sanding Bands and Discs

Catalog Number	Soft Wood	Hard Wood	Laminates Plastic	Steel	Aluminum, Brass, etc.	Shell Stone	Ceramic	Glass
430, 431, 438	1-10	1-10	1-6	10	10	1-10	1-10	-
439, 440, 444	1-10	1-10	1-6	10	10	1-10	1-10	-
407, 408, 432	1-10	1-10	1-6	10	10	1-10	1-10	-
411, 412, 413	8	8	1-4	-	1-4	-	-	-

Flapwheels

Catalog Number	Soft Wood	Hard Wood	Laminates Plastic	Steel	Aluminum, Brass, etc.	Shell Stone	Ceramic	Glass
502, 503, 504, 505	10	8	1	10	8-10	-	-	-

Finishing Abrasive Buffs

Catalog Number	Soft Wood	Hard Wood	Laminates Plastic	Steel	Aluminum, Brass, etc.	Shell Stone	Ceramic	Glass
511	6	6	4	6	6	-	-	-

Drill Bit

Catalog Number	Soft Wood	Hard Wood	Laminates Plastic	Steel	Aluminum, Brass, etc.	Shell Stone	Ceramic	Glass
150	10	10	1-4	-	6	-	-	-

Grout Removal Bits

Catalog Number	Soft Wood	Hard Wood	Laminates Plastic	Steel	Aluminum, Brass, etc.	Shell Stone	Ceramic	Glass
569, 570	For use on wall and floor grout.						6-8	-

MAINTENANCE

⚠ WARNING Preventative maintenance performed by unauthorized personnel may result in misplacing of internal wires and components which could cause serious hazard. We recommend that all tool service be performed by a Dremel™ Service Facility.

⚠ WARNING To avoid injury from unexpected starting or electrical shock, always remove plug from wall outlet before performing service or cleaning.

Carbon Brushes

The brushes in your tool have been engineered for many hours of dependable service.

To prepare the brushes for use, run the tool at full speed for 5 minutes under no load. This will properly "seat" the brushes, and extend the life of the tool.

To maintain peak efficiency of the motor, examine the brushes for wear every 40-50 hours.

⚠ CAUTION Using the tool with worn brushes will permanently damage the motor.

Use only original Dremel™ replacement brushes.

Inspect the rotary tool brushes after 40-50 hours of use. If the rotary tool runs erratically, loses power, or makes unusual noises check the brushes for wear and possible replacement. Remember: brushes in the rotary tool are similar to oil in a car; the more you check/service, the better the performance.

Follow these steps to check/change the rotary tool brushes:

- 1 With the power cord unplugged, place the tool on a clean surface. Use the tool wrench as a screwdriver to remove the brush caps in a counter-clockwise direction (Figure A).



Removing Brush Cover

- 2 Remove the brushes from the tool by pulling on the spring that is attached to the carbon brush. If the brush is less than 1/8" long and the surface of the brush that touches the commutator is rough or pitted, the carbon brushes should be replaced. Be sure to check both brushes (Figure B).

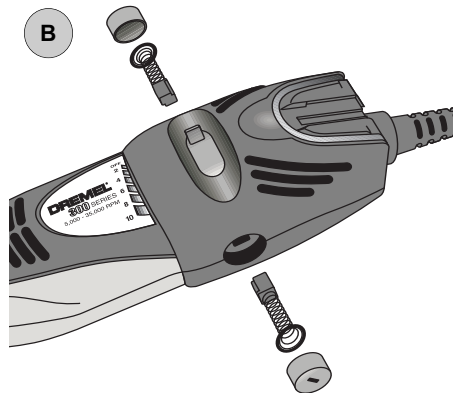

Removing/Inspecting Brushes

- 3 If one brush is worn, you should replace both brushes for better performance of your rotary tool. Remove the spring from the brush, throw away the old brush and place the spring on a new brush.

4. Place the carbon brush and spring back into the tool, there is only one way the brush will fit back into the tool.
5. Replace the brush caps onto the tool by turning the cap in a clockwise direction. To tighten, use the wrench, but **DO NOT OVER TIGHTEN!**

After replacing the brushes the tool should be run at no load; place it on a clean surface and run it freely at full speed for 5 minutes before loading (or using) the tool. This will allow the brushes to "seat" properly and will give you more hours of life from each set of brushes. This will also extend the life of your tool since the commutator surface will also wear better and longer.

Cleaning The Tool

Ventilation openings and switch levers must be kept clean and free of foreign matter. Do not attempt to clean by inserting pointed objects through openings.



The tool may be cleaned with compressed air. Always wear safety goggles when cleaning tool with compressed air.

There is no need to lubricate the Dremel™ rotary tool.

CAUTION Certain cleaning agents and solvents will damage plastic parts. Some of these are: gasoline, carbon tetrachloride, chlorinated cleaning solvents, ammonia and household detergents that contain ammonia.

Clean the "soft grip" areas of the tool using a damp cloth. Tougher soiled areas may require more than one wipe application to get clean.

ACCESSORIES

For availability of all accessories and attachments, refer your local hardware, hobby or home center. Or contact Dremel Consumer Service at: **03-5415317** or at www.Dremel.com.

▲ WARNING Use only Dremel™, high-performance accessories. Other accessories are not designed for this tool and may lead to personal injury or property damage.

Drywall Cutting Bit



When using a template (outlet box) behind the drywall, cut in a counterclockwise direction.

High Speed Router Bits

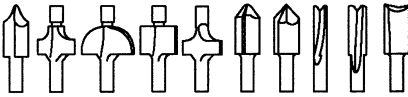

For routing, inlaying and mortising in wood and other soft materials. Use only with Dremel™ Router Attachment #330 or Shape/Router Table #231.

Tile Cutting Bit

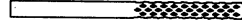

For use wall tile, cement board and plaster. Start the bit into the material at a 45° angle and then slowly bring it to a 90° angle to begin the cut.

Multipurpose Cutting Bit



For use in wood, plastics, drywall, fiberglass, vinyl or aluminum siding, acoustical tile and laminates.

Start the bit into the material at a 45° angle and then slowly bring it to a 90° angle to begin the cut.

Mandrels

A mandrel is a shank with a threaded or screw head used with polishing accessories, cutting wheels, sanding discs and polishing points. The mandrel is a permanent shank, allowing for replacement of the worn head when necessary.

Screw Mandrel

For use with the felt polishing tip and felt polishing wheels.

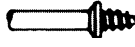

1/8" shank

Small Screw Mandrel

Mandrel has a small screw at the tip and is used with emery and fiberglass cutting wheels, sanding discs and polishing wheels.

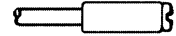

1/8" shank

Threaded Tip Mandrel

Mandrel has a threaded tip which threads into the polishing point accessory #427.



1/8" shank

Aluminum Oxide Grinding Stones (red/brown)

These grinding stones come round, pointed or flat and are made of aluminum oxide. Use them for every possible grinding operation: sharpening lawn mower blades, screwdriver tips, knives, scissors, chisels and other cutting tools. Use to remove flash from metal castings, deburring any kind of metal. These grinding stones can be resharpened with a dressing stone. In machine shops, high speed drills and cutters are normally ground with aluminum oxide wheels.

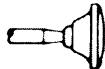

1/8" shank

Silicon Carbide Grinding Stones (blue/green)

Tougher than aluminum oxide points, these are made especially for use on hard materials such as glass and ceramics.

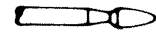

1/8" shank

Diamond Wheel Points

Used for fine detail work on wood, jade, ceramic, glass and other hard material. Bits are covered with diamond particles.



3/32" shank

ACCESSORIES (continued)

High Speed Cutters

High speed cutters are used in carving, cutting and slotting wood, plastics and soft metals (such as aluminum, copper and brass). Made of high quality steel.



1/8" shank

Structured Tooth Tungsten Carbide Cutters

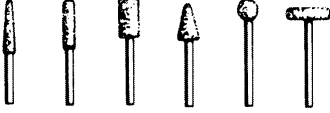

1/8" shank

These cutters feature fast cutting needle-sharp teeth for greater material removal with minimum loading. Use on fiberglass, wood, plastic, epoxy and rubber.

Engraving Cutters

Engraving cutters come in a wide variety of sizes and shapes and are used for intricate work on ceramics (greenware), wood carvings, jewelry and scrimshaw. They are often used in making complicated printed circuit boards. They should not be used on steel and very hard materials, but are good for use on wood, plastic and soft metals.

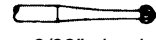

3/32" shank

Tungsten Carbide Cutters

Tungsten carbide cutters are long-lived cutters for use on hardened steel, fired ceramics and other very hard materials. They can be used for engraving on tools and garden equipment.



1/8" shank

Wire Brushes

CAUTION Never use wire brushes at speeds greater than 15,000 rpm. Refer to Speed Settings (pages 10-12) for proper tool and setting.

Three different shapes of wire brushes are available in three different materials: stainless steel, brass and carbon wire. Stainless steel brushes perform well on pewter, aluminum, stainless steel and other metals, without leaving rust. Brass brushes are non-sparking and softer than steel, making them good for use on soft metals like gold, copper and brass. Carbon wire brushes are good for general purpose cleaning.



1/8" shank

Bristle Brushes

Bristle brushes are used for cleaning tools on silverware, jewelry and antiques. The three shapes make it possible to get into tight corners and other difficult spaces. They can be used with polishing compound for faster cleaning or polishing.



1/8" shank

Brushing Pressure

- The tips of a wire brush do the work. Operate the brush with the lightest pressure so only the tips of the wires come in contact with the work surface.
- If heavier pressure is used, the wires will become overstressed, resulting in a wiping action. If this continues, the life of the brush will be shortened by fatigue.
- Apply the brush to the work surface so the majority of the brush face makes full contact. Applying the edge or side of the brush to the work surface will result in wire breakage and shortened brush life.

CORRECT:

Wire tips doing the work.

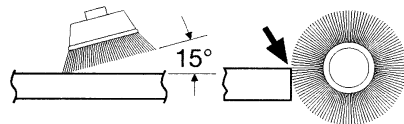

INCORRECT:

Excessive pressure can cause wire breakage.

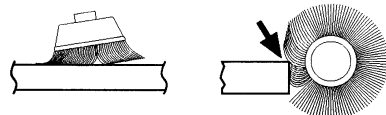

Aluminum Oxide Abrasive Wheels

Used to remove paint, deburr metal, polish stainless steel and other metals. Available in medium grit.



1/8" shank

Grinding Wheel

Used for deburring, removing rust, and general purpose grinding. Use with Mandrel #402.



ACCESSORIES (continued)

Sanding Accessories

Sanding discs in fine, medium and coarse grades are made to fit mandrel #402. They can be used for nearly any small sanding job from model making to fine furniture finishing.

In addition, the drum sander makes it possible to shape wood, smooth fiberglass, sand inside curves and other difficult places. Drum bands are replaceable and come in fine and coarse grades.



1/8" shank

Flapwheels grind and polish flat or contoured surfaces. They are used most effectively as a finishing sander, after heavier surface sanding and material removal is completed. Flapwheels come in fine and coarse grades.

Bufs are a great finishing accessory for cleaning and light sanding. They work effectively on metal, glass, wood, aluminum and plastics. Bufs are available in medium and coarse grades.

ATTACHMENTS

The following attachments are part of the Dremel Rotary Tool System; increasing the versatility of your rotary tool.

Flex Shaft

Ideal for hard-to-reach places and fine detail work.

- Quick connect attach system
- 36" long cable with new 5" bend radius provides more flexibility
- Comfort grip hand piece
- Integrated shaft lock button
- Holds up to 1/8" shank

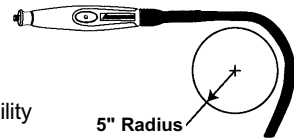

Use with models: 275, 285, 395, 398, 780, 800, 300 Series, 400 Series XPR.

Plunge Router

Converts you corded rotary tool into a plunge router.

- Clear base
- Two depth stop
- Includes edge guide and circle guide
- Rout circles, parallel to edge, signs, inlay work, and lettering template adapters

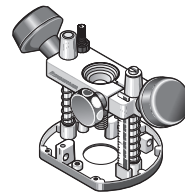

Use with models: 275, 285, 395, 398, 800, 300 Series, 400 Series XPR.

ATTACHMENTS (continued)

Grout Removal

Fast and easy way to regrout any room or replace a broken tile!

- Multiple side depth adjustment
- 30° angle for control cutting
- Guides 180° apart to keep bit centered between tiles
- Easy screw mounting
- Includes 1/16" grout removal bit

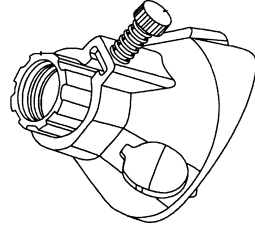

Use with models: 275, 285, 395, 398, 770, 780, 800, 300 Series, 400 Series XPR.

Cutting Guide

Provides controlled cutting in a variety of materials

- Allows for sturdy controlled cuts with maximum visibility
- Easy depth adjustment. Set to the correct cutting depth for the project material.

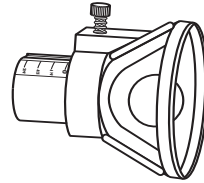

Use with models: 275, 285, 395, 398, 770, 780, 800, 300 Series, 400 Series XPR.

Lawn / Garden Sharpener

The fastest, easiest, safest way to sharpen your lawn mower blade and other garden tools.

- Guide provides optimum sharpening angle
- Sharpens most rotary lawn mower blades
- Includes sharpening stone

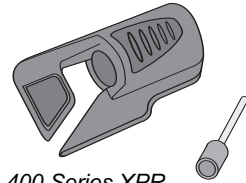

Use with models: 275, 285, 395, 398, 770, 780, 800, 300 Series, 400 Series XPR.

Chain Saw Sharpener

- Easily sharpen the dulllest of chains
- Contains: sharpening attachment, 3 sharpening stones, gauge, 2 spacers, wrench, instruction manual

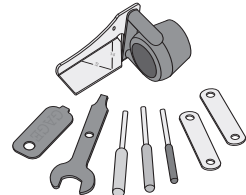

Use with models: 275, 285, 395, 398, 770, 780, 800, 300 Series, 400 Series XPR.

ATTACHMENTS (continued)

Right Angle

Enhances the versatility of the rotary tool by allowing you to get into hard-to-reach places.

- Ball bearings and spiral gears provide smooth and cool operation
- Coupling system allows you to orient the attachment on your tool in 12 different directions
- Quick disconnect system easily attaches to your rotary tool in place of the housing cap, no wrenches required

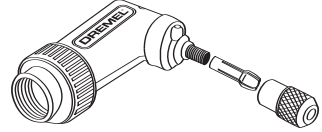

Use with models: 275, 285, 395, 398, 780, 800, 300 Series, 400 Series XPR.

Dremelite

- Provides visibility in dimly lit areas and increases light on detailed projects
- Two extremely long lasting and durable LED lights
- Uses a magnet threaded onto the tool's output shaft to provide a clever and simple power source—no wires!

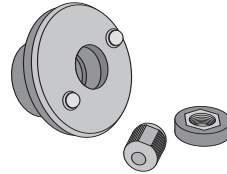

Use with models: 275, 285, 395, 398, 770, 780, 800, 300 Series, 400 Series XPR.

Flex Shaft Tool Holder

Conveniently suspends any Dremel rotary tool above your workbench.

- Perfect for use with the Flex-Shaft attachment
- Clamps to workbenches up to 1-3/4" thick, and adjusts in height from 12" to 42"
- Store extra bits on base

Use with models: 275, 285, 395, 398, 300 Series, 400 Series XPR.

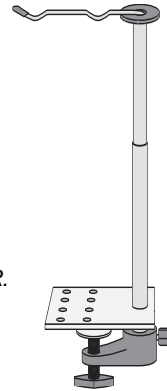

SERVICE PARTS & DIAGRAM

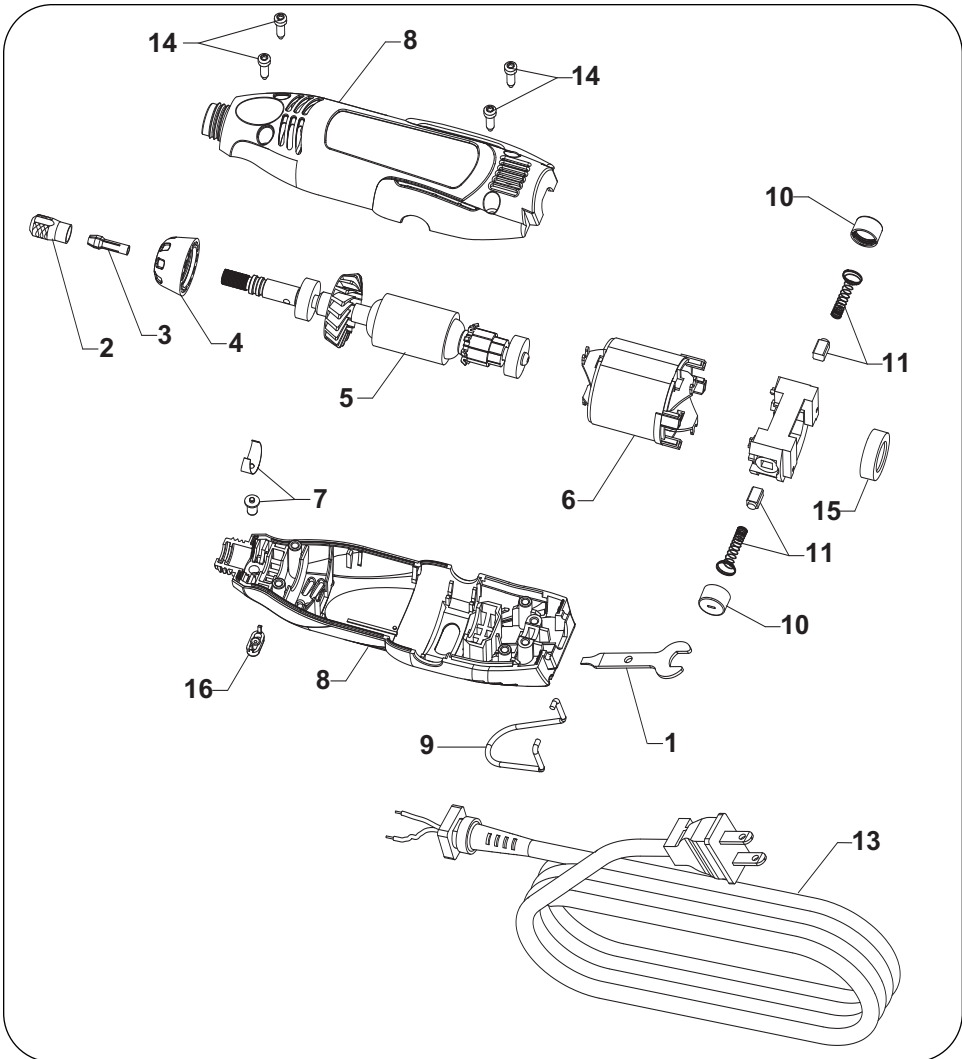

Ref.	Part No.	Description	Ref.	Part No.	Description
1	2615990962	Wrench	10	2610912785	Brush Cap (Pair)
2	2615297355	Collet Nut	11	2615302695	Brush & Brush Spring (Pair)
3	2615110480	1/8" Collet (In Tool)	12	2610938877	Switch Assembly
4	2615919754	Nose Cap	13	2610999103	Cord
5	2610912779	Armature and Bearing Assembly	14	2615294035	Screws (Individual)
6	2610907324	Field Assembly	15	2615297373	Rubber Bearing Sleeve
7	2610913818	Shaft Lock Assembly	16	2610925721	Glamour Cap
8	2610925724	Housing Set			
9	2610925720	Hanger			

NOTES:

GUARANTEE

This DREMEL product has been carefully inspected before leaving the factory and carries a guarantee of 2 years ("BASIC" : 1 year) from the date of purchase during which period any defect caused by faulty material or manufacture will be corrected without charge. Damage due to normal wear and tear, overload or improper handling will be excluded from the guarantee. In case of a complaint, please, send the tool undismantled together with proof of purchase to the nearest DREMEL Service Station, postal charges prepaid. DREMEL reserves the right to decline responsibility in case of repairs made by persons other than DREMEL service staff. In no event compensation can be claimed in case of damage to the workpiece or injury to the tool user. This guarantee does not affect your statutory rights (UK only). Information on guarantee in instruction manual herewith expires.

Free Manuals Download Website

<http://myh66.com>

<http://usermanuals.us>

<http://www.somanuals.com>

<http://www.4manuals.cc>

<http://www.manual-lib.com>

<http://www.404manual.com>

<http://www.luxmanual.com>

<http://aubethermostatmanual.com>

Golf course search by state

<http://golfingnear.com>

Email search by domain

<http://emailbydomain.com>

Auto manuals search

<http://auto.somanuals.com>

TV manuals search

<http://tv.somanuals.com>