

CELVIANO

AP-500

USER'S GUIDE

GUÍA DEL USUARIO

Please keep all information for future reference.
Guarde toda información para tener como referencia futura.

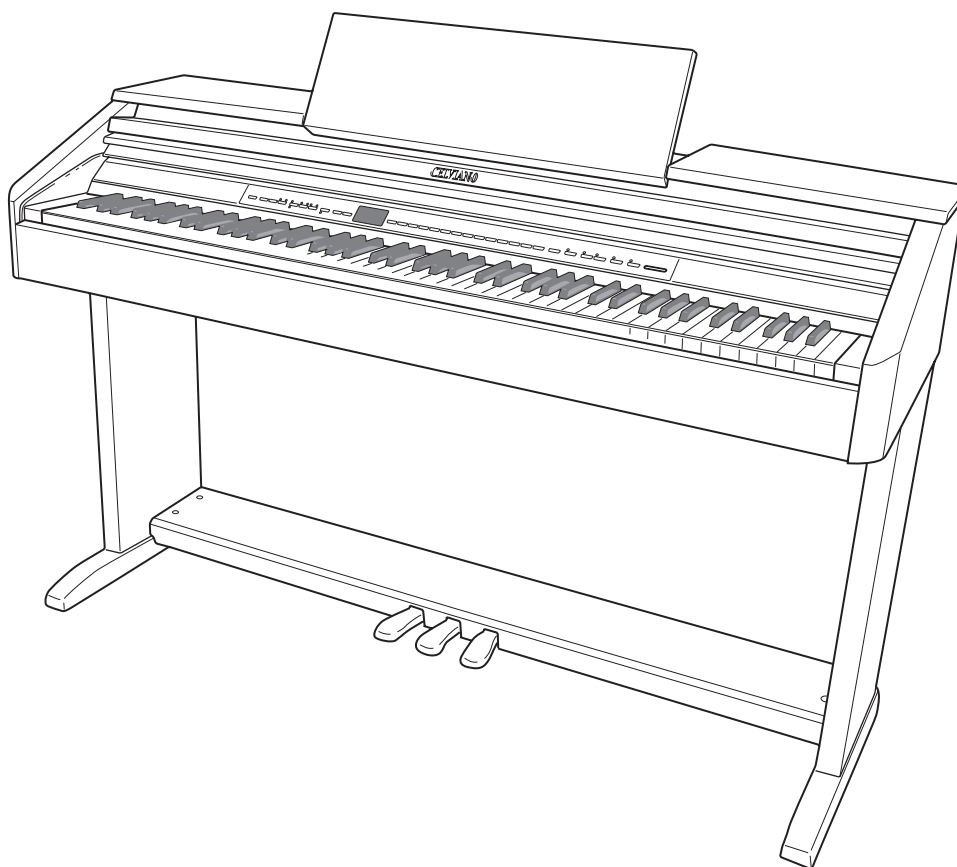
**Safety Precautions**

Before trying to use the piano, be sure to read the separate "Safety Precautions".

Precauciones de seguridad

Antes de intentar usar el piano, asegúrese de leer las "Precauciones de seguridad" separadas.

IMPORTANT SAFETY INSTRUCTIONS

1. Read these instructions.
2. Keep these instructions.
3. Heed all warnings.
4. Follow all instructions.
5. Do not use this apparatus near water.
6. Clean only with dry cloth.
7. Do not block any ventilation openings. Install in accordance with the manufacturer's instructions.
8. Do not install near any heat sources such as radiators, heat registers, stoves, or other apparatus (including amplifiers) that produce heat.
9. Do not defeat the safety purpose of the polarized or grounding-type plug. A polarized plug has two blades with one wider than the other. A grounding type plug has two blades and a third grounding prong. The wide blade or the third prong are provided for your safety. If the provided plug does not fit into your outlet, consult an electrician for replacement of the obsolete outlet.
10. Protect the power cord from being walked on or pinched particularly at plugs, convenience receptacles, and the point where they exit from the apparatus.
11. Only use attachments/accessories specified by the manufacturer.
12. Use only with the cart, stand, tripod, bracket, or table specified by the manufacturer, or sold with the apparatus. When a cart is used, use caution when moving the cart/apparatus combination to avoid injury from tip-over.



13. Unplug this apparatus during lightning storms or when unused for long periods of time.
14. Refer all servicing to qualified service personnel. Servicing is required when the apparatus has been damaged in any way, such as power-supply cord or plug is damaged, liquid has been spilled or objects have fallen into the apparatus, the apparatus has been exposed to rain or moisture, does not operate normally, or has been dropped.

The apparatus shall not be exposed to dripping or splashing and that no objects filled with liquids, such as vases, shall be placed on the apparatus.

The power indicator being unlit does not mean the apparatus is completely disconnected from the MAINS. When you need to have the apparatus completely disconnected from the MAINS, you must unplug the power cord. For that purpose, locate the apparatus in a way that secures easy access to the power cord.

Declaration of Conformity

Model Number: AP-500
Trade Name: CASIO COMPUTER CO., LTD.
Responsible party: CASIO, INC.
Address: 570 MT. PLEASANT AVENUE, DOVER, NEW JERSEY 07801
Telephone number: 973-361-5400

This device complies with Part 15 of the FCC Rules, Operation is subject to the following two conditions:

(1) This device may not cause harmful interference, and (2) this device must accept any interference received, including interference that may cause undesired operation.



CAUTION

RISK OF ELECTRIC SHOCK DO NOT OPEN



CAUTION: TO REDUCE THE RISK OF ELECTRIC SHOCK, DO NOT REMOVE COVER (OR BACK). NO USER -SERVICEABLE PARTS INSIDE. REFER SERVICING TO QUALIFIED SERVICE PERSONNEL.



The lightning flash with arrowhead symbol, within an equilateral triangle, is intended to alert the user to the presence of uninsulated "dangerous voltage" within the product's enclosure that may be of sufficient magnitude to constitute a risk of electric shock to persons.



The exclamation point within an equilateral triangle is intended to alert the user to the presence of important operating and maintenance (servicing) instructions in the literature accompanying the product.

NOTICE

This equipment has been tested and found to comply with the limits for a Class B digital device, pursuant to Part 15 of the FCC Rules. These limits are designed to provide reasonable protection against harmful interference in a residential installation. This equipment generates, uses and can radiate radio frequency energy and, if not installed and used in accordance with the instructions, may cause harmful interference to radio communications. However, there is no guarantee that interference will not occur in a particular installation. If this equipment does cause harmful interference to radio or television reception, which can be determined by turning the equipment off and on, the user is encouraged to try to correct the interference by one or more of the following measures:

- Reorient or relocate the receiving antenna.
- Increase the separation between the equipment and receiver.
- Connect the equipment into an outlet on a circuit different from that to which the receiver is connected.
- Consult the dealer or an experienced radio/TV technician for help.

FCC WARNING

Changes or modifications not expressly approved by the party responsible for compliance could void the user's authority to operate the equipment.

TO REDUCE THE RISK OF FIRE OR ELECTRIC SHOCK, REFER SERVICING TO QUALIFIED SERVICE PERSONNEL.

Company and product names used in this manual may be registered trademarks of others.



This mark applies in EU countries only.



CASIO Europe GmbH
Bornbarch 10, 22848 Norderstedt, Germany

This mark applies to the AP-500V only.
Please keep all information for future reference.

Contents

Assembling the Stand E-40

- Unpacking E-40
- To assemble the stand E-40
- To connect cables E-42
- To raise the music stand E-43
- To install the headphones hook E-43

General Guide E-2

- Using the TEMPO/SETTING Button E-4
- ▼/NO Button and ▲/YES Button E-4

Power Supply E-5

Connections E-6

- Connecting Headphones E-6
- Connecting Audio Equipment or an Amplifier E-6
- Bundled and Optional Accessories E-7

Selecting and Playing a Tone E-8

- Selecting a Main Tone E-8
- Selecting a Various tone, GM tone, and Drum set E-9
- Adjusting the Brilliance of a Tone E-9
- Layering Two Tones E-10
- Splitting the Keyboard between Two Tones E-10
- Using Effects E-11
- Using the Digital Piano's Pedals E-12
- Using the Metronome E-12

Playing a Rhythm E-14

- Selecting a Rhythm E-14
- Using Auto Accompaniment E-14

Playing Back Built-in Songs E-18

- Playing Back All of the Built-in Songs E-18
- Playing Back a Specific Music Library Song E-19
- Skipping Back through a Song E-19
- Skipping Forward through a Song E-20
- Practicing with a Music Library Song E-20

Recording and Play Back E-21

- Songs and Tracks E-21
- Recording Your Keyboard Play E-22
- Playing Back from Digital Piano Memory E-23
- Deleting Recorded Data E-24

Other Settings E-25

- Configuring Settings E-25
- Secondary Parameter Reference E-27

Connecting to a Computer E-30

- Connecting to the MIDI Terminal E-30
- Connecting to the USB Port E-30
- USB Mode and MIDI Mode E-31
- Expanding the Selections in the Music Library E-32

Using an SD Memory Card E-33

- Inserting and Removing an SD Memory Card E-34
- Playing Back a File Stored on an SD Memory Card E-35
- Transferring Song Data from an SD Memory Card to Digital Piano Memory E-35
- Saving Song Data Recorded on the Digital Piano to an SD Memory Card E-37
- Formatting an SD Memory Card E-38
- SD Memory Card Errors E-39

Reference E-44

- Troubleshooting E-44
- Product Specifications E-46
- Operating Precautions E-47

Appendix A-1

- Tone List A-1
- Drum Assignment List A-2
- Rhythm List A-3
- Song List A-3
- Fingered Chord Chart A-4

MIDI Implementation Chart

General Guide

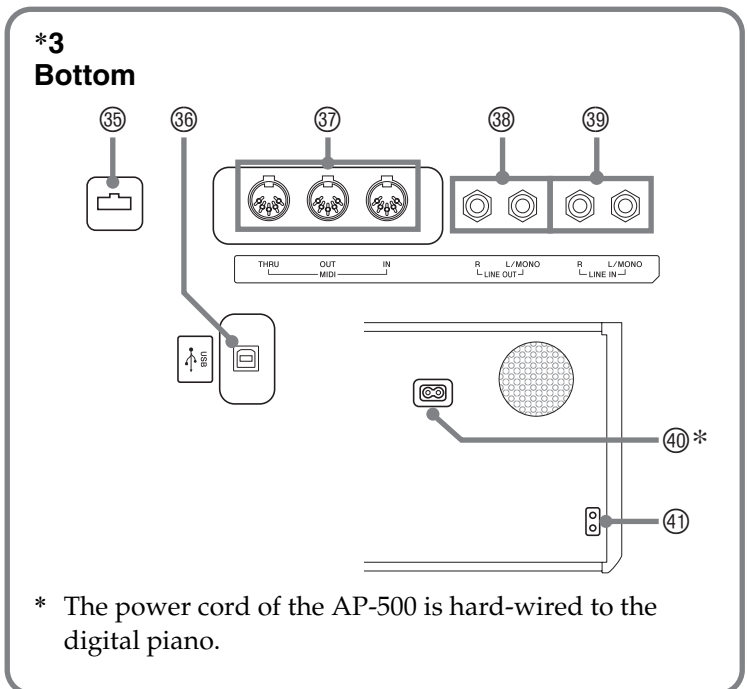
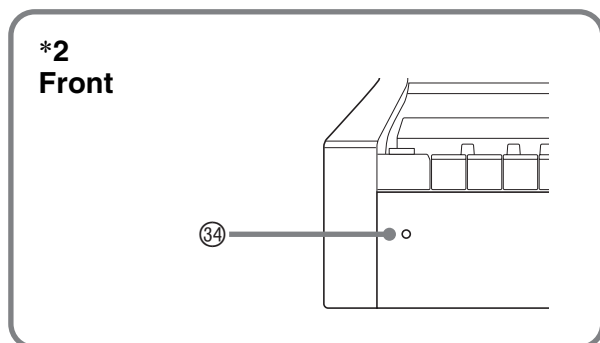
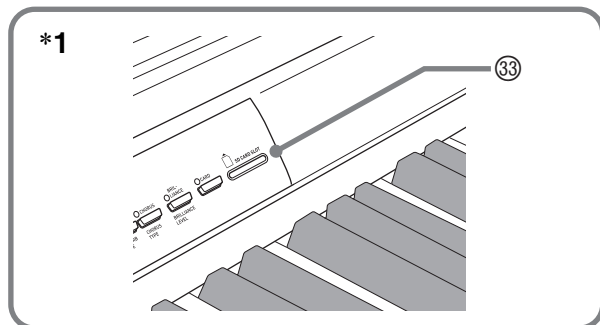
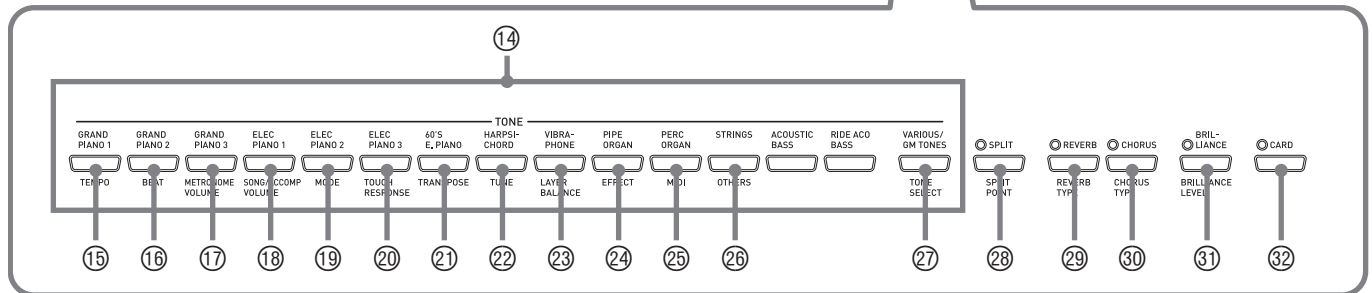
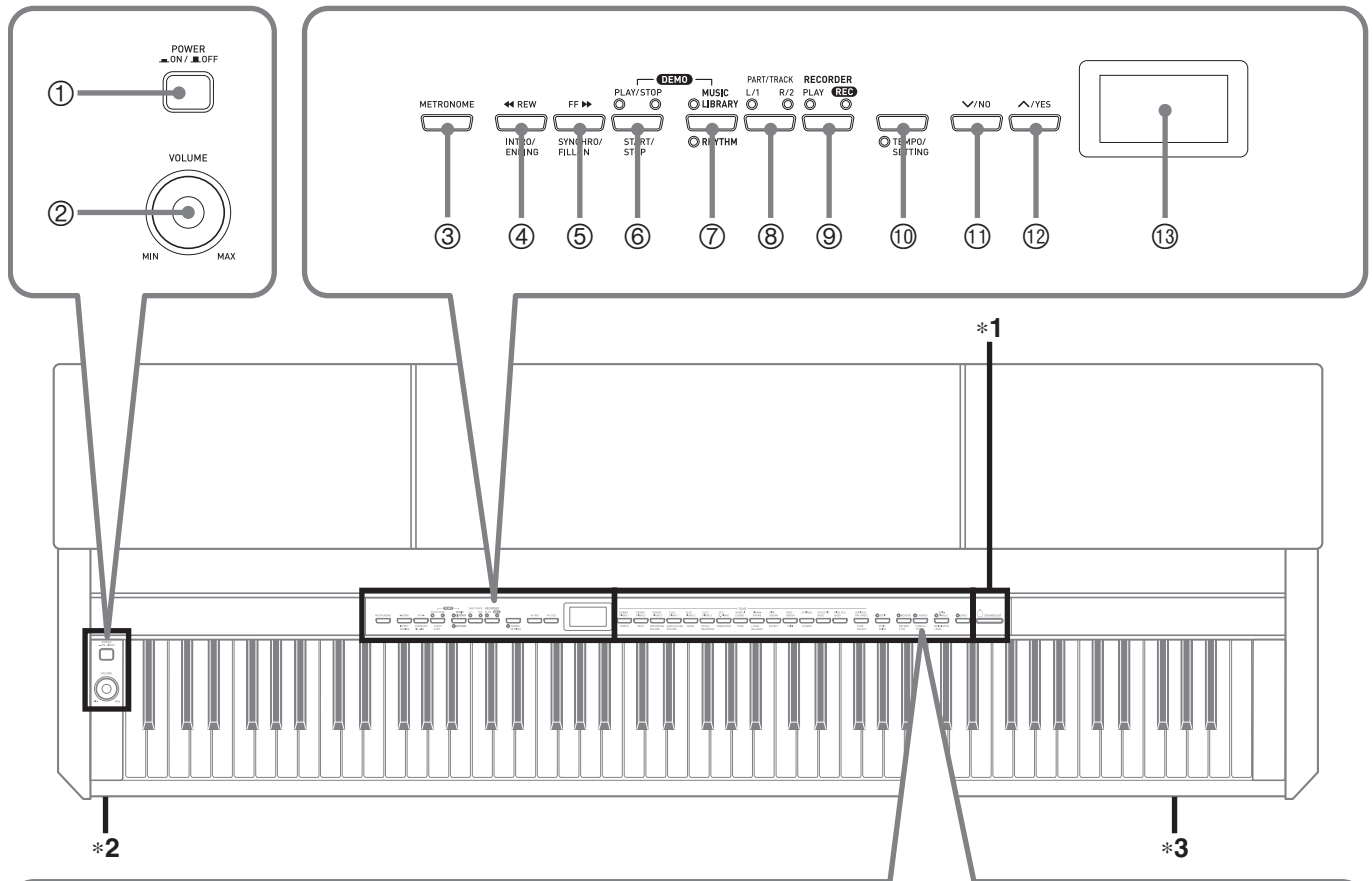

⚠ CAUTION

- Make sure that the cover is fully open whenever you are playing on the keyboard. A partially open cover can suddenly close unexpectedly and pinch.

📌 NOTE

- The names shown here are always indicated in bold when they appear within the text of this manual.

- | | |
|---------------------------------------|---|
| ① POWER button | ②② TUNE button |
| ② VOLUME controller | ②③ LAYER BALANCE button |
| ③ METRONOME button | ②④ EFFECT button |
| ④ ◀◀REW, INTRO/ENDING button | ②⑤ MIDI button |
| ⑤ FF▶▶, SYNCHRO/FILL-IN button | ②⑥ OTHERS button |
| ⑥ PLAY/STOP, START/STOP button | ②⑦ STONE SELECT button |
| ⑦ MUSIC LIBRARY, RHYTHM button | ②⑧ SPLIT, SPLIT POINT button |
| ⑧ PART/TRACK button | ②⑨ REVERB, REVERB TYPE button |
| ⑨ RECORDER button | ③⑩ CHORUS, CHORUS TYPE button |
| ⑩ TEMPO/SETTING button | ③① BRILLIANCE, BRILLIANCE LEVEL button |
| ⑪ ✓/NO button | ③② CARD button |
| ⑫ ^/YES button | ③③ SD memory card slot |
| ⑬ Display | ③④ Power lamp |
| ⑭ STONE buttons | ③⑤ Pedal connector |
| ⑮ TEMPO button | ③⑥ USB port |
| ⑯ BEAT button | ③⑦ MIDI THRU/OUT/IN terminals |
| ⑰ METRONOME VOLUME button | ③⑧ LINE OUT R, L/MONO jacks |
| ⑱ SONG/ACCOMP VOLUME button | ③⑨ LINE IN R, L/MONO jacks |
| ⑲ MODE button | ④⑩ AC power jack |
| ⑳ TOUCH RESPONSE button | ④① PHONES jack |
| ㉑ TRANPOSE button | |

📌 NOTE

- Each chapter of this manual starts with an illustration of the digital piano's console, which shows the buttons and other controllers you need to operate.

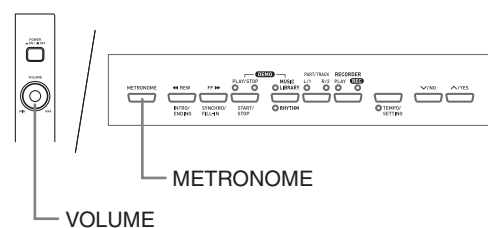

Using the TEMPO/SETTING Button

Normally when you press a button, it will change the setting or perform the operation marked above the button. Note that there also are secondary parameters (settings) marked below some buttons that you can select using the **TEMPO/SETTING** button.

- For details about the parameters you can configure using the **TEMPO/SETTING** button, see “Secondary Parameter Reference” on page E-27.

To select a secondary button parameter

1. Press the **TEMPO/SETTING** button.

- This will cause the lamp below the **TEMPO/SETTING** button to flash.
- The **GRAND PIANO 1/TEMPO** button’s lamp also will flash.

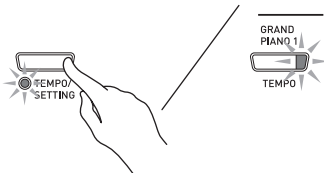

Example:



2. Press the button that corresponds to the parameter you want to select.

- This will cause the button’s lamp to flash.

Example: **TRANSPOSE** button

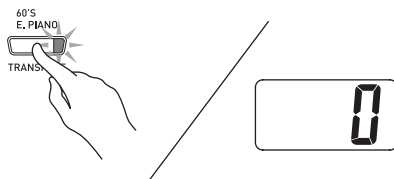

- If you want to adjust the tempo, you can skip this step because the **GRAND PIANO 1/TEMPO** button’s lamp will flash already.

3. Use the **∨/NO** and **∧/YES** buttons to change the setting of the selected parameter.

4. After you are finished, press the **TEMPO/SETTING** button again.

- This will cause the **TEMPO/SETTING** lamp and the lamp of the selected parameter button to go out.

∨/NO Button and ∧/YES Button

Use the **∨/NO** and **∧/YES** buttons to change a displayed setting.

- **Holding down either button changes the value at high speed.**

Example: See “Selecting a Various tone, GM tone, and Drum set” on page E-9.

NOTE

- Pressing the **∨/NO** and **∧/YES** buttons at the same time will return the displayed setting to its default.

Power Supply

Your digital piano runs on standard household power. Be sure to turn off power whenever you are not using the digital piano.

1. Make sure that the **POWER** button is in the OFF position (raised).

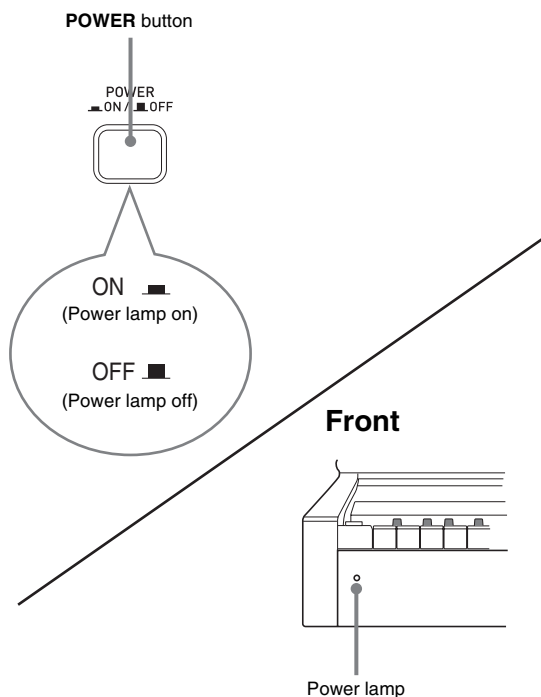

2. Connect the power cord that comes with the digital piano to the AC power jack on the bottom of the digital piano.*

* AP-500V only

3. Plug the power cord into a household power outlet.

IMPORTANT!

- Always make sure that the **POWER** button is the OFF position before plugging in or unplugging the power cord.
 - The shape of the power cord plug and household power outlet receptacle differ according to country and geographical area. The illustration shows just one example of the shapes that are available.
 - The power cord of the AP-500 is hard-wired to the digital piano.
- Make sure the power lamp is completely turned off before unplugging the power cord from the power outlet. Be sure to read and observe all of the safety precautions concerning power supply.

Connections

IMPORTANT!

- Whenever connecting something to the digital piano, first use the **VOLUME** controller to set the volume to a low level. After connecting, you can adjust the volume to the level you want.

Connecting Headphones

Bottom

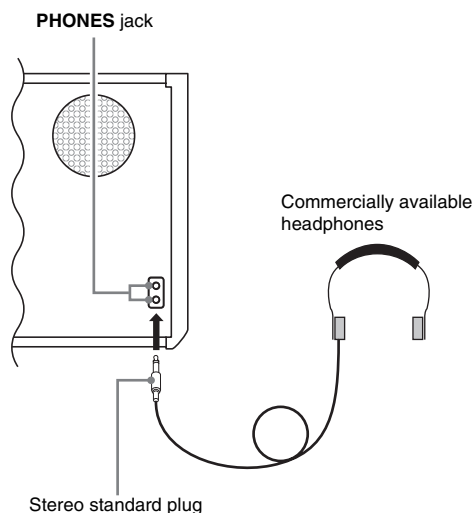

Connect commercially available headphones to the **PHONES** jack. Connecting headphones to the **PHONES** jack cuts off output to the speakers, which means you can practice even late at night without bothering others. To protect your hearing, make sure that you do not set the volume level too high when using headphones.

NOTE

- Be sure to push the headphones plug into the **PHONES** jack as far as it will go. If you don't, you may hear sound from only one side of the headphones.

Connecting Audio Equipment or an Amplifier

You can connect audio equipment or a music amplifier to the digital piano and then play through external speakers for more powerful volume and better sound quality.

IMPORTANT!

- The digital piano automatically adjusts sound output to optimize for headphone output (when headphones are connected) or built-in speaker output (when headphones are not connected). Note that this feature also affects the sound output from the **LINE IN** and **LINE OUT** jacks.

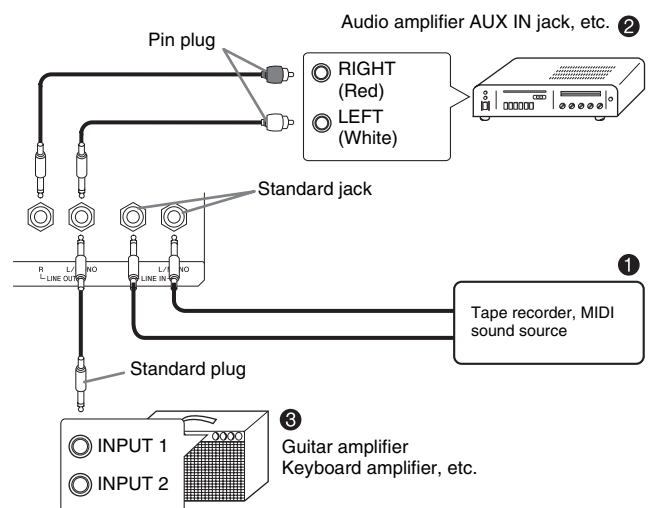

Playing Output from External Equipment through the Piano's Speakers 1

LINE IN R jack input sounds through the piano's right speaker, while **LINE IN L/MONO** jack input sounds through the left speaker. Connecting to the **LINE IN L/MONO** jack only causes the same output to be produced from both speakers. It is up to you to purchase connecting cables that are compatible with the equipment you are connecting.

Connecting to Audio Equipment ②

Use commercially available cables to connect the external audio equipment to the piano's **LINE OUT** jacks as shown in Figure ②. **LINE OUT R** jack output is right channel sound, while **LINE OUT L/MONO** jack output is left channel sound. It is up to you to purchase connecting cables like the ones shown in the illustration for connection of audio equipment.

Normally in this configuration you must set the audio equipment's input selector to the setting that specifies the terminal (such as AUX IN) to which the piano is connected. Use the piano's **VOLUME** controller to adjust the volume level.

Connecting to a Musical Instrument Amplifier ③

Use commercially available cables to connect the amplifier to the piano's **LINE OUT** jacks as shown in Figure ③. **LINE OUT R** jack output is right channel sound, while **LINE OUT L/MONO** jack output is left channel sound. Connecting to the **LINE OUT L/MONO** jack only outputs a mixture of both channels. It is up to you to purchase connecting cable like the one shown in the illustration for connection of the amplifier. Use the piano's **VOLUME** controller to adjust the volume level.

Bundled and Optional Accessories

Use only accessories that are specified for use with this digital piano.

Use of unauthorized accessories creates the risk of fire, electric shock, and personal injury.

Selecting and Playing a Tone

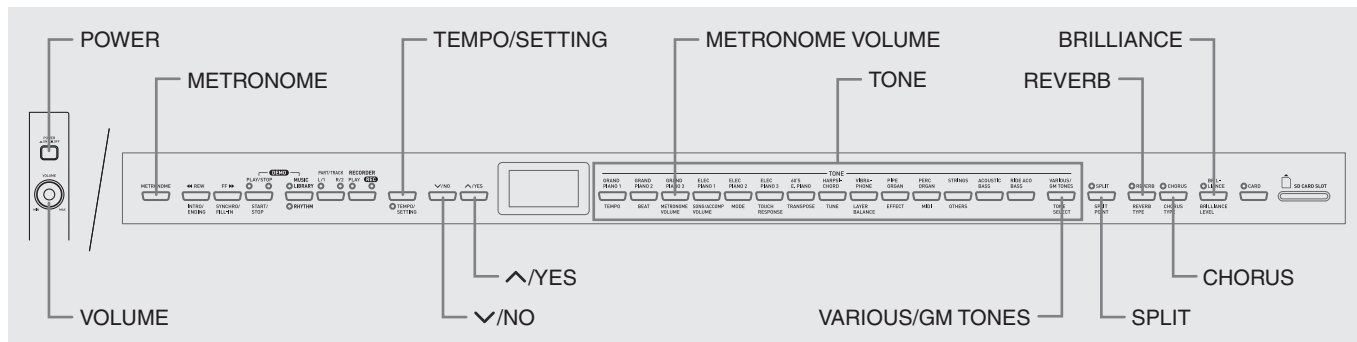

Your digital piano has the following types of tones built in.

Tone Numbers	Tone Type	Number of Tones
—	Main Tones	14
001 to 020	Various	20
021 to 148	GM (General MIDI)	128
149, 150	Drum Sets	2 sets

Selecting a Main Tone

1. Press the **POWER** button.

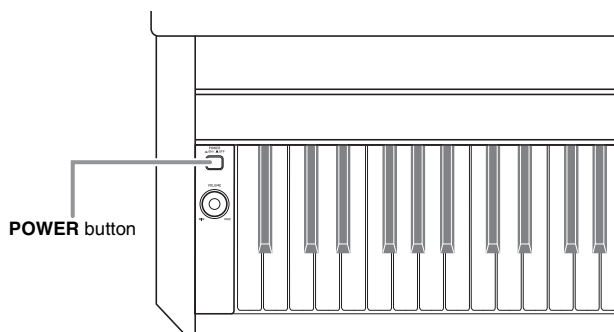

IMPORTANT!

- When you turn on the digital piano, it performs a power up operation in order to prepare its system. The power up operation takes about 10 seconds, and is indicated by the following messages appearing on the display.

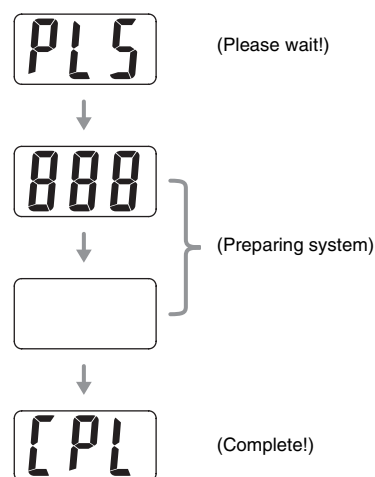

- Use the **VOLUME** controller to adjust the volume level.
- Press one of the 14 **TONE** buttons to select the tone you want.
 - The names of the main tones are marked above the **TONE** buttons.
 - This will cause the lamp of the selected tone's button to light.

Example: GRAND PIANO 3

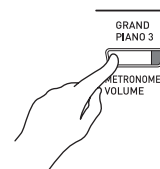

NOTE

- The DSP effect (pages E-26 and E-28) will be applied if you select a tone with DSP.
- Note that the digital piano's DSP resources are limited. Because of this, selecting a tone with DSP can cause notes that are currently being played to cut off (if they are being played using a tone with DSP), or it can remove the DSP effect from an operation (layer, split, demo song) that was previously assigned a tone with DSP.

Selecting a Various tone, GM tone, and Drum set

You can use the following procedure to assign one of the 20 Various tones, 128 GM tones, or 2 Drum sets to the **VARIOUS/GM TONES** button. After that you can select the assigned tone by pressing the **VARIOUS/GM TONES** button.

1. In the Tone List on page A-1, find the tone number of the Various tone, GM tone, and Drum set you want to assign to the **VARIOUS/GM TONES** button.

Example: 003 DANCE PIANO

2. Press the **VARIOUS/GM TONES** button.

- This will cause the lamp above the button to light.
- To find out the tone that is currently assigned to the **VARIOUS/GM TONES** button, hold down the button. This will cause the number of its tone to appear on the display. Releasing the button will return to the song or rhythm number display.

Example: 001 MELLOW PIANO



3. To change the tone assigned to the **VARIOUS/GM TONES** button, hold down the button as you use the **∇/NO** and **∧/YES** buttons to scroll through the tone numbers on the display. Display the number of the tone you want to assign to the button.



- Holding down either button changes the value at high speed.

NOTE

- See "Other Settings" on page E-25 for information about another method you can use to assign a tone to the **VARIOUS/GM TONES** button.
- The tone you assign to the **VARIOUS/GM TONES** button is retained until you turn off the digital piano.
- If a drum set is assigned to the **VARIOUS/GM TONES** button, keyboard keys sound drum sounds when you press them while the lamp above the **VARIOUS/GM TONES** button is lit. See page A-2 for information about the drum sounds that are assigned to each of the keyboard keys.

Adjusting the Brilliance of a Tone

Use the following procedure to adjust the brilliance of a tone.

1. Press the **BRILLIANCE** button.
 - This will cause the lamp above the button to light, indicating that the brilliance effect is being applied. This also will change the brilliance of the tone in accordance with the initial setting.
2. To change the brilliance setting, hold down the **BRILLIANCE** button as you press the **∇/NO** and **∧/YES** buttons.

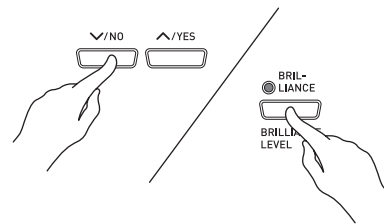

To do this:	Press this button:
Make the tone softer	∇
Make the tone sharper	∧



3. To cancel the brilliance effect, press the **BRILLIANCE** button again so its lamp goes out.

NOTE

- Pressing the **∇/NO** and **∧/YES** buttons at the same time will return the displayed setting to its default.
- See "Other Settings" on page E-25 for information about another method you can use to configure brilliance settings.

Layering Two Tones

Use the following procedure to layer two tones, so they sound at the same time. The tone you specify first is called the “main tone”, while the tone you specify second is called the “layered tone”.

NOTE

- To use a Various tone or GM tone as the main tone, you must first assign it to the **VARIOUS/GM TONES** button (page E-9).
- You can use a Various tone or GM tone assigned to the **VARIOUS/GM TONES** button as either the main tone or the layered tone. You cannot use Various/GM tones at the same time for both the main tone and layered tone.

1. While holding down the **TONE** button of the tone that corresponds to the main tone, press the button that corresponds to the layered tone.

Example: While holding down the **GRAND PIANO 2** button, press the **STRINGS** button.

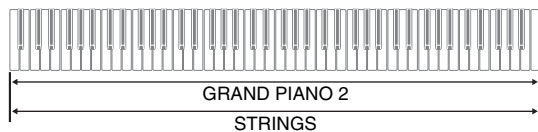
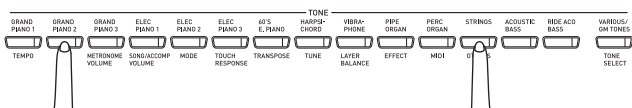

NOTE

- If you press the **VARIOUS/GM TONES** button to assign its tone as the layered (second) tone, the number of the currently assigned tone will appear on the display when you hold down the **VARIOUS/GM TONES** button.
- While holding down the **VARIOUS/GM TONES** button, you can use the **∨/NO** and **∧/YES** buttons to scroll through tone numbers and change the tone assignment.



2. To unlayer the keyboard, press any one of the **TONE** buttons.

NOTE

- You can adjust the balance between the main tone and layered tone. See “Other Settings” on page E-25 for more information.

Splitting the Keyboard between Two Tones

You can assign different tones to keys on the left side (low range) and the right side (high range) of the keyboard.

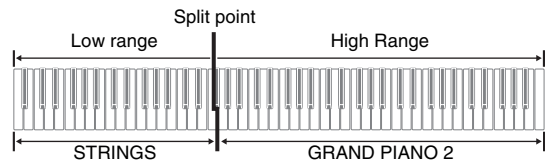

1. Press the **TONE** button of the tone you want to select for the high range.

Example: GRAND PIANO 2

2. Press the **SPLIT** button.

- This will cause the **SPLIT** lamp to light.

3. Press the **TONE** button of the tone you want to select for the low range.

Example: STRINGS

4. After you are finished using the split keyboard, press the **SPLIT** button again to unsplit it.

- This will cause the **SPLIT** lamp to go out.

NOTE

- You can configure the keyboard so it is layered with two tones in the high range. To do this, first perform the layer operation (page E-10). After that, split the keyboard as described above.

To specify the keyboard split point

1. While holding down the **SPLIT** button, press the keyboard key where you want the left limit of the high range (right) tone to be.

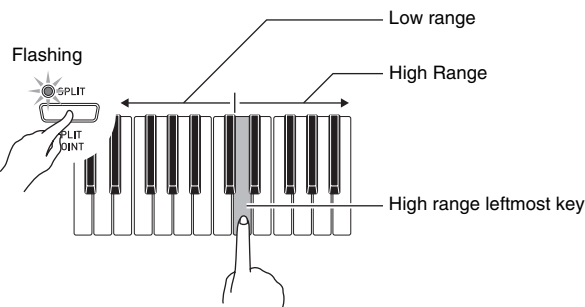

NOTE

- The split point also is the boundary between the accompaniment keyboard range (pages E-15 to E-17) and the melody keyboard range. You can change the location of the split point, which also changes the sizes of the keyboards.
- See "Other Settings" on page E-25 for information about another method you can use to change the split point.

Using Effects

Reverb Makes your notes resonate.

Chorus Adds more breadth to your notes.

To turn effects on and off

1. Use the **REVERB** and **CHORUS** buttons to turn the effects on and off as shown below.
 - The lamps above the buttons show whether the effects are on or off.

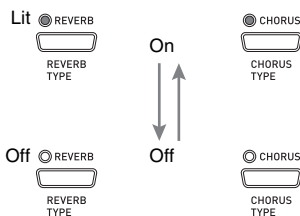

To change the effect type

1. Turn on **REVERB** or **CHORUS**.
2. While holding down the effect button (**REVERB** or **CHORUS**), use the **∨/NO** and **∧/YES** buttons to change the effect type as described below.

[Reverb]

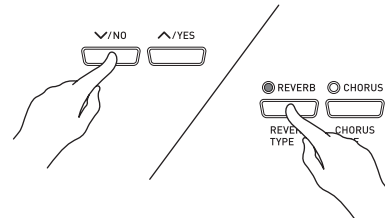

- Reverb Value

- 1: Room
- 2: Small Hall
- 3: Large Hall
- 4: Stadium

[Chorus]

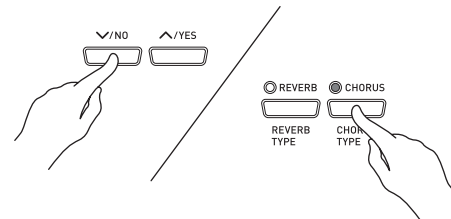

- Chorus Value

- 1: Light Chorus
- 2: Medium Chorus
- 3: Deep Chorus
- 4: Flanger (Whooshing effect)

NOTE

- While the keyboard is layered, the chorus on/off setting affects the layered tone only. While the keyboard is split, the chorus on/off setting affects the low range tone only.

Using the Digital Piano's Pedals

Your digital piano comes equipped with three pedals: damper, soft, and sostenuto

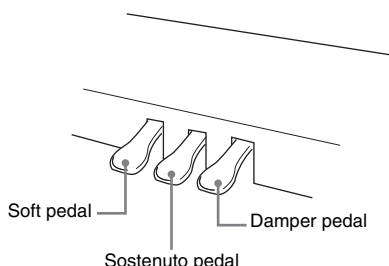

Pedal Functions

● Damper Pedal

Pressing the damper pedal while playing will cause the notes you play to reverberate for a very long time.

- When GRAND PIANO 1, GRAND PIANO 2, or GRAND PIANO 3 is selected as the tone, pressing this pedal will cause notes to reverberate just like the damper pedal on an acoustic grand piano. Half-pedal operation (pressing the pedal part way) is also supported.

● Soft Pedal

Pressing this pedal while playing suppresses notes played on the keyboard after the pedal was pressed, and makes them sound softer.

● Sostenuto Pedal

Only the notes that are played while this pedal are depressed are sustained until the pedal is released.

Using the Metronome

1. Press the **METRONOME** button.
 - This will start the metronome.
 - The two lamps above the **START/STOP** button will flash along with the metronome beats.



2. To change the beat, hold down the **METRONOME** button as you press the **∇/NO** or **∧/YES** button.



- You can select a beat value in the range of 2 through 6. A chime sounds as the first beat of each measure, and the remaining beats sound as clicks. Specifying 0 as the setting plays a straight click, without any chime. This setting lets you practice with a steady beat.

3. Press the **TEMPO/SETTING** button.
 - This will cause the button's lamp to flash.

4. Use the **∇/NO** and **∧/YES** buttons to adjust the tempo in a range of 20 to 255 beats per minute.

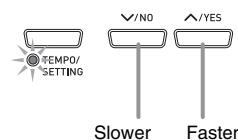

5. Press the **TEMPO/SETTING** button again.
 - This will cause the lamp above the button to go out.
6. Press the **METRONOME** button again to stop the metronome.

NOTE

- See "Other Settings" on page E-25 for information about another method you can use to configure the metronome setting.

To adjust the metronome volume

NOTE

- You can perform the following procedure at any time, regardless of whether or not the metronome is sounding.

1. Press the **TEMPO/SETTING** button.
 - This will cause the lamp above the button to flash.
2. Press the **METRONOME VOLUME** button.
 - This will cause the lamp above the button to flash.
3. Use the **∨/NO** and **∧/YES** buttons to change the metronome volume in the range of 0 to 42.



4. Press the **TEMPO/SETTING** button again.
 - This will cause the lamp above the button to go out.

Playing a Rhythm

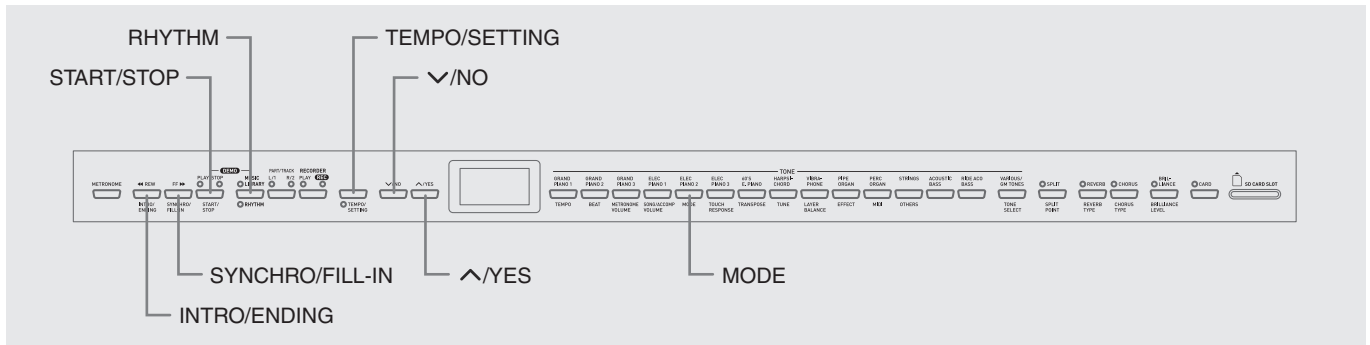

Selecting a Rhythm

You can select from among 20 built-in rhythms.

1. Press the **RHYTHM** button so the lamp below it is lit.
 - Each press of the button toggles between the upper lamp and lower lamp.

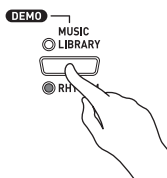

- This will cause the currently selected rhythm number to appear on the display.



2. Find the rhythm number of the rhythm you want to use in the Rhythm List on page A-3.
3. Use the **∨/NO** and **∧/YES** buttons to scroll through the rhythm numbers until the one you want is displayed.



4. Press the **START/STOP** button.
 - This will start the rhythm.
5. Press the **START/STOP** button again to stop the rhythm.

To adjust playback tempo

1. Press the **TEMPO/SETTING** button.
 - This will cause the button's lamp to flash.
2. Use the **∨/NO** and **∧/YES** buttons to change the tempo in the range of 20 to 255.
3. Press the **TEMPO/SETTING** button again.
 - This will cause the lamp above the button to go out.

Using Auto Accompaniment

With Auto Accompaniment, the digital piano automatically plays rhythm, bass, and chord parts in accordance with chords you select using simplified keyboard fingerings, or chords you play. Auto Accompaniment makes it feel like you have your own private backup group with you all the time.

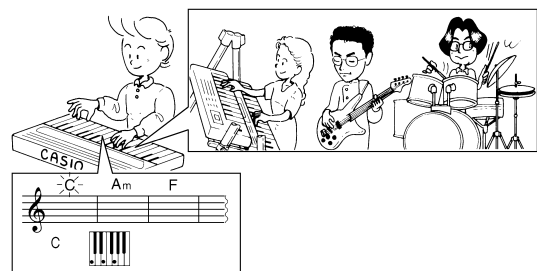

NOTE

- With the rhythms listed below, make sure that CASIO CHORD, FINGERED, or FULL RANGE CHORD is selected before you try playing chords. The volume of percussion instruments is very low, and percussion is inserted in a way that does not interfere with the overall mood of the rhythm.

10	ROCK'N'ROLL
14	ARPEGGIO 1
15	ARPEGGIO 2
16	MARCH 1
17	MARCH 2
18	STRIDE PIANO
19	WALTZ 1
20	WALTZ 2

To play with Auto Accompaniment

PREPARATION

- Use the procedures under "Selecting a Rhythm" to select the rhythm you want to use and adjust the tempo.

1. Press the **TEMPO/SETTING** button.
 - This will cause the button's lamp to flash.
2. Press the **MODE** button.
3. Use the **∨/NO** and **∧/YES** buttons to select one of the Auto Accompaniment modes shown below.

Display Indicator	Meaning
oFF	NORMAL
C.C.	CASIO CHORD
FnG	FINGERED
FUL	FULL RANGE CHORD

- Here we will select the CASIO CHORD mode.



- See "How to Play Chords" on page E-16 for details about Auto Accompaniment modes and their chord fingerings.

4. Press the **TEMPO/SETTING** button again.
 - This will cause the lamp above the button to go out.
5. Press the **SYNCHRO/FILL-IN** button.
 - This configures the digital piano so rhythm and chord accompaniment will start automatically when you press any keys within the accompaniment keyboard range.
 - This will cause the two lamps above the **START/STOP** button to flash.

6. Press the **INTRO/ENDING** button.

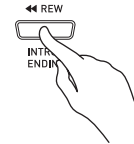

7. Finger the first chord within the accompaniment keyboard range.

- Playing a chord will cause the intro pattern for the selected rhythm to play, followed by the accompaniment rhythm and chord pattern.

8. Finger other chords on the keyboard.

- See "How to Play Chords" on page E-16 for information about how to finger chords within the different Auto Accompaniment modes.
- The two lamps above the **START/STOP** button will flash along with the beat.

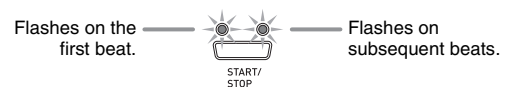

NOTE

- You can insert a fill-in pattern while a rhythm pattern is playing by pressing the **SYNCHRO/FILL-IN** button. A fill-in helps to change the mood of the pattern.

9. To stop accompaniment, press the **INTRO/ENDING** button.

- This will play an ending pattern for the selected rhythm before stopping Auto Accompaniment play.

NOTE

- You can stop accompaniment play without an intro and ending pattern by pressing the **START/STOP** button in place of steps 6 or 9.
- See "Other Settings" on page E-25 for information about adjusting accompaniment volume.

How to Play Chords

The way you finger chords depends on the current Auto Accompaniment mode. If you want to play without Auto Accompaniment, use the NORMAL mode.

■ CASIO CHORD

Even if you do not know how to play chords normally, this mode lets you play four different types of chords using simplified fingerings in the accompaniment keyboard range of the keyboard. The following shows where the accompaniment keyboard range is located, and explains how to finger chords in the CASIO CHORD mode.

CASIO CHORD Mode Keyboard

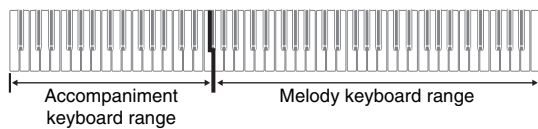

IMPORTANT!

- In the CASIO CHORD mode, the keys in the accompaniment keyboard range of the keyboard operate as “chord switches” only. You cannot use the keys in this keyboard range to play notes.
- You can use the split point to change the size of the accompaniment keyboard range. See “To specify the keyboard split point” on page E-11 for more information.

Chord Types	Example:
Major Chords Pressing a single accompaniment keyboard range key in the CASIO CHORD mode will play the major chord whose name is marked above the key. All of the accompaniment keyboard range keys that are marked with the same chord name play exactly the same chord.	C (C Major) Note →
Minor Chords To play a minor chord, press the accompaniment keyboard range key that corresponds to the major chord, while also pressing one other accompaniment keyboard range key to the right.	Cm (C Minor)
Seventh Chords To play a seventh chord, press the accompaniment keyboard range key that corresponds to the major chord, while also pressing two other accompaniment keyboard range keys to the right.	C7 (C Seventh)
Minor Seventh Chords To play a minor seventh chord, press the accompaniment keyboard range key that corresponds to the major chord, while also pressing three other accompaniment keyboard range keys to the right.	Cm7 (C Minor Seventh)

NOTE

- When playing a minor, seventh, or minor seventh chord, it makes no difference whether the additional keys you press are black or white.

■ FINGERED

In the FINGERED mode, you play standard chord fingerings in the accompaniment keyboard range to play chords. To finger a C chord, for example, you would press the C-E-G keys.

FINGERED Mode Keyboard

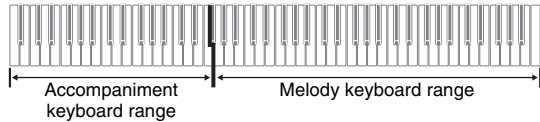

IMPORTANT!

- In the FINGERED mode, the keys in the accompaniment keyboard range of the keyboard operate as “chord switches” only. You cannot use the keys in this keyboard range to play notes.
- You can use the split point to change the size of the accompaniment keyboard range. See “To specify the keyboard split point” on page E-11 for more information.

C 	Cm 	Cdim
Caug^{*1} 	Csus4 	C7^{*2}
Cm7^{*2} 	CM7^{*2} 	Cm7-5
C7-5^{*1} 	C7sus4 	Cadd9
Cm add9 	CmM7^{*2} 	Cdim7^{*1}

NOTE

- See the “Fingered Chord Chart” on page A-4 for information about fingering chords with other roots in the accompaniment keyboard range.

*1 Inverted fingerings (see “Fingered Chord Notes” on page E-17) are not supported for these chords. The lowest note fingered is used as the root.

*2 For these chords, the same chord is specified even if the G fifth is not fingered

Fingered Chord Notes

- Except for the chords whose names have *1 after them in the above examples, you also can use inverted fingerings. This means that fingering either E-G-C or G-C-E will produce a C chord.
- Except for the chords whose names have *2 after them in the above examples, you need to press all of the indicated keys in order to finger a chord. Failure to include even a single note may produce a chord that is different from the one you want.

■ FULL RANGE CHORD

The FULL RANGE CHORD mode lets you play a total of 38 different types of chords (the same chords available in the FINGERED mode plus 23 more). FULL RANGE CHORD recognizes the pressing of three or more keyboard keys anywhere on the keyboard as a chord fingering. Anything else (pressing one or two keys, or playing any group of notes that does not form a chord fingering that is recognized by the keyboard) is treated as melody notes.

FULL RANGE CHORD Mode Keyboard

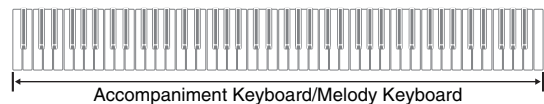

● Recognized Chords

Type	Chord Types
FINGERED Mode Chords	15 (See “FINGERED” on page E-17.)
Other Chords	23 For example, the following are chords that have C as the bass note. C ₆ , Cm ₆ , C ₆₉ D ^b / _C , D/ _C , E/ _C , F/ _C , G/ _C , A ^b / _C , B ^b / _C , B/ _C , D ^b m/ _C , Dm/ _C , Fm/ _C , Gm/ _C , Am/ _C , B ^b m/ _C , Ddim/ _C , A ^b 7/ _C , F7/ _C , Fm7/ _C , Gm7/ _C , A ^b add9/ _C

Example: C Major or $\frac{C}{E}$ chord

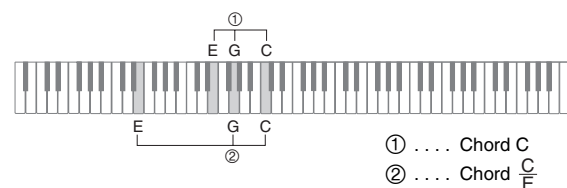

NOTE

- When there are at least six semitones between the lowest note and the next note to the right, the lowest note is assumed to be the bass note.

Playing Back a Specific Music Library Song

The Music Library includes both built-in songs (01 to 60), plus up to 10 songs (61 to 70) that have been saved to digital piano memory from a computer* or SD memory card (page E-33). You can use the procedure below to select one of these songs and play it back.

* You can download music data from the Internet and then transfer it from your computer to digital piano memory. See "Expanding the Selections in the Music Library" on page E-32 for more information.

1. Press the **MUSIC LIBRARY** button so the lamp above the button is lit.

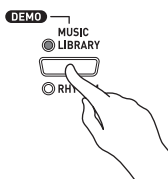

- Each press of the button toggles between the upper lamp and lower lamp.
- This will cause the currently selected song number to appear on the display.



2. Find the song number of the song you want to play in the Song List on page A-3.

3. Use the **∨/NO** and **∧/YES** buttons to select a song.



4. Press the **PLAY/STOP** button.

- This starts the playback of the song.
- The measure number appears on the display during playback.



Measure number

NOTE

- To view the song number during playback, hold down the **MUSIC LIBRARY** button.
- While playback is in progress, you can press the **∨/NO** or **∧/YES** button to change to another song.

5. Press the **PLAY/STOP** button again to stop playback.
 - Playback will stop automatically when the end of the song is reached.

NOTE

- Pressing the **∨/NO** and **∧/YES** buttons at the same time will select Music Library song number 01.

Skipping Back through a Song

1. While playback is in progress, hold down the **REW** button.

- This skips back through the song measure-by-measure.
- The measure number appears on the display while you are skipping back.



Measure number

2. When you reach the point you want, release the **REW** button to resume playback.

NOTE

- Depending on what is being played when you press the **REW** button, the skip back operation may not start right away when you press it.

Skipping Forward through a Song

1. While playback is in progress, hold down the **FF** button.

- This skips forward through the song measure-by-measure.
- The measure number appears on the display while you are skipping forward.



Measure number

2. When you reach the point you want, release the **FF** button to resume playback.

NOTE

- You can change tempo, volume, and pre-count settings for playback. See "Other Settings" on page E-25 for more information.

Practicing with a Music Library Song

You can turn off the left hand part or right hand part of a Music Library song and play along on the digital piano.

NOTE

- The Music Library includes a number of duets. While a duet is selected, you can turn off the first piano <Primo> or second piano <Secondo> tone and play along with the song.

PREPARATION

- Select the Music Library song you want to practice and adjust the tempo.
- A number of tunes have tempo changes part way through in order to produce specific musical effects.

1. Use the **PART/TRACK** button to turn off a part.

- Each press of the **PART/TRACK** button cycles through the part settings as shown below. The lamps above the button show which part is turned off.

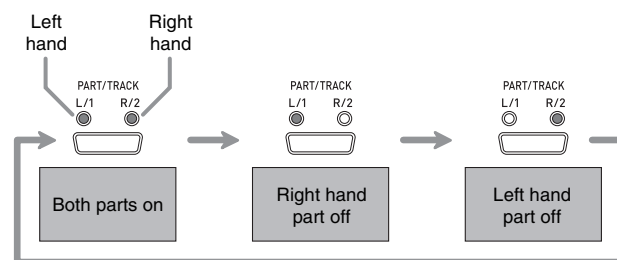

2. Press the **PLAY/STOP** button.
 - This starts playback, without the part you turned off in step 1.
3. Play the missing part on the keyboard.
4. Press the **PLAY/STOP** button again to stop playback.

Recording and Play Back

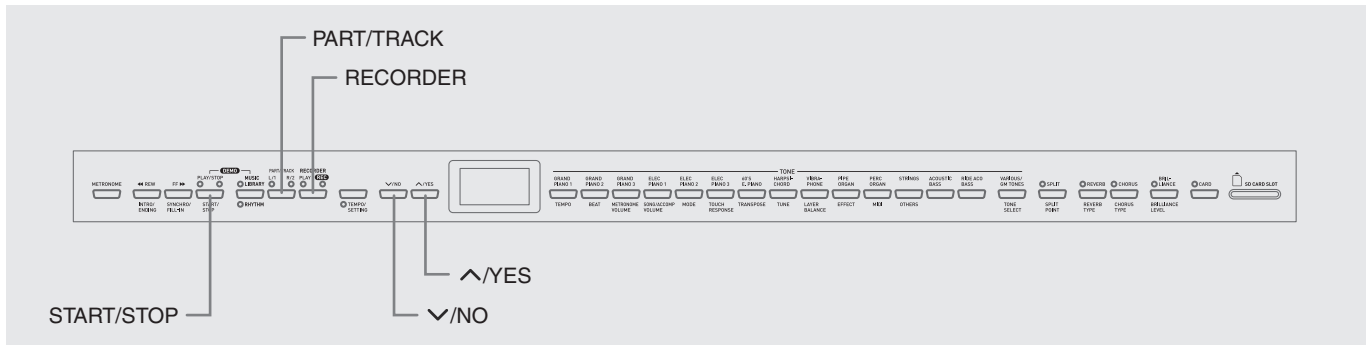

You can store the notes you play in digital piano memory for later playback. You can have up to five songs in memory at one time.

Songs and Tracks

A track is a container of recorded data, and each song consists of two tracks: Track 1 and Track 2. You can record each track separately and then combine them so they play back together as a single song.

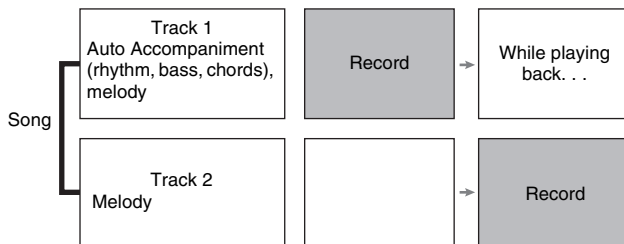

Memory Capacity

- Digital piano memory can hold about 50,000 notes total, for five songs. Each song can contain up to about 10,000 notes.
- Recording will stop automatically and the REC lamp will go out if the number of notes in memory exceeds the maximum.

Recorded Data

- Keyboard play
- Tone used
- Pedal operations

■ Track 1 only

- Tempo setting
- Layer and split settings
- Reverb and chorus settings
- Rhythm Patterns
- Chord fingering
- Intro, fill-in, ending operations

Recording Data Storage

- Starting a new recording deletes any data that was previously recorded in memory.
- Should power fail during recording, all of the data in the track you are recording will be deleted.
- You can save memory data to external media, if you want. See “Using an SD Memory Card” on page E-33 for more information.

IMPORTANT!

- CASIO COMPUTER CO., LTD. takes no responsibility for any damages, lost profits, or claims by third parties arising from the deletion of recorded data due to malfunction, repair, or for any other reason.
- After you select a song, it can take a number of seconds for the song data to be loaded. While the data is being loaded, the song number will flash on the display, and the keyboard keys and button operations will be disabled. If you are playing something on the keyboard, the following operation will cause output to stop.

Using the RECORDER Button

Each press of the **RECORDER** button cycles through the recording options in the sequence shown below.

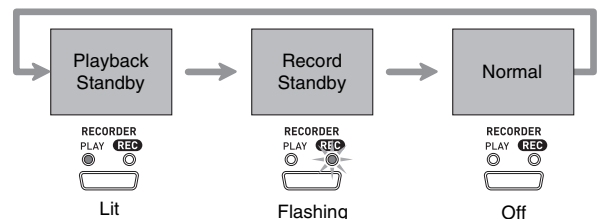

Recording Your Keyboard Play

After recording to either of the tracks of a song, you can record to the other track while listening to playback what you recorded in the first track.

To record to a specific track of a specific song

1. Press the **RECORDER** button so the **PLAY** lamp is lit.

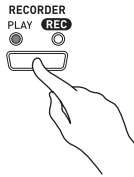

2. Use the **∨/NO** and **∧/YES** buttons to display a song number (1 to 5).



3. Press the **RECORDER** button so the **REC** lamp is flashing.

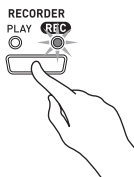

- At this time the L/1 lamp will flash to indicate that the digital piano is standing by for recording to Track 1.



4. Use the **PART/TRACK** button to select the track to which you want to record.

- Make sure that the lamp for the record track is flashing.

Track 1: L/1 lamp

Track 2: R/2 lamp

NOTE

- If you want to record with rhythm or Auto Accompaniment, select Track 1 (L/1 lamp flashing).

5. Select the tone and effects you want to use in your recording, and set the tempo you want. If you are recording to Track 1, you also can select a rhythm and accompaniment mode.

- Tone (page E-8)
- Effect (page E-11)
- Tempo (page E-14)
- Track 1 only
- Rhythm (page E-14)
- Mode (page E-16)

NOTE

- It is a good idea to use a relatively slow tempo when recording.
- If you want the metronome to sound during recording, press the **METRONOME** button.

6. Start playing something on the keyboard.

- Recording will start automatically.

NOTE

- When recording to Track 1 with rhythm or Auto Accompaniment: Press the **START/STOP** button to start recording. You also can start recording by pressing the **SYNCHRO/FILL-IN** button and/or the **INTRO/ENDING** button, and then play a chord.
- When recording to Track 1 without rhythm or Auto Accompaniment: Recording will start as soon as you play anything on the keyboard.

7. When you are finished, press the **START/STOP** button to stop recording.

- To stop recording with a rhythm/Auto Accompaniment ending pattern, press the **INTRO/ENDING** button.
- This will cause the REC lamp to go out and the PLAY lamp to light.
- To play back the track you just recorded, press the **START/STOP** button again.

8. After you are finished recording or playing back, press the **RECORDER** button so the **PLAY** lamp and **REC** lamp are off.

To record to one track of a song while listening to the playback of the other track

1. Press the **RECORDER** button so the **PLAY** lamp is lit.

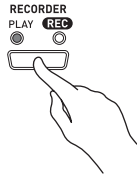

2. Use the **∨/NO** and **∧/YES** buttons to display a song number (1 to 5).



This indicator appears when the track contains recorded data already.

3. Press the **RECORDER** button so the **REC** lamp is flashing.

- This will cause the L/1 lamp to flash.

4. Use the **PART/TRACK** button to select the track to which you want to record.

- Make sure that the lamp for the record track is flashing.

Example: To listen to playback of Track 1 as you record to Track 2

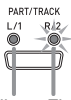

Lit: Playback standby Flashing: Record standby

5. Select the tone and effects you want to use for your recording.
6. Press the **START/STOP** button or play something on the keyboard to start simultaneous playback from Track 1 and recording to Track 2.
 - This will start both playback of the recorded track and recording to the other track.
7. When you are finished, press the **START/STOP** button again to stop recording.

Playing Back from Digital Piano Memory

1. Press the **RECORDER** button so the **PLAY** lamp is lit.

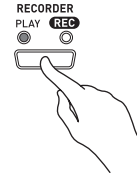

2. Use the **∨/NO** and **∧/YES** buttons to display a song number (1 to 5).



NOTE

- When a song has something recorded in both tracks, you can turn off one track and play back just the other track, if you want. Whether a track is on or off is indicated by the lamps above the **PART/TRACK** button. Each press of the **PART/TRACK** button cycles through the different possible track on/off settings.

3. Press the **START/STOP** button.

- This starts playback of the song and/or track you selected.

NOTE

- You can change the tempo setting as a track is playing.
- You cannot change the tone setting during playback.
- Press the **START/STOP** button again to stop playback.

Deleting Recorded Data

The following procedure deletes a specific track of a song.

IMPORTANT!

- The procedure below deletes all of the data of the selected song. Note that the delete operation cannot be undone. Check to make sure you really do not need the data in digital piano memory before you perform the following steps.

1. Press the **RECORDER** button so the **PLAY** lamp is lit.
2. Use the **∨/NO** and **∧/YES** buttons to display a song number (1 to 5).
3. Press the **RECORDER** button so the **REC** lamp is flashing.

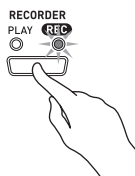

4. Use the **PART/TRACK** button to select the track you want to delete.
 - This will cause the lamp of the selected track to flash.
5. Hold down the **RECORDER** button until "dEL" (dELete) appears on the display.



6. Press the **∧/YES** button.
 - This will delete the selected track and enter record standby.
 - To cancel the operation, press the **∨/NO** button in place of the **∧/YES** button.

Other Settings

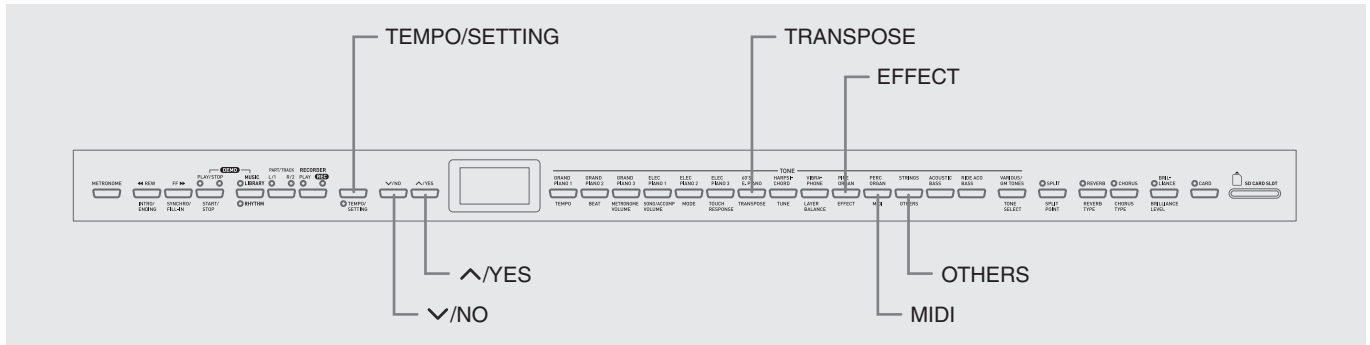

This section explains how to configure key, touch, MIDI, and other settings.

- The basic procedure below is used for configuring all settings. The only difference is the button that you press to select a parameter.
- See the “Secondary Parameter Reference” on page E-27 for details about the settings you can configure using this procedure.

Configuring Settings

1. Use the “Secondary Parameter Reference” on page E-27 to find the parameter whose setting you want to configure, and note the applicable parameter button name.

Example: To change key, you would need to use the **TRANSPOSE** button.

2. Press the **TEMPO/SETTING** button.
 - This will cause the button’s lamp to flash.



3. Press the button you looked up in step 1.
 - The button’s lamp will flash and the current setting of the parameter you are configuring will appear on the display.

Example: **TRANSPOSE** button

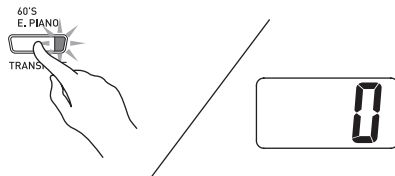

- If the button has multiple parameters assigned to it, keep pressing the button until the parameter you want to configure is displayed. See “Multiple Parameter Buttons” below for more information.

4. Use the **✓/NO** and **^/YES** buttons to change the setting of the displayed parameter.

Example: Lower the transpose setting by one semitone by changing the displayed value to -1.



5. Press the **TEMPO/SETTING** button to complete the procedure.

- This will cause the button’s lamp to go out.

NOTE

- Pressing the **✓/NO** and **^/YES** buttons at the same time will change the displayed parameter to its default setting.

Multiple Parameter Buttons

The **EFFECT**, **MIDI**, and **OTHERS** buttons have more than one parameter assigned to them. Use the procedures below to select the parameter whose setting you want to change.

To change the setting of one of the EFFECT button parameters

Pressing the **EFFECT** button in step 3 of the “Configuring settings” procedure will toggle between the two parameters shown below.

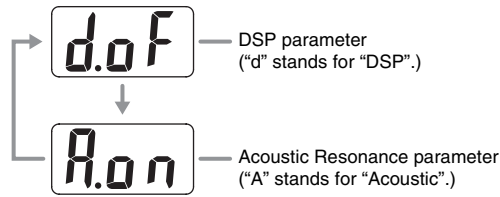

NOTE

- While the keyboard is layered, the DSP on/off setting affects the layered tone only. While the keyboard is split, the DSP on/off setting affects the low range tone only.
- Turning on DSP will apply the DSP effect to tones with DSP only. It will not be applied to any other type of tone.
- Turning on Acoustic Resonance will apply the Acoustic Resonance effect to tones that support Acoustic Resonance only. It will not be applied to any other type of tone.

To change the setting of one of the MIDI button parameters

Pressing the **MIDI** button in step 3 of the “Configuring settings” procedure will cycle between the parameters shown below.

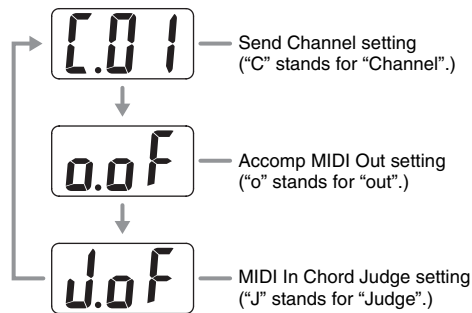

To change the setting of one of the OTHERS button parameters

Pressing the **OTHERS** button in step 3 of the “Configuring settings” procedure will cycle between the parameters shown below.

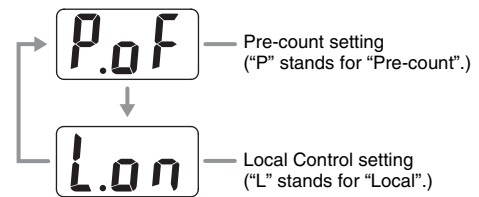

Secondary Parameter Reference









■ Keyboard

Setting	Parameter Name	Settings	Description
Keyboard touch response	TOUCH RESPONSE	oFF : Off 1 : Strong sound is produced even when relatively light pressure is applied. 2 : Normal 3 : Normal sound is produced even when relatively strong pressure is applied.	Specifies the relative touch of the keyboard keys.
Key	TRANSPOSE	-6 to 0 to 5	Raises or lowers the tuning of the digital piano in semitone steps.  NOTE <ul style="list-style-type: none"> Using TRANSPOSE to raise the key of the digital piano can cause notes at the highest range of a tone to become distorted.
Keyboard tuning	TUNE	-50 to 0 to 50	Raises or lowers the overall pitch of the digital piano to match another instrument. The setting range is plus or minus 50 cents (100 cents = 1 semitone) from the standard pitch of A4 = 440.0Hz.

■ Tones

Setting	Parameter Name	Settings	Description
VARIOUS/GM TONES button assignment	TONE SELECT	See "Tone List" on page A-1.	Assigns one of the digital piano's Various tone, GM tone, or Drum set to the VARIOUS/GM TONES button.
Layered tone volume balance	LAYER BALANCE	-24 to 0 to 24	Specifies the volume balance between layered tones. A lower value reduces the volume level of the layered tone.
Split point	SPLIT POINT	A0 to C8*	See page E-10.
Reverb type	REVERB TYPE	1 to 4	See page E-11.
Chorus type	CHORUS TYPE	1 to 4	See page E-11.
Brilliance level	BRILLIANCE LEVEL	-3 to -1, 1 to 3	See page E-9.
Acoustic Resonance	EFFECT	A.oF: Off A.on: On	<p>■ GRAND PIANO 1, GRAND PIANO 2, and GRAND PIANO 3 tones only</p> <p>When the damper pedal is pressed, acoustic resonance reproduces the harmonic resonance similar to that of a grand piano. This parameter turns acoustic resonance on or off. When configuring the setting of this parameter, use the procedure under "To change the setting of one of the EFFECT button parameters" on page E-26.</p>
DSP	EFFECT	d.oF: Off d.on: On	<p>■ Certain Tones Only</p> <p>DSP applies sophisticated acoustic effects to a tone. For example, it applies a rotary speaker effect to the drawbar organ tone. This parameter turns the DSP effect on or off. When configuring the setting of this parameter, use the procedure under "To change the setting of one of the EFFECT button parameters" on page E-26.</p> <p> NOTE</p> <ul style="list-style-type: none"> See the tone list on page A-1 for information about whether or not a tone is a tone with DSP, and for DSP types.

*Display Indicator

Display									
Settings	A	B	C	D	E	F	G	F#3	Bb5

■ Song, Rhythm, and Metronome

Setting	Parameter Name	Settings	Description
Tempo	TEMPO	20 to 255	Specifies the tempo of Music Library songs, the metronome, Auto Accompaniment playback, recording and playback, etc.
Metronome beat	BEAT	0, 2 to 6	Turns the metronome on or off.
Metronome volume	METRONOME VOLUME	0 to 42	Specifies the metronome volume.
Song, Auto Accompaniment volume	SONG/ACCOMP VOLUME	0 to 42	Specifies the volume of rhythm and chord accompaniment and built-in songs, independent of overall volume control.

Setting	Parameter Name	Settings	Description
Pre-count	OTHERS	P.oF: Off P.on: On	Turns the pre-count before playback of a Music Library song on or off. When configuring the setting of this parameter, use the procedure under "To change the setting of one of the OTHERS button parameters" on page E-26.  NOTE <ul style="list-style-type: none"> When playing a song from the user area or from an SD memory card, the pre-count may not sound, even though the pre-count setting is turned on.
Auto Accompaniment mode	MODE	oFF : NORMAL C.C. : CASIO CHORD FnG : FINGERED FUL : FULL RANGE CHORD	Specifies the Auto Accompaniment mode.

■ MIDI

Setting	Parameter Name	Settings	Description
Send channel	MIDI	C.01 to C.16	Specifies one of the MIDI channels (1 through 16) as the Send Channel, which is used for sending MIDI messages to an external device. When configuring the setting of this parameter, use the procedure under "To change the setting of one of the MIDI button parameters" on page E-26.
Accomp MIDI out	MIDI	o.oF: Off o.on: On	Use this parameter to specify whether or not MIDI messages should be sent in accordance with the digital piano's Auto Accompaniment and recording function playback. When configuring the setting of this parameter, use the procedure under "To change the setting of one of the MIDI button parameters" on page E-26.
MIDI In Chord judge	MIDI	J.oF: Off J.on: On	Specifies whether chord judge should be performed on accompaniment range MIDI Note On messages received from an external device. When configuring the setting of this parameter, use the procedure under "To change the setting of one of the MIDI button parameters" on page E-26.
Local control	OTHERS	L.oF: Off L.on: On	When Local Control is turned on, pressing the keyboard's keys plays the notes using the currently selected built-in tone, and also sends the applicable MIDI messages out the MIDI OUT port. Turning off Local Control cuts off the digital piano's sound source, so no sound is produced by the digital piano when keys are pressed. This capability comes in handy when you want to turn off the digital piano's keyboard and play on an external sequencer or other device. When configuring the setting of this parameter, use the procedure under "To change the setting of one of the OTHERS button parameters" on page E-26.

Connecting to a Computer

Connecting to the MIDI Terminal

What is MIDI?

MIDI is a standard for digital signals and connectors that allows musical instruments, computers, and other devices, regardless of manufacturer, to exchange data with each other.

NOTE

- For details about MIDI implementation, visit: <http://world.casio.com/>

MIDI Connections

Connecting your computer or other external MIDI device to the digital piano's **MIDI THRU/OUT/IN** terminals makes it possible for them to exchange MIDI messages. You also can playback notes you play on the digital piano on the connected device.

There is a third MIDI terminal named **MIDI THRU**, which passes any MIDI messages received by the **MIDI IN** terminal on to another device.

Bottom

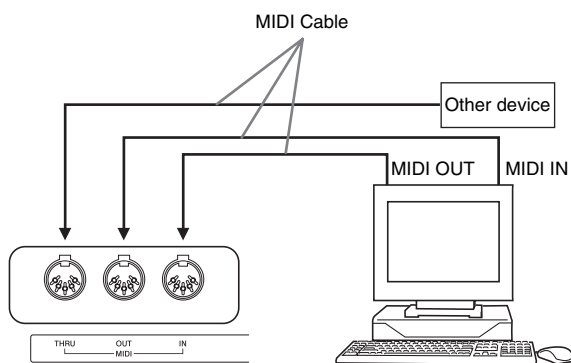

MIDI Settings

You can use the procedure in "Other Settings" (page E-25) to configure MIDI settings. See page E-27 for a description of the settings and information about how to configure them.

Connecting to the USB Port

The digital piano's **USB** port makes it quick and simple to connect to a computer.

You can install a USB MIDI driver from the CD-ROM that comes bundled with the digital piano onto a computer equipped with a USB port. After that, you can connect the digital piano to your computer and run commercially available MIDI software on your computer to exchange MIDI data with the digital piano. You also can use the USB connection to transfer files you downloaded from the CASIO MUSIC SITE from your computer to the digital piano.

You will need a commercially available USB cable to connect a computer to the digital piano's **USB** port.

To connect to a computer using the USB port

1. On the computer to which you plan to connect, install the USB MIDI driver from the CD-ROM that comes bundled with the digital piano.

NOTE

- Before installing the USB MIDI driver, be sure to read the contents of the "readme.txt" file in the "English" folder on the bundled CD-ROM.
- For details about how to install the USB MIDI driver, see the "CASIO USB MIDI Driver User's Guide" (manual_e.pdf)*¹ that also is on the bundled CD-ROM.

- Use a commercially available USB cable (A-B type) to connect the digital piano to the computer.

IMPORTANT!

- Make sure that the digital piano is turned off before connecting or disconnecting the USB cable to it.

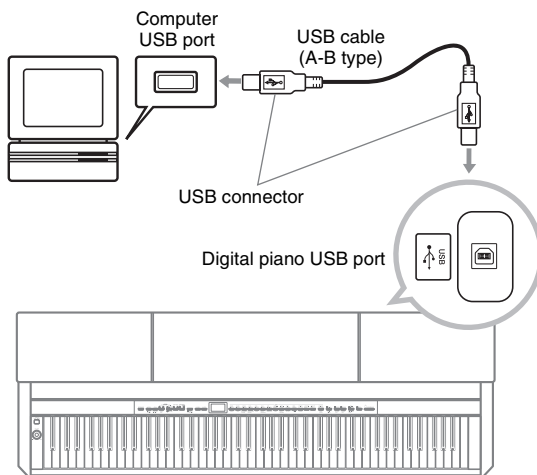

- *1 You need to have Adobe Reader or Acrobat Reader installed on your computer in order to view the contents of the "CASIO USB MIDI Driver User's Guide" (manual_e.pdf). If your computer does not have Adobe Reader or Acrobat Reader installed already, use the procedure below to install it.

To install Adobe Reader (Acrobat Reader*2)

- Place the CD-ROM that comes with the digital piano into your computer's CD-ROM drive.
 - On the CD-ROM, navigate to the "Adobe"/"English" folder and double-click "ar601enu.exe" (or "ar505enu.exe*2"). Follow the instructions that appear on your computer screen to install the driver.
- *2 Adobe Reader cannot be installed using the "ar601enu.exe" file on a computer running Windows 98. If your computer is running Windows 98, click "ar505enu.exe" to install Acrobat Reader.

Minimum Computer System Requirements

Supported Operating Systems

Windows® XP Professional, Windows® XP Home Edition, Windows® 2000 Professional, Windows® Me, Windows® 98SE, Windows® 98

Driver Minimum Computer System Requirements

The following are the minimum computer system requirements for running the USB MIDI driver.

- Universal**
 - IBM AT or compatible computer
 - USB port that provides normal operation under Windows
 - CD-ROM drive (for installation)
 - At least 2MB of free hard disk space (not including space required for Acrobat Reader)
- Windows XP**
 - Pentium 300MHz or higher
 - 128MB minimum memory
- Windows 2000**
 - Pentium 166MHz or higher
 - 64MB minimum memory
- Windows Me, Windows 98SE, Windows 98**
 - Pentium 166MHz or higher
 - 32MB minimum memory

USB Mode and MIDI Mode

Your digital piano has two data communication modes: a USB mode and a MIDI mode. The digital piano will enter the USB mode automatically whenever a connection is established between it and the USB driver running on a connected computer. If there is no computer connected to the USB port, the digital piano will enter the MIDI mode.

● USB Mode



The above indicator appears for about three seconds after a USB connection is established. For details about using the MIDI device functions in the USB mode, see the "CASIO USB MIDI Driver User's Guide" (manual_e.pdf) on the bundled CD-ROM.

● MIDI Mode



The above indicator appears for about three seconds after a USB connection terminated. The MIDI mode is used when sending and receiving data over the digital piano's MIDI terminals.

Expanding the Selections in the Music Library

You can store up to 10 songs you have downloaded with your computer as songs 61 through 70 of the Music Library and practice along with them as they play, just as you do with the built-in songs. You also can use the CASIO SMF conversion software (SMF Converter) to convert SMF data files you have purchased or created, and transfer them to the digital piano's Music Library.

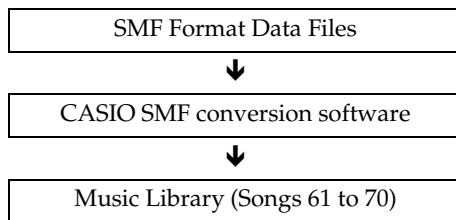

NOTE

- You will not be able to transfer data from a computer to the digital piano during playback or recording of song data, during a data save or recall operation, etc. Wait until the current operation is complete before transferring data.

To install the SMF conversion software (SMF Converter)

- Place the CD-ROM that comes with the digital piano into the CD-ROM drive of a computer that is equipped with a USB port.
- Navigate to the CD-ROM and then double-click the "SMFConv-e.exe" file. Next, follow the instructions that appear on your computer screen to install the software.
 - Before installing SMF Converter, be sure to read the contents of the "smfreadme.txt" file. A version of this file is provided in each language folder on the CD-ROM.

For information about using SMF Converter, double-click [index.html] in the [help] folder, which was created when you installed SMF Converter. You also can access user documentation from the Windows [Start] menu by clicking [Programs] – [CASIO] – [SMF Converter] – [manual].

A browser that supports frames (like Internet Explorer 4 or Netscape Navigator 4.04 or higher) is required to view the SMF Converter manual.

Minimum Computer System Requirements

● Operating System

Windows 98SE
Windows Me
Windows XP Professional
Windows XP Home Edition

● Storage

At least 10 MB of available disk space

● USB Interface

You also can download the SMF conversion software from the CASIO Website.



In addition to the software itself, the CASIO MUSIC SITE also will provide you with information about its installation and use. You also can find out the latest news about your digital piano and other CASIO musical instruments, and much more.

NOTE

- Your digital piano supports SMF Format 0 and Format 1.

Using an SD Memory Card

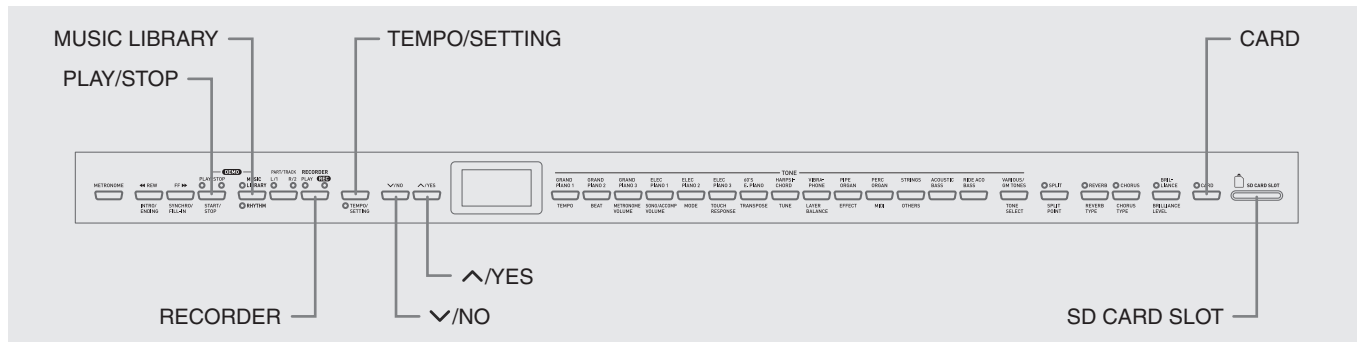

Your digital piano's SD memory card slot makes it possible for you to store song data on a commercially available SD memory card.



The digital piano also can read SMF song data and CASIO format song data from an SD memory card.

● Supported SD Memory Cards

The maximum supported SD memory card size is 1 GB. Use of any SD memory card with greater capacity is not supported.

● Supported Data File Types and SD Memory Card Operations

Data File Type	Display Indicator*1	File Name Extension	Supported SD Memory Card Operations
SMF Data (Format 0)	U (v)	.MID	Playback, transfer to user area, save to SD memory card*2
SMF Data (Format 1)*3	U (v)	.MID	Playback, transfer to user area
Song data converted to CASIO format using CASIO SMF conversion software (CASIO format)	C (d)	.CM2	Playback, transfer to user area
Song data recorded on the digital piano (CASIO format)	r (q)	.CSR	Transfer to recorder area, save to SD memory card

- *1 If the first two characters of the filename of song data is not a two-digit number from 01 to 99, the corresponding letter (according to data type) shown in the parentheses will be displayed as the data type indicator.
- *2 Song data recorded with the digital piano can be saved as SMF Format 0 data.
- *3 The digital piano will not be able to correctly play a file that has more than 17 tracks.

● Data File Display



Data File Type File Number (01 to 99)

IMPORTANT!

- Use only SD memory cards. Operation is not guaranteed when any other type of memory card is used.

SD Memory Card and SD Memory Card Slot Precautions

IMPORTANT!

- Whenever handling an SD memory card, be sure to observe the instructions and precautions in the user documentation that comes with it.
- SD memory cards have a write-protect switch that protects against accidental deletion of data.
- Avoid using an SD memory card in the following types of areas. Such conditions can corrupt data stored on the memory card.
 - Areas subjected to high temperature, high humidity, and corrosive gas
 - Areas subjected to strong electrostatic charge and digital noise
- Never touch the contacts of an SD memory card when loading it or removing it from the digital piano.
- Never remove the SD memory card from the digital piano or turn off the digital piano while it is reading data from or writing data to the memory card. Doing so can corrupt the data on the memory card and damage the SD memory card slot.

- Never insert anything besides an SD memory card into the SD memory card slot. Doing so creates the risk of malfunction.
- Inserting an SD memory card that carries an electrostatic charge into the SD memory card slot can cause malfunction of the digital piano. If this happens, turn the digital piano off and then back on again.
- An SD memory card can become quite warm after very long use in the SD memory card slot. This is normal and does not indicate malfunction.
- An SD memory card has a limited service life. After very long use, you may start to experience problems with storing data to, or reading or deleting data from the memory card. When this happens, you need to purchase a new SD memory card.

* Note that CASIO COMPUTER CO., LTD. shall not be held liable for any loss of data stored on an SD memory card.

Using an SD Memory Card with the Digital Piano

When using an SD Memory card, first be sure to format the memory card on the digital piano. For details, see "Formatting an SD Memory Card" on page E-38.

Inserting and Removing an SD Memory Card

IMPORTANT!

- Note that the SD memory card must be oriented correctly when you insert it into the SD memory card slot. Trying to force the memory card into the slot can damage the card and the slot.
- Never remove the SD memory card from the card slot or turn off the digital piano while any data access operation (save, recall, format) is being performed. Doing so can corrupt the data on the memory card and damage the SD memory card slot.

■ To insert an SD memory card

1. With the SD memory card facing upwards as shown in the illustration, angle the card downwards as you insert it into the SD memory card slot.
 - Push the card into the slot until you hear it click into place.

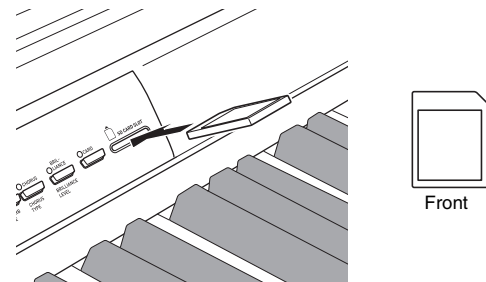

■ To remove an SD memory card

IMPORTANT!

- Before removing the SD memory card, check to make sure that the lamp above the **CARD** button is not lit. If the lamp is lit or flashing, it means that the card is being accessed, and that you should not remove it.
1. Press the memory card into the slot slightly and then release it.
 - This will cause the memory card to disengage and eject partially.
 2. Pull the memory card out of the slot.

Playing Back a File Stored on an SD Memory Card

Playback of SMF format data and song data converted using SMF conversion software to CASIO CM2 format.

IMPORTANT!

- Note the following important precautions whenever playing back a data file you copied to a memory card with a computer.
To perform the procedure below, you must have an SD memory card to which an SMF data file has been copied from a computer. Insert an SD memory card that has been formatted on the digital piano into the memory card slot of your computer, and copy the data file you want to play back from your computer into the memory card folder named "MUSICDAT". Note that you will not be able to play back the data on the digital piano if it is not located inside the "MUSICDAT" folder. If you create a sub-folder inside of the "MUSICDAT" folder, the digital piano will not be able to load any data file inside the sub-folder.
- After you select a song data, it can take a number of seconds for the song data to be loaded. While the data is being loaded, the song number will flash on the display, and the keyboard keys and button operations will be disabled. If you are playing something on the keyboard, the following operation will cause output to stop.

1. Press the **CARD** button.

- The **CARD** button lamp will light and a file number will appear on the display.



CASIO format song

2. Use the **∨/NO** and **∧/YES** buttons to display the song number of the song you want to play.

3. Press the **PLAY/STOP** button.

4. Press the **PLAY/STOP** button again to stop playback.

5. After you are finished using the SD memory card, press the **CARD** button so its lamp turns off.

NOTE

- You can change tempo, volume, and pre-count settings for playback. See "Other Settings" on page E-25 for more information.

Transferring Song Data from an SD Memory Card to Digital Piano Memory

You can use the procedures in this section to transfer song data from an SD memory card to the digital piano user area*¹ or recorder area.*²

*1 Music Library Songs 61 to 70

*2 Memory area where songs recorded on the digital piano are stored.

● Supported Data

User Area SMF format data and song data converted using SMF conversion software (CASIO CM2 format)

Recorder Area . . Song data recorded on the digital piano (CASIO CSR format)

PREPARATION

- Insert the SD memory card that contains the song data you want to transfer into the digital piano's SD memory card slot.

IMPORTANT!

- Never turn off the digital piano or perform any other operation while data is being recalled from an SD memory card. Doing so can cause SD memory card data to be deleted or damaged, making transfer of the data impossible. It also can cause deletion of data stored in the user area or recorder area to which you are saving the data.

To transfer song data from an SD memory card to the digital piano user area

1. Press the **MUSIC LIBRARY** button so the lamp above the button is lit.

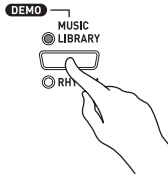

2. Use the **∨/NO** and **∧/YES** buttons to display the number of the user area song (Music Library song number 61 through 70) to which you want to transfer the song data.



This mark indicates that the currently displayed user area song number has data stored already.

3. Hold down the **CARD** button until its lamp starts to flash slowly and “LdU” (Load User area) appears on the display.
4. Use the **∨/NO** and **∧/YES** buttons to display the file number of the song data you want to transfer to digital piano memory.



5. When everything is the way you want, press the **TEMPO/SETTING** button to begin data transfer.
 - The message “CPL” (ComPLete) will appear on the display to let you know when data transfer is complete. The number of the user area song to which the data was transferred will be shown on the display.
 - To interrupt an ongoing data transfer operation, press the **CARD** button.
 - If the user area song number you select contains data already, pressing the **TEMPO/SETTING** button in step 5 will display “rEP” (rEPlace) to confirm that you want to replace the existing data with the data you are transferring. Press the **∧/YES** button to overwrite the data or the **∨/NO** button to cancel.

To transfer song data from an SD memory card to the recorder area

1. Press the **RECORDER** button so the PLAY lamp is lit.

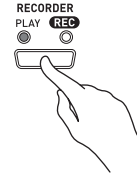

2. Use the **∨/NO** and **∧/YES** buttons to display the number of the recorder area song (1 through 5) to which you want to transfer the song data.



This mark indicates that the currently displayed song number has data stored already.

3. Hold down the **CARD** button until its lamp starts to flash slowly and “Ldr” (Load recorder area) appears on the display.
4. Use the **∨/NO** and **∧/YES** buttons to display the file number of the song data you want to transfer to digital piano memory.



5. When everything is the way you want, press the **TEMPO/SETTING** button to begin data transfer.
 - The message “CPL” (ComPLete) will appear on the display to let you know when data transfer is complete. The number of the recorder area song to which the data was transferred will be shown on the display.
 - To interrupt an ongoing data transfer operation, press the **CARD** button.
 - If the recorder area song number you select contains data already, pressing the **TEMPO/SETTING** button in step 5 will display “rEP” (rEPlace) to confirm that you want to replace the existing data with the data you are transferring. Press the **∧/YES** button to overwrite the data or the **∨/NO** button to cancel.

Saving Song Data Recorded on the Digital Piano to an SD Memory Card

You can save song data that you recorded to the digital piano's recorder area to an SD memory card as an SMF Format 0 file or a CASIO CSR file.

PREPARATION

- Insert an SD memory card that has been formatted on the digital piano into the digital piano's SD memory card slot. Make sure that the write-protect switch of the SD memory card is not in the write-protect position.

IMPORTANT!

- Never turn off the digital piano or perform any other operation while data is being saved to an SD memory card. Doing so can cause SD memory card data to be deleted and make impossible to store data to the card.

1. Press the **RECORDER** button so the **PLAY** lamp is lit.

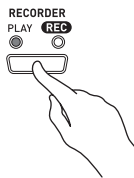

2. Use the **▽/NO** and **△/YES** buttons to select the song data (song number 1 through 5) you want to save.



3. Hold down the **CARD** button until its lamp starts to flash slowly and "Ldr" (Load recorder area) appears on the display.
4. Press the **CARD** button again.
 - This will cause the **CARD** button lamp to flash at a higher speed and "SvC" (Save as CSR file) to appear on the display. This setting will save song data in CASIO CSR format.
 - If you want to save the song data in SMF Format 0, press the **CARD** button again. This will cause "SvS" (Save as SMF0 file) to appear on the display.

5. Use the **▽/NO** and **△/YES** buttons to select the file number where you want to save the song data.



This mark indicates that the currently displayed file number on the SD memory card has data stored already.

6. When everything is the way you want, press the **TEMPO/SETTING** button to begin saving data.

- The message "CPL" (ComPLete) will appear on the display to let you know when the save operation is complete. After that, the digital piano will return to playback standby.
- To cancel the save operation, press the **CARD** button.
- If the SD memory card already contains a data file with the same file number, pressing the **TEMPO/SETTING** button in step 6 will display "rEP" (rEPlace) to confirm that you want to replace the existing file with the file you are saving. Press the **△/YES** button to overwrite the existing data file or the **▽/NO** button to cancel.

Formatting an SD Memory Card

Use the procedures in this section to format an SD memory card.

IMPORTANT!

- Before performing the procedure below, check to make sure that the SD memory card does not contain any data you might need.
- The SD memory card format performed by your digital piano is a “quick format”. If you want to completely delete all of the data on the card, format it on your computer or using some other device.

PREPARATION

- Insert the SD memory card you want to format into the digital piano’s SD memory card slot. Make sure that the write-protect switch of the SD memory card is not in the write-protect position.

To format an SD memory card

1. Press the **TEMPO/SETTING** button.
 - This will cause the button’s lamp to flash.
2. Press the **CARD** button.
 - This will cause “For” (Format) to flash on the display.
3. Press the **^/YES** button to start formatting.
 - “PLS” (PLeaSe wait) remains on the display while the formatting operation is performed. Never try to perform any other operation on the digital piano while the memory card is being formatted. The message “CPL” (ComPLete) will appear on the display to let you know when the format operation is complete.
 - To cancel the format operation, press the **▼/NO** button in place of the **^/YES** button in step 3.

SD Memory Card Errors

Display Message	Cause	Action
[noI]	No SD memory card loaded in the SD memory card slot or the card is not loaded correctly.	Correctly insert the SD memory card into the SD memory card slot. (Page E-34)
[noF]	You are trying to load data from an SD memory card that does not contain any data that is supported by this digital piano.	<ol style="list-style-type: none"> 1. Change to an SD memory card that contains data saved by or supported by this digital piano. 2. When copying data to an SD memory card from a computer, copy it to the "MUSICDAT" folder. (Page E-35)
[Er1]	The SD memory card is damaged or the card was removed while it was being accessed.	<ol style="list-style-type: none"> 1. Use an SD memory card that was formatted on the digital piano. (Page E-38) 2. Use a different SD memory card.
[Er2]	The SD memory card is full.	Use a different SD memory card.
[Er3]	An SD memory card was removed while some operation was in progress.	Never remove a card from the card slot while a card access operation is in progress.
[Er4]	Attempt to overwrite the song data file that is read-only.	Save the file to a different SD memory card or under a different number.
[Er5]	The data file you are trying to transfer to the digital piano is too large.	<p>When playing back a file stored on an SD memory card or loading data to the user area, select a data file that is no larger than about 318 KB.</p> <p>When loading song data to the recorder area, you only can select song data that was recorded on this model of digital piano.</p>
[Er6]	You are trying to load SMF (Standard MIDI File) data that is not Format 0 or Format 1.	Use only Format 0 or Format 1 SMF data.
[Er7]	You are trying to store data to an SD memory card that is write-protected.	<ol style="list-style-type: none"> 1. Use a different SD memory card. 2. If you want to write to the SD memory card, change the write-protect position to enable writing. (Page E-33)
[Er8]	There is a problem with the SD memory card data format or the data is corrupted.	Use different data or a different SD memory card.

Assembling the Stand

Unpacking

PREPARATION

- Before starting assembly, check to make sure that you have all the parts shown below. You can find the screws in a plastic bag inside of the polystyrene foam packing material.
- This stand does not include any of the tools required for assembly. It is up to you to prepare a large Philips head (+) screwdriver for assembly.

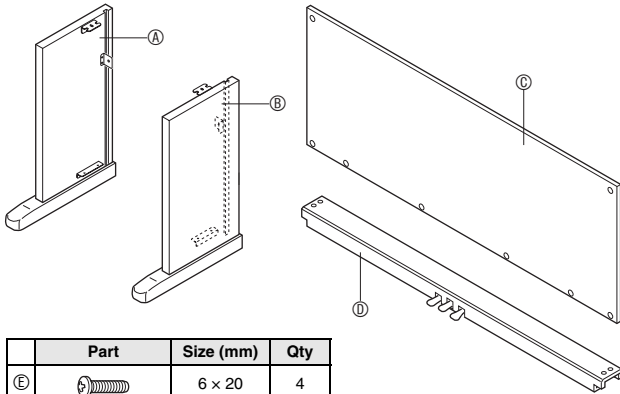

	Part	Size (mm)	Qty
E		6 × 20	4
F		3.5 × 16	6
G		—	1
H		6 × 14	2
I		4 × 16	2
J		—	1
K		6 × 20	1
L		—	4

IMPORTANT!

- If anything is missing or damaged, contact your local CASIO service provider.
- Note that use of any unauthorized parts or components can cause damage to the stand and/or the digital piano.
- Before starting stand assembly, unfasten the band 1 that bundles the pedal cable in the back of crosspiece ④, and extend the cable.

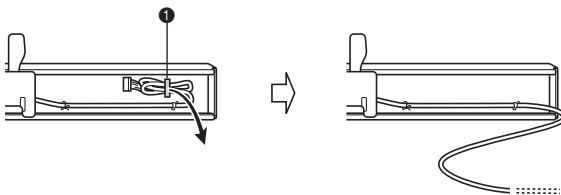

CAUTION

- This stand should be assembled by two people working together.
- This stand should be assembled on a flat surface.
- Do not remove the tape securing the keyboard cover in place until assembly is complete. Removing the tape can cause the keyboard cover to open and close during assembly, creating the risk of personal injury to your hands and fingers.
- Take care that you do not pinch your fingers between parts when assembling them.

To assemble the stand

1. Attach side panels A and B to crosspiece ④. Secure the side panels using four E screws.

- When installing part 2, slide the brackets 3 into the slots in either end crosspiece ④. If the brackets 3 are not inserted into the ends of the crosspiece ④ as far as they will go, the ④ screws will not be able to enter into the screw holes of the brackets 3, which can strip the threads of the screws.
- Cover the screw heads with the caps L.

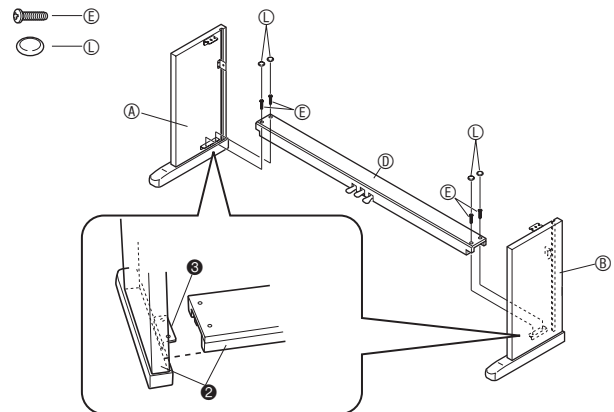

2. Slide back panel ③ into the grooves of the side panels (★).

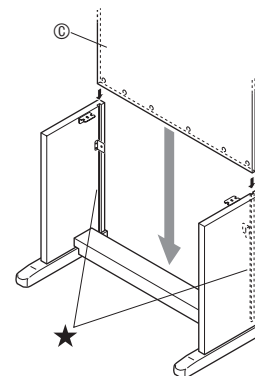

3. First secure the sides of the back panel with the two ① screws on the left and right.

- At location ④, slip the ③ clip onto to the ① screw before installing the screw.
- With back panel ② resting on top of the feet ⑤ of side panels ④ and ⑥, press the back panel against crosspiece ⑦ as you install the ① screws.

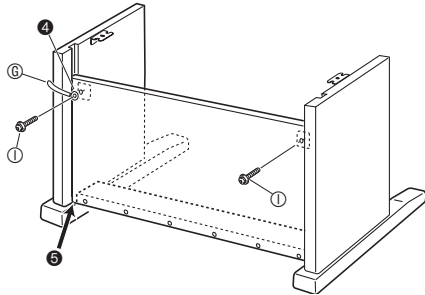

4. Next, secure the bottom of the back panel ② with the six ⑧ screws.

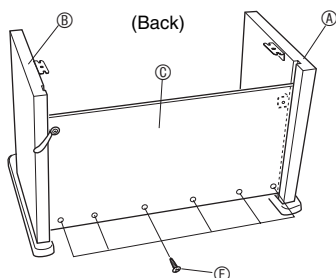

5. Adjust the height adjustment screw ⑨ to provide support so crosspiece ⑦ does not bow downwards when the pedals are pressed.

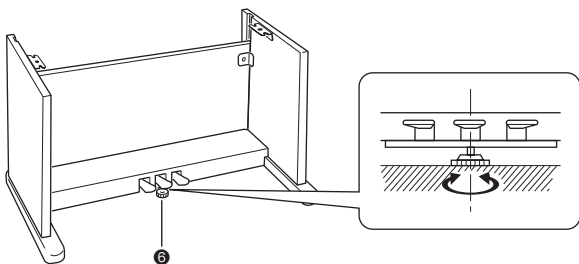

IMPORTANT!

- Pressing the pedals without adjusting height adjustment screw ⑨ can result in damage to crosspiece ⑦. Always make sure you adjust height adjustment screw ⑨ before operating the pedals.

6. Mound the piano onto the stand.

- Use the ⑩ butterfly bolts to secure the piano to the stand.

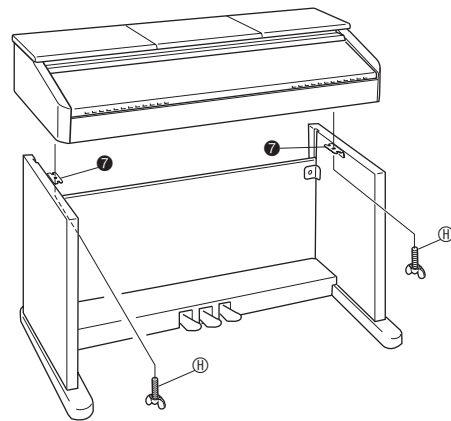

- After ensuring that the screws on the bottom of the piano hook into the cut outs in the stand brackets ⑦, secure the piano with the ⑩ butterfly bolts.

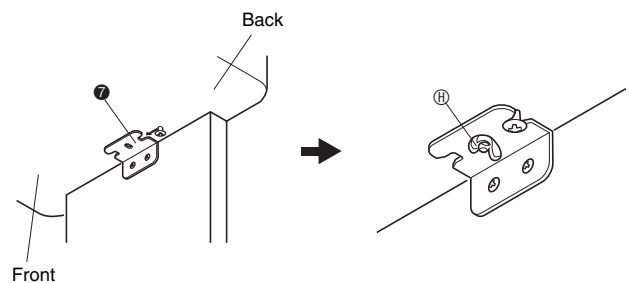

- The butterfly bolts keep the piano from slipping off the stand. Never use the piano without the butterfly bolts installed.

To connect cables

1. Orienting the pedal plug as shown in the illustration, plug it into the pedal connector on the bottom of the piano.

- Secure the pedal cord with the clip.

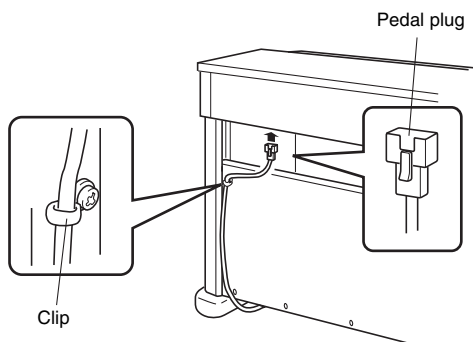

2. Check to make sure that the **POWER** button is in the OFF position (raised). If power is on, press the **POWER** button to turn it off.

3. Plug the power cord that comes with the digital piano into the AC power jack on the bottom of the digital piano.*

* AP-500V only

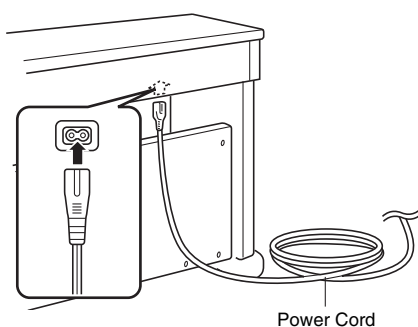

IMPORTANT!

- The shape of the power cord plug and household power outlet receptacle differ according to country and geographical area. The illustration shows just one example of the shapes that are available.
- The power cord of the AP-500 is hard-wired to the digital piano.

4. Plug the power cord into a household power outlet.

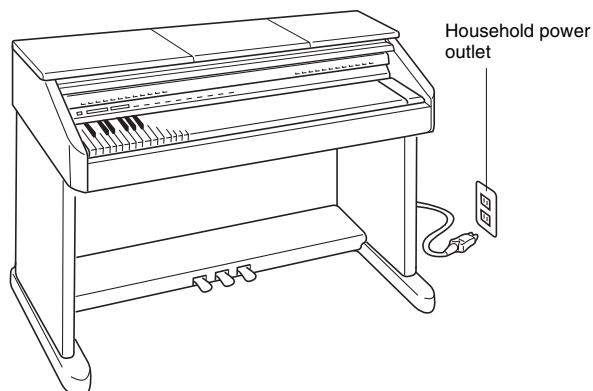

CAUTION

- The screws of the stand can work loose due to the effects of temperature and humidity changes, vibration, etc. Because of this, you need to periodically check the screws for proper tightness. Retighten any loose screws you find.
- To power the digital piano, use a power outlet that allows easy access when plugging in or unplugging the power cord.

To raise the music stand

1. Raise the music stand and insert its support bar into the two grooves behind it.

⚠ CAUTION

- Take care to make sure that the support bar engages securely into one of the two grooves. If you raise the music stand too hastily, the support bar may not engage correctly and make the music stand unsteady.

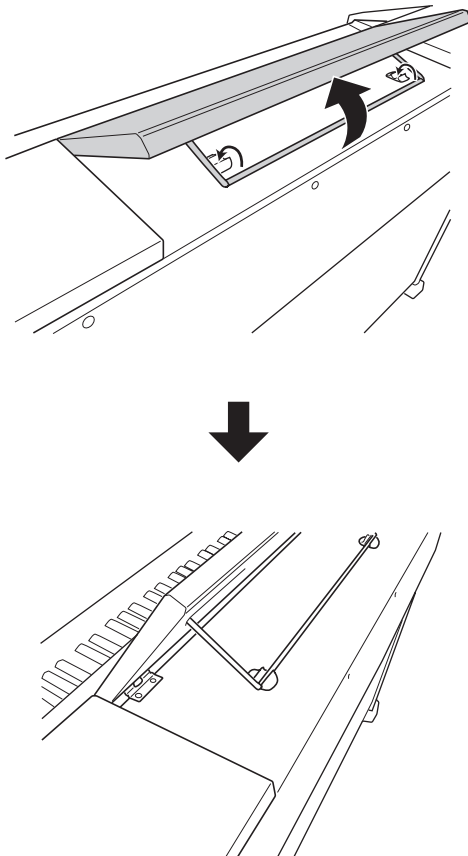

2. You can adjust the angle of the music stand as shown in the illustration below.

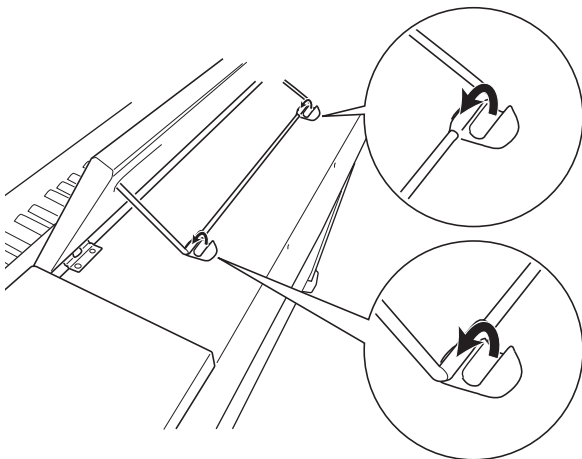

To install the headphones hook

1. Insert the headphones hook ① into the two holes on the bottom of the piano.
2. Use screw ② to secure the headphones hook in place.

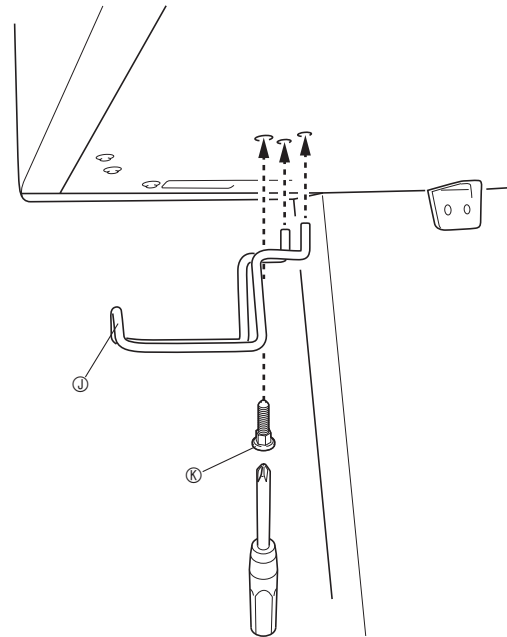

Reference

Troubleshooting

Problem	Cause	Action	See Page
No sound is produced when I press a keyboard key.	<ol style="list-style-type: none"> 1. The VOLUME controller is set to "MIN". 2. Headphones are connected to the digital piano. 3. MIDI Local Control is turned off. 4. Check the current accompaniment mode setting. Normally, the accompaniment keyboard range will not produce any note while CASIO CHORD or FINGERED is selected as the Auto Accompaniment mode. 	<ol style="list-style-type: none"> 1. Rotate the VOLUME controller more towards "MAX". 2. Unplug the headphones from the digital piano. 3. Turn on the Local Control setting. 4. Change the accompaniment mode to NORMAL. 	<ul style="list-style-type: none"> ☞ E-8 ☞ E-6 ☞ E-29 ☞ E-14
No rhythm.	Accompaniment volume is set to 0.	Use the TEMPO/SETTING button and SONG/ACCOMP VOLUME button to increase the volume.	☞ E-28
The pitch of the digital piano is off.	<ol style="list-style-type: none"> 1. The digital piano's key setting is something other than "0". 2. Digital piano tuning is incorrect. 	<ol style="list-style-type: none"> 1. Change the key setting to "0", or turn digital piano power off and then back on again. 2. Adjust digital piano tuning, or turn the piano off and then back on again. 	<ul style="list-style-type: none"> ☞ E-27 ☞ E-27
No sound is produced when I try to play back a built-in song or a recorded song.	<ol style="list-style-type: none"> 1. The VOLUME controller is set to "MIN". 2. Headphones are connected to the digital piano. 	<ol style="list-style-type: none"> 1. Rotate the VOLUME controller more towards "MAX". 2. Unplug the headphones from the digital piano. 	<ul style="list-style-type: none"> ☞ E-8 ☞ E-6
When I play something on the digital piano, my connected external MIDI sound source does not sound.	<ol style="list-style-type: none"> 1. The digital piano's send channel is different from the send channel of the external MIDI sound source. 2. The volume or expression setting of the external sound source is "0". 	<ol style="list-style-type: none"> 1. Change the send channel settings of the digital piano and/or the external MIDI sound source so they are the same. 2. Adjust the volume and expression settings of the external sound source. 	<ul style="list-style-type: none"> ☞ E-29 ☞ External sound source user's guide
No sound is produced when playing MIDI data from a computer.	The USB cable is not connected correctly.	Check to make sure that the USB cable is connected correctly.	☞ E-30
When connected to a computer over a USB connection, playing on the keyboard produces unnatural sounds.	The computer's MIDI THRU function is turned on.	Turn off MIDI THRU on the computer, or turn off digital piano Local Control.	☞ E-29
I can't record chord accompaniment data on my computer.	Accomp MIDI out is turned off.	Turn on Accomp MIDI out.	☞ E-29
I can't store data to an SD memory card.	<ol style="list-style-type: none"> 1. The SD memory card is write-protected. 2. The card is not inserted properly into the SD memory card slot. 3. There is not enough room available on the SD memory card. 4. The capacity of the SD memory card is not supported by the digital piano. 5. The SD memory card is damaged. 	<ol style="list-style-type: none"> 1. Change the write-protect position to enable writing. 2. Insert the card properly. 3. Use a different SD memory card. 4. Use an SD memory card with a supported capacity. 5. Use a different SD memory card. 	<ul style="list-style-type: none"> ☞ E-33 ☞ E-34 ☞ E-34 ☞ E-33

Problem	Cause	Action	See Page
I can't load data from an SD memory card.	<ol style="list-style-type: none"> 1. The card is not inserted properly into the SD memory card slot. 2. The capacity of the SD memory card is not supported by the digital piano. 3. The SD memory card is damaged. 4. When the data was copied to the SD memory card from a computer, it was copied to a folder other than "MUSICDAT". 	<ol style="list-style-type: none"> 1. Insert the card properly. 2. Use an SD memory card with a supported capacity. 3. Use a different SD memory card. 4. Move the data to the "MUSICDAT" folder. 	<p>☞ E-34</p> <p>☞ E-33</p> <p>☞ E-35</p>
Playback stops part way through while transferring song data from my computer.	Digital noise from the USB cable or power cord caused data communication your computer and digital piano to be interrupted.	<p>Stop song playback, disconnect the USB cable from the digital piano, and then reconnect it. Next, try playing back the song again.</p> <p>If this does not solve the problem, quit the MIDI software you are using, disconnect the USB cable from the digital piano, and then reconnect it. Next, restart the MIDI software and then try playing back the song again.</p>	☞ E-30
"E-A" appears on the display immediately after power is turned on.	Built-in flash memory is corrupted.	Contact your nearest CASIO Service Center.	—
A tone's quality and volume sounds slightly different depending where it is played on the keyboard.	<p>This is an unavoidable result of the digital sampling process,* and does not indicate malfunction.</p> <p>* Multiple digital samples are taken for the low range, middle range, and high range of the original musical instrument. Because of this, there may be a very slight difference in tonal quality and volume between sample ranges.</p>		

Product Specifications

All of the items in these specifications apply to the AP-500 and AP-500V, unless specifically noted otherwise.

Model	AP-500/AP-500V
Keyboard	88-key piano keyboard, with Touch Response
Maximum Polyphony	128 notes
Tones	164 (with Layer and Split)
Effects	DSP, Reverb (4 types), chorus (4 types), Acoustic Resonance, Brilliance (-3 to -1, 1 to 3)
Metronome	<ul style="list-style-type: none"> • Beats: 0, 2, 3, 4, 5, 6 • Tempo Range: 20 to 255
Demo Songs	<ul style="list-style-type: none"> • Number of Songs: 74 songs (All-song repeat play)
Music Library	<ul style="list-style-type: none"> • Number of Songs: 60 • User Songs: Up to 10 (Up to approximately 3.1 MB; up to approximately 318 KB per song)* * Based on 1 KB = 1024 bytes, 1 MB = 1024² bytes. • Song volume: Adjustable • Part On/Off: L, R
Recorder	<ul style="list-style-type: none"> • Functions: Real-time recording, playback • Number of Songs: 5 • Number of Tracks: 2 • Capacity: Approximately 50,000 notes total (Up to approximately 10,000 notes per song) • Recorded Data Protection: Built-in flash memory
Pedals	Damper, soft, sostenuto
Other Functions	<ul style="list-style-type: none"> • Touch Select: 3 types, Off • Transpose: 1 octave (-6 to 0 to 5) • Tuning: A4 = 440.0 Hz ±50 cents (variable)
MIDI	16-channel multi-timbre receive
SD Memory Card	<ul style="list-style-type: none"> • SD memory card slot • Supported SD Memory Cards: Up to 1 GB (Larger capacity cards not supported.) • Functions: SMF playback, data storage, data recall, card format
Inputs/Outputs	<ul style="list-style-type: none"> • PHONES jack: Stereo standard jacks × 2 • MIDI THRU/OUT/IN terminals • LINE IN R, L/MONO jacks: Standard jacks × 2 Input impedance: 7.0KΩ Input Voltage: 290mV (RMS) • LINE OUT R, L/MONO jacks: Standard jacks × 2 Output impedance: 1.1KΩ Output Voltage: 2.3V (RMS) MAX • USB port: Type B • Pedal connector
Speakers	φ 16cm × 2 + φ 5cm × 2 (Output 30W + 30W)
Power Requirements	AP-500: 120V AP-500V: 220-240V
Power Consumption	AP-500: 78W AP-500V: 78W
Dimensions	Digital Piano and Stand: 138.1 (W) × 47.3 (D) × 87.4 (H) cm (54 ⁷ / ₁₆ × 18 ¹⁰ / ₁₆ × 34 ⁷ / ₁₆ inch)
Weight	Digital Piano and Stand: approximately 53.0kg (116.8 lbs)

- Specifications and designs are subject to change without notice.
- The power cord of the AP-500 is hard-wired to the digital piano.
- The power cord of the AP-500V is detachable.

Operating Precautions

Be sure to read and observe the following operating precautions.

■ Location

Avoid the following locations for this product.

- Areas exposed to direct sunlight and high humidity
- Areas subjected to temperature extremes
- Near a radio, TV, video deck, or tuner

The above devices will not cause malfunction of the product, but interference from the product can cause audio or video interference of a nearby device.

■ User Maintenance

- Never use benzene, alcohol, thinner, or other chemical agents to clean the product.
- To clean the product or its keyboard, wipe with a soft cloth moistened in a weak solution of water and a mild neutral detergent. Wring all excess moisture from the cloth before wiping.

■ Included and Optional Accessories

Use only accessories that are specified for use with this product. Use of unauthorized accessories creates the risk of fire, electric shock, and personal injury.

■ Weld Lines

Lines may be visible on the exterior of the product. These are "weld lines" that result from the plastic molding process. They are not cracks or scratches.

■ Musical Instrument Etiquette

Always be aware of others around you whenever using this product. Be especially careful when playing late at night to keep the volume at levels that do not disturb others. Other steps you can take when playing late at night are closing the window and using headphones.

- Any reproduction of the contents of this manual, either in part or its entirety, is prohibited. Except for your own, personal use, any other use of the contents of this manual without the consent of CASIO is prohibited under copyright laws.
- IN NO EVENT SHALL CASIO BE LIABLE FOR ANY DAMAGES WHATSOEVER (INCLUDING, WITHOUT LIMITATION, DAMAGES FOR LOSS OF PROFITS, BUSINESS INTERRUPTION, LOSS OF INFORMATION) ARISING OUT OF THE USE OF OR INABILITY TO USE THIS MANUAL OR PRODUCT, EVEN IF CASIO HAS BEEN ADVISED OF THE POSSIBILITY OF SUCH DAMAGES.
- The contents of this manual are subject to change without notice.

Appendix/Apéndice

Tone List/Lista de tonos

No./ Nº	Tone Name/ Nombre de tonos	Program Change/ Cambio de programa	Bank Select MSB/ MSB de selección de banco	Maximum Polyphony /Polifonía máxima	DSP
—	GRAND PIANO 1	0	48	64	—
—	GRAND PIANO 2	0	49	128	—
—	GRAND PIANO 3	1	48	64	—
—	ELEC PIANO 1	4	48	128	Enhancer
—	ELEC PIANO 2	5	49	64	3Band EQ
—	ELEC PIANO 3	5	48	128	Enhancer
—	60'S E. PIANO	4	51	128	Tremolo
—	HARPSICHORD	6	48	128	3Band EQ
—	VIBRAPHONE	11	48	128	Tremolo
—	PIPE ORGAN	19	49	128	—
—	PERC ORGAN	17	48	64	Rotary
—	STRINGS	49	48	128	3Band EQ
—	ACOUSTIC BASS	32	48	128	3Band EQ
—	RIDE ACO BASS	32	49	64	3Band EQ
Various					
001	MELLOW PIANO	0	50	64	—
002	ROCK PIANO	1	49	128	—
003	DANCE PIANO	1	50	128	—
004	MODERN PIANO	1	51	64	—
005	PIANO PAD	0	51	64	—
006	HONKY-TONK	3	48	64	—
007	OCTAVE PIANO	3	49	64	—
008	DYNO ELEC.PIANO	4	49	128	Auto Pan
009	POP ELEC.PIANO	4	50	64	Tremolo
010	E.GRAND 80	2	48	128	—
011	CLAVI	7	48	128	Enhancer
012	CHURCH ORGAN	19	48	64	—
013	DRAWBAR ORGAN	16	48	128	Rotary
014	ROCK ORGAN	16	49	128	Drive Rotary
015	STEEL STR.GUITAR	25	48	128	—
016	SYNTH-STRINGS	50	48	128	3Band EQ
017	CHOIR	52	48	64	—
018	SYNTH-PAD	90	48	64	—
019	FANTASY	88	48	64	—
020	NEW AGE	88	49	64	3Band EQ
GM					
021	GM PIANO 1	0	0	128	—
022	GM PIANO 2	1	0	128	—
023	GM PIANO 3	2	0	128	—
024	GM HONKY-TONK	3	0	64	—
025	GM E.PIANO 1	4	0	128	—
026	GM E.PIANO 2	5	0	128	—
027	GM HARPSICHORD	6	0	128	—
028	GM CLAVI	7	0	128	—
029	GM CELESTA	8	0	128	—
030	GM GLOCKENSPIEL	9	0	128	—
031	GM MUSIC BOX	10	0	64	—
032	GM VIBRAPHONE	11	0	128	—
033	GM MARIMBA	12	0	128	—
034	GM XYLOPHONE	13	0	128	—
035	GM TUBULAR BELL	14	0	128	—
036	GM DULCIMER	15	0	64	—
037	GM ORGAN 1	16	0	128	—
038	GM ORGAN 2	17	0	64	—
039	GM ORGAN 3	18	0	64	—
040	GM PIPE ORGAN	19	0	64	—
041	GM REED ORGAN	20	0	128	—
042	GM ACCORDION	21	0	64	—
043	GM HARMONICA	22	0	128	—
044	GM BANDONEON	23	0	64	—
045	GM NYLON STR.GUITAR	24	0	128	—

No./ Nº	Tone Name/ Nombre de tonos	Program Change/ Cambio de programa	Bank Select MSB/ MSB de selección de banco	Maximum Polyphony /Polifonía máxima	DSP
046	GM STEEL STR.GUITAR	25	0	128	—
047	GM JAZZ GUITAR	26	0	128	—
048	GM CLEAN GUITAR	27	0	128	—
049	GM MUTE GUITAR	28	0	128	—
050	GM OVERDRIVE GT	29	0	64	—
051	GM DISTORTION GT	30	0	64	—
052	GM GT HARMONICS	31	0	128	—
053	GM ACOUSTIC BASS	32	0	128	—
054	GM FINGERED BASS	33	0	128	—
055	GM PICKED BASS	34	0	128	—
056	GM FRETLESS BASS	35	0	128	—
057	GM SLAP BASS 1	36	0	128	—
058	GM SLAP BASS 2	37	0	128	—
059	GM SYNTH-BASS 1	38	0	64	—
060	GM SYNTH-BASS 2	39	0	128	—
061	GM VIOLIN	40	0	128	—
062	GM VIOLA	41	0	128	—
063	GM CELLO	42	0	128	—
064	GM CONTRABASS	43	0	128	—
065	GM TREMOLO STRINGS	44	0	128	—
066	GM PIZZICATO	45	0	128	—
067	GM HARP	46	0	128	—
068	GM TIMPANI	47	0	128	—
069	GM STRINGS 1	48	0	128	—
070	GM STRINGS 2	49	0	128	—
071	GM SYNTH-STRINGS 1	50	0	128	—
072	GM SYNTH-STRINGS 2	51	0	128	—
073	GM CHOIR AAHS	52	0	128	—
074	GM VOICE DOO	53	0	128	—
075	GM SYNTH-VOICE	54	0	128	—
076	GM ORCHESTRA HIT	55	0	64	—
077	GM TRUMPET	56	0	128	—
078	GM TROMBONE	57	0	128	—
079	GM TUBA	58	0	128	—
080	GM MUTE TRUMPET	59	0	128	—
081	GM FRENCH HORN	60	0	64	—
082	GM BRASS	61	0	128	—
083	GM SYNTH-BRASS 1	62	0	64	—
084	GM SYNTH-BRASS 2	63	0	64	—
085	GM SOPRANO SAX	64	0	128	—
086	GM ALTO SAX	65	0	128	—
087	GM TENOR SAX	66	0	128	—
088	GM BARITONE SAX	67	0	128	—
089	GM OBOE	68	0	128	—
090	GM ENGLISH HORN	69	0	128	—
091	GM BASSOON	70	0	128	—
092	GM CLARINET	71	0	128	—
093	GM PICCOLO	72	0	128	—
094	GM FLUTE	73	0	128	—
095	GM RECORDER	74	0	128	—
096	GM PAN FLUTE	75	0	128	—
097	GM BOTTLE BLOW	76	0	128	—
098	GM SHAKUHACHI	77	0	64	—
099	GM WHISTLE	78	0	128	—
100	GM OCARINA	79	0	128	—
101	GM SQUARE LEAD	80	0	64	—
102	GM SAWTOOTH LEAD	81	0	64	—
103	GM CALLIOPE	82	0	64	—
104	GM CHIFF LEAD	83	0	64	—
105	GM CHARANG	84	0	64	—
106	GM VOICE LEAD	85	0	64	—
107	GM FIFTH LEAD	86	0	64	—
108	GM BASS+LEAD	87	0	64	—

No./ Nº	Tone Name/ Nombre de tonos	Program Change/ Cambio de programa	Bank Select MSB/ MSB de selección de banco	Maximum Polyphony /Polifonía máxima	DSP
109	GM FANTASY	88	0	64	—
110	GM WARM PAD	89	0	128	—
111	GM POLYSYNTH	90	0	64	—
112	GM SPACE CHOIR	91	0	64	—
113	GM BOWED GLASS	92	0	64	—
114	GM METAL PAD	93	0	64	—
115	GM HALO PAD	94	0	64	—
116	GM SWEEP PAD	95	0	128	—
117	GM RAIN DROP	96	0	64	—
118	GM SOUND TRACK	97	0	64	—
119	GM CRYSTAL	98	0	64	—
120	GM ATMOSPHERE	99	0	64	—
121	GM BRIGHTNESS	100	0	64	—
122	GM GOBLINS	101	0	64	—
123	GM ECHOES	102	0	128	—
124	GM SF	103	0	64	—
125	GM SITAR	104	0	128	—
126	GM BANJO	105	0	128	—
127	GM SHAMISEN	106	0	128	—
128	GM KOTO	107	0	128	—
129	GM THUMB PIANO	108	0	128	—
130	GM BAGPIPE	109	0	64	—
131	GM FIDDLE	110	0	128	—
132	GM SHANAI	111	0	128	—
133	GM TINKLE BELL	112	0	128	—
134	GM AGOGO	113	0	128	—
135	GM STEEL DRUMS	114	0	64	—
136	GM WOOD BLOCK	115	0	128	—
137	GM TAIKO	116	0	128	—
138	GM MELODIC TOM	117	0	128	—
139	GM SYNTH-DRUM	118	0	128	—
140	GM REVERSE CYMBAL	119	0	128	—
141	GM GT FRET NOISE	120	0	128	—
142	GM BREATH NOISE	121	0	128	—
143	GM SEASHORE	122	0	64	—
144	GM BIRD	123	0	64	—
145	GM TELEPHONE	124	0	128	—
146	GM HELICOPTER	125	0	128	—
147	GM APPLAUSE	126	0	64	—
148	GM GUNSHOT	127	0	128	—
Drum Sets					
149	STANDARD SET	0	120	128	—
150	BRUSH SET	40	120	128	—

Drum Assignment List/ Lista de sonidos de batería

Key/Note Number Número de clave/nota	STANDARD SET	BRUSH SET
E1 28	HIGH Q	←
F1 29	SLAP	←
G1 31	SCRATCH PUSH	←
A1 33	SCRATCH PULL	←
B1 35	STICKS	←
C2 36	SQUARE CLICK	←
D2 38	METRONOME CLICK	←
E2 40	METRONOME BELL	←
F2 41	STANDARD 1 KICK 2	BRUSH KICK 2
G2 43	STANDARD 1 KICK 1	BRUSH KICK 1
A2 45	SIDE STICK	BRUSH SIDE STICK
B2 47	STANDARD 1 SNARE 1	BRUSH TAP
C3 48	HAND CLAP 1	BRUSH SWIRL
D3 50	STANDARD 1 SNARE 2	←
E3 52	LOW TOM 2	←
F3 54	CLOSED HI-HAT	←
G3 55	LOW TOM 1	←
A3 57	PEDAL HI-HAT	←
B3 59	MID TOM 2	←
C4 60	OPEN HI-HAT	←
D4 62	MID TOM 1	←
E4 64	HIGH TOM 2	←
F4 65	CRASH CYMBAL 1	BRUSH CRASH CYMBAL 1
G4 67	HIGH TOM 1	←
A4 69	RIDE CYMBAL 1	BRUSH RIDE CYMBAL 1
B4 71	CHINESE CYMBAL	←
C5 72	RIDE BELL	BRUSH RIDE BELL
D5 74	TAMBOURINE 1	TAMBOURINE 2
E5 76	SPLASH CYMBAL	BRUSH SPLASH CYMBAL
F5 77	COWBELL	←
G5 79	CRASH CYMBAL 2	BRUSH CRASH CYMBAL 2
A5 81	VIBRA-SLAP	←
B5 83	RIDE CYMBAL 2	BRUSH RIDE CYMBAL 2
C6 84	HIGH BONGO	←
D6 86	LOW BONGO	←
E6 88	MUTE HIGH CONGA	←
F6 89	OPEN HIGH CONGA	←
	LOW CONGA	←
	HIGH TIMBALE	←
	LOW TIMBALE	←
	HIGH AGOGO	←
	LOW AGOGO	←
	CABASA	←
	MARACAS	←
	SHORT HI WHISTLE	←
	LONG LOW WHISTLE	←
	SHORT GUIRO	←
	LONG GUIRO	←
	CLAVES	←
	HIGH WOOD BLOCK	←
	LOW WOOD BLOCK	←
	MUTE CUICA	←
	OPEN CUICA	←
	MUTE TRIANGLE	←
	OPEN TRIANGLE	←
	SHAKER	←
	JINGLE BELL	←
	BELL TREE	←
	CASTANETS	←
	MUTE SURDO	←
	OPEN SURDO	←
	APPLAUSE	←
	APPLAUSE 2	←

NOTE

- “←” : indicates the same sound as STANDARD SET.

NOTA

- “←” : indica el mismo sonido que STANDARD SET.

Rhythm List/Lista de ritmos

No./Nº	Rhythm Name/Nombre de ritmo
01	8 BEAT
02	PIANO BALLAD 1
03	PIANO BALLAD 2
04	EP BALLAD 1
05	EP BALLAD 2
06	BLUES BALLAD
07	JAZZ COMBO 1
08	JAZZ COMBO 2
09	RAGTIME
10	ROCK'N'ROLL
11	BOOGIE WOOGIE
12	BOSSA NOVA
13	GOSPEL
14	ARPEGGIO 1
15	ARPEGGIO 2
16	MARCH 1
17	MARCH 2
18	STRIDE PIANO
19	WALTZ 1
20	WALTZ 2

Song List/Lista de canciones

No./Nº	Song Name/Nombre de canciones
01	Nocturne Op.9-2
02	Fantaisie-Impromptu Op.66
03	Étude Op.10-3 "Chanson de l'adieu"
04	Étude Op.10-5 "Black Keys"
05	Étude Op.10-12 "Revolutionary"
06	Étude Op.25-9 "Butterflies"
07	Prélude Op.28-7
08	Valse Op.64-1 "Petit Chien"
09	Valse Op.64-2
10	Moments Musicaux 3
11	Impromptu Op.90-2
12	Marche Militaire 1 (Duet)
13	Frühlingslied [Lieder Ohne Worte Heft 5]
14	Fröhlicher Landmann [Album für die Jugend]
15	Von fremden Ländern und Menschen [Kinderszenen]
16	Träumerei [Kinderszenen]
17	Tambourin
18	Menuet BWV Anh.114 [Clavierbüchlein der Anna Magdalena Bach]
19	Inventio 1 BWV 772
20	Inventio 8 BWV 779
21	Inventio 13 BWV 784
22	Praeludium 1 BWV 846 [Das Wohltemperierte Klavier 1]
23	Le Coucou
24	Gavotte
25	Sonatina Op.36-1 1st Mov.
26	Sonatine Op.20-1 1st Mov.
27	Sonate K.545 1st Mov.
28	Sonate K.331 3rd Mov. "Turkish March"
29	Rondo K.485
30	Für Elise
31	Marcia alla Turca
32	Sonate Op.13 "Pathétique" 1st Mov.
33	Sonate Op.13 "Pathétique" 2nd Mov.
34	Sonate Op.13 "Pathétique" 3rd Mov.
35	Sonate Op.27-2 "Moonlight" 1st Mov.
36	Rhapsodie 2
37	Waltz Op.39-15 (Duet)
38	Liebesträume 3
39	Blumenlied
40	La Prière d'une Vierge
41	Csikos Post
42	Humoresque Op.101-7
43	Melodie [Lyrische Stücke Heft 2]
44	Sicilienne Op.78
45	Berceuse [Dolly] (Duet)
46	Arabesque 1
47	La Fille aux Cheveux de Lin [Préludes]
48	Passepied [Suite bergamasque]
49	Gymnopédie 1
50	Je Te Veux
51	Salut d'Amour
52	The Entertainer
53	Maple Leaf Rag
54	L'arabesque [25 Étüden Op.100]
55	La Styrienne [25 Étüden Op.100]
56	Ave Maria [25 Étüden Op.100]
57	Le retour [25 Étüden Op.100]
58	La chevaleresque [25 Étüden Op.100]
59	No.13 [Études de Mécanisme Op.849]
60	No.26 [Études de Mécanisme Op.849]
61-70	User area songs/Canciones del área de usuario

Fingered Chord Chart/Cuadro de acordes digitados (Fingered)

Chord Type Root	M	m	7	m7	dim7	M7	dim	m7 ⁵
C								
C [♯] (D [♭])								
D								
(D [♯])/E [♭]								
E								
F								
F [♯] (G [♭])								
G								
(G [♯])/A [♭]								
A								
(A [♯])/B [♭]								
B								



This recycle mark indicates that the packaging conforms to the environmental protection legislation in Germany.

Esta marca de reciclaje indica que el empaquetado se ajusta a la legislación de protección ambiental en Alemania.

CASIO®

Free Manuals Download Website

<http://myh66.com>

<http://usermanuals.us>

<http://www.somanuals.com>

<http://www.4manuals.cc>

<http://www.manual-lib.com>

<http://www.404manual.com>

<http://www.luxmanual.com>

<http://aubethermostatmanual.com>

Golf course search by state

<http://golfingnear.com>

Email search by domain

<http://emailbydomain.com>

Auto manuals search

<http://auto.somanuals.com>

TV manuals search

<http://tv.somanuals.com>