

bryant

**Model 320AAZ & 321AAZ
Variable-Speed, Gas-Fired
Condensing Furnaces**

FILE COPY

**day &
night**

**USER'S INFORMATION MANUAL FOR
THE OPERATION AND MAINTENANCE
OF YOUR NEW GAS-FIRED FURNACE**

Payne

WARNING: If the information in this manual is not followed exactly, a fire or explosion may result causing property damage, personal injury or loss of life.

FILE COPY

- Do not store or use gasoline or other flammable vapors and liquids in the vicinity of this or any other appliance.
- WHAT TO DO IF YOU SMELL GAS:
 - Do not try to light any appliance.
 - Do not touch any electrical switch; do not use any phone in your building.
 - Immediately call your gas supplier from a neighbor's phone. Follow the gas supplier's instructions.
 - If you cannot reach your gas supplier, call the fire department.
- Installation and service must be performed by a qualified installer, service agency or the gas supplier.

FILE COPY

NOTE TO INSTALLER:

This manual must be left with the equipment user.

THE INTELLIGENT HEATING MACHINE

A91236

Download from www.30manuals.com. All manuals Search and Download.

WELCOME TO A NEW GENERATION OF COMFORT

Congratulations! In light of rising energy costs, the Plus 90i™ Variable-Speed, Gas-Fired Condensing Furnace is one of the soundest investments today's homeowner can make.

Your new Plus 90i is truly a triumph of technology in home heating. A revolutionary design employs 2 heat exchangers to "squeeze" out the maximum amount of heat from the fuel consumed. In fact, your new furnace is so efficient, over 90%* of the heat generated during combustion is captured and delivered inside your home. That's more than a 33%* increase in heating efficiency over conventional furnaces.

The Plus 90i is not only one of the most energy-efficient furnaces you can buy today, it is also one of the safest and most dependable. We are proud of the technological advances incorporated into the design of the Plus 90i. With only minimal care, your new furnace will deliver many years of money-saving home comfort and enjoyment. Spend just a few minutes with this manual to learn the operation of your new furnace and the small amount of maintenance it takes to help keep it operating at peak efficiency year after year.

*The output capacity and any representations of efficiency for this furnace are based on standard Department of Energy test procedures.

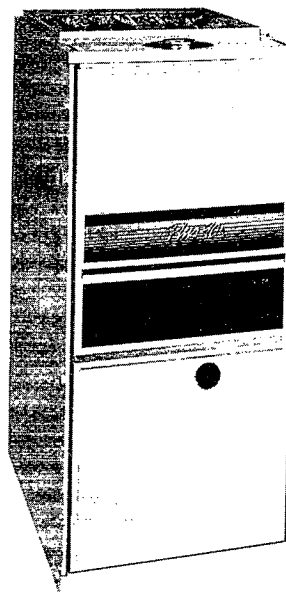

1

A91129

**MODEL 320AAZ
UPFLOW FURNACE**

For your convenience, record the product and serial numbers of your new furnace on the form below. Should you ever require service, you will have ready access to the information needed by the service representative.

FURNACE IDENTIFICATION

Product No. _____

Serial No. _____

Date Installed _____

Dealer Name _____

Address _____

City _____

State _____ Zip _____

Telephone _____

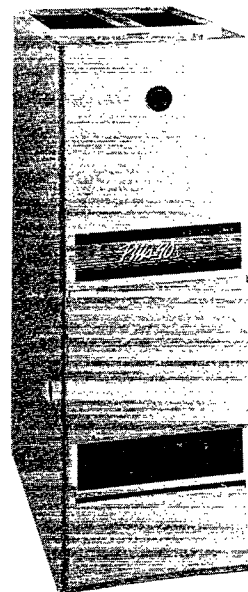

2

A92096

**MODEL 321AAZ
DOWNFLOW FURNACE**

UPFLOW FURNACE COMPONENTS

- 1 Gas valve. Safe, efficient. Features 2 separate gas shut-off valves.
- 2 Burner assembly (inside). Operates with energy-saving pilot, inshot burners, and spark igniter for safe, dependable heating.
- 3 Primary serpentine heat exchanger (inside). Stretches fuel dollars with the S-shaped heat-flow design. Solid construction of corrosion-resistant aluminized steel means reliability.
- 4 Secondary condensing heat exchanger (inside). Wrings out more heat through condensation. Constructed with polypropylene-laminated steel to ensure durability.
- 5 Inducer motor. Pulls hot flue gases through the heat exchangers, maintaining negative pressure for added safety.
- 6 Vent outlet. Uses PVC pipe to carry vent gases from the home.
- 7 Condensate drain trap. Collects moisture condensed from burned gases for disposal into home drain system.
- 8 Heavy-duty blower. Circulates air upwards, scrubbing the heat exchangers to speed condensation and transfer extra heat into the home.
- 9 Air filter and retainer spring.
- 10 Light emitting diode (LED) view port. Fault code lights are inside.
- 11 Low-voltage circuit breaker.

DOWNFLOW FURNACE COMPONENTS

- 1 Gas valve. Safe, efficient. Features 2 separate gas shut-off valves.
- 2 Burner assembly (inside). Operates with energy-saving pilot, inshot burners, and spark igniter for safe, dependable heating.
- 3 Primary serpentine heat exchanger (inside). Stretches fuel dollars with the S-shaped heat-flow design. Solid construction of corrosion-resistant aluminized steel means reliability.
- 4 Secondary condensing heat exchanger (inside). Wrings out more heat through condensation. Constructed with polypropylene-laminated steel to ensure durability.
- 5 Inducer motor. Pulls hot flue gases through the heat exchangers, maintaining negative pressure for added safety.
- 6 Vent outlet. Uses PVC pipe to carry vent gases from the home.
- 7 Condensate drain trap. Collects moisture condensed from burned gases for disposal into home drain system.
- 8 Heavy-duty blower. Circulates air downward, scrubbing the heat exchangers to speed condensation and transfer extra heat into the home.
- 9 Light emitting diode (LED) view port. Fault code lights are inside.
- 10 Low-voltage circuit breaker.
- 11 Manual-reset auxiliary limit switch.

Note: See Fig. 28 for filter location.

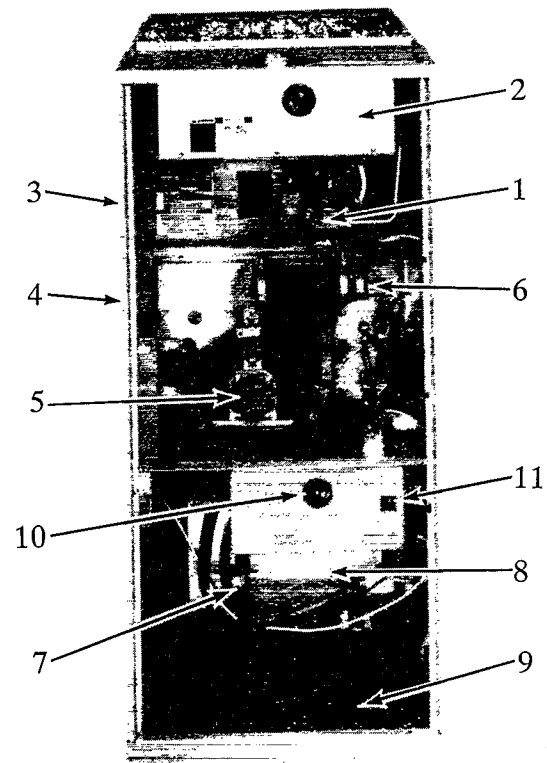

A91237

**MODEL 320AAZ
UPFLOW FURNACE**

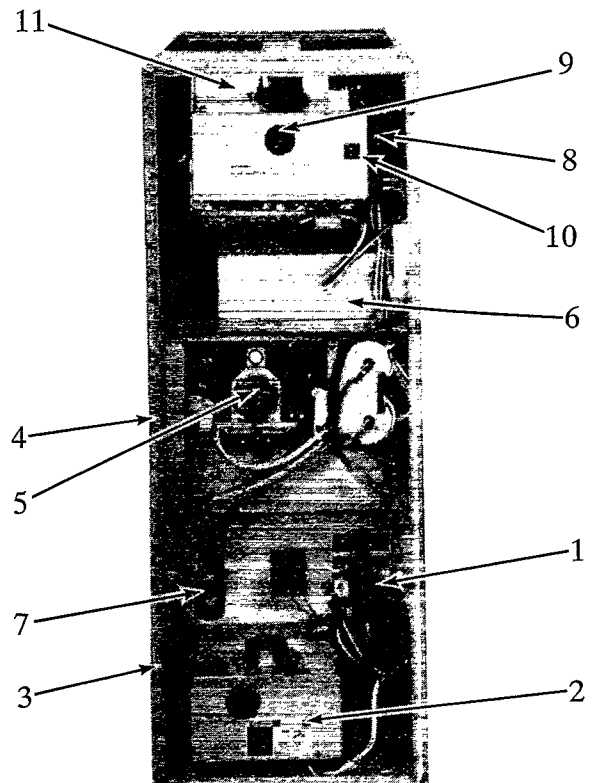

A92097

**MODEL 321AAZ
DOWNFLOW FURNACE**

IMPORTANT FACTS

Your gas furnace uses air from **outside the home** for combustion and venting. It is not to be installed using in-house air. Therefore, both pipes must terminate outside the structure and must not be obstructed in any way.

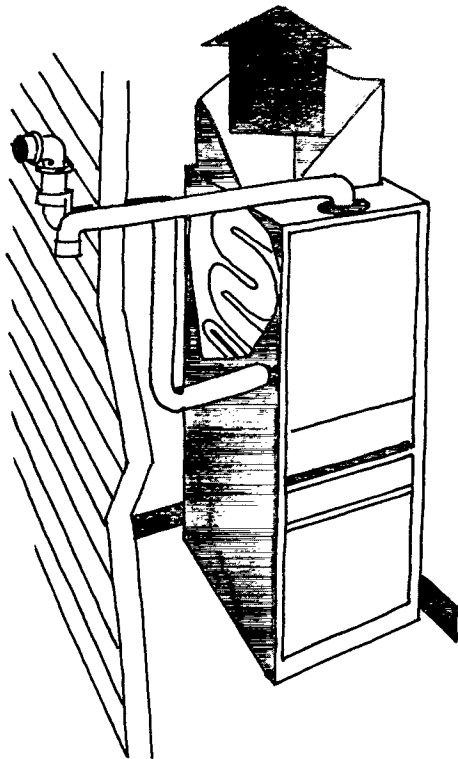

5

A86051

To minimize the possibility of serious personal injury, fire, damage to your furnace, or improper operation, **carefully follow these safety rules:**

- Keep the area around your furnace free of combustible materials, gasoline, and other flammable liquids and vapors.
- Do not cover the furnace, store trash or debris near it, or in any way block the flow of fresh air to the unit.
- A furnace installed in an attic or other insulated space must be kept free and clear of insulating material. Examine the furnace area when installing the furnace or adding more insulation. Some materials may be combustible.

NOTE: Do not use this furnace if any part has been under water. Immediately call a qualified service technician to inspect the furnace and to replace any part of the control system and any gas control which has been under water.

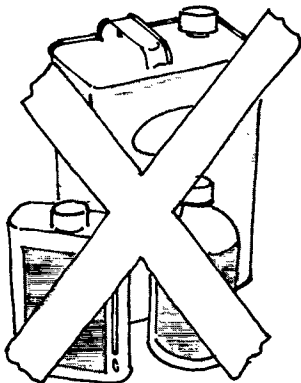

6

A86023

NOTE: The qualified installer or agency must use only factory-authorized replacement parts, kits, and accessories when modifying this product.

This furnace contains **SAFETY DEVICES** which must be **MANUALLY RESET**. If the furnace is left unattended for an extended period of time, have it checked periodically for proper operation. This precaution will prevent problems associated with **NO HEAT**, such as frozen water pipes, etc. See "Before You Request a Service Call" in this manual.

SAFETY CONSIDERATIONS

Installation and service of heating equipment can be hazardous due to gas and electrical components. Only trained and qualified personnel should install, repair, or service heating equipment.

Untrained personnel can perform basic maintenance functions such as cleaning and replacing air filters. All other operations must be performed by trained service personnel. Observe safety precautions in this manual, on tags, and labels attached to the furnace and other safety precautions that may apply.

Recognize safety information: This is the safety-alert symbol \triangle . When you see this symbol on the furnace and in instructions or manuals, be alert to the potential for personal injury.

Understand the signal word—**DANGER**, **WARNING**, or **CAUTION**. These words are used with the safety-alert symbol. **DANGER** identifies the most serious hazards which **will** result in severe personal injury or death. **WARNING** signifies hazards that **could** result in personal injury or death. **CAUTION** is used to identify unsafe practices, which would result in minor personal injury or product and property damage.

STARTING YOUR FURNACE

Instead of a continuously burning pilot flame which wastes valuable energy, your furnace uses an automatic, intermittent ignition system to light the pilot each time the thermostat turns your furnace on. **Follow these important safeguards:**

- Never attempt to light the pilot manually with a match or other source of flame.

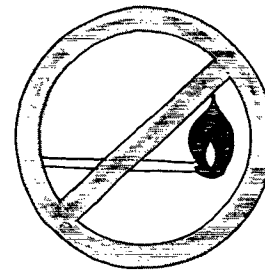

7

A86024

- Read and follow the operating instructions on the furnace, especially the item that reads as follows:
Wait 5 minutes to clear out any gas. Then smell for gas, including near the floor. If you smell gas, **STOP!** Follow "B" in the safety information above on this label. If you don't smell gas, go to the next step.
- If a suspected malfunction occurs with your gas control system, such as the pilot not lighting when it should, refer to the shutdown procedures on the furnace or in the next section to turn off your system, then call your dealer as soon as possible.

WARNING: If overheating occurs, or the gas valve fails to shut off the gas supply, turn **OFF** the manual gas valve to the furnace **BEFORE** turning **OFF** the electrical supply. (See Fig. 9.) Failure to follow this warning could result in a fire or explosion, and personal injury or death.

- **CHECK AIR FILTER:** Before attempting to start your furnace, be sure the furnace filter is clean and in place. (See the maintenance section of this manual.) Then proceed as follows:

STEPS FOR STARTING YOUR FURNACE

1. Set your room thermostat to the lowest temperature setting. (See Fig. 8.)
2. Close the external manual gas valve. (See Fig. 9.)
3. Turn OFF the electrical supply to the furnace. (See Fig. 10.)

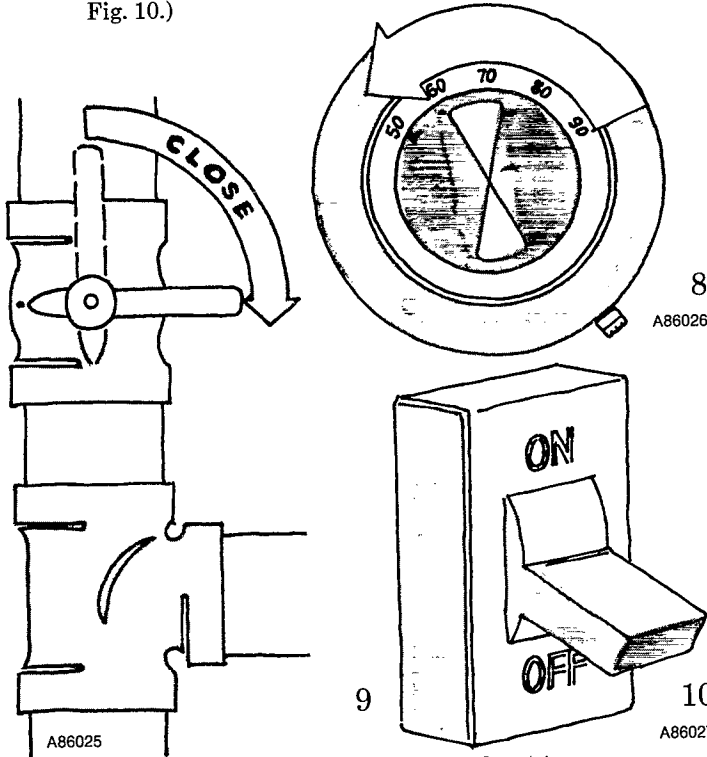

4. Remove the furnace control access door(s).
 - a. Upflow—remove control door. (See Fig. 11.)
 - b. Downflow—Remove blower door first, then remove the control door. (See Fig. 12.)

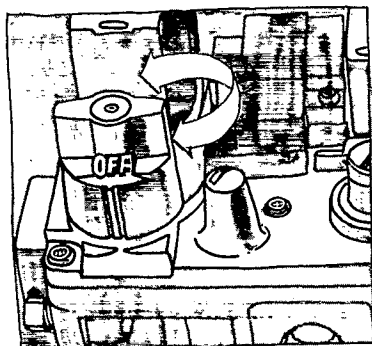
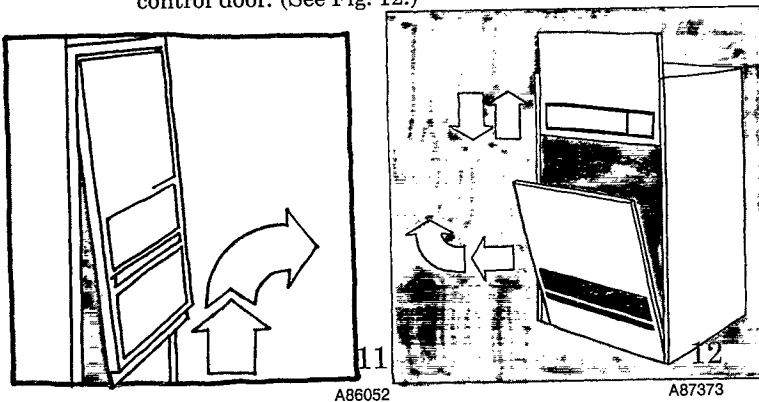

5. Turn the control knob on the gas valve to the OFF position and wait 5 minutes. Then smell for gas (including near the floor). If you smell gas, **STOP!** Follow operating instructions on furnace control access door. (See Fig. 13.)
6. After waiting 5 minutes, turn the control knob on the gas valve to the ON position. (See Fig. 13.)

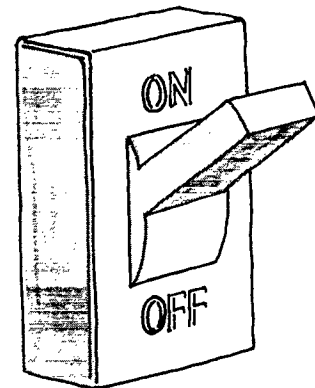
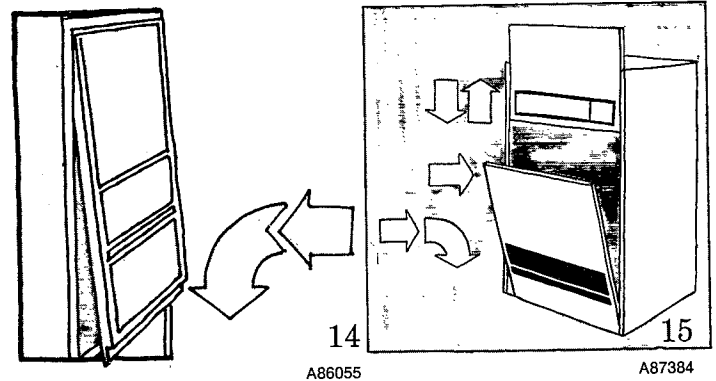

7. Replace the access door(s). (See Fig. 14 for upflow and Fig. 15 for downflow.) Replace control door first on downflow furnaces. Then replace blower door.
8. Turn ON the electrical supply to the furnace and wait 1 minute. (See Fig. 16.)
9. Open the external manual gas valve. (See Fig. 17.)
10. Set the room thermostat to a temperature slightly above room temperature. This will automatically signal the furnace to start.
11. The speed of the induced draft motor is gradually increased until the flow-proving switches make. Shortly thereafter the pilot ignition system begins sparking and the pilot flame lights. After a 40- to 70-sec time delay that takes place while the system is automatically verifying that a pilot flame has been established, the gas valve permits gas to flow to the main burners, and the pilot lights the burners. After another built-in time-delay of approximately 35 sec, your furnace blower starts at low speed for 20 sec before the microprocessor control makes the necessary adjustments to operate the blower at either the low- or high-fire speed.

NOTE: If the pilot fails to ignite within 5 minutes (twice), the furnace control system will lockout. If lockout occurs, the main burners fail to light, or the blower doesn't come on, shut down your furnace and call your dealer for service.

12. Set your thermostat to the temperature that satisfies your comfort requirements. **SUGGESTION:** Setting the thermostat back a few degrees—and compensating for the difference with warmer clothing—can make a big difference in your fuel consumption on extremely cold days. The few

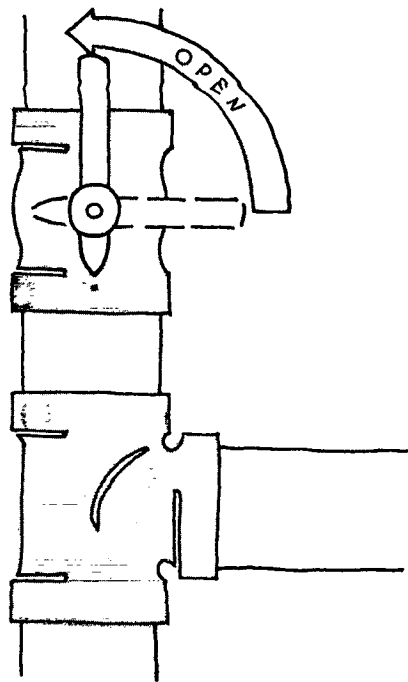

17

A86035

degrees at the top of your thermostat "comfort level" are the most costly degrees to obtain.

When the room temperature drops below the temperature selected on the thermostat, the furnace will be switched on automatically. When the room temperature reaches the degree selected on the thermostat, the furnace will be automatically switched off.

Some thermostats have a "fan" switch with 2 selections: AUTO or ON. When set on AUTO, the furnace blower cycles on and off, controlled by the thermostat. In the ON position, the furnace blower runs continuously. This keeps the temperature level in your home more evenly balanced. It also continuously filters the indoor air.

SHUTTING DOWN YOUR FURNACE

Should you need to shut down your furnace for service or maintenance, you will need to turn the furnace OFF. The following procedures must be followed:

1. Set your room thermostat to the lowest temperature setting. (See Fig. 18.)
2. Close the external manual gas valve. (See Fig. 9.)
3. Turn OFF the electrical power to your furnace. (See Fig. 19.)

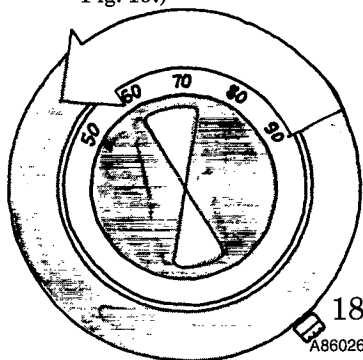

18

A86026

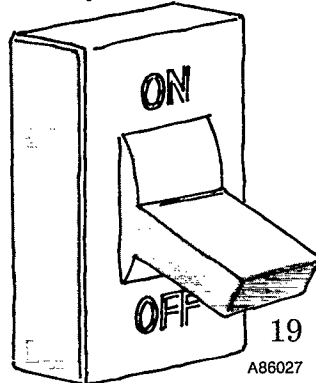

19

A86027

4. Remove the control access door on your furnace. (See Fig. 11 or 12.)
5. Turn the control knob on the gas valve to the OFF position. (See Fig. 20.)
6. Replace the control access door. (See Fig. 14 or 15.)
7. If the furnace is being shut down because of a malfunction, call your dealer as soon as possible.

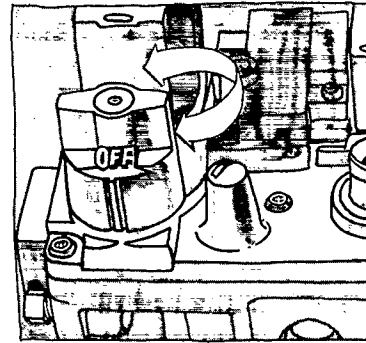

20

A87374

CAUTION: Furnace is not to be installed, operated, and then turned off and left turned off in an unoccupied structure during winter. (See winterizing procedures in maintenance section).

PERFORMING ROUTINE MAINTENANCE

With proper maintenance and care, your furnace will operate economically and dependably. Instructions for basic maintenance, which can easily be followed, are found on this and the following pages. However, before beginning maintenance, follow these safety precautions:

WARNING: Turn OFF electrical power supply to your furnace before removing the access doors to service or perform maintenance. Failure to follow this warning could result in personal injury or death.

CAUTION: Although special care has been taken to minimize sharp edges, be extremely careful when handling parts or reaching into the furnace.

FILTERING OUT TROUBLE

A dirty filter will cause a loss of airflow in your duct system; the microprocessor will detect an airflow change and compensate for slight variations. When the microprocessor cannot compensate for the excessive loss of airflow, a blower calibration fault will be signaled and the furnace will operate only in the low-heat mode. If this condition is left unattended, the furnace will eventually lockout. It is recommended that the furnace filter be checked every 3 or 4 weeks and cleaned if necessary.

CAUTION: Never operate your furnace without a filter in place. Doing so may damage the furnace blower motor. An accumulation of dust and lint on internal parts of your furnace can cause a loss of efficiency.

The air filter is normally located in the blower compartment. (See Fig. 3.) Filters for the downflow furnaces are normally located in the return-air plenum above the blower. If the filters have been installed in another location, contact your dealer for instructions. To inspect, clean and/or replace the air filter(s), follow these steps:

● UPFLOW FURNACES ONLY:

1. Turn OFF the electrical supply to the furnace. (See Fig. 19.)
2. Remove control and blower access doors. (See Fig. 21 and 22.)
3. Push filter retainer toward the back of the furnace until it clears the flange on the furnace casing. (See Fig. 23.)

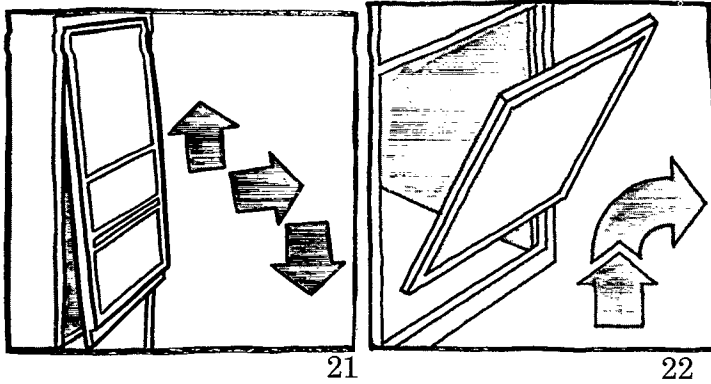

21
A88587

22
A86056

4. Gently remove the filter and carefully turn the dirty side up (if dirty) to avoid "spilling" dirt from the filter. (See Fig. 24.)
5. Inspect the filter. If torn, replace it.
6. Wash the filter (if dirty) in a sink, bathtub, or outside with a garden hose. Always use cold tap water. A mild liquid detergent may be used if necessary. Spray water through the filter in the opposite direction of airflow (through the cross-mesh binding side). Allow filter to dry.

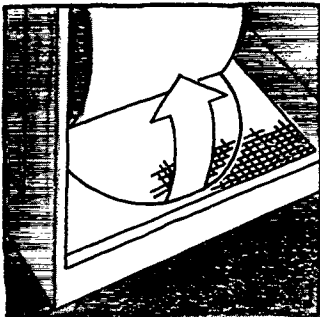

A86038

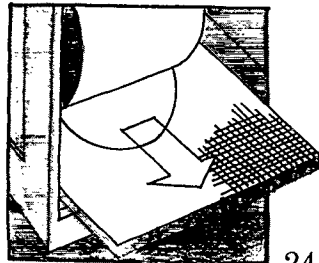

24
A86039

7. Reinstall the clean filter with the cross-mesh binding side facing the furnace blower.
8. Push filter retainer toward back of the furnace until it will go behind the flange on the furnace casing.
9. Replace blower and control access doors and turn ON electrical power to your furnace. (See Fig. 25 and 26.)

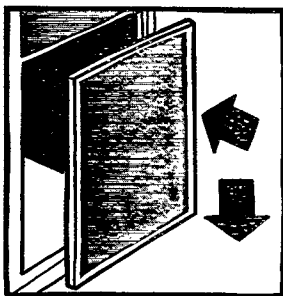

25
A88588

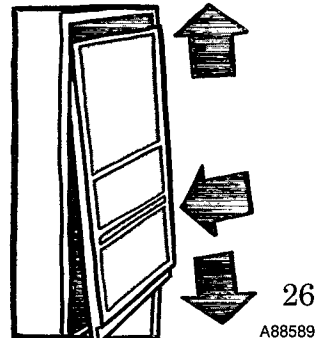

26
A88589

If your furnace filter needs to be replaced, be sure to use the same size and type of filter that was originally supplied. Use the furnace filter table and compare your furnace size with the proper filter size.

UPFLOW FURNACE FILTER TABLE

UPFLOW FURNACE CASING WIDTH	FILTER SIZE* (IN.)	FILTER TYPE
17-1/2	(1) 15-7/8 x 27-3/4 x 1	Cleanable
21	(1) 19-1/2 x 27-3/4 x 1	Cleanable

*Furnaces with a side return-air inlet may have a different filter size. Measure the filter to obtain the correct size.

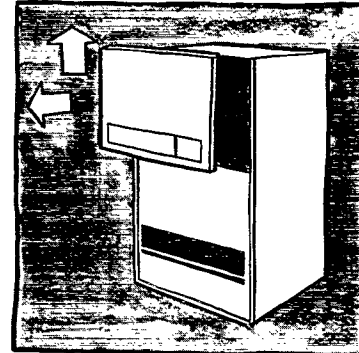

27
A88590

● **DOWNFLOW FURNACES ONLY:** Two filters are located in the return-air plenum above the blower (above line-of-sight) attached to the top of the furnace. (See Fig. 28.)

1. Turn OFF electrical supply to the furnace. (See Fig. 19.)
2. Remove blower access door. (See Fig. 27.)
3. Remove the left side filter by tipping the filter toward the center—raise it from the V-shaped channel in which it rests. (See Fig. 28 and 29.)

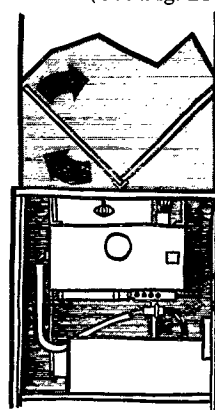

28
A92156

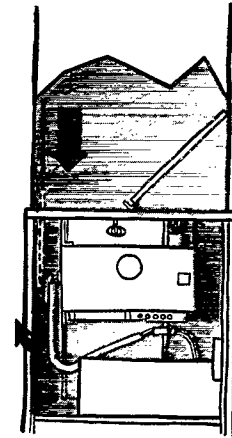

29
A92155

DOWNFLOW FURNACE FILTER TABLE

DOWNFLOW FURNACE CASING WIDTH	FILTER SIZE* (IN.)	FILTER TYPE
All	(2) 16 x 20 x 1	Cleanable

4. Lower filter down along side of the blower and remove from the furnace.
5. To remove the second filter, lift from V-shaped channel and remove the same way as left side filter.
6. Inspect the filters. If torn, replace the filter.
7. Wash the filters (if dirty) in a sink, bathtub, or outside with a garden hose. Always use cold tap water. A mild liquid detergent may be used if necessary. Spray water through the filter in the opposite direction of airflow through the cross-mesh binding side. Allow filter to dry.
8. Reinstall the clean filters with the cross-mesh binding side facing the furnace blower.
9. Replace blower door and turn ON electrical supply to your furnace. (See Fig. 30.)

COMBUSTION AREA AND VENT SYSTEM

Visually inspect the combustion area and vent system before each heating season. Make sure that all PVC pipes leading into the combustion area and vent are free from any cracks and sags. Also check the combustion-air intake and vent pipes on the outside of your home for blockage.

When dirt, soot or rust is allowed to build up, your furnace can suffer a loss of efficiency and perform improperly. Accumulations on the main burners can result in their firing out of normal sequence. This delayed ignition will create an alarmingly loud sound.

CAUTION: If your furnace makes an especially loud noise when the main burners light, shut down your furnace and call your dealer.

To inspect the combustion area and vent system, you will need a flashlight. Refer to Fig. 3 or 4, and proceed as follows:

1. Turn OFF the electrical supply to your furnace and remove the access doors. (See Fig. 10 and 11, or 12.)
2. Remove burner enclosure front. (See Fig. 31 or 32.)

Inspect the gas burners and pilot area for dirt, rust, or scale. (See Fig. 33.) Then inspect the vent outlet area and vent pipe.

CAUTION: If dirt, rust, soot, or scale accumulations are found, call your dealer. Do not operate your furnace.

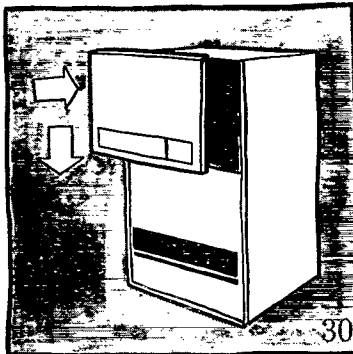

A88591

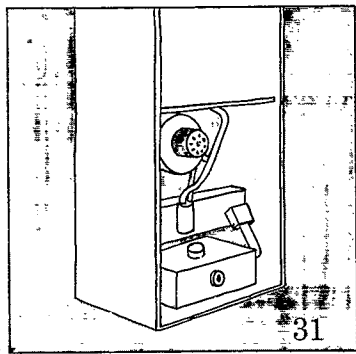

A87387

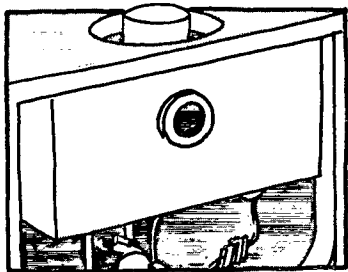

32
A86057

3. Inspect the vent pipe for sag, holes, cracks, or disconnection.

DANGER: If holes are found in the vent pipe, or if it has become disconnected, toxic fumes can escape into your home. DO NOT OPERATE YOUR FURNACE. Call your dealer for service.

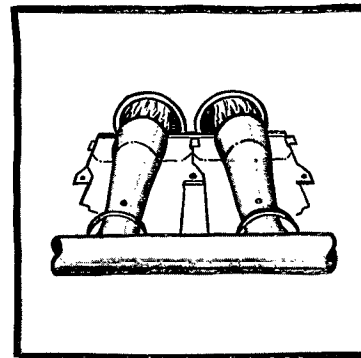

33

A91065

4. Reinstall the burner enclosure front.
5. If your furnace is free of the above conditions, replace the blower access door and restore electrical power to your furnace. (See Fig. 14, or 15 and 16.)
6. Start your furnace and observe its operation. Watch the burner flames to see if they are clear blue, almost transparent. The pilot flame should be well defined. (See Fig. 33.) If you observe a suspected malfunction, or that the burner flames are not clear blue, or the pilot flame not well defined, call your dealer.
7. If your furnace is operating properly, reinstall the control access door.

HEADING SOUTH FOR THE WINTER?

DON'T FORGET YOUR FURNACE!

Since the furnace uses a condensing heat exchanger, some water will accumulate in the unit as a result of the heat transfer process. Therefore, once it has been operated, it cannot be turned off and left off for an extended period of time when temperatures will reach 32 degrees F or lower, unless winterized. Follow these procedures to winterize your furnace:

1. Mix a solution of equal amounts of ethylene glycol (Prestone II antifreeze coolant or equivalent) and water.
2. Turn OFF electrical supply to furnace. (See Fig. 10.)
3. Remove control access door. (See Fig. 11 or 12.)
4. Disconnect drain tube from bottom of inducer vent outlet. (See Fig. 34 or 35.)

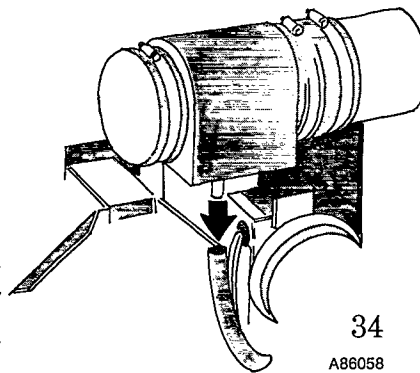

34
A86058

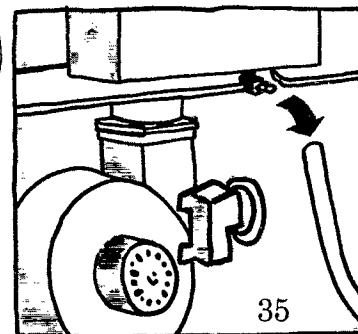

35
A87388

5. Insert funnel in drain tube and pour antifreeze/water solution into furnace until it is visible at point where condensate enters open drain. (See Fig. 36.)
6. Reconnect drain tube to vent outlet.
7. Replace control access panel. (See Fig. 14 or 15.)

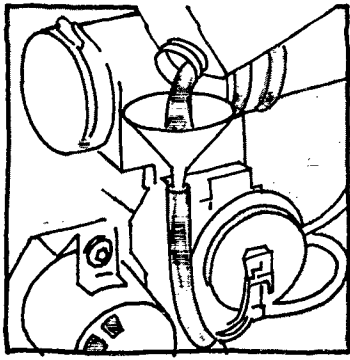

36

A86059

A CHECKUP CHECKLIST

Your furnace represents an important investment in your family's comfort and your home's value. To keep it in tip-top shape and as a preventative to future problems, have a trained service specialist give your furnace a professional check-up annually. The following checklist can be used as a guideline to proper service:

- Inspect all flue gas passages, burners, heat exchangers, coupling box(es), and inducer assembly.
- Inspect all combustion and ventilation air passages and openings, including combustion air and vent pipe terminations outside the structure.
- Check gas pipes leading to and inside of your furnace for leaks.
- Inspect, clean, and lubricate the blower, blower motor, and wheel as required.

NOTE: If oil ports are provided, refer to the unit Service and Maintenance Instructions for blower motor oiling information. The motor must be oiled, if applicable, by a qualified service technician.

- Inspect and change or clean air filter(s) if necessary.
- Inspect all supply- and return-air ducts for obstructions, air leaks, and insulation. Remedy any problem when necessary.
- Inspect electrical wiring, connections, and components for loose connections.
- Perform an operational checkout to determine whether your furnace is working properly and if it requires adjustments.
- Inspect all condensate tubes and connections, condensate trap assembly, and drain for leaks. The condensate removal system should be cleaned annually by a qualified service agency; refer to the Service and Maintenance Instructions for further information.
- Examine the physical support of the furnace; the support should be sound with no cracks, sagging, gaps, etc. around the base.
- Check the furnace for any obvious signs of deterioration.

BEFORE YOU REQUEST A SERVICE CALL

If your furnace is not operating or not performing properly, you may save the expense of a service call by checking a few things yourself before calling for service.

For your convenience, record the product and serial numbers on the form on page 2. Should you ever require service, you will have ready access to the information needed by your service representative.

This furnace has an LED fault code display to aid the installer, service technician, or homeowner while installing or servicing the unit. The fault code display can be seen through the view port provided in the blower door. To decipher the meaning of the fault code, the following cross-reference can be used:

FAULT CODE	FAULT CODE DESCRIPTION	CHECKLIST
12 or 44	Blower Calibration Lockout or Blower Calibration Fault	<input type="checkbox"/> Check for dirty air filter <input type="checkbox"/> Check for blocked return-air or supply-air grilles throughout your home. <input type="checkbox"/> Turn electrical power supply OFF then back ON and set the thermostat switch to "call" for heat.
14 or 34	Pilot Proving Lockout or Pilot Proving Fault	<input type="checkbox"/> Manual shut-off valve in gas supply pipe in open position (follow start-up procedure if you open gas line). NOTE: Turn off the electrical power supply and remove access doors before continuing with this checklist. <input type="checkbox"/> Control knob on gas valve in ON position (follow start-up procedures if you must reset dial to ON).
42	Inducer Outside Valid Speed Range	<input type="checkbox"/> Check to make sure that all PVC pipes leading into the combustion-air intake and vent/exhaust are free from any cracks and sags. Also check the combustion-air intake and vent/exhaust pipes on the outside of your home for blockage.
Any Other Fault	13, 21, 22, 23, 24, 31, 32, 33, 41, and 43 or either RED LED on continuously.	<input type="checkbox"/> Call dealer for service.
No Fault Signaled	When Furnace Fails to Operate and no Fault is Signaled	<input type="checkbox"/> Check thermostat for proper temperature setting. <input type="checkbox"/> Thermostat switch on HEAT? <input type="checkbox"/> Check fuses and circuit breakers. <input type="checkbox"/> Blower door properly in place?

1. RED LED 1 on continuously means furnace is operating in emergency heat.
2. RED LED 2 on continuously means the microprocessor board has malfunctioned.
3. YEL LED 3 on continuously means furnace is operating in high heat.
4. GRN LED 4 on continuously means furnace is operating in low heat.
5. Alternate flashing of YEL and GRN LED's indicates fault.

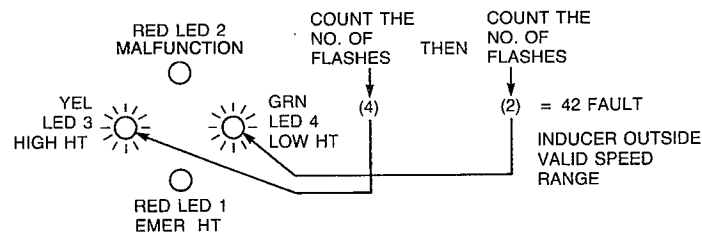

A87348

Bryant, Day & Night, Payne Brands

FOR SERVICE OR REPAIR, FOLLOW THESE STEPS IN ORDER:

- FIRST:** Contact the installer. You may find his name on the product or in your User's Manual. If his name is not known, call your builder if yours is a new residence.
- SECOND:** Contact the nearest distributor. (See telephone yellow pages.)
- THIRD:** Contact:
BDP
Consumer Relations
P.O. Box 4952
Syracuse, New York 13221-4952
Phone: 1-800-428-4326 (TOLL FREE) from USA.
1-315-432-7885 from Canada.

Model No. _____ Unit Serial No. _____
Date of Installation _____ Installed by _____
Name of Owner _____ Address of Installation _____

Indoor Deluxe Gas-Fired Electronic Condensing Furnace Limited Warranty

ONE-YEAR WARRANTY—This CARRIER CORPORATION (hereinafter referred to as "COMPANY") product is warranted to be free from defects in material and workmanship under normal use and maintenance for a period of one year from the date of original installation whether or not actual use begins on that date. A new or remanufactured part, at the COMPANY'S sole option, to replace any defective part will be provided without charge for the part itself; PROVIDED the defective part is returned to our distributor through a qualified servicing dealer. The replacement part assumes the unused portion of the warranty.

THIS WARRANTY DOES NOT INCLUDE ANY ADDITIONAL LABOR ALLOWANCE OR OTHER COSTS incurred for diagnosing, repairing, removing, installing, shipping, servicing or handling of either defective parts or replacement parts. Such costs may be covered by a separate warranty provided by the installer.

EXTENDED 4-YEAR WARRANTY ON MICROPROCESSOR CONTROL CENTER, VARIABLE SPEED MOTORS AND MOTOR CONTROLLERS ONLY—During the second through the fifth years after the date of original installation, the COMPANY further warrants the microprocessor control center, variable speed motors and motor controllers against defects in material or workmanship under normal use and maintenance. A new or remanufactured part, at COMPANY'S sole option, will be provided without charge for the part itself; PROVIDED the defective part is returned to our distributor through a qualified servicing dealer.

EXTENDED WARRANTY ON HEAT EXCHANGER ONLY—

A. LIFETIME WARRANTY

Beginning on the date of original installation, the COMPANY warrants to the original purchaser, during his or her lifetime, that the heat exchanger will be free from defects in material and workmanship, provided, however, this warranty shall apply only to the original installation of the furnace in a single family dwelling (i.e., where the furnace services only one dwelling unit) used without interruption by the purchaser as his or her principal residence.

B. 20-YEAR WARRANTY

Where the owner of the dwelling is not the original purchaser and in multi-family dwellings (i.e., where the furnace services more than one dwelling unit) and in non-residential and other applications, the COMPANY warrants the heat exchanger against defects in material and workmanship for a period of twenty years from the date of original installation.

In order to fill this warranty obligation in A or B above, the COMPANY will, at its sole option, provide a new heat exchanger without charge, or allow a credit, in the amount of the then current retail selling price of an equivalent heat exchanger toward the purchase price of a new BRYANT, DAY &

NIGHT or PAYNE deluxe gas-fired furnace, PROVIDED the defective heat exchanger is returned to our distributor through a qualified servicing dealer.

THESE EXTENDED WARRANTIES DO NOT INCLUDE LABOR OR OTHER COSTS incurred for diagnosing, repairing, removing, installing, shipping, servicing or handling of either defective parts or replacement parts.

THESE WARRANTIES APPLY ONLY TO PRODUCTS IN THEIR ORIGINAL INSTALLATION LOCATION AND BECOME VOID UPON REINSTALLATION.

LIMITATIONS OF WARRANTIES—ALL IMPLIED WARRANTIES (INCLUDING IMPLIED WARRANTIES OF MERCHANTABILITY) ARE HEREBY LIMITED IN DURATION TO THE PERIOD FOR WHICH THE LIMITED WARRANTY IS GIVEN. SOME STATES DO NOT ALLOW LIMITATIONS ON HOW LONG AN IMPLIED WARRANTY LASTS, SO THE ABOVE MAY NOT APPLY TO YOU. THE EXPRESSED WARRANTIES MADE IN THIS WARRANTY ARE EXCLUSIVE AND MAY NOT BE ALTERED, ENLARGED, OR CHANGED BY ANY DISTRIBUTOR, DEALER, OR OTHER PERSON WHATSOEVER.

ALL WORK UNDER THE TERMS OF THIS WARRANTY SHALL BE PERFORMED DURING NORMAL WORKING HOURS. ALL REPLACEMENT PARTS, WHETHER NEW OR REMANUFACTURED, ASSUME AS THEIR WARRANTY PERIOD ONLY THE REMAINING TIME PERIOD OF THIS WARRANTY.

THE COMPANY WILL NOT BE RESPONSIBLE FOR:

1. Normal maintenance as outlined in the installation and servicing instructions or owners manual including coil cleaning, filter cleaning and/or replacement and lubrication.
2. Damage or repairs required as a consequence of faulty installation, misapplication, abuse, improper servicing, unauthorized alteration or improper operation.
3. Failure to start due to voltage conditions, blown fuses, open circuit breakers or other damages due to the inadequacy or interruption of electrical service.
4. Damage as a result of floods, winds, fires, lightning, accidents, corrosive environments or other conditions beyond the control of the COMPANY.
5. Parts not supplied or designated by the COMPANY, or damages resulting from their use.
6. COMPANY products installed outside the continental U.S.A., Alaska, Hawaii and Canada.
7. Electricity or fuel costs or increases in electricity or fuel costs from any reason whatsoever including additional or unusual use of supplemental electric heat.
8. **ANY SPECIAL INDIRECT OR CONSEQUENTIAL PROPERTY OR COMMERCIAL DAMAGE OF ANY NATURE WHATSOEVER.** Some states do not allow the exclusion of incidental or consequential damages, so the above limitation may not apply to you.

This warranty gives you specific legal rights, and you may also have other rights which vary from state to state.

Catalog No. BDP-3339-810

39004DP79

Free Manuals Download Website

<http://myh66.com>

<http://usermanuals.us>

<http://www.somanuals.com>

<http://www.4manuals.cc>

<http://www.manual-lib.com>

<http://www.404manual.com>

<http://www.luxmanual.com>

<http://aubethermostatmanual.com>

Golf course search by state

<http://golfingnear.com>

Email search by domain

<http://emailbydomain.com>

Auto manuals search

<http://auto.somanuals.com>

TV manuals search

<http://tv.somanuals.com>