

# IMPORTANT!

You must ensure that you follow these instructions carefully and correctly. If this seat is not fitted securely and your child is not strapped in correctly, your child and other passengers are at serious risk of injury in the event of an accident

## Please read this User Guide carefully BEFORE trying to install your child car seat

The Hampshire Trading Standards Authority and Britax advise that child car seats should not be bought or sold second-hand. Please dispose of your child seat safely. Do not sell or pass it on.

**After an accident**, the child seat and your vehicle seat belts should be replaced. Although they may look undamaged, if you were to have another accident the child seat and your vehicle seat belts may not be able to protect your child as well as they should.

### No child seat is escape proof

Harness systems cannot be designed to be completely "child proof" and yet comply with the legal requirements of European Standard ECE R44. The harness must be fastened and adjusted correctly at all times and children encouraged to remain within the harness system.

### Looking after your child seat

Food and drink may find their way inside the buckle of the harness. This can stop it from working properly – it will not click. Wash in warm water until clean (dia A and B).

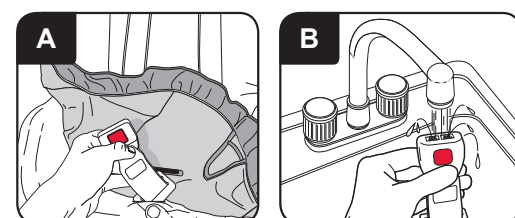

### Cleaning the cover

Please read the labels on the cover for washing instructions.

**DO NOT** tumble dry the cover – short spin and drip dry only.

### Cleaning the seat shell

Sponge clean **ONLY** using hand soap and warm water.

**DO NOT** take apart, or attempt to take apart, any part of the seat when cleaning.

**DO NOT** use solvents, detergents or washing-up liquid as these may weaken the seat.

**DO NOT** lubricate or oil any part of the seat.

### Removing the cover

Press in and hold the adjuster button with your hand below the chest pads (dia 1a) pull **BOTH** shoulder straps forward as far as possible. Unfasten the buckle by pressing the red harness buckle button (dia 1c). Undo the press studs from around the harness straps on either side of the headrest cover, tilt the headrest forward and lift off the headrest cover. Undo the press studs on the backrest cover, push the harness buckle and adjuster strap through the cover, unhook the elastic seam of the cover from under the edge of the seat shell and gently lift the backrest cover off the shell.

### Re-fitting the cover

Simply proceed in the reverse order.

**IMPORTANT** – The cover is a safety feature. **NEVER** use the child seat without it. Don't put your child's safety at risk by using other makes of replacement cover, they could stop the child seat from protecting your child as well as it should.

A replacement cover is available from your Britax stockist or contact Britax Customer Service Department on **01264 386034**.

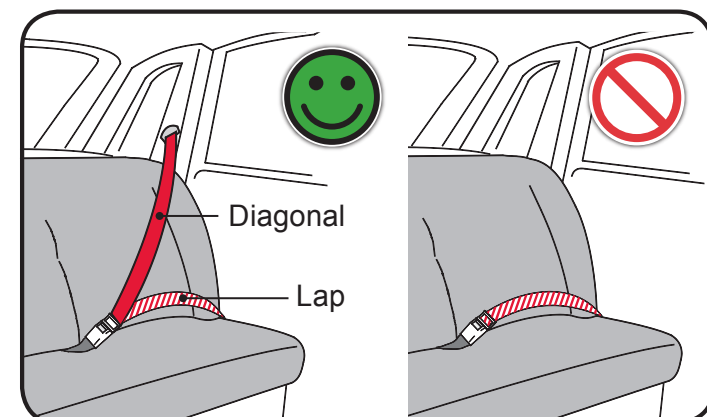

### Guarantee

All Britax products are carefully designed, manufactured and tested. However, should this product prove faulty within 12 months of purchase due to a materials or manufacturing fault please return it to the original place of purchase. We will then, at our discretion, either repair it free of charge or replace it with the same or a similar product.

For guarantee purposes proof of purchase will be required. We recommend that you retain your receipt and attach it to this user guide. They should be kept in a safe place.

Britax does not accept liability for damage arising from abuse, misuse or negligence. This guarantee is not transferable and therefore does not apply to second-hand products.

Your statutory rights are not affected by this guarantee.

### If in doubt

Not all car seats fit all cars. For advice as to the suitability of this restraint for your vehicle please use the vehicle approval list, **Fit-finder** on our website at [www.britax.eu](http://www.britax.eu) or call our Customer Service Helpline on 01264 386034 or email [helpline@britax.eu](mailto:helpline@britax.eu).

Service Helpline on 01264 386034 or email [helpline@britax.eu](mailto:helpline@britax.eu).

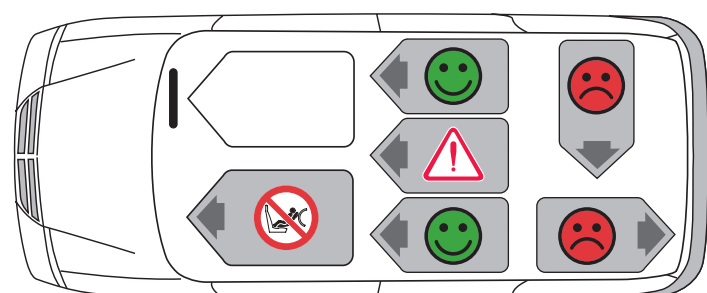

**IMPORTANT** – ISOFIX should only be used with vehicles which appear on the supplied vehicle applications list. An up-to-date copy of the list can also be found on our website.



*Britax, whilst taking into account child car seat contact with vehicle seats throughout the development of new products, cannot accept responsibility for damage occurring to vehicle seats or seat belts.*



**IMPORTANT** – The child seat **MUST** only be used with a lap and diagonal seat belt (approved to UN/ECE Regulation no. 16 or other equivalent standards).

### Britax Excelsior Limited

1 Churchill Way West  
Andover  
Hampshire SP10 3UW  
United Kingdom

### A Britax Childcare company

Customer Service Helpline: 01264 386034

Email: [helpline@britax.eu](mailto:helpline@britax.eu)

Switchboard: 01264 333343

Fax: 01264 334146

[www.britax.eu](http://www.britax.eu)

Britax is a registered trademark of Britax Childcare



## WARNING

### EXTREME HAZARD!

**DO NOT** use the child seat on a passenger seat fitted with an active front airbag unless your vehicle manufacturer confirms that it is safe.

**DO NOT** use the child seat on rearward facing seats.

**DO NOT** use the child seat on side facing vehicle seats.

**DO NOT** use anything, such as a cushion or coat, to raise the child seat off the passenger seat. In an accident the child seat and your vehicle seat belts would not be able to protect your child as well as they should.

**DO NOT** use the child seat in the home. It has not been designed for home use and should only be used in your vehicle.

**DO NOT** attempt to dismantle, modify or add to any part of the child seat or change the way its harness or your vehicle seat belts are made or used. The official approval is no longer valid if modifications are made. **NO** modifications may be made to the child seat other than by the manufacturer.

**DO NOT** leave children alone in your car, even for a short time.

**DO NOT** leave loose objects, such as luggage or books, in the back of your vehicle. They must be properly secured, because if you have to stop your vehicle suddenly loose objects will keep moving and can then cause serious injuries. Large and heavy loose objects are a particular risk.

**DO NOT** leave folding passenger seats unlatched. If you have to stop your vehicle suddenly a loose seat back could injure your child.

**DO NOT** allow children to play with or adjust the child seat.

**DO** keep this user guide in the user guide storage slot.

**DO** cover the child seat if your car is left in direct sunlight. Fittings can become hot to touch in sunny weather and the cover may become faded.

**DO** make sure that the child seat does not become trapped by a folding passenger seat or in the door of your car.

**DO** make sure that you adjust the harness to fit the clothes your child is wearing before each journey – a fitting for winter clothes may be too slack for a child wearing summer clothes.

**DO** store the child seat in a safe place when it is not being used. Avoid placing heavy objects on top of it and do not store near direct heat sources or in direct sunlight.

**DO** always keep the child seat secure, even if it is not being used by your child.

**DO** make sure that all occupants in the vehicle are correctly restrained.

**DO** where necessary, use the insertion guides when installing the child seat with ISOFIX fittings. Failure to do so may result in damage to your vehicle seat.

**DO** make sure that your child seat is firmly latched to its anchorage points.

## Introducing your new child car seat

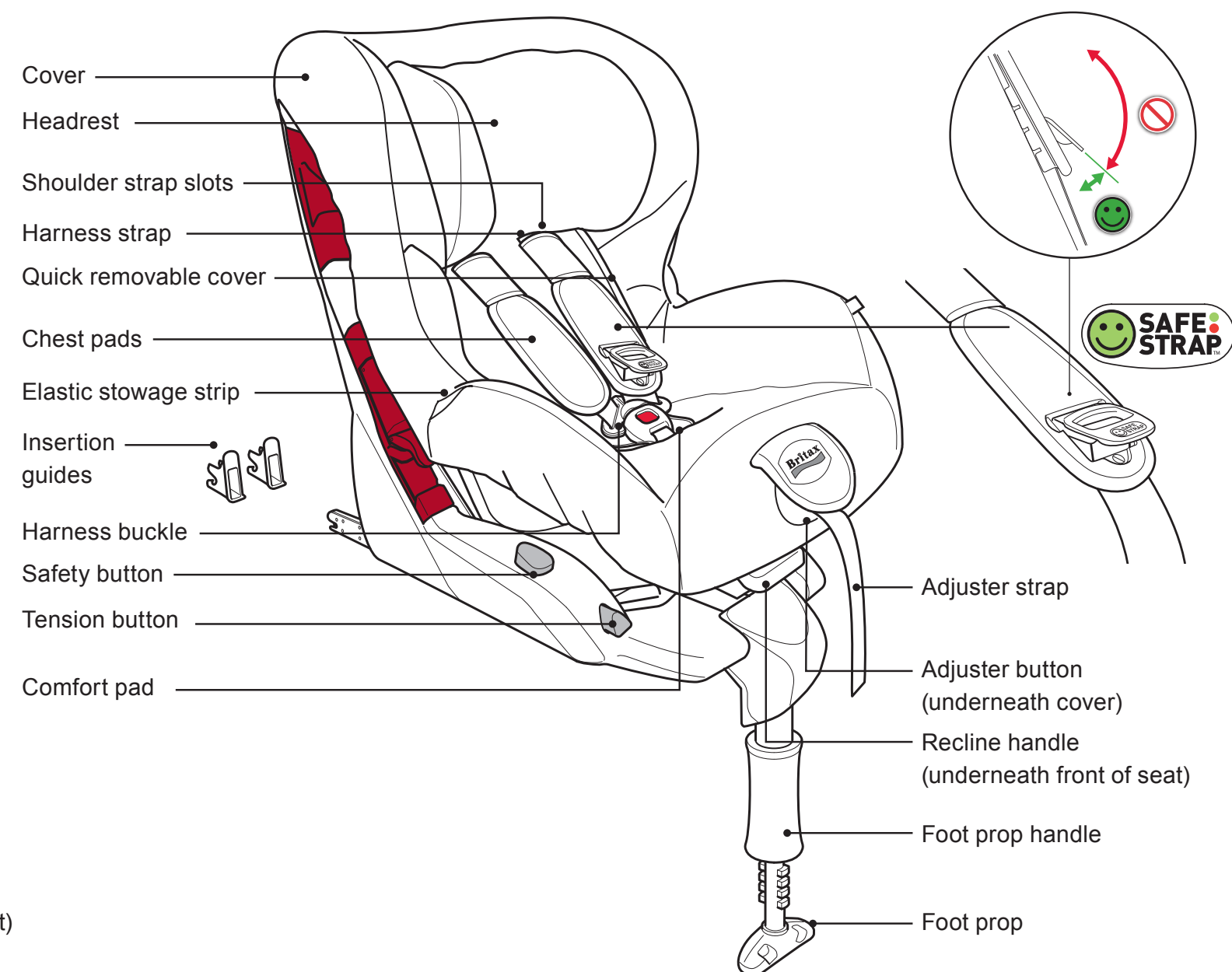
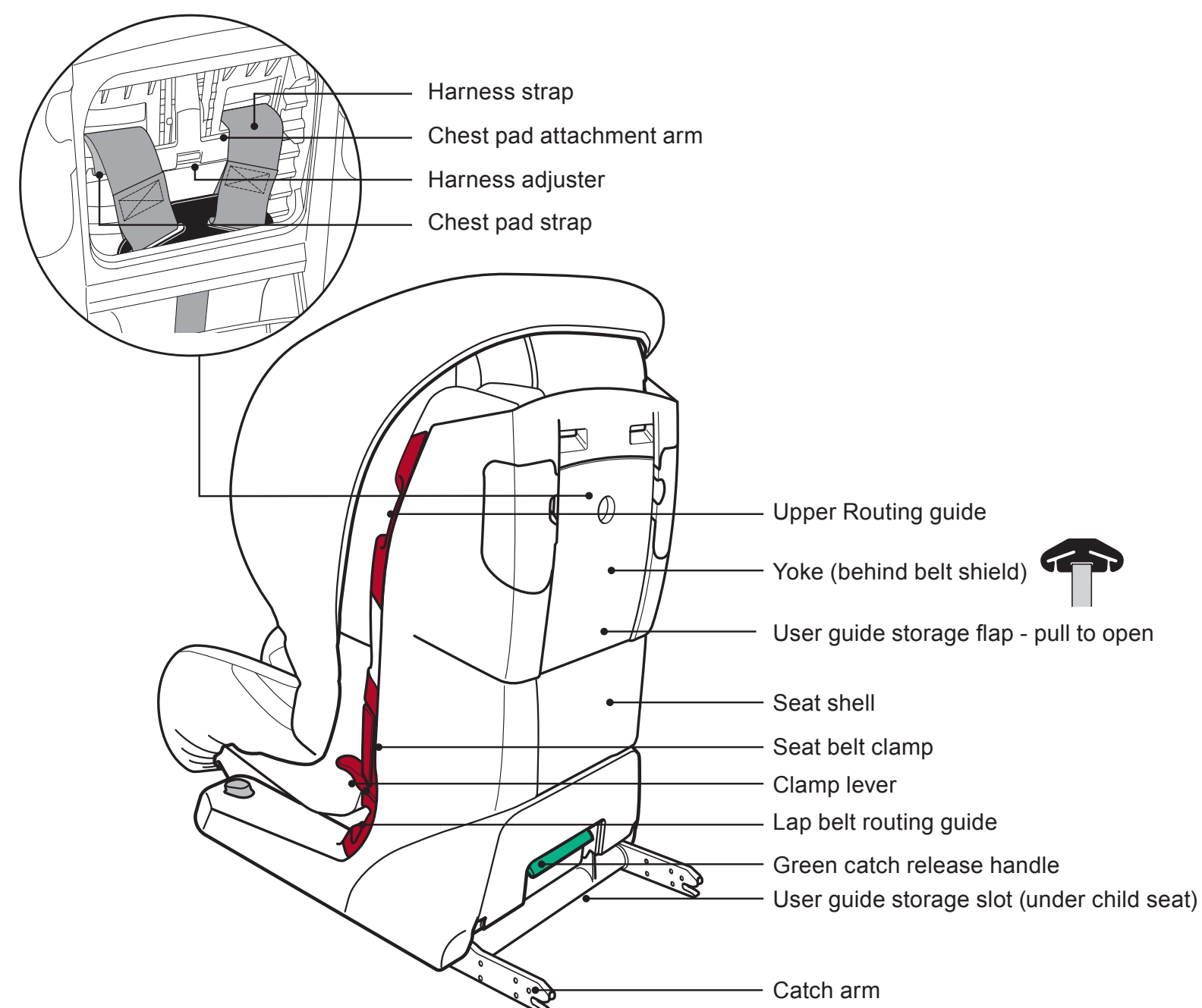

# Explora ISOFIX



## 1. Adjusting the child seat

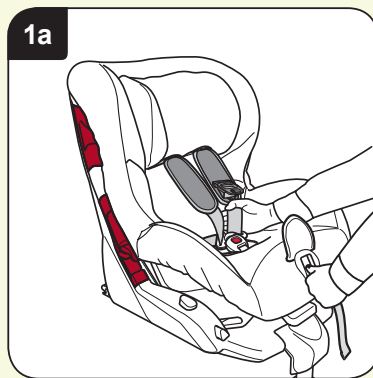

**Harness adjustment**  
With one hand press the adjuster button and with your other hand **BELOW** the chest pads, pull both shoulder straps forward as far as possible to loosen the harness (dia 1a).



Your child's head **MUST** be centralised within the headrest (dia 1b). The shoulder strap slots in the cover and shell **MUST** be level with the top of your child's shoulders. If in any doubt always position the slots slightly above the shoulder rather than below it (dia 1b). However, once you reach the top position your child may continue to use the seat until their eye line is above the top of the seat shell or their weight exceeds 18kg.

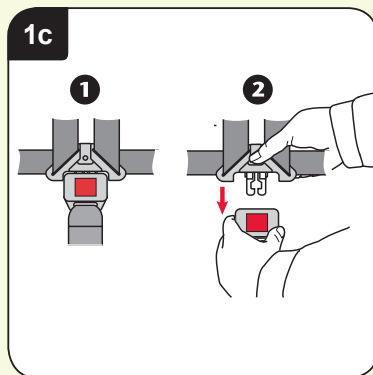

Unfasten the buckle by pressing the red harness buckle button ❶ (dia 1c). To fasten the buckle; first fit the two upper sections together, then push them firmly into the lower section until you hear a positive "CLICK" ❷.



**To tighten the harness**  
Sit your child in the child seat and fit the harness. Tighten the harness by pulling the adjuster strap forward until the gap on the SAFESTRAP™ indicator is less than 2cm wide. This indicates that the harness should be comfortable but firmly fitted around your child. Make sure the harness straps are not twisted. **IMPORTANT** – The lap section of the harness should rest as forward and as low as possible over your child's pelvis. Finally, ensure the chest pads are pulled down onto your child's chest (dia 1d).



**Reclining the child seat**  
The child seat can be used in either an upright, or reclined position (dia 1e). Squeeze the recline handle (dia 1e inset), underneath the front of the child seat, and slide the child seat shell into the desired position.

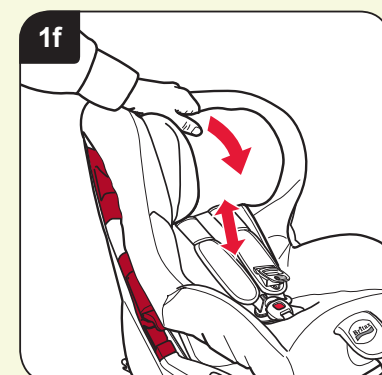

**To adjust the height of the headrest and harness to fit your child:**  
Loosen the harness straps as far as possible. Tip the headrest forward. The headrest adjuster is now unlocked. Slide the headrest up or down until the shoulder straps are at the correct height. Push the headrest back onto the seat shell to lock the headrest adjuster again (dia 1f).

## 2. Installing the child seat using your in-car ISOFIX fittings



**IMPORTANT** – The child seat is semi-universal. For advice as to the suitability of the child seat for your vehicle you **MUST** use the vehicle applications list, *Fit-finder*™ on our website at [www.britax.eu](http://www.britax.eu), call our Customer Service Helpline on 01264 386034 or email [helpline@britax.eu](mailto:helpline@britax.eu).

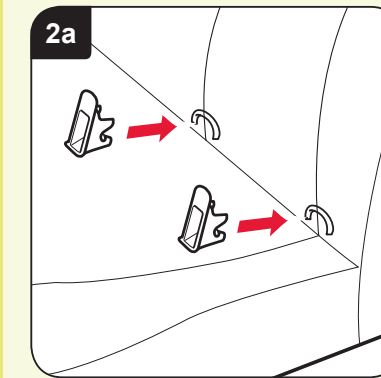

**Installing the child seat**  
If required, clip the two insertion guides onto the two ISOFIX anchorage points on the vehicle seat (between seat and backrest). The cut out on the insertion guide must point upwards (dia 2a). The insertion guides should be removed when not in use.

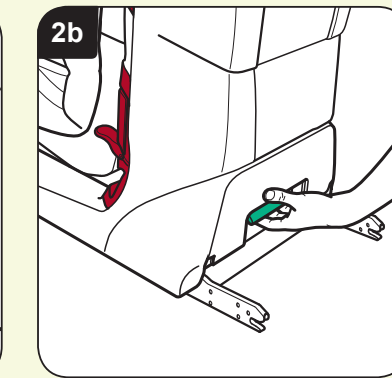

Pull the green catch release handle at the base of the seat out to extend the two catch arms fully (dia 2b). The catch arms release. Unfold the foot prop from the base.

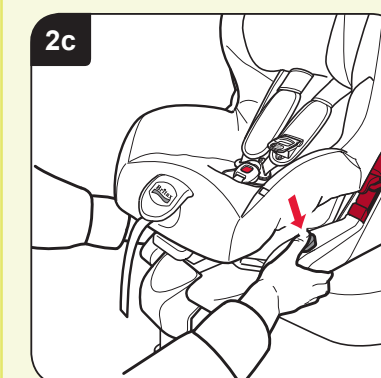

Press the safety buttons on the left and right side of the seat base together (dia 2c). **TIP** – This ensures that both hooks on the locking arms are open and ready to use.

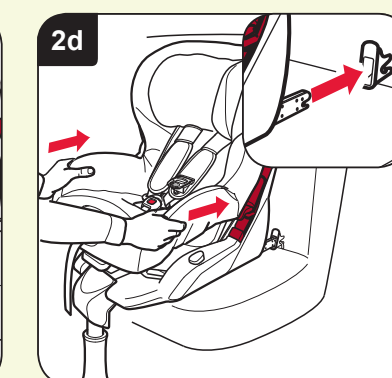

Guide both catch arms into the insert guides until the arms engage on both sides (dia 2d). "CLICK!"

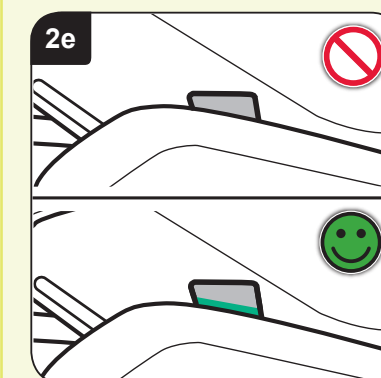

**IMPORTANT** – The green markings on the safety buttons must now be visible on both sides (dia 2e).

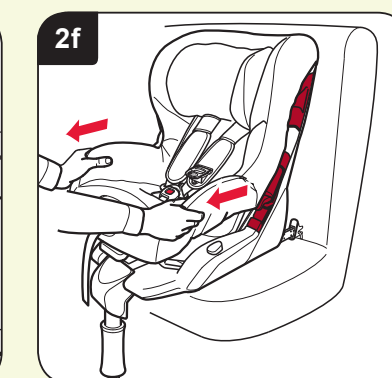

Pull on the child seat to ensure it is engaged on both sides (dia 2f).

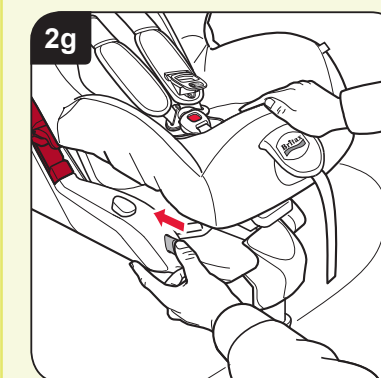

Press the tension button whilst pushing the child seat against the backrest of the vehicle seat (dia 2g).

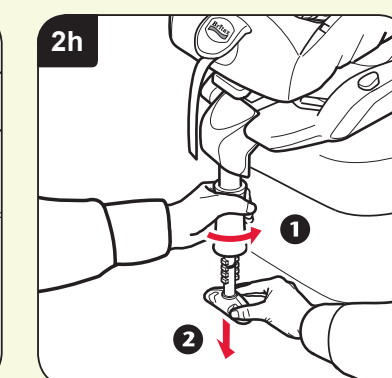

Turn the foot prop handle anticlockwise ❶ and pull out the foot prop ❷ until it rests firmly on the floor of the vehicle (dia 2h). **IMPORTANT** – The foot prop must never be suspended in mid-air or supported by other objects. Also ensure that the foot prop does not raise the child seat from the vehicle seat surface.

## 3. Removing the child seat installed with ISOFIX fittings

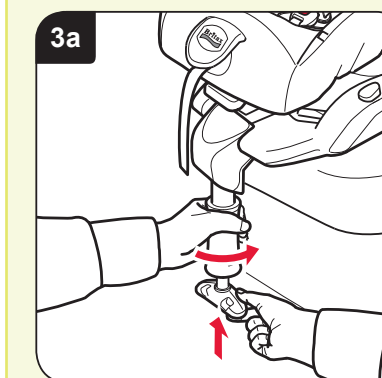

Turn the foot prop handle anticlockwise to shorten it (dia 3a).

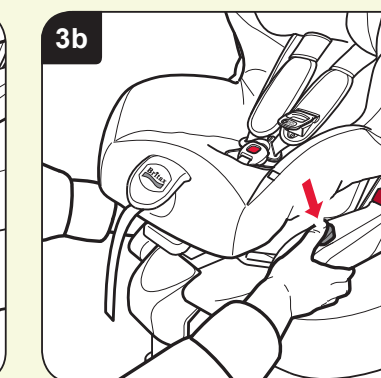

Press the safety buttons on the left and right side of the child seat to release it from the vehicle (dia 3b). The catch arms release.

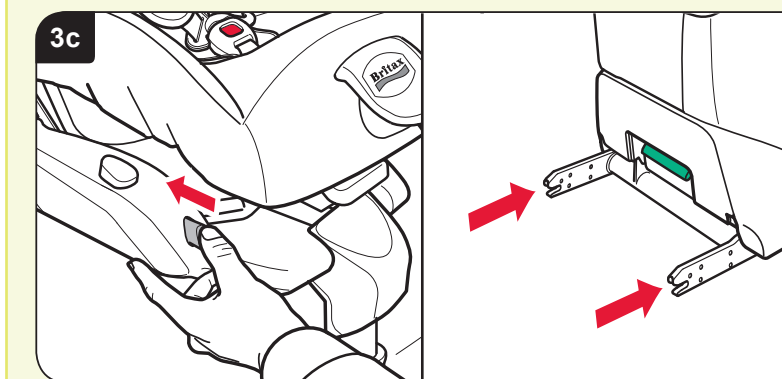

Press and hold the tension button whilst pushing the catch arms into the seat base at the same time (dia 3c). Fold the foot prop onto the bottom side of the seat base.

## 4. Installing the child seat in your vehicle using a lap and diagonal seat belt

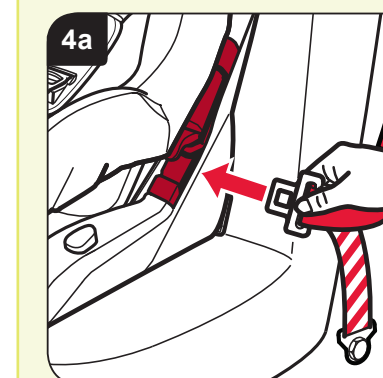

**IMPORTANT** – Ensure catch arms are stowed. Unfold the foot prop and place the child seat facing forward on the vehicle seat. Pull up on the adjustment handle and pull the seat shell forward into the reclining position.

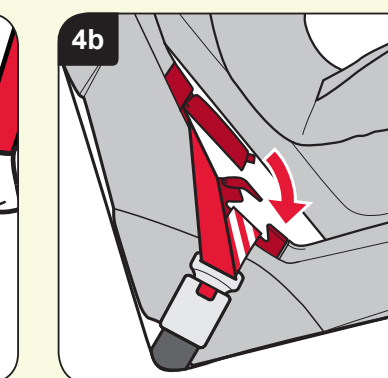

Engage the buckle tongue in the vehicle seat buckle. **CLICK!** Place the lap belt section in the lap belt routing guides on both sides of the seat base.



Pull up the vehicle seat belt and place it between the seat shell and the seat base (dia 4a).

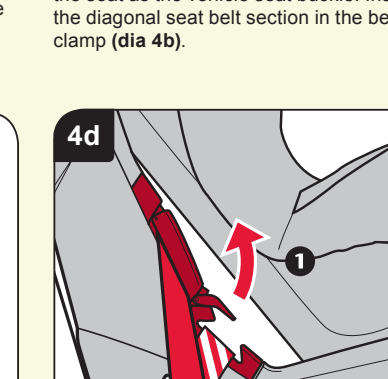

Press down the clamp lever of the dark red seat belt clamp on the same side of the seat as the vehicle seat buckle. Insert the diagonal seat belt section in the belt clamp (dia 4b).

**IMPORTANT** – Do not twist the belt. Firmly push the child seat into your vehicle seat using your body weight. Pull and hold the diagonal belt ❶. Pull at ❷ to remove all slack in the lap belt and insert the diagonal belt into the upper routing guide. (dia 4c).

Whilst holding the diagonal belt tight pull up on the clamp lever ❶ until it engages (dia 4d). **IMPORTANT** – The diagonal seat belt section may only be clamped on the side of the vehicle seat buckle.

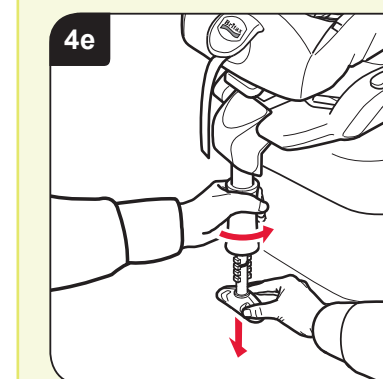

Turn the foot prop handle anticlockwise ❶ and pull out the foot prop ❷ until it rests firmly on the floor of the vehicle (dia 4e).

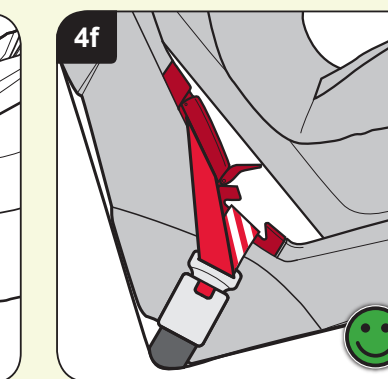

**IMPORTANT** – After installing the child seat you need to check the position of the seat belt buckle. **Checking the position of the seat belt buckle**  
If, after following the installation instructions, your seat belt buckle looks like this (dia 4f) the child seat should now be secure. To check this try to pull the seat forward by the harness. It should feel firm, not loose.

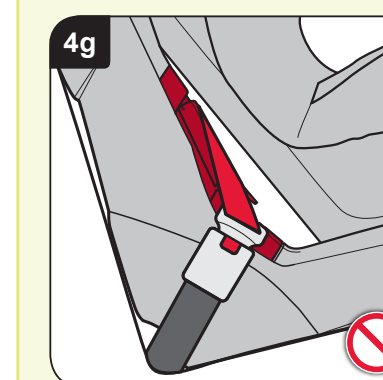

If, after following the above instructions, your seat belt buckle looks like this (dia 4g) the child seat is **NOT** correctly installed. Try another seating position in your car.

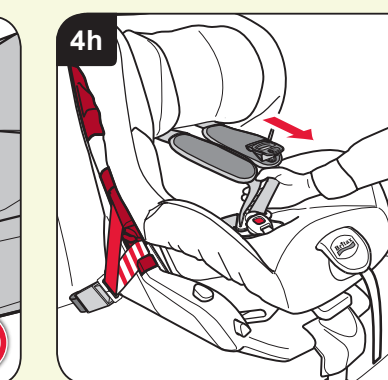

The child seat should now be secure. To check pull forward firmly on the harness. There should be little or no movement (dia 4h). If you are in any doubt contact Customer services on 01264 386034 or use our *Fit-finder* service at [www.britax.eu](http://www.britax.eu). To remove the child seat from the car, simply reverse these instructions.

## 5. Removing the SAFESTRAP™

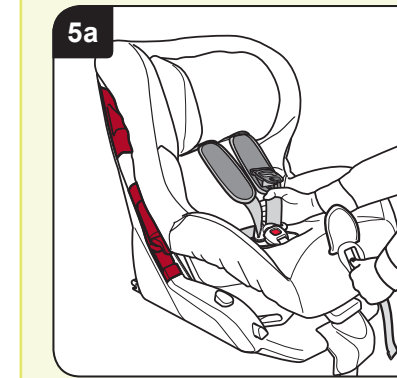

Push the adjuster button in and at the same time pull **BOTH** shoulder straps forward as far as possible (dia 5a).

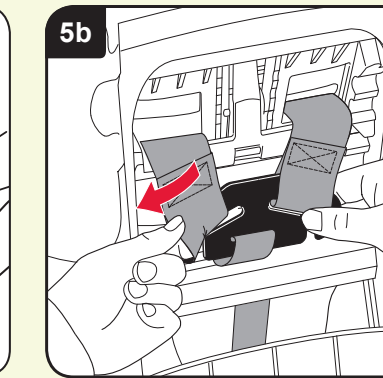

Turn the seat around and open the User Guide storage flap. Lift the harness adjuster at the back of the seat shell and move it up so that the shoulder strap slots in the headrest are in the top position. Unhook the harness strap from the yoke at the back of the child seat. Pull the harness strap through the shoulder strap slot to the front of the seat (dia 5b).

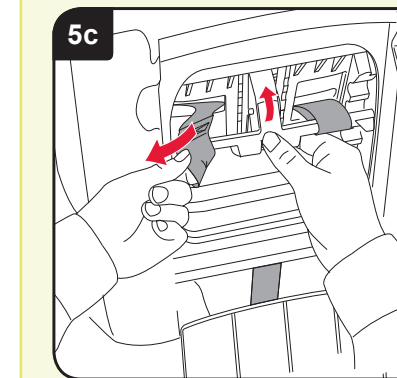

Remove the chest pad strap from the chest pad attachment arm. Pull the chest pad strap through the shoulder strap slots to the front of the seat (dia 5c).

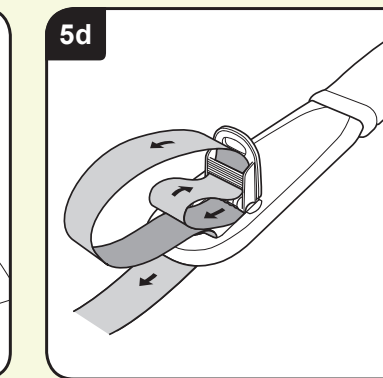

Feed the harness strap all the way out of the SAFESTRAP™ mechanism until it is released (dia 5d).

## 6. Refitting the SAFESTRAP™

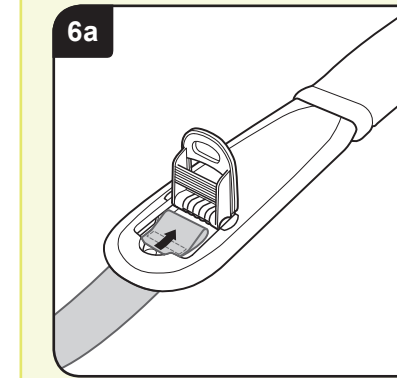

Making sure the harness strap is not twisted push the loop end of the harness strap up through the front of the SAFESTRAP™ mechanism and pull through (dia 6a).

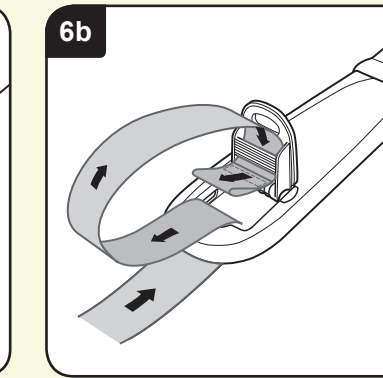

Ensure there is enough slack and thread the harness strap down over the bar of the SAFESTRAP™ mechanism and pull through (dia 6b).

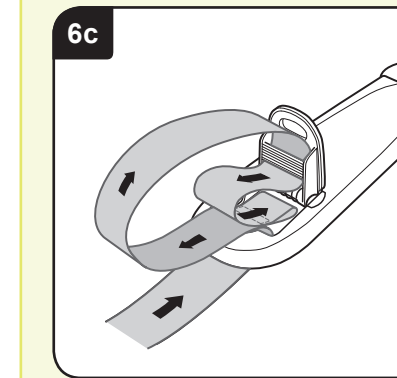

Feed the harness strap under the SAFESTRAP™ mechanism. Push through the harness strap until it appears out the top of the chest pad. Ensure the strap is not twisted (dia 6c).

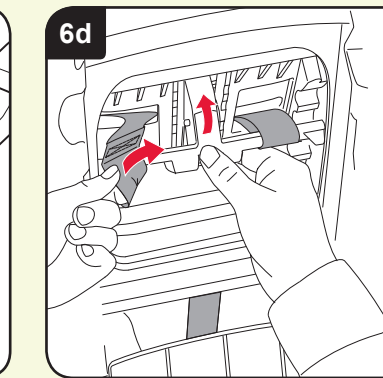

Push the chest pad strap through the shoulder strap slot towards the back of the seat. Attach the chest pad strap to the chest pad adjustment arm (dia 6d).

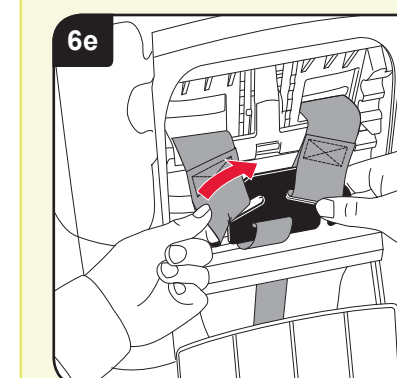

Push the harness strap through the shoulder strap slot towards the back of the seat. Attach the harness strap to the yoke. Ensure the harness strap and the chest pad strap are not twisted (dia 6e).

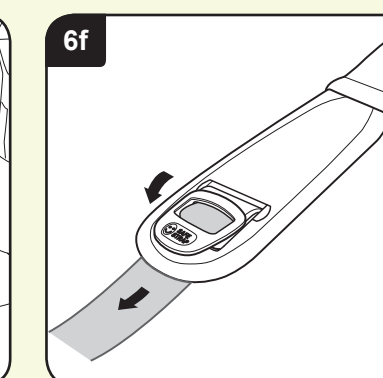

Pull through all the excess slack to close the indicator (dia 6f).



## Free Manuals Download Website

<http://myh66.com>

<http://usermanuals.us>

<http://www.somanuals.com>

<http://www.4manuals.cc>

<http://www.manual-lib.com>

<http://www.404manual.com>

<http://www.luxmanual.com>

<http://aubethermostatmanual.com>

Golf course search by state

<http://golfingnear.com>

Email search by domain

<http://emailbydomain.com>

Auto manuals search

<http://auto.somanuals.com>

TV manuals search

<http://tv.somanuals.com>