

# 15-inch Color LCD Flat Panel Display Monitor



Security Systems

EN | Instruction Manual  
MON150CL

# BOSCH

## Important Safeguards

1. **Read, Follow, and Retain Instructions** - All safety and operating instructions should be read and followed before operating the unit. Retain instructions for future reference.
2. **Heed Warnings** - Adhere to all warnings on the unit and in the operating instructions.
3. **Attachments** - Attachments not recommended by the product manufacturer should not be used, as they may cause hazards.
4. **Installation Cautions** - Do not place this unit on an unstable stand, tripod, bracket, or mount. The unit may fall, causing serious injury to a person and serious damage to the unit. Use only manufacturer-recommended accessories, or those sold with the product. Mount the unit per the manufacturer's instructions. Appliance and cart combination should be moved with care. Quick stops, excessive force, or uneven surfaces may cause the appliance and cart combination to overturn.
5. **Cleaning** - Unplug the unit from the outlet before cleaning. Follow any instructions provided with the unit. Generally, using a damp cloth for cleaning is sufficient. Do not use liquid cleaners or aerosol cleaners.
6. **Servicing** - Do not attempt to service this unit yourself. Opening or removing covers may expose you to dangerous voltage or other hazards. Refer all servicing to qualified service personnel.
7. **Damage Requiring Service** - Unplug the unit from the main AC power source and refer servicing to qualified service personnel under the following conditions:
  - When the power supply cord or plug is damaged.
  - If liquid has been spilled or an object has fallen into the unit.
  - If the unit has been exposed to water and/or inclement weather (rain, snow, etc.).
  - If the unit does not operate normally, when following the operating instructions. Adjust only those controls specified in the operating instructions. Improper adjustment of other controls may result in damage, and require extensive work by a qualified technician to restore the unit to normal operation.
  - If the unit has been dropped or the cabinet damaged.
  - If the unit exhibits a distinct change in performance, this indicates that service is needed.
8. **Replacement Parts** - When replacement parts are required, the service technician should use replacement parts specified by the manufacturer or that have the same characteristics as the original part. Unauthorized substitutions may result in fire, electrical shock or other hazards.
9. **Safety Check** - Upon completion of servicing or repairs to the unit, ask the service technician to perform safety checks to ensure proper operating condition.
10. **Power Sources** - Operate the unit only from the type of power source indicated on the label. If unsure of the type of power supply to use, contact your dealer or local power company.
  - For units intended to operate from battery power, refer to the operating instructions.
  - For units intended to operate **with External Power Supplies**, use only the recommended approved power supplies.
  - For units intended to operate with a limited power source, this power source must comply with EN60950. Substitutions may damage the unit or cause fire or shock.
  - For units intended to operate at 24VAC, normal input voltage is **24VAC**. Voltage applied to the unit's power input should not exceed 30VAC. User-supplied wiring, from the 24VAC supply to unit, must be in compliance with electrical codes (Class 2 power levels). Do not ground the 24VAC supply at the terminals or at the unit's power supply terminals.
11. **Coax Grounding** - If an outside cable system is connected to the unit, ensure that the cable system is grounded. U.S.A. models only - Section 810 of the National Electrical Code, ANSI/NFPA No.70, provides information regarding proper grounding of the mount and supporting structure, grounding of the coax to a discharge unit, size of grounding conductors, location of discharge unit, connection to grounding electrodes, and requirements for the grounding electrode.
12. **Grounding** - This unit may be equipped with a 3-wire grounding plug (a plug with a third pin, for grounding). This safety feature allows the plug to fit into a grounding power outlet only. If unable to insert the plug into the outlet, contact an electrician to arrange replacement of the obsolete outlet. Do not defeat the safety purpose of the grounding plug.
  - Outdoor equipment should only be connected to the unit's inputs after this unit has had its grounding plug connected to a grounded outlet or its ground terminal properly connected to a ground source.
  - The unit's input connectors must be disconnected from outdoor equipment before disconnecting the grounding plug or grounding terminal.
  - Proper safety precautions such as grounding should be followed for any outdoor device connected to this unit.
13. **Lightning** - For added protection during a lightning storm, or when this unit is left unattended and unused for long periods of time, unplug the unit from the wall outlet and disconnect the cable system. This will prevent damage to the unit due to lightning and power line surges.

### For Indoor Product

- Water and Moisture** - Do not use this unit near water - for example, in a wet basement, in an unprotected outdoor installation or in any area classified as a wet location.
- Object and Liquid Entry** - Never push objects of any kind into this unit through openings, as they might touch dangerous voltage points or create short circuits, resulting in a fire or electrical shock. Never spill liquid of any kind on the unit.
- Power Cord and Power Cord Protection** - For units intended to operate with 230VAC, 50Hz, the input and output power cord must comply with the latest versions of IEC Publication 227 or IEC Publication 245.  
Power supply cords should be routed so they are not likely to be walked on or pinched. Pay particular attention to location of cords and plugs, convenience receptacles, and the point of exit from the appliance.
- Overloading** - Do not overload outlets and extension cords; this can result in a risk of fire or electrical shock.

### For Outdoor Product

**Power Lines** - An outdoor system should not be located in the vicinity of overhead power lines, electric lights or power circuits, or where it may contact such power lines or circuits. When installing an outdoor system, extreme care should be taken to keep from touching power lines or circuits, as this contact might be fatal. U.S.A. models only - refer to the National Electrical Code Article 820 regarding installation of CATV systems.

### For Rack-mount Product

- Ventilation** - Do not place this equipment in a built-in installation or rack, unless proper ventilation is provided, or the manufacturer's instructions were followed. The equipment must not exceed its maximum operating temperature requirements.
- Mechanical Loading** - When rack-mounting the equipment, ensure that a hazardous condition is not created by uneven mechanical loading.

## Safety Precautions



### CAUTION

RISK OF ELECTRIC SHOCK. DO NOT OPEN!



**CAUTION: TO REDUCE THE RISK OF ELECTRIC SHOCK, DO NOT REMOVE COVER (OR BACK). NO USER SERVICEABLE PARTS INSIDE. REFER SERVICING TO QUALIFIED SERVICE PERSONNEL.**



This symbol indicates the presence of uninsulated "dangerous voltage" within the product's enclosure that can cause an electric shock.



This symbol indicates the presence of important operating and maintenance (servicing) instructions in the literature accompanying the appliance.



Installation should be performed by qualified service personnel only in accordance with the National Electrical Code or applicable local codes.



**Power Disconnect.** Units with or without ON-OFF switches have power supplied to the unit whenever the power cord is inserted into the power source; however, the unit is operational only when the ON-OFF switch is in the ON position. The power cord is the main power disconnect for all units.

### Cover Removal



**WARNING:** Removal of the cover should only be performed by qualified service personnel - not user serviceable. The unit should always be unplugged before removing the cover and remain unplugged while the cover is removed.

## FCC & ICES INFORMATION

### (U.S.A. and Canadian Models Only)

This device complies with part 15 of the FCC Rules. Operation is subject to the following two conditions:

- (1) This device may not cause harmful interference, and
- (2) This device must accept any interference received, including interference that may cause undesired operation.

**NOTE:** This equipment has been tested and found to comply with the limits for a Class B digital device, pursuant to Part 15 of the FCC Rules and ICES-003 of Industry Canada. These limits are designed to provide reasonable protection against harmful interference when the equipment is operated in a residential installation. This equipment generates, uses and can radiate radio frequency energy, and if not installed and used in accordance with the instructions, may cause harmful interference to radio communications. However, there is no guarantee that interference will not occur in a particular installation. If this equipment does cause harmful interference to radio or television reception, which can be determined by turning the equipment off and on, the user is encouraged to try to correct the interference by one or more of the following measures:

- Reorient or relocate the receiving antenna.
- Increase the separation between the equipment and receiver.
- Connect the equipment into an outlet on a circuit different from that to which the receiver is connected.
- Consult the dealer, or an experienced radio/TV technician for help.

Intentional or unintentional changes or modifications, not expressly approved by the party responsible for compliance, shall not be made. Any such changes or modifications could void the user's authority to operate the equipment. The user may find the following booklet, prepared by the Federal Communications Commission, helpful: [How to Identify and Resolve Radio-TV Interference Problems](#). This booklet is available from the U.S. Government Printing Office, Washington, DC 20402, Stock No. 004-000-00345-4.

## Table of Contents

Important Safeguards .....	2
FCC Information .....	4
Front and Back Panel Diagrams .....	6
1.0 UNPACKING .....	7
1.1 Parts List .....	7
2.0 SERVICE .....	7
3.0 GENERAL FEATURES .....	7
3.1 Features .....	7
4.0 INTRODUCTION .....	7
4.1 Monitors .....	7
5.0 INSTALLATION .....	7
5.1 Power .....	7
5.2 Desktop Installation .....	8
5.3 Connecting the Composite Video Signal to the Monitor .....	8
5.4 Connecting the Y/C (S-video) Signal to the Monitor .....	8
5.5 Connecting Audio to the Monitor .....	8
5.6 Connecting the Analog VGA Signal to the Monitor .....	9
5.7 Ventilation .....	9
6.0 OPERATION .....	9
6.1 Front Panel Controls .....	9
6.2 On-screen Display (OSD) Menu .....	9
7.0 ON-SCREEN DISPLAY MENU CONFIGURATION .....	11
7.1 CVBS Mode .....	11
7.2 VGA Mode .....	12

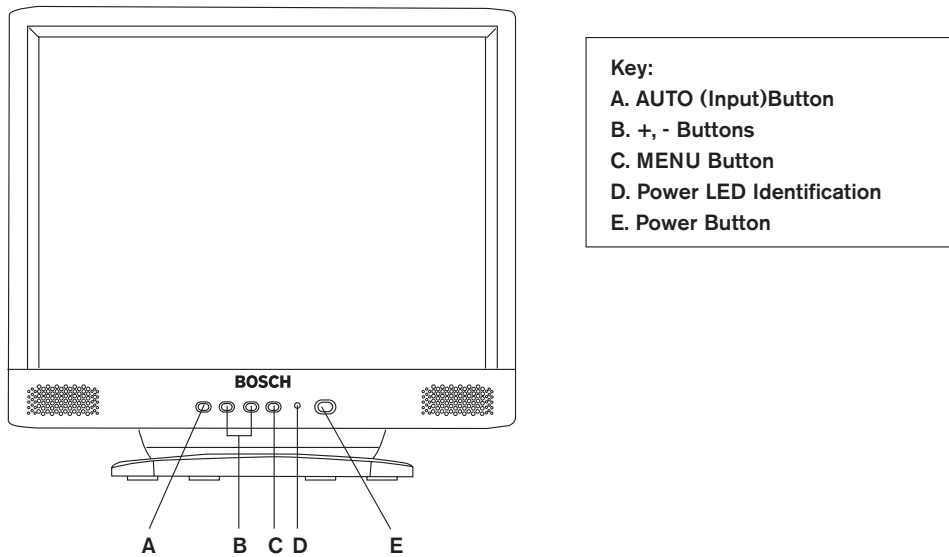
**MON150CL**

Figure 1: Front Panel

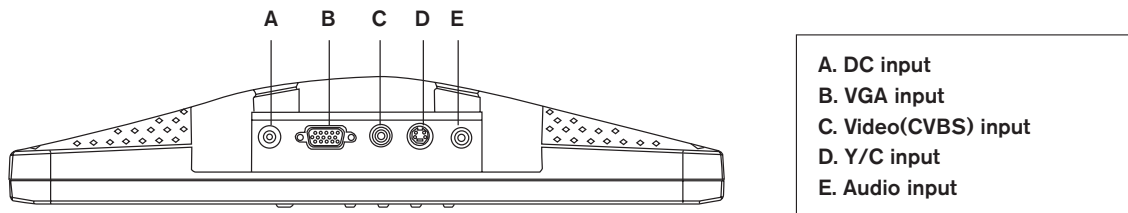


Figure 2: I/O Connectors

## 1.0 UNPACKING

This equipment should be unpacked and handled with care. If an item appears to have been damaged in shipment, notify the shipper.

Verify that all parts shown in the *Parts List* have been included. If any items are missing, notify your Bosch Security Systems Sales or Customer Service Representative.

The original packing carton is the safest container in which to transport the unit. Save it for possible future use.

### 1.1 Parts List

Qty	Item
1	Unit (verify model number)
1	MON150CL Color LCD Flat Panel Monitor
2	Power Cords: 3-wire with grounded plug, 1.8 m (6 ft) long; One (1) with European Continental plug type and one (1) with U.S plug type
1	MON150PS power supply
1	One (1) analog VGA cable, 1.5 m (5 ft)
1	One (1) audio cable
1	RCA to BNC connector
1	This installation manual

## 2.0 SERVICE

If the unit needs servicing, contact the nearest Bosch Security Systems Service Center for authorization to return and shipping instructions.

### Service Centers

#### USA

Phone: 800-366-2283 or 717-735-6638

Fax: 800-366-1329 or 717-735-6639

#### CCTV Spare Parts

Phone: 800-894-5215 or 408-956-3853 or 3854

Fax: 408-957-3198

E-mail: [BoschCCTVparts@ca.slr.com](mailto:BoschCCTVparts@ca.slr.com)

#### Canada

Phone: 514-738-2434

#### Europe, Middle East & Asia Pacific Region

Phone: 32-1-440-0711

For additional information, see [www.boschsecurity.com](http://www.boschsecurity.com).

## 3.0 GENERAL FEATURES

This high-performance, 15-inch TFT LCD monitor with a 1024 X 768 XGA resolution has been designed to display both PC and Video images. It complies with the power management regulations of VESA DPMS, it is supported by Plug & Play, and complies with DDC1/2B.

### 3.1 Features

- 100 to 240 VAC Power Supply
- NTSC/PAL Auto - Detect
- High Resolution (1024 X 768 XGA)
- PC Input
- Video Input
- Audio Input
- Y/C Input
- OSD with Multiple Languages

## 4.0 INTRODUCTION

### 4.1 Monitors

The MON150CL 15-inch (38 cm) Color Liquid Crystal Display Monitor displays PAL or NTSC standard color pictures in CCTV systems. The MON150CL monitor includes one (1) Composite Video input RCA connector (one RCA to BNC connector is included), one (1) Audio input mini phone jack, and one (1) Y/C (S-video) input using 4-pin mini-DIN. In addition, this model includes an Analog VGA input using 15-pin D-sub to accommodate the increasing use of Personal Computers and digital video devices in security applications. Monitor control functions are accessed via the front panel push buttons and the multi-language On-Screen Display (OSD).

## 5.0 INSTALLATION

### 5.1 Power

Model No.	Rated Voltage	Voltage Range	Power at Rated Voltage	Sync Format
MON150CL	120/230 VAC	100 to 240 V	26 W	NTSC/PAL



## 5.2 Desktop Installation

The MON150CL monitor is delivered with a 3-pole US-style power cord and a 3-pole Euro-style power cord. Use the US-style power cord where 120 VAC, 60 Hz power is available; and use the Euro-style power cord where 230 VAC, 50 Hz power is available. Connect the bayonet connector from the power supply to the power input connector on the rear side of the LCD panel, as shown in *Photo A*. The monitor automatically adjusts to either power input voltage.



Photo A

## 5.3 Connecting the Composite Video Signal to the Monitor

There is one (1) RCA connector located on the rear of the monitor for composite video input (please see *Figure 2* on *Page 6*). Also included is one (1) RCA to BNC adapter used to connect a BNC cable line as shown in *Photo B* and *Photo C*.



Photo B



Photo C

## 5.4 Connecting the Y/C (S-video) Signal to the Monitor

There is one (1) mini-DIN type connector for the S-video (Y/C) input (please see *Figure 2* on *Page 6* and *Figure 3* below).

**NOTE:** Both Y and C inputs are terminated with 75Ω.

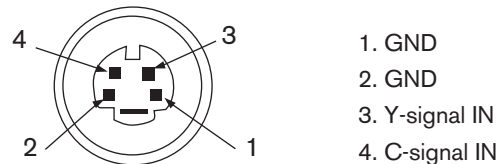


Figure 3: Y/C Connection Pinout

## 5.5 Connecting Audio to the Monitor

There is one (1) set of mini phone jacks for the audio connector (please see *Figure 2* on *Page 6* and *Photo D* below).



Photo D



## 5.6 Connecting the Analog VGA Signal to the Monitor

There is one (1) 15-pin D-sub connector (Figure 4) for one analog VGA input. Refer to Figure 2, item B.

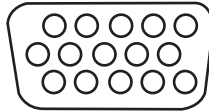


Figure 4: Analog VGA Connector

## 5.7 Ventilation

To prevent overheating, ensure that the ventilation openings on the rear of the monitor are not covered.

## 6.0 OPERATION

### 6.1 Front Panel Controls (Figure 1)

- AUTO (Input)** Press this button to display the input signal which is selected on the screen
- +/-** Press the '+' or '-' button to move the cursor to the targeted parameter in the OSD main menu. Press the '+' or '-' button to adjust the value of the selected parameter in the OSD sub-menu.
- MENU** Press this button to open the main OSD menu. Use this button to confirm a value for a parameter in the OSD Menu.
- Power LED Identification** Power on (Green)  
Stand by (Amber)
- POWER** Press this button to turn on or turn off the monitor

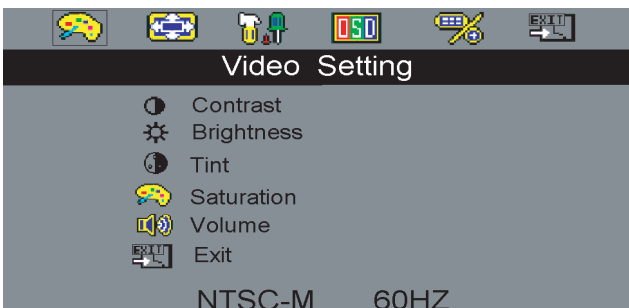
### 6.2 On-screen Display (OSD) Menu

#### 6.2.1 Video Setting (CVBS/S-VIDEO)



#### Saturation

- Press **Menu** to open the OSD Main menu
- Press the '+' or '-' button to highlight an option, then press **Menu** to modify the value of the option



#### Contrast

Adjusts the contrast value (0-100)



#### Brightness

Adjusts the brightness value (0-100)



#### Tint

Adjusts the tint value (NTSC only) (0-100)



#### Saturation

Adjusts the color value (0-100)



#### Volume

Adjusts the volume (0-31)



#### Exit

Exits the OSD menu

#### 6.2.2 Colour Setting (RGB / VGA)



#### Colour Setting

- Press **Menu** to open the OSD Main menu
- Press the '+' or '-' button to highlight an option, then press **Menu** to modify the value of the option



#### Contrast

Adjusts the contrast value (0-100)



#### Brightness

Adjusts the brightness value (0-100)



#### Gamma Correct

Opens an optimum Gamma curve (0/1/2/3)



#### Colour Adjust

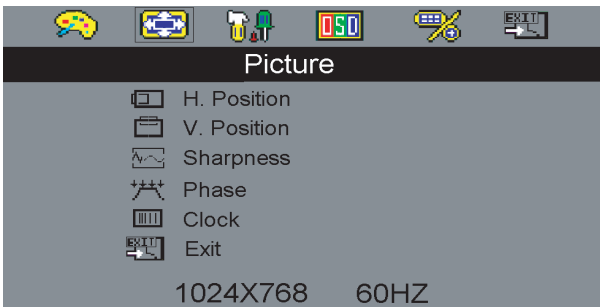
Opens the **color** menu. Select a color then press **Menu** to adjust the value of the selected color.





#### Exit


Exits the Colour OSD menu setting


6.2.3  Picture Setting (RGB / VGA)




 **H Position** Adjusts the horizontal position (0-100)


 **V Position** Adjusts the vertical position (0-100)

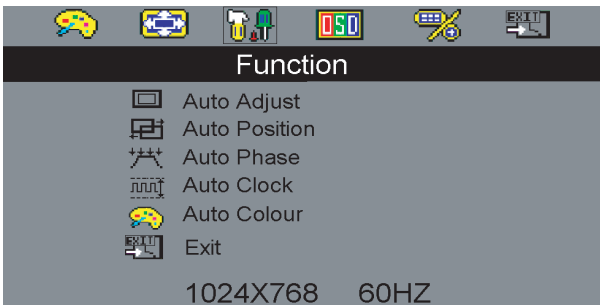
 **Sharpness** Adjusts the sharpness value (1/2/3/4/5)


 **Phase** Adjusts the phase value (0-31)

 **Clock** Adjusts the clock frequency (0-200)

 **Exit** Exits the Picture OSD Menu setting


6.2.4  Auto Function Setting (RGB / VGA)




 **Auto Adjust** Automatically adjusts the H/V position, phase, and clock

 **Auto Position** Automatically adjusts the H/V position

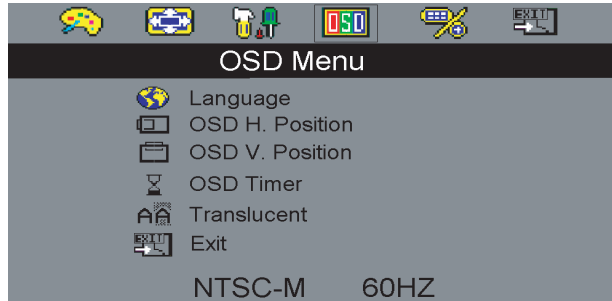
 **Auto Phase** Automatically adjusts the phase


 **Auto Clock** Automatically adjusts the clock frequency


 **Auto Colour** Automatically adjusts the color temperature


 **Exit** Exits the Function OSD Menu setting


6.2.5  OSD Menu (CVBS/S-VIDEO / RGB / VGA)





 **Language** Opens the Language Selection Menu. Select one of the following: English, Deutsch, Francais, Italiano, Espanol, Simple Chinese, Traditional Chinese, Japanese

 **OSD H. Position** Adjusts the OSD horizontal position (0-100)

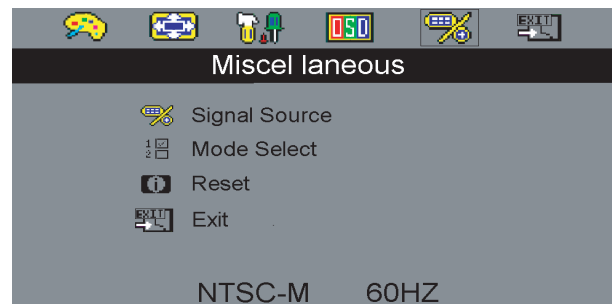
 **OSD V. Position** Adjusts the OSD vertical position (0-100)


 **OSD Time** Adjusts the OSD window display time (0-30)


 **Translucent** Toggles the OSD window background setting


 **Exit** Exits the OSD menu setting

6.2.6  Miscellaneous (CVBS/S-VIDEO / RGB / VGA)



 **Signal Source** Prompts you to select an input source

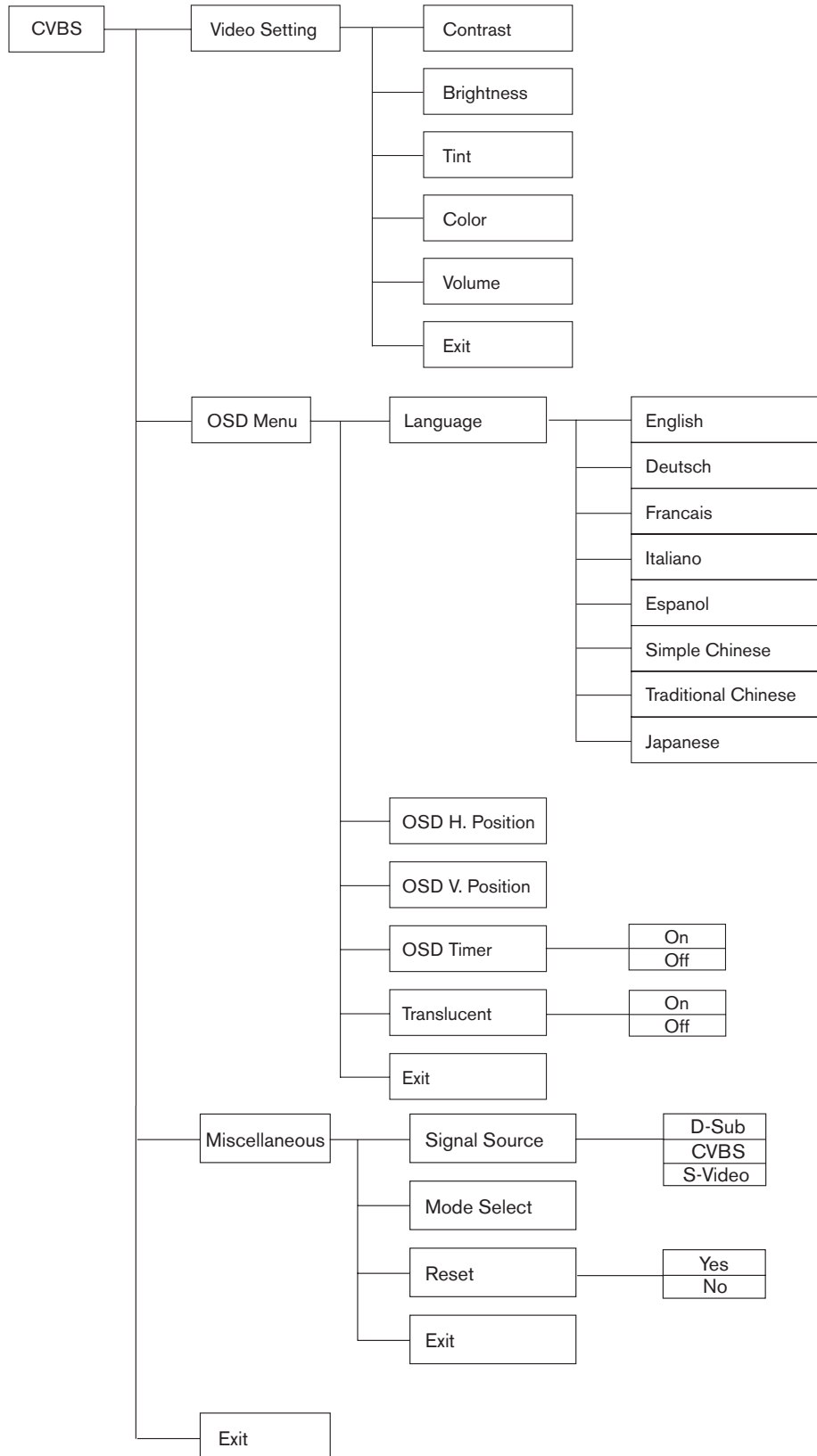
 **Mode Select** Prompts you to select one of these modes: 640 X 400 or 720 X 400

 **Reset** Returns the monitor setting to the factory default

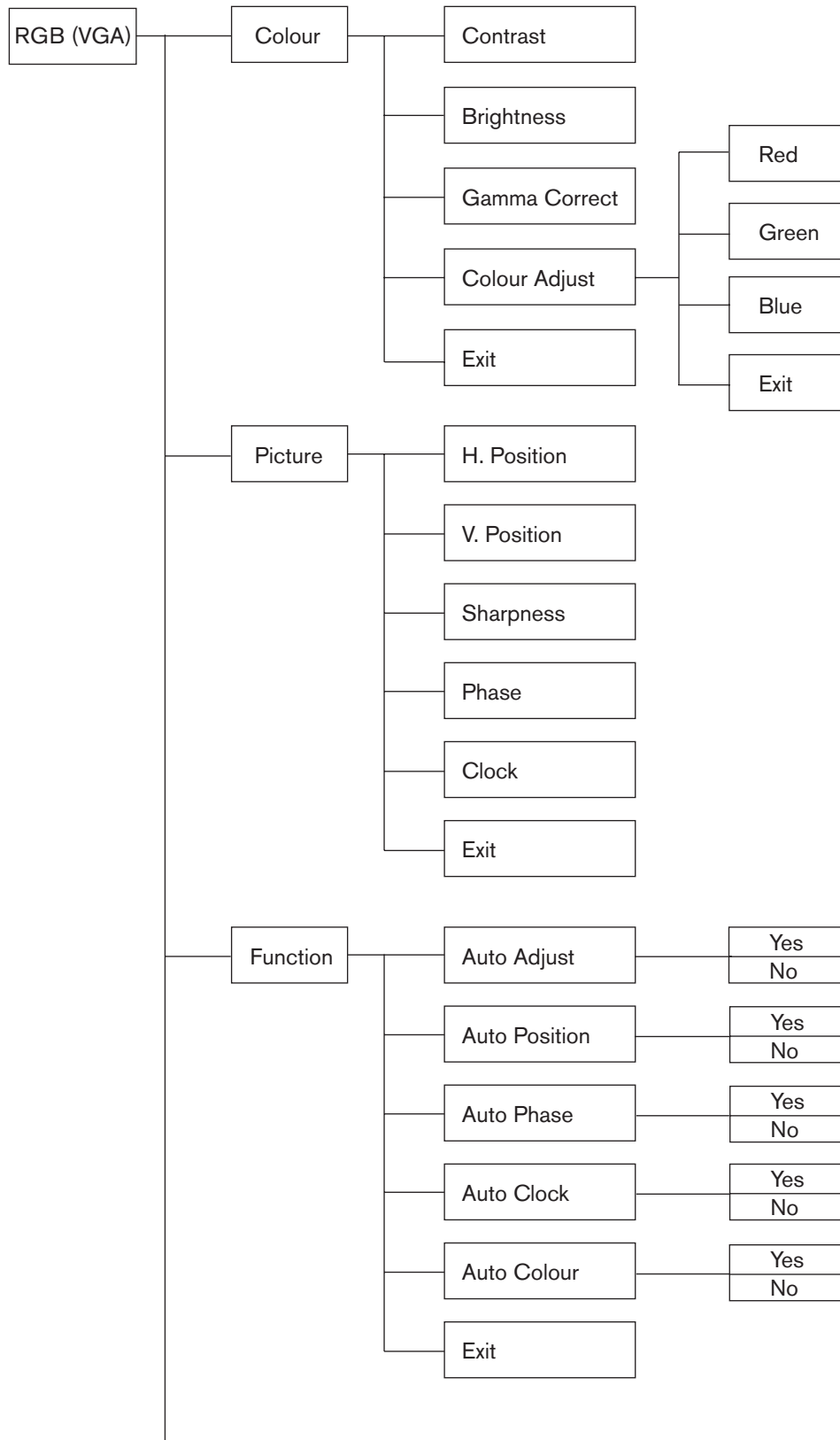
 **Exit** Exits the Miscellaneous menu setting

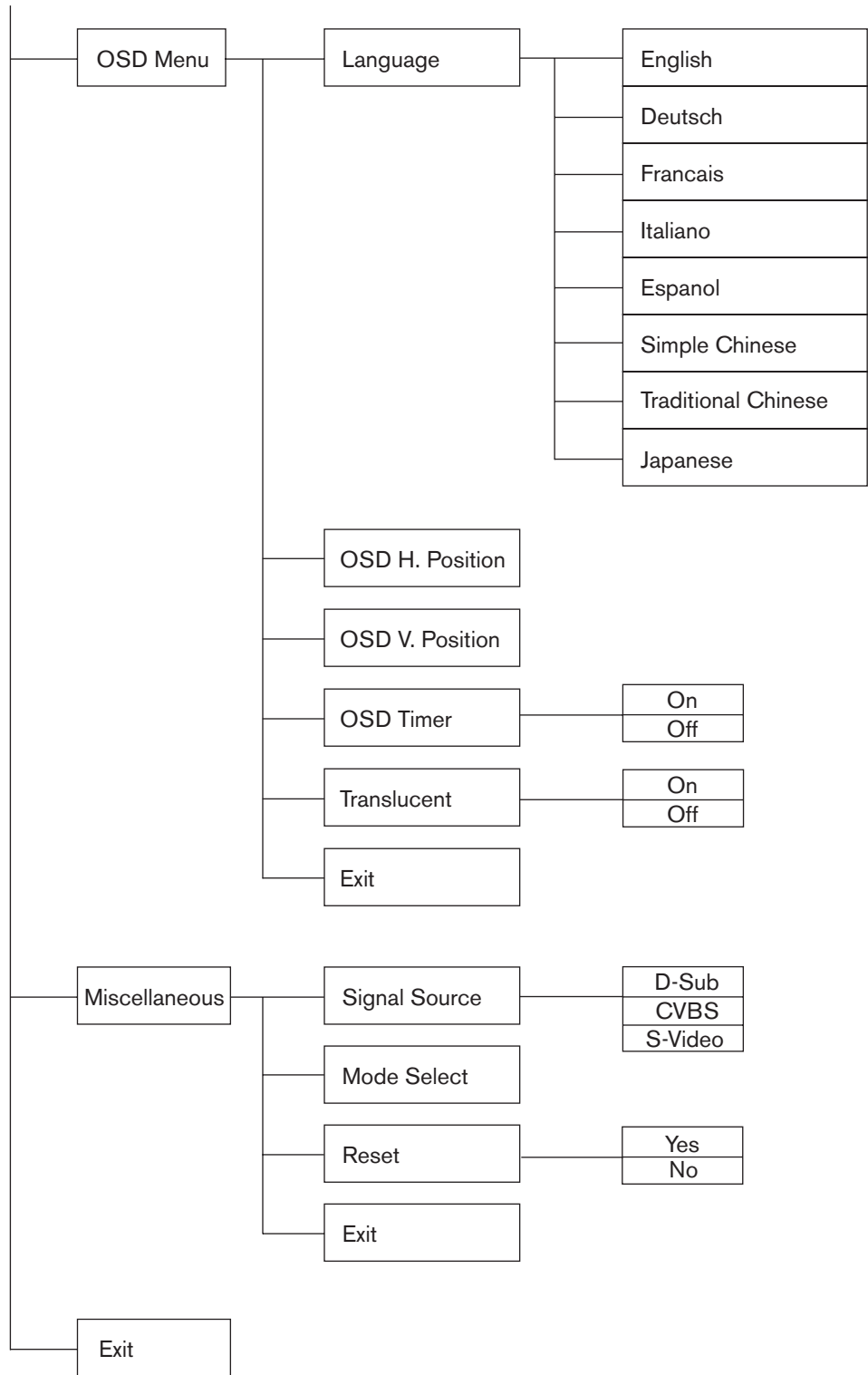
## 7.0 ON-SCREEN DISPLAY MENU CONFIGURATION

### 7.1 CVBS Mode



## 7.2 VGA Mode





7.2.1 Supported Resolutions

VGA Timing Modes	
640 x 480	60/72/75 Hz
800 x 600	60/72/75 Hz
1024 x 768	50/60/70/75 Hz

**Error Message:** Signal Out of Range

This message appears in VGA mode if the PC is operating with a resolution or timing mode that is not supported by the MON150CL. Please change the PC settings to one of the supported VGA Timing Mode combinations listed.







#### **Americas**

Bosch Security Systems  
130 Perinton Parkway  
Fairport, New York, 14450, USA  
Phone: +1 (585) 223 4060  
+1 800 289 0096  
security.sales@us.bosch.com  
<http://www.boschsecurity.us>

#### **Europe, Middle East, Africa**

Bosch Security Systems B.V.  
P.O. Box 80002  
5600 JB Eindhoven, The Netherlands  
Phone: +31 (0) 40 27 83955  
Fax: +31 (0) 40 27 86668  
emea.securitysystems@bosch.com  
<http://www.boschsecurity.com>

#### **Asia-Pacific**

Bosch Security Systems Pte Ltd  
38C Jalan Pemimpin  
Singapore 577180  
Phone: +65 6319 3450  
Fax: +65 6319 3499  
apr.securitysystems@bosch.com  
<http://www.boschsecurity.com>

© 2005 Bosch Security Systems GmbH

F01U009193\_01 05-20 | Updated May 20, 2005 | Data subject to change without notice.

# **BOSCH**

## Free Manuals Download Website

<http://myh66.com>

<http://usermanuals.us>

<http://www.somanuals.com>

<http://www.4manuals.cc>

<http://www.manual-lib.com>

<http://www.404manual.com>

<http://www.luxmanual.com>

<http://aubethermostatmanual.com>

Golf course search by state

<http://golfingnear.com>

Email search by domain

<http://emailbydomain.com>

Auto manuals search

<http://auto.somanuals.com>

TV manuals search

<http://tv.somanuals.com>