

# BOSCH

YOUR LIFE. OUR INSPIRATION.

## **DISHWASHER USE AND CARE MANUAL**

MODEL: SHE66C, SHX56C, SHV56C, SHX57C, SHV57C, SHY56A, SHE58C, SHX55M, SHE68M, SHX68M, SHV68M

## **GUIDE D'ENTRETIEN ET D'UTILISATION DU LAVE-VAISSELLE**

MODÈLE: SHE66C, SHX56C, SHV56C, SHX57C, SHV57C, SHY56A, SHE58C, SHX55M, SHE68M, SHX68M, SHV68M

## **MANUAL DE USO Y CUIDADO PARA LAVADORA DE PLATOS**

MODELOS: SHE66C, SHX56C, SHV56C, SHX57C, SHV57C, SHY56A, SHE58C, SHX55M, SHE68M, SHX68M, SHV68M



Congratulations, and Thank You from Bosch!

Thank you for selecting a Bosch dishwasher. You have joined the many consumers who demand quiet and superior performance from their dishwashers.

This manual was written with your safety and convenience in mind, and the information contained herein is very important. We highly recommend that you read this manual before you use your dishwasher for the first time.

To learn even more about your dishwasher and available accessories, as well as many other top-quality Bosch appliances, visit our website at [www.boschappliances.com](http://www.boschappliances.com).

Please contact us if you have any questions or comments. Call **1-800-944-2904**, or write to:

BSH Home Appliances, Corp.  
5551 McFadden Avenue  
Huntington Beach, CA 92649

Enjoy!

<b>IMPORTANT SAFETY INSTRUCTIONS</b> .....	4-5
Dishwasher Components.....	5
Dishwasher Features and Options.....	6
Dishware Materials.....	7
Preparing and Loading the Dishware .....	7-9
Dishware Preparation .....	7
Loading the Dishwasher .....	7-9
Adding Detergent and Rinse Agent .....	10-11
Operating the Dishwasher .....	11-13
Dishware Drying .....	13
Unloading the Dishwasher .....	13
Care and Maintenance .....	14-15
Wash Cycle Information/Sanitized.....	16
Self Help .....	17
Statement of Warranties.....	18
Customer Service .....	19

## Important Safety Instructions - Save This Information

### **WARNING**

Misuse of the dishwasher can result in serious injury or death. Do not use the dishwasher in any way not covered in this manual or for any purpose other than those explained on the following pages.

### **WARNING**

Severe product damage and/or injury could result from the use of unqualified service technicians or non-original replacement parts. All repairs must be performed by a qualified service technician using only original equipment factory replacement parts.

### **WARNING**

Electrical shock or fire could result if the electrical supply for the dishwasher covered in this manual is incorrectly installed or if the dishwasher has been improperly grounded. Do not use the dishwasher covered in this manual if you are not certain the electrical supply has been correctly installed or the dishwasher has been properly grounded.

### **ATTENTION**

Never use steam cleaning products to clean your dishwasher. The manufacturer will not be liable for possible damages or consequences.

### **ATTENTION**

Never use harsh chemicals to clean your dishwasher. Some chloride-containing cleaning products can damage your dishwasher and may present health hazards!

### **ATTENTION**

It is highly recommended for the end use consumer to become familiar with the procedure to shut off the incoming water supply and the procedure to shut off the incoming power supply. See the Installation Instructions or speak with your installer for more information.

## ⚠ Important Safety Instructions - Save This Information ⚠

- This appliance must be grounded to a metal, permanent wiring system, or an equipment grounding conductor must be run with the circuit conductors and connected to the equipment grounding terminal or lead on the dishwasher. See the **Installation Instructions** included with this dishwasher for more information on electrical requirements.
- Use this dishwasher only for its intended function, which is the washing of household dishware and kitchenware.
- This dishwasher is provided with **Installation Instructions** and this **Use and Care Manual**. Read and understand all instructions before using the dishwasher.
- Use only detergents or rinsing agents recommended for use in a dishwasher, and keep them out of the reach of children.
- When loading items to be washed:
  - Locate sharp items so that they are not likely to damage the door seal.
  - Load knives and other sharp utensils with their HANDLES UP to reduce the risk of cut-type injuries.
- Do not wash plastic items unless they are marked "dishwasher safe" or the equivalent. For plastic items not so marked, check the manufacturer's recommendations.
- Do not operate your dishwasher unless all enclosure panels are in place.
- Do not tamper with or override controls and interlocks.
- Do not abuse, sit on, or stand on the door or dish racks of the dishwasher.
- To reduce the risk of injury, do not allow children to play in or on the dishwasher.
- When children become old enough to operate the appliance, it is the legal responsibility of the parents or legal guardians to ensure that they are instructed in safe practices by qualified persons.
- Under certain conditions, hydrogen gas may be produced in a hot water system that has not been used for two weeks or more. Hydrogen gas is explosive. Before using a dishwasher that is connected to a hot water system that has been unused for two weeks or longer, turn on all hot water faucets and let the water flow from each for several minutes. This will release any accumulated hydrogen gas. As the gas is explosive, do not smoke or use an open flame during this time.
- Remove the door to the washing compartment when removing an old dishwasher from service or discarding.
- To avoid floor damage and possible mold growth, do not allow wet areas to remain around or under the dishwasher.
- Protect your dishwasher from the elements. Protect against freezing to avoid possible damage to the fill valve. Damage caused by freezing is not covered by the warranty.

## Dishwasher Components

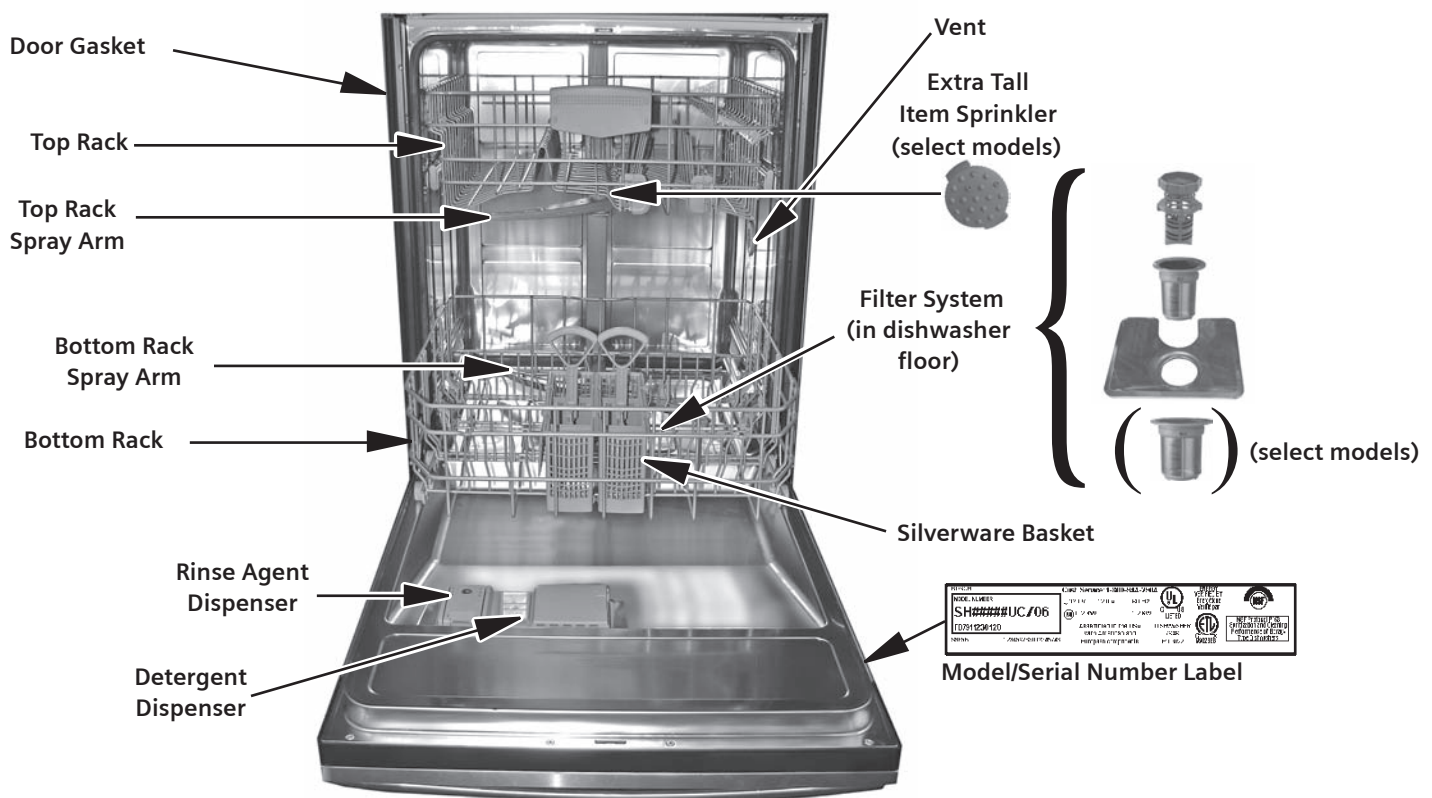

# Dishwasher Features and Options

**Noise Reduction System:** A two-pump motor system, the Suspension Motor™, and triple insulation make this dishwasher one of the quietest in North America.

**Stainless Steel TALLTUB™:** A rust-free, hygienic interior surface with a lifetime warranty.

**Nylon Coated Racks:** Eliminate cuts and nicks, and have a five-year warranty.

**Flow-Through Heater™:** Heats water to a temperature of up to 161°F.

**Condensation Drying:** A high temperature final rinse, a low temperature stainless steel tub, and the sheeting action of a rinse agent result in drying that is hygienic, energy efficient, and economical.























**SENSOTRONIC™ Water Condition Monitor:** Checks water condition and decides whether a second fresh water fill is necessary.

**Filter System:** Three filters ensure distribution of clean water and protect the main pump and the drain pump from foreign material.

**Water Shut-Off:** A safety feature that stops the flow of incoming water, if water is detected in the base of the dishwasher.

**Fully Integrated Unit (select models):** A fully integrated unit that requires a custom front door.

**ECO function (select models):** This option saves energy by reducing the water temperature.

Model Number	SHE66C	SHX56C	SHV56C	SHX57C	SHV57C	SHY56A	SHE58C	SHX55M	SHX68M	SHE68M	SHV68M
Control Panel Design	Hidden Top Control	Hidden Top Control	Hidden Top Control	Hidden Top Control	Hidden Top Control	Hidden Top Control	Hidden Top Control	Hidden Top Control	Hidden Top Control	Hidden Top Control	Hidden Top Control
Audible Cycle Completion Signal	yes	yes	yes	yes	yes	yes	yes	yes	yes	yes	yes
Clean Light	no	no	no	no	no	yes	no	no	no	no	no
Countdown Display	yes	yes	yes	yes	yes	yes	yes	yes	yes	yes	yes
Refill Rinse Agent Indicator Light	Shown on Display as 	Shown on Display as 	Shown on Display as 	Shown on Display as 	Shown on Display as 	Shown on Display as 	Shown on Display as 	Shown on Display as 	Shown on Display as 	Shown on Display as 	Shown on Display as 
Sanitized Indicator Light	Shown on Display as 	Shown on Display as 	Shown on Display as 	Shown on Display as 	Shown on Display as 	Shown on Display as 	Shown on Display as 	Shown on Display as 	Shown on Display as 	Shown on Display as 	Shown on Display as 
Delay Start	yes	yes	yes	yes	yes	yes	yes	yes	yes	yes	yes
Child Safety Latch	yes	no	no	no	no	no	yes	no	no	yes	no
Upper Rack Flip Tines	yes	yes	yes	yes	yes	yes	yes	yes	yes	yes	yes
Lower Rack Flip Tines	no	yes	yes	yes	no	yes	yes	yes	yes	yes	yes
Silverware Basket	Premium Flexible	Premium Flexible	Premium Flexible	Premium Flexible	Premium Flexible	Premium Flexible	Premium Flexible	Premium Flexible	Premium Flexible	Premium Flexible	Premium Flexible
Top Rack Only or Half Load	yes	yes	yes	yes	yes	no	yes	yes	yes	yes	yes
Extra Dry Heat	yes	yes	yes	yes	yes	yes	yes	yes	yes	yes	yes
OPTIDRY™	yes	yes	yes	yes	yes	yes	yes	yes	yes	yes	yes
INFOLIGHT™ Status Indicator	no	no	no	yes	yes	no	no	yes	yes	no	yes
Flow Through Water Heater	yes	yes	yes	yes	yes	yes	yes	yes	yes	yes	yes
ECO	yes	yes	yes	yes	no	no	no	yes	no	yes	no



# Dishware Materials

**NOTE:** Before using your dishwasher for the first time, check the information in this section. Some items are not dishwasher safe and should be hand-washed; others require special loading. Contact the item's manufacturer if you are unsure about the item's dishwasher suitability.

## Recommended

**Aluminum:** Colored anodized aluminum may fade over time. Minerals in your water may cause the aluminum to darken or spot. This can usually be removed by using a soap-filled steel wool pad.

**China, Crystal, Stoneware:** Some hand-painted pieces may discolor, fade, or spot. Hand-wash these pieces. Position fragile glassware so that it will not topple over or contact other pieces during the wash cycle.

**Glass:** Milk glass may yellow.

**Non-Stick Coatings:** Apply a light coating of vegetable oil to non-stick surfaces after drying.

**Plastics:** Make sure the piece is dishwasher safe.

**Stainless Steel, Sterling Silver, and Silver Plate:** Place these pieces so that they do not contact dissimilar metals.

## Not Recommended

**Acrylic:** crazing (small cracks throughout the acrylic) may occur.

**Adhesive-Joined Pieces:** Adhesives that join materials such as plastic, wood, bone, steel copper, tin, etc. may loosen.

**Bone-Handled Utensils:** Handles may separate.

**Iron:** Iron will rust. Hand-wash and dry immediately.

**Non-Dishware Items:** Your dishwasher is intended for use in cleaning ONLY standard household dishware and kitchenware.

**Pewter, Brass, Bronze:** Pewter will tarnish. Hand-wash and dry immediately.

**Tin:** Tin will rust. Hand-wash and dry immediately.

**Wood:** Wooden bowls, wooden utensils, and wood-handled utensils can crack, warp, and lose their finish.

# Preparing and Loading the Dishware

## Dishware Preparation

Do not pre-wash items having loosely-attached soiling. Remove large food particles, bones, seeds, toothpicks, and excessive grease. Items having burned-on, baked-on or starchy soils may require pre-treatment.

## Loading the Dishwasher

Check the Materials section of this manual if you are unsure about an item's dishwasher suitability.

Load only dishwasher-safe items into the dishwasher. Load dishes in the dishwasher racks so that the insides of bowls, pots, and pans are facing the spray arms. Avoid nesting and contact points between dishes. Separate items of dissimilar metals.

## Loading the Top Rack

Figures 1 and 2 show typical 10 and 12 place load patterns for the top rack.

**NOTE:** Make sure items do not protrude through the bottom of the racks and block the spray arms.

## ATTENTION

To avoid dishwasher damage, do not load the dishwasher with objects such as paper products, plastic bags, packing materials, or anything other than normal dishware and kitchenware. Do not load the dishwasher with anything other than dishwasher-safe dishware and kitchenware.

Figure 1  
10 place setting top rack

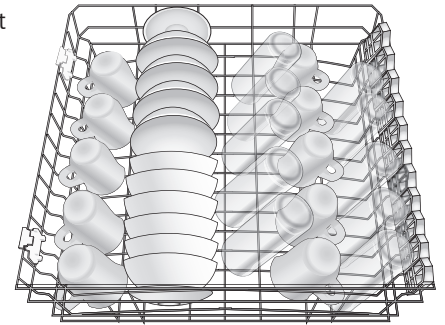

Figure 2  
12 place setting top rack

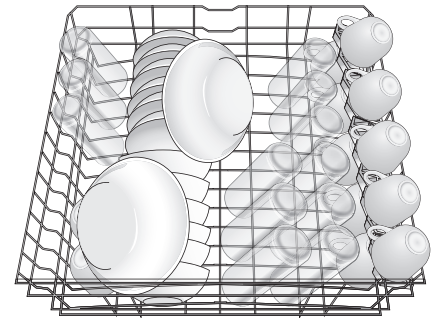

Figure 3

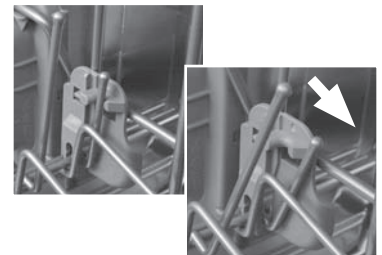

Figure 4

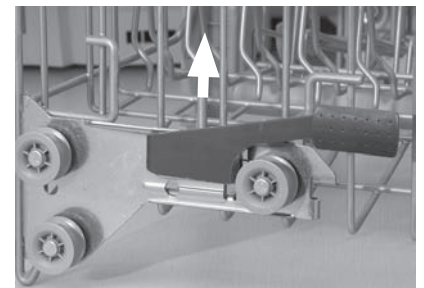

Figure 5

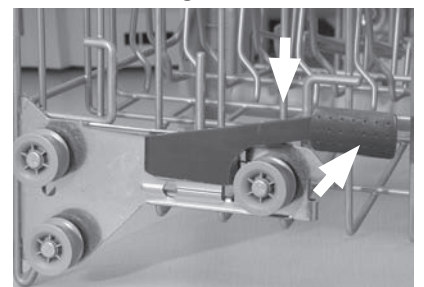

Figure 6

10 place setting bottom rack

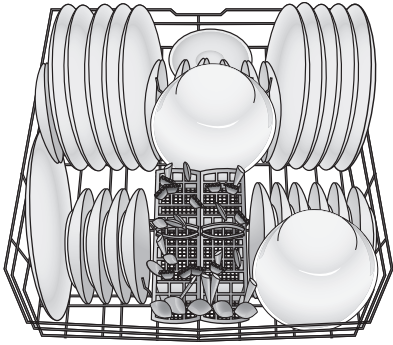

Figure 7

12 place setting bottom rack

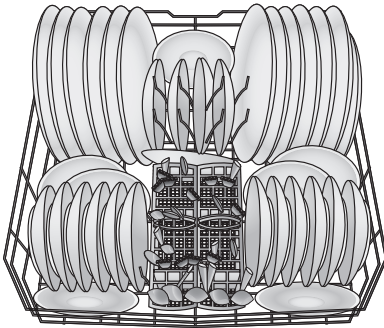

Figure 8



Figure 9

Do not block vent.



## Top Rack Accessories

### Top Rack Flip Tines

Flip Tines fold down to make loading the racks easier in some instances. Grasp the tines, release from notch, and fold the tines downward. When the top rack is loaded, push it into the dishwasher.

**NOTE:** When pushing the top rack into the dishwasher, push it until it stops against the back of the tub so the top rack spray arm will connect to the water supply. Do not push the top rack with the door.

### Top Rack Height Adjustment

The top rack can be lowered to accommodate large items in the top rack, and raised to make room for large items in the bottom rack.

To raise the top rack:

1. Pull the top rack out of the dishwasher until it stops rolling.
2. Grasp the top of the rack above the Automatic Height-Adjustable Top Rack handles and pull it upward as shown in Figure 4 until the Automatic Height-Adjustable Top Rack handles lock the rack into position (you do not need to press the Automatic Height-Adjustable Top Rack handles in order to raise the rack).

**NOTE:** Before you push the top rack back into the dishwasher, ensure that the rack height is the same on both sides. Otherwise, the dishwasher door will not shut and the top rack spray arm will not connect to the water circuit.

To lower the top rack:

1. Pull the top rack out of the dishwasher until it stops rolling.
2. Press the Automatic Height-Adjustable Top Rack handles inward as shown in Figure 5 and let the rack drop.

### Loading the Bottom Rack

Place large items in the bottom rack. Load pots, pans and bowls upside-down. Figures 6 and 7 show typical mixed loads for the bottom rack.

### Loading Extra Tall Items

If an item is too tall to be placed into the bottom rack even with the top rack in the raised position, remove the empty top rack by pulling it out of the dishwasher until it stops rolling. Pull the front of the rack upward and outward until the rollers are completely free of the roller guides. Set the top rack aside. Push the roller guides back into the dishwasher. Insert the Extra Tall Item Sprinkler into the top rack spray outlet and turn the sprinkler clockwise to lock it into position as shown in Figure 8. Place your extra tall item(s) in the bottom rack as shown in Figure 9.

**NOTE:** Keep the vent on the tub's right side clear by placing tall items such as plastic cutting boards and tall baking sheets on the bottom rack's left side, center, or back.

## ATTENTION

To avoid dishwasher damage, do not reinstall the top rack without removing the extra tall item sprinkler. Do not reinstall the top rack with the sprinkler installed.

To remove the sprinkler and return the dishwasher to its normal condition:

1. Turn the sprinkler counterclockwise and remove it.
2. Retrieve the top rack.
3. Tilt the top rack upwards and position the top rack rollers onto the roller guides.
4. Continue pushing the top rack until the rollers are on the guide.
5. Push the top rack into the dishwasher.

### Loading the Silverware Basket

**NOTE:** The silverware basket tops can be folded up to accommodate large or oddly-shaped items.

With the silverware basket tops down, load the silverware basket following the patterns suggested in Figures 10 and 11). Place knives with their handles up, and forks and spoons with their handles down.

If large or oddly-shaped items are to be loaded into the silverware basket with the tops up, load the items so that they do not nest together. Load knives and sharp utensils with their handles up.

## ⚠ CAUTION

The sharp points and edges of knives and other sharp utensils can cause serious injuries. Load knives and other sharp utensils with sharp points and edges down. Do not allow children to handle or play near knives and sharp utensils.

### The Flexible Silverware Basket

This basket is designed for maximum versatility. The basket splits along its length, resulting in two halves that may be placed in a variety of positions in the lower rack, greatly increasing the lower rack's loading versatility.

#### To split the Flexible Silverware Basket:

1. Grasp the basket as shown in Figure 12A, and slide the two halves in opposite directions, as shown in Figure 12A.
2. Pull the two halves apart, as shown in Figure 12B.

Some suggestions for placing the two halves in the lower rack are shown in Figure 13.

#### Cup Shelves (select models)

In addition to cups, the shelves can also hold large utensils. Grasp the cup shelves and fold them down. Place cups upside-down on the cup shelves.

#### Knife Rack (select models)

The knife rack is an extra shelf for knives and other large utensils. It is assembled onto an edge of the upper rack. Place knives with sharp sides down as shown,

#### Glass Rack Attachment (select models)

The rack attachment has two additional cup shelves upon which to place cups and large kitchen utensils. The rack attachment is assembled on the rear edge of the lower rack. Before placing the glass rack in the bottom rack, first fold down the two rear rows of flip tines. To assemble:

Slide the Rack Attachment in as shown, keeping the longest tines on the inside of the top basket wire and on the outside of the lower basket wire. The short tines will snap into place.

#### Rack Attachment Use

To use the rack attachment, fold down the cup shelves and place items to be washed.

Cup Shelves



Knife Rack

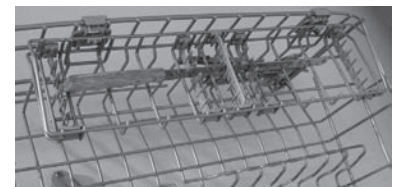

Glass Rack Attachment

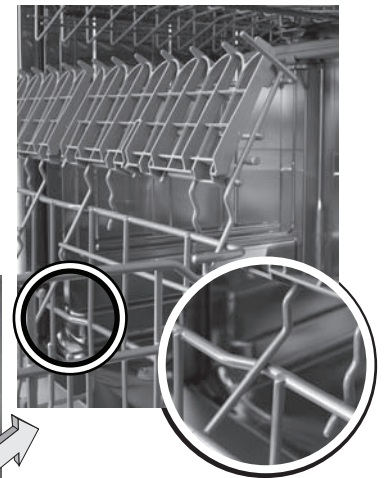

Figure 10

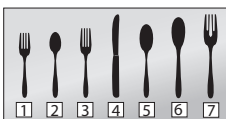
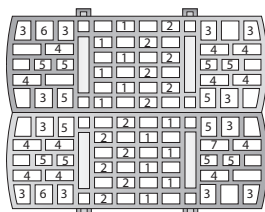

Figure 11



12 place setting

Figure 12

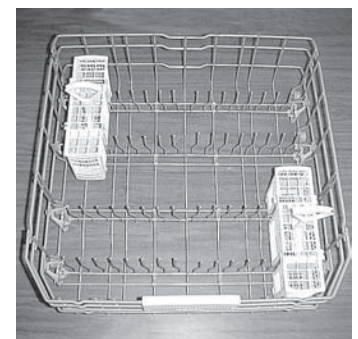
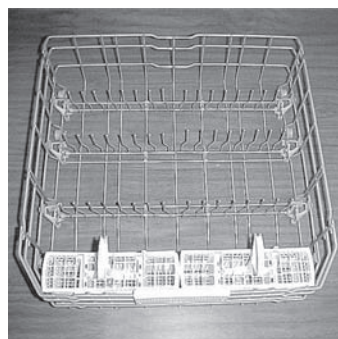
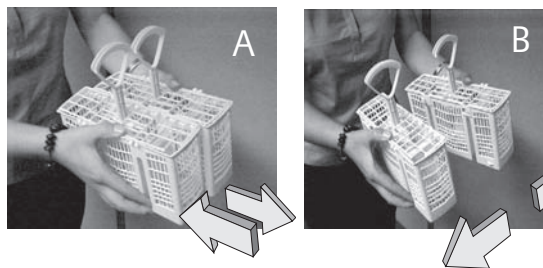
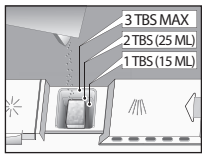

Figure 13



Figure 14



Add Detergent

- Use fresh powdered detergent for best results
- 1 tablespoon will clean most loads
- 3 tablespoons Max, do not overfill
- When using detergent tabs, lay them flat to avoid contact with the cover

# Adding Detergent and Rinse Agent

## Detergent

Use only detergent specifically designed for dishwashers. For best results, use fresh powdered dishwashing detergent.

### ATTENTION

To avoid dishwasher damage, do not use hand dishwashing products in your dishwasher.

This dishwasher uses less water so you need to use less detergent. With soft water, 1 tablespoon (15ml) of detergent will clean most loads. The detergent dispenser cup has lines that measure detergent to 1 tablespoon (15ml) and 1.75 tablespoons (25ml). 3 tablespoons (45ml) of detergent will completely fill the detergent dispenser cup.

### ATTENTION

To avoid dishware damage, do not use too much detergent if your water supply is soft. Using too much detergent in soft water may cause etching in glassware.

**NOTE:** If you do not know the hardness of your water supply, use 15ml of detergent. Increase the amount of detergent, if necessary, to the least amount required to get your dishware and kitchenware clean.

Use the measuring lines in the detergent dispenser cup as a guide to measure the amount of detergent recommended in Table 1.

Figure 15

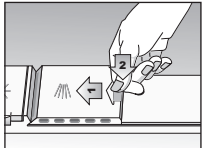

To close

- 1 Slide cover fully left
- 2 Push rear of cover down firmly until you hear the **CLICK**

Figure 16

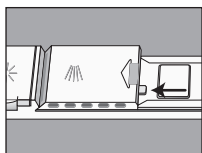

To open the cover

- Push the blue button in (NOT DOWN)

Figure 17

**Always use Rinse Agent** even if your detergent contains Rinse Agent

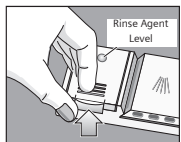

Lift tab to open

- Add Rinse Agent when the light on the control panel illuminates or (Model Dependent)
- Rinse Agent Level indicator on the dispenser changes to a light silver color

Table 1 - Recommended Detergent Amount				
Wash Cycle	Unit	Water Type		
		Hard	Medium	Soft
Power Scrub Plus/Auto Plus	ml	45	45	25-45
	Tbsp	3	3	1.75 to 3
Auto Wash	ml	25-45	25	15-25
	Tbsp	1.75 to 3	1.75	1 to 1.75
Regular Wash	ml	25-45	25	15-25
	Tbsp	1.75 to 3	1.75	1 to 1.75
Delicate/Economy	ml	25	15-25	15
	Tbsp	1.75	1 to 1.75	1
Quick Wash	ml	25	15-25	15
	Tbsp	1.75	1 to 1.75	1
Rinse Hold		None	None	None

Figure 18



- To add Rinse Agent pour on the arrow
- Turn arrow to adjust the amount of rinse agent dispensed

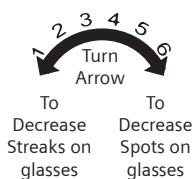

### Filling the Detergent Dispenser

Fill the dispenser cup as recommend in Table 1. (See Figure 14 for additional information.)

To close, slide the detergent dispenser cover in the direction shown in Figure 15 and press it down firmly so the cover snaps shut.

To open the detergent dispenser cover, press the blue release tab in the direction shown in Figure 16. Pressing down on the release tab will not open the cover.

### Rinse Agents

To achieve proper drying, always use a liquid rinse agent, even if your detergent contains a rinse agent or drying additive.



## Rinse Agent Dispenser

Open the rinse agent dispenser by lifting the tab with your thumb as shown in Figure 17.

**NOTE:** The dishwasher indicates low rinse agent by showing the symbol \* in the countdown display.

Add liquid rinse agent to the dispenser as shown in Figure 18 until the rinse agent reservoir is full. Wipe up any excess rinse agent that puddles when the dispenser reservoir is full.

**NOTE:** After filling the rinse agent dispenser, the indicator light will go out in a few minutes after the dishwasher door is shut (select models only).

# Operating the Dishwasher

Always make sure your dishware is dishwasher safe. Refer to the **Dishware Materials** section of this manual for guidance.

## Wash Cycles

### Auto Plus

Takes the guesswork out of cycle selection. Sensors adjust cycle length, temperature and water changes based on the soil load. This cycle is appropriate for pots and pans.

### Power Scrub Plus

Cleans items having baked-on or hard dried-on food soils. These items may require soaking or hand scouring.

### Auto

Takes the guesswork out of cycle selection. Sensors adjust cycle length, temperature and water changes based on the soil load. This cycle is appropriate for mixed loads.

### Regular

Thoroughly cleans large loads having loosely attached normal soiling.

### Delicate/Economy

For delicate or heirloom dishwasher and silverware or other special items. Always make sure that the items are dishwasher safe. Refer to the Materials section of this manual for further information. Hand washing may be the best treatment of such items.

### Quick Wash

For lightly soiled items with easy to remove food soils.

### Rinse and Hold

Allows you to rinse the food soil off of a partial load and hold them in the dishwasher until there is a full load.

## Wash Cycle Options

### Half Load

In the Power Scrub Plus, Regular and Auto Wash cycles you can reduce the energy and water consumption when washing small, lightly soiled loads that fill approximately half of the dishwasher's capacity. To activate, select the Half Load button in addition to the Power Scrub Plus, Regular or Auto Wash cycle button.

### Top Rack Only

This option allows you to save energy and water by washing loads small enough to fill the top rack only. To activate, select the Top Rack Only button in addition to a cycle. When using the Top Rack Only feature, dishes should only be loaded in the top rack.

### Extra Dry Heat

With this option you can raise the temperature of the rinse water and increase the drying time which will result in improved drying.

To activate:

- Press and hold the left "Cancel Drain" button, then press and hold the On/Off button.

	Wash Cycles						
	Auto Plus	Power Scrub Plus	Auto	Regular	Delicate/Economy	Quick Wash	Rinse and Hold
SHX55M		X	X	X	X	X	
SHX68M	X		X	X	X	X	X
SHE68M	X		X	X	X	X	X
SHV68M	X		X	X	X	X	X
SHE66C		X	X		X	X	X
SHX56C		X	X	X		X	X
SHV56C		X	X	X		X	X
SHX57C		X	X	X		X	X
SHV57C		X	X	X		X	X
SHY56A		X		X	X	X	X
SHE58C	X		X	X	X	X	

	Wash Options				
	Pre-soak	OptIMISER	Top Rack Only	Half Load	Eco
SHX55M		X		X	X
SHX68M		X		X	X
SHE68M		X		X	X
SHV68M		X		X	X
SHE66C	X		X		
SHX56C			X		
SHV56C			X		
SHX57C	X		X		
SHV57C	X		X		
SHY56A		X			
SHE58C				X	

Figure 19



- When the LED display shows a "00" or a "01" release both buttons.
- To enable the Additional Drying Heat, press the left "Cancel Drain" button until the LED display shows a "01".
- To disable the Additional Drying Heat, press the left "Cancel Drain" button until the LED display shows a "00".
- Press the On/Off button to save the setting.

**ECO function (select models):** This option saves energy by reducing the water temperature.

**Delay Start**

This option allows you to delay the start time of your dishwasher.

To activate:

- Turn the dishwasher on.
- Select the desired wash cycle.
- Press and hold the Delay Start button. Release when the desired delay time is shown in the display window.

**The Cycle Completion Signal**

This Cycle Completion Signal is a tone that sounds to alert you when your dishwasher finishes washing and drying your dishes. You can either disable the tone or set the volume.

To activate:

- Press and hold the right "Cancel Drain" button then press and hold the On/Off button.
- When the light on the "Cancel Drain" button you are pressing illuminates and the tone begins to sound, release both buttons.
- Press the right-most "Cancel Drain" button until the tone is either at the desired volume or is silent.
- Press the On/Off Button. The Cycle Completion Signal is now set.

Figure 20

**Hidden Top Controls**

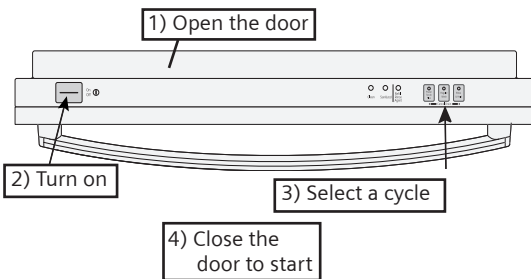

**OPTIDRY™**

This feature senses when the unit is low on rinse agent and automatically increases the drying time. For best performance, always use a liquid rinse agent even if your detergent contains a drying additive.

**OptiMISER™**

This feature reduces the cycle time by approximately 30% in the Power Scrub Plus, Regular, and Delicate cycles.

**Cycle Progress Indicator (select models)**

The front panel display shows cycle progress with the symbols show in Figure 19.

**Starting the Dishwasher**

To start the dishwasher, follow the instructions in Figure 20.

**Interrupting a Cycle**

**NOTE:** Should you need to interrupt a cycle (to add or remove an item, to add detergent, etc.), it is best to do so within the first 30 minutes of the cycle.

**Hidden Top Controls (See Figure 20)**

1. Open the dishwasher door just far enough to expose the control panel.
2. Press the On/Off button to turn the unit off.
3. Wait at least ten seconds or until the water noises stop before opening the dishwasher door.
4. To resume the cycle, press the On/Off button and close the dishwasher door.

Figure 21

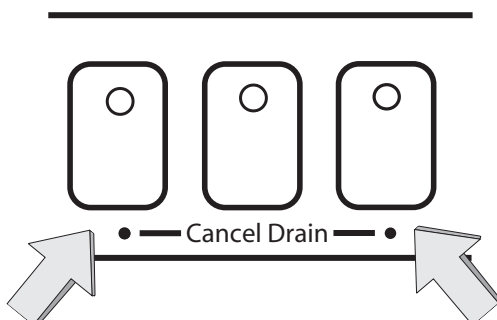

**⚠ WARNING**

You could be seriously scalded if you allow hot water to splash out of the dishwasher. **OPEN THE DOOR CAREFULLY** during any wash or rinse cycle. Do not fully open the door until water noises have stopped.

Wait at least ten seconds or until water noises stop before opening the dishwasher door. To resume the cycle, press the On/Off button and shut the dishwasher door.

### Canceling or Changing a Cycle

To cancel or change a cycle, open the dishwasher door far enough to expose the control buttons then press and hold for three seconds the two buttons labeled "Cancel Drain" as shown in Figure 21.

Close the door and wait until the dishwasher completes the cycle (approximately 1 minute). Open the door and press the ON/OFF button.

You may now begin a new cycle.

### Child Safety Latch (select models)

Your dishwasher is shipped from the factory with the Child Safety Latch disengaged and in the normal operating mode. Pull on the door handle to open the door. The Child Safety latch activation lever is located in the recess for the door handle. You must look up into the recess to find the Child Safety Latch activation lever (see Figure 22).

To activate the Child Safety Latch insert a matchstick or other non-metal object into the opening as shown in Figure 22. The activation lever will release and move toward the left.

You have now activated the Child Safety Latch. Each time you open the dishwasher door you will need to **slide the activation lever to the right** to release the door locking mechanism, you can then pull the door open (See Figure 23). After you open the door you should release the Child Safety Latch Activation lever and let it slide back toward the left.

To deactivate the Child Safety Latch insert a matchstick or other non-metal object into the opening as shown in Figure 24. Slide the activation lever to the right and hold. Remove the matchstick and release the lever. The feature has now been deactivated and you can open the door by pulling the handle.

### Dishware Drying

At the end of the cycle the dishwasher will stop and a period of condensation drying will follow. After drying, the cycle is complete and:

- the "Clean" light will illuminate (select models).
- the completion signal will sound (select models).
- the "Sanitized" light may appear. See section on Sanitization for more information.
- the countdown display will show "0" (select models).

**NOTE:** If your household water supply is too hot, your dishwasher's heating time may be reduced and the "Sanitized" light may not illuminate. Your Dishwasher Installation Manual has information on the recommended temperature for your household hot water supply.

**NOTE:** To accelerate and enhance drying, open the dishwasher door, pull the top rack a few inches out of the dishwasher, and prop the dishwasher door against the top rack.

### "Sanitized" Light

When the "Sanitized" light  appears, it means that the dishware and kitchenware that was just washed has been sanitized according to the requirements of the National Sanitation Foundation (NSF). For more information on NSF certification, go to the Wash Cycle Information section of this manual.

### Unloading the Dishwasher

Unload the bottom rack first.

Unload the silverware basket(s). They are easily removed for unloading.

Unload the top rack.

If the Extra Tall Item Sprinkler was installed, return the dishwasher to its normal condition (see the Loading Extra Tall Items instructions in the "Loading the Dishwasher" section of this manual).

Figure 22

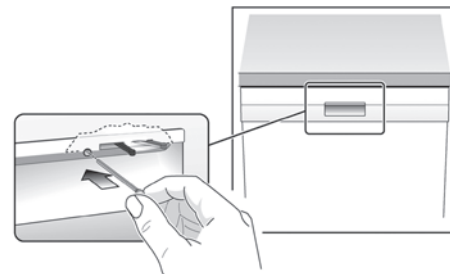

Figure 23

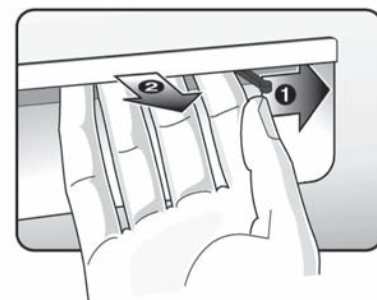

Figure 24

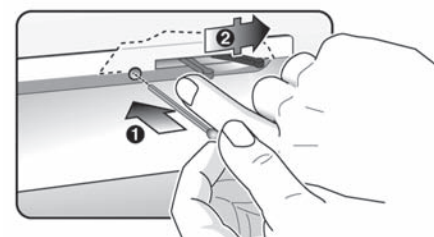

Figure 25

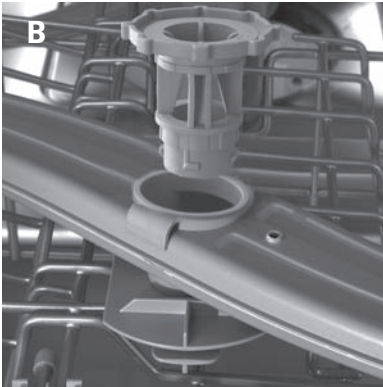
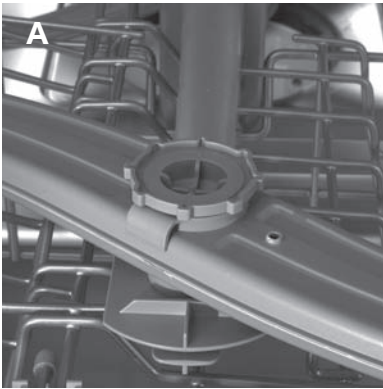

Figure 26

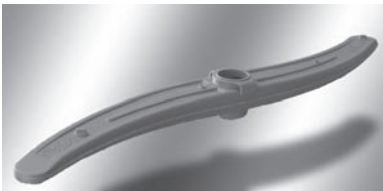

Figure 27

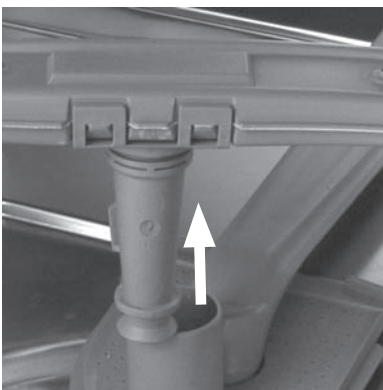
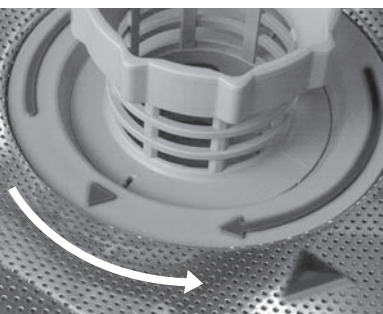

Figure 28



To open - turn counterclockwise.

# Care and Maintenance

## Maintenance Tasks

Certain areas of your dishwasher require occasional maintenance. The maintenance tasks are easy to do and will ensure continued superior performance from your dishwasher. These tasks are:

- Winterizing Your Dishwasher
- Wiping up Spills and Splash-out
- Clean the Stainless Steel Inner Door and Tub
- Check/Clean the Spray Arm Nozzles
- Check/Clean the Filter System
- Clean the Exterior Door Panel
- Clean the Door Gasket

## Winterizing Your Dishwasher

If your dishwasher will be unused for an extended period of time in a location that experiences freezing temperatures (e.g., in a holiday home or through a vacation period), have your dishwasher winterized by an authorized service center.

## ATTENTION

To avoid dishwasher damage, do not allow water to remain in your dishwasher systems through extended periods of freezing temperatures. Freezing temperatures can damage your dishwasher.

## Wiping Up Spills and Splash-out

Water may occasionally splash out of your dishwasher, especially if you interrupt a cycle or open the dishwasher door during a cycle. To avoid floor damage and possible mold growth, do not allow wet areas to remain around or under the dishwasher.

## Check/Clean the Stainless Steel Inner Door and Tub

Clean the outer edges of the inside door panel regularly to remove debris that might collect there from normal loading.

If spots begin to appear on the stainless steel tub or inner door, make sure the rinse agent reservoir is full.

## Check/Clean the Spray Arm Nozzles

Occasionally check the spray arms to ensure that the spray arm nozzles (holes) are unobstructed. You must remove the spray arms to check them for obstruction.

### To remove the top spray arm:

1. Remove the empty top rack from the dishwasher.
2. Turn the rack upside-down. The top spray arm is held in position by a locking nut as shown in Figure 25A. Turn the locking nut counter-clockwise 1/8 turn and remove it, as shown in Figure 25B to release the spray arm.
3. Remove the spray arm as shown in Figure 26.
4. Look for obstruction in the spray nozzles.
5. If the spray nozzles need cleaning, flush them under running water.

### To reinstall the top spray arm:

1. Return the top spray arm to its installed position.
2. Return the locking nut to its installed position and turn it 1/8 turn clockwise.
3. Return the top rack to the top rack roller guides.



### To remove the bottom spray arm:

1. Remove the empty bottom rack from the dishwasher tub.
2. Grasp and lift the bottom spray arm as shown in Figure 27.
3. Look for obstruction in the spray nozzles.
4. If the spray nozzles need cleaning, flush them under running water.

### To reinstall the bottom spray arm:

1. Return the bottom spray arm to its installed position and press it so that it snaps into place.
2. Return the bottom rack to its installed position.

### Check/Clean the Filter System

This dishwasher has a filter system that consists of a Large Object Trap/Cylinder Filter assembly and a Fine Filter. Select models have an additional Micro Filter. The filter system is located on the inside of your dishwasher under the lower rack and is easily accessible.

During normal use, the filter system is self-cleaning. You should occasionally inspect it for foreign objects and clean it when necessary.

### **CAUTION**

To avoid injury, do not reach into the large object trap with your fingers. The large object trap could contain sharp objects.

This dishwasher has a filter system that consists of a Large Object Trap/Cylinder Filter assembly and a Fine Filter. The filter system is located on the inside of your dishwasher under the lower rack and is easily accessible.

During normal use, the filter system is self-cleaning. You should occasionally inspect it for foreign objects and clean it when necessary.

### To Remove the Large Object Trap/Cylinder Filter Assembly:

1. Remove the bottom rack.
2. Grasp the assembly as shown in Figure 28 and turn it counter-clockwise 1/4 turn.
3. Lift out the assembly as shown in Figure 29.
4. Carefully examine the assembly. If you find debris in the Large Object Trap, turn it upside-down and gently tap it on a surface such as a countertop to dislodge and remove the debris. Flush the Cylinder Filter clean by holding it under running water.

### To Remove the Fine Filter:

1. Lift the Fine Filter from the dishwasher floor as shown in Figure 30 A and flush it clean by holding it under running water.
2. Remove the Micro Filter as shown in Figure 30 B and flush it clean by holding it under running water.

### To reinstall the filter system:

1. Return the Fine Filter to its installed position.
2. Place the Large Object Trap/Cylinder Filter Assembly into its installed position in the dishwasher floor.
3. Turn the ring handle clockwise 1/4 turn until it is locked. The arrow on the ring handle and the arrow on the Fine Filter should point to each other, as shown by the circle in Figure 31.
4. Gently pull the ring handle to ensure that the assembly is locked into place.

### **ATTENTION**

To avoid possible dishwasher damage, do not use harsh chemicals, abrasive cleaners, scouring pads (metal or plastic), or abrasive cloths/paper towels to clean your dishwasher's exterior door panel. Your dishwasher's exterior door panel can be damaged by doing so.

Figure 29

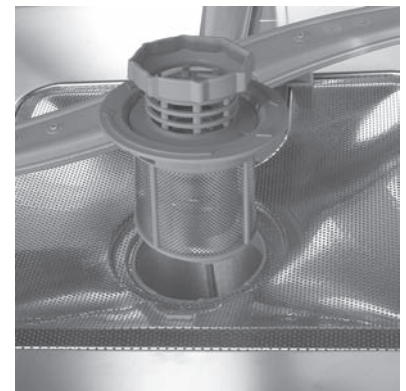

Large Object Trap/Cylinder Filter

Figure 30

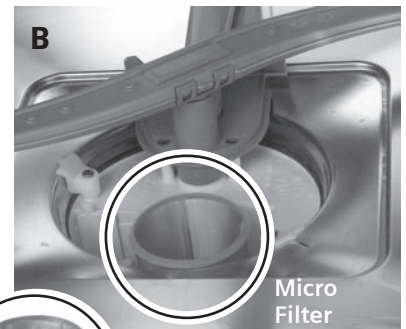
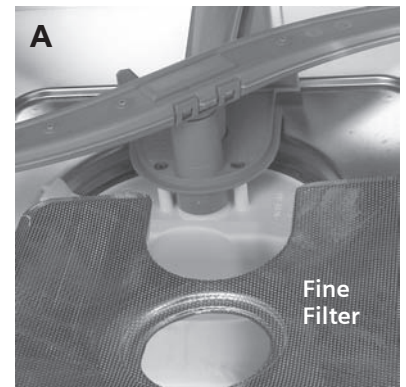
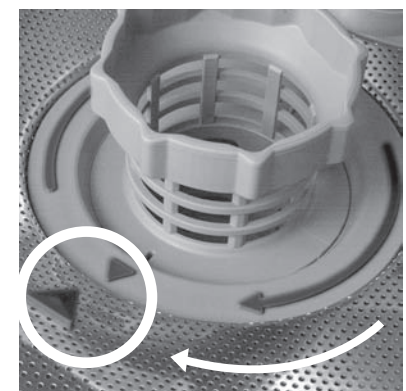

Figure 31



To close - turn clockwise.

## Clean the Exterior Door Panel

### Colored Doors

Use only a soft cloth that is lightly dampened with soapy water.

### Stainless Steel Doors

Use a soft cloth with a non-abrasive cleaner (preferably a liquid spray) made for cleaning stainless steel. For the best results, apply the stainless steel cleaner to the cloth, then wipe the surface.

### Clean the Door Gasket and Door Seal

Regularly clean the door gasket with a damp cloth to remove food particles and other debris. Also clean the door seal, located inside the dishwasher at the bottom of the door.

## Wash Cycle Information

To save energy, this dishwasher has a "Smart Control" that automatically adjust the cycle based on soil loads and incoming water temperature. The "Smart Control" makes decisions that can cause the cycle time and water usage to adjust intermittently. The cycle times listed in the Use and Care manual are based on normal soil loads and 120°F incoming water and will vary based on your actual conditions.

See the Available Cycles Chart to determine the cycles available for your specific model.

On select models, the Half Load feature will reduce the water consumption by approximately 30 percent in the Power Scrub Plus, Regular, and Auto Wash cycles.

On select models, the ECO feature will reduce energy consumption by approximately 10-25 percent depending on cycle chosen.

If additional drying heat is selected, the cycle will be extended by approximately 20 minutes.

If the unit is out of rinse agent, the **OPTIDRY™** feature will automatically extend the cycle time by approximately 10 minutes.

If Pre Soak is selected, the cycle will be extended by approximately 15 minutes.







### THE NSF SYMBOL

A dishwasher or a dishwasher cycle that has the NSF symbol has been certified by the NSF International to meet very strict requirements of wash time and water temperature to ensure dishware and kitchenware sanitization. These requirements are explained in the document NSF/ANSI 184, Residential Dishwashers. More information on NSF Certification is available at the NSF website, <http://www.nsfconsumer.org/home/appliances.asp>.



Your dishwasher is NSF certified. The dishwasher cycles that are NSF certified are shown in the chart above. When these cycles are complete, the "Sanitized" indicator on your dishwasher control panel will illuminate.

**NOTE:** If your household water supply is too hot, your dishwasher's heating time may be reduced and the "Sanitized" light or symbol may not illuminate. Your Dishwasher Installation Manual has information on the recommended temperature for your household hot water supply.

Data below refers to models SHE66C, SHX56C, SHV56C, SHX57C, SHV57C, SHY56A and SHE58C only. Refer to cycle charts to determine those available on your model.

		 Power Scrub Wash	 Auto Plus	 Auto	 Regular Wash	 Delicate/Economy	Quick Wash	Rinse and Hold
	Cycle Time (in minutes)	135	120 - 135	105 - 125	119	80	30	9
Water Consumption in gallons	Minimum	6.1	6.1	4.8	2.3	3.1	3.2	1.2
	Maximum	7.2	7.2	7.0	5.7	4.2	3.2	1.2
Water Consumption in liters	Minimum	23.2	23.2	18	8.8	11.5	12.3	4.7
	Maximum	27.4	27.4	26.4	21.7	15.7	12.3	4.7
Wash Temp °F		160°	150°-160°	130°-150°	131°	122°	113°	Incoming
Rinse Temp °F		156°	156°	156°	156°	156°	122°	Incoming

Data below refers to models SHX55M, SHX68M, SHE68M and SHV68M only. Refer to cycle charts to determine those available on your model.

		 Power Scrub Plus	 Auto Plus	 Auto	Regular Wash	Delicate/Economy	Quick Wash	Rinse and Hold
	Cycle Time (in minutes)	120 - 135	120 - 135	105 - 125	119	80 - 100	30	9
Water Consumption in gallons	Minimum	6.1	6.1	4.5	1.8	3.0	3.3	1.2
	Maximum	7.2	7.2	7.0	5.7	4.7	3.3	1.2
Water Consumption in liters	Minimum	23.2	23.2	17	6.9	11.5	12.3	4.7
	Maximum	27.4	27.4	26.4	21.7	17.7	12.3	4.7
Wash Temp °F		160°	150°-160°	130°-150°	122°-131°	113°-122°	113°	Incoming
Rinse Temp °F		156°	156°	156°	113°-156°	156°	122°	Incoming

# Self Help

Dishwashers may occasionally exhibit problems that are unrelated to a malfunction of the dishwasher itself. The following information may help you with a dishwasher problem without your having to call a repair person.

## **Dishes do not dry**

The rinse agent dispenser may be empty. Check the rinse-aid dispenser and refill it if necessary. Dishware drying can be accelerated and enhanced by opening the dishwasher door slightly and propping it open with the top rack.

## **Indicator light(s) do not come on**

A fuse may have blown or a circuit breaker tripped. Check the fuse or circuit breaker at your fuse box/breaker box and replace the fuse or reset the breaker if necessary.

## **Dishwasher does not start**

The dishwasher door may not be properly shut. Make certain the dishwasher door is shut and latched.

## **Dishwasher runs a long time**

If the dishwasher completes the cycle, but the run time seems exceptionally long, it may be due to cold incoming water. Before starting the dishwasher, open the hot water faucet at the sink nearest the dishwasher. Run the water until it runs hot, then turn off the water and start the dishwasher.

## **Machine cycle does not advance to rinse**

**NOTE:** The Installation Manual that came with your dishwasher will help you with the following instructions. The water supply line may be shut off. Check the water supply valve and open it if it's shut.

## **White spots left on dishes**

More rinse agent is needed. Go to the Adding Detergent and Rinse Agent section of this manual for instructions on increasing the amount of rinse agent dispensed.

## **Water not pumped from dishwasher**

Make certain the drain hose isn't kinked, clogged, or improperly installed. Make certain a portion of the drain hose is at least 20 inches above the dishwasher's enclosure floor (see the Installation Manual). Filters may be clogged. Make certain the filter system isn't clogged (see the Care and Maintenance section of this manual). The kitchen sink drain may be clogged; you may need a plumber rather than a serviceman for the dishwasher. If an air gap is installed at sink, it may be clogged.

## **Detergent dispenser cover will not shut**

You may not be correctly shutting the detergent dispenser cover, or a cycle was not finished and should be cancelled. Go to the Adding Detergent and Rinse Agent section of this manual for instructions on shutting the detergent dispenser cover. Go to the Operating the Dishwasher section of this manual for instructions on canceling a cycle.

## **Streaks on glassware**

Too much rinse agent is being dispensed. Go to the Adding Detergent and Rinse Agent section of this manual for instructions on decreasing the amount of rinse agent dispensed.

## **Rattling noises**

Utensils may not be properly arranged.

## **Suds in dishwasher**

You may have used the wrong type of dishwashing detergent. Use only automatic dishwasher detergents.

## **Unsatisfactory washing results**

- Incorrect amount of detergent.
- Utensils incorrectly arranged or rack overloaded.
- Spray arm rotation blocked by utensils.
- Spray arm nozzles need cleaning.
- Filters not properly fitted into position.
- Unsuitable cycle selected.



# Statement of Limited Product Warranty

## Bosch Dishwashers

**What this Warranty Covers & Who it Applies to:** The limited warranty provided BSH Home Appliances ("Bosch") in this Statement of Limited Product Warranty applies only to Bosch dishwashers ("Product") sold to you, the first using purchaser, provided that the Product was purchased: (1) for your normal, household (non-commercial) use, and has in fact at all times only been used for normal household purposes; (2) new at retail (not a display, "as is", or previously returned model), and not for resale, or commercial use; and (3) within the United States or Canada, and has at all times remained within the country of original purchase. The warranties stated herein apply only to the first purchaser of the Product and are not transferable.

- Please make sure to return your registration card; while not necessary to effectuate warranty coverage, it is the best way for Bosch to notify you in the unlikely event of a safety notice or product recall.

**How Long the Warranty Lasts:** Bosch warrants that the Product is free from defects in materials and workmanship for a period of three hundred sixty five (365) days (i.e., 1 year) from the date of purchase. The foregoing timeline begins to run upon the date of purchase, and shall not be stalled, tolled, extended, or suspended, for any reason whatsoever. Labor and shipping costs are included in this basic coverage.

**Extended Limited Warranty:** Bosch also provides these additional limited warranties:

- **2 Year Limited Warranty:** Bosch will repair or replace any component that proves to be defective in materials or workmanship (excludes labor charges).
- **5 Year Limited Warranty on Electronics:** Bosch will repair or replace any Bosch microprocessor or printed circuit board if it proves to be defective in materials or workmanship (excludes labor charges).
- **5 Year Limited Warranty on Dish Racks:** Bosch will replace the upper or lower dish rack (excluding rack components), if the rack proves defective in materials or workmanship (excludes labor charges).
- **Lifetime Warranty against Stainless Steel Rust Through:** Bosch will replace your dishwasher with the same model or a current model that is substantially equivalent or better in functionality, if the inner liner should rust through (excludes labor charges). Bosch will replace the stainless steel door if the door should rust through (excludes labor charges).

The foregoing timeline begins to run upon the date of purchase, and shall not be stalled, tolled, extended, or suspended, for any reason whatsoever.

**Repair/Replace as Your Exclusive Remedy:** During this warranty period, Bosch or one of its authorized service providers will repair your Product without charge to you (subject to certain limitations stated herein) if your Product proves to have been manufactured with a defect in materials or workmanship. If reasonable attempts to repair the Product have been made without success, then Bosch will replace your Product (upgraded models may be available to you, in Bosch's sole discretion, for an additional charge). All removed parts and components shall become the property of Bosch at its sole option. All replaced and/or repaired parts shall assume the identity of the original part for purposes of this warranty and this warranty shall not be extended with respect to such parts. Bosch's sole liability and responsibility hereunder is to repair manufacturer-defective Product only, using a Bosch-authorized service provider during normal business hours. For safety and property damage concerns, Bosch highly recommends that you do not attempt to repair the Product yourself, or use an un-authorized servicer; Bosch will have no responsibility or liability for repairs or work performed by a non-authorized servicer. If you choose to have someone other than an authorized service provider work on your Product, THIS WARRANTY WILL AUTOMATICALLY BECOME NULL AND VOID. Authorized service providers are those persons or companies that have been specially trained on Bosch products, and who possess, in Bosch's opinion, a superior reputation for customer service and technical ability (note that they are independent entities and are not agents, partners, affiliates or representatives of Bosch). Notwithstanding the foregoing, Bosch will not incur any liability, or have responsibility, for the Product if it is located in a remote area (more than 100 miles from an authorized service provider) or is reasonably

inaccessible, hazardous, threatening, or treacherous locale, surroundings, or environment; in any such event, if you request, Bosch would still pay for labor and parts and ship the parts to the nearest authorized service provider, but you would still be fully liable and responsible for any travel time or other special charges by the service company, assuming they agree to make the service call.

**Out of Warranty Product:** Bosch is under no obligation, at law or otherwise, to provide you with any concessions, including repairs, pro-rates, or Product replacement, once this warranty has expired.

**Warranty Exclusions:** The warranty coverage described herein excludes all defects or damage that are not the direct fault of Bosch, including without limitation, one or more of the following: (1) use of the Product in anything other than its normal, customary and intended manner (including without limitation, any form of commercial use, use or storage of an indoor product outdoors, use of the Product in conjunction with air or water-going vessels); (2) any party's willful misconduct, negligence, misuse, abuse, accidents, neglect, improper operation, failure to maintain, improper or negligent installation, tampering, failure to follow operating instructions, mishandling, unauthorized service (including self-performed "fixing" or exploration of the appliance's internal workings); (3) adjustment, alteration or modification of any kind; (4) a failure to comply with any applicable state, local, city, or county electrical, plumbing and/or building codes, regulations, or laws, including failure to install the product in strict conformity with local fire and building codes and regulations; (5) ordinary wear and tear, spills of food, liquid, grease accumulations, or other substances that accumulate on, in, or around the Product; and (6) any external, elemental and/or environmental forces and factors, including without limitation, rain, wind, sand, floods, fires, mud slides, freezing temperatures, excessive moisture or extended exposure to humidity, lightning, power surges, structural failures surrounding the appliance, and acts of God. In no event shall Bosch have any liability or responsibility whatsoever for damage to surrounding property, including cabinetry, floors, ceilings, and other structures or objects around the Product. Also excluded from this warranty are scratches, nicks, minor dents, and cosmetic damages on external surfaces and exposed parts; Products on which the serial numbers have been altered, defaced, or removed; service visits to teach you how to use the Product, or visits where there is nothing wrong with the Product; correction of installation problems (you are solely responsible for any structure and setting for the Product, including all electrical, plumbing or other connecting facilities, for proper foundation/flooring, and for any alterations including without limitation cabinetry, walls, floors, shelving, etc.); and resetting of breakers or fuses. **TO THE EXTENT ALLOWED BY LAW, THIS WARRANTY SETS OUT YOUR EXCLUSIVE REMEDIES WITH RESPECT TO PRODUCT, WHETHER THE CLAIM ARISES IN CONTRACT OR TORT (INCLUDING STRICT LIABILITY, OR NEGLIGENCE) OR OTHERWISE. THIS WARRANTY IS IN LIEU OF ALL OTHER WARRANTIES, WHETHER EXPRESS OR IMPLIED. ANY WARRANTY IMPLIED BY LAW, WHETHER FOR MERCHANTABILITY OR FITNESS FOR A PARTICULAR PURPOSE, OR OTHERWISE, SHALL BE EFFECTIVE ONLY FOR THE PERIOD THAT THIS EXPRESS LIMITED WARRANTY IS EFFECTIVE. IN NO EVENT WILL THE MANUFACTURER BE LIABLE FOR CONSEQUENTIAL, SPECIAL, INCIDENTAL, INDIRECT, "BUSINESS LOSS", AND/OR PUNITIVE DAMAGES, LOSSES, OR EXPENSES, INCLUDING WITHOUT LIMITATION TIME AWAY FROM WORK, HOTELS AND/OR RESTAURANT MEALS, REMODELLING EXPENSES IN EXCESS OF DIRECT DAMAGES WHICH ARE DEFINITELY CAUSED EXCLUSIVELY BY BOSCH, OR OTHERWISE. SOME STATES DO NOT ALLOW THE EXCLUSION OR LIMITATION OF INCIDENTAL OR CONSEQUENTIAL DAMAGES, AND SOME STATES DO NOT ALLOW LIMITATIONS ON HOW LONG AN IMPLIED WARRANTY LASTS, SO THE ABOVE LIMITATIONS MAY NOT APPLY TO YOU. THIS WARRANTY GIVES YOU SPECIFIC LEGAL RIGHTS, AND YOU MAY ALSO HAVE OTHER RIGHTS WHICH VARY FROM STATE TO STATE. No attempt to alter, modify or amend this warranty shall be effective unless authorized in writing by an officer of BSH.**

**How to Obtain Warranty Service:** TO OBTAIN WARRANTY SERVICE FOR YOUR PRODUCT, YOU SHOULD CONTACT THE NEAREST BOSCH AUTHORIZED SERVICE CENTER, OR CALL 800-944-2904, or write Bosch at: BSH Home Appliances - 5551 McFadden Avenue, Huntington Beach, CA 92649 /

# Customer Service

Your Bosch dishwasher requires no special care other than that described in the Care and Maintenance section. If you are having a problem with your dishwasher, before calling for service please refer to the Self Help section. If service is necessary, contact your dealer or installer or an authorized service center. **Do not attempt to repair the appliance yourself.** Any work performed by unauthorized personnel may void the warranty.

If you are having a problem with your Bosch dishwasher and are not pleased with the service you have received, please take the following steps (in the order listed below) until the problem is corrected to your satisfaction:

1. Contact your installer or the Bosch Authorized Service Contractor in your area.
2. E-mail us from the customer service section of our website, [www.boschappliances.com](http://www.boschappliances.com).
3. Write us at the address below:

BSH Home Appliances, Corporation  
 5551 McFadden Avenue  
 Huntington Beach, CA 92649

4. Call us at 1-800-944-2904.

Please be sure to include your model information listed below as well as an explanation of the problem and the date it originated.

You will find the model and serial number information on the label located on the right edge of the dishwasher door as shown in Figure 32.

Also, if you are writing, please include a daytime phone number where you can be reached.

Please make a copy of your invoice and keep it with this manual. The customer must show proof of purchase to obtain warranty service.

## Your Model Information:

- Model Number \_\_\_\_\_
- Serial Number \_\_\_\_\_
- Date Purchased \_\_\_\_\_
- Date Installed \_\_\_\_\_



## CAUTION

Removing any cover or pulling the dishwasher from the cabinet can expose hot water connections, electrical power and sharp edges or points.

Figure 32



Model and Serial Number Label

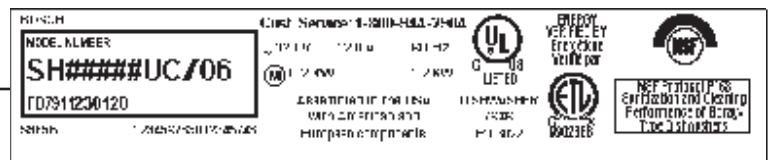

Serial Number

Model Number

Félicitations et merci de Bosch !

Merci d'avoir choisi un lave-vaisselle Bosch. Vous avez rejoint les nombreux consommateurs qui exigent un rendement supérieur et silencieux de leur lave-vaisselle.

Ce guide a été écrit avec sécurité et côté pratique en tête et l'information contenue ici est importante. Nous recommandons fortement de lire ce guide avant d'utiliser ce lave-vaisselle la première fois.

Pour en connaître plus sur ce lave-vaisselle et les accessoires disponibles ainsi que les autres appareils Bosch de haute qualité, visitez notre site : [www.boschappliances.com](http://www.boschappliances.com).

Vous pouvez communiquer avec nous pour tout commentaire et toute question en téléphonant au **1.800.944.2904** ou en écrivant à :

BSH Home Appliances, Corp.  
5551 McFadden Avenue  
Huntington Beach, CA 92649

Merci !

<b>INSTRUCTIONS IMPORTANTES DE SÉCURITÉ</b> .....	22-23
Composants du lave-vaisselle .....	23
Caractéristiques et options du lave-vaisselle .....	24
Matériaux .....	25
Préparation et chargement de la vaisselle .....	25-27
Préparation .....	25
Chargement.....	25-27
Ajout de détergent et d'agent de rinçage .....	28-29
Fonctionnement du lave-vaisselle.....	29-31
Séchage de la vaisselle .....	29-30
Déchargement. ....	31
Entretien.....	32-33
Information sur le cycle de lavage/hygiénique.....	34
Aide.....	35
Énoncé de garantie .....	36
Service à la clientèle.....	37

## **▲ Instructions de sécurité importantes-Conservé ces Instructions ▲**

### **AVERTISSEMENT**

Une mauvaise utilisation du lave-vaisselle peut causer des blessures ou la mort. Ne pas utiliser d'une façon autre que celle couverte dans ce guide ou à d'autres fins que celles expliquées dans les pages suivantes.

### **AVERTISSEMENT**

Des dommages aux produits et/ou des blessures peuvent résulter à cause d'un technicien non qualifié ou par des pièces de rechange non d'origine. Toute réparation doit être effectuée par un technicien qualifié utilisant seulement des pièces de rechange d'origine.

### **AVERTISSEMENT**

Il peut en résulter un choc électrique ou un incendie si l'alimentation électrique du lave-vaisselle indiquée dans ce guide est inadéquatement installée ou si le lave-vaisselle n'est pas adéquatement mis à la terre. Ne pas utiliser le lave-vaisselle si l'on n'est pas certain que l'alimentation électrique a été effectuée correctement ou que la mise à la terre est adéquate.

### **ATTENTION**

Ne jamais utiliser des produits nettoyants à vapeur dans le lave-vaisselle. Le fabricant n'est pas responsable des dommages ou conséquences possible.

### **ATTENTION**

Ne jamais utiliser des produits chimiques pour nettoyer le lave-vaisselle. Certains produits contenant du chlore peuvent endommager le lave-vaisselle et poser un risque pour la santé.

### **ATTENTION**

Il est recommandé que l'utilisateur se familiarise avec la marche à suivre d'arrêt de l'alimentation en eau entrante ainsi que de l'alimentation électrique. Voir les instructions d'installation ou communiquer avec l'installateur pour plus de détails.

BSH reserves the right to change specifications or design without notice. Some models are certified for use in Canada. BSH is not responsible for products which are transported from the United States for use in Canada. Check with your local Canadian distributor or dealer. BSH Home Appliances, Corporation, 5551 McFadden Avenue, Huntington Beach, CA 92649.

For the most up to date critical installation dimensions by fax, use your fax handset and call 775/833-3600. Use code #8030.

BSH se réserve le droit de modifier les données techniques ou le design sans préavis. Certains modèles sont certifiés pour une utilisation au Canada. BSH n'est pas responsable pour les produits transportés des États-Unis pour une utilisation au Canada. Vérifier auprès d'un marchand ou distributeur canadien. BSH Home Appliances Corporation, 5551 McFadden Avenue, Huntington Beach, CA 92649.

Pour les dimensions d'installation à jour par télécopieur, utiliser le combiné du télécopieur et composer le 775.833.3600. Utiliser le code n° 8030.

BSH se reserva el derecho de modificar las especificaciones o el diseño sin previo aviso. Algunos modelos están certificados para ser usados en Canadá. BSH no es responsable de productos que son transportados desde los Estados Unidos para ser utilizados en Canadá. Consulte a su distribuidor local en Canadá. BSH Home Appliances Corporation, 5551 McFadden Avenue, Huntington Beach, CA 92649.

Para recibir las dimensiones de instalación más actuales por fax, use su fax y llame al (775) 833-3600. Use el código #8030.

# BOSCH



## Free Manuals Download Website

<http://myh66.com>

<http://usermanuals.us>

<http://www.somanuals.com>

<http://www.4manuals.cc>

<http://www.manual-lib.com>

<http://www.404manual.com>

<http://www.luxmanual.com>

<http://aubethermostatmanual.com>

Golf course search by state

<http://golfingnear.com>

Email search by domain

<http://emailbydomain.com>

Auto manuals search

<http://auto.somanuals.com>

TV manuals search

<http://tv.somanuals.com>