

OWNER'S GUIDE

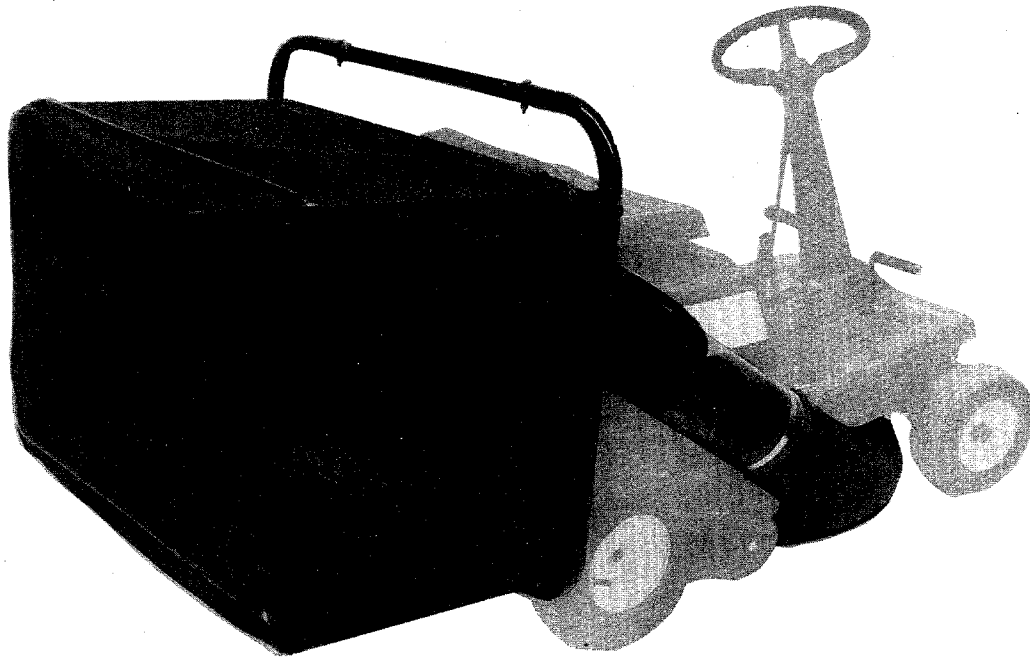

ASSEMBLY • OPERATION • MAINTENANCE • PARTS

BAG-IT REAR MOUNT GRASS CATCHER

Important:

**Read Safety Rules and
Instructions Carefully**

Model Numbers

**191-041A
19041-1**

Thank you for purchasing an
American built product.



Under normal usage the grass catcher is subject to wear, and should be checked periodically. Be sure any replacement complies with the mower manufacturers recommendation.

LIMITED WARRANTY

For one year from the date of original retail purchase, MTD PRODUCTS INC will either repair or replace, at its option, free of charge, F.O.B. factory or authorized service firm, any part or parts found to be defective in material or workmanship. Transportation charges for any parts submitted for replacement under this warranty must be paid by the purchaser unless such return is requested by MTD PRODUCTS INC.

This warranty will not apply to any part which has become inoperative due to misuse, excessive use, accident, neglect, improper maintenance, alterations, or unless the unit has been operated and maintained in accordance with the instructions furnished. This warranty does not apply to the engine, motor, battery, battery charger or component parts thereof. Please refer to the applicable manufacturer's warranty on these items.

This warranty will not apply where the unit has been used commercially.

Warranty service is available through your local authorized service dealer or distributor. If you do not know the dealer or distributor in your area, please write to the Customer Service Department of MTD.

The return of a complete unit will not be accepted by the factory unless prior written permission has been extended by MTD.

This warranty gives you specific legal rights. You may also have other rights which vary from state to state.

ASSEMBLY INSTRUCTIONS

List of Contents in Hardware Pack:
(See figure 1).

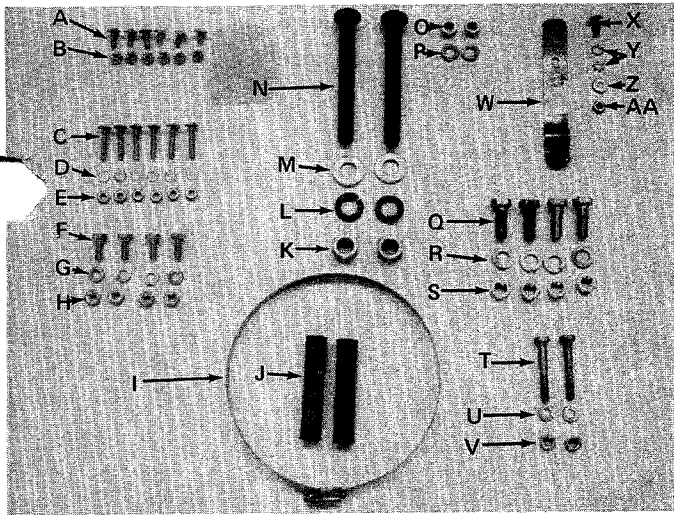

FIGURE 1

- A (6) Truss Machine Screws #10-24 x 3/8" Long.
- B (6) Hex Sems Nuts #10-24 Thread.
- C (6) Truss Machine Screws #10-24 x 1.00" Long.
- D (6) External Lock Washers #10 I.D.
- E (6) Square Nuts #10-24 Thread.
- F (4) Hex Bolts 1/4-20 x 1/2" Long.
- G (4) Lock Washers 1/4" I.D.
- H (4) Hex Nuts 1/4-20 Thread
- I (1) Hose Clamp
- J (2) Tube Connectors
- K (2) Hex Nuts 1/2-13 Thread
- L (2) Lock Washers 1/2" I.D.
- M (2) Flat Washers 1/2" I.D.
- N (2) Hex Bolts 1/2-13 x 4.50" Long
- O (2) Hex Nuts 5/16-18 Thread
- P (2) Lock Washers 5/16" I.D.
- Q (4) Hex Bolts 3/8-16 x 3/4" Long
- R (4) Lock Washers 3/8" I.D.
- S (4) Hex Nuts 3/8-16 Thread
- T (2) Hex Bolts 1/4-20 x 1-1/4" Long
- U (2) Lock Washers 1/4" I.D.
- V (2) Hex Nuts 1/4-20 Thread
- W (1) Spring Lock
- X (1) Truss Machine Screw #10-24 x 5/8" Long
- Y (2) External Lock Washers #10 I.D.
- Z (1) Flat Washers #10 I.D.
- AA (1) Square Nut #10-24 Thread

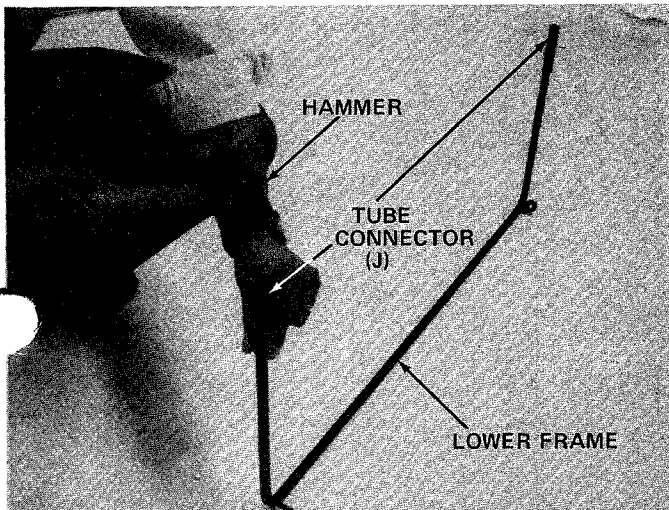

FIGURE 2

Remove all loose parts, hardware pack and literature from carton before discarding the carton.

1. Place the catcher frame assembly (lower half) on the floor or work bench and with a hammer tap on the tube connectors (J), one on each end. See figure 2.

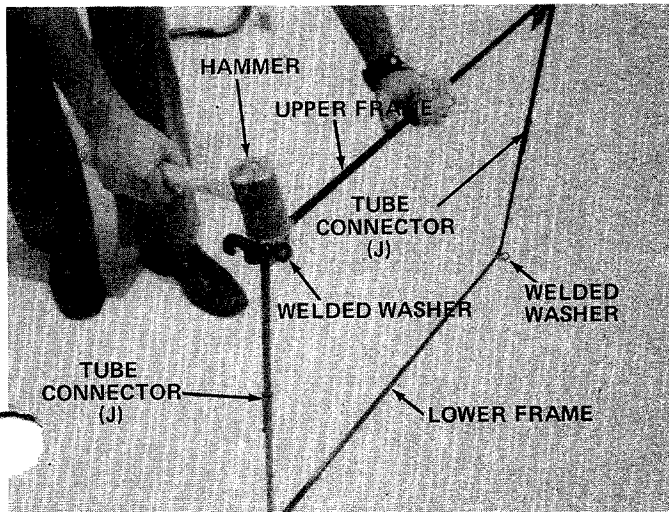

FIGURE 3

2. Place the catcher frame assembly (upper half) into tube connectors.



Be sure the welded washers on the upper and lower catcher frames are facing in the same direction. See figure 3.

With a hammer, tap the upper frame assembly into the tube connectors.

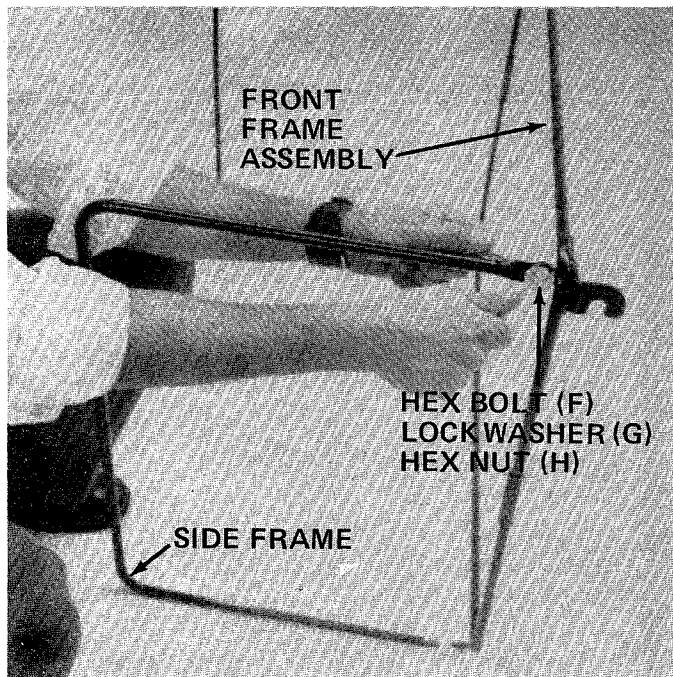

FIGURE 4

- Place the side frames in position over welded washers on front frame assembly. Secure in place with four hex bolts (F), lock washers (G) and hex nuts (H). See figure 4. Two 7/16" wrenches are required.

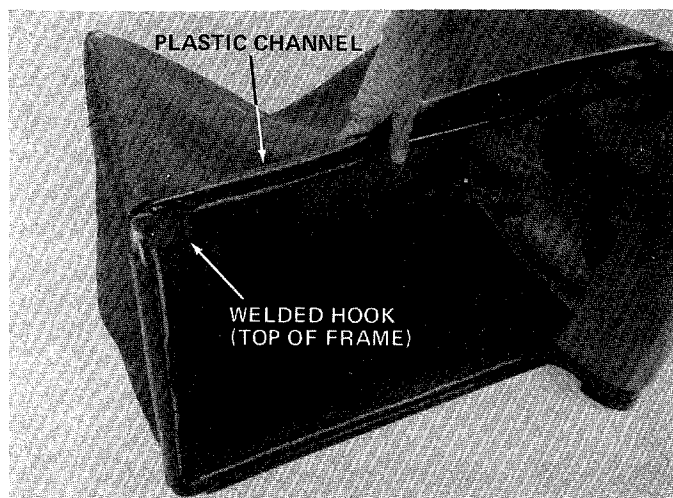

FIGURE 5

- Place the grass catcher bag over frame assembly. The top and bottom of bag is determined by the length of the plastic channel on edge of bag. The shorter channel will be the top. The top of frame has welded hooks. Secure the bag to frame by opening the plastic channel up by hand and snap over the frame. See figure 5.



FIGURE 6

- Place two handle braces on grass catcher bag and frame. One will be assembled to the top rear of bag and the other will assemble to the bottom rear of bag. Secure in place with two each truss machine screws (C), external lock (star) washers (D) and square nuts (E). See figure 6.

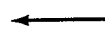

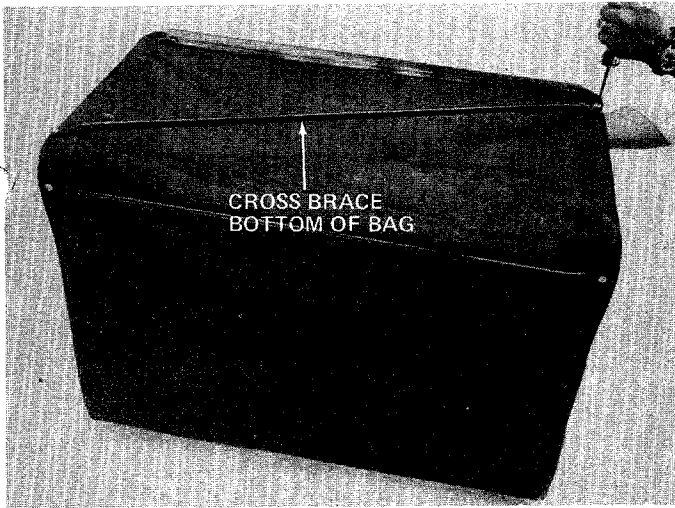

FIGURE 7

6. Place the grass bag upside down and assemble the cross brace as shown in figure 7. Secure in place with two truss machine screws (C), external lock (star) washers (D) and hex nuts (E).

7. Set the grass bag assembly aside for now.

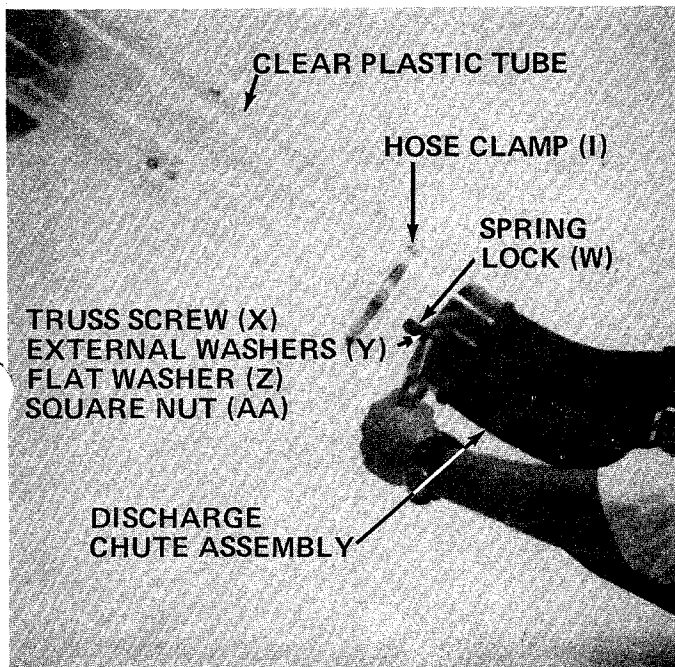

FIGURE 8

8. Place the hose clamp (I) over the end of the clear plastic tube. Slide the end of clear plastic tube over the discharge chute assembly. Place the spring lock (W) over lip of discharge chute assembly and secure to tube with truss machine screw (X), external lock (star) washers (Y), flat washer (Z) and square nut (AA). See figure 8.

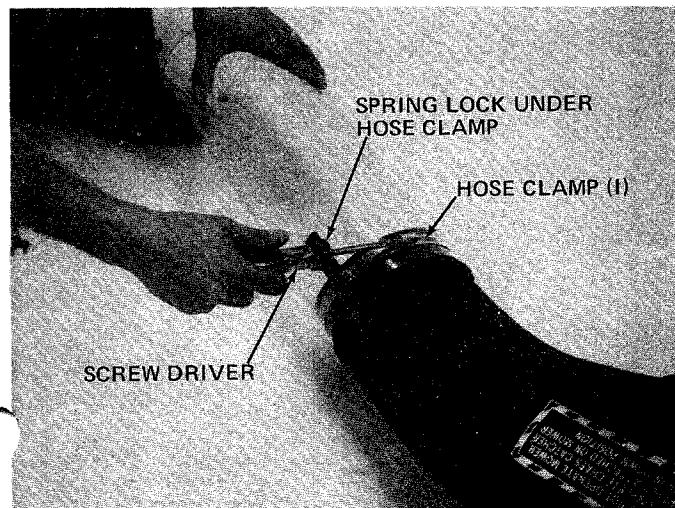

FIGURE 9

9. Slide the hose clamp (I) down over the top of spring lock and plastic tube and tighten with a screwdriver until clear plastic tube cannot be moved. See figure 9.

10. Set discharge chute and tube assembly aside for now.

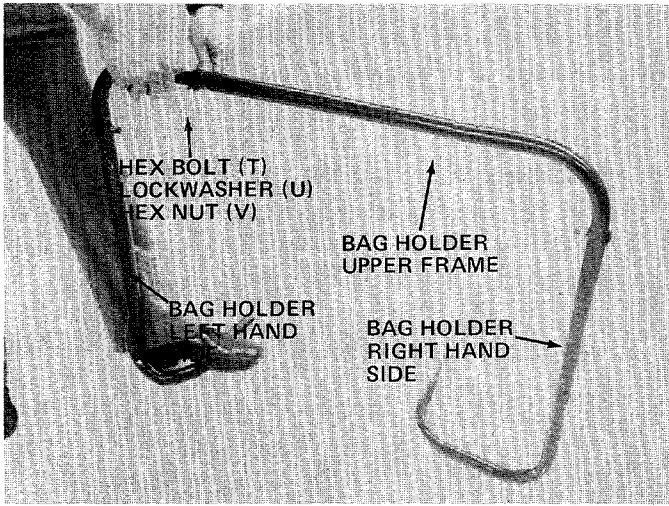

FIGURE 10

11. Assemble the bag holder frame. Slip the upper frame into the right and left hand frame halves. Secure with two hex bolts (T), lock washers (U) and hex nuts (V). Two 7/16" wrenches are required. See figure 10.

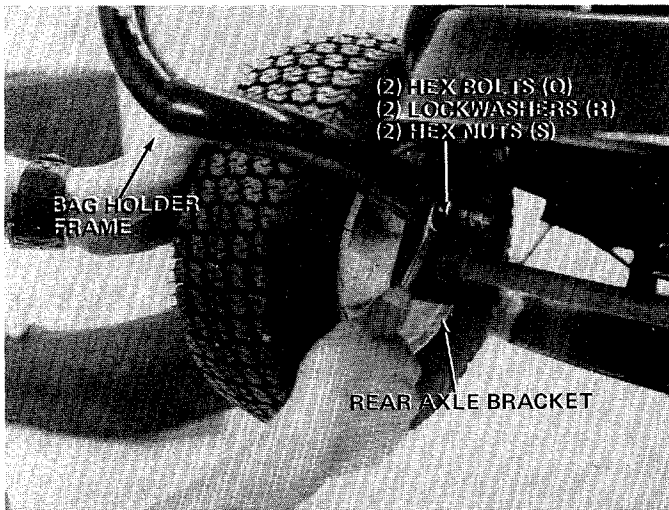

FIGURE 11

12. Place the bag holder frame assembly at the rear of the rider and line up the holes in bag frame with holes in rear axle bracket. See figure 11. Secure frame to axle bracket with four hex bolts (Q), lock washers (R) and hex nuts (S). Tighten bolts and nuts securely.

NOTE

You may want to remove the right hand rear wheel for ease of assembly.

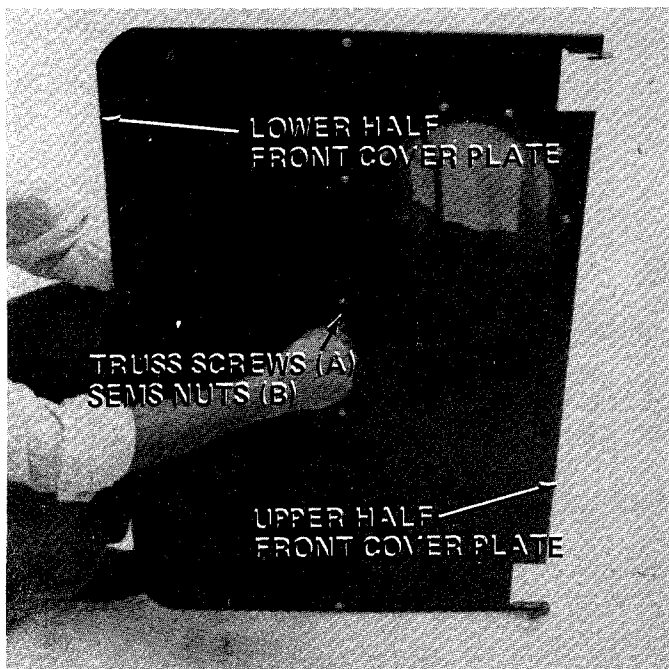

FIGURE 12

13. Assemble the upper and lower front cover plates with six truss screws (A) and hex sems nuts (B). See figure 12.

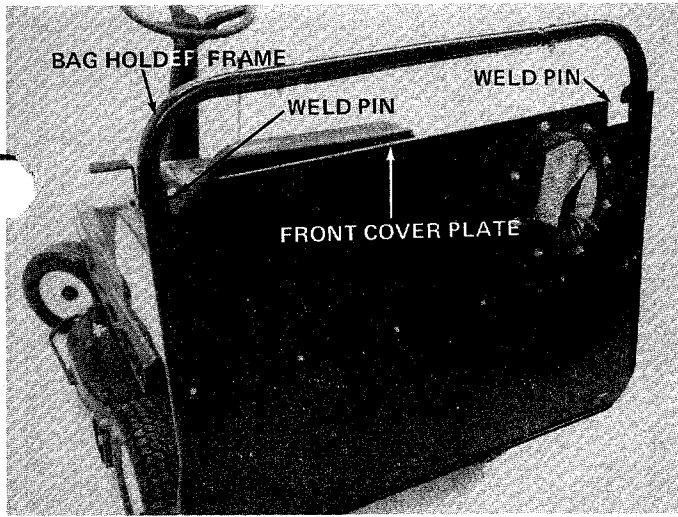

FIGURE 13

14. Hook the front cover plate assembly over weld pins located on bag holder frame. See figure 13.

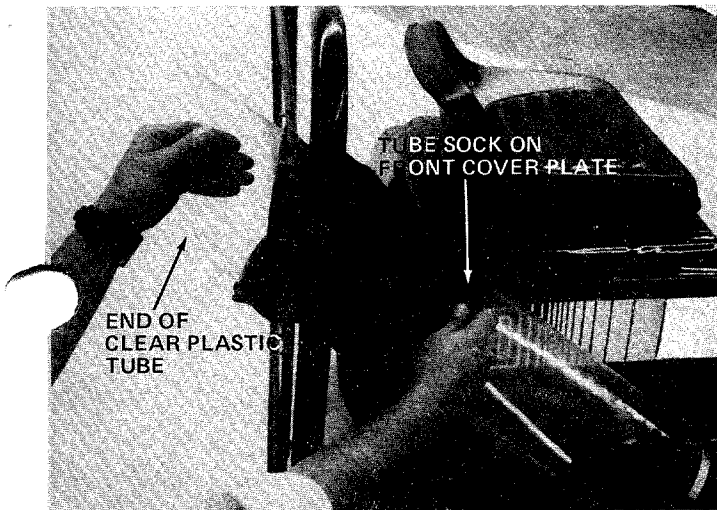

FIGURE 14

15. Place end of clear plastic tube through tube sock located on front of front cover plate as shown in figure 14.

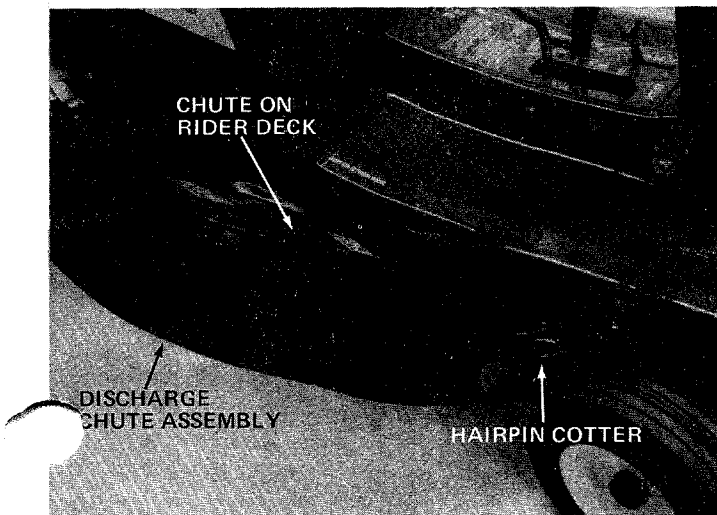
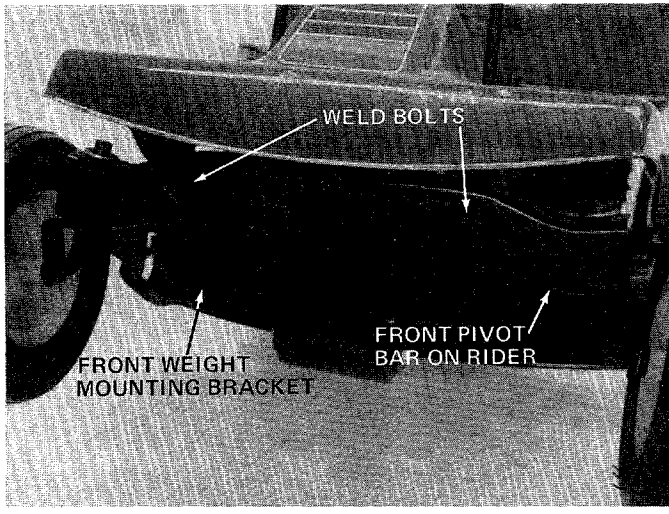

FIGURE 15

16. Raise the chute on rider deck up. Slide the discharge chute assembly into place lining up the hinge on chute assembly with hinge on deck. Secure with hairpin cotter provided. See figure 15.



17. Place the front weight mounting bracket in position on the front pivot bar (located on front of rider). Secure the weld bolts to pivot bar with two hex nuts (O) and lock washers (P). See figure 16.

FIGURE 16

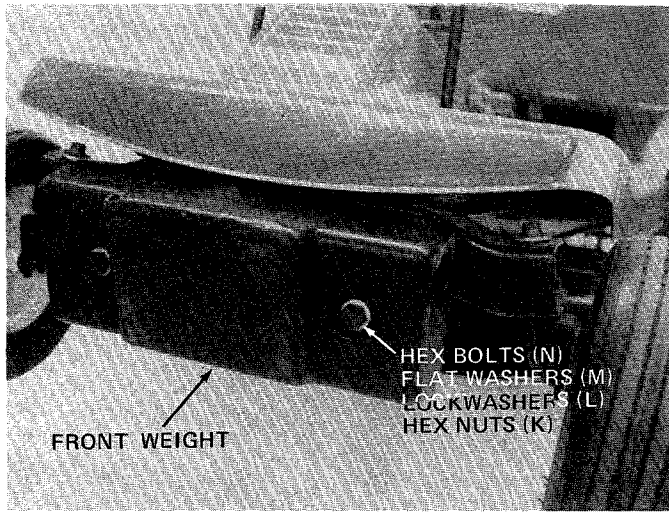

18. Place the front weight (35 lbs.) in position on the front weight mounting bracket. Fasten with two hex bolts (N) and flat washers (M) on the outside or front of weight. Secure bolts (N) with lock washers (L) and hex nuts (K). See figure 17.

FIGURE 17



19. Hook grass bag assembly in place on bag holder, over weld pins. See figure 18. When grass bag has been filled, back rider up to dumping area and simply lift up on handle brace to dump grass clippings.

FIGURE 18

DANGER: DO NOT OPERATE MOWER UNLESS COMPLETE GRASS CATCHER IS PROPERLY ATTACHED OR MOWER GUARD IS IN DOWN POSITION.

191-041A 19041-1

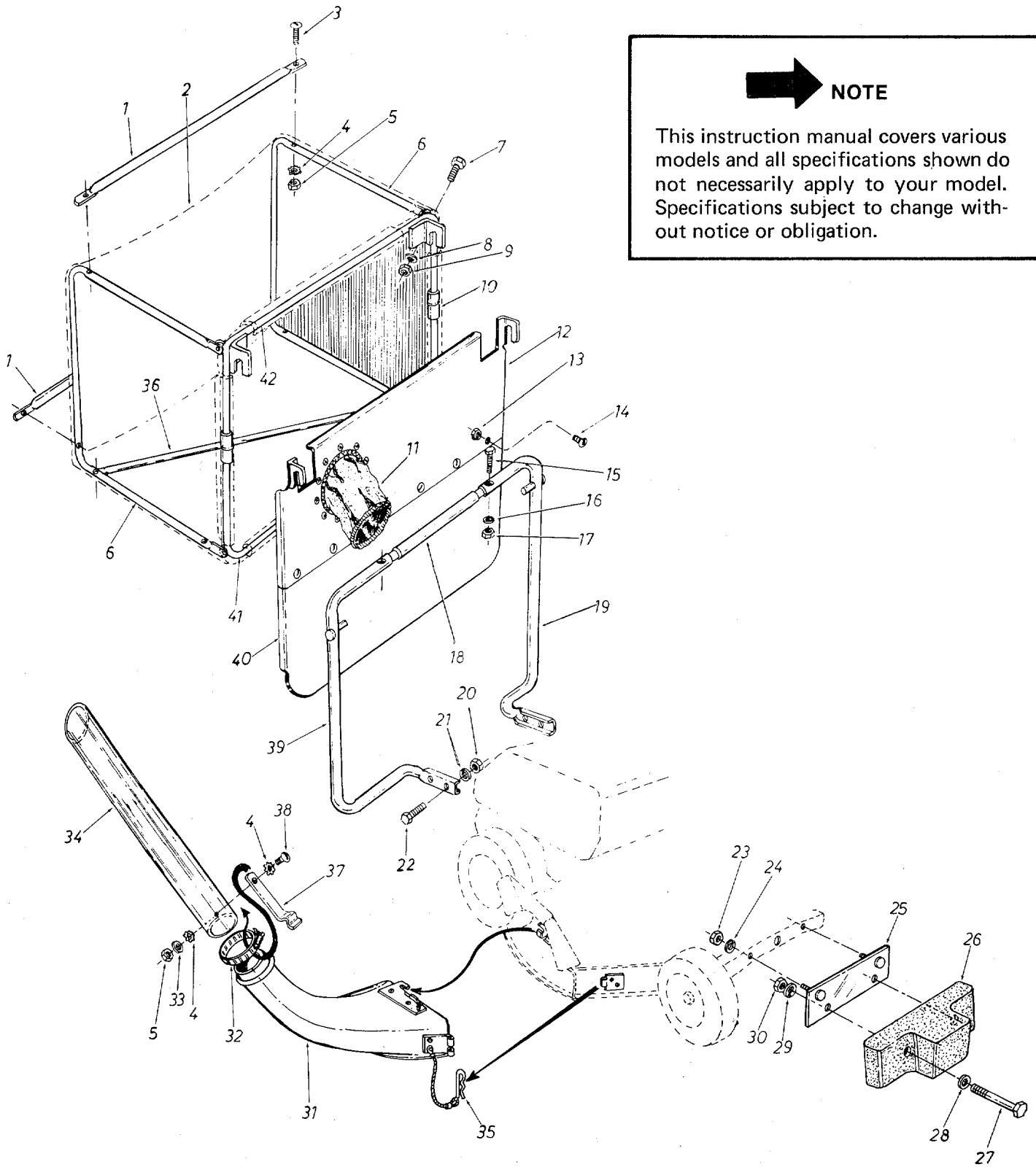

NOTE

This instruction manual covers various models and all specifications shown do not necessarily apply to your model. Specifications subject to change without notice or obligation.

191-041A 19041-1

PARTS LIST FOR GRASS CATCHER MODELS 191-041A AND 19041-1

Ref. No.	PART No.	DESCRIPTION	New Part
1	749-0458	Catcher Handle	N
2	764-0189	Grass Bag	N
3	710-0467	Truss Mach. Scr. #10-24 x 1.0" Lg.*	
4	736-0147	#10 Ext. L.-Wash.*	
5	712-0425	Sq. Nut #10-24 Thd.*	
6	749-0460	Catcher Side Frame	N
7	710-0289	Hex Bolt 1/4-20 x .50" Lg.*	
8	736-0329	L.-Wash. 1/4" I.D.*	
9	712-0287	Hex Nut 1/4-20 Thd.*	
10	750-0473	Tube Connector 1/2" Tube	
11	764-0190	Tube Sock	N
12	14395	Front Cover Plate - Upper Half	N
13	712-0425	Sq. Nut #10-24 Thd.*	
14	710-0192	Truss Mach. Scr. #10-24 x .38" Lg.*	
15	710-0106	Hex Bolt 1/4-20 x 1.25" Lg.*	
16	736-0329	L.-Wash. 1/4" I.D.*	
17	712-0287	Hex Nut 1/4-20 Thd.*	
18	749-0456	Bag Holder Upper Frame	N
19	14397	Bag Holder Side Frame Ass'y.- L.H.	N
20	712-0798	Hex Nut 3/8-16 Thd.*	
21	736-0169	L.-Wash. 3/8" I.D.*	
22	710-0216	Hex Bolt 3/8-16 x .75" Lg.*	
23	712-0267	Hex Nut 5/16-18 Thd.*	
24	736-0119	L.-Wash. 5/16" I.D.*	
25	14364	Front Weight Brk't. Ass'y.	N
26	723-0340	Weight 35#	
27	710-0496	Hex Bolt 1/2-13 x 4.50" Lg.*	
28	736-0192	Fl.-Wash. 1/2" I.D. x .940" O.D.	
29	736-0921	L.-Wash. 1/2" I.D.*	
30	712-0206	Hex Nut 1/2-13 Thd.*	
31	15193	Discharge Chute Ass'y.	
32	726-0149	Hose Clamp	
33	736-0931	Fl.-Wash. #10 I.D.	
34	731-0531	Grass Chute Tube-Clear Plastic	N
35	714-0155	Int. Cotter Pin	
36	749-0459	Catcher Cross Brace	N
37	732-0402	Grass Chute Spring Lock	N
38	710-0425	Truss Mach. Scr. #10-24 x .62" Lg.*	
39	14398	Bag Holder Side Frame Ass'y.-R.H.	N
40	14396	Front Cover Plate-Lower Half	N
41	14394	Catcher Frame Ass'y.-lower	N
42	14393	Catcher Frame Ass'y.-upper	N

*For faster service obtain standard nuts, bolts and washers locally. If these items cannot be obtained locally order by part number and size as shown on parts list.

MTD PRODUCTS INC YARD-MAN COMPANY

5965 GRAFTON ROAD • P.O. BOX 36900 • CLEVELAND OHIO 44136

Free Manuals Download Website

<http://myh66.com>

<http://usermanuals.us>

<http://www.somanuals.com>

<http://www.4manuals.cc>

<http://www.manual-lib.com>

<http://www.404manual.com>

<http://www.luxmanual.com>

<http://aubethermostatmanual.com>

Golf course search by state

<http://golfingnear.com>

Email search by domain

<http://emailbydomain.com>

Auto manuals search

<http://auto.somanuals.com>

TV manuals search

<http://tv.somanuals.com>