

BLANCO

 Performance First

Instructions for the Use and Care and Installation of

BOSE65

FAN FORCED OVEN

Dear Customer

You will find that the clean lines and modern look of your **Blanco** oven blends in perfectly with your kitchen décor. It is easy to use and performs to a high standard.

Blanco also makes a range of products that will enhance your kitchen – such as cook tops, rangehoods, dishwashers, microwaves, sinks and taps. There are models to complement your new Blanco oven. Blanco now has a range of laundry products to choose from.

Of course, we make every effort to ensure that our products meet all your requirements, and our Customer Relations Department is at your disposal, to answer all your questions and to listen to all your suggestions.

Please complete the warranty section of this manual and keep your receipt as proof of purchase. Retain all documents relating to the purchase of Blanco product.

Blanco is committed to providing increasingly efficient products that are easy to use, respect the environment and are attractive and reliable.

BLANCO

CONTENTS

Introduction	3
Contents	3
Safety recommendations	4-5
Specification	6
Cabinetry Preparation	7
Important notice to the User	8
Notes for the installation	9-10
Instructions for Use	11-13
Instructions for Cooking	14
Table of cooking times and temperature	15
Cleaning and Maintenance	16-18
Technical assistance	19
Warranty card	20



Safety recommendations

ELECTRIC OVEN

Read the following carefully to avoid an electric shock or fire

It is most important that this instruction book should be retained with the appliance for future reference. Should the appliance be sold or transferred, always ensure that the book is left with the appliance in order that the new owner can get to know the functions of the appliance and the relevant warnings. These warnings are provided in the interest of safety. You **MUST** read them carefully before installing or using the appliance.

Safety Warnings.

- The appliance is not intended for use by young children or infirm persons unless they have been adequately supervised by a responsible person to ensure that they can use the appliance safely.
- Young children should be supervised to ensure that they do not play with the appliance.
- **WARNING:** Ensure the appliance is switched off before replacing the lamp to avoid the possibility of electric shock.
- **WARNING - Accessible parts will become hot when in use. To avoid burns and scalds children should be kept away.**
- Do not use a steam cleaner to clean a hob, oven or range.
- Do not spray aerosols in the vicinity of the appliance when it is in operation.
- Do not store flammable materials in or under the appliance, eg aerosols.
- Always turn the grill off immediately after use as fat left there may catch fire.
- Do not cover the insert with foil, as fat left there may catch fire.
- Always keep the grill dish clean as any fat left there may catch fire.
- Do not leave the grill on unattended.
- To avoid a fire, ensure that grill trays and fittings are always inserted into the appliance in accordance with the instructions.
- Switch the appliance off before removing the oven light glass for globe replacement.
- To avoid an accident, ensure that oven shelves and fittings are always inserted into the appliance in accordance with the instructions.
- Do not use the door as a shelf.
- Do not push down on the open oven door.
- An authorised person must install this appliance.
- Before using the appliance, ensure that all packing materials are removed from the appliance.
- In order to avoid any potential hazard, the installation instructions must be followed.
- Ensure that all specified vents, openings and airspaces are not blocked.
- Only authorised personnel should carry out servicing.
- Always ensure the appliance is switched off before cleaning or replacing parts.



Safety recommendations

- Always clean the appliance immediately after any food spillage.
- To maintain safe operation, it is recommended that the product be inspected every five years by an authorised service person.
- If the supply cord is damaged, it must be replaced by the manufacturer or its service agent or similarly qualified person in order to avoid hazard.
- During use the appliance becomes hot. Care should be taken to avoid touching heating elements inside the oven.

HEADING GENERAL WARNINGS.

Using for the first time:

Before you use your oven for the first time, leave it empty and, with the door closed, turn it on to maximum temperature and let it heat up for 15 minutes. During this time there may be some smell from the mineral wool that insulates the oven and there could be some smoke. This is perfectly normal.

Normal use:

- Always close the door properly. The oven is fitted with a seal designed to work with a closed door.
- Always ensure the appliance is switched off before cleaning or replacing parts.
 - If the supply cord is damaged, it must be replaced by the manufacturer or its service agent or a similarly qualified person in order to avoid hazard.
 - During use the appliance becomes hot. Care should be taken to avoid touching heating elements inside the oven.

Do not install the product if it is damaged.

SPECIFICATION

Electrical features

Input voltage	230-240V 50 Hz
Grill element	1800 W
Upper element	800 W
Lower element	1000 W
Circular element	2100 W
Lighting bulb	max 25 W

This appliance complies with EEC 89/336 specifications issued for the magnetic compatibility. For components coming in contact with foodstuffs, the appliance complies with EEC 89/109 specifications.

ELECTRICAL CONNECTION: The appliance is fitted with an Australian approved 10 Amp flexible cord and plug which must be connected to a correctly earthed socket outlet.

The manufacturer is not liable for any direct or indirect damage caused by faulty installation or connection. It is therefore necessary that all installation and connection operations are carried out by qualified personnel complying with the local and general regulations in force.

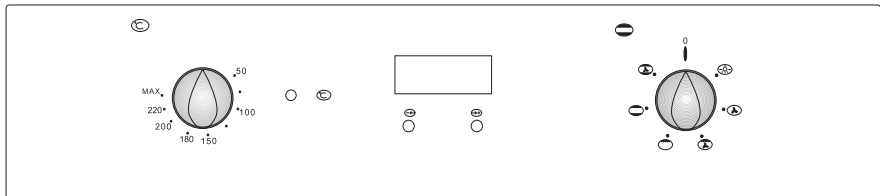

CABINETRY PREPARATION

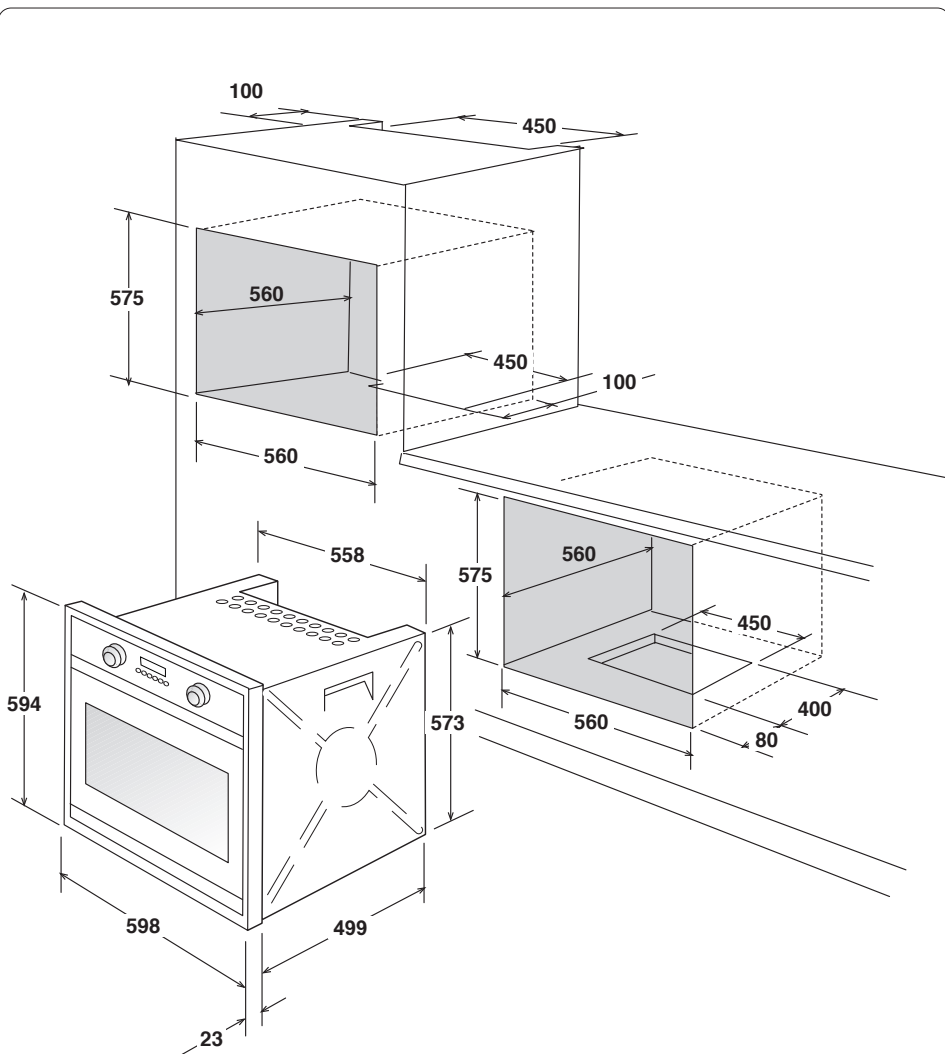

CABINETRY MATERIALS MUST BE SUITABLE TO WITHSTAND TEMPERATURES UP TO 90°C

Dimensions illustrated are for proudmount installation.

IMPORTANT NOTICE TO THE USER

The base element is concealed beneath the bottom of the oven to make the oven easier to clean and contribute to better access into the oven.

Because the element is concealed beneath the oven the following rules will need to be observed during cooking to ensure optimum performance from the oven.

DO NOT PLACE ALUMINIUM FOIL OR METAL OBJECTS ON THE BASE OF THE OVEN DURING COOKING.

Foil or dishes must never be placed on the base of the oven during cooking as the concentration of the direct and reflected heat will damage the enamel surface. Provisions of the warranty do not cover damage resulting from such use.

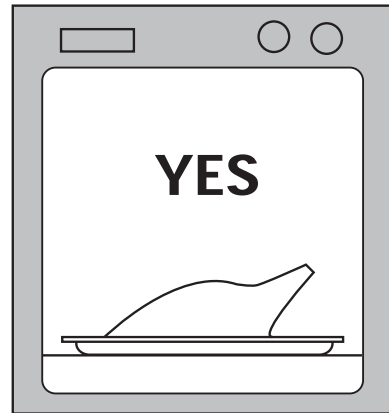
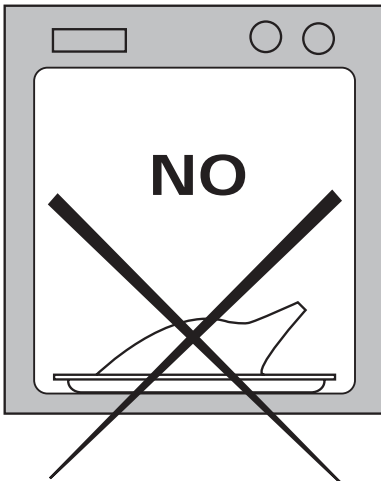

NOTES FOR THE INSTALLATION

GENERAL INFORMATION

The appliance must be installed in accordance with all relevant codes laid down by Electrical Supply Authorities. The original installation and adjustment must be made by a licensed electrician.

ELECTRICAL CONNECTION

The appliances are provided with a three-pole feeding cable and work with alternate current and single-phase voltage indicated on the rating plate of the product and in the instruction manual and on the product. The grounding conductor of the cable is marked with the colours yellow/green.

CONNECTION OF THE FEEDING CABLE TO THE MAINS

Connect the feeding cable of the oven to a plug suitable for the load indicated on the rating plate of the product. In case of a direct connection to the mains (cable without plug), it is necessary to insert a suitable omnipolar switch before the appliance, with minimum opening between contacts of 3 mm (the grounding wire should not be interrupted by the switch).

Before connecting to the mains, make sure that:

- The electrical counter, the fuse, the feeding line and the socket are adequate to withstand the maximum load required (see rating plate).
- The supply system is regularly grounded, according to the regulations in force.
- The socket or the omnipolar switch can easily be reached after the installation of the oven.
- After carrying out the connection to the mains, check that the supplying cable does not come into contact with parts subject to heating.
- Never use reductions, shunts, adaptors which can cause overheating or burning.

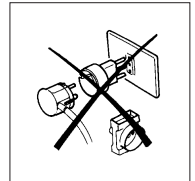

The manufacturer is not liable for any direct or indirect damage caused by faulty installation or connection. It is therefore necessary that all installation and connection operations are carried out by qualified personnel complying with the local and general regulations in force.

INSERTION AND ASSEMBLY

Insert the oven into the opening of the cabinet, resting it on the base and pushing it as far as the ledge of the side stanchions against the shoulder of the cabinet. For the dimensions of the oven see cabinet and technical data.

NOTES FOR THE INSTALLATION

•Open the door and fix the oven with four wood screws to be screwed up through the holes in the side stanchions of the oven.

Pay attention to fix the oven in an absolutely firm way, as indicated. If the oven is hard wired, ensure that the wiring is fixed securely into the terminal block to prevent contact with metallic parts.

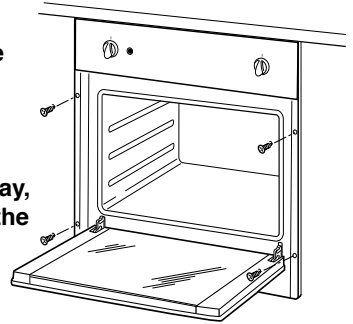

Once the electrical connection has been carried out, apply voltage to the oven only after installing it.

INSTRUCTIONS FOR USE

The selector A and thermostat B control is used to select the various oven functions and to choose the cooking temperatures best corresponding to the food to be cooked. During oven operation the lamp will always remain on.



The lamp of the oven is on, with no heating elements operated (electrical resistances). During oven operation the lamp will always remain on.



TRADITIONAL

Upper and lower heating elements operated; temperature adjustable from 50°C to MAX on the thermostat.

Suitable for the cooking of meats/poultry that require long, slow cooking as well as for the cooking of bread and sponge cakes.

It is advisable to insert the food to be cooked into the oven when it has reached the cooking temperature.



FAN ASSIST

Upper and lower heating elements and the oven-fan operated; temperature adjustable from 50°C to MAX on the thermostat.

A continuous circulation of warm air is created. This kind of heating is specially fit for cooking on multiple shelves. The cooking temperatures required are lower than when using traditional methods, thus saving time and energy. □ □



FAN FORCED

Back heating element and the oven-fan operated; temperature adjustable from 50°C to MAX on the thermostat.

The circular heating element and fan come into operation and the heat is spread evenly to all shelf positions. Various types of food can be cooked on different shelves, naturally with the appropriate cooking times. The oven must be preheated before the foods are placed inside. Fan mode provides optimum results with: cakes (soft and thick), large quantities of foods and cooking various dishes simultaneously. To operate, select Fan Forced function along with the temperature.



FAN GRILL

Grill Element and oven fan operated; turn the thermostat to position 200°C.

Used for grilling meats, vegetables and poultry. Preheat oven, place food on grill rack in baking tray and place in the middle of the oven. Other foods may be cooked underneath whilst grilling.



GRILL

Grill element operated; turn thermostat to position 200°C - Use for toasting and melting cheese or browning. No longer than 5 minutes cooking time. To operate, select Full Grill Function along with the temperature.

The oven door must be closed for all cooking methods

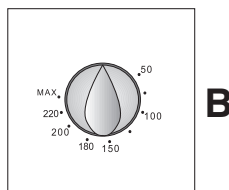
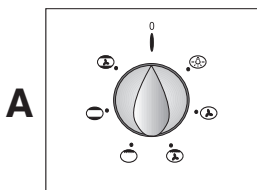

INSTRUCTIONS FOR USE

PROGRAMMING THE OVEN

Setting the Clock.

Once the power has been connected, the display 0.00 and the Auto indicator will flash alternately.

Press both keys (1) and (2) at the same time and release.

Within 4 seconds, set the clock by pressing either button (1) or (2) until the correct time is set.

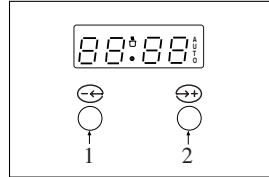

The oven is now in manual mode and the manual indicator  will be displayed. The oven can now be used without any further programming.

Setting End of Cooking Time

Step 1

- Select the oven mode and the temperature required using the function and the thermostat switches.

Step 2

- Auto mode is activated when you press (1) or (2).
- The press button (1) or (2) to set and adjust the cooking time.
- The display will show briefly the time entered and then revert back to the clock display.
- The oven is now in auto mode and the Auto indicator is displayed.
- If through the cooking time you would like to see how long is left, press either buttons (1) or (2) once (and briefly) and the remaining time will be displayed momentarily.
- At the end of cooking time an acoustic signal is activated, the oven will turn off and the auto indicator will flash. You will need to either:
 - **Option 1** - Turn off oven function and temperature switches. Push buttons (1) or (2) once to cancel the acoustic signal. Push button (1) or (2) once again to put the oven back to manual mode.
 - **Option 2** – if you wish to continue cooking at this point you need to put the oven back into manual. First of all stop the acoustic signal by pressing either button (1) or (2). Then press button (1) or (2) again to return to manual mode. Remember to turn off the oven function and temperature switches when you have finished cooking.

INSTRUCTIONS FOR USE

- **Note!** The acoustic signal will cut out automatically after 2 minutes if it hasn't been cancelled as above. If this happens then you will also need to:
 - Turn off oven function and temperature switches.
 - Push buttons (1) or (2) once to put the oven back to manual mode.

SAFETY LOCK FOR CHILDREN

The program is provided with a safety lock that locks the operation of the oven.

Activate the lock.

- Press both switches (1) and (2) at same time for about 10 seconds, the display shows "ON"; release the switches simultaneously and immediately.
- Press button switch (2) and the display will show  the key symbol.
- Now the safety lock is activated. The display shows the current time and every 30seconds the key symbol will appear for approximately 3 seconds.

Deactivate the Lock.

- Press both switches (1) and (2) at same time for about 10 seconds and the display shows "OF"
- Then press button (2) and "On" will be displayed; release the switch.
- The safety lock is deactivated and the display will show the current time.

General remarks.

- The maximum programming time is 23 hours, 59 minutes.
- If there has been a voltage cut out it will be necessary to reset the clock.

PILOT LIGHT OF THE THERMOSTAT (°C)

It comes on any time the oven is heating and switches off when the oven reaches the preset temperature.

SAFETY THERMOSTAT

It cuts out the electric supply preventing possible overheating when the appliance is not correctly used. In this case, wait until the oven cools down before using it again. On the other hand, if a fault is present with components, please contact your local Blanco service agent.

COOLING MOTOR

The oven has a built in fan for cooling the oven cavity. The fan starts automatically when using the oven .

INSTRUCTIONS FOR COOKING

It is necessary to pre-heat the oven to the preset cooking temperature. Only very fat meat can be placed into a cold oven. To minimise food splashes into the oven (which can sometimes produce smoke) deep baking dishes are recommended.

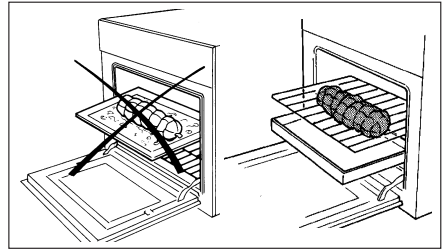

Practical hints to save energy

The oven can be switched off some minutes before the end of cooking. The residual temperature is enough to complete cooking. Open the oven door only when it is absolutely necessary. To check the cooking progress, look through the glass (the oven lamp is always on).

General Advice

The oven offers various kinds of heating:

- Traditional heating for the cooking of special roasts that require slow cooking.
- Fan forced - for cooking cakes, biscuits and similar.
- If the fan forced cooking is chosen, you can put your roast meat (as an example) on various shelf positions. You can also cook multiple dishes in the oven at the same time to help save energy.

PROTECTION FILTER OF THE OVEN FAN

During the cooking of fatty products, to avoid too much fat residue striking the fan, the filter should be placed in the oven before use. When cooking is finished and oven cools, remove the filter and wash it carefully. Install the filter by leaning it against the rear wall at the same level of the fan, then push the tang downwards. Reverse this operation to remove the filter.

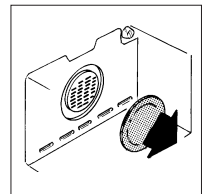

ATTENTION:

The filter should be only used when cooking fatty foods. Better cooking results for non fatty foods will be achieved without the filter installed.

COOKING TIMES

- **The times indicated in the table refer to the cooking of one food only. For more than one food, the cooking times should be increased by 5 - 10 minutes.**

For beef, veal, pork and turkey roasts with bones or rolled, add about 20 minutes to the times shown in the table.

TABLE OF COOKING TIMES

The table below provides indicative shelf positions for use with your oven. Please note, the temperature and cooking times are indicative only. According to different cooking habits, it may be necessary to make further modifications. Add to the below mentioned times about 15 minutes for preheating.

	Shelf position	Temperature (°C)	Time (Mins)
	Fan oven	Fan oven	
Sweets			
Pastry	2 (3/4)	200-230	20-30
Sponge cakes	2 (2/3/4)	185-200	35-45
Fish			
Fillets or slices	2 (2/3)	180-200	15-20
Meat			
Veal	2 (2/3/4)	175-190	60-70
Pork	2 (2/3/4)	175-200	70-90
Chicken	2 (2/3/4)	175-200	80-90
Turkey	2 (2/3/4)	175-200	90-120
Beef	2 (2/3/4)	175-200	70-90
Lamb	2 (2/3/4)	180-200	85-100
Bread and pizza			
Pizza	2 (2/3)	200-230	15-25
Muffins	2 (2/3/4)	175	20-30
Bread	3 (2/3/4)	180-200	40-50
Bakes			
Vegetable bake	2 (2/3)	175-185	30-40

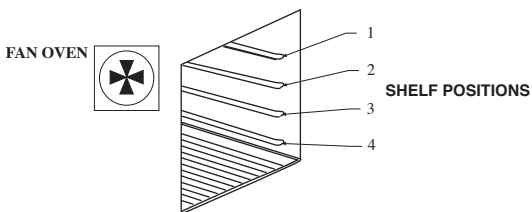

CLEANING AND MAINTENANCE

Caution: before any operation, disconnect electrically the oven.

GENERAL CLEANING

To keep the characteristics of brightness of the enamelled parts for a long time it is necessary to clean the oven after each use. Once the oven is cold, you will be able to easily remove the fat deposits by means of a sponge or a cloth damp with warm soapy water and eventually a detergent to be found on the market. Never use abrasive cloths or sponges, that could irreparably damage the enamel. On white ovens even the parts of the control panel such as handgrip and knob have to be cleaned each time because they may become yellow due to the emissions of fat vapours. After the use, rinse thoroughly with water the parts in stainless steel and dry them with a soft cloth or with a bockskin. In case of persistent stain, use the normal non-abrasive cleaning agents or one of the specific products for stainless steel or some warm vinegar. Clean the door glass only with warm water, avoiding the use of rough cloths.

Ovens with facility to lower grill for cleaning purposes

- 1 Warning: ensure that all controls are in the "OFF" position and wait for the grill element to cool.
- 2 Support the front of the grill element while you remove the knurled screw retaining the element.
- 3 Lower the front of the element carefully to the rest position.
- 4 When cleaning the oven take care to not apply any forces to the grill element
- 5 When the cleaning is complete, carefully remove any cleaning chemicals and water from the grill element.
- 6 Carefully raise the front of the element into position and secure with the knurled screw.

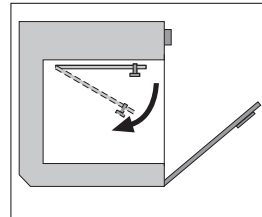

NEVER USE THE OVEN WITH THE GRILL ELEMENT HANGING DOWN!

Replacing the oven bulb

Once the oven has been electrically disconnected, unscrew the glass protection cap and the bulb, replacing it with another one suitable for high temperatures (300°C / E14). Reassemble the glass cap and reconnect the oven.

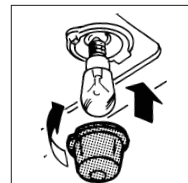

CLEANING AND MAINTENANCE

Cleaning the oven door

ATTENTION: for your safety, before removing the glasses you should remove the oven door.

1. Set the oven door wide open.
2. Lift the hinge jumpers with your thumb and index fingers, then turn them fully outwards to the end of stroke (Fig.A).
3. Turn the door towards the closure position and lay it on the jumpers: in this way the hinge's spring is blocked. By fully closing the door the hinges are unhooked from the connection slits which are integral with the oven muffle (sequence 1,2,3 of fig.B).

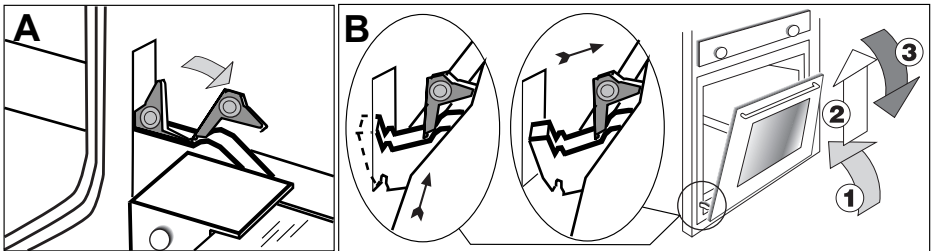

Re-assemble the door by carrying-out the aforesaid operations in the opposite order.

Disassembling of the door glasses

To facilitate the cleaning, after having removed the door from the oven, you can proceed with the disassembly of the glass. Release the two upper blocks (picture C) so that the glass can be removed (picture D). After the cleaning you should reassemble the glass, replace the blocks and lock into position. Check that all components have been assembled correctly and than you can re-assemble the door onto the oven.

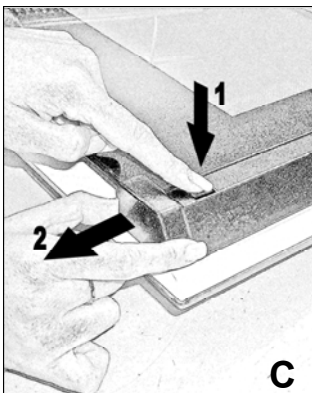

Please keep the (OK) symbol below on the right.

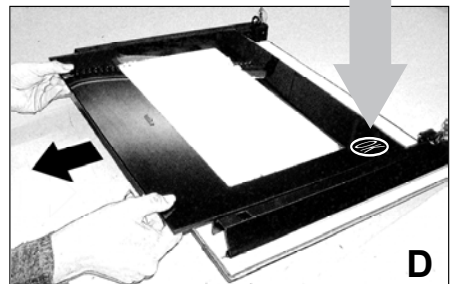

CLEANING AND MAINTENANCE

Care of Catalytic Liners. (If your oven has had these fitted)

Splashes of food and fats from cooking will collect on the catalytic liner. After cooking a dish with high fat content or when you can see grease spots on the liners, it is recommended that you :

- * Remove baking dishes and oven racks
- * Wipe out the bottom of the oven and clean the door
- * Turn oven to 220°C for approximately 20 minutes
- * When oven is cool, wipe out bottom of the oven

Manual cleaning of the catalytic liner is not recommended. Damage will occur if soap impregnated steel wood pads, aerosol cleaners and any other abrasives are used.

Slight discolouration and polishing of the Catalytic surface may occur in time. This does not affect the Catalytic properties in any way.

Blanco Contact Information.

NEW SOUTH WALES

Head Office, Sales & Marketing Office

104 Vanessa Street
Kingsgrove NSW 2208
Telephone: 02 9503 2888
Facsimile: 02 9503 2810

NSW Showroom*

40 Ebley Street
Bondi Junction NSW 2022
Telephone: 02 9386 1190
Facsimile: 02 9386 1671

Service and Spare Parts

All General Whitegoods Service
Telephone: 02 8788 8666
Facsimile: 02 9756 1091

AUSTRALIAN CAPITAL TERRITORY

Service and Spare Parts

Detlevs Appliance & Electrical Care
1/88 Sheppard Street
Hume
ACT 2905
Telephone: 02 6280 1033
Facsimile: 02 6260 1035

VICTORIA

State Office and Showroom*

35 Centre Road
Scoresby VIC 3179
Telephone: 03 8756 7888
Facsimile: 03 8756 7907

Service and Spare Parts

Advantage Appliances
Telephone: 03 9874 4222
Facsimile: 03 9874 6917

QUEENSLAND

State Office and Showroom*

148 Robinson Road - East
Geebung
QLD 4034
Telephone: 07 3259 2555
Facsimile: 07 3265 6933

Service and Spare Parts

Endeavour Appliances
Telephone: 07 3872 7444
Facsimile: 07 3852 2465

Platinum Appliance Service

Telephone: 07 3862 1154
Facsimile: 07 3862 1114

Roshad (Gold Coast)

Telephone: 07 5535 7044
Facsimile: 07 5535 7407

SOUTH AUSTRALIA & NORTHERN TERRITORY

Agent and Sales Office

S C Lighting & Electrical Supplies
47 North Terrace
Hackney SA 5069
Telephone: 08 8362 4599
Facsimile: 08 8362 4591

Service and Spare Parts

Prestige Appliance Repair Centre
Telephone: 08 8352 2022
Facsimile: 08 8352 3044

WESTERN AUSTRALIA

1 Alvan Street
SUBIACO WA 6008

Telephone: 08 9382 1611
Facsimile: 08 9382 1622

Service and Spare Parts

Metropolitan Appliance Repairs
Telephone: 08 9330 1724
Facsimile: 08 9317 1296

TASMANIA

Agent and Sales Office

Mark Pearce Agencies
23 Tranmere Road
Howrah TAS 7018
Tel/Fax: 03 6247 9215

Service and Spare Parts

Electrical Equipment Service (Launceston)
Telephone: 03 6339 3873
Facsimile: 03 6339 4588

Baldocks Appliance Service (Hobart)

Telephone: 03 6234 5995
Facsimile: 03 6234 8134

BLANCO CUSTOMER SERVICE 1300 739 033

Website: www.meappliances.com.au

* Showrooms open six days a week

Rating plate of the product

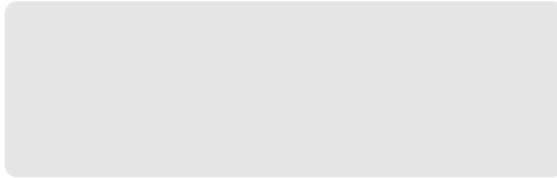

Dis. S506_569 -I/C-
Cod. 099217009930
Rev. 0 del 04/07



Free Manuals Download Website

<http://myh66.com>

<http://usermanuals.us>

<http://www.somanuals.com>

<http://www.4manuals.cc>

<http://www.manual-lib.com>

<http://www.404manual.com>

<http://www.luxmanual.com>

<http://aubethermostatmanual.com>

Golf course search by state

<http://golfingnear.com>

Email search by domain

<http://emailbydomain.com>

Auto manuals search

<http://auto.somanuals.com>

TV manuals search

<http://tv.somanuals.com>