



## **Cisco IP Phone 7960 and 7940 Series User Guide**

### **Corporate Headquarters**

Cisco Systems, Inc.  
170 West Tasman Drive  
San Jose, CA 95134-1706  
USA

<http://www.cisco.com>

Tel: 408 526-4000  
800 553-NETS (6387)

Fax: 408 526-4100

Customer Order Number: DOC-7810182=  
Text Part Number: 78-10182-08



THE SPECIFICATIONS AND INFORMATION REGARDING THE PRODUCTS IN THIS MANUAL ARE SUBJECT TO CHANGE WITHOUT NOTICE. ALL STATEMENTS, INFORMATION, AND RECOMMENDATIONS IN THIS MANUAL ARE BELIEVED TO BE ACCURATE BUT ARE PRESENTED WITHOUT WARRANTY OF ANY KIND, EXPRESS OR IMPLIED. USERS MUST TAKE FULL RESPONSIBILITY FOR THEIR APPLICATION OF ANY PRODUCTS.

THE SOFTWARE LICENSE AND LIMITED WARRANTY FOR THE ACCOMPANYING PRODUCT ARE SET FORTH IN THE INFORMATION PACKET THAT SHIPPED WITH THE PRODUCT AND ARE INCORPORATED HEREIN BY THIS REFERENCE. IF YOU ARE UNABLE TO LOCATE THE SOFTWARE LICENSE OR LIMITED WARRANTY, CONTACT YOUR CISCO REPRESENTATIVE FOR A COPY.

The following information is for FCC compliance of Class A devices: This equipment has been tested and found to comply with the limits for a Class A digital device, pursuant to part 15 of the FCC rules. These limits are designed to provide reasonable protection against harmful interference when the equipment is operated in a commercial environment. This equipment generates, uses, and can radiate radio-frequency energy and, if not installed and used in accordance with the instruction manual, may cause harmful interference to radio communications. Operation of this equipment in a residential area is likely to cause harmful interference, in which case users will be required to correct the interference at their own expense.

The following information is for FCC compliance of Class B devices: The equipment described in this manual generates and may radiate radio-frequency energy. If it is not installed in accordance with Cisco's installation instructions, it may cause interference with radio and television reception. This equipment has been tested and found to comply with the limits for a Class B digital device in accordance with the specifications in part 15 of the FCC rules. These specifications are designed to provide reasonable protection against such interference in a residential installation. However, there is no guarantee that interference will not occur in a particular installation.

Modifying the equipment without Cisco's written authorization may result in the equipment no longer complying with FCC requirements for Class A or Class B digital devices. In that event, your right to use the equipment may be limited by FCC regulations, and you may be required to correct any interference to radio or television communications at your own expense.

You can determine whether your equipment is causing interference by turning it off. If the interference stops, it was probably caused by the Cisco equipment or one of its peripheral devices. If the equipment causes interference to radio or television reception, try to correct the interference by using one or more of the following measures:

- Turn the television or radio antenna until the interference stops.
- Move the equipment to one side or the other of the television or radio.
- Move the equipment farther away from the television or radio.
- Plug the equipment into an outlet that is on a different circuit from the television or radio. (That is, make certain the equipment and the television or radio are on circuits controlled by different circuit breakers or fuses.)

Modifications to this product not authorized by Cisco Systems, Inc. could void the FCC approval and negate your authority to operate the product.

The Cisco implementation of TCP header compression is an adaptation of a program developed by the University of California, Berkeley (UCB) as part of UCB's public domain version of the UNIX operating system. All rights reserved. Copyright © 1981, Regents of the University of California.

NOTWITHSTANDING ANY OTHER WARRANTY HEREIN, ALL DOCUMENT FILES AND SOFTWARE OF THESE SUPPLIERS ARE PROVIDED "AS IS" WITH ALL FAULTS. CISCO AND THE ABOVE-NAMED SUPPLIERS DISCLAIM ALL WARRANTIES, EXPRESSED OR IMPLIED, INCLUDING, WITHOUT LIMITATION, THOSE OF MERCHANTABILITY, FITNESS FOR A PARTICULAR PURPOSE AND NONINFRINGEMENT OR ARISING FROM A COURSE OF DEALING, USAGE, OR TRADE PRACTICE.

IN NO EVENT SHALL CISCO OR ITS SUPPLIERS BE LIABLE FOR ANY INDIRECT, SPECIAL, CONSEQUENTIAL, OR INCIDENTAL DAMAGES, INCLUDING, WITHOUT LIMITATION, LOST PROFITS OR LOSS OR DAMAGE TO DATA ARISING OUT OF THE USE OR INABILITY TO USE THIS MANUAL, EVEN IF CISCO OR ITS SUPPLIERS HAVE BEEN ADVISED OF THE POSSIBILITY OF SUCH DAMAGES.

CCIP, the Cisco Arrow logo, the Cisco *Powered* Network mark, the Cisco Systems Verified logo, Cisco Unity, Follow Me Browsing, FormShare, iQ Breakthrough, iQ Expertise, iQ FastTrack, the iQ Logo, iQ Net Readiness Scorecard, Networking Academy, ScriptShare, SMARTnet, TransPath, and Voice LAN are trademarks of Cisco Systems, Inc.; Changing the Way We Work, Live, Play, and Learn, Discover All That's Possible, The Fastest Way to Increase Your Internet Quotient, and iQuick Study are service marks of Cisco Systems, Inc.; and Aironet, ASIST, BPX, Catalyst, CCDA, CCDP, CCIE, CCNA, CCNP, Cisco, the Cisco Certified Internetwork Expert logo, Cisco IOS, the Cisco IOS logo, Cisco Press, Cisco Systems, Cisco Systems Capital, the Cisco Systems logo, Empowering the Internet Generation, Enterprise/Solver, EtherChannel, EtherSwitch, Fast Step, GigaStack, Internet Quotient, IOS, IP/TV, LightStream, MGX, MICA, the Networkers logo, Network Registrar, *Packet*, PIX, Post-Routing, Pre-Routing, RateMUX, Registrar, SlideCast, StrataView Plus, Stratm, SwitchProbe, TeleRouter, and VCO are registered trademarks of Cisco Systems, Inc. and/or its affiliates in the U.S. and certain other countries.

All other trademarks mentioned in this document or Web site are the property of their respective owners. The use of the word partner does not imply a partnership relationship between Cisco and any other company. (0208R)

*Cisco IP Phone 7960 and 7940 Series User Guide*

Copyright © 2000-2002, Cisco Systems, Inc.

All rights reserved.





## **Preface** xi

About this Guide xi

Related Documentation xii

Obtaining Documentation xiii

World Wide Web xiii

Documentation CD-ROM xiii

Ordering Documentation xiii

Documentation Feedback xiv

Obtaining Technical Assistance xiv

Cisco.com xiv

Technical Assistance Center xv

Cisco TAC Web Site xv

Cisco TAC Escalation Center xvi

Document Conventions xvii

---

## **CHAPTER 1**

### **Introducing Your Cisco IP Phone** 1-1

Connecting Your Cisco IP Phone 1-2

Auto-Registering Your Phone Using TAPS 1-5

A Road Map to Your Cisco IP Phone 1-6

Using the Feature Buttons 1-10

Navigating on Your Phone 1-11

Using the Handset, Headset, and Speakerphone 1-12

Using the Handset 1-12

Adjusting the Handset Rest 1-12

- Using the Speakerphone 1-14
- Using the Headset 1-14
- Customizing Your Phone From the User Options Web Pages 1-15
  - Logging In to the User Options Web Pages 1-16
  - Changing the Default Language for the User Options Web Pages 1-17
  - Establishing Cisco IP Phone Services 1-18
    - Subscribing to Services 1-19
    - How to Change or End Subscriptions 1-20

---

**CHAPTER 2**

**Customizing Phone Settings 2-1**

- Adjusting the Handset, Speakerphone, and Headset Volume 2-1
- Adjusting the Ringer Volume 2-2
- Personalizing the Ringer Sound 2-3
- Adjusting the Message Waiting Indicator Light 2-4
- Changing the LCD Screen Contrast 2-5
- Changing the Language for the Phone LCD Screen 2-6

---

**CHAPTER 3**

**Placing a Call and Other Basic Phone Tasks 3-1**

- Making Telephone Calls 3-1
  - Placing a Call 3-2
  - Answering a Call 3-4
  - Ending a Call 3-4
  - Muting a Call 3-5
  - Putting a Call on Hold 3-6
  - Transferring a Call to Another Extension 3-7
  - Redialing the Last Number Dialed 3-8
  - How to Get Notified When a Busy Line is Available Using Cisco Call Back 3-8
  - Storing and Retrieving a Call Using Call Park 3-9

Answering Calls on Another Extension Using Call Pickup	3-10
How to Pick Up Calls Within Your Group	3-11
How to Pick Up Calls Outside of Your Group	3-11
Using Speed Dial	3-12
Forwarding Calls to Another Extension	3-14
Setting Up Call Forwarding on Your Phone	3-14
Setting Up Call Forwarding When Not at Your Phone	3-15
Canceling Call Forwarding	3-16
Making Conference Calls	3-17
Placing a Conference Call	3-18
Using Meet-Me Conferences	3-18
Establishing a Meet-Me Conference	3-19
Joining a Meet-Me Conference	3-19
Conferencing by Barging in on Established Conversations	3-20
Using Voice Mail	3-21
Viewing and Dialing from the Phone Logs	3-21
Searching and Dialing from the Phone Directory	3-23

**CHAPTER 4****Logging Into Your Extension from Any Phone Using the Cisco CallManager Extension Mobility Feature** 4-1

Logging in to Cisco CallManager Extension Mobility	4-2
Logging Out of Cisco CallManager Extension Mobility	4-4
Changing Your Cisco CallManager Extension Mobility PIN	4-5

**CHAPTER 5****Managing Your Contacts** 5-1

Managing Your Personal Address Book	5-2
Subscribing to Personal Address Book	5-2
Creating a New Address Book Entry on the Web	5-4
Searching for or Editing a Personal Address Book Entry on the Web	5-5

- Searching Personal Address Book Entries on Your Phone 5-6
- Editing a Personal Address Book Entry on Your Phone 5-7
- Deleting an Address Book Entry on the Web 5-8
- Dialing a Personal Address Book Entry 5-9
- Using the Cisco IP Phone Address Book Synchronizer 5-9
  - Installing the Cisco IP Phone Address Book Synchronizer 5-9
  - Configuring the Cisco IP Phone Address Book Synchronizer 5-11
- Using Fast Dials 5-12
  - Subscribing to Personal Fast Dials 5-12
  - Assigning Fast Dial Codes to Phone Numbers on the Web 5-13
  - Removing Personal Fast Dials Entries on the Web 5-15
  - Creating a Personal Fast Dials Entry for a Number in Your Personal Address Book on Your Phone 5-16
  - Creating a Personal Fast Dial Entry for a Non-Address Book Directory Number on Your Phone 5-17
  - Removing a Personal Fast Dials Entry on Your Phone 5-19
  - Dialing a Personal Fast Dials Entry 5-20

**CHAPTER 6**

**Using the Cisco IP Phone 7914 Expansion Module 6-1**

- Understanding Expansion Module Features 6-2
- How to Get More Information 6-3

**APPENDIX A**

**FAQ A-1**

- How do I access voice mail? A-2
- How do I set speed dials? A-2
- How do I list my missed calls? A-2
- I don't see a Hold button—how do I put someone on hold? A-3
- How do I change the contrast on the phone LCD screen? A-3



How do I change the settings for my Cisco CallManager Extension Mobility line? **A-3**

How do I forward calls? **A-4**

How do I store numbers of friends and colleagues that I want to call often? **A-4**

I've used up all my speed dial lines, can I add more? **A-5**

If I cannot answer a call that I have forwarded to another number, will the call get re-routed to my voice mail system? **A-5**

Can I use call forwarding to send my calls directly to voice mail, without ringing my desk top phone? **A-6**

Why don't I get a dial tone after dialing an access code? **A-6**

---

**APPENDIX B****Safety Notices B-1**

---

**APPENDIX C****Troubleshooting Your Phone C-1**

Accessing Network Configuration Data **C-1**

Accessing Status Data **C-2**

Troubleshooting Cisco CallManager Extension Mobility **C-3**

Using the Quality Reporting Tool **C-4**

---

**INDEX**





# Preface

---

This preface covers these topics:

- [About this Guide, page xi](#)
- [Related Documentation, page xii](#)
- [Obtaining Documentation, page xiii](#)
- [Obtaining Technical Assistance, page xiv](#)
- [Document Conventions, page xvii](#)

## About this Guide

Use this guide to perform basic and advanced phone tasks using a phone in the Cisco IP Phone 7960 or 7940 series running in a Cisco CallManager phone system.

This book is organized in the following way:

Chapter	Contents
<a href="#">Chapter 1, “Introducing Your Cisco IP Phone”</a>	Instructions on installing your phone, an overview of your phone, information about the User Options web pages.
<a href="#">Chapter 2, “Customizing Phone Settings”</a>	Information about configuring volume, contrast, and other phone settings.
<a href="#">Chapter 3, “Placing a Call and Other Basic Phone Tasks”</a>	Procedures about how to perform basic phone tasks, like making a call and accessing voice mail.

Chapter	Contents
<a href="#">Chapter 4, “Logging Into Your Extension from Any Phone Using the Cisco CallManager Extension Mobility Feature”</a>	In-depth information about Cisco CallManager Extension Mobility.
<a href="#">Chapter 5, “Managing Your Contacts”</a>	Information and procedures for managing your contacts on your phone and on the web using the Personal Directories, Personal Address Book, Fast Dials, and more.
<a href="#">Chapter 6, “Using the Cisco IP Phone 7914 Expansion Module”</a>	Overview of using the Cisco 7914 Expansion Module with your Cisco IP Phone
<a href="#">Appendix A, “FAQ”</a>	Contains Frequently Asked Questions (FAQ) about your Cisco IP Phone.
<a href="#">Appendix B, “Safety Notices”</a>	Lists safety information about your phone.
<a href="#">Appendix C, “Troubleshooting Your Phone”</a>	Error codes and their meanings and ways of getting status and configuration data about your phone.

## Related Documentation

For more information, refer to these documents:

- *At a Glance Cisco IP Phone 7960 and 7940 Series*—This booklet includes basic installation instructions and ships in the box with each phone.
- *Quick Reference Cisco IP Phone 7960/7940 Series*—This wallet card contains basic instructions and can be ordered separately.
- *Cisco IP Phone 7914 Expansion Module Quick Start Guide*—This guide includes user instructions and installation information for the Cisco IP Phone 7914 Expansion Module.
- *Regulatory Compliance and Safety Information for the Cisco IP Phone 7960, 7940, and 7910 Series*—This document provides international agency compliance, safety, and statutory information for Cisco IP Phone models in the 7960 series, 7940 series, and 7910 series.

# Obtaining Documentation

These sections explain how to obtain documentation from Cisco Systems.

## World Wide Web

You can access the most current Cisco documentation on the World Wide Web at this URL:

<http://www.cisco.com>

Translated documentation is available at this URL:

[http://www.cisco.com/public/countries\\_languages.shtml](http://www.cisco.com/public/countries_languages.shtml)

## Documentation CD-ROM

Cisco documentation and additional literature are available in a Cisco Documentation CD-ROM package. The Documentation CD-ROM is updated monthly and may be more current than printed documentation. The CD-ROM package is available as a single unit or through an annual subscription.

## Ordering Documentation

You can order Cisco documentation in these ways:

- Registered Cisco.com users (Cisco direct customers) can order Cisco product documentation from the Networking Products MarketPlace:  
[http://www.cisco.com/cgi-bin/order/order\\_root.pl](http://www.cisco.com/cgi-bin/order/order_root.pl)
- Registered Cisco.com users can order the Documentation CD-ROM through the online Subscription Store:  
<http://www.cisco.com/go/subscription>
- Nonregistered Cisco.com users can order documentation through a local account representative by calling Cisco Systems Corporate Headquarters (California, U.S.A.) at 408 526-7208 or, elsewhere in North America, by calling 800 553-NETS (6387).

## Documentation Feedback

You can submit comments electronically on Cisco.com. In the Cisco Documentation home page, click the **Fax** or **Email** option in the “Leave Feedback” section at the bottom of the page.

You can e-mail your comments to [bug-doc@cisco.com](mailto:bug-doc@cisco.com).

You can submit your comments by mail by using the response card behind the front cover of your document or by writing to the following address:

Cisco Systems  
Attn: Document Resource Connection  
170 West Tasman Drive  
San Jose, CA 95134-9883

We appreciate your comments.

## Obtaining Technical Assistance

Cisco provides Cisco.com as a starting point for all technical assistance. Customers and partners can obtain online documentation, troubleshooting tips, and sample configurations from online tools by using the Cisco Technical Assistance Center (TAC) Web Site. Cisco.com registered users have complete access to the technical support resources on the Cisco TAC Web Site.

## Cisco.com

Cisco.com is the foundation of a suite of interactive, networked services that provides immediate, open access to Cisco information, networking solutions, services, programs, and resources at any time, from anywhere in the world.

Cisco.com is a highly integrated Internet application and a powerful, easy-to-use tool that provides a broad range of features and services to help you with these tasks:

- Streamline business processes and improve productivity
- Resolve technical issues with online support
- Download and test software packages

- Order Cisco learning materials and merchandise
- Register for online skill assessment, training, and certification programs

If you want to obtain customized information and service, you can self-register on Cisco.com. To access Cisco.com, go to this URL:

<http://www.cisco.com>

## Technical Assistance Center

The Cisco Technical Assistance Center (TAC) is available to all customers who need technical assistance with a Cisco product, technology, or solution. Two levels of support are available: the Cisco TAC Web Site and the Cisco TAC Escalation Center.

Cisco TAC inquiries are categorized according to the urgency of the issue:

- Priority level 4 (P4)—You need information or assistance concerning Cisco product capabilities, product installation, or basic product configuration.
- Priority level 3 (P3)—Your network performance is degraded. Network functionality is noticeably impaired, but most business operations continue.
- Priority level 2 (P2)—Your production network is severely degraded, affecting significant aspects of business operations. No workaround is available.
- Priority level 1 (P1)—Your production network is down, and a critical impact to business operations will occur if service is not restored quickly. No workaround is available.

The Cisco TAC resource that you choose is based on the priority of the problem and the conditions of service contracts, when applicable.

## Cisco TAC Web Site

You can use the Cisco TAC Web Site to resolve P3 and P4 issues yourself, saving both cost and time. The site provides around-the-clock access to online tools, knowledge bases, and software. To access the Cisco TAC Web Site, go to this URL:

<http://www.cisco.com/tac>

All customers, partners, and resellers who have a valid Cisco service contract have complete access to the technical support resources on the Cisco TAC Web Site. The Cisco TAC Web Site requires a Cisco.com login ID and password. If you have a valid service contract but do not have a login ID or password, go to this URL to register:

<http://www.cisco.com/register/>

If you are a Cisco.com registered user, and you cannot resolve your technical issues by using the Cisco TAC Web Site, you can open a case online by using the TAC Case Open tool at this URL:

<http://www.cisco.com/tac/caseopen>

If you have Internet access, we recommend that you open P3 and P4 cases through the Cisco TAC Web Site.

## Cisco TAC Escalation Center

The Cisco TAC Escalation Center addresses priority level 1 or priority level 2 issues. These classifications are assigned when severe network degradation significantly impacts business operations. When you contact the TAC Escalation Center with a P1 or P2 problem, a Cisco TAC engineer automatically opens a case.

To obtain a directory of toll-free Cisco TAC telephone numbers for your country, go to this URL:

<http://www.cisco.com/warp/public/687/Directory/DirTAC.shtml>

Before calling, please check with your network operations center to determine the level of Cisco support services to which your company is entitled: for example, SMARTnet, SMARTnet Onsite, or Network Supported Accounts (NSA). When you call the center, please have available your service agreement number and your product serial number.



# Document Conventions

This document uses the following conventions:

Convention	Description
<b>boldface font</b>	Commands and keywords are in <b>boldface</b> .
<i>italic font</i>	Arguments for which you supply values are in <i>italics</i> .
[ ]	Elements in square brackets are optional.
{ x   y   z }	Alternative keywords are grouped in braces and separated by vertical bars.
[ x   y   z ]	Optional alternative keywords are grouped in brackets and separated by vertical bars.
string	A nonquoted set of characters. Do not use quotation marks around the string or the string will include the quotation marks.
screen font	Terminal sessions and information the system displays are in screen font.
<b>boldface screen font</b>	Information you must enter is in <b>boldface screen font</b> .
<i>italic screen font</i>	Arguments for which you supply values are in <i>italic screen font</i> .
^	The symbol ^ represents the key labeled Control—for example, the key combination ^D in a screen display means hold down the Control key while you press the D key.
< >	Nonprinting characters, such as passwords are in angle brackets.



## Note

Means *reader take note*. Notes contain helpful suggestions or references to material not covered in the publication.

**Caution**

Means *reader be careful*. In this situation, you might do something that could result in equipment damage or loss of data.

Warnings use the following conventions:

**Warning**

This warning symbol means *danger*. You are in a situation that could cause bodily injury. Before you work on any equipment, be aware of the hazards involved with electrical circuitry and be familiar with standard practices for preventing accidents. To see translations of the warnings that appear in this publication, refer to the *Regulatory Compliance and Safety Information* document that accompanied this device.

**Waarschuwing**

Dit waarschuwingssymbool betekent gevaar. U verkeert in een situatie die lichamelijk letsel kan veroorzaken. Voordat u aan enige apparatuur gaat werken, dient u zich bewust te zijn van de bij elektrische schakelingen betrokken risico's en dient u op de hoogte te zijn van standaard maatregelen om ongelukken te voorkomen. Voor vertalingen van de waarschuwingen die in deze publicatie verschijnen, kunt u het document *Regulatory Compliance and Safety Information* (Informatie over naleving van veiligheids- en andere voorschriften) raadplegen dat bij dit toestel is ingesloten.

**Varoitus**

Tämä varoitusmerkki merkitsee vaaraa. Olet tilanteessa, joka voi johtaa ruumiinvammaan. Ennen kuin työskentelet minkään laitteiston parissa, ota selvää sähkökytkentöihin liittyvistä vaaroista ja tavanomaisista onnettomuuksien ehkäisykeinoista. Tässä julkaisussa esiintyvien varoitusten käännökset löydät laitteen mukana olevasta *Regulatory Compliance and Safety Information* -kirjasesta (määräysten noudattaminen ja tietoa turvallisuudesta).

- Attention** Ce symbole d'avertissement indique un danger. Vous vous trouvez dans une situation pouvant causer des blessures ou des dommages corporels. Avant de travailler sur un équipement, soyez conscient des dangers posés par les circuits électriques et familiarisez-vous avec les procédures couramment utilisées pour éviter les accidents. Pour prendre connaissance des traductions d'avertissements figurant dans cette publication, consultez le document *Regulatory Compliance and Safety Information* (Conformité aux règlements et consignes de sécurité) qui accompagne cet appareil.
- Warnung** Dieses Warnsymbol bedeutet Gefahr. Sie befinden sich in einer Situation, die zu einer Körperverletzung führen könnte. Bevor Sie mit der Arbeit an irgendeinem Gerät beginnen, seien Sie sich der mit elektrischen Stromkreisen verbundenen Gefahren und der Standardpraktiken zur Vermeidung von Unfällen bewußt. Übersetzungen der in dieser Veröffentlichung enthaltenen Warnhinweise finden Sie im Dokument *Regulatory Compliance and Safety Information* (Informationen zu behördlichen Vorschriften und Sicherheit), das zusammen mit diesem Gerät geliefert wurde.
- Avvertenza** Questo simbolo di avvertenza indica un pericolo. La situazione potrebbe causare infortuni alle persone. Prima di lavorare su qualsiasi apparecchiatura, occorre conoscere i pericoli relativi ai circuiti elettrici ed essere al corrente delle pratiche standard per la prevenzione di incidenti. La traduzione delle avvertenze riportate in questa pubblicazione si trova nel documento *Regulatory Compliance and Safety Information* (Conformità alle norme e informazioni sulla sicurezza) che accompagna questo dispositivo.
- Advarsel** Dette varselsymbolet betyr fare. Du befinner deg i en situasjon som kan føre til personskade. Før du utfører arbeid på utstyr, må du være oppmerksom på de faremomentene som elektriske kretser innebærer, samt gjøre deg kjent med vanlig praksis når det gjelder å unngå ulykker. Hvis du vil se oversettelser av de advarslene som finnes i denne publikasjonen, kan du se i dokumentet *Regulatory Compliance and Safety Information* (Overholdelse av forskrifter og sikkerhetsinformasjon) som ble levert med denne enheten.

- Aviso** Este símbolo de aviso indica perigo. Encontra-se numa situação que lhe poderá causar danos físicos. Antes de começar a trabalhar com qualquer equipamento, familiarize-se com os perigos relacionados com circuitos eléctricos, e com quaisquer práticas comuns que possam prevenir possíveis acidentes. Para ver as traduções dos avisos que constam desta publicação, consulte o documento *Regulatory Compliance and Safety Information* (Informação de Segurança e Disposições Reguladoras) que acompanha este dispositivo.
- ¡Advertencia!** Este símbolo de aviso significa peligro. Existe riesgo para su integridad física. Antes de manipular cualquier equipo, considerar los riesgos que entraña la corriente eléctrica y familiarizarse con los procedimientos estándar de prevención de accidentes. Para ver una traducción de las advertencias que aparecen en esta publicación, consultar el documento titulado *Regulatory Compliance and Safety Information* (Información sobre seguridad y conformidad con las disposiciones reglamentarias) que se acompaña con este dispositivo.
- Varning!** Denna varningssymbol signalerar fara. Du befinner dig i en situation som kan leda till personskada. Innan du utför arbete på någon utrustning måste du vara medveten om farorna med elkretsar och känna till vanligt förfarande för att förebygga skador. Se förklaringar av de varningar som förkommer i denna publikation i dokumentet *Regulatory Compliance and Safety Information* (Efterrättelse av föreskrifter och säkerhetsinformation), vilket medföljer denna anordning.
-



# Introducing Your Cisco IP Phone

---

A Cisco IP Phone is a full-feature telephone that provides voice communication over the same data network that your computer uses. This phone functions much like a traditional analog phone, allowing you to place and receive telephone calls. It also supports features that you have come to expect from a telephone—such as speed dialing, redial, call transfer, conference calling, and voice mail access.

Your Cisco IP Phone offers features that might surprise you. Because it is part of an IP network, your Cisco IP Phone can provide not only telephony services, but data services, too—including up-to-the-minute information and services from the network. In a nutshell, your Cisco IP Phone provides a whole range of communication features that you could not expect from a traditional telephone.

This guide helps you learn to use the various features and services available on your phone. Not all of the features described in this book are available by default—your administrator may not add them for you. You access some phone features and services on the phone itself, while you customize others on a convenient web page. For information about the User Options web page, see [Customizing Your Phone From the User Options Web Pages, page 1-15](#).

This chapter contains the following sections:

- [Connecting Your Cisco IP Phone, page 1-2](#)
- [A Road Map to Your Cisco IP Phone, page 1-6](#)
- [Using the Feature Buttons, page 1-10](#)
- [Navigating on Your Phone, page 1-11](#)
- [Using the Handset, Headset, and Speakerphone, page 1-12](#)
- [Customizing Your Phone From the User Options Web Pages, page 1-15](#)

# Connecting Your Cisco IP Phone

Chances are, your system administrator or a technician will connect your new Cisco IP Phone to the corporate IP telephony network. If that is not the case, connecting your phone is easy.

Follow the steps below. Refer to to locate ports on the back of your phone.

## Before You Begin

Verify that your system administrator is ready for you to connect your Cisco IP Phone to the network.



### Warning

---

**Be sure to read [Appendix B, “Safety Notices,”](#) before connecting or using your phone.**

---

### Step 1

Connect your Cisco IP Phone to the corporate IP telephony network. You can do this in one of two ways, depending on how your workspace is set up. See your system administrator if you are not sure which method to choose:

- **Direct network connection**—For this method, you need at least one available Ethernet port in your workspace. Use the Ethernet cable included with your phone to connect the network port on the back of your phone to the Ethernet port in your workspace.
- **Shared network connection**—Use this method if you have a single Ethernet port in your workspace with your desktop computer already connected to it. First, disconnect the Ethernet cable from the computer and attach it to the network port on the back of your phone. Next, use the Ethernet cable included with your phone to connect the access port on the back of your phone to your desktop computer. Your Cisco IP Phone now shares a network connection with your computer.

### Step 2

Connect the handset to the handset port. Ensure that the end of the cord with the longer uncoiled section is connected to the body of the phone.

- Step 3** If your system administrator delivered your Cisco IP Phone with a power supply, connect the power supply plug to the DC48V AC adapter port on the back of the phone.
- If your system administrator delivered your phone *without* a power supply, your phone probably receives power through the Ethernet connection.
- Step 4** Use the power cable to connect the power supply to a standard power outlet in your workspace.
- Step 5** To adjust the footstand height, release the footstand by pressing the footstand adjustment knob and gently pull the footstand away from the body of the phone.
- See the [“Adjusting the Handset Rest” section on page 1-12](#) for information on adjusting the handset rest to make sure the receiver will sit securely in the cradle.
- 

Once you connect the Cisco IP Phone to its power source, a start-up process begins. After several minutes, the phone’s LCD screen displays a neutral “ready” screen. The details on your screen might vary, but a ready screen typically displays the date and time, your extension number, and available soft keys. Startup is complete and your phone is ready to use.

**Tip**

Soft keys point to feature options displayed along the bottom of your LCD screen. Soft keys are flexible—they change depending on the status of your phone. For example, you can see one set of soft key options when you pick up the handset, and another set when the phone is not in use.

---

Table 1-1 Cisco IP Phone cable connections

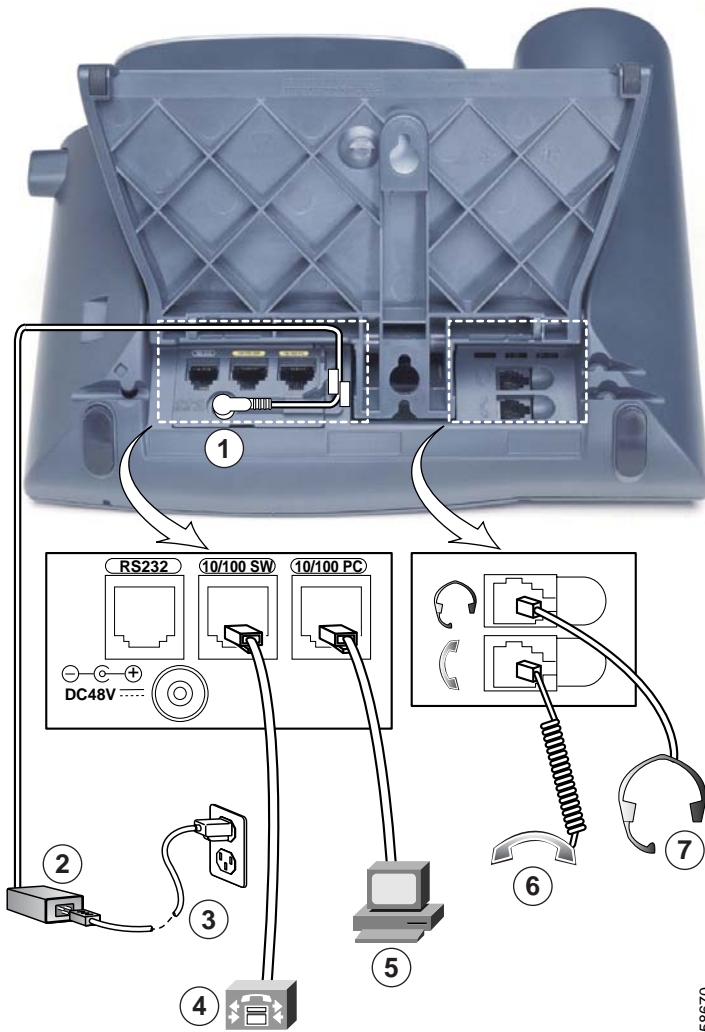

588670

1	DC adapter port (DC48V)	5	Access port (10/100 PC)
2	Power supply with AC adapter port plug	6	Handset port
3	Power cable with wall socket plug	7	Headset port
4	Network port (10/100 SW)		



**Related Topics**

- [Auto-Registering Your Phone Using TAPS, page 1-5](#)
- [A Road Map to Your Cisco IP Phone, page 1-6](#)
- [Using the Handset, Headset, and Speakerphone, page 1-12](#)

# Auto-Registering Your Phone Using TAPS

Your administrator may ask you to auto-register your Cisco IP Phone using TAPS, the Tool for Auto-Registered Phones Support. TAPS might be used either for a new phone or to replace an existing phone.

**Note**

---

You should follow this procedure only if your phone administrator asks you to.

---

**Procedure**

---

**Step 1** If the phone is not already installed, follow the installation instructions available in the [“Connecting Your Cisco IP Phone”](#) section on page 1-2.

After you plug the phone into a port, the phone automatically registers and displays a number.

**Step 2** Dial the TAPS extension provided by your system administrator.

**Step 3** A voice prompt asks you to select the language that you want to use. Choose appropriately.

**Step 4** Dial your personal extension number (provided by your system administrator), then press the # key.

**Note**

---

You may be instructed to enter the complete telephone number (including area code).

---

- Step 5** To confirm, enter your personal extension number again, followed by the # key. The phone displays a confirmation message.
- Step 6** Hang up the phone. The phone resets and displays your extension number.
- 

**Related Topics**

- [Connecting Your Cisco IP Phone, page 1-2](#)
- [A Road Map to Your Cisco IP Phone, page 1-6](#)
- [Using the Feature Buttons, page 1-10](#)
- [Navigating on Your Phone, page 1-11](#)
- [Using the Handset, Headset, and Speakerphone, page 1-12](#)

## A Road Map to Your Cisco IP Phone







Refer to the following illustrations and table to identify the buttons and parts on your Cisco IP Phone and to find a description of related features.





Figure 1-1 Cisco IP Phone 7960



Figure 1-2 Cisco IP Phone 7940



1	Handset with indicator light	Functions like a traditional handset. The light strip at the top of the handset blinks when the phone rings and can be set to remain lit when you receive a voice mail message.  For more information on working with the handset, refer to the <a href="#">“Adjusting the Handset, Speakerphone, and Headset Volume”</a> section on page 2-1.
2	LCD screen	Displays features such as the time, date, your phone number, caller ID, line/call status and softkey tabs.
3	Cisco IP Phone model type	Indicates your Cisco IP Phone model.
4	Line or speed dial button 	Opens a new line or speed dials the number on the LCD screen. Phones in the Cisco IP Phone 7960 series have six line or speed dial buttons and phones in the 7940 series have two.
5	Footstand adjustment	Allows you to adjust the angle of the phone base.
6	Directories button 	Provides access to call histories and directories (see the <a href="#">“Using the Feature Buttons”</a> section on page 1-10.)
7	? button 	Displays help on your LCD screen for a phone button or function (see the <a href="#">“Using the Feature Buttons”</a> section on page 1-10.)
8	Settings button 	Provides access to phone settings such as contrast and ring sound, network configuration, and status information (see the <a href="#">“Using the Feature Buttons”</a> section on page 1-10.)
9	Speaker button 	Toggles the speaker on or off.
10	Mute button 	Toggles the mute on or off.
11	Headset button 	Toggles the headset on or off.  For more information on working with the headset, refer to the <a href="#">“Using the Headset”</a> section on page 1-14.

12	Volume button 	Increases or decreases volume for the handset, headset, or speakerphone (depending upon which is currently active). Also controls the ringer volume (if the handset is in its cradle), and the LCD screen contrast.  For more information on adjusting the volume, refer to the <a href="#">“Adjusting the Handset, Speakerphone, and Headset Volume”</a> section on page 2-1 and the <a href="#">“Adjusting the Ringer Volume”</a> section on page 2-2.
13	Services button 	Provides access to any available phone services (see the <a href="#">“Using the Feature Buttons”</a> section on page 1-10.)
14	Messages button 	Provides access to a message system, if available (see the <a href="#">“Using the Feature Buttons”</a> section on page 1-10.)
15	Navigation button 	Enables you to scroll through text and select features displayed on the LCD screen (see the <a href="#">“Navigating on Your Phone”</a> section on page 1-11.).
16	Dial pad	Works exactly like the dial pad on a traditional telephone.
17	Softkeys	Enable you to engage any of the functions displayed on the corresponding LCD screen tabs. Softkeys point to feature options displayed along the bottom of your LCD screen. Softkeys change depending on the status of your phone. For example, you can see one set of softkey options when you pick up the handset, and another set when the phone is not in use.

### Related Topics

- [Using the Feature Buttons](#), page 1-10
- [Navigating on Your Phone](#), page 1-11

# Using the Feature Buttons

Your Cisco IP Phone has five feature buttons:

- **Services** button—Displays services on your phone’s LCD screen. These are services to which you have already subscribed using the Cisco CallManager User Options web pages. Your system administrator determines the services that are available to you. For more information, see the [“Establishing Cisco IP Phone Services”](#) section on page 1-18.
- **Messages** button—Provides access to your voice mail message system. For more information, see the [“Using Voice Mail”](#) section on page 3-21.
- **Settings** button—Displays network settings on your phone’s LCD screen, plus options for adjusting your phone’s ringer sound and LCD screen contrast.
- **Directories** button—Displays various directories on your phone’s LCD screen, including missed, received, and placed calls. You can use each of these directories to locate phone numbers and you can dial those numbers from the directories. For more information, see the [“Viewing and Dialing from the Phone Logs”](#) section on page 3-21 and the [“Searching and Dialing from the Phone Directory”](#) section on page 3-23.
- **? button**—Displays helpful information about buttons and features.

For help with:

- A specific button or softkey—Press the ? button once, then press the button or softkey to display information about that button or key.
- A specific feature—First press the **Directories**, **Settings**, or **Services** buttons to display a list of available features. Use the Navigation button to scroll through the list and select a feature. Press the ? button twice quickly to display information about the selected feature.
- The ? button feature itself—Press the ? button twice quickly (without first selecting a feature). This brings up help about using the ? button.
- Viewing network statistics about a call you are actively on—Press the ? button twice quickly during the call.

## Related Topics

- [A Road Map to Your Cisco IP Phone, page 1-6](#)
- [Navigating on Your Phone, page 1-11](#)

- [Personalizing the Ringer Sound, page 2-3](#)
- [Changing the LCD Screen Contrast, page 2-5](#)
- [Accessing Network Configuration Data, page C-1](#)
- [Accessing Status Data, page C-2](#)

## Navigating on Your Phone

Navigating on your Cisco IP Phone is easy. You use the Navigation button, the softkeys, and the key pad to make your selections:

- Softkeys correspond to the option tabs displayed along the bottom of your LCD screen. Softkeys change depending on the status of your phone. For example, you can see one set of softkey options when you pick up the handset, and another set when the phone is not in use.
- The >> softkey allows you to re-position your cursor. The << softkey allows you to delete a character or digit in an entry. Press the << softkey or the **Delete** softkey if you make a mistake or need to edit an entry. The Delete softkey allows you to edit a character or digit—it does not delete the entire entry.
- You can choose menu items on your Cisco IP Phone in more than one way:
  - Using the Navigation button—Press the **Navigation** button (this is the button with the up and down arrows) to select (or highlight) a menu item. Then press the **Select** softkey.
  - Using an Item Number—You can press the number key on your phone’s key pad that corresponds to the item number displayed on the LCD screen. Use this method to select any menu item that has an item number to the left of it
- To enter any letter on your LCD screen, use a corresponding number key. Press the key one or more times to display a particular letter. For example, press the **2** key one time for “a,” twice quickly for “b,” and three times quickly for “c.” After you pause, the cursor automatically advances to allow you to enter the next letter. Press the << softkey if you make a mistake.

**Related Topics**

- [A Road Map to Your Cisco IP Phone, page 1-6](#)
- [Using the Feature Buttons, page 1-10](#)

# Using the Handset, Headset, and Speakerphone

Your Cisco IP Phone works with a handset, headset, or speakerphone.

For information on using each of these, refer to the following sections:

- [Using the Handset, page 1-12](#)
- [Adjusting the Handset Rest, page 1-12](#)
- [Using the Speakerphone, page 1-14](#)
- [Using the Headset, page 1-14](#)

## Using the Handset

The handset on your Cisco IP Phone functions in the same way as a handset on a traditional phone:

- To place and answer calls with the handset, simply lift the handset.
- To hang up, place the handset back in its cradle.
- To switch from the handset to the speakerphone, press the **Speaker** button on the front of your phone during a call, then hang up the handset.

**Related Topics**

- [Adjusting the Handset Rest, page 1-12](#)
- [Adjusting the Handset, Speakerphone, and Headset Volume, page 2-1](#)

## Adjusting the Handset Rest

If you mount your Cisco IP Phone on the wall or use the footstand on the phone, you can adjust the handset rest to ensure the receiver will not slip out of the cradle.

To adjust the handset rest, follow the steps and refer to [Figure 1-3](#).

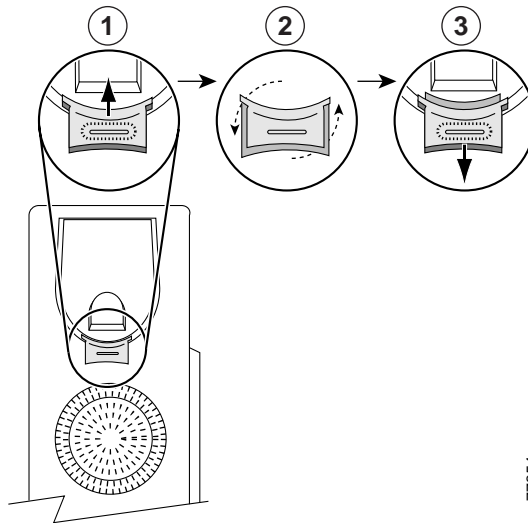

**Figure 1-3 Using the Handset Rest**

77354

<b>1</b>	Set the handset aside and use your thumb and finger to grasp and pull out the square plastic tab in the handset rest.
<b>2</b>	Rotate the tab 180 degrees.
<b>3</b>	Slide the tab back into the handset rest with the extension protruding from the top of the tab.  Replace the handset in the rest. The tab hooks into a slot in the handset to ensure that the handset will not slip out of the rest.

**Related Topics**

- [Using the Handset, page 1-12](#)

## Using the Speakerphone

You can use the speakerphone in conjunction with all of the features on your Cisco IP Phone.

To place and answer calls using the speakerphone, press the **Speaker** button.

To switch from speakerphone to handset during a call, simply lift the handset.

### Related Topics

- [Adjusting the Handset, Speakerphone, and Headset Volume, page 2-1](#)

## Using the Headset

You can use the headset in conjunction with all of the features on your Cisco IP Phone, including the Volume and Mute buttons. Use these buttons to adjust the volume to the ear piece and to mute the speech path from the headset microphone.

To place and answer calls using a headset, plug an approved headset into the back of the phone base and press the **Headset** button on the front of your phone.

Your phone supports four- or six-wire headset jacks. For information about purchasing headsets, see the following URLs:

- <http://cisco.getheadsets.com>
- <http://vxicorp.com/cisco>



### Caution

---

Use only Cisco-approved headsets.

---



### Warning

---

**This product relies on the building's installation for short-circuit (overcurrent) protection. Ensure that a fuse or circuit breaker no larger than 120 VAC, 15A U.S. (240 VAC, 10A international) is used on the phase conductors (all current-carrying conductors).**

---

**Warning**

---

**To avoid electric shock, do not connect safety extra-low voltage (SELV) circuits to telephone-network voltage (TNV) circuits. LAN ports contain SELV circuits, and WAN ports contain TNV circuits. Some LAN and WAN ports both use RJ-45 connectors. Use caution when connecting cables.**

---

on [page 1-4](#) illustrates the headset port and other cable connection ports on your phone.

**Related Topics**

- [Adjusting the Handset, Speakerphone, and Headset Volume, page 2-1](#)

# Customizing Your Phone From the User Options Web Pages

You can use the Cisco CallManager User Options web pages to subscribe to services. Services include web-based information and special phone features.

In addition to subscribing to services, you can use the Cisco CallManager User Options web pages to:

- set up call forwarding rules—[Forwarding Calls to Another Extension, page 3-14](#)
- change the language in which you view phone information—[Changing the Language for the Phone LCD Screen, page 2-6](#)
- specify a policy for the message waiting indicator light on your phone's handset—[Adjusting the Message Waiting Indicator Light, page 2-4](#)
- assign speed dial buttons for your Cisco IP Phone—[Using Speed Dial, page 3-12](#)
- manage personal contacts—, [page 4-5](#)

**Note**

---

If you use the Cisco CallManager Extension Mobility service, changes that you make from the User Options web pages are maintained in your device profile. .

---

You can also get a copy of the documentation available for your phone on the User Options Pages.

This section covers the following topics:

- [Logging In to the User Options Web Pages, page 1-16](#)
- [Changing the Default Language for the User Options Web Pages, page 1-17](#)
- [Establishing Cisco IP Phone Services, page 1-18](#)

## Logging In to the User Options Web Pages

Follow these instructions to log on and to access the main menu.

### Procedure

- 
- Step 1** Use your Web browser to access the URL provided by your system administrator. The Cisco CallManager User Options Log On page appears.
- Step 2** Enter your user ID and your password and click **Log On**. Your user ID and password are provided by your system administrator. The Cisco CallManager User Options Menu page appears.
- Step 3** Select your phone or, if applicable, your Cisco CallManager Extension Mobility device profile from the “Select a device to configure” drop-down list. The menu is context-sensitive and displays options appropriate for the device or device profile that you have selected.
- 

### Related Topics

- [Changing the Default Language for the User Options Web Pages, page 1-17](#)
- [Establishing Cisco IP Phone Services, page 1-18](#)

# Changing the Default Language for the User Options Web Pages

Use this procedure to change the default language (French or English, for example) in which information is displayed on the Cisco CallManager User Options web pages.

If you use the Cisco CallManager Extension Mobility service, follow this procedure to change the default language for both your device profile and your User Options web pages.

To temporarily change the language for the User Options web pages, click the “View page in” drop-down list located at the bottom of each web page. This changes the language displayed for the *current* web session. The next time that you log on, the User Options web pages will display in the default language.

## Before You Begin

Log in to the User Options web page. For information on the User Options web page and how to access it, see the [“Logging In to the User Options Web Pages” section on page 1-16](#).

## Procedure

---

**Step 1** From the User Options main menu, select your phone or, if applicable, your Cisco CallManager Extension Mobility device profile from the **Select a device to configure** drop-down list.

The menu is context-sensitive and displays options appropriate for the device or device profile that you have selected.

**Step 2** The next step depends upon your selection from the **Select a device to configure** drop-down list:

- a. If you selected your phone (and not a device profile), click **Change the Locale for these web pages**.
- b. If you selected a device profile, click **Change the Locale for your device profile(s) and these web pages**.



---

**Note** You will not have access to a device profile unless you use the Cisco CallManager Extension Mobility service.

---

- Step 3** Select the language that you want to use as the default language from the “User Locale” drop-down list and click **Update**.

The language that you have selected now serves as the default language for each of the User Options web pages in the current web session and in future sessions. If you use Cisco CallManager Extension Mobility, the default language will display on the LCD screen the next time you log on to a Cisco IP Phone.

- Step 4** When you are finished, click **Return to the Menu** or **Log Off** at the bottom of the page.
- 

#### Related Topics

- [Changing the Language for the Phone LCD Screen, page 2-6](#)
- [Logging In to the User Options Web Pages, page 1-16](#)
- [Establishing Cisco IP Phone Services, page 1-18](#)

## Establishing Cisco IP Phone Services

You can access information services, such as weather, stock quotes, and other services available at your company, using your Cisco IP Phone’s LCD display. Before accessing these services on your phone, your system administrator must customize them and make them available to you. Additionally, you must subscribe to the services that you want to appear on your phone.

To view services that you have subscribed to, press the **Services** button on your Cisco IP Phone. Use the Navigation button to select the desired service, then press the **Select** softkey to display information about that service. When you are finished, press the **services** button to exit the Services menu.

You can subscribe to the same service multiple times and give each instance of the same service a unique name. For example, if you want to subscribe to a weather service for several regions, you can rename each version.

The following topics describe how to establish services with the User Options web pages:

- [Subscribing to Services, page 1-19](#)
- [How to Change or End Subscriptions, page 1-20](#)

### Related Topics

- [Logging In to the User Options Web Pages, page 1-16](#)
- [Changing the Default Language for the User Options Web Pages, page 1-17](#)

## Subscribing to Services

Follow these steps to subscribe to services.

### Before You Begin

Log in to the User Options web page. For information on the User Options web page and how to access it, see the [“Logging In to the User Options Web Pages” section on page 1-16](#).

### Procedure

---

- Step 1** From the User Options main menu, click **Configure your Cisco IP Phone Services**.
- The Subscribe/Unsubscribe IP Phone Services page appears.
- Step 2** Select the service you want to add to your phone from the “Available Services” drop-down list.
- Step 3** Click **Continue**.
- Step 4** Enter any required information. For example, if the service is “movie times,” you might need to enter your zip code to enable the service to display movies in your location.
- Step 5** When you are done, click **Subscribe** to save your settings. To restore your previous settings, click **Back**.



---

**Note** If your phone uses Cisco CallManager Extension Mobility, you will need to log out and then log back in to the extension mobility service on your IP Phone before the changes take effect.

---

**Step 6** To subscribe to another service, click **New Subscription** in the Subscribed Services pane.

To exit, click **Return to the Menu** or **Log Off** at the bottom of the page.

---

### Related Topics

- [Establishing Cisco IP Phone Services, page 1-18](#)
- [How to Change or End Subscriptions, page 1-20](#)

## How to Change or End Subscriptions

You can change or end your current subscriptions at any time. To do so, follow these steps.

### Before You Begin

Log in to the User Options web page. For information on the User Options web page and how to access it, see the “[Logging In to the User Options Web Pages](#)” section on page 1-16.

### Procedure

---

**Step 1** From the User Options main menu, click **Configure your Cisco IP Phone Services**.

The Subscribe/Unsubscribe IP Phone Services page appears.

**Step 2** In the Your Subscribed Services pane, click on the service that you want to change or end.

**Step 3** If you want to change your subscription, change the information in the desired fields and click **Update**. Or, click **Unsubscribe** to end your subscription to the service.



**Note** If your phone uses Cisco CallManager Extension Mobility, you will need to log out and then log back in to the extension mobility service on your IP Phone before the changes take effect.

---



**Step 4** When you are finished, click **Return to the Menu** or **Log Off** at the bottom of the page.

---

#### **Related Topics**

- [Subscribing to Services, page 1-19](#)
- [Establishing Cisco IP Phone Services, page 1-18](#)





## Customizing Phone Settings

---

These procedures help you personalize settings for your Cisco IP Phone:

- [Adjusting the Handset, Speakerphone, and Headset Volume, page 2-1](#)
- [Adjusting the Ringer Volume, page 2-2](#)
- [Personalizing the Ringer Sound, page 2-3](#)
- [Adjusting the Message Waiting Indicator Light, page 2-4](#)
- [Changing the LCD Screen Contrast, page 2-5](#)
- [Changing the Language for the Phone LCD Screen, page 2-6](#)

## Adjusting the Handset, Speakerphone, and Headset Volume

You can adjust the volume of the caller for the handset, speakerphone, and headset individually. When you change the volume for one, the others are not effected.

Follow these steps to adjust the volume on the handset, speakerphone, or headset.

### Procedure

---

- Step 1** Press the up or down **Volume** button when the handset, speakerphone, or headset is in use.



---

**Note** If you press the Volume button when none of these are in use, you are adjusting the ringer volume. For details, see the [“Adjusting the Ringer Volume”](#) section on page 2-2.

---

**Step 2** To save this volume setting for future calls, press the **Save** softkey.

If you adjust the volume during a call without pressing **Save**, you are changing the volume level only for the duration of that particular call; on subsequent calls, the volume level will revert to the previously saved setting.

---

#### Related Topics

- [Adjusting the Ringer Volume, page 2-2](#)
- [Personalizing the Ringer Sound, page 2-3](#)
- [Changing the LCD Screen Contrast, page 2-5](#)

## Adjusting the Ringer Volume

To change the volume used by the ringer, press the up or down **Volume** button while the handset is in its cradle. Continue to press the **Volume** button to hear sample rings and to adjust the volume to the desired level. The ringer volume is automatically saved.

#### Related Topics

- [Adjusting the Handset, Speakerphone, and Headset Volume, page 2-1](#)
- [Personalizing the Ringer Sound, page 2-3](#)
- [Changing the LCD Screen Contrast, page 2-5](#)

# Personalizing the Ringer Sound

You can change the sound your phone makes when it rings to suit your tastes and to help you differentiate between your phone ringing and another nearby phone, or to differentiate between different lines on your own phone.

Follow these steps to change the sound used by the ringer.

## Procedure

- 
- Step 1** Press the **Settings** button.
- Step 2** From the Settings menu, use the Navigation button to select **Ring Type** and press the **Select** softkey.
- Step 3** If you have multiple lines, use the Navigation button to scroll through the list of your lines. When you find the line you want to configure, press the **Select** softkey.



---

**Note** You can only use six different ring tones on your phone. If you have more than six lines, some of your lines must share a ring tone.

---

- Step 4** Use the Navigation button to scroll through the list of ring types and press the **Play** softkey to hear the selected ring type.
- Step 5** When you find the ring you want, press the **Select** softkey to check the corresponding check box.
- To set the ring tone back to the default ring tone, select **Default** from the list.
- Step 6** Press the **OK** softkey to accept and save your ringer selection.
- Step 7** Press the **Save** softkey to save all of your settings and to exit the Settings menu.
- 

## Related Topics

- [Adjusting the Handset, Speakerphone, and Headset Volume, page 2-1](#)
- [Adjusting the Ringer Volume, page 2-2](#)
- [Changing the LCD Screen Contrast, page 2-5](#)

# Adjusting the Message Waiting Indicator Light

You can change the behavior policy of the message waiting indicator light (or “lamp”) for each line appearance on your Cisco IP Phone. The message waiting indicator is the red strip on your phone’s handset that blinks when you receive an incoming call. In its default state, the message waiting indicator light is usually configured to remain lit when you receive a new voice mail message. However, the default policy is determined by your system administrator.

Follow these steps to specify the message waiting indicator light policy (on, off, or default) for one or more of your phone lines.

## Before You Begin

Log in to the User Options web page. For information on the User Options web page and how to access it, see the [“Logging In to the User Options Web Pages” section on page 1-16](#).

## Procedure

---

- Step 1** From the User Options web page, click **Change the Message Waiting Lamp policy for your phone**.
- The Change Your Message Waiting Lamp Policy page appears.
- Step 2** Click the drop-down list that corresponds to the line that you want to change. Choose **Use System Policy**, **Always light**, or **Never light**.
- Step 3** Click **Update**.
- Step 4** When you are finished, click **Return to the Menu** or **Log Off** at the bottom of the page.
- 

## Related Topics

- [Using Voice Mail, page 3-21](#).

# Changing the LCD Screen Contrast

To improve the readability of the LCD screen, follow these steps to adjust the contrast.

## Procedure

---

- Step 1** Press the **Settings** button.
- Step 2** From the Settings menu, use the Navigation button to select **Contrast**.
- Step 3** Perform one of the following:
- To set the desired contrast level—press the **Up** or **Down** softkeys (or the Volume buttons).
  - To restore your previously saved contrast setting—press the **more** softkey and then the **Restore** softkey.
  - To restore the factory default contrast setting—press the **more** softkey and then the **Factory** softkey.
- Step 4** Press the **OK** softkey to accept and save your changes.
- 

## Related Topics

- [Adjusting the Handset, Speakerphone, and Headset Volume, page 2-1](#)
- [Adjusting the Ringer Volume, page 2-2](#)
- [Personalizing the Ringer Sound, page 2-3](#)
- [Adjusting the Message Waiting Indicator Light, page 2-4](#)

# Changing the Language for the Phone LCD Screen

Use this procedure to change the default language in which information is displayed on the Cisco IP Phone's LCD screen.

**Note**

If you use the Cisco CallManager Extension Mobility service, follow the procedure described in the [“Changing the Default Language for the User Options Web Pages”](#) section on page 1-17. This procedure allows you to change the default language for your device profile.

**Before You Begin**

Log in to the User Options web page. For information on the User Options web page and how to access it, see the [“Logging In to the User Options Web Pages”](#) section on page 1-16.

**Procedure**

- 
- Step 1** From the User Options main menu, select your phone from the “Select a device to configure” drop-down list.
- Step 2** Click **Change the Locale for this phone**.  
The Select a User Locale for your Phone page appears.
- Step 3** Select the language that you want to use as the default language from the “User Locale for this phone” drop-down list and click **Update**.  
The language that you have selected now serves as the default language for your Cisco IP Phone LCD screen.  
If you change the default language for your phone's LCD screen while you are on an active call, the phone waits for you to end the call before updating the LCD screen.
- Step 4** When you are finished, click **Return to the Menu** or **Log Off** at the bottom of the page.
-



### Related Topics

- [Changing the LCD Screen Contrast, page 2-5](#)
- [Changing the Default Language for the User Options Web Pages, page 1-17](#)

■ Changing the Language for the Phone LCD Screen



# Placing a Call and Other Basic Phone Tasks

---

Basic phone tasks include placing, receiving and forwarding calls. The following sections describe how to perform these basic tasks on your Cisco IP Phone:

- [Making Telephone Calls, page 3-1](#)
- [Using Speed Dial, page 3-12](#)
- [Forwarding Calls to Another Extension, page 3-14](#)
- [Making Conference Calls, page 3-17](#)
- [Using Voice Mail, page 3-21](#)
- [Viewing and Dialing from the Phone Logs, page 3-21](#)
- [Searching and Dialing from the Phone Directory, page 3-23](#)



## Caution

---

Using a cell or mobile phone in close proximity to a Cisco IP Phone might cause interference.

---

## Making Telephone Calls

These sections describe how you can place, answer, or otherwise manage a telephone call:

- [Placing a Call, page 3-2](#)
- [Answering a Call, page 3-4](#)

- [Ending a Call, page 3-4](#)
- [Muting a Call, page 3-5](#)
- [Putting a Call on Hold, page 3-6](#)
- [Transferring a Call to Another Extension, page 3-7](#)
- [Redialing the Last Number Dialed, page 3-8](#)
- [How to Get Notified When a Busy Line is Available Using Cisco Call Back, page 3-8](#)
- [Storing and Retrieving a Call Using Call Park, page 3-9](#)
- [Answering Calls on Another Extension Using Call Pickup, page 3-10](#)

## Placing a Call

[Table 3-1](#) lists the different ways you can place a call with your Cisco IP Phone.

**Table 3-1** *Placing calls on your Cisco IP Phone*

If you want to...	Then...
use the receiver	Lift the handset and dial the number.
dial from one of your multiple lines	Press the <b>line</b> button that corresponds with your extension and dial the number that you want to reach.
make a new call on the current line	Press the <b>NewCall</b> softkey and dial the number.
dial with the phone on hook	<p>From the main screen, dial the number and press the <b>Dial</b> softkey. The phone will not produce a dial tone until after you press the Dial softkey.</p> <p>You can also press a line button, the Headset button, the Speaker button, or lift the receiver to place the call.</p> <p><b>Note</b> If you are dialing with the phone on hook, you cannot use * or # as the leading digit. If you need to use these keys, dial with the phone off hook.</p>
use a headset	Press the <b>Headset</b> button and dial the number.
use the speakerphone	Press the <b>Speaker</b> button and dial the number.

**Table 3-1** Placing calls on your Cisco IP Phone (continued)

If you want to...	Then...
redial the most recently dialed number	Press the <b>Redial</b> softkey.
use speed dial numbers	Press a <b>Speed dial</b> button to place a call to the corresponding number. See the <a href="#">“Using Speed Dial”</a> section on page 3-12 for details.
use a directory	Select a number from one of the directories, then press the <b>Dial</b> softkey. See the <a href="#">“Viewing and Dialing from the Phone Logs”</a> section on page 3-21 for details.
dial a Personal Address Book entry	Refer to the <a href="#">“Dialing a Personal Address Book Entry”</a> section on page 5-9.
dial a Personal Fast Dial number	Refer to the <a href="#">“Dialing a Personal Fast Dials Entry”</a> section on page 5-20.

**Tip**

If you receive a busy tone or a ring with no answer when you call another extension, you can use the Cisco Call Back feature to get an alert when the extension is available. See the [“How to Get Notified When a Busy Line is Available Using Cisco Call Back”](#) section on page 3-8.

**Related Topics**

- [A Road Map to Your Cisco IP Phone](#), page 1-6
- [Answering a Call](#), page 3-4
- [Ending a Call](#), page 3-4
- [How to Get Notified When a Busy Line is Available Using Cisco Call Back](#), page 3-8
- [Redialing the Last Number Dialed](#), page 3-8
- [Using Speed Dial](#), page 3-12
- [Making Conference Calls](#), page 3-17

## Answering a Call

Table 3-2 lists ways to answer an incoming call:

**Table 3-2 Answering a Call**

If you want to...	Then...
use the handset	Lift the handset.
use a headset	If the <b>Headset</b> button: <ul style="list-style-type: none"> <li>• is not lit, then press it.</li> <li>• is lit, then press the <b>Answer</b> softkey or the <b>line</b> button of the incoming call.</li> </ul>
use the speakerphone	Press the <b>Answer</b> softkey or the <b>Speaker</b> button.
use the AutoAnswer feature	The phone will automatically answer the call when your phone receives it, if your administrator turned AutoAnswer on for your extension.

### Related Topics

- [Placing a Call, page 3-2](#)
- [Ending a Call, page 3-4](#)
- [Muting a Call, page 3-5](#)
- [Putting a Call on Hold, page 3-6](#)
- [Answering Calls on Another Extension Using Call Pickup, page 3-10](#)

## Ending a Call

Table 3-3 lists ways to end a call:

**Table 3-3 Ending a Call**

If you are using...	Then...
the handset	Hang up the handset.

**Table 3-3** *Ending a Call (continued)*

<b>If you are using...</b>	<b>Then...</b>
a headset	Press the <b>Headset</b> button or the <b>EndCall</b> softkey.
the speakerphone	Press the <b>Speaker</b> button or the <b>EndCall</b> softkey.

**Related Topics**

- [Placing a Call, page 3-2](#)
- [Answering a Call, page 3-4](#)
- [Transferring a Call to Another Extension, page 3-7](#)
- [Forwarding Calls to Another Extension, page 3-14](#)

## Muting a Call

You can mute the handset, headset, or speakerphone during a call. The mute feature temporarily disables your phone's microphone. Mute prevents the party or parties on the other end of the line from hearing you, but does not interfere with your ability to hear them.

To mute a call, press the **Mute** button. To disengage mute, press **Mute** again.

**Related Topics**

- [Placing a Call, page 3-2](#)
- [Answering a Call, page 3-4](#)
- [Ending a Call, page 3-4](#)
- [Putting a Call on Hold, page 3-6](#)

## Putting a Call on Hold

When you put a call on hold, the call remains active even though you and the other party cannot hear one another. You can answer other calls while a call is on hold.

**Note**

Engaging the Hold feature generates music or a beeping tone. For this reason, avoid putting a conference call on hold.

Table 3-4 lists ways to use the Hold feature:

**Table 3-4** Putting a Call on Hold

If you...	Then...
want to put a call on hold	Press the <b>Hold</b> softkey.
want to resume a call on hold	Press the <b>Resume</b> softkey.
have multiple calls on hold	Use the Navigation button to select the desired call before you press <b>Resume</b> .
have multiple calls on multiple lines on hold	<p>Press the <b>line</b> button for the line to which you want to switch and use the Navigation button to select the desired call. Press <b>Resume</b>.</p> <p>If you cannot use the Navigation button because only one line displays on your phone's LCD screen, press the <b>line</b> button next to the call that you want to resume.</p> <p>If your phone opens a new line when you press the line button, press the <b>EndCall</b> softkey to return to the desired call.</p> <p><b>Tip</b> If you are using multiple lines, to see the phone number for a call you have on hold, press the ? button followed by the line button of the call on hold.</p>

### Related Topics

- [Placing a Call, page 3-2](#)
- [Answering a Call, page 3-4](#)
- [Ending a Call, page 3-4](#)
- [Muting a Call, page 3-5](#)
- [Transferring a Call to Another Extension, page 3-7](#)



## Transferring a Call to Another Extension

Follow these steps to transfer a call to another phone.

### Procedure

---

- Step 1** During a call, press the **Trnsfer** softkey. This puts the call on hold.
- Step 2** Dial the number or office extension to which you want to transfer the call.
- Step 3** When it rings on the other end, press **Trnsfer** again. Or, when the party answers, announce the call and then press **Trnsfer**.
- Step 4** If you are using a handset, hang up.  
If the party refuses the call, press the **Resume** softkey to return to the original call.
- 

### Related Topics

- [Placing a Call, page 3-2](#)
- [Answering a Call, page 3-4](#)
- [Ending a Call, page 3-4](#)
- [Storing and Retrieving a Call Using Call Park, page 3-9](#)
- [Forwarding Calls to Another Extension, page 3-14](#)

## Redialing the Last Number Dialed

To redial the most recently dialed number, press the **Redial** softkey. Doing so without lifting the handset activates the speakerphone or headset.

To redial a number from a line other than your primary line, select the desired line button and then press **Redial**.

### Related Topics

- [Placing a Call, page 3-2](#)
- [Ending a Call, page 3-4](#)
- [How to Get Notified When a Busy Line is Available Using Cisco Call Back, page 3-8](#)

## How to Get Notified When a Busy Line is Available Using Cisco Call Back

If you call an extension and the line is busy or the call goes unanswered, you can use the Cisco Call Back feature to be notified when the extension is available to take a call.

### Procedure

---

**Step 1** Call an extension. While you hear the busy tone or ringing tone, press the **CallBack** softkey.

A CallBack activation confirmation message displays.



---

**Note** You cannot activate call back notification if the called party has forwarded all calls to another extension.

---

**Step 2** Press the **Exit** softkey to close the confirmation screen or press the **Cancel** softkey to cancel the call back notification.

- Step 3** To verify the status of the call back notification, press the **CallBack** softkey while your phone is idle.
- A confirmation message displays.
- Press the **Exit** softkey to close the confirmation screen or press the **Cancel** softkey to cancel call back notification.
- Step 4** When the extension you called is available to receive a call, you receive an audio and visual alert from your phone. Press **Dial** to dial the number.
- 

#### Related Topics

- [Placing a Call, page 3-2](#)
- [Answering a Call, page 3-4](#)
- [Ending a Call, page 3-4](#)
- [Redialing the Last Number Dialed, page 3-8](#)

## Storing and Retrieving a Call Using Call Park

Park a call when you want to store the call before retrieving it from another phone in the Cisco CallManager system (for example, a phone in someone else's office or in a conference room). Call park numbers are pre-configured for this purpose by your system administrator.

#### Procedure

---

- Step 1** During an active call, press the **more** softkey until you see the **Park** tab.
- Step 2** Press **Park**. The LCD screen displays the special call park number at which the call is stored. If the screen does not display a call park number, the call park feature is not available to you.
- Step 3** Make a note of the call park number, then hang up. The call is parked at that number, allowing you to retrieve it from another phone.

- Step 4** To retrieve the parked call from any phone in the Cisco CallManager system, dial the call park number at which the call is parked.



---

**Note** You have a limited amount of time to retrieve the parked call before it reverts to ringing at its original destination. See your system administrator for this time limit.

---

#### Related Topics

- [Placing a Call, page 3-2](#)
- [Answering a Call, page 3-4](#)
- [Ending a Call, page 3-4](#)
- [Transferring a Call to Another Extension, page 3-7](#)

## Answering Calls on Another Extension Using Call Pickup

You can answer an incoming call that is ringing on a telephone extension other than your own by using the call pickup feature.

There are two types of call pickup available on the Cisco IP Phone, as described in these topics:

- [How to Pick Up Calls Within Your Group, page 3-11](#)
- [How to Pick Up Calls Outside of Your Group, page 3-11](#)



---

**Note** Call pickup and group call pickup are optional features configured by your system administrator; your phone does not support these features by default.

---

#### Related Topics

- [Placing a Call, page 3-2](#)
- [Answering a Call, page 3-4](#)
- [Ending a Call, page 3-4](#)

- [Putting a Call on Hold](#), page 3-6
- [Redialing the Last Number Dialed](#), page 3-8

## How to Pick Up Calls Within Your Group

Call pickup allows you to pick up incoming calls within your own group. A “group” in this sense is any consolidation of Cisco IP Phone extensions, as defined by your system administrator. For example, your group might contain co-workers in neighboring offices or cubes.

Activate call pickup so that an incoming call delivered to another extension in your group rings on your extension.

### Procedure

---

- Step 1** Press any available **line** button on your Cisco IP Phone.
- Step 2** Press the **PickUp** softkey. The call now rings on your phone.
- Step 3** Answer the incoming call.
- 



### Tip

If there is more than one incoming call involved when you activate call pickup, the first unanswered call will ring at your phone.

---

### Related Topics

- [Storing and Retrieving a Call Using Call Park](#), page 3-9
- [How to Pick Up Calls Outside of Your Group](#), page 3-11

## How to Pick Up Calls Outside of Your Group

Group call pickup allows you to pick up incoming calls within your own group or in other groups. A “group” might contain co-workers in neighboring offices or cubes.

You must dial the appropriate call pickup group number when using this feature. A call pickup group number is provided to you by your system administrator.

### Procedure

---

- Step 1** Press any available **line** button.
- Step 2** Press the **GPickUp** softkey.
- Step 3** Dial the required call pickup group number.
- Step 4** Answer the incoming call that is redirected to your phone.
- Step 5** To pick up a call using a different call pickup group number, hang up and begin again at Step 1.
- 



#### Tip

If there is more than one incoming call involved when you activate group call pickup, you receive the first unanswered call. If there is no unanswered call in the group, or if you dial an invalid group number, you receive a fast busy tone.

---

### Related Topics

- [Storing and Retrieving a Call Using Call Park, page 3-9](#)
- [How to Pick Up Calls Within Your Group, page 3-11](#)

## Using Speed Dial

The buttons to the right of the LCD screen on your Cisco IP Phone can be used as phone lines or as speed dial buttons, as determined by your system administrator. You can assign phone numbers and text labels to speed dial buttons using the Cisco CallManager User Options web pages.

Unlike the Fast Dial feature (see the [“Using Fast Dials” section on page 5-12](#)), Speed Dial does not require subscribing to or using a service.



#### Note

If you are using one or more Cisco IP Phone 7914 Expansion Modules, you can access extra speed dial or line buttons. To configure speed dial buttons for your Expansion Module, follow the steps in the procedure below.

---

Follow these instructions to set up your speed dial buttons.

### Before You Begin

Log in to the User Options web page. For information on the User Options web page and how to access it, see the [“Logging In to the User Options Web Pages” section on page 1-16](#).

### Procedure

---

**Step 1** From the User Options web page, click **Add/Update your Speed Dials**.

The Add/Update Your Speed Dials page appears. You will see a section for setting speed dials on your phone. If you have one or more Expansion Modules, you will see another section for setting speed dials for each of your Expansion Modules.

**Step 2** In an available Speed Dial box, enter a phone number or extension that you want to associate to one of your speed dial buttons.



**Note** Be sure to enter the number exactly as you would if you were to call that number. For example, include an access code such as 9 or the area code, if necessary.

---

**Step 3** In each corresponding Display Text box, enter a text label that you want displayed on your phone’s LCD screen. You can enter a maximum of 30 characters for phone base text and 14 characters for Expansion Module text.

**Step 4** Click **Update** to activate new speed dial buttons and to display the corresponding text on your phone’s LCD screen. Your LCD screen(s) and lighted buttons will reset.

**Step 5** When you are finished, click **Return to the Menu** or **Log Off** at the bottom of the page.



**Note** If your phone uses Cisco CallManager Extension Mobility, you will need to log out and back in to the extension mobility service on your phone before the changes take effect.

---

**Related Topics**

- [Using Fast Dials, page 5-12](#)
- [Making Telephone Calls, page 3-1](#)

## Forwarding Calls to Another Extension

Call forwarding allows you to redirect all incoming calls from your Cisco IP Phone to another number.

Use call forwarding to:

- Send incoming calls to another number where you can answer the calls (for example, if you are going to be working in an alternate office).
- Send incoming calls directly to voice mail. Your desk phone does not ring when calls are routed to your voice mail through the call forwarding feature.

Call forwarding can send your calls to another IP Phone or to a traditional analog phone.

If there is no answer at the forwarded number, either a person or voice mail, the call will be sent back to your voice mail system.

**Related Topics**

- [Setting Up Call Forwarding on Your Phone, page 3-14](#)
- [Setting Up Call Forwarding When Not at Your Phone, page 3-15](#)
- [Canceling Call Forwarding, page 3-16](#)

## Setting Up Call Forwarding on Your Phone

Follow these steps to set up call forwarding on your phone.

**Procedure**

- 
- Step 1** Press the **CFwdAll** softkey. You should hear two beeps.
- Step 2** Enter the number to which you want to forward all of your calls, exactly as you would if you were placing a call to that number.



For example, enter an access code such as 9 or the area code, if necessary. Your system administrator might restrict the call forwarding feature to numbers within your company.

After you enter the number, an animated phone icon with a flashing right arrow appears in the upper-right corner of the LCD screen. The LCD screen also displays a message confirming the number or extension to which your calls are being forwarded.

**Step 3** To cancel call forwarding, press the **CFwdAll** softkey.

---

#### Tips

- To set up call forwarding when not at your phone, see the [“Setting Up Call Forwarding When Not at Your Phone”](#) section on page 3-15.
- To use call forwarding to send all of your incoming calls directly to your voice mail without causing your desk phone to ring, see the [“Setting Up Call Forwarding When Not at Your Phone”](#) section on page 3-15.

#### Related Topics

- [Forwarding Calls to Another Extension, page 3-14](#)
- [Setting Up Call Forwarding When Not at Your Phone, page 3-15](#)
- [Canceling Call Forwarding, page 3-16](#)

## Setting Up Call Forwarding When Not at Your Phone

If you are away from your phone, use the Cisco CallManager User Options web pages to set up call forwarding.

#### Before You Begin

Log in to the User Options web page. For information on the User Options web page and how to access it, see the [“Logging In to the User Options Web Pages”](#) section on page 1-16.

### Procedure

---

- Step 1** From the User Options web page, click **Forward all calls to a different number**.  
The Forward Your Calls page appears.
- Step 2** Check the check box next to the line from which you want your incoming calls forwarded.
- Step 3** Choose where to send calls:
- To send calls directly to voice mail, and not ring your phone, choose **Voice Mail**.
  - To send calls to a specific number, choose **this number** and enter the phone number or extension in the box provided.  
  
Be sure to enter the number exactly as you would if you were to call that number. For example, enter an access code such as 9 or the area code, if necessary. Your system administrator might restrict the call forwarding feature to numbers within your company.
- Step 4** Click **Update**.
- 

### Related Topics

- [Forwarding Calls to Another Extension, page 3-14](#)
- [Setting Up Call Forwarding on Your Phone, page 3-14](#)
- [Canceling Call Forwarding, page 3-16](#)

## Canceling Call Forwarding

You can cancel call forwarding from either your phone or on the web.

To cancel call forwarding from your phone, press the **CFwAll** softkey.

To cancel call forwarding when you are away from your phone, perform the following procedure.

**Before You Begin**

Log in to the User Options web page. For information on the User Options web page and how to access it, see the [“Logging In to the User Options Web Pages” section on page 1-16](#).

**Procedure**

- 
- Step 1** From the User Options web page, click **Forward all calls to a different number**. The Forward Your Calls page appears.
- Step 2** Clear the checkbox next to the line for which you want to cancel call forwarding.
- Step 3** Click **Update**.
- 

**Related Topics**

- [Forwarding Calls to Another Extension, page 3-14](#)
- [Setting Up Call Forwarding on Your Phone, page 3-14](#)
- [Setting Up Call Forwarding When Not at Your Phone, page 3-15](#)

## Making Conference Calls

Your Cisco IP Phone supports conference calls, enabling you to talk with multiple parties at the same time. When you are on a conference call, you can use regular phone features such as Mute, Hold, Transfer, and speakerphone.

This section covers the following topics:

- [Placing a Conference Call, page 3-18](#)
- [Using Meet-Me Conferences, page 3-18](#)
- [Conferencing by Barging in on Established Conversations, page 3-20](#)

## Placing a Conference Call

Follow these steps to turn a call into a conference call.

### Procedure

---

- Step 1** During a call, press the **more** softkey and then the **Confnrn** softkey. Doing so automatically activates a new line and puts the first party on hold.
- Step 2** Place a call to another number or extension.
- Step 3** When the call connects, press **Confnrn** again to add the new party to the conference call.

Repeat these steps to add parties to the conference call.

Once the conference call initiator disconnects, no additional parties can be added.

You can drop the last party added by pressing the **RmLstC** softkey.

---

### Related Topics

- [Making Conference Calls, page 3-17](#)
- [Using Meet-Me Conferences, page 3-18](#)
- [Conferencing by Barging in on Established Conversations, page 3-20](#)

## Using Meet-Me Conferences

Your Cisco IP Phone supports Meet-Me conferences. A Meet-Me conference allows other callers to dial into the conference call. A Meet-Me conference requires a special conference number which is pre-configured for this purpose by your system administrator.

This section covers these topics:

- [Establishing a Meet-Me Conference, page 3-19](#)
- [Joining a Meet-Me Conference, page 3-19](#)

## Establishing a Meet-Me Conference

Follow these steps to establish a Meet-Me conference call.

### Before You Begin

Contact your system administrator for the necessary Meet-Me conference number or numbers.

### Procedure

---

- Step 1** Press the **more** softkey twice to display the **Meet-Me** tab.
  - Step 2** Press the **Meet-Me** softkey.
  - Step 3** Dial the Meet-Me conference number.
  - Step 4** Follow the voice instructions to establish the Meet-Me conference.
- 

### Related Topics

- [Making Conference Calls, page 3-17](#)
- [Placing a Conference Call, page 3-18](#)
- [Using Meet-Me Conferences, page 3-18](#)
- [Conferencing by Barging in on Established Conversations, page 3-20](#)
- [Joining a Meet-Me Conference, page 3-19](#)

## Joining a Meet-Me Conference

To join a Meet-Me conference, simply dial the Meet-Me conference number provided by the Meet-Me conference initiator. You are connected to the conference once the conference initiator has dialed in and established the conference. You do not need to press the **Meet-Me** softkey on your Cisco IP Phone.

### Related Topics

- [Making Conference Calls, page 3-17](#)
- [Placing a Conference Call, page 3-18](#)

- [Using Meet-Me Conferences, page 3-18](#)
- [Conferencing by Barging in on Established Conversations, page 3-20](#)
- [Establishing a Meet-Me Conference, page 3-19](#)

## Conferencing by Barging in on Established Conversations

The Barge feature lets you add yourself to a call in progress on a shared line appearance.

If the party whose call you barged puts the call on hold, puts it in a conference, or transfers it, you are disconnected from the call.



### Note

---

You cannot be on two barged calls at the same time. You cannot put a barged call on hold and resume the call. You cannot answer a second line while on a barged call.

---

### Procedure

---

**Step 1** Select an active call on one of your shared lines.

**Step 2** Press the **Barge** softkey.

The phone creates a conference call and sends a beep tone to all the members of the conference to indicate that the barge occurred and that the conference started.

**Step 3** To end the conference, hang up.

When you hang up, the remaining parties receive a disconnect tone, and the original call continues.

---

### Related Topics

- [Making Conference Calls, page 3-17](#)
- [Placing a Conference Call, page 3-18](#)
- [Using Meet-Me Conferences, page 3-18](#)

# Using Voice Mail

Your phone administrator chooses the voice mail system that your phone uses. For information on how to use your voice mail system, refer to the documentation that came with it. For example, if your administrator configured your phone system to work with Cisco Unity, you would refer to the Cisco Unity documentation about working with your voice mail.

Your Cisco IP Phone indicates that you have one or more new voice mail messages by providing the following cues:

- The red light on your handset remains lit. (This indicator can vary, depending on the how the message waiting indicator lamp is configured. See the [“Adjusting the Message Waiting Indicator Light”](#) section on page 2-4.)
- A flashing envelope icon displays next to the appropriate line appearance on the LCD screen.
- A text message on the LCD screen displays.

To set up voice mail, press the **Messages** button on your Cisco IP Phone and follow the voice instructions. Your system administrator will provide you with a default password. For security reasons, you should change your default password as soon as possible.

To access voice mail, press the **Messages** button and follow the voice instructions.

## Related Topics:

- [A Road Map to Your Cisco IP Phone, page 1-6](#)
- [Using the Feature Buttons, page 1-10](#)

# Viewing and Dialing from the Phone Logs

If your phone display indicates that you have missed calls, you can use the Missed Calls option on the Directory menu to view your call history and to call back the person whose call you missed. Likewise, you can view call histories and place calls from the Received Calls and Placed Calls directories.

If the network shuts down or is reset, you might lose your call history records. If you use Cisco CallManager Extension Mobility

(see the [“Logging Into Your Extension from Any Phone Using the Cisco CallManager Extension Mobility Feature”](#) section on page 4-1), the call history is only available for times you are logged into the phone. Also, there is a limit on the number of call history records that can be stored. Your system administrator can provide information on this limit.

You can delete all records in the Missed, Received, or Placed directories. From the Directories menu, use the Navigation button to select the directory that you want to delete and press the **Clear** softkey.

Follow these steps to view or dial from a call log on your phone:

### Procedure

---

- Step 1** Press the **Directories** button.
- Step 2** Use the Navigation button to select the desired directory from the Directories menu, then press the **Select** softkey.
- Step 3** To place a call from any directory, use the Navigation button to select the record, then press the **Dial** softkey.



---

**Note** You might need to use the **EditDial** softkey to add digits to the front of the number. For example, if the call was from an outside, long-distance caller, you might need to add the digits 9-1 to the front of the number. Then, press the **Dial** softkey.

---

- Step 4** Press the **Exit** softkey twice to exit the Directory menu.
- 

### Related Topics

- [Searching and Dialing from the Phone Directory, page 3-23](#)
- [Making Telephone Calls, page 3-1](#)
- [Using Fast Dials, page 5-12](#)



# Searching and Dialing from the Phone Directory

Your phone may come configured with a corporate or local phone directory. This directory is searchable and allows you to find and dial phone numbers of colleagues easily.

Follow these steps to view or dial from a directory in your company.

## Procedure

---

- Step 1** Press the **Directories** button.
- Step 2** Use the Navigation button to select the desired directory from the Directories menu, then press the **Select** softkey.
- Step 3** Enter search criteria to retrieve a record (see the [“Navigating on Your Phone” section on page 1-11](#) for information on entering characters into your phone.)
- Step 4** To place a call from any directory, use the Navigation button to select the record, then press the **Dial** softkey.



**Note** You might need to use the **EditDial** softkey to add digits to the front of the number. For example, if the call was from an outside, long-distance caller, you might need to add the digits 9-1 to the front of the number. Then, press the **Dial** softkey.

---

- Step 5** Press the **Exit** softkey twice to exit the Directory menu.
- 

## Related Topics

- [Viewing and Dialing from the Phone Logs, page 3-21](#)
- [Making Telephone Calls, page 3-1](#)
- [Using Fast Dials, page 5-12](#)





# Logging Into Your Extension from Any Phone Using the Cisco CallManager Extension Mobility Feature

---

Your system administrator might provide you with a service called Cisco CallManager Extension Mobility. This service allows you to associate your phone number and user profile with any Cisco IP Phone. When you use your Cisco CallManager Extension Mobility personal identification number (PIN) to log in to a Cisco IP Phone, your assigned telephone number, and the settings that you have established from the Cisco CallManager User Options web pages, are associated with that phone.



## Note

---

For information about the User Options web pages, see [Chapter 1, “Customizing Your Phone From the User Options Web Pages”](#).

---

Cisco CallManager Extension Mobility is useful to you if you do not routinely conduct business in the same office space every day.

Your system administrator will inform you whether this service is available to you.

If you are logged out of a Cisco IP Phone that has the Cisco CallManager Extension Mobility feature configured for it, you will not be able to make calls, receive calls, or check voice mail messages from that phone until you log in. Also, Cisco CallManager Extension Mobility might automatically log you out after a certain amount of time. This time limit is established by your system administrator. Therefore, it is recommended that you log in to your phone at the

beginning of every day. If you hear a busy signal after pressing the Messages button or any key on the touch tone key pad, then you must log in before using the phone.

With Cisco CallManager Extension Mobility, you can be logged into only one phone at a time. If you want to use another phone, you must log out of the first phone.

Your Cisco CallManager Extension Mobility profile does not maintain ring type, contrast settings, and volume settings; configure these settings directly on the Cisco IP Phone.

This section covers the following topics:

- [Logging in to Cisco CallManager Extension Mobility, page 4-2](#)
- [Logging Out of Cisco CallManager Extension Mobility, page 4-4](#)
- [Changing Your Cisco CallManager Extension Mobility PIN, page 4-5](#)

## Logging in to Cisco CallManager Extension Mobility

To log in to Cisco CallManager Extension Mobility, perform the following steps. Your system administrator will provide you with the necessary user ID and personal identification number (PIN).



### Tip

---

It is recommended that you log in to your phone at the beginning of the work day. This practice ensures that your user device profile gets loaded on your phone. If you make changes to your profile, the changes will apply wherever you log in.

---

### Procedure

---

- Step 1** Press the **Services** button on your Cisco IP Phone.
- Step 2** From the Services menu, use the Navigation button to select the login option for extension mobility. Then, press the **Select** softkey.



---

**Note** Your system administrator chooses the name for your particular extension mobility service. These options might display on the Settings menu of your phone LCD screen as “extension mobility service,” for example.

---

- Step 3** Enter your user ID. For information on entering letters on your phone, see the [“Navigating on Your Phone” section on page 1-11](#).
- Step 4** Use the Navigation button to scroll down to the PIN prompt and enter your PIN.
- Step 5** Press the **submit** softkey.

The Cisco IP Phone to which you have logged in now adopts your user profile information, including your speed dials and established services. The phone also becomes associated with your phone number. If you login while the receiver is off hook, the changes will not take effect until you hang up.

You may be prompted to select the device profile to use. Use the Navigation button to scroll to the device and click the **Select** softkey.

- Step 6** Press the **Exit** softkey to return to the previous screen.
- 

### Related Topics

- [Logging Out of Cisco CallManager Extension Mobility, page 4-4](#)
- [Changing Your Cisco CallManager Extension Mobility PIN, page 4-5](#)
- [Logging Into Your Extension from Any Phone Using the Cisco CallManager Extension Mobility Feature, page 4-1](#)

# Logging Out of Cisco CallManager Extension Mobility

When you are ready to log out of Cisco CallManager Extension Mobility, follow these steps.

## Procedure

---

- Step 1** Press the **Services** button on your phone.
- Step 2** Use the Navigation button to select the logout option for Cisco CallManager Extension Mobility.
- Step 3** Press the **Select** softkey.
- Step 4** The phone might display “Do you want to log out <your UserID>?” If it does, select **Yes**.
- Step 5** Press the **Exit** softkey to return to the previous screen.
- 

## Related Topics

- [Logging Into Your Extension from Any Phone Using the Cisco CallManager Extension Mobility Feature, page 4-1](#)
- [Logging in to Cisco CallManager Extension Mobility, page 4-2](#)
- [Changing Your Cisco CallManager Extension Mobility PIN, page 4-5](#)

# Changing Your Cisco CallManager Extension Mobility PIN

To change your Cisco CallManager Extension Mobility PIN, use the Cisco CallManager User Options web pages:

**Note**

---

Changing your PIN will effect any service that requires a PIN, such as Personal Address Book and Personal Fast Dials. If you use these services and change your PIN, you must update those services before you can use them.

---

**Before You Begin**

Log in to the User Options web page. For information on the User Options web page and how to access it, see the [“Logging In to the User Options Web Pages” section on page 1-16](#).

**Procedure**

- 
- Step 1** From the User Options main menu, click **Change your PIN**.
- Step 2** Enter your current PIN and a new PIN in the required fields, then click **Update**.
- Step 3** When you are finished, click **Return to the Menu** or **Log Off** at the bottom of the page.
- 

**Related Topics**

- [Logging Into Your Extension from Any Phone Using the Cisco CallManager Extension Mobility Feature, page 4-1](#)
- [Logging in to Cisco CallManager Extension Mobility, page 4-2](#)
- [Logging Out of Cisco CallManager Extension Mobility, page 4-4](#)







## Managing Your Contacts

---

Your Cisco IP Phone might supply several different features to help you manage your phone contacts: a personal address book, a Cisco IP phone synchronizer, the Personal Address Book service, and the Personal Fast Dials service.

The Personal Address Book allows you to store names and numbers of your common contacts. From your Cisco IP Phone, you can use the Personal Address Book service to look up entries, make a selection, and press a softkey to dial the selected number.

With the Personal Fast Dials service, you can assign index numbers (from 1 to 99) for quick dialing from your Cisco IP Phone. You can assign index numbers either to Personal Address Book entries or to directory entries that you add that do not correspond to the address book. You can assign and remove the Personal Fast Dials entries from your phone or the Cisco IP Phone User Options application.



### Note

---

The exact names of the Personal Address Book and Personal Fast Dials services may vary, depending on how your system administrator configured the services.

---

With the Personal Directory synchronization tool, you can synchronize the Microsoft Windows address book, Microsoft Outlook and/or your Outlook Express address book entries stored on your computer with the Cisco CallManager directory.

These features are optional. Talk to your phone administrator about which features are available to you.

**Related Topics**

- [Managing Your Personal Address Book, page 5-2](#)
- [Dialing a Personal Address Book Entry, page 5-9](#)
- [Using the Cisco IP Phone Address Book Synchronizer, page 5-9](#)
- [Using Fast Dials, page 5-12](#)
- [Using Speed Dial, page 3-12](#)

## Managing Your Personal Address Book

You can set up and maintain a personal address book that contains listings for people internal and external to your company. You can also assign Fast Dial codes to personal address book entries and dial those codes in place of phone numbers.

**Related Topics**

- [Creating a New Address Book Entry on the Web, page 5-4](#)
- [Searching for or Editing a Personal Address Book Entry on the Web, page 5-5](#)
- [Searching Personal Address Book Entries on Your Phone, page 5-6](#)
- [Editing a Personal Address Book Entry on Your Phone, page 5-7](#)
- [Deleting an Address Book Entry on the Web, page 5-8](#)

## Subscribing to Personal Address Book

The Personal Address Book service allows you to look up address book entries and to dial a chosen number by pressing a softkey on your phone.

**Before You Begin**

Log in to the User Options web page. For information on the User Options web page and how to access it, see the [“Logging In to the User Options Web Pages” section on page 1-16](#).

### Procedure

---

- Step 1** From the User Options Menu window in the Cisco IP Phone User Options application, choose a device to configure, such as your primary phone.
- Step 2** Click the **Configure your Cisco IP Phone Services** link.  
The Cisco IP Phone Services window displays.
- Step 3** Choose the service as named by your system administrator; for example, My Address Book.
- Step 4** Click **Continue**.
- Step 5** Enter the appropriate service information. An asterisk indicates required fields. For a description of each field, click the **Description** link next to the field.
- Step 6** Click **Subscribe**.
- 

### Related Topics

- [Creating a New Address Book Entry on the Web, page 5-4](#)
- [Searching for or Editing a Personal Address Book Entry on the Web, page 5-5](#)
- [Searching Personal Address Book Entries on Your Phone, page 5-6](#)
- [Editing a Personal Address Book Entry on Your Phone, page 5-7](#)
- [Deleting an Address Book Entry on the Web, page 5-8](#)
- [Managing Your Personal Address Book, page 5-2](#)

## Creating a New Address Book Entry on the Web

Follow these steps to create a new address book entry.

### Before You Begin

Log in to the User Options web page. For information on the User Options web page and how to access it, see the [“Logging In to the User Options Web Pages” section on page 1-16](#).

### Procedure

---

**Step 1** From the User Options web page, click **Configure your Cisco Personal Address Book**.

The Find/List Personal Address Book Entries page appears.



---

**Note** You can add entries manually or use a synchronizer application to automatically import entries from your Microsoft Outlook address book. To obtain the synchronizer, contact your system administrator.

---

**Step 2** Click **Add a New Entry**.

The Address Book Entry window appears.

**Step 3** Enter information in the desired fields and click **Insert**.

**Step 4** When you are finished:

- Click **Return to Search**, **Fast Dials**, or **Add a New Entry** to continue working in the Find/List Address Book Entries page.
  - To exit, click **Return to the Menu** or **Log Off** at the bottom of the page.
- 

### Related Topics

- [Subscribing to Personal Address Book, page 5-2](#)
- [Searching for or Editing a Personal Address Book Entry on the Web, page 5-5](#)
- [Searching Personal Address Book Entries on Your Phone, page 5-6](#)
- [Editing a Personal Address Book Entry on Your Phone, page 5-7](#)

- [Deleting an Address Book Entry on the Web](#), page 5-8
- [Managing Your Personal Address Book](#), page 5-2

## Searching for or Editing a Personal Address Book Entry on the Web

Follow these steps to search for an address book entry. After you find the entry, you can modify or delete the entry, if necessary.

### Before You Begin

Log in to the User Options web page. For information on the User Options web page and how to access it, see the [“Logging In to the User Options Web Pages” section on page 1-16](#).

### Procedure

---

- Step 1** From the User Options web page, click **Configure your Cisco Personal Address Book**.
- The Find/List Personal Address Book Entries page appears.
- Step 2** Enter the name you that want to find by First Name, Last Name, or Nickname and click **Find**; you can enter partial or complete information in any search field (wildcard symbols such as \* are implicit and do not need to be entered.)
- If you want to view all entries in your address book, click **Find** without entering a name.
- Step 3** Click on any portion of the person’s name to display the complete entry or enter more search information to further refine your search.
- Step 4** If you want to edit any of the information, make the necessary changes, and click **Update**.
- 

### Related Topics

- [Creating a New Address Book Entry on the Web](#), page 5-4
- [Subscribing to Personal Address Book](#), page 5-2

- [Searching Personal Address Book Entries on Your Phone, page 5-6](#)
- [Editing a Personal Address Book Entry on Your Phone, page 5-7](#)
- [Deleting an Address Book Entry on the Web, page 5-8](#)
- [Managing Your Personal Address Book, page 5-2](#)

## Searching Personal Address Book Entries on Your Phone

Use the following procedure to find a personal address book entry.

### Procedure

---

**Step 1** Press the **services** button.

The phone displays the services that have been configured for your phone.

**Step 2** Use the navigation button to highlight the option that corresponds to the My Address Book service and press the **Select** softkey.



**Tip** The exact service name may vary, depending on how your system administrator configured the service.

---

**Step 3** Perform one of the following actions:

- To display a specific name, enter the name using your phone keypad and press the **Submit** softkey. All names that match your search criteria will display.
- To display all your address book entries, press the **Submit** softkey.

**Step 4** Using the navigation button, highlight the entry that you want and press the **Select** softkey.

---

### Related Topics

- [Creating a New Address Book Entry on the Web, page 5-4](#)
- [Searching for or Editing a Personal Address Book Entry on the Web, page 5-5](#)
- [Subscribing to Personal Address Book, page 5-2](#)
- [Editing a Personal Address Book Entry on Your Phone, page 5-7](#)

- [Deleting an Address Book Entry on the Web, page 5-8](#)
- [Managing Your Personal Address Book, page 5-2](#)

## Editing a Personal Address Book Entry on Your Phone

Use the following procedure to edit a Personal Address Book entry.

### Procedure

- 
- Step 1** Find the entry that you want to edit as described in [“Editing a Personal Address Book Entry on Your Phone” section on page 5-7](#).
- Step 2** Press the **Edit** softkey.  
The phone displays the Personal Address Book information for that entry.
- Step 3** Perform one of the following actions:
- To edit the first name, last name, or nickname for this entry, press the **Name** softkey.
  - To edit the home, work, or mobile numbers, press the **Phone** softkey.
- Step 4** Make your changes and press the **Submit** softkey.  
The phone displays a message that your change is successful.
- Step 5** Press the **OK** softkey.
- 

### Related Topics

- [Creating a New Address Book Entry on the Web, page 5-4](#)
- [Searching for or Editing a Personal Address Book Entry on the Web, page 5-5](#)
- [Searching Personal Address Book Entries on Your Phone, page 5-6](#)
- [Subscribing to Personal Address Book, page 5-2](#)
- [Deleting an Address Book Entry on the Web, page 5-8](#)
- [Managing Your Personal Address Book, page 5-2](#)

## Deleting an Address Book Entry on the Web

Follow these steps to delete an address book entry.

### Before You Begin

Log in to the User Options web page. For information on the User Options web page and how to access it, see the [“Logging In to the User Options Web Pages” section on page 1-16](#).

### Procedure

- 
- Step 1** Find the entries you want to delete (see the [“Searching for or Editing a Personal Address Book Entry on the Web” section on page 5-5](#).)
- Step 2** To delete an individual entry, check the checkbox next to the entry.  
To delete all entries displayed as a result of your search, check the checkbox in the heading bar above the individual entries. Doing so automatically selects each of the displayed entries.
- Step 3** Click **Delete Selected**.
- 

### Related Topics

- [Creating a New Address Book Entry on the Web, page 5-4](#)
- [Searching for or Editing a Personal Address Book Entry on the Web, page 5-5](#)
- [Searching Personal Address Book Entries on Your Phone, page 5-6](#)
- [Editing a Personal Address Book Entry on Your Phone, page 5-7](#)
- [Subscribing to Personal Address Book, page 5-2](#)
- [Managing Your Personal Address Book, page 5-2](#)



# Dialing a Personal Address Book Entry

Use the following procedure to dial a Personal Address Book entry.

## Procedure

---

- Step 1** Find the entry that you want to dial as described in [“Editing a Personal Address Book Entry on Your Phone” section on page 5-7](#).
- Step 2** Use the navigation button to choose the directory number that you want to dial and press the **Dial** softkey.
- 

## Related Topics

- [Creating a New Address Book Entry on the Web, page 5-4](#)
- [Managing Your Personal Address Book, page 5-2](#)

# Using the Cisco IP Phone Address Book Synchronizer

You can synchronize your Microsoft Outlook and/or your Outlook Express address book entries with the directory in Cisco CallManager using the Cisco IP Phone Address Book Synchronizer.

- [Installing the Cisco IP Phone Address Book Synchronizer, page 5-9](#)
- [Configuring the Cisco IP Phone Address Book Synchronizer, page 5-11](#)

# Installing the Cisco IP Phone Address Book Synchronizer

To install Cisco IP Phone Address Book Synchronizer, perform the following steps.

### Before You Begin

You need to get the Cisco IP Phone Address Book Synchronizer installer file from your system administrator.

### Procedure

---

- Step 1** Double-click the TabSyncInstall.exe file provided by your system administrator. The Welcome to Cisco IP Phone Address Book Synchronizer window displays.
- Step 2** Click **Next**.  
The License Agreement window displays.
- Step 3** Read the license agreement information, and click **Yes** to accept.  
The Choose Destination Location window displays.
- Step 4** Choose the directory in which you want to install the application and click **Next**.  
The Start Copying Files window displays.
- Step 5** Verify that you have chosen the correct directory, and click **Next**.  
The installation wizard installs the application to your computer. When the installation is complete, the InstallShield Wizard Complete window displays.
- Step 6** Click **Finish**.  
For information on configuring the Cisco IP Phone Address Book Synchronizer, see [“Configuring the Cisco IP Phone Address Book Synchronizer”](#) section on page 5-11.
- 

### Related Topics

- [Configuring the Cisco IP Phone Address Book Synchronizer, page 5-11](#)
- [Using the Cisco IP Phone Address Book Synchronizer, page 5-9](#)

## Configuring the Cisco IP Phone Address Book Synchronizer

Use the following steps to configure the Cisco IP Phone Address Book Synchronizer and to synchronize your address book.

### Procedure

---

- Step 1** Open the Cisco IP Phone Address Book Synchronizer.
- If you accepted the default installation directory, you can open the application by choosing **Start > Programs > Cisco > IP Phone Address Synchronizer**.
- Step 2** To configure user information, click the **Password** button.
- The Cisco IP Phone User window displays.
- Step 3** Enter the Cisco IP phone user name and password and click **OK**.
- Step 4** To configure synchronization rules, click the **Rules Options** button.
- Step 5** Choose the synchronization method that you want to use and click **OK**.
- Step 6** To configure Cisco CallManager information, click the **CCM Server** button.
- The Configure Cisco CallManager Web Server window displays.
- Step 7** Enter the IP address or host name of the Cisco CallManager and click **OK**.
- If you do not have this information, contact your system administrator.
- Step 8** Click the **Password** button.
- The Cisco IP Phone User window displays.
- Step 9** Enter your user identification and password for the Cisco IP Phone User Options application.
- Step 10** To start the directory synchronization process, click the **Synchronize** button.
- The Synchronization Status window provides information on the status of the address book synchronization. If you chose the user intervention for duplicate entries rule and you have duplicate address book entries, the Duplicate Selection window displays. Choose the entry that you want to include in your Personal Address Book and click **OK**.
- Step 11** When synchronization completes, click **Exit** to close the Cisco IP Phone Address Book Synchronizer.
-

**Related Topics**

- [Using the Cisco IP Phone Address Book Synchronizer, page 5-9](#)
- [Installing the Cisco IP Phone Address Book Synchronizer, page 5-9](#)

## Using Fast Dials

With Personal Fast Dials, you can assign index numbers (from 1 to 99) to phone numbers for quick dialing from your Cisco IP phone.

To use Personal Fast Dials, you must subscribe to the Fast Dials service and use either your phone or the User Options web pages to assign fast dial numbers.

**Related Topics**

- [Subscribing to Personal Fast Dials, page 5-12](#)
- [Assigning Fast Dial Codes to Phone Numbers on the Web, page 5-13](#)
- [Removing Personal Fast Dials Entries on the Web, page 5-15](#)
- [Creating a Personal Fast Dials Entry for a Number in Your Personal Address Book on Your Phone, page 5-16](#)
- [Creating a Personal Fast Dial Entry for a Non-Address Book Directory Number on Your Phone, page 5-17](#)
- [Removing a Personal Fast Dials Entry on Your Phone, page 5-19](#)
- [Dialing a Personal Fast Dials Entry, page 5-20](#)

## Subscribing to Personal Fast Dials

To subscribe to the Personal Fast Dials service, perform the following steps.

**Before You Begin**

Log in to the User Options web page. For information on the User Options web page and how to access it, see the [“Logging In to the User Options Web Pages” section on page 1-16](#).

### Procedure

---

- Step 1** From the User Options Menu window in the Cisco IP Phone User Options application, choose a device to configure, such as your primary phone.
- Step 2** Click the **Configure your Cisco IP Phone Services** link.  
The Cisco IP Phone Services window displays.
- Step 3** Choose the service as named by your system administrator; for example My Fast Dials and click **Continue**.
- Step 4** Enter the appropriate service information. An asterisk indicates required fields.  
For a description of each field, click the **Description** link next to the field.
- Step 5** Click **Subscribe**.
- 

### Related Topics:

- [Using Fast Dials, page 5-12](#)
- [Creating a Personal Fast Dials Entry for a Number in Your Personal Address Book on Your Phone, page 5-16](#)
- [Creating a Personal Fast Dial Entry for a Non-Address Book Directory Number on Your Phone, page 5-17](#)
- [Dialing a Personal Fast Dials Entry, page 5-20](#)

## Assigning Fast Dial Codes to Phone Numbers on the Web

The Fast Dial feature allows you to assign a fast dial code to a phone number for easier dialing. Unlike speed dial, the fast dial feature is not limited by the availability of line buttons on your Cisco IP Phone. Instead, fast dial codes are one or two number codes (1 to 99) that you dial instead of a complete phone number.

Follow these steps to assign a fast dial code to a phone number.

### Procedure

**Step 1** Begin by searching for the address book entry to which the phone number belongs. See the [“Searching for or Editing a Personal Address Book Entry on the Web” section on page 5-5](#) for instructions.

**Step 2** Next, click the **fast dial icon** that corresponds to the appropriate entry.

The Add a New Fast Dial Entry pop-up window appears.



**Note** If no fast dial icon is displayed, you have not entered a phone number for that person’s address book entry yet. In this case, click on the person’s name to modify the entry.

**Step 3** In the Fast Dial Association area, choose a fast dial code for this entry from the “Index” drop-down list. Choose any fast dial code number not already assigned.

**Step 4** In the Directory Number Association area, select an address book entry. For example, select “John Smith.”

**Step 5** If the phone number to which you want to assign a fast dial code

- already exists in your personal address book—click on the Directory Number drop-down list to choose the phone number. Choose **H** for a home number, **W** for a work number, or **M** for a mobile phone number. For example, choose “W-4321” for John Smith’s work number.
- does not exist in your address book, enter the phone number in the “Enter a directory number” field.



**Note** Be sure to enter the number exactly as you would if you were to call that number. For example, include an access code such as 9 or the area code, if necessary.

**Step 6** Click **Insert** and close the window.

**Step 7** From the Find/List Address Book Entries page, click **Fast Dials**.

On the line that corresponds to the index (fast dial code number) that you chose, you will see a name or phone number:

- If you chose an existing entry from your address book, then you can see the person's nickname (or first and last name if no nickname is available). The initial M, W, or H (mobile, work, or home phone number, respectively) is displayed next to the person's name.
- If you chose to enter a new phone number for someone already included in your personal address book (instead of choosing an existing phone number), you will see the phone number that you entered next to the fast dial code.

**Tip**

If the person to whom you want to assign a fast dial code is *not* included in your personal address book, do the following: Click on **Fast Dials** on the bottom of the Find/List Address Book Entries page, then click any "Unassigned" fast dial listing to display the Add a New Fast Dial Entry pop-up window. Follow the above instructions, omitting Step 3.

**Related Topics:**

- [Subscribing to Personal Fast Dials, page 5-12](#)
- [Using Fast Dials, page 5-12](#)
- [Creating a Personal Fast Dials Entry for a Number in Your Personal Address Book on Your Phone, page 5-16](#)
- [Creating a Personal Fast Dial Entry for a Non-Address Book Directory Number on Your Phone, page 5-17](#)
- [Dialing a Personal Fast Dials Entry, page 5-20](#)

## Removing Personal Fast Dials Entries on the Web

Use the following procedure to remove an entry from your personal fast dial list.

**Before You Begin**

Log in to the User Options web page. For information on the User Options web page and how to access it, see the ["Logging In to the User Options Web Pages"](#) section on page 1-16.

### Procedure

---

- Step 1** From the User Options Menu window in the Cisco IP Phone User Options application, choose a device to configure, such as your primary phone.
- Step 2** Click the **Configure your Cisco Personal Address Book** link.  
The Find and List Personal Address Book Entries window displays.
- Step 3** Click the **Fast Dials** link.
- Step 4** Check the checkboxes next to the entries that you want to remove. To choose the displayed entries, select the checkbox in the title bar above the fast dials list.
- Step 5** Click the **Delete** button.  
A confirmation dialog box displays.
- Step 6** To unassign the chosen entries, click **OK**.
- 

### Related Topics

- [Subscribing to Personal Fast Dials, page 5-12](#)
- [Creating a Personal Fast Dials Entry for a Number in Your Personal Address Book on Your Phone, page 5-16](#)
- [Creating a Personal Fast Dial Entry for a Non-Address Book Directory Number on Your Phone, page 5-17](#)
- [Removing a Personal Fast Dials Entry on Your Phone, page 5-19](#)

## Creating a Personal Fast Dials Entry for a Number in Your Personal Address Book on Your Phone

Use the following procedure to create a Personal Fast Dials entry for a number in your Personal Address Book. For information on creating an entry for a directory number that is not in your address book, see the [“Creating a Personal Fast Dial Entry for a Non-Address Book Directory Number on Your Phone”](#) section on page 5-17.



### Procedure

---

- Step 1** Find the address book entry for which you want to create a fast dial as described in [“Editing a Personal Address Book Entry on Your Phone”](#) section on page 5-7.
- Step 2** Use the navigation button to highlight the appropriate entry and press the **Select** softkey.
- Step 3** Press the **FastDial** softkey.
- Step 4** Use the navigation button to highlight the directory number that you want to assign to a fast dial index (home, work, or mobile) and press the **Select** softkey.
- Step 5** Use the navigation button to choose a fast-dial index and press the **Select** softkey. A message displays that the Fast Dials entry has been created.
- Step 6** Press the **OK** softkey.
- 

### Related Topics

- [Subscribing to Personal Fast Dials, page 5-12](#)
- [Assigning Fast Dial Codes to Phone Numbers on the Web, page 5-13](#)
- [Removing Personal Fast Dials Entries on the Web, page 5-15](#)
- [Creating a Personal Fast Dial Entry for a Non-Address Book Directory Number on Your Phone, page 5-17](#)
- [Removing a Personal Fast Dials Entry on Your Phone, page 5-19](#)
- [Dialing a Personal Fast Dials Entry, page 5-20](#)

## Creating a Personal Fast Dial Entry for a Non-Address Book Directory Number on Your Phone

Use the following procedure to create a Personal Fast Dials entry for a directory number that is not in your Personal Address Book. For information on creating an entry for a number in your address book, see the [“Creating a Personal Fast Dials Entry for a Number in Your Personal Address Book on Your Phone”](#) section on page 5-16.

## Procedure

---

- Step 1** From your Cisco IP Phone, press the **services** button.  
The phone displays the services that have been configured for your phone.
- Step 2** Use the navigation button to highlight the option that corresponds to the My Fast Dials service and press the **Select** softkey.



**Tip** Remember, the exact service name may vary, depending on how your system administrator configured the service.

---

- Step 3** Press the **Assign** softkey.  
A message displays requesting you to choose an index to assign.
- Step 4** Use the navigation button to highlight a fast-dial index and press the **Select** softkey.
- Step 5** Enter a directory number and press the **Submit** softkey.  
A message displays that the Fast Dials entry has been created.
- Step 6** Press the **OK** softkey.
- 

## Related Topics

- [Subscribing to Personal Fast Dials, page 5-12](#)
- [Assigning Fast Dial Codes to Phone Numbers on the Web, page 5-13](#)
- [Creating a Personal Fast Dials Entry for a Number in Your Personal Address Book on Your Phone, page 5-16](#)
- [Removing a Personal Fast Dials Entry on Your Phone, page 5-19](#)
- [Dialing a Personal Fast Dials Entry, page 5-20](#)

## Removing a Personal Fast Dials Entry on Your Phone

Use the following procedure to remove a Personal Fast Dials entry.

### Procedure

---

- Step 1** From your Cisco IP Phone, press the **services** button.
- The phone displays the services that have been configured for your phone.
- Step 2** Use the navigation button to highlight the option that corresponds to the My Fast Dials service and press the **Select** softkey.
- Step 3** Press the **Remove** softkey.
- A message prompts you to choose an index to remove.
- Step 4** Use the navigation button to highlight the index that you want to remove and press the **Select** softkey.
- A message displays indicating that the entry has been removed.
- Step 5** Click the **OK** softkey.
- 

### Related Topics

- [Subscribing to Personal Fast Dials, page 5-12](#)
- [Creating a Personal Fast Dials Entry for a Number in Your Personal Address Book on Your Phone, page 5-16](#)
- [Creating a Personal Fast Dial Entry for a Non-Address Book Directory Number on Your Phone, page 5-17](#)
- [Removing a Personal Fast Dials Entry on Your Phone, page 5-19](#)
- [Dialing a Personal Fast Dials Entry, page 5-20](#)

## Dialing a Personal Fast Dials Entry

Use the following procedure to dial a number using the Personal Fast Dials service.

### Before You Begin

Before you can use the Fast Dial feature on your Cisco IP Phone, you must subscribe to the Fast Dial service. For information on subscribing to services, refer to the [“Establishing Cisco IP Phone Services” section on page 1-18](#)

### Procedure

- 
- Step 1** From your Cisco IP Phone, press the **services** button.
- The phone displays the services that have been configured for your phone.
- Step 2** Use the navigation button to highlight the option that corresponds to the My Fast Dials service and press the **Select** softkey.



---

**Tip** Remember, the exact service name may vary, depending on how your system administrator configured the service.

---

A screen displays your Personal Fast Dials entries.

- Step 3** Use the navigation button to choose a fast dial number and press the **Dial** softkey.
- 

### Related Topics

- [Subscribing to Personal Fast Dials, page 5-12](#)
- [Assigning Fast Dial Codes to Phone Numbers on the Web, page 5-13](#)
- [Creating a Personal Fast Dials Entry for a Number in Your Personal Address Book on Your Phone, page 5-16](#)
- [Creating a Personal Fast Dial Entry for a Non-Address Book Directory Number on Your Phone, page 5-17](#)
- [Dialing a Personal Fast Dials Entry, page 5-20](#)



## Using the Cisco IP Phone 7914 Expansion Module

The Cisco IP Phone 7914 Expansion Module attaches to phones in the Cisco IP Phone 7960 series and extends its functionality by adding 14 line appearances and/or speed dial numbers per module. One or two Expansion Modules can be attached to your IP Phone. One Expansion Module provides a total of 20 line and/or speed dial numbers. Two Expansion Modules provide a total of 34 line and/or speed dial buttons, as shown in [Figure 6-1](#).

**Figure 6-1** Cisco IP Phone 7960 with Two Expansion Modules



### Related Topics

- [Understanding Expansion Module Features, page 6-2](#)
- [How to Get More Information, page 6-3](#)

# Understanding Expansion Module Features

Cisco IP Phone 7914 Expansion Module features are illustrated in [Figure 6-2](#).

**Figure 6-2** Expansion Module Features



<b>1</b>	<b>LCD screen</b> —Displays either the phone number, speed dial number, or text label (such as a name) assigned to each button. Icons indicating line status function in the same way as those on the Cisco IP Phone 7960.
<b>2</b>	<p><b>Lighted Buttons</b>—14 buttons. Each button corresponds to one line (just like on the Cisco IP Phone 7960). The lights beneath each button indicate the state of the corresponding line as follows:</p> <p>Line available: Light off</p> <p>Line in use by you: Light steady Green</p> <p>Line in use by someone else: Light steady Red</p> <p>Line ringing: Light flashing Amber</p> <p>Call on hold: Light flashing Green</p> <p>Call transfer: Light steady Green</p>

**Tip**

You can assign phone numbers and text labels to speed dial buttons on your Expansion Module. For more information, see the “Using Speed Dial” section on page 3-12.

**Related Topics**

- [How to Get More Information, page 6-3](#)

## How to Get More Information

For more information about the 7914 Expansion Module, see the *Cisco IP Phone 7914 Expansion Module Quick Start Guide*. You can access this guide from the Cisco IP Phone Web site by performing the following steps:

**Procedure**

- 
- Step 1** Go to the following URL:  
[http://www.cisco.com/univercd/cc/td/doc/product/voice/c\\_ipphon/index.htm](http://www.cisco.com/univercd/cc/td/doc/product/voice/c_ipphon/index.htm)
- Step 2** Click the link to **Cisco CallManager**.
- Step 3** Choose your language from the list.
- Step 4** Click the **Cisco IP Phone 7914 Expansion Module** link.
- 

**Related Topics**

- [Understanding Expansion Module Features, page 6-2](#)







## FAQ

---

This Frequently Asked Questions section contains the following information:

- [How do I access voice mail?, page A-2](#)
- [How do I set speed dials?, page A-2](#)
- [How do I list my missed calls?, page A-2](#)
- [I don't see a Hold button—how do I put someone on hold?, page A-3](#)
- [How do I change the contrast on the phone LCD screen?, page A-3](#)
- [How do I change the settings for my Cisco CallManager Extension Mobility line?, page A-3](#)
- [How do I forward calls?, page A-4](#)
- [How do I store numbers of friends and colleagues that I want to call often?, page A-4](#)
- [I've used up all my speed dial lines, can I add more?, page A-5](#)
- [If I cannot answer a call that I have forwarded to another number, will the call get re-routed to my voice mail system?, page A-5](#)
- [Can I use call forwarding to send my calls directly to voice mail, without ringing my desk top phone?, page A-6](#)
- [Why don't I get a dial tone after dialing an access code?, page A-6](#)

## How do I access voice mail?

You can access your voice mail easily, just using the **Messages** button on your phone.

For information about setting up and accessing voice mail, refer to the [“Using Voice Mail” section on page 3-21](#).

### Related Topics

- [Using the Feature Buttons, page 1-10](#)

## How do I set speed dials?

You add, modify, and delete speed dials on the User Options web page.

To set up your speed dials, refer to the [“Using Speed Dial” section on page 3-12](#).

### Related Topics

- [Logging In to the User Options Web Pages, page 1-16](#)
- [Managing Your Contacts, page 5-1](#)

## How do I list my missed calls?

You can list the missed calls, placed calls, and received calls on your phone.

For more information, refer to the [“Viewing and Dialing from the Phone Logs” section on page 3-21](#).

### Related Topics

- [Searching and Dialing from the Phone Directory, page 3-23](#)

## I don't see a Hold button—how do I put someone on hold?

Some of the features and functions on your phone are accessed through softkeys. To put someone on hold, refer to the [“Putting a Call on Hold” section on page 3-6](#).

### Related Topics

- [Navigating on Your Phone, page 1-11](#)

## How do I change the contrast on the phone LCD screen?

You can make it easier to read the text on your phone LCD screen by adjusting the contrast.

To adjust the contrast, refer to the [“Changing the LCD Screen Contrast” section on page 2-5](#).

### Related Topics

- [Customizing Phone Settings, page 2-1](#)

## How do I change the settings for my Cisco CallManager Extension Mobility line?

You change the settings for your Cisco CallManager Extension Mobility line the same way that you change them for a regular line. When you want to change any settings that are in the User Options web page, make sure to select the device profile for your extension mobility extension. The Cisco CallManager Extension Mobility device profile usually has identifying text in the name, such as “EM”.

**Related Topics**

- [Logging Into Your Extension from Any Phone Using the Cisco CallManager Extension Mobility Feature, page 4-1](#)

## How do I forward calls?

You can forward calls either from your phone or from the User Options web page. You can either forward calls to another extension, or to voice mail.

For more information, refer to the [“Forwarding Calls to Another Extension” section on page 3-14.](#)

**Related Topics**

- [Logging In to the User Options Web Pages, page 1-16](#)

## How do I store numbers of friends and colleagues that I want to call often?

You can store the numbers of other people easily, using either the phone or the User Options web pages.

If you have the Personal Directory service available on your phone, you can enter numbers using that service (see the [“Searching Personal Address Book Entries on Your Phone” section on page 5-6.](#))

You can also enter numbers into the Personal Address Book on the User Options web pages (see the [“Creating a New Address Book Entry on the Web” section on page 5-4.](#))

To phone these numbers quickly, you can set them up as either speed dials, which appear directly on your phone (see the [“Using Speed Dial” section on page 3-12](#)) or you can set them up as Fast Dials, if the phone service is available to you, (see the [“Using Fast Dials” section on page 5-12.](#))

**Related Topics**

- [Managing Your Contacts, page 5-1](#)

# I've used up all my speed dial lines, can I add more?

If you assigned numbers to all of the speed dial buttons on your phone, there are two ways to store numbers for fast retrieval:

- Add a Cisco IP Phone 7914 Expansion Module to your phone, and get an additional 14 speed dial lines (see [Chapter 6, “Using the Cisco IP Phone 7914 Expansion Module.”](#))
- Use Fast Dials to store the rest of your phone numbers (see the [“Using Fast Dials”](#) section on page 5-12.)

## Related Topics

- [Managing Your Contacts, page 5-1](#)

# If I cannot answer a call that I have forwarded to another number, will the call get re-routed to my voice mail system?

Yes—as long as the forwarded call is not picked up by a person or a mechanical answering machine. Although call forwarding sends an incoming call intended for your Cisco IP Phone to another number, your Cisco IP Phone does not relinquish the forwarded call unless the call is answered (in other words, picked up by a person or a mechanical answering machine). Your Cisco IP Phone considers a forwarded call “unanswered” after a certain number of rings. Unanswered, forwarded calls are redirected to your voice mail system (if one is available).

## Related Topics

- [Using Voice Mail, page 3-21](#)

## Can I use call forwarding to send my calls directly to voice mail, without ringing my desk top phone?

Yes. Follow the procedure in the [“Setting Up Call Forwarding on Your Phone” section on page 3-14](#) and choose the **Voice Mail** option.

### Related Topics

- [Using Voice Mail, page 3-21](#)

## Why don't I get a dial tone after dialing an access code?

If you use an access code, such as 9, to make external calls, your Cisco IP Phone might not make a dial tone. Continue dialing your call.

### Related Topics

- [Making Telephone Calls, page 3-1](#)



## Safety Notices

---

Read the following safety notices before installing or using your Cisco IP Phone:  
These safety notices apply to phones in the Cisco IP Phone 7960 and 7940 series.



**Warning**

---

**This warning symbol means danger. You are in a situation that could cause bodily injury. Before you work on any equipment, be aware of the hazards involved with electrical circuitry and be familiar with standard practices for preventing accidents.**

---



**Warning**

---

**Read the installation instructions before you connect the system to its power source.**

---



**Warning**

---

**Ultimate disposal of this product should be handled according to all national laws and regulations.**

---



**Warning**

---

**The plug-socket combination must be accessible at all times because it serves as the main disconnecting device.**

---



**Warning**

---

**Do not work on the system or connect or disconnect cables during periods of lightning activity.**

---

**Warning**

---

**To avoid electric shock, do not connect safety extra low voltage (SELV) circuits to telephone network voltage (TNV) circuits. LAN ports contain SELV circuits, and WAN ports contain TNV circuits. Some LAN and WAN ports use RJ-45 connectors. Use caution when connecting cables.**

---

The following warnings apply when you use the external power supply with the Cisco IP Phone:

**Warning**

---

**This product relies on the building's installation for short-circuit (over current) protection. Ensure that a fuse or circuit breaker no larger than 120 VAC, 15A U.S. (240 VAC, 10A international) is used on the phase conductors (all current-carrying conductors).**

---

**Warning**

---

**The device is designed to work with TN power systems.**

---





## Troubleshooting Your Phone

---

This appendix contains procedures and troubleshooting information you might need to diagnose problems with your phone or to help install your phone.

The information in this appendix is only necessary if your administrator asks you to perform one of the procedures.

- [Accessing Network Configuration Data, page C-1](#)
- [Accessing Status Data, page C-2](#)
- [Accessing Network Configuration Data, page C-1](#)
- [Using the Quality Reporting Tool, page C-4](#)

## Accessing Network Configuration Data

You might need to access network configuration data to help your system administrator troubleshoot a problem that you are experiencing with your phone. Only a system administrator or technician can alter this data.

Follow these steps to access network configuration data.

### Procedure

---

- Step 1** Press the **Settings** button.
- Step 2** From the Settings menu, use the Navigation button to select **Network Configuration**.

**Step 3** Press the **Select** softkey.

From here, you can use the Navigation button to view your Network Configuration information, such as Host Name, Domain Name, IP Address, MAC address, TFTP server, and so on.

---

#### Related Topics

- [Accessing Network Configuration Data, page C-1](#)
- [Troubleshooting Cisco CallManager Extension Mobility, page C-3](#)
- [Using the Quality Reporting Tool, page C-4](#)

## Accessing Status Data

Your network administrator or technician might want to access status information to monitor the performance of your phone.

Follow these steps to access status data.

#### Procedure

---

**Step 1** Press the **Settings** button.

**Step 2** From the Settings menu, use the Navigation button to select **Status**.

**Step 3** Press the **Select** softkey.

The Settings Status submenu appears.

**Step 4** Use the Navigation button to select the item that you want to view and press the **Select** softkey.

From here, you can view Status Messages, Network Statistics, Firmware Versions, and Expansion Module Statistics for your phone.

---

**Related Topics**

- [Accessing Network Configuration Data, page C-1](#)
- [Troubleshooting Cisco CallManager Extension Mobility, page C-3](#)
- [Using the Quality Reporting Tool, page C-4](#)

# Troubleshooting Cisco CallManager Extension Mobility

Use [Table C-1](#) to troubleshoot error codes and messages displayed on your Cisco IP Phone.

**Table C-1 Troubleshooting Error Messages**

Error Code or Message	Recommended Action for Users
0, 2, 3, 6, 9, 12, 100, 101 HTTP error	When you try to log in to Cisco CallManager Extension Mobility, the phone displays one of these error codes or error messages.  Provide your system administrator with the information displayed on the phone.
Invalid host	
No services configured	
Requesting...	
Device does not allow logon	
Device profile unavailable	
Authentication error	After you enter your UserID and PIN, the phone displays “Authentication error.”  The system does not recognize your User ID or your PIN. Perform these steps: <ol style="list-style-type: none"> <li>1. Try to log in again to confirm that you did not make a mistake when you entered your UserID and PIN.</li> <li>2. If you receive the error message again, contact your system administrator to check that you have the correct UserID and PIN.</li> </ol>

**Table C-1 Troubleshooting Error Messages (continued)**

Error Code or Message	Recommended Action for Users
System not enabled for login	<p>After you enter your UserID and PIN, the phone displays “System not enabled for login.”</p> <p>Ask your system administrator to enable the Cisco CallManager Extension Mobility service.</p>
User logged in elsewhere	<p>After you enter your UserID and PIN, the phone displays “User Logged in elsewhere.”</p> <p>You are still logged in to the last phone you used with Cisco CallManager Extension Mobility. You can be logged in to only one phone at a time.</p> <p>Log yourself out of the phone where you are still logged in. (Or, contact your system administrator to log you out.) Then, you can log in at the phone that you want to use.</p>

**Related Topics**

- [Logging Into Your Extension from Any Phone Using the Cisco CallManager Extension Mobility Feature, page 4-1](#)
- [Accessing Network Configuration Data, page C-1](#)
- [Accessing Status Data, page C-2](#)
- [Using the Quality Reporting Tool, page C-4](#)

## Using the Quality Reporting Tool

Your administrator may temporarily configure your Cisco IP Phone with the Quality Reporting Tool to troubleshoot problems with your phone calls. With the Quality Reporting Tool, you can use the QRT softkey to submit information about problem phone calls to your system administrator.

Depending on how your system administrator configured the Quality Reporting Tool for your phone, you can use the QRT softkey in one of two ways:

- To quickly report an audio problem with a current call, press the **QRT** softkey.

Your phone will display: Audio quality data will be collected and logged.

- After you press the **QRT** softkey, you may be presented with a list of phone menu options to provide more details about the problem. Follow the instructions on the phone to submit the quality report information.

Your phone will display: Your feedback has been logged.

In either scenario, press the **Exit** softkey to return to the previous screen.

The system routes the data or information you submitted to your system administrator to troubleshoot problems with your phone calls.

#### Related Topics

- [Accessing Network Configuration Data, page C-1](#)
- [Accessing Status Data, page C-2](#)
- [Troubleshooting Cisco CallManager Extension Mobility, page C-3](#)





---

## Symbols

- ? button
  - about [1-10](#)
  - identifying [1-8](#)

---

## A

- about this book [xi](#)
- address book synchronizer
  - configuring [5-11](#)
  - installing [5-9](#)
- answering calls [3-4](#)
- AutoAnswer, answering calls with [3-4](#)
- auto-registering your phone [1-5](#)

---

## B

- barge, about [3-20](#)
- busy lines, using Cisco Call Back [3-8](#)

---

## C

- cable connections on your phone [1-4](#)
- call park, and storing calls [3-9](#)

- call pickup
  - about [3-10](#)
  - answering calls outside your group [3-11](#)
  - answering calls within your group [3-11](#)
- Cisco Call Back, about [3-8](#)
- Cisco CallManager Extension Mobility
  - about [4-1](#)
  - changing your PIN [4-5](#)
  - logging in [4-2](#)
  - logging out [4-4](#)
- Cisco IP Phone 7914 Expansion Module
  - about [6-1](#)
  - features [6-2](#)
  - more information [6-3](#)
- conference calls
  - about [3-17](#)
  - placing [3-18](#)
- connecting your phone [1-2](#)
- contacts
  - about [5-1](#)
  - synchronizing [5-9](#)
- conventions, document [xvii](#)

---

**D**

dial pad, identifying [1-9](#)

directories

- button, about [1-10](#)
- button, identifying [1-8](#)
- dialing numbers with [3-23](#)

documentation

- conventions [xvii](#)
- feedback [xiv](#)
- obtaining [xiii](#)
- related [xii](#)

---

**E**

ending calls [3-4](#)

---

**F**

FAQ (Frequently Asked Questions) [A-1](#)

fast dials

- about [5-12](#)
- assigning dial codes [5-13](#)
- deleting entries [5-15](#)
- placing calls with [5-20](#)
- subscribing [5-12](#)

feature buttons, about [1-10](#)

feedback, documentation [xiv](#)

footstand

- adjusting [1-3](#)
- identifying [1-8](#)

forwarding

- calls [3-14](#)
- canceling call forwarding [3-16](#)

Frequently Asked Questions (FAQ) [A-1](#)

---

**H**

handset rest, adjusting [1-12](#)

handsets

- about [1-8](#)
- adjusting volume [2-1](#)
- answering a call with [3-4](#)
- ending a call with [3-4](#)
- placing a call with [3-2](#)
- using [1-12](#)

headset button, identifying [1-8](#)

headsets

- adjusting volume [2-1](#)
- answering a call with [3-4](#)
- ending calls with [3-5](#)
- ordering [1-14](#)
- placing a call with [3-2](#)
- using [1-14](#)

help button

- about [1-10](#)
- identifying [1-8](#)



hold

- putting calls on [3-6](#)
- resuming held calls [3-6](#)

---

## I

installing your phone [1-2](#)  
 introduction [1-1](#)

---

## L

language  
   on user options web pages [1-17](#)  
 LCD screen, identifying [1-8](#)  
 line buttons, identifying [1-8](#)  
 logging in  
   Cisco CallManager Extension Mobility [4-2](#)  
   user options web pages [1-16](#)  
 logging out, Cisco CallManager Extension  
   Mobility [4-4](#)

---

## M

meet-me conferences  
   about [3-18](#)  
   establishing [3-19](#)  
   joining [3-19](#)  
 messages button  
   about [1-10](#)  
   and voice mail [3-21](#)

identifying [1-9](#)

message waiting indicator light  
   about [1-8](#)  
 missed calls, viewing [3-21](#)  
 multiple lines  
   and placing calls [3-2](#)  
   using hold with [3-6](#)  
 mute button, identifying [1-8](#)  
 muting calls [3-5](#)

---

## N

navigating on your phone [1-11](#)

---

## P

personal address book  
   about [5-2](#)  
   creating new entries [5-4](#)  
   deleting entries [5-8](#)  
   placing a call with [5-9](#)  
   subscribing [5-2](#)  
 phone logs, about [3-21](#)  
 PIN, changing for Cisco CallManager  
   Extension Mobility [4-5](#)  
 placed calls, viewing [3-21](#)  
 placing a call [3-2](#)  
 power supply [1-3](#)

**R**

received calls, viewing [3-21](#)  
 redial [3-8](#)  
 redialing [3-3](#)  
 related documentation [xii](#)  
 ringer sound  
   personalizing [2-3](#)  
 ringer volume  
   adjusting [2-2](#)

**S**

services  
   about [1-18](#)  
   button, about [1-10](#)  
   button, identifying [1-9](#)  
   personalizing [1-20](#)  
   subscribing [1-19](#)  
   unsubscribing [1-20](#)  
 settings button  
   about [1-10](#)  
   identifying [1-8](#)  
 softkeys, about [1-9](#)  
 speaker button, identifying [1-8](#)  
 speakerphone  
   adjusting volume [2-1](#)  
   answering a call with [3-4](#)  
   ending calls with [3-5](#)

  placing a call with [3-2](#)  
   using [1-14](#)  
 speed dial  
   about [3-12](#)  
   buttons, identifying [1-8](#)  
 storing calls, using call park [3-9](#)  
 subscribing  
   fast dials [5-12](#)  
   personal address book [5-2](#)  
   services [1-19](#)  
 subscriptions  
   ending [1-20](#)  
 synchronizing contacts [5-9](#)

**T**

TAC (Technical Assistance Center) [xv](#)  
 TAPS (Tool for Auto-Registered Phones Support) [1-5](#)  
 technical assistance, obtaining [xiv](#)  
 Technical Assistance Center (TAC) [xv](#)  
 Tool for Auto-Registered Phone Support (TAPS) [1-5](#)  
 transferring calls [3-7](#)

**U**

user options web pages  
   about [1-15](#)  
   changing the language [1-17](#)

logging in [1-16](#)

---

## V

voice mail

using [3-21](#)

volume

adjusting ringer volume [2-2](#)

adjusting volume of caller [2-1](#)

button, identifying [1-9](#)

---

## W

warnings, translated [xviii](#)



## Free Manuals Download Website

<http://myh66.com>

<http://usermanuals.us>

<http://www.somanuals.com>

<http://www.4manuals.cc>

<http://www.manual-lib.com>

<http://www.404manual.com>

<http://www.luxmanual.com>

<http://aubethermostatmanual.com>

Golf course search by state

<http://golfingnear.com>

Email search by domain

<http://emailbydomain.com>

Auto manuals search

<http://auto.somanuals.com>

TV manuals search

<http://tv.somanuals.com>