

**Experts In Home Cleaning™**

**CLEANview™**  
POWER  
cyclonic

 **CLEANview™**  
CYCLONIC **pet**

## USER'S GUIDE

80E7 and 28F4 SERIES 220-240V

- 2 Thank You
- 3 Safety Instructions
- 4 Product View
- 5 Assembly
- 6-7 Operations
- 8-12 Maintenance and Care
- 13-14 Troubleshooting
- 14 Replacement Parts
- 15 Warranty
- 16 Consumer Services



## Thanks for buying a BISSELL Cleanview™ Cyclonic

We're glad you purchased a BISSELL Cleanview cyclonic vacuum. Everything we know about floor care went into the design and construction of this complete, high-tech home cleaning system.

Your BISSELL Cleanview cyclonic vacuum is well made, and we back it with a limited one year warranty. We also stand behind it with a knowledgeable, dedicated Consumer Services department, so, should you ever have a problem, you'll receive fast, considerate assistance.

My great-grandfather invented the floor sweeper in 1876. Today, BISSELL is a global leader in the design, manufacture, and service of high quality homecare products like your BISSELL Cleanview cyclonic vacuum.

Thanks again, from all of us at BISSELL.

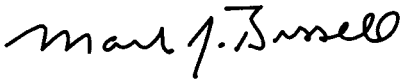

**Mark J. Bissell**  
Chairman, President & CEO

# IMPORTANT SAFETY INSTRUCTIONS

When using an electrical appliance, basic precautions should be observed, including the following:

## READ ALL INSTRUCTIONS BEFORE USING YOUR UPRIGHT VACUUM.

### **WARNING: To reduce the risk of fire, electric shock, or injury:**

- Do not use outdoors or on wet surfaces.
- Do not leave machine when it is plugged in.
- Do not use with damaged cord or plug.
- If appliance is not working as it should, has been dropped, damaged, left outdoors, or dropped into water, return it to a service agent.
- Do not pull or carry by cord, use cord as a handle, close door on cord, pull cord around sharp corners or edges, run appliance over cord, or expose cord to heated surfaces.
- Do not unplug by pulling on cord. Unplug by grasping plug.
- Do not handle plug or appliance with wet hands.
- Do not expose hair, loose clothing, fingers or body parts to openings or moving parts.
- Do not pick up hot or burning objects such as cigarettes, matches, or hot ashes.
- Do not pick up flammable or combustible materials (lighter fluid, petrol, kerosene, etc.) or use in the presence of explosive liquids or vapour.
- Do not use appliance in an enclosed space filled with vapours given off by oil base paint, paint thinner, some moth proofing substances, flammable dust, or other explosive or toxic vapours.
- Not intended for use by persons (including children) with reduced physical, sensory or mental capabilities, or lack of experience and knowledge, unless they have been given supervision or instruction concerning use of the appliance by a person responsible for their safety

- Young children should be supervised to ensure that they do not play with the appliance.
- Remove plug from electrical outlet before cleaning or maintaining the appliance.
- If the supply cord is damaged, it must be replaced by the manufacturer or its service agent in order to avoid a hazard.
- Do not pick up toxic material (chlorine bleach, ammonia, drain cleaner, petrol, etc.).
- Do not allow to be used as a toy.
- Do not use for any purpose other than described in this User's Guide.
- Use only manufacturer's recommended attachments.
- Do not use with any opening blocked; keep free of dust, lint, hair, and anything that may reduce air flow.
- Keep appliance on a level surface.
- Turn off all controls before unplugging.
- Be extra careful when cleaning stairs.
- This appliance is provided with double insulation. Use only identical replacement parts.
- Do not use without the dirt container and filters in place.
- Pay close attention when working around children.
- Unplug before attaching TurboBrush™ tool.
- Do not pick up hard or sharp objects such as glass, nails, screws, coins, etc.

## SAVE THESE INSTRUCTIONS FOR FUTURE USE

This model is for household use only.

### **IMPORTANT** FOR OPERATION ON A 220-240 VOLT A.C. 50/60 Hz POWER SUPPLY ONLY.

If your appliance is fitted with a nonrewireable BS 1363 plug it must not be used unless a 13 amp (ASTA approved to BS 1362) fuse is fitted in the carrier contained in the plug. (Spares may be obtained from your BISSELL supplier). If for any reason the plug is cut off, it must be disposed of, as it is an electric shock hazard should it be inserted into a mains socket.

# Product view

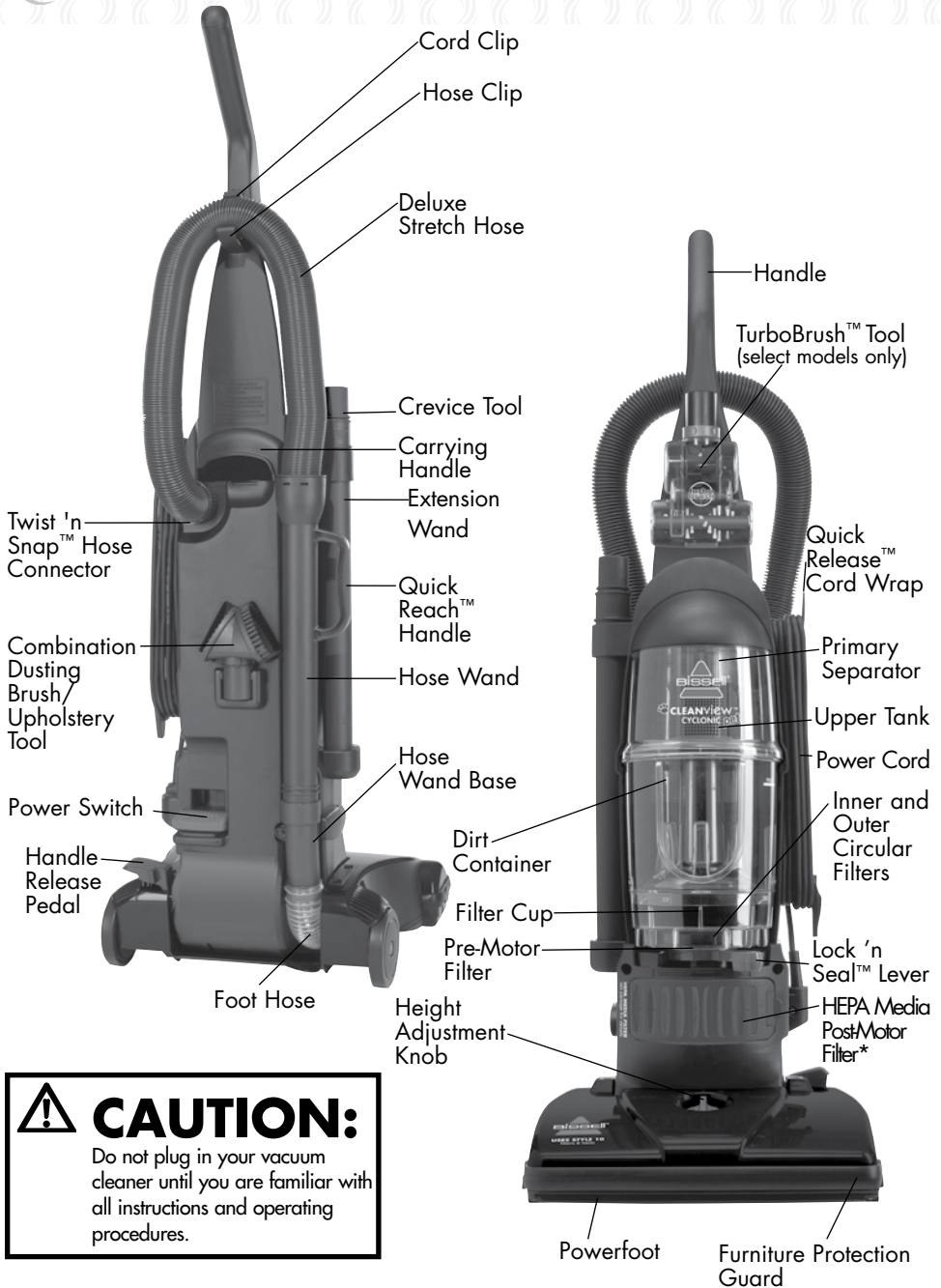

## CAUTION:

Do not plug in your vacuum cleaner until you are familiar with all instructions and operating procedures.

## Assembly

**The only tool you'll need to assemble your vacuum cleaner is a screwdriver.**

### **Attach handle to vacuum**

1. Locate the vacuum handle and remove the screw packet taped to the base of the handle.
2. Stand the vacuum upright and place the handle on the top of the vacuum body.
3. Insert the screws into the existing holes on each side. Tighten securely with a screwdriver.

### **Attach vacuum hose and tools**

1. Attach the Twist 'n Snap hose by lining up the tabs on the base with the corresponding notches on the back of the vacuum.
2. Turn the Twist 'n Snap hose to the right to lock the hose into place.
3. Grasping the Quick Reach handle, slide the end of the hose wand into the hose wand base. Snap the hose into the hose clip.

**NOTE: The powerfoot will not operate effectively unless the hose wand is firmly attached.**

4. Slide the extension wand and the crevice tool together into the storage clip on the side of the vacuum.
5. Snap the combination tool into the storage clip on the back of the vacuum.
6. **Select models only:** The TurboBrush tool bracket slides into the front of the handle. Attach the bracket by aligning the pegs with the holes on the handle and pulling down until it locks into place.
7. **Select models only:** Place the TurboBrush tool in the bracket by aligning the bottom of the bracket with the opening of the brush roll and snap the TurboBrush tool into place.

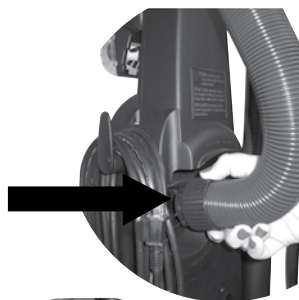

# Operations

## Handle position

Press the handle release pedal with your foot to place your **BISSELL Cleanview cyclonic bagless vacuum into one of three cleaning positions.**

1. **Upright-** For storage and above floor cleaning with special tools.
2. **Normal Cleaning-** Press handle release pedal once. Use for most household floor cleaning tasks.
3. **Low Cleaning-** With the vacuum in normal cleaning position, press handle release pedal again. Use for reaching under low furniture such as tables, chairs and beds.

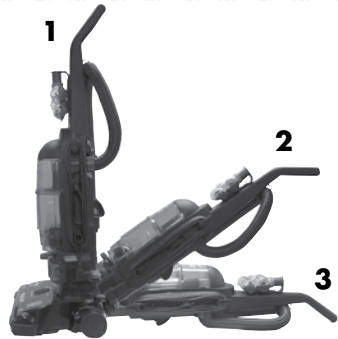

## Powerfoot height adjustment

The powerfoot/rotating floor brush on your **BISSELL Cleanview cyclonic bagless vacuum can be adjusted to clean several floor surfaces.**

**NOTE:** For optimal cleaning performance, adjust to the lowest practical setting. If your cleaner is difficult to push, adjust to the next higher setting.

1. Place handle in upright position.
2. Turn height adjustment knob to desired setting.  
**Lowest Setting -** For bare floors.  
**Medium Settings -** For short and medium pile carpets.  
**Highest Setting -** For plush pile carpets.
3. Place the handle into the normal cleaning position and the powerfoot will adjust to the setting chosen.

**NOTE:** You may also adjust the setting while in the normal cleaning position.

## Transporting cleaner

1. To move your cleaner from room to room, put the handle in the upright position, tilt the cleaner back on its rear wheels and push forward.
2. The cleaner can also be moved by using the carrying handle on the back.



## CAUTION:

Before using your vacuum, make sure that the dirt container is in locked position and that all filters (inner circular, outer circular, pre-motor and post-motor) are in place. Do not operate your vacuum without these filters.

## ATTENTION:

Some Berber carpets have a tendency to fuzz with wear. Repeated strokes in the same area may aggravate this condition. Consider setting your cleaner on a higher than normal setting for this type of carpet.



*Tip:*

Before cleaning under low furniture, check area first for objects that might harm the unit or block the vacuum hose.



Carrying Handle

*Tip:*

Your vacuum features a Quick Release cord wrap. To remove the power cord quickly and easily, rotate the upper cord wrap towards the floor, and slip power cord from upper and lower cord wraps.

# Operations

## Special tools

Your **BISSELL Cleanview cyclonic bagless vacuum is not only a powerful carpet and rug vacuum cleaner, it's also a versatile above floor vacuum cleaner when you select one of the special tools.**

1. Raise handle to upright position.
2. Grasp the Quick Reach handle and lift hose wand to separate from suction intake opening.
3. Attach tools by firmly pushing onto vacuum hose or extension wand.

### Combination Dusting Brush/Upholstery Tool:

Two types of cleaning tools are included in one attachment; rotate for desired tool.

- Use brush side to dust furniture, blinds, books, lamps, shelves and baseboards.
- Use upholstery side for curtains, draperies, cushions and fabrics.

**Crevice Tool:** Use in tight, narrow spaces.

**Extension Wand:** Use with desired attachment for a longer reach.

### TurboBrush tool:

(Select models only)

Use rotating brush action for small areas such as stairs and upholstery.

**NOTE: Press gently when using the TurboBrush tool to gain maximum cleaning. Too much pressure will cause the brush to stop rotating.**

## Power cord

**When you are done using your BISSELL Cleanview Cyclonic Bagless vacuum, return it to the upright position and store the power cord.**

1. Turn power switch OFF.
2. Unplug power cord by grasping the plug (NOT the cord) and disconnect from outlet.
3. Loop power cord around cord wraps on side of vacuum cleaner.
4. Clip molded plug to power cord to secure.

## NOTICE:

The floor brush will continue to rotate while you use your vacuum for above floor cleaning. To prevent carpet damage, do not lean on the vacuum or let the powerfoot tilt forward.



*Tip:*

Hair, string and small objects can block the vacuum hose or tools. Check them occasionally for obstructions.



## CAUTION:

The rotating floor brush continues to rotate while tools are in use. To reduce the risk of injury from moving parts, always move the cleaner with the carrying handle at the back of the cleaner. Always place the vacuum cleaner on the floor with the handle in upright position when using tools. Never place your fingers under the cleaner when it is running. Never place powerfoot on furniture or uneven surfaces. Do not place vacuum cleaner close enough to objects to pull them into rotating brush.

## NOTICE:

While vacuuming, certain carpets and low humidity conditions may generate small static discharges. The discharges are entirely harmless and are not associated in any way with the main power supply.

# Maintenance and care

To maintain maximum cleaning performance from your BISSELL Cleanview cyclonic bagless vacuum, perform these simple maintenance steps.

1. Empty the dirt container when the dirt reaches the "Full" line on the side.
2. Check the inner and outer circular filters, and the pre-motor filter at least once a month and clean or replace as needed.
3. Replace the HEPA media post-motor filter\* every three to six months.

**Note: More frequent filter cleaning or replacing may be necessary if you are vacuuming new carpet, fine dust, or have allergy concerns. Follow the instructions on the following pages to perform these simple maintenance steps.**

## Emptying dirt container

The dirt container needs to be emptied when the dirt reaches the "Full" line on the side of the container.

1. Unplug cleaner from electrical outlet.
2. Slide the Lock 'n Seal lever to the "Unlock" position.
3. Grasp handle and pull dirt container straight out to remove from vacuum.
4. Empty dirt into garbage container.
5. Put dirt container back in the vacuum and slide the lever to the "Lock" position.

**Note: The dirt container may be washed in warm water with a mild detergent. Remove the filter cup from the bottom before washing. Make sure it is completely dry before reassembling with the filter cup.**



## WARNING:

To reduce the risk of electric shock, turn power switch OFF and disconnect plug from electrical outlet before performing maintenance or troubleshooting checks.

*Tip:*

For maximum cleaning performance, check and clean or replace all filters as suggested.





# Maintenance and care

## Cleaning the inner & outer circular filters

1. Unplug cleaner from electrical outlet.
2. Remove the dirt container as described in the previous section. Grasp the filter cup located at the bottom of the dirt container and twist counterclockwise to unlock and remove.
3. Grasp the circular filters and pull straight up to remove.
4. Separate the outer foam and inner pleated circular filters. Wash each individually by hand in warm water. Mild detergent may be used if desired. Rinse well, then air dry thoroughly before putting them back together and replacing in filter cup.
5. The filter cup may be washed in warm water with a mild detergent. Make sure it is completely dry before reassembling with filters.
6. The upper tank and primary separator may be wiped clean with a damp cloth. Reach underneath the upper tank and turn the rim of the primary separator to remove. Pull straight down to remove.

### **NOTICE:**

This product is intended for household use only and not for commercial or industrial use. Vacuuming of dust from products like plaster, concrete or ashes will damage the motor and void the warranty.



## Cleaning the pre-motor filter

1. Unplug the cleaner from electrical outlet.
2. The pre-motor filter protects the motor from debris. It is located underneath the dirt container and filter cup in the center of the round part of the Lock 'n Seal lever.
3. Remove the small, round, pre-motor filter and any debris on top of it. Rinse well under warm water, then air dry thoroughly before replacing.



### **WARNING:**

Do not operate cleaner with damp or wet filters or without all filters in place.

Pre-Motor Filter

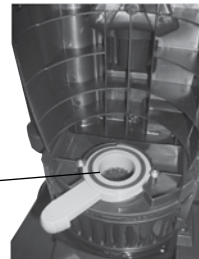

# Maintenance and care

## Replacing the HEPA media post-motor filter \*

The post-motor filter is a H13 HEPA media filter\*, which assists in the filtration process to return clean air to the room.

1. Unplug the vacuum from electrical outlet.
2. Remove the filter door, located on the front of the vacuum.
3. Remove the post motor filter.
4. Replace the post-motor filter with a new filter.

**NOTE: The post-motor filter is a white pleated HEPA media filter\*. This filter is NOT washable and must be replaced when it becomes dirty.**

5. Replace the door by inserting the tabs on the left side and snapping the right side into place.

HEPA  
Media  
Post-Motor  
Filter\*

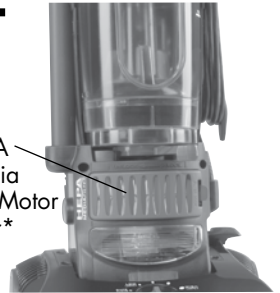

## **WARNING:**

To reduce the risk of injury from moving parts, turn the power switch OFF and disconnect plug from electrical outlet.

## Maintaining the TurboBrush tool

(Select models only.)

The TurboBrush tool should be checked regularly for clogs or debris wrapping around the brush roll.

1. Remove TurboBrush tool from hose or front of vacuum.
2. Twist collar so opening is at the top and lift top cover to remove.
3. Remove brush from belt and clean debris.
4. Replace brush inside belt and place ends into slots on sides.
5. Reposition top cover, making sure to line up the inside tab at the front with the opening on the cover. Twist collar until opening is at the bottom to lock into place.

2.



4.

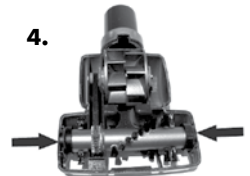

5.

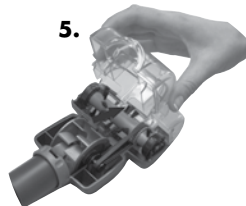

\*The Filter Media, not the vacuum as a whole, complies with the High Efficiency Particulate Air (HEPA) filter specification (EN 1822-1:2009).

# Maintenance and care

## Check rotating floor brush and drive belt

You should check your vacuum cleaner's rotating floor brush and drive belt regularly for wear or damage. You should also clean the brush and brush ends of string, hair and carpet fibers. These can wrap around the brush and hamper its ability to effectively clean your carpet. Also remove any debris that has accumulated under the brush cover.

1. Unplug cleaner from electrical outlet.
2. Place handle in low position and turn vacuum cleaner over so bottom side is up.
3. Remove the two screws from the brush cover (as shown) with a Phillips head screwdriver. Lift the brush cover off.
4. Grasp rotating floor brush at both ends and lift.
5. Clean strings, hair and other debris from rotating floor brush, paying particular attention to brush ends.
6. Clean strings, hair and other debris from motor pulley and drive belt areas.
7. Check drive belt carefully for wear, cuts or stressed areas. Replace if worn or damaged.
8. Check air passageway for obstructions. Remove debris from this area.

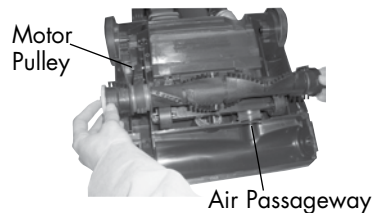
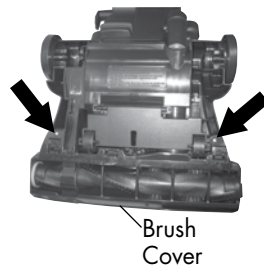

## Replace drive belt

1. Unplug cleaner from electrical outlet.
2. With rotating floor brush removed from vacuum cleaner (Steps 1-4 of "Check rotating floor brush and drive belt"), grasp old drive belt and remove from motor pulley. Discard old drive belt.
3. Place new drive belt over motor pulley and stretch other end over rotating floor brush in the space between the bristles.
4. Place ends of rotating floor brush down into slots on sides as shown.
5. Turn rotating floor brush by hand several times in direction of motor pulley. If properly installed, drive belt will center itself on rotating brush.
6. Reposition brush cover and replace two screws. Make sure end of brush cover is snapped into place.

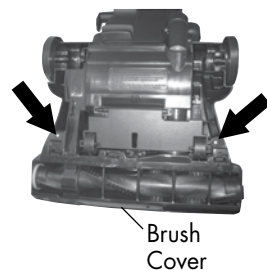

# Maintenance and care

## Clearing clog

**Low suction, poor pickup or no suction may be due to a clog in the vacuum cleaner. If you notice a change in the sound of the vacuum motor or a reduction in the spinning action in the dirt container, check for clogs.**

1. Unplug cleaner from electrical outlet.
2. Empty dirt container.
3. Check upper tank and primary separator for build up or clogs. Check to make sure primary separator is installed correctly. To unlock the primary separator, grasp the rim and turn toward the left. Pull straight down to remove. If the primary separator is missing or not locked into place, check and clear the tube in the center of the dirt container and properly install primary separator.
4. Remove the Twist 'n Snap hose from the vacuum by turning to the left. Check the suction inlet, hose and hose wand for clogs. Remove any clogs from the hose using a long, narrow object such as a broomstick.
5. Check the foot hose for clogs. If needed, remove the screw attaching the hose wand base to the vacuum. Straighten the foot hose and unclog with a long, narrow object such as a broomstick.
6. If the clog persists, follow the instructions for checking the rotating floor brush on page 11 and inspect the air passageway for obstructions.

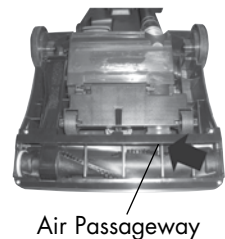
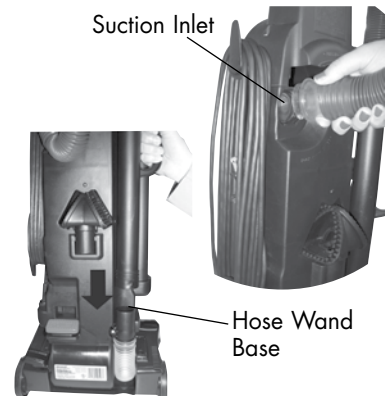
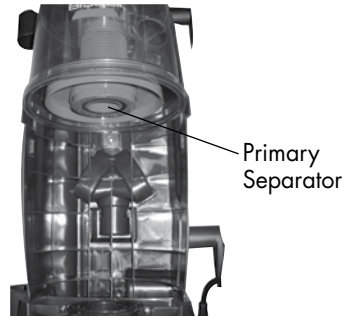

# Troubleshooting



## WARNING:

To reduce the risk of electric shock, turn power OFF and disconnect plug from electrical outlet before performing maintenance or troubleshooting.

### Vacuum cleaner won't turn on

#### Possible causes

1. Power cord not firmly plugged in

#### Remedies

1. Check electrical plug

### Vacuum cleaner won't pick up dirt

#### Possible causes

1. Incorrect height adjustment
2. Hose not attached to suction opening
3. Twist 'n Snap hose not securely attached
4. Crack or hole in hose
5. Broken or worn drive belt
6. Rotating floor brush bristles worn
7. Rotating floor brush jammed
8. Clog in vacuum
9. Dirt container full
10. Dirt container not installed properly
11. Filters are dirty
12. Primary separator missing or installed incorrectly

#### Remedies

1. Adjust powerfoot to correct height setting
2. Grasp Quick Release handle and firmly push hose wand onto the suction opening.
3. Make sure Twist 'n Snap hose is snapped into locked position
4. Check hose and replace if needed
5. Replace drive belt, see page 11
6. Replace brush
7. Remove brush and clean debris from brush ends
8. Follow instructions for clearing clogs on page 12
9. Empty dirt container
10. Position correctly and lock in place
11. Check and clean inner and outer circular filters and , pre-motor filter, replace post-motor filter
12. Check for a clog in the tube in the center of the dirt container, clear and properly install primary separator

### Tools won't pick up dirt

#### Possible causes

1. Crack or hole in hose
2. Vacuum hose, wand or tools clogged
3. Dirt container full
4. Dirt container or upper tank not installed properly
5. Filters are dirty
6. Primary separator missing or installed incorrectly

#### Remedies

1. Check hose and replace if needed
2. Follow instructions for clearing clogs on page 12
3. Empty dirt container
4. Position correctly and lock in place
5. Check and clean inner and outer circular filters and , pre-motor filter, replace post-motor filter
6. Check for a clog in the tube in the center of the dirt container, clear and properly install primary separator

### Vacuum cleaner difficult to push

#### Possible causes

1. Incorrect height adjustment
2. Rotating floor brush not rotating

#### Remedies

1. Adjust powerfoot to correct height setting
2. Check drive belt and brush

### Visible dirt escaping from cleaner

#### Possible causes

1. Dirt container full
2. Filters missing or installed incorrectly

#### Remedies

1. Empty dirt container
2. Check inner and outer circular filter and post-motor filter for correct installation

# Troubleshooting

## Visible dirt escaping from cleaner continued

### Possible causes

3. Dirt container installed incorrectly
4. Filter cup installed incorrectly

### Remedies

3. Position correctly and lock into place
4. Remove dirt container and make sure filter cup is fully attached

**Other maintenance or service not included in the manual should be performed by an authorized service representative.**

**Thank you for selecting a BISSELL product.**

**Please do not return this product to the store.**

## Replacement parts -

Item	Part No.	Part Name
1	32074	Style 7/9/10/12/14 Drive Belt (2-Pack)
2	203-1056	Crevice Tool
3	203-1059	Combination Dusting Brush/Upholstery Tool
4	203-1068	Extension Wand
5	203-1216	Twist 'n Snap Vacuum Hose (Select Models Only)
6	203-5624	Brush Roll
7	32064	Style 9/10/12 Inner & Outer Circular Filter Set
8	32065	Style 9/10/12 Inner Circular Filter only
9	3205	Style 12 HEPA Media Filter*
10	203-1215	Pre-Motor Filter
11	203-1429	TurboBrush



\*The Filter Media, not the vacuum as a whole, complies with the High Efficiency Particulate Air (HEPA) filter specification (EN 1822-1:2009).

# Warranty

This warranty gives you specific legal rights, and you may also have other rights which may vary from country to country. If you need additional instruction regarding this warranty or have questions regarding what it may cover, please contact BISSELL Consumer Services by telephone, or regular post as described below, or contact your local in country distributor.

## Limited One Year Warranty

Subject to the \*EXCEPTIONS AND EXCLUSIONS identified below, BISSELL Homecare, Inc., will replace (with new or remanufactured components), at BISSELL's option, free of charge from the date of purchase by the original purchaser, for one year any defective or malfunctioning part do to manufacturers defect.

This warranty applies to product used for personal, and not commercial or rental service. This warranty does not apply to fans or routine maintenance components such as filters, belts, or brushes. Damage or malfunction caused by negligence, abuse, or use not in accordance with the User's Guide is not covered.

### For UK inquiries:

Monday - Thursday 9 am — 5 pm

Friday 9 am — 4 pm

### BISSELL Homecare (Overseas) Inc.

Ground Floor

226 Berwick Avenue

Slough

Berkshire, SL1 4QT

United Kingdom

Telephone: 0844-888-6644

### For spare parts and accessories:

Monday - Friday 9 am — 5:30 pm

### Exserve Ltd.

550, Peterborough

Cambridgeshire, PE2 6WH

Telephone: 01733-362415

BISSELL HOMECARE INC. IS NOT LIABLE FOR INCIDENTAL OR CONSEQUENTIAL DAMAGES OF ANY NATURE ASSOCIATED WITH THE USE OF THIS PRODUCT. BISSELL'S LIABILITY WILL NOT EXCEED THE PURCHASE PRICE OF THE PRODUCT.

### \*EXCEPTIONS AND EXCLUSIONS FROM THE TERMS OF THE LIMITED WARRANTY

THIS WARRANTY IS EXCLUSIVE AND IN LIEU OF ANY OTHER WARRANTIES EITHER ORAL OR WRITTEN. ANY IMPLIED WARRANTIES WHICH MAY ARISE BY OPERATION OF LAW, INCLUDING THE IMPLIED WARRANTIES OF MERCHANTABILITY AND FITNESS FOR A PARTICULAR PURPOSE, ARE LIMITED TO THE ONE YEAR DURATION FROM THE DATE OF PURCHASE AS DESCRIBED ABOVE.

## If your BISSELL product should require service:

Call BISSELL Consumer Services at the numbers below and we will give you the location of a BISSELL Authorized Service Center in your area. For all other countries, contact your local in country distributor for questions, service, or repair.

If you have questions about your warranty or need replacement parts please contact the numbers below.

### For UK inquiries:

Monday - Thursday 9 am — 5 pm

Friday 9 am — 4 pm

### BISSELL Homecare (Overseas) Inc.

Ground Floor

226 Berwick Avenue

Slough

Berkshire, SL1 4QT

United Kingdom

Telephone: 0844-888-6644

### For spare parts and accessories:

Monday - Friday 9 am — 5:30 pm

### Exserve Ltd.

550, Peterborough

Cambridgeshire, PE2 6WH

Telephone: 01733-362415

Or visit the BISSELL website - [www.bissell.com](http://www.bissell.com)

When contacting BISSELL, have model number of cleaner available.

Please record your Model Number: \_\_\_\_\_

Please record your Purchase Date: \_\_\_\_\_

**NOTE: Please keep your original sales receipt. It provides proof of purchase date in the event of a warranty claim. See Warranty on page 15 for details.**



Experts In Home Cleaning™

©2011 BISSELL Homecare, Inc  
Grand Rapids, Michigan  
All rights reserved. Printed in China  
Part Number 110-4353  
Rev 3/11  
Visit our website at:  
[www.bissell.com](http://www.bissell.com)



## Free Manuals Download Website

<http://myh66.com>

<http://usermanuals.us>

<http://www.somanuals.com>

<http://www.4manuals.cc>

<http://www.manual-lib.com>

<http://www.404manual.com>

<http://www.luxmanual.com>

<http://aubethermostatmanual.com>

Golf course search by state

<http://golfingnear.com>

Email search by domain

<http://emailbydomain.com>

Auto manuals search

<http://auto.somanuals.com>

TV manuals search

<http://tv.somanuals.com>