



**XL** ULTIMATE ESPORTS  
GAMING MONITOR

Gaming is in the Details

**XL2420T / XL2420TX**

**User Manual**

## Copyright

Copyright © 2012 by BenQ Corporation. All rights reserved. No part of this publication may be reproduced, transmitted, transcribed, stored in a retrieval system or translated into any language or computer language, in any form or by any means, electronic, mechanical, magnetic, optical, chemical, manual or otherwise, without the prior written permission of BenQ Corporation.

## Disclaimer

BenQ Corporation makes no representations or warranties, either expressed or implied, with respect to the contents hereof and specifically disclaims any warranties, merchantability or fitness for any particular purpose. Further, BenQ Corporation reserves the right to revise this publication and to make changes from time to time in the contents hereof without obligation of BenQ Corporation to notify any person of such revision or changes.

## Power Safety



Please follow these safety instructions for best performance, and long life for your monitor.

---

- The AC plug isolates this equipment from the AC supply.
- The power supply cord serves as a power disconnect device for pluggable equipment. The socket outlet should be installed near the equipment and be easily accessible.
- This product should be operated from the type of power indicated on the marked label. If you are not sure of the type of power available, consult your dealer or local power company.
- An approved power cord greater or equal to H03VV-F or H05VV-F, 2G or 3G, 0.75mm<sup>2</sup> must be used.

## Care And Cleaning

- **Cleaning.** Always unplug your monitor from the wall outlet before cleaning. Clean the LCD monitor surface with a lint-free, non-abrasive cloth. Avoid using any liquid, aerosol or glass cleaners.
- Slots and openings on the back or top of the cabinet are for ventilation. They must not be blocked or covered. Your monitor should never be placed near or over a radiator or heat source, or in a built-in installation unless proper ventilation is provided.
- Never push objects or spill liquid of any kind into this product.

## Servicing

Do not attempt to service this product yourself, as opening or removing covers may expose you to dangerous voltages or other risks. If any of the above mentioned misuse or other accident such as dropping or mishandling occurs, contact qualified service personnel for servicing.

## BenQ ecoFACTS

BenQ has been dedicated to the design and development of greener product as part of its aspiration to realize the ideal of the "Bringing Enjoyment 'N Quality to Life" corporate vision with the ultimate goal to achieve a low-carbon society. Besides meeting international regulatory requirement and standards pertaining to environmental management, BenQ has spared no efforts in pushing our initiatives further to incorporate life cycle design in the aspects of material selection, manufacturing, packaging, transportation, using and disposal of the products. BenQ ecoFACTS label lists key eco-friendly design highlights of each product, hoping to ensure that consumers make informed green choices at purchase. Check out BenQ's CSR Website at <http://csr.BenQ.com/> for more details on BenQ's environmental commitments and achievements.







# Table of Contents

Copyright .....	2
Disclaimer .....	2
Power Safety .....	2
Getting started .....	5
Getting to know your monitor .....	7
Front view.....	7
Back view .....	7
How to assemble your monitor hardware .....	9
How to detach the stand and the base .....	15
Adjusting the monitor height .....	17
Rotating the monitor .....	18
Viewing angle adjustment.....	19
Using the monitor wall mounting kit .....	20
Getting the most from your BenQ monitor .....	21
How to install the monitor on a new computer .....	22
How to upgrade the monitor on an existing computer .....	23
How to install on Windows 7 system .....	24
How to install on Windows Vista systems .....	25
How to watch 3D content on your monitor .....	26
How to adjust your monitor .....	28
The control panel.....	28
The S Switch .....	29
Basic menu operation.....	30
Picture optimization .....	32
Customizing the hot keys.....	32
Setting up your own game mode .....	32
Downloading more game modes using Game Mode Loader .....	33
Adjusting display mode .....	33
Using Smart Scaling.....	34
Using Instant Mode.....	34
Navigating the main menu .....	35
Display menu .....	36
Picture menu .....	38
Picture Advanced menu .....	40
Save Settings menu .....	44
Audio menu .....	45
System menu .....	46
Troubleshooting .....	50
Frequently asked questions (FAQ) .....	50
Need more help?.....	52

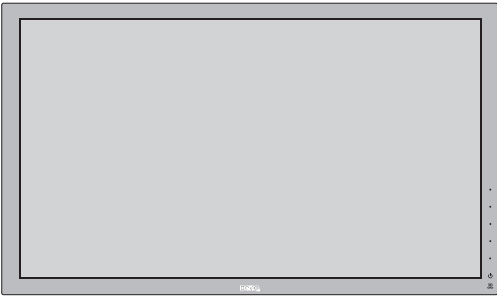
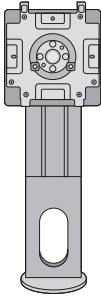
## Getting started

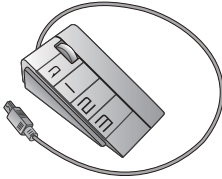
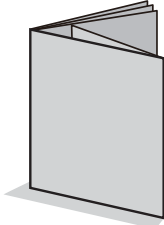
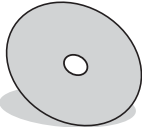
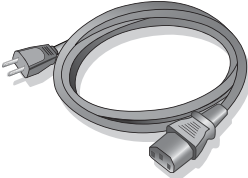
When unpacking please check you have the following items. If any are missing or damaged, please contact the place of purchase for a replacement.

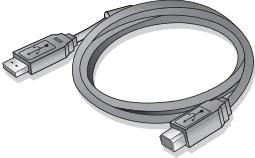
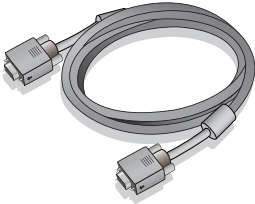
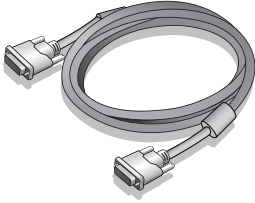
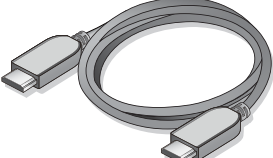
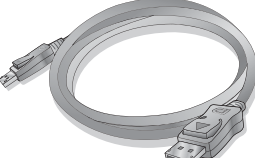
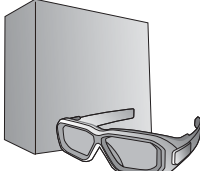
BenQ LCD Monitor	
Monitor Stand	
Monitor Base	
S Switch (Swift Switch)	
Quick Start Guide	
CD-ROM	
Power Cord (Picture may differ from product supplied for your region.)	

USB Cable	
Video Cable: D-Sub	
Video Cable: DVI-D Dual Link	
Video Cable: HDMI (Optional accessory)	
Video Cable: DP (Optional accessory)	
NVIDIA 3D Vision Kit (XL2420TX only)	
Protective cover	
Headphone hook (Pre-installed, can be removed)	



Consider keeping the box and packaging in storage for use in the future when you may need to transport the monitor. The fitted foam packing is ideal for protecting the monitor during transport.



Always keep the product and accessories out of reach of small children.

# Getting to know your monitor

## Front view

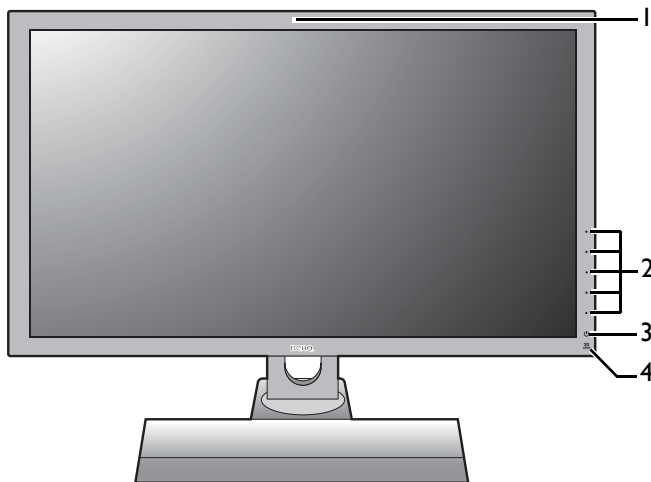

1. Infrared (IR) sensor (XL2420TX only)
2. Control buttons
3. Power button
4. Infrared (IR) emitter indicator

## Back view

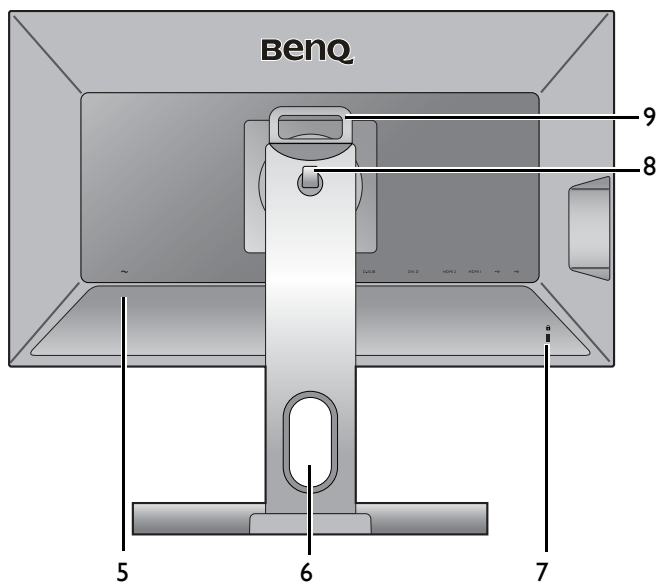

5. AC Power Input jack
6. Cable management hole
7. Kensington lock slot
8. Headphone hook
9. Handle

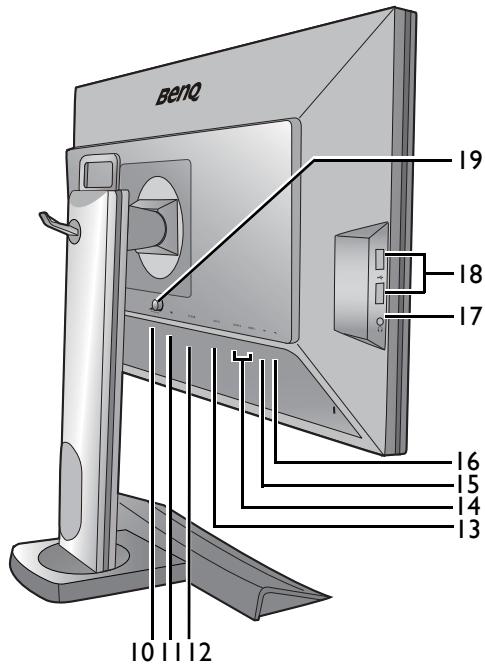

- 10. S Switch socket
- 11. DisplayPort socket
- 12. D-Sub socket
- 13. DVI-D socket
- 14. HDMI socket x 2
- 15. USB port (upstream; connecting to the PC)
- 16. USB port (downstream; connecting to USB devices)
- 17. Headphone jack
- 18. USB port x 2 (downstream; connecting to USB devices)
- 19. VESA mount release button



# How to assemble your monitor hardware



If the computer is turned on you must turn it off before continuing.  
Do not plug-in or turn-on the power to the monitor until instructed to do so.

## I. Attach the monitor base.



Please be careful to prevent damage to the monitor. Placing the screen surface on an object like a stapler or a mouse will crack the glass or damage the LCD substrate voiding your warranty. Sliding or scraping the monitor around on your desk will scratch or damage the monitor surround and controls.

Protect the monitor and screen by clearing a flat open area on your desk and placing a soft item like the monitor packaging bag on the desk for padding.

Gently lay the screen face down on a flat clean padded surface.

Orient and align the stand base socket with the end of the stand arm. Make sure that the locking tabs at the end of the stand bypass the retaining plates on the stand, then push the stand and the base together. If the base is properly attached, the arrow at the end of the stand should point to **RISER UNLOCK**.

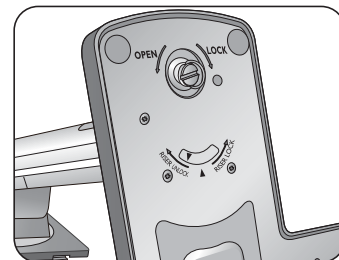
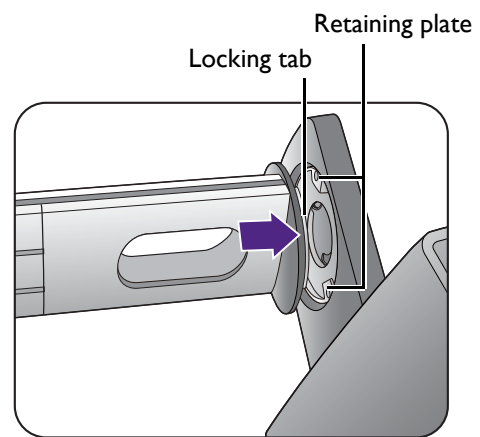

Turn the stand counterclockwise to align the arrow at the end of the stand with the one on the monitor base (1). Raise the thumbscrew lid (2) and tighten the thumbscrew as illustrated (3). Then push the lid back.

Gently attempt to pull them back apart to check that they have properly engaged.

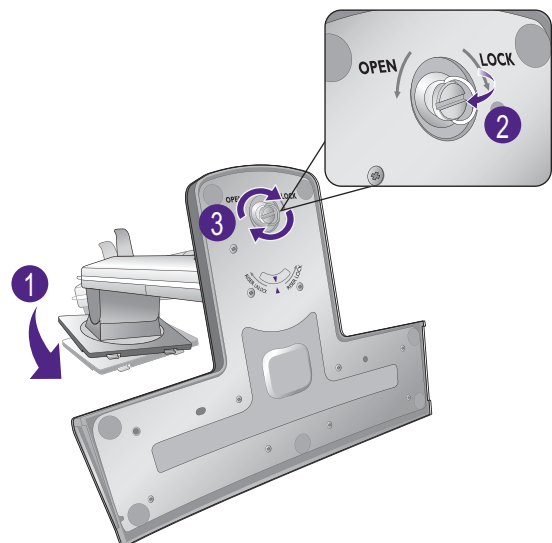

Orient and align the stand arm with the monitor (1), push them together until they click and lock into place (2).

Gently attempt to pull them back apart to check that they have properly engaged.

Carefully lift the monitor, turn it over and place it upright on its stand on a flat even surface.

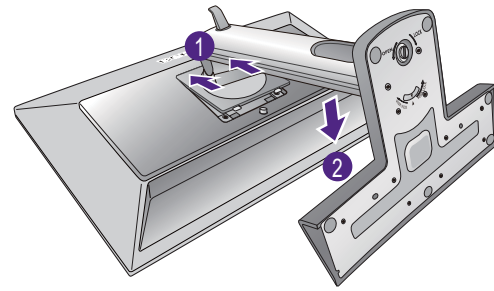

To move the monitor, you must hold the handle and the bottom of the stand base at the same time as illustrated. You can protect the monitor using the supplied protective cover.

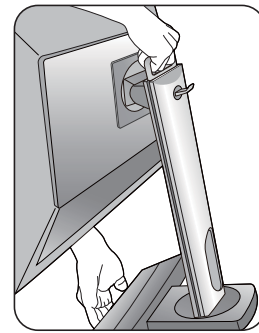

You might want to adjust the monitor stand height. See [Adjusting the monitor height on page 17](#) for more information.

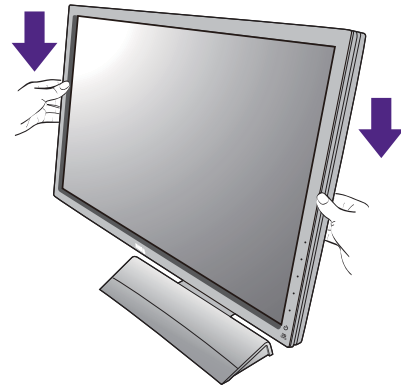

You should position the monitor and angle the screen to minimize unwanted reflections from other light sources.

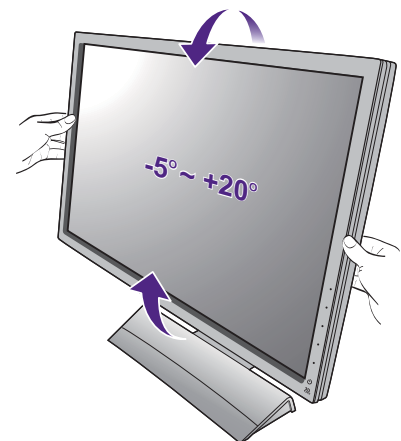

## 2. Connect the PC video cable



Do not use both DVI-D cable and D-Sub cable on the same PC. The only case in which both cables can be used is if they are connected to two different PCs with appropriate video systems.

### To Connect the D-Sub Cable

Connect the plug of the D-Sub cable (at the end without the ferrite filter) to the monitor video socket. Connect the other end of the cable (at the end with the ferrite filter) to the computer video socket.

Tighten all finger screws to prevent the plugs from accidentally falling out during use.

### To Connect the DVI-D Dual Link Cable

Connect the plug of the DVI-D Dual Link cable to the monitor video socket. Connect the other end of the cable (at the end with the ferrite filter) to the computer video socket.

Tighten all finger screws to prevent the plugs from accidentally falling out during use.

### To Connect the HDMI Cable

Connect the plug of the HDMI cable to the HDMI port on the monitor. Connect the other end of the cable to the HDMI port of a digital output device.

Either

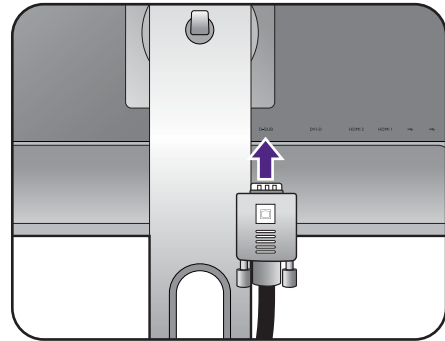

Or

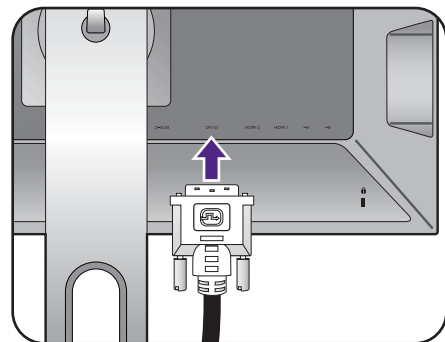

Or

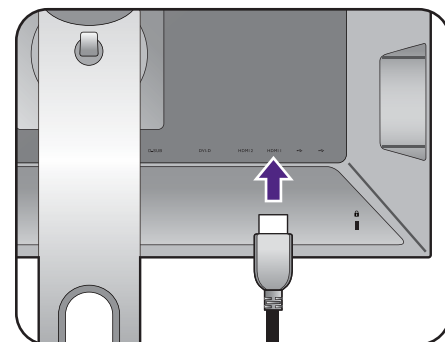

### To Connect the DP Cable

Connect the plug of the DP cable to the monitor video socket. Connect the other end of the cable to the computer video socket.



If there is more than one video transmission method available to you, you might want to take the picture quality of each video cable into consideration before making the connection.

- Better quality: HDMI / DVI-D / DP
- Good quality: D-Sub



The video cables included in your package and the socket illustrations on the right may vary depending on the product supplied for your region.

### 3. Connect the headphones.

You may connect headphones to the headphone jack found on the left side of the monitor.

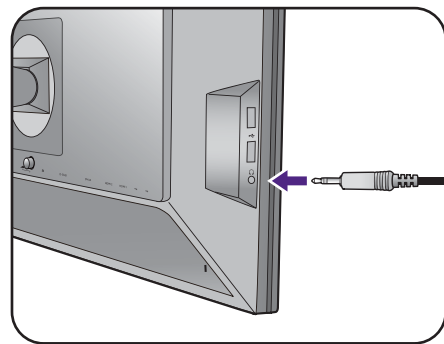
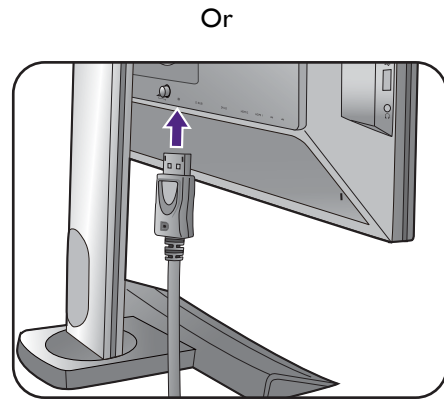

### 4. Connect USB devices.

Connect the USB cable between the PC and the monitor (via the upstream USB port at the back). This upstream USB port transmits data between the PC and the USB devices connected to the monitor.

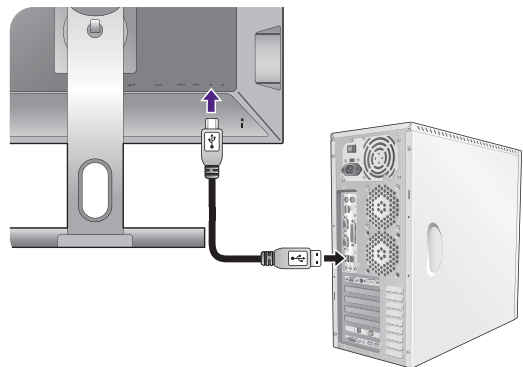

Connect USB devices via other USB ports (downstream) on the monitor. These downstream USB ports transmit data between connected USB devices and the upstream port.

See picture on the right.

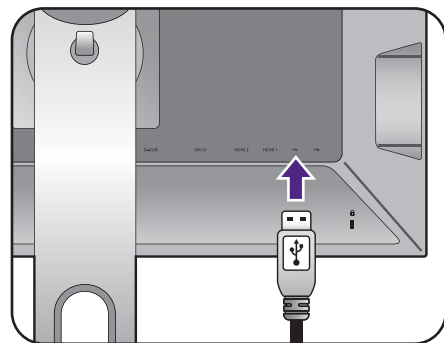

## 5. Connect the S Switch to the monitor.

Connect the S Switch to the S Switch socket found on the back of the monitor. And place the S Switch next to your monitor base.



You can place the S Switch either on the left or on the right of the monitor base.

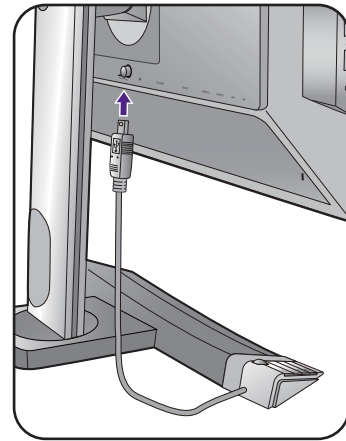

## 6. Connect the power cable to the monitor.

Plug one end of the power cord into the socket labelled  on the rear of the monitor. Do not connect the other end to a power outlet just yet.

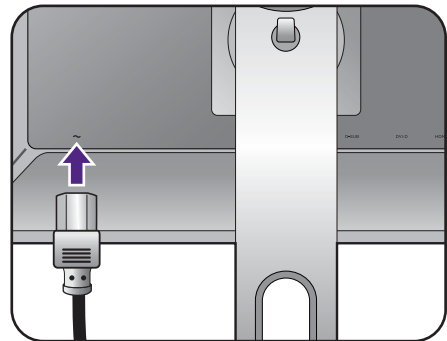

## 7. Organize the cables.

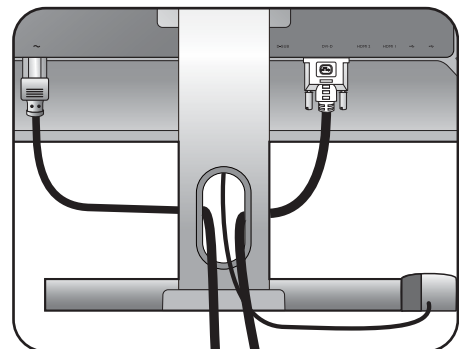

## 8. Connect-to and turn-on the power.

Plug the other end of the power cord into a power outlet and turn it on.



Picture may differ from product supplied for your region.

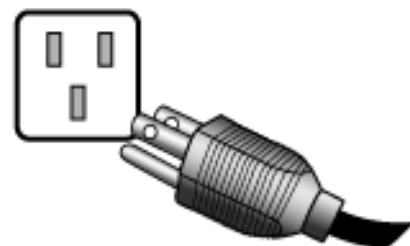

Turn on the monitor by pressing the power button on the monitor.

Turn on the computer too, and follow the instructions in [Getting the most from your BenQ monitor on page 21](#) to install the monitor software.



To extend the service life of the product, we recommend that you use your computer's power management function.



When the monitor is powered on, to prevent overheating, do not cover the monitor with the supplied protective cover or obstruct the ventilation holes.

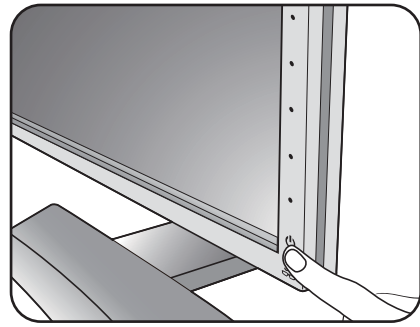

## How to detach the stand and the base

### 1. Prepare the monitor and area.

Turn off the monitor and the power before unplugging the power cable. Turn off the computer before unplugging the monitor signal cable.

Protect the monitor and screen by clearing a flat open area on your desk and placing a soft item like a towel on the desk for padding, before laying the screen face down on a flat clean padded surface.

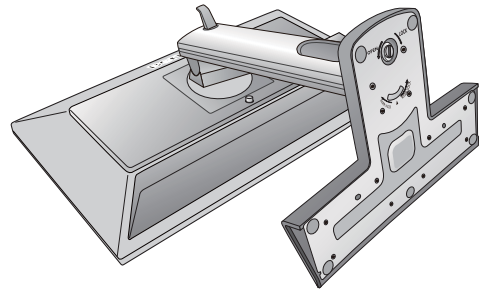

Please be careful to prevent damage to the monitor. Placing the screen surface on an object like a stapler or a mouse will crack the glass or damage the LCD substrate voiding your warranty. Sliding or scraping the monitor around on your desk will scratch or damage the monitor surround and controls.

### 2. Remove the monitor stand.

While pressing and holding the VESA mount release button (1), detach the stand from the monitor (2 and 3).

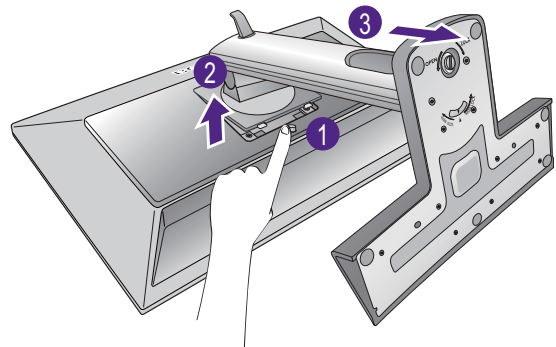

### 3. Remove the monitor base.

Align the arrow on the bottom of the stand with the one on the monitor stand. Raise the thumbscrew lid (1) and release the thumbscrew as illustrated (2).

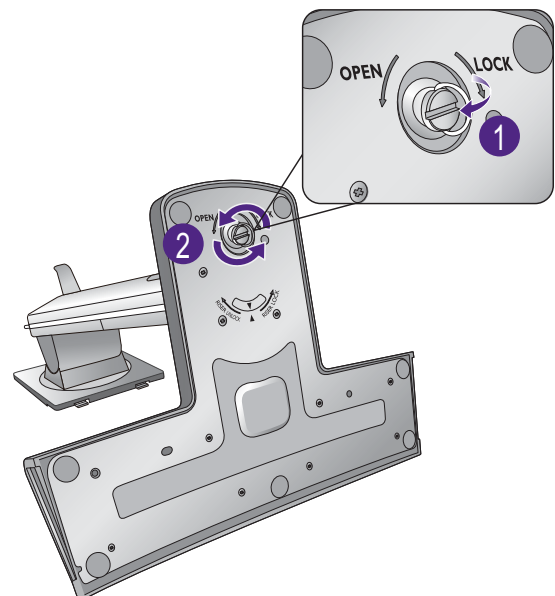

Turn the stand clockwise so that the arrow on the bottom of the stand points to **RISER UNLOCK**

(1). And then detach the base from the stand (2).

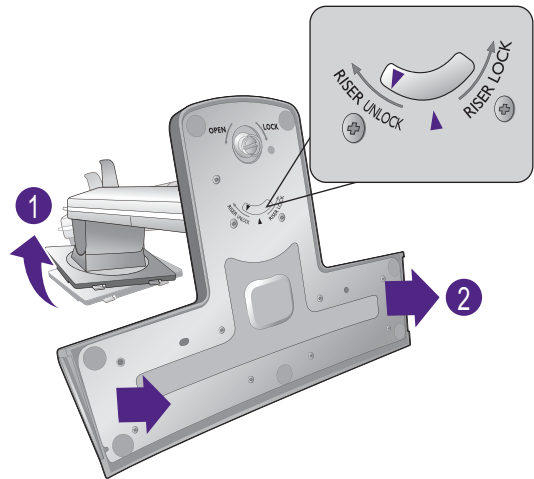

You can remove the headphone hook as illustrated. Keep the headphone hook somewhere safe.

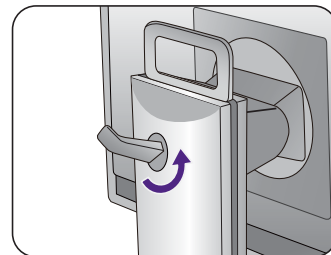



## Adjusting the monitor height

To adjust the monitor height, hold both the left and the right sides of the monitor to lower the monitor or lift it up to the desired height.

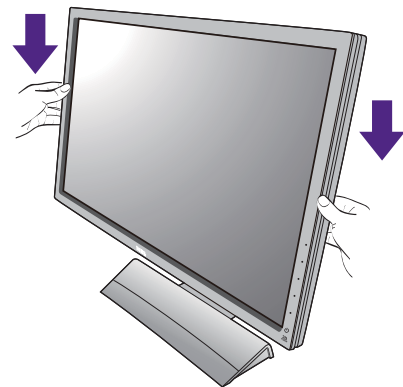
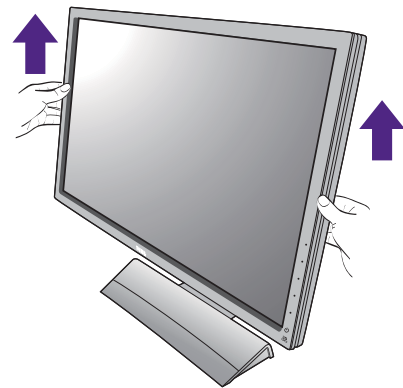

- Avoid placing hands on the upper or lower part of the height-adjustable stand or at the bottom of the monitor, as ascending or descending monitor might cause personal injuries. Keep children out of reach of the monitor while performing this operation.

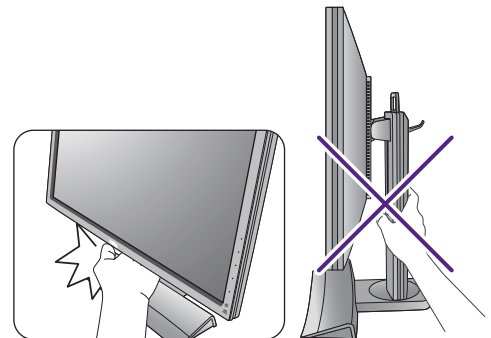

- If the monitor has been rotated to portrait mode and height adjustment is desired, you should be noted that the wide screen will keep the monitor from being lowered to its minimum height.

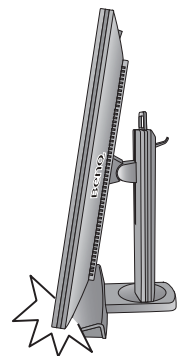

# Rotating the monitor

## 1. Pivot the display.

Before rotating the monitor with a portrait viewing orientation, the display has to be rotated 90 degrees.

Right-click the desktop and select **Screen resolution** from the popup menu. Select **Portrait in Orientation**, and apply the setting.



Depending on the operating system on your PC, different procedures should be followed to adjust the screen orientation. Refer to the help document of your operating system for details.

## 2. Fully extend the monitor and tilt it.

Gently lift the display up and extend it to the maximum extended position. Then tilt the monitor.



The monitor should be vertically extended to allow to rotate from landscape to portrait mode.

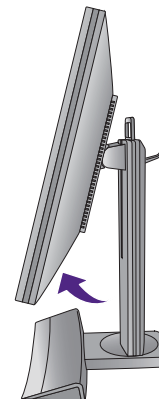
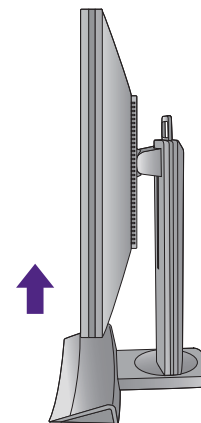

## 3. Rotate the monitor 90 degrees clockwise as illustrated.



To avoid the edge of the LCD display hitting the monitor base surface while it is being rotated, do tilt and extend the monitor to the highest position before you start to rotate the display. You should also make sure there are no obstacles around the monitor and there is enough room for cables.



4. Adjust the monitor to the desired viewing angle.



## Viewing angle adjustment

You may position the screen to the desired angle with  $-5^{\circ}$  to  $+20^{\circ}$  monitor tilt,  $70^{\circ}$  (left and right total) monitor swivel, and 130 mm monitor height.

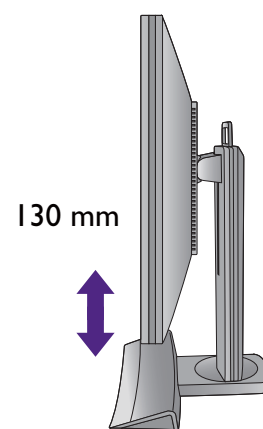
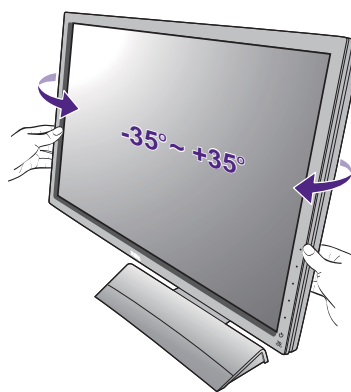
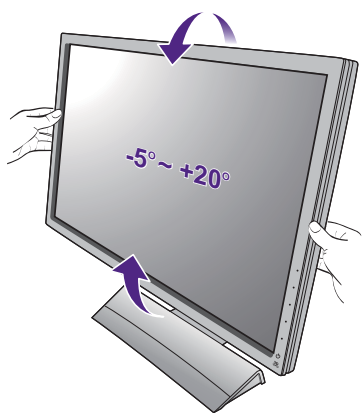

## Using the monitor wall mounting kit

The back of your LCD monitor has a VESA standard mount with 100mm pattern, allowing the installation of a wall mount bracket. Before starting to install a monitor wall mounting kit, please read the precautions carefully.



The maximum dimensions of the VESA mounting bracket compatible with your monitor are 125mm x 125mm.

### Precautions

- Install your monitor and monitor mounting kit on a wall with flat surface.
- Ensure that the wall material is stable to support the weight of the monitor.
- Turn off the monitor and the power before disconnecting the cables from the LCD monitor.

#### 1. Remove the monitor stand.

Detach the monitor stand as instructed in step 1~2 in [How to detach the stand and the base on page 15](#).

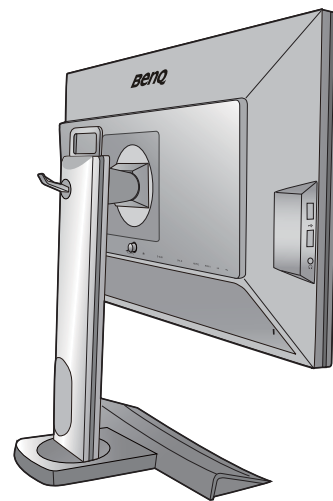

#### 2. Remove the screws on the back cover.

Use a cross-pointed screwdriver to release the screws on the back cover. The use of a magnetic-head screwdriver is recommended to avoid of losing the screws.



In case you intend to use your monitor on the stand in the future, please keep the monitor base, monitor stand, and screws somewhere safe for future use.

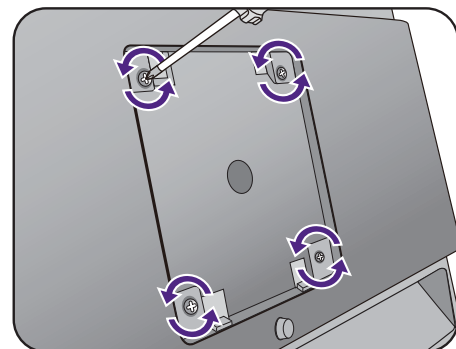

#### 3. Follow the instruction manuals of the wall mount bracket you purchased to complete the installation.

## Getting the most from your BenQ monitor

To gain the most benefit from your new BenQ color LCD flat screen monitor, you should install the custom BenQ LCD Monitor driver software as provided on the BenQ LCD Monitor CD-ROM.

The circumstances under which you connect and install your BenQ LCD Monitor will determine which process you need to follow to successfully install the BenQ LCD Monitor driver software. These circumstances relate to which version of Microsoft Windows you are using, and whether you are connecting the monitor and installing the software onto a new computer (without existing monitor driver software), or whether you are upgrading an existing installation (which already has existing monitor driver software) with a newer monitor.

In either case however, the very next time you turn on your computer (after connecting the monitor to your computer), Windows will automatically recognize the new (or different) hardware, and will launch its **Found New Hardware wizard**.

Follow the wizard instructions until it asks you to select a monitor model. At that point, click the **Have Disk** button, insert the BenQ LCD Monitor CD-ROM and select the appropriate monitor model. Further details and step-by-step instructions for either an automatic (new) or upgrade (existing) installation, see:

- [How to install the monitor on a new computer on page 22.](#)
- [How to upgrade the monitor on an existing computer on page 23.](#)



- If you require a User Name and Password to login to your Windows computer, you must be logged on as an Administrator or as a member of the Administrators group in order to install the monitor driver software. Furthermore, if your computer is connected to a network which has security access requirements, network policy settings may prevent you from installing software on your computer.
  - To check the name of the purchased model, refer to the specification label on the back of the monitor.
-

## How to install the monitor on a new computer

This instruction details the procedure for selecting and installing the BenQ LCD Monitor driver software on a new computer which has never had a monitor driver installed before. This instruction is only suitable for a computer which has never been used before, and for which the BenQ LCD Monitor is the first ever monitor to be connected to it.



If you are adding the BenQ LCD Monitor to an existing computer that has already had another monitor connected to it (and has monitor driver software installed), you should not be following these instructions. You should instead be following the instructions for [How to upgrade the monitor on an existing computer](#).

---

1. Follow the instructions in [Getting the most from your BenQ monitor on page 21](#).  
When Windows starts, it will automatically detect the new monitor and launch the **Found New Hardware Wizard**. Follow the prompts until it displays the option to **Install Hardware Device Drivers**.
2. Insert the BenQ LCD Monitor CD-ROM into a CD drive on the computer.
3. Check **Search for a suitable driver for my device** option, and click **Next**.
4. Check the option for CD-ROM drives (uncheck all others) and click **Next**.
5. Look to confirm that the wizard has selected the correct name of your monitor and click **Next**.
6. Click **Finish**.
7. Restart the computer.

## How to upgrade the monitor on an existing computer

This instruction details the procedure for manually updating the existing monitor driver software on your Microsoft Windows computer. It is currently tested as compatible for Windows Vista and Windows 7 Operating System (OS).



The BenQ LCD Monitor driver for your model may well function perfectly with other versions of Windows, however, as at the time of writing, BenQ has done no testing of this driver on other versions of Windows and cannot guarantee its operation on those systems.

---

Installing monitor driver software involves selecting an appropriate information file (.inf) on the BenQ LCD Monitor CD-ROM for the particular model monitor you have connected, and letting Windows install the corresponding driver files from the CD. You need only steer it in the right direction. Windows has an Upgrade Device Driver Wizard to automate the task and guide you through the file selection and installation process.

See:

- [How to install on Windows 7 system on page 24.](#)
- [How to install on Windows Vista systems on page 25.](#)

## How to install on Windows 7 system

1. Open **Display Properties**.

Go to **Start, Control Panel, Hardware and Sound, Devices and Printers** and right-click the name of your monitor from the menu.

Alternatively, right-click the desktop and select **Personalize, Display, Devices and Printers**, and right-click the name of your monitor from the menu.

2. Select **Properties** from the menu.
3. Click the **Hardware** tab.
4. Click **Generic PnP Monitor**, and then the **Properties** button.
5. Click the **Driver** tab and the **Update Driver** button.
6. Insert the BenQ LCD Monitor CD-ROM into a CD drive on the computer.
7. In the **Update Driver Software** window, select the option **Browse my computer for driver software**.
8. Click **Browse** and navigate to the following directory: d:\BenQ\_LCD\Driver\ (where d is the drive letter designator for the CD-ROM drive).



The drive letter for your CD drive may differ from the example above depending upon your system - it may be 'D:' or 'E:' or 'F:' etc.

---

9. Select the correct folder name of your monitor from provided driver list, and click **Next**.  
This will copy and install the appropriate monitor driver files to your computer.
10. Click **Close**.  
You may be prompted to restart your computer after the driver update is complete.



## How to install on Windows Vista systems

1. Open **Display Settings**.

Right-click the desktop and select **Personalize** from the popup menu.

Select **Display Settings** from the **Personalize appearance and sounds** window.

The **Display Settings** window will display.

2. Click the **Advanced Settings** button.

The **Generic PnP Monitor Properties** window will display.

3. Click the **Monitor** tab and the **Properties** button.

4. Click **Continue** in the prompted **User Account Control** window.

5. Click the **Driver** tab and the **Update Driver** button.

6. Insert the BenQ LCD Monitor CD-ROM into a CD drive on the computer.

7. In the **Update Driver Software** window, select the option **Browse my computer for driver software**.

8. Click **Browse** and navigate to the following directory: d:\BenQ\_LCD\Driver\ (where d is the drive letter designator for the CD-ROM drive).



The drive letter for your CD drive may differ from the example above depending upon your system – it may be 'D:' or 'E:' or 'F:' etc.

---

9. Select the correct folder name of your monitor from provided driver list, and click **Next**.

This will copy and install the appropriate monitor driver files to your computer.

10. Click **Close**.

You may be prompted to restart your computer after the driver update is complete.

## How to watch 3D content on your monitor

Your monitor supports playing three-dimensional (3D) content transferred through DVI-D Dual Link cable. Yet you need to have the appropriate hardware equipment and software programs that are compatible with 3D playback.



3D content can be transferred to XL2420TX through HDMI cable (version 1.3 or above) as well.



Not all menu options are available for 3D playback.

---

### System requirements

- BenQ LCD Monitor XL2420T / XL2420TX
- Compatible 3D glasses
- PC with Microsoft Windows Vista or Windows 7 Operating System
- Compatible graphics processing units (GPU) with the latest driver files installed
- Compatible software programs that play 3D playback

For the compatible accessories, visit

<http://www.nvidia.com/object/3d-vision-requirements.html>. For the appropriate 3D players, check with the 3D content providers.



- Contact NVIDIA or visit NVIDIA website (<http://www.nvidia.com/page/home.html>) for the purchase and the settings of the compatible GPU.
  - Visit the NVIDIA website ([www.nvidia.com/3DUpdate](http://www.nvidia.com/3DUpdate)) for the latest GPU driver files.
- 

### Playing 3D content

Follow the instruction manuals of your 3D accessories to install the hardware and the software. If the 3D glasses are properly connected and IR signal is detected, the IR emitter indicator on the bottom right of the monitor and on the IR emitter module (purchased separately for XL2420T) will light up.

To improve the performance of 3D glasses, you can do the following:

- On XL2420TX, check if there are any obstacles in front of the IR sensor located at the front top of the monitor that keep the sensor from receiving signals from the 3D glasses. Go to **System** and **Emitter Mode** and change the setting as needed. See [Emitter Mode \(XL2420TX only\) on page 48](#) for more information.
- On XL2420T or XL2420TX, follow the instruction manuals of the 3D accessories to make adjustment.

If you want to adjust the brightness when watching 3D content, go to **Picture** and **NVIDIA® 3D LightBoost™**. See [Brightness \(during 2D playback\) / NVIDIA® 3D LightBoost™ \(during 3D playback\) on page 38](#) for more information.



IR sensor is embedded in the front bezel of your XL2420TX and is not visible to you.

---

## Safety information for watching 3D content

- You may experience eye strain after watching 3D content for certain period of time. Take off the 3D glasses and take a rest to relieve the eye strain.
- If you experience headaches, dizziness, or nausea, stop watching 3D content immediately. You might need to consult a doctor if the symptoms last.
- Watching 3D content for a long period of time may increase health risks. For small children, the elderly, the pregnant women or people who have high blood pressure or other health concerns, consult a doctor before watching 3D content.

# How to adjust your monitor

## The control panel

All OSD (On Screen Display) menus can be accessed by the control keys.

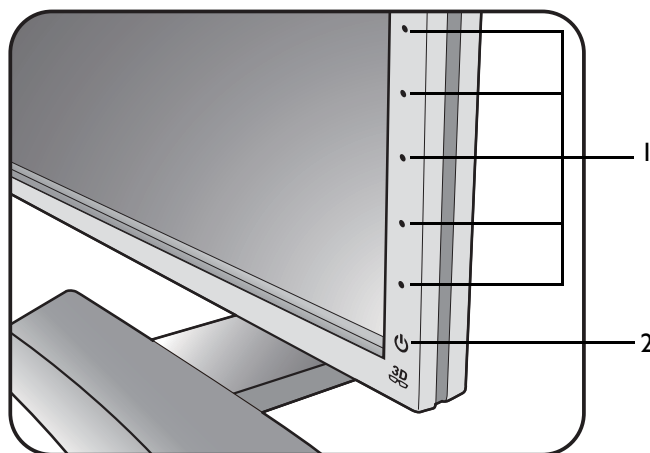

No.	Name	Description
1.	Control keys	Accesses the functions or menu items displayed on the screen, right next to each key.
2.	Power key	Turns the power on or off.



The control keys are embedded in a touchpad and are indicated by LED indicators. Touch of an LED indicator represents pressing the corresponding control key.

## The S Switch

Apart from the control keys, S Switch also provides a quick way to control and access the OSD menus.



You need to connect the S Switch to your monitor prior to use. Follow the instructions in [Connect the S Switch to the monitor.](#) on page 13.

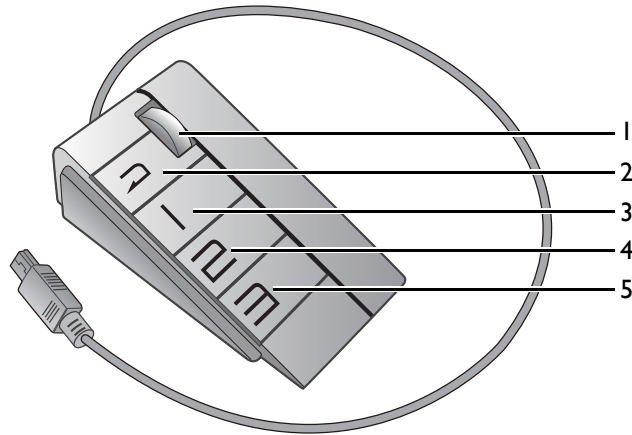

No.	Name	Function
1.	Wheel	<ul style="list-style-type: none"><li>• For Increase/Decrease adjustment.</li><li>• Scrolls Up/Down in a menu.</li><li>• Selects menu item by pressing once.</li></ul>
2.	Return button	Returns to the previous menu.
3.	Gamer 1 button	<ul style="list-style-type: none"><li>• Press to switch to <b>Gamer 1 (Picture Mode)</b>.</li><li>• Press and hold for 5 seconds to save the customized display settings for <b>Gamer 1</b>.</li></ul>
4.	Gamer 2 button	<ul style="list-style-type: none"><li>• Press to switch to <b>Gamer 2 (Picture Mode)</b>.</li><li>• Press and hold for 5 seconds to save the customized display settings for <b>Gamer 2</b>.</li></ul>
5.	Gamer 3 button	<ul style="list-style-type: none"><li>• Press to switch to <b>Gamer 3 (Picture Mode)</b>.</li><li>• Press and hold for 5 seconds to save the customized display settings for <b>Gamer 3</b>.</li></ul>



S Switch is designed for BenQ LCD Monitor XL2420T and XL2420TX exclusively. Do not connect it to other devices with USB ports.



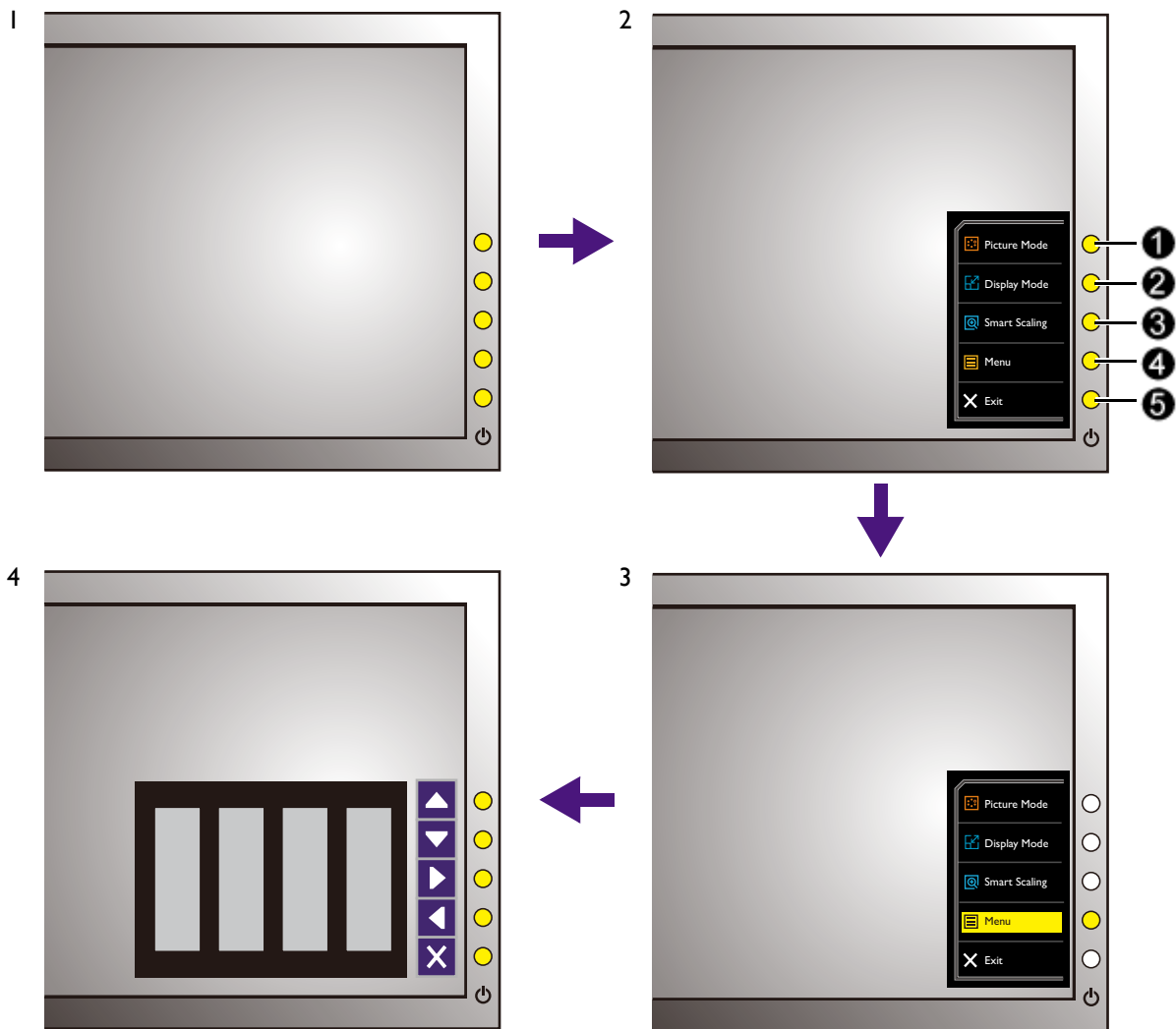

## Basic menu operation

You can use the OSD menu to adjust all the settings on your monitor.



1. Press any of the control keys. Alternatively, press the wheel or the return button on the S Switch.
2. The hot key menu is displayed. The top three controls are custom keys and are designated for particular functions.
3. Select **Menu** to access the main menu.
4. In the main menu, follow the icons next to the control keys to make adjustments or selection. See [Navigating the main menu on page 35](#) for details on the menu options.

No.	OSD in hot key menu	OSD icon in main menu	Function
①	Custom Key 1	▲	<ul style="list-style-type: none"> <li>• By default, the key is the hot key for <b>Picture Mode</b>. To change the default settings, see <a href="#">Customizing the hot keys on page 32</a>.</li> <li>• For Up/Increase adjustment.</li> </ul>

No.	OSD in hot key menu	OSD icon in main menu	Function
②	Custom Key 2		<ul style="list-style-type: none"> <li>• By default, the key is the hot key for <b>Display Mode</b>. To change the default settings, see <a href="#">Customizing the hot keys on page 32</a>.</li> <li>• For Down/Decrease adjustment.</li> </ul>
③	Custom Key 3	 / 	<ul style="list-style-type: none"> <li>• By default, the key is the hot key for <b>Smart Scaling</b>. To change the default settings, see <a href="#">Customizing the hot keys on page 32</a>.</li> <li>• Enters sub menus.</li> <li>• Selects menu items.</li> </ul>
④	Menu		<ul style="list-style-type: none"> <li>• Activates the main menu.</li> <li>• Returns to the previous menu.</li> </ul>
⑤	Exit		Exits OSD menu.



- OSD = On Screen Display.  
The hot keys only operate while the main menu is not currently displaying. Hot key displays will disappear after a few seconds of no key activity.
- To unlock the OSD controls, press and hold any key for 10 seconds.

## Picture optimization



The default picture mode is **FPS1**, which is designed for FPS games. If you prefer other picture modes, go to **Picture Advanced** and change setting in **Picture Mode**.

The easiest way to obtain an optimal display from an analog (D-Sub) input is to use the **Auto Adjustment** function. Go to **Display** and **Auto Adjustment** to optimize the currently displayed image to the screen.



When you connect a digital video output using a digital (DVI, HDMI, or DP) cable to your monitor, the **Auto Adjustment** function will be disabled, because the monitor will automatically display the best image.



Please ensure that the connected graphic card on your computer is set to the native resolution of the monitor when you use the **Auto Adjustment** function.

If you wish, you can always adjust the screen geometric settings manually using geometry menu items. To assist you in this endeavour, BenQ has provided a screen test image utility which you can use to check for screen color, grayscale and line gradient display.

1. Run the test program auto.exe from CD-ROM. You could also use any other image, such as the desktop of your operating system. However, we recommend that you use auto.exe. As you run auto.exe, a test pattern displays.
2. Press any of the control keys, or the wheel, or the return button on the S Switch to bring up the hot key menu. Select **Menu** to enter the main menu.
3. Go to **Display** and **Auto Adjustment**.
4. If you notice a vertical noise (like a curtain effect-shimmering of vertical lines), select **Pixel Clock** and adjust the monitor until the noise disappears.
5. If you notice a horizontal noise, select **Phase** and adjust the monitor until the noise disappears.

## Customizing the hot keys

The top 3 control keys (also called custom keys) perform as hot keys to provide direct access to pre-defined functions. You can change the default setting and designate different functions for these keys.

1. Press any of the control keys, or the wheel, or the return button on the S Switch to bring up the hot key menu.
2. Select **Menu** to access the main menu.
3. Go to **System**.
4. Select the custom key you want to change.
5. In the sub menu, select a function that can be accessed by this key. A pop-up message will appear, showing that the setup is complete.

## Setting up your own game mode

There are several preset picture modes on your monitor that are suitable for games. To better suit your needs, you can change and save the related display settings, and switch to your own game mode easily.

1. Adjust the related display settings in different OSD menus. Settings that can be customized for game mode are:



- Brightness (during 2D playback) / NVIDIA® 3D LightBoost™ (during 3D playback) (see page 38)
  - Contrast (see page 38)
  - Sharpness (see page 38)
  - Black eQualizer (see page 39)
  - Gamma (see page 39)
  - Color Temperature (see page 39)
  - Hue (see page 39)
  - Saturation (see page 39)
  - AMA (see page 39)
  - Instant Mode (see page 39)
  - Picture Mode (see page 40)
  - Display Mode (see page 41)
  - Dynamic Contrast (see page 41)
  - Smart Scaling (see page 42)
  - Smart Focus (see page 43)
  - Volume (see page 45)
  - Mute (see page 45)
2. After all settings are done, go to **Save Settings** and save as one of the game modes. Alternatively, press and hold one of the game mode buttons (labeled 1~3) on S Switch to save as one of the game modes.
  3. If you want to switch to your game mode at any time, go to **Picture Advanced** and **Picture Mode**, and select the game mode you saved in Step 2. Your preferred display settings will be applied all at once. Alternatively, press one of the game mode buttons (depending on your settings in Step 2) on S Switch to switch to the desired game mode quickly.



BenQ offers more optimized game modes on the website. If you prefer to use these settings, refer to [Downloading more game modes using Game Mode Loader on page 33](#).

---

## Downloading more game modes using Game Mode Loader

Instead of customizing your own display settings, you can download the game modes available on the BenQ website and apply the settings directly.

1. Link to [gaming.benq.com](http://gaming.benq.com).
2. Download and install the game mode loader.
3. Follow the on-screen instructions to complete the setup.
4. Go to **Picture Advanced** and **Picture Mode** on your monitor, and select the game mode you just downloaded to apply the settings directly.



Internet connection is required for this operation.

---

## Adjusting display mode

To display images of aspect ratios other than your monitor aspect ratio and sizes other than your display size, you can adjust the display mode on the monitor. For the aspect ratio and display size of your monitor, see the specifications on the CD.

1. Press any of the control keys, or the wheel, or the return button on the S Switch to bring up the hot key menu, and press **Menu** to access the main menu.
2. Go to **Picture Advanced** and **Display Mode**.
3. Select an appropriate display mode. The setting will take effect immediately.



Switch to the desired display mode first, and follow the instructions in [Using Smart Scaling on page 34](#) to adjust the display size to precisely suit your needs.

---

## Using Smart Scaling

You can resize your display by **Smart Scaling**.

1. Go to **Picture Advanced** and **Smart Scaling**.
2. Adjust the value.



- If one of the custom keys is preset for **Smart Scaling**, you can press the custom key and adjust the value directly.
  - Your display may become unstable temporarily when being resized. This is a normal phenomenon and should not be considered as manufacturing defect.
  - For more information on **Smart Scaling**, go to [Smart Scaling on page 42](#).
- 

## Using Instant Mode

While playing games, you can diminish the input lag by activating **Instant Mode**.

1. Go to **Picture** and **Instant Mode**.
2. Select **On**.

## Navigating the main menu

You can use the OSD (On Screen Display) menu to adjust all the settings on your monitor.

Press any of the control keys, or the wheel, or the return button on the S Switch to bring up the hot key menu. Select **Menu** to enter the main menu. See [Basic menu operation on page 30](#) for details.

Available menu options may vary depending on the input sources, functions and settings. Menu options that are not available will become grayed out. And keys that are not available will be disabled and the corresponding OSD icons will disappear.



The OSD menu languages may differ from the product supplied to your region, see [Language on page 47](#) under **System** and **OSD Settings** for more details.

---









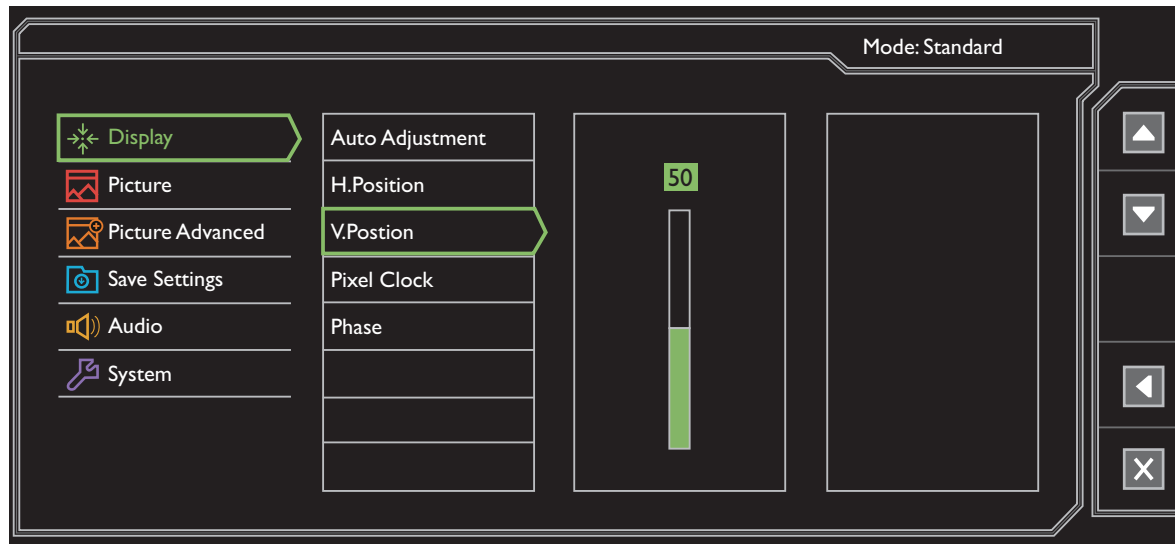

For more information on each menu, please refer to the following pages:



- [Display menu on page 36](#)
- [Picture menu on page 38](#)
- [Picture Advanced menu on page 40](#)
- [Save Settings menu on page 44](#)
- [Audio menu on page 45](#)
- [System menu on page 46](#)

## Display menu

Available menu options may vary depending on the input sources, functions and settings. Menu options that are not available will become grayed out. And keys that are not available will be disabled and the corresponding OSD icons will disappear.



1. Select **Menu** from the hot key menu.
2. Use  or  to select **Display**.
3. Select  to go to a sub menu, and then use  or  to select a menu item.
4. Use  or  to make adjustments, or use  to make selection.
5. To return to the previous menu, select .
6. To exit the menu, select .









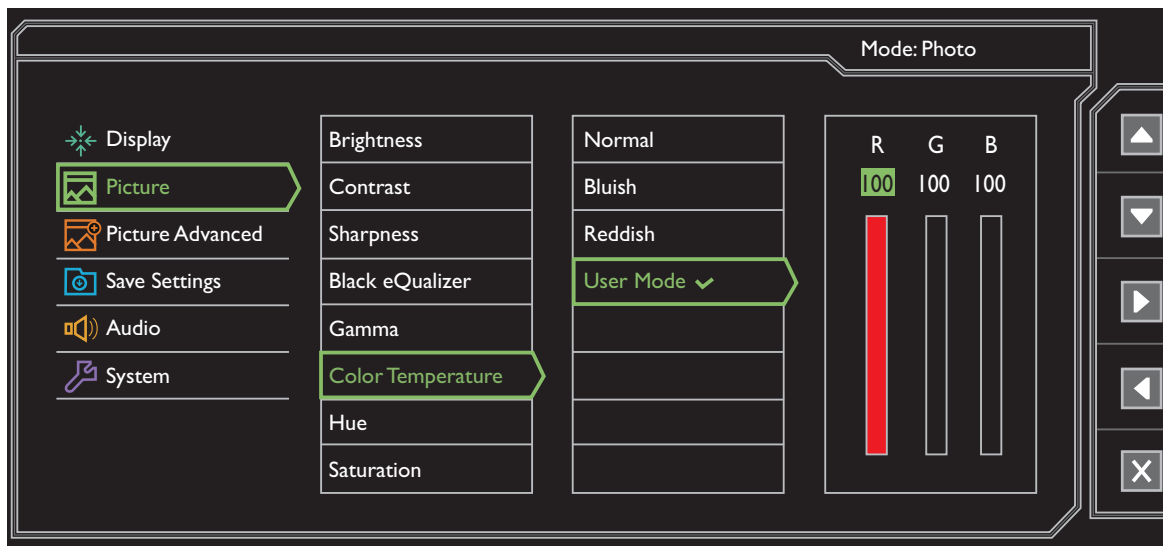

Item	Function	Range
<b>Auto Adjustment</b>	Optimizes and adjusts the screen settings automatically for you.  Not applicable to a digital input signal.	
<b>H. Position</b>	Adjusts the horizontal position of the screen image.	0 to 100
<b>V. Position</b>	Adjusts the vertical position of the screen image.	0 to 100
<b>Pixel Clock</b>	Adjusts the pixel clock frequency timing to synchronize with the analog input video signal. See also: <a href="#">Picture optimization on page 32</a> .  Not applicable to a digital input signal.	0 to 100

Item	Function	Range
<b>Phase</b>	Adjusts the pixel clock phase timing to synchronize with the analog input video signal. See also: <a href="#">Picture optimization on page 32.</a>  Not applicable to a digital input signal.	0 to 63



## Picture menu

Available menu options may vary depending on the input sources, functions and settings. Menu options that are not available will become grayed out. And keys that are not available will be disabled and the corresponding OSD icons will disappear.



1. Select **Menu** from the hot key menu.
2. Use  or  to select **Picture**.
3. Select  to go to a sub menu, and then use  or  to select a menu item.
4. Use  or  to make adjustments, or use  to make selection.
5. To return to the previous menu, select .
6. To exit the menu, select .









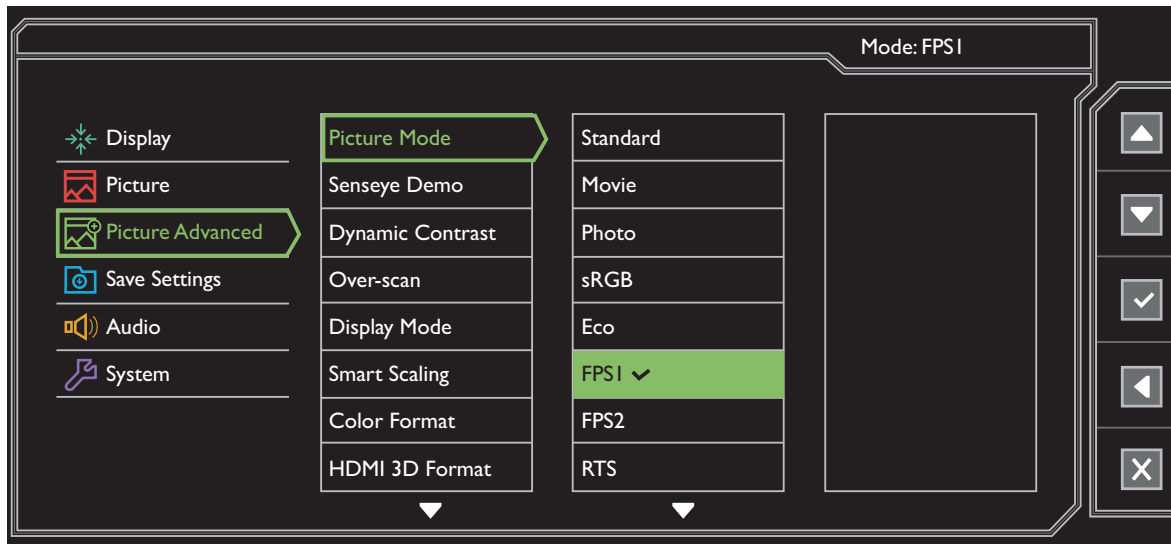

Item	Function	Range
<b>Brightness</b> (during 2D playback) / <b>NVIDIA® 3D LightBoost™</b> (during 3D playback)	<ul style="list-style-type: none"> <li>• Adjusts the balance between light and dark shades (during 2D playback).</li> <li>Or</li> <li>• Adjusts the brightness during 3D playback.</li> </ul>	(During 2D playback) • 0 to 100 (During 3D playback) • <b>OFF to MAX</b>
<b>Contrast</b>	Adjusts the degree of difference between darkness and lightness.	0 to 100
<b>Sharpness</b>	Adjusts the clarity and visibility of the edges of the subjects in the image.	1 to 10

Item	Function		Range
<b>Black eQualizer</b>	Brings out the dark shades by increasing the brightness without changing those of the light shades.   If the image is too bright or barely contains any dark shades, adjusting the value of <b>Black eQualizer</b> may not show much change to the image.		0 ~ 20
<b>Gamma</b>	Adjusts the tone luminance. The default value is 3 (the standard value for Windows).		<ul style="list-style-type: none"> <li>• <b>Gamma 1</b></li> <li>• <b>Gamma 2</b></li> <li>• <b>Gamma 3</b></li> <li>• <b>Gamma 4</b></li> <li>• <b>Gamma 5</b></li> </ul>
<b>Color Temperature</b>	<b>Normal</b>	Allows video and still photographs to be viewed with natural coloring. This is the factory default color.	
	<b>Bluish</b>	Applies a cool tint to the image and is factory pre-set to the PC industry standard white color.	
	<b>Reddish</b>	Applies a warm tint to the image and is factory pre-set to the news print standard white color.	
	<b>User Mode</b>	The blend of the Red, Green and Blue primary colors can be altered to change the color tint of the image. Go to the succeeding <b>R</b> (red), <b>G</b> (green), and <b>B</b> (blue) menus to change the settings. Decreasing one or more of the colors will reduce their respective influence on the color tint of the image. (e.g. if you reduce the Blue level the image will gradually take on a yellowish tint. If you reduce Green, the image will become a magenta tint.)	<ul style="list-style-type: none"> <li>• <b>R</b> (0~100)</li> <li>• <b>G</b> (0~100)</li> <li>• <b>B</b> (0~100)</li> </ul>
<b>Hue</b>	Adjusts the degree of how we perceive colors.		0 ~ 100
<b>Saturation</b>	Adjusts the purity degree of colors.		0 ~ 100
<b>Reset Color</b>	Resets the custom color settings to the factory defaults.		<ul style="list-style-type: none"> <li>• <b>YES</b></li> <li>• <b>NO</b></li> </ul>
<b>AMA</b>	Improves the gray level response time of the LCD panel.		<ul style="list-style-type: none"> <li>• <b>ON</b></li> <li>• <b>OFF</b></li> </ul>
<b>Instant Mode</b>	Adjusts the image processing to diminish input lag. You can have a real-time experience while playing games.   To optimize the picture quality, disable <b>Instant Mode</b> if the source is interlaced video. To check the resolution of the video source, go to <b>System</b> and <b>Information</b> on the monitor.		<ul style="list-style-type: none"> <li>• <b>ON</b></li> <li>• <b>OFF</b></li> </ul>

## Picture Advanced menu





Available menu options may vary depending on the input sources, functions and settings. Menu options that are not available will become grayed out. And keys that are not available will be disabled and the corresponding OSD icons will disappear.







1. Select **Menu** from the hot key menu.
2. Use  or  to select **Picture Advanced**.
3. Select  to go to a sub menu, and then use  or  to select a menu item.
4. Use  or  to make adjustments, or use  to make selection.
5. To return to the previous menu, select .
6. To exit the menu, select .

Item	Function	Range	
<b>Picture Mode</b>	Select a picture mode that best suits the type of images shown on the screen.		
	 The default setting is <b>FPS1</b> . Change the setting if needed.		
	<b>Standard</b>	For basic PC application.	
	<b>Movie</b>	For viewing videos.	
	<b>Photo</b>	For viewing still images.	
	<b>sRGB</b>	For better color matching representation with the peripheral devices, such as printers, digital cameras, etc.	
<b>Eco</b>	For saving electricity with low power consumption by providing minimum brightness for all running programs.		



Item	Function		Range
	<b>FPS1</b>	For playing FPS (First Person Shooting) games.	
	<b>FPS2</b>		
	<b>RTS</b>	For playing RTS (Real-time strategy) games.	
	<b>Gamer1</b>	Applies customized display settings.  For details on setting up a game mode, see <a href="#">Setting up your own game mode on page 32.</a>	
	<b>Gamer2</b>		
	<b>Gamer3</b>		
<b>Senseye Demo</b>	Displays the preview of screen images under the selected mode from Picture Mode. The screen will be divided into two windows; the left window demonstrates images of Standard mode, while the right window presents the images under the specified mode.		<ul style="list-style-type: none"> <li>• <b>ON</b></li> <li>• <b>OFF</b></li> </ul>
<b>Dynamic Contrast</b>	The function is to automatically detect the distribution of an input visual signal, and then to create the optimal contrast.		0 to 5
<b>Overscan</b>	Slightly enlarges the input image. Use this feature to hide annoying edge noise if present around your image.   Available only when the input source is HDMI, DP, or D-Sub (VGA converted from Component).		<ul style="list-style-type: none"> <li>• <b>ON</b></li> <li>• <b>OFF</b></li> </ul>
<b>Display Mode</b>	This feature is provided to allow aspect ratios other than 16:9 to be displayed without geometric distortion.   The options under <b>Display Mode</b> will be different depending on the input signal sources.   Depending on your selection of <b>Picture Mode</b> , different <b>Display Mode</b> option is pre-set. Change the setting if needed.		
	<b>Full</b>	Scales the input image to fill the screen. Ideal for 16:9 aspect images.	
	<b>Aspect</b>	The input image is displayed without geometric distortion filling as much of the display as possible.	
	<b>1:1</b>	Displays the input image in its native resolution without scaling.	
	<b>17" (4:3)</b>	Displays the input image as if on a 17" monitor of 4:3 aspect ratio.	
	<b>19" (4:3)</b>	Displays the input image as if on a 19" monitor of 4:3 aspect ratio.	
	<b>19"W (16:10)</b>	Displays the input image as if on a 19"W monitor of 16:10 aspect ratio.	









Item	Function		Range
	<b>21.5" (16:9)</b>	Displays the input image as if on a 21.5" monitor of 16:9 aspect ratio.	
	<b>22"W (16:10)</b>	Displays the input image as if on a 22"W monitor of 16:10 aspect ratio.	
	<b>23"W (16:9)</b>	Displays the input image as if on a 23"W monitor of 16:9 aspect ratio.	
<b>Smart Scaling</b>	Adjusts the display size to best suit your needs. <ul style="list-style-type: none"> <li> If the <b>Display Mode</b> is <b>17"</b>, <b>19"W</b>, or <b>21.5"</b>, the last 2 scaling settings (in different resolutions of the input source) will be saved for quick access.</li> <li> If the <b>Display Mode</b> is <b>1:1</b> (and the resolution of the input source is lower than 1920 x 1080), the last 5 scaling settings (in different resolutions of the input source) will be saved for quick access.</li> </ul>		0 ~ 100
<b>Color Format</b>	Determines the color space ( <b>RGB</b> or <b>YUV</b> ) based on the detected video signal. <ul style="list-style-type: none"> <li> You might need to manually set the <b>Color Format</b> if colors shown on the monitor screen do not display properly.</li> <li> If the input source is HDMI or DP, color format is not selectable. In other words, <b>Color Format</b> is automatically set depending on the input video source.</li> </ul>		
	<b>RGB</b>	<ul style="list-style-type: none"> <li>• For D-Sub (VGA) input source from PC.</li> <li>• For DVI input source.</li> </ul>	
	<b>YUV</b>	For D-Sub (Component converted from VGA) input source from a video device.	
<b>HDMI 3D Format (XL2420TX only)</b>	Selects an appropriate format to play 3D content. <ul style="list-style-type: none"> <li> Contact your 3D content provider for the correct playback format.</li> </ul>		<ul style="list-style-type: none"> <li>• <b>2D</b></li> <li>• <b>FramePacked</b></li> <li>• <b>Side-by-Side</b></li> <li>• <b>Top Bottom</b></li> </ul>
<b>HDMI RGB PC Range</b>	Determines the range of color scales. Select an option that matches the RGB range setting on the connected HDMI device.		<ul style="list-style-type: none"> <li>• <b>RGB (0 ~ 255)</b></li> <li>• <b>RGB (16 ~ 235)</b></li> </ul>

Item	Function		Range
<b>Smart Focus</b>	This feature provides a highlight area to focus on certain content, e.g. a YouTube video or a game in windowed mode.		
	<b>Size</b>	Determines the size of the highlight area.	<ul style="list-style-type: none"> <li>• <b>Small</b></li> <li>• <b>Large</b></li> <li>• <b>OFF</b></li> </ul>
	<b>H. Position</b>	Adjusts the horizontal position of the highlight area.	0 ~ 100
	<b>V. Position</b>	Adjusts the vertical position of the highlight area.	0 ~ 100
	<b>Scaling</b>	Scales the highlight area.	0 ~ 100

## Save Settings menu

Available menu options may vary depending on the input sources, functions and settings. Menu options that are not available will become grayed out. And keys that are not available will be disabled and the corresponding OSD icons will disappear.











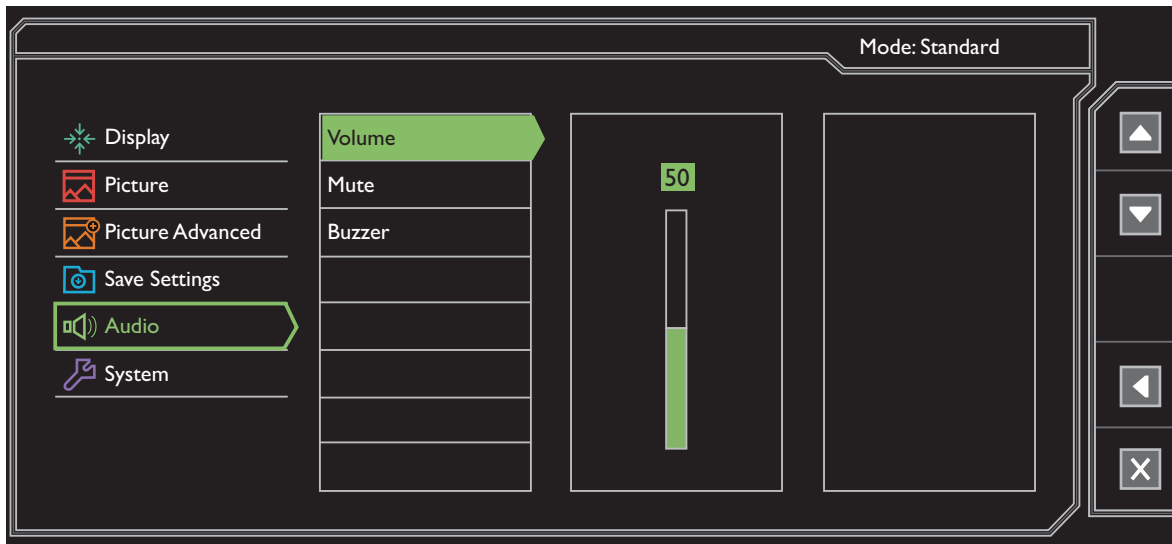

1. Select **Menu** from the hot key menu.
2. Use  or  to select **Save Settings**.
3. Select  to go to a sub menu, and then use  or  to select a menu item.
4. Use  to make selection.
5. To return to the previous menu, select .
6. To exit the menu, select .

Item	Function	Range
<b>Gamer 1</b>	 See <a href="#">Setting up your own game mode on page 32</a> for information on applying the game mode.	-
<b>Gamer 2</b>		
<b>Gamer 3</b>		

## Audio menu

Available menu options may vary depending on the input sources, functions and settings. Menu options that are not available will become grayed out. And keys that are not available will be disabled and the corresponding OSD icons will disappear.











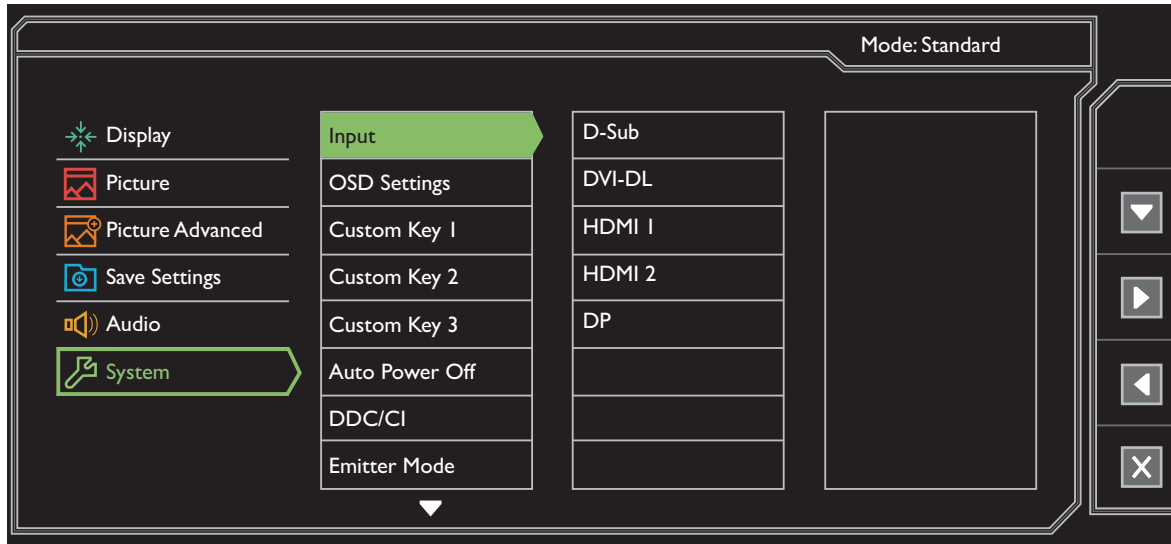

1. Select **Menu** from the hot key menu.
2. Use  or  to select **Audio**.
3. Select  to go to a sub menu, and then use  or  to select a menu item.
4. Use  or  to make adjustments, or use  to make selection.
5. To return to the previous menu, select .
6. To exit the menu, select .

Item	Function	Range
<b>Volume</b>	Adjusts the audio volume.	0 ~ 100
<b>Mute</b>	Mutes the audio input.	<ul style="list-style-type: none"> <li>• ON</li> <li>• OFF</li> </ul>
<b>Buzzer</b>	Turns the tone of control keys on or off.	<ul style="list-style-type: none"> <li>• ON</li> <li>• OFF</li> </ul>



## System menu

Available menu options may vary depending on the input sources, functions and settings. Menu options that are not available will become grayed out. And keys that are not available will be disabled and the corresponding OSD icons will disappear.



1. Select **Menu** from the hot key menu.
2. Use  or  to select **System**.
3. Select  to go to a sub menu, and then use  or  to select a menu item.
4. Use  or  to make adjustments, or use  to make selection.
5. To return to the previous menu, select .
6. To exit the menu, select .

Item	Function	Range
<b>Input</b>	Use this to change the input to that appropriate to your video cable connection type.	<ul style="list-style-type: none"> <li>• <b>D-Sub</b></li> <li>• <b>DVI-DL</b></li> <li>• <b>HDMI 1</b></li> <li>• <b>HDMI 2</b></li> <li>• <b>DP</b></li> </ul>

Item	Function		Range
<b>OSD Settings</b>	<b>Language</b>	Sets the OSD menu language.   The language options displayed on your OSD may differ from those shown on the right, depending on the product supplied in your region.	<ul style="list-style-type: none"> <li>• English</li> <li>• Français</li> <li>• Deutsch</li> <li>• Italiano</li> <li>• Español</li> <li>• Polski</li> <li>• Český</li> <li>• Magyar</li> <li>• Serbo-croatia</li> <li>• Română</li> <li>• Nederlands</li> <li>• Русский</li> <li>• Svenska</li> <li>• Português</li> <li>• 日本語</li> <li>• 繁體中文</li> <li>• 简体中文</li> </ul>
	<b>Display Time</b>	Adjusts the display time of the OSD menu.	<ul style="list-style-type: none"> <li>• 5 Sec.</li> <li>• 10 Sec.</li> <li>• 15 Sec.</li> <li>• 20 Sec.</li> <li>• 25 Sec.</li> <li>• 30 Sec.</li> </ul>
	<b>OSD Lock</b>	Prevents all the monitor settings from being accidentally changed. When this function is activated, the OSD controls and hotkey operations will be disabled.   To unlock the OSD controls, press and hold any key for 10 seconds.	



Item	Function	Range
<b>Customer Key 1</b>	Sets the function to be accessed by custom key 1.	<ul style="list-style-type: none"> <li>• <b>Picture mode</b></li> <li>• <b>Display Mode</b></li> </ul>
<b>Customer Key 2</b>	Sets the function to be accessed by custom key 2.	<ul style="list-style-type: none"> <li>• <b>Smart Scaling</b></li> <li>• <b>Brightness</b></li> </ul>
<b>Customer Key 3</b>	Sets the function to be accessed by custom key 3.	<ul style="list-style-type: none"> <li>• <b>Contrast</b></li> <li>• <b>Smart Focus</b></li> <li>• <b>Volume</b></li> <li>• <b>Mute</b></li> <li>• <b>Input</b></li> <li>• <b>Black eQualizer</b></li> </ul>
<b>Auto Power Off</b>	Sets the time to power off the monitor automatically in power saving mode.	<ul style="list-style-type: none"> <li>• <b>OFF</b></li> <li>• <b>10min.</b></li> <li>• <b>20min.</b></li> <li>• <b>30min.</b></li> </ul>
<b>DDC/CI</b>	<p>Allows the monitor settings to be set through the software on the PC.</p> <p> DDC/CI, short for Display Data Channel/Command Interface, which was developed by Video Electronics Standards Association (VESA). DDC/CI capability allows monitor controls to be sent via the software for remote diagnostics.</p>	<ul style="list-style-type: none"> <li>• <b>ON</b></li> <li>• <b>OFF</b></li> </ul>
<b>Emitter Mode (XL2420TX only)</b>	Decides the IR signal range.	
	<b>Normal Mode</b>	Sets the signal distance in normal power mode.
	<b>Consumer Mode</b>	Sets to reduce interference with other IR equipment (e.g. televisions or DVD players).
	<b>LAN Mode</b>	Sets the minimum distance for LAN parties in low power mode.
<b>HDMI Auto Switch</b>	When this function is activated, HDMI port will be in the input auto select loop. Otherwise, HDMI can only be selected by input select or by hot key.	<ul style="list-style-type: none"> <li>• <b>ON</b></li> <li>• <b>OFF</b></li> </ul>
<b>Resolution Notice</b>	Sets whether to display the resolution notice of the recommended resolution when a new input source is detected by the monitor.	<ul style="list-style-type: none"> <li>• <b>ON</b></li> <li>• <b>OFF</b></li> </ul>





Item	Function	Range
<b>Information</b>	Displays the current monitor property settings.	<ul style="list-style-type: none"> <li>• <b>Input</b></li> <li>• <b>Current Resolution</b></li> <li>• <b>Optimum Resolution</b> (best with the monitor)</li> <li>• <b>Model Name</b></li> </ul>
<b>Reset All</b>	Resets all mode, color and geometry settings to the factory default values.	<ul style="list-style-type: none"> <li>• <b>YES</b></li> <li>• <b>NO</b></li> </ul>

# Troubleshooting

## Frequently asked questions (FAQ)

-  The image has a faulty coloration.
-  • The default **Picture Mode** is **FPS1**, which is designed for FPS games. If you prefer other picture modes, go to **Picture Advanced** and change setting in **Picture Mode**.
- If the image has a yellow, blue or pink appearance, go to **Picture** and **Reset Color**, and then choose **YES** to reset the color settings to the factory defaults.

If the image is still not correct and the OSD also has faulty coloration, this means one of the three primary colors is missing in the signal input. Now check the signal cable connectors. If any pin is bent or broken off, please contact your dealer to get necessary support.

-  The image is blurred.
-  Read the instructions on the link "**Adjusting the Screen Resolution**" on the CD, and then select the correct resolution, refresh rate and make adjustments based on these instructions.

-  How do you use a VGA extension cable?

-  Remove the extension cable for the test. Is the image now in focus? If not, optimize the image by working through the instructions in the "**Adjusting the refresh rate**" section on the link "**Adjusting the Screen Resolution**". It is normal for blurring to occur due to conduction losses in extension cables. You can minimize these losses by using an extension cable with better conduction quality or with a built-in booster.

















-  Does the blurring only occur at resolutions lower than the native (maximum) resolution?

-  Read the instructions on the link "**Adjusting the Screen Resolution**" on the CD. Select the native resolution.

-  Pixel errors can be seen.

One of several pixels is permanently black, one or more pixels are permanently white, one or more pixels are permanently red, green, blue or another color.

-  • Clean the LCD screen.
- Cycle power on-off.
- These are pixels that are permanently on or off and is a natural defect that occurs in LCD technology.

-  No image can be seen.
-  Is the prompt on the display illuminated in green?
- If the LED is illuminated in green and there is a message **Out of Range** on the screen, this means you are using a display mode that this monitor does not support, please change the setting to one of the supported mode. Please read the “**Preset display modes**” section from the link "**Adjusting the Screen Resolution**".
-  Faint shadow from the static image displayed is visible on the screen.
-  • Activate the power management function to let your computer and monitor go into a low power "sleep" mode when not actively in use.
- Use a screensaver to prevent the occurrence of image retention.
-  Is the prompt on the display illuminated in orange?
-  If the LED is illuminated in orange, the power management mode is active. Press any button on the computer keyboard or move the mouse. If that does not help, check the signal cable connectors. If any pin is bent or broken off, please contact your dealer to get necessary support.
-  Is the prompt on the display not illuminated at all?
-  Check the power supply mains socket, the external power supply and the mains switch.
-  The image is distorted, flashes or flickers.
-  Read the instructions on the link "**Adjusting the Screen Resolution**" on the CD, and then select the correct resolution, refresh rate and make adjustments based on these instructions.
-  You are running the monitor at its native resolution, but the image is still distorted.
-  Images from different input sources may appear distorted or stretched on the monitor running at its native resolution. To have the optimal display performance of each type of input sources, you can use the **Display Mode** function to set a proper aspect ratio for the input sources. See [Display Mode on page 41](#) for details.
-  The image is displaced in one direction.
-  Read the instructions on the link "**Adjusting the Screen Resolution**" on the CD, and then select the correct resolution, refresh rate and make adjustments based on these instructions.
-  The OSD controls are inaccessible.
-  To unlock the OSD controls when it is preset to be locked, press and hold any key for 10 second.

 No sound can be heard from the connected external speakers.

-  • Remove your headphone (if the headphone is connected to the monitor).
- Check whether the headphone jack is properly connected.
- If the external speakers are USB-powered, check whether the USB connection is OK.
- Increase the volume (volume may be muted or too low) on the external speakers.

## Need more help?

If your problems remain after checking this manual, please contact your place of purchase or e-mail us at: [Support@BenQ.com](mailto:Support@BenQ.com).

## Free Manuals Download Website

<http://myh66.com>

<http://usermanuals.us>

<http://www.somanuals.com>

<http://www.4manuals.cc>

<http://www.manual-lib.com>

<http://www.404manual.com>

<http://www.luxmanual.com>

<http://aubethermostatmanual.com>

Golf course search by state

<http://golfingnear.com>

Email search by domain

<http://emailbydomain.com>

Auto manuals search

<http://auto.somanuals.com>

TV manuals search

<http://tv.somanuals.com>