

BenQ

T52WA

15" Wide-Screen LCD Monitor

User Manual

Table of Contents

Package contents	3
Installation	4
To connect the monitor to your PC	4
To connect the monitor to the power source	4
Adjusting your monitor	5
Functions of the buttons and indicator	5
OSD icon list	5
Troubleshooting	7
Specifications	8
15" Wide-Screen LCD monitor	8

1. Package contents

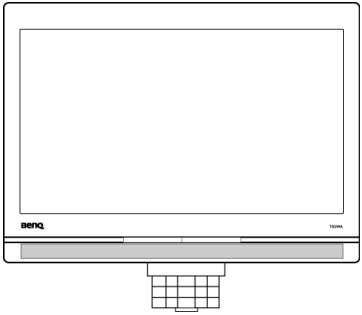
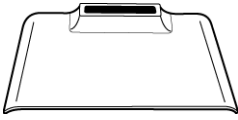
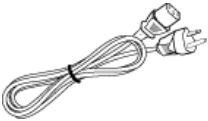
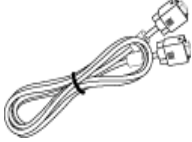
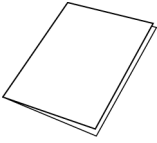
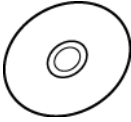
 A line drawing of a BenQ LCD monitor with a keyboard tray attached to the bottom.	1. LCD Monitor
 A line drawing of a trapezoidal monitor base with a central slot for the monitor.	2. Monitor Base (the shape of base may vary according to the monitor model)
 A line drawing of a power cord with a standard three-prong electrical plug and a connector for the monitor.	3. Power Cord (plug may vary according to the electrical standards for your area)
 A line drawing of an analog signal cable with connectors for the monitor and a computer system.	4. Analog Signal Cable
 A line drawing of a rectangular document representing the quick installation guide.	5. Quick Installation Guide
 A line drawing of a CD-ROM disc.	6. CD-ROM (contains user manual)

2. Installation

To connect the monitor to your PC

1. Make sure that the PC and monitor are unplugged.
2. Connect the signal cable to the monitor and the PC.

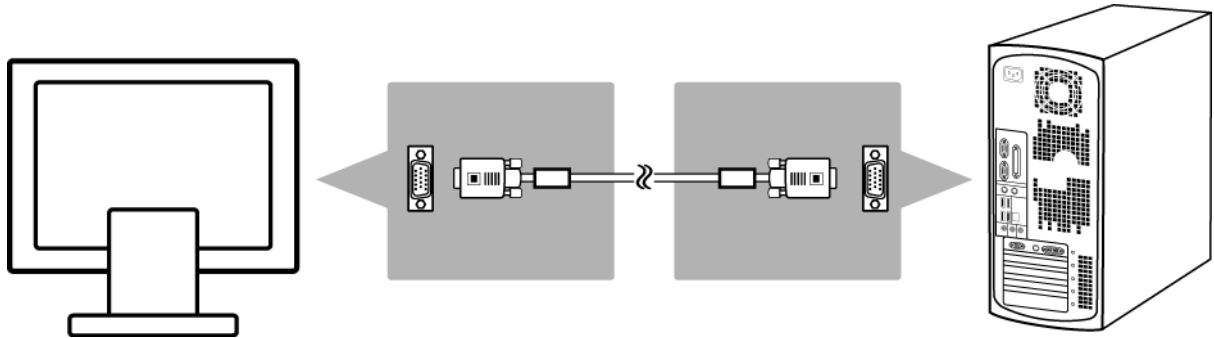

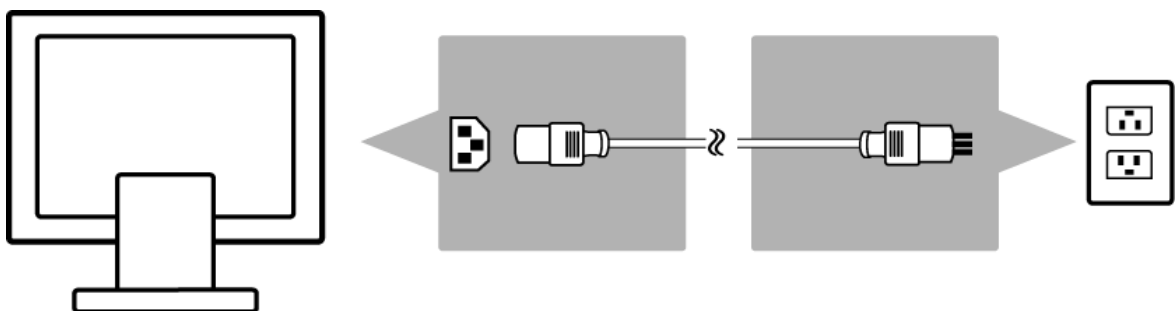

To connect the monitor to the power source

Connect the separate power cable to the monitor and a grounded outlet.























3. Adjusting your monitor

Functions of the buttons and indicator

Item	Function
Enter	Enter OSD menu, select item, enter submenu, and confirm recall.
	1. Positive adjustment, change within several selections. 2. Hot key of "Brightness".
	1. Minus adjustment, change within several selections. 2. Hot key of "Contrast".
Exit	Leave menu, cancel recall. (Settings will be saved automatically after adjustments are made.)
Auto	Hot key of auto adjustment (for geometric settings only).

OSD icon list

Icon	Function	Description
	Auto Adjust	* Optimize the picture performance automatically
	Luminance	* Select "Brightness" and "Contrast" adjustment submenu
	Geometry	* Select "H. Position", "V. Position", "Pixel Clock" and "Phase" adjustment submenu
	Color	* Select color temperature or to set up user mode
	OSD	* Adjust the position and time of OSD menu on the screen
	Language	* Select your own preference of language of OSD menu
	Recall	* Reset monitor parameters back to factory preset value
	Miscellaneous	* Select "Miscellaneous" adjustment submenu
	Brightness	* Adjust the luminance of the screen
	Contrast	* Adjust the contrast level of the screen
	H. Position	* Shift the screen left or right

	V. Position	* Shift the screen up or down
	Pixel Clock	* Adjust the monitor internal sampling clock rate
	Phase	* Adjust the monitor internal signal phase
	OSD H. Position	* Shift the OSD left or right
	OSD V. Position	* Shift the OSD up or down
	OSD Time	* Set OSD display duration time
	Sharpness	* Adjust the sharp level of the screen
	DDC/CI	* Switch "DDC/CI" On or Off
	Information	* Show the display information

4. Troubleshooting

Symptom	Remedy
<p>*Blank Screen*</p> <p>Power indicator is off</p>	<ul style="list-style-type: none"> • Make sure the power cable is connected properly (see Installation on page 4). • Make sure that the monitor was turned on using the power switch (see To connect the monitor to your PC on page 4).
Power indicator lights orange	<ul style="list-style-type: none"> • Perhaps a power saving mode is active? Press any key on your keyboard or move the mouse.
Power indicator lights green	<ul style="list-style-type: none"> • A screen saver may have activated automatically after a certain period of inactivity. Press any key on your keyboard or move the mouse.
"No Signal Detected!" message	<ul style="list-style-type: none"> • Is the signal cable connected to the monitor and the PC's graphics port (see Installation on page 4)? • Is the PC turned on (see your PC's documentation)?
<p>*Display Problems*</p> <p>Image is displaced to the left/right or to the top/bottom</p>	<ul style="list-style-type: none"> • If the image appears normal but off-center, you can adjust it using the OSD functions. For further information, see "Auto Adjust" in the OSD icon list section.
Image is blurred	<ul style="list-style-type: none"> • Check brightness and contrast settings (see "Luminance" in the OSD icon list section). • Check the sharpness setting (see "Sharpness" in the OSD icon list section).
Color problems	<ul style="list-style-type: none"> • If the colors are off (e.g., white is not really displayed as white etc.), you should adjust the color temperature (see "Color" in the OSD icon list section).

5. Specifications

15" Wide-Screen LCD monitor

Item		T52WA
Panel	Display Size	332.16 (H) x 186.84 (V) mm
	Pixel Pitch	0.2595 (H) x 0.2595 (V) mm
Monitor	Display Colors	16.7M colors
Input Signal	Frequency	Horizontal: 31 - 64 KHz
		Vertical: 59 - 75 Hz
Connector	Analog	D-sub 15 pin
Tilt	Tilt Angle	-5° - 20°
Dimensions (W x H x D)	Net	370.3(W) x 330.4(H) x 137.1(D) mm
Weight	Net	< 4 kg
Power	AC	AC 100-240V, 50 Hz / 60 Hz
	Consumption	Active: ≤ 21W / Standby: < 2W

Free Manuals Download Website

<http://myh66.com>

<http://usermanuals.us>

<http://www.somanuals.com>

<http://www.4manuals.cc>

<http://www.manual-lib.com>

<http://www.404manual.com>

<http://www.luxmanual.com>

<http://aubethermostatmanual.com>

Golf course search by state

<http://golfingnear.com>

Email search by domain

<http://emailbydomain.com>

Auto manuals search

<http://auto.somanuals.com>

TV manuals search

<http://tv.somanuals.com>