

Installation Instructions / Warranty

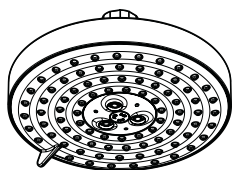

27495XX1
27495XX3

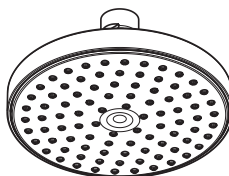

27486XX1
27486XX3



27447XX1



27457XX1



27491XX1



27425XX1



27426XX1

Raindance S AIR
Raindance E AIR

hansgrohe

Showerheads with model numbers ending in "1" are available in the US and Canada only.

Raindance S 150 AIR 3-jet
27495XX1

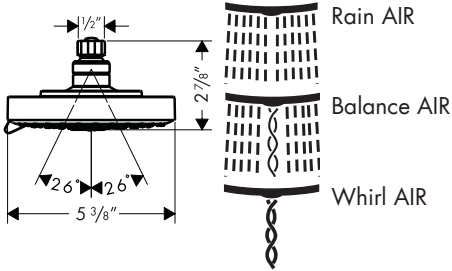

Maximum Flow Rate 2.5 gpm

Raindance S 150 AIR 1-jet
27486XX1

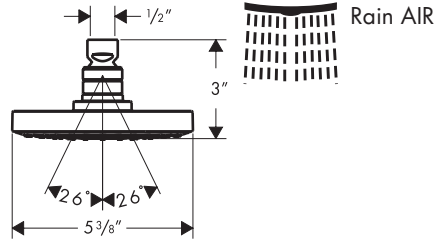

Maximum Flow Rate 2.5 gpm

Raindance E 120 AIR 3-Jet
27447XX1

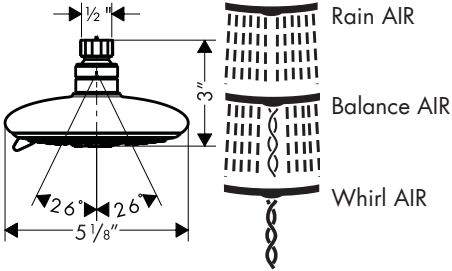

Maximum Flow Rate 2.5 gpm

Raindance S 120 AIR 3-Jet
27457XX1

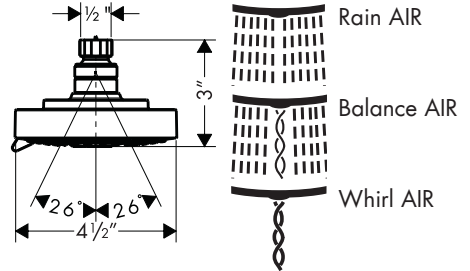

Maximum Flow Rate 2.5 gpm

Raindance S 100 AIR 3-jet
27491XX1

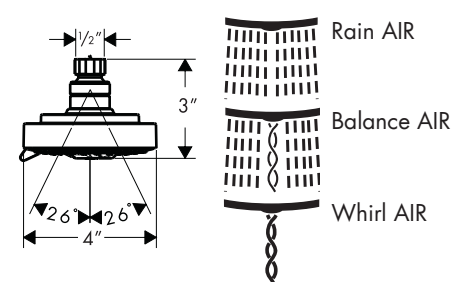

Maximum Flow Rate 2.5 gpm

Raindance E 100 AIR 1-Jet
27425XX1

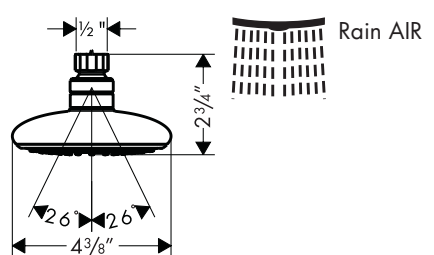

Maximum Flow Rate 2.5 gpm

Raindance S 100 AIR 1-Jet
27426XX1

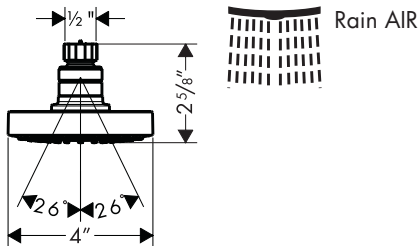

Maximum Flow Rate 2.5 gpm

Showerheads with model numbers ending in "3" are available in Australia only.

Raindance S 150 AIR 3-jet
27495XX3 (Australia only)

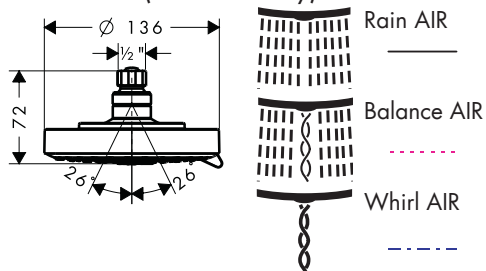

AAA Water Conservation Rating
from • the function is guaranteed

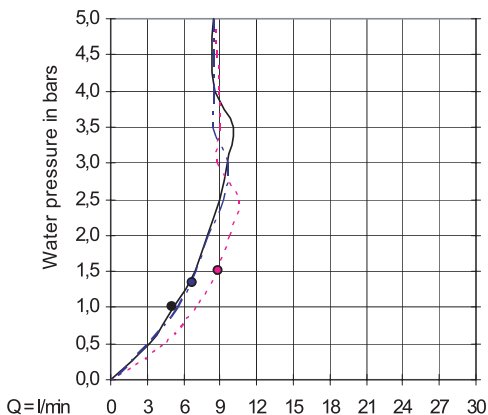

Raindance S 150 AIR 1-jet
27486XX3 (Australia only)

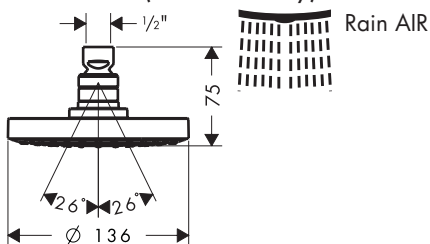

AAA Water Conservation Rating
from • the function is guaranteed

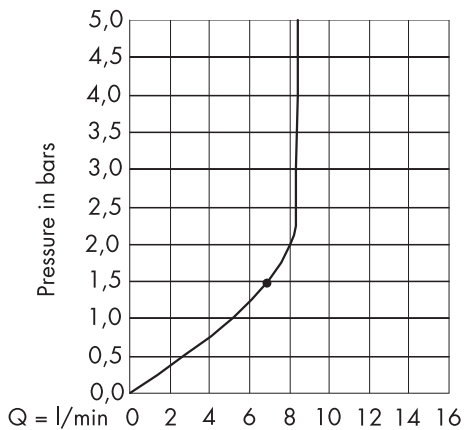

Installation

Make sure that the filter gasket (already installed) is screwed firmly into the ball joint.

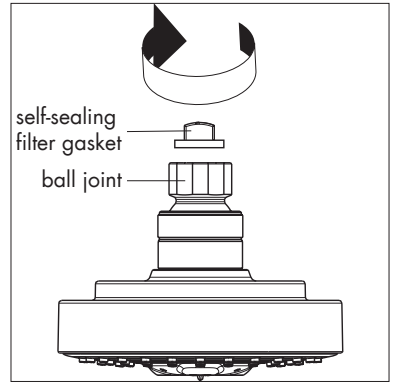

Install the showerhead on the shower arm.

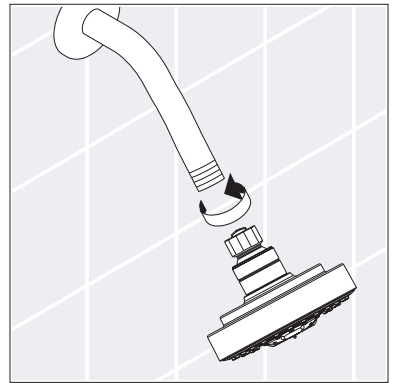

If the flow of water decreases over time, remove and clean the filter gasket.

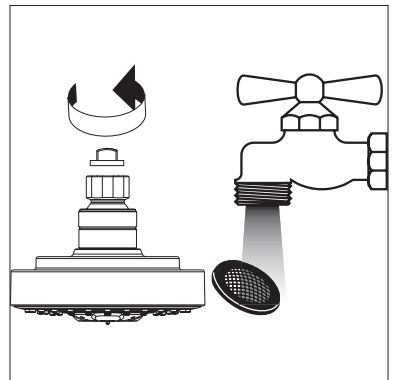

Scale Removal

The Raindance AIR showerhead incorporates the QUICKclean™ cleaning system. If scale deposits are noticed in the spray channels, turn the water on lightly and rub the spray channels with a finger or a sponge.

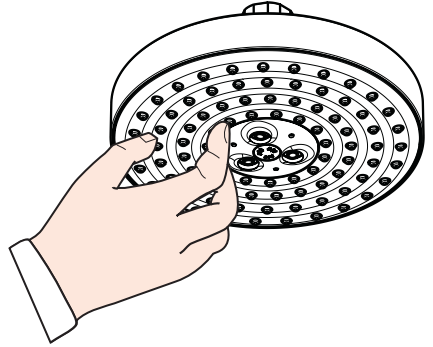

If scale deposits are noticed on the spray face, pour about 3/4" of a commercial scale remover, such as Lime-Away™ or CLR™, into a shallow dish. Dilute the remover according to the label instructions.

Soak only the spray face in the solution for the amount of time specified on the label.

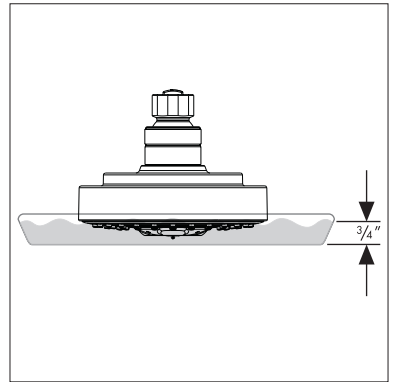

Rinse the showerhead with clear water.

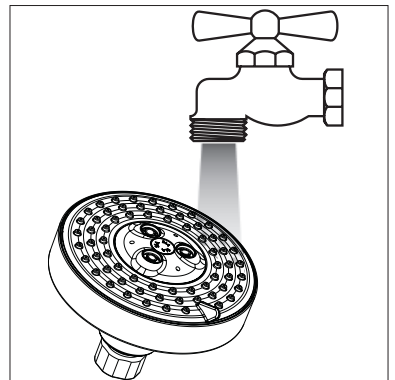

Install the showerhead.

Flush the showerhead for at least one minute.

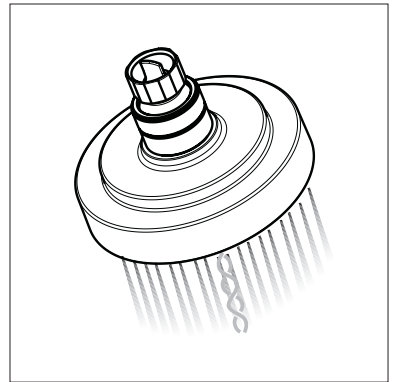

User Instructions - Raindance AIR 3-jet models only

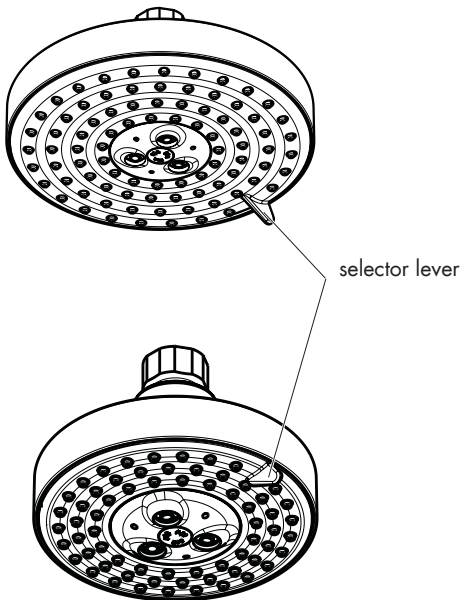

To change spray modes, push the selector lever until the desired spray is achieved.



Rain AIR



Balance AIR



Whirl AIR

Cleaning Recommendation for Hansgrohe Products

Modern faucetry and shower products utilize a combination of materials to comply with the needs of the market with regard to design and functionality.

To avoid damage, it is necessary to use some caution when cleaning. Damage caused by improper treatment is not covered under the Hansgrohe warranty.

Cleaning Materials for Faucets and Showers

- To remove lime scale, use only products made specifically for that purpose. Always follow the manufacturer's instructions when using.
- Do not use cleaners that contain hydrochloric, formic, acetic, or phosphoric acids, as these will cause considerable damage to finishes and to plastic components.
- Never mix cleaning materials.
- Never use cleaners containing abrasives. Do not use abrasive cleaning cloths, pads, or sponges.

Cleaning Procedures

- Clean your faucets and shower products as and when required. Regular cleaning will prevent scale buildup and water spotting.
- Follow the label instructions. Do not allow any cleaner to remain on the product for longer than necessary.
- When using spray cleaners, spray first onto a sponge or cloth – do not spray directly onto the product.
- After cleaning, rinse thoroughly with clear water to remove any cleaner residue.

Important

- Soap and shampoo residue can also cause damage to the product. Rinse well with clean water after use.
- If the surface is already damaged, harsh cleaning materials will cause further damage.

Limited Lifetime Consumer Warranty

This product has been manufactured and tested to the highest quality standards by Hansgrohe, Inc. ("Hansgrohe"). This warranty is limited to Hansgrohe products which are purchased by a consumer in the United States after March 1, 1996, and installed in either the United States or Canada.

WHO IS COVERED BY THE WARRANTY

This warranty extends to the original consumer purchaser only. This warranty is non-transferable.

WHAT IS COVERED BY THE WARRANTY

This warranty covers only your Hansgrohe manufactured product. Hansgrohe warrants this product against defects in material or workmanship as follows: Hansgrohe will repair at no charge for parts only or, at its option, replace any product or part of the product that proves defective because of improper workmanship and/or material, under normal installation, use, service and maintenance. If Hansgrohe is unable to provide a replacement and repair is not practical or cannot be timely made, Hansgrohe may elect to refund the purchase price in exchange for the return of the product.

LENGTH OF WARRANTY

Replacement or repaired parts of products will be covered for the term of this warranty as stated in the following two sentences. If you are a consumer who purchased the product for use primarily for personal, family, or household purposes, this warranty extends for as long as you own the product and the home in which the product is originally installed. If you purchased the product for use primarily for any other purpose, including, without limitation, a commercial purpose, this warranty extends only (i) for 1 year, with respect to Hansgrohe and Commercial products, and (ii) for 5 years, with respect to AXOR products.

THIS WARRANTY DOES NOT COVER, AND HANSGROHE WILL NOT PAY FOR:

- A. Conditions, malfunctions or damage not resulting from defects in material or workmanship.
- B. Conditions, malfunctions or damage resulting from (1) normal wear and tear, improper installation, improper maintenance, misuse, abuse, negligence, accident or alteration, or (2) the use of abrasive or caustic cleaning agents or "no-rinse" cleaning products, or the use of the product in any manner contrary to the product instructions. (3) Conditions in the home such as excessive water pressure or corrosion.
- C. Labor or other expenses for the disconnection, deinstallation, or return of the product for warranty service, or for installation or reinstallation of the product (including but not limited to proper packaging and shipping costs), or for installation or reinstallation of the product.

D. Accessories, connected materials and products, or related products not manufactured by Hansgrohe.

TO OBTAIN WARRANTY PARTS OR INFORMATION

Contact your Hansgrohe retailer, or contact Technical Service at:

Hansgrohe Inc.

1492 Bluegrass Lakes Parkway

Alpharetta GA 30004

Toll-free (800) 334-0455.

In requesting warranty service, you will need to provide

1. The sales receipt or other evidence of the date and place of purchase.
2. A description of the problem.
3. Delivery of the product or the defective part, postage prepaid and carefully packed and insured, to Hansgrohe Inc. 1492 Bluegrass Lakes Parkway, Alpharetta, Georgia 30004, Attention: Technical Service, if required by Hansgrohe.

When warranty service is completed, any repaired or replacement product or part will be returned to you postage prepaid.

EXCLUSIONS AND LIMITATIONS

REPAIR OR REPLACEMENT (OR, IN LIMITED CIRCUMSTANCES, REFUND OF THE PURCHASE PRICE) AS PROVIDED UNDER THIS WARRANTY IS THE EXCLUSIVE REMEDY OF THE PURCHASER. HANSGROHE NEITHER ASSUMES NOR AUTHORIZES ANY PERSON TO CREATE FOR IT ANY OBLIGATION OR LIABILITY IN CONNECTION WITH THIS PRODUCT.

HANSGROHE SHALL NOT BE LIABLE TO PURCHASER OR ANY PERSON FOR ANY INCIDENTAL, SPECIAL, OR CONSEQUENTIAL DAMAGES, ARISING OUT OF BREACH OF THIS WARRANTY OR ANY IMPLIED WARRANTY (INCLUDING MERCHANTABILITY).

Some States do not allow the exclusion or limitation of incidental or consequential damages, so the above limitation or exclusion may not apply to you. This warranty gives you specific legal rights, and you may have other rights which vary from State to State. You may be required by law to give us a reasonable opportunity to correct or cure any failure to comply before you can bring any action in court against us under the Magnuson-Moss Warranty Act.

PRODUCT INSTRUCTIONS AND QUESTIONS

Upon purchase or prior to installation, please carefully inspect your Hansgrohe product for any damage or visible defect. Prior to installing, always carefully study the enclosed instructions on the proper installation and the care and maintenance of the product. If you have questions at any time about the use, installation, or performance of your Hansgrohe product, or this warranty, please call or write to us or call us toll-free at 800 334 0455.

The logo consists of the word "hansgrohe" in a lowercase, sans-serif font, centered within a solid black rectangular background.

Hansgrohe, Inc. • 1490 Bluegrass Lakes Parkway • Alpharetta, GA 30004
Tel. 770 360-9880 • Fax 770 360 9887

www.hansgrohe-USA.com

Free Manuals Download Website

<http://myh66.com>

<http://usermanuals.us>

<http://www.somanuals.com>

<http://www.4manuals.cc>

<http://www.manual-lib.com>

<http://www.404manual.com>

<http://www.luxmanual.com>

<http://aubethermostatmanual.com>

Golf course search by state

<http://golfingnear.com>

Email search by domain

<http://emailbydomain.com>

Auto manuals search

<http://auto.somanuals.com>

TV manuals search

<http://tv.somanuals.com>