



Avaya 1120E IP Deskphone with SIP Software User Guide

Avaya Communication Server 1000

Document Status: **Standard**

Document Version: **06.04**

Part Code: **NN43112-101**

Date: **October 2010**



© 2010 Avaya Inc. All Rights Reserved.

Notices

While reasonable efforts have been made to ensure that the information in this document is complete and accurate at the time of printing, Avaya assumes no liability for any errors. Avaya reserves the right to make changes and corrections to the information in this document without the obligation to notify any person or organization of such changes.

Documentation disclaimer

Avaya shall not be responsible for any modifications, additions, or deletions to the original published version of this documentation unless such modifications, additions, or deletions were performed by Avaya. End User agree to indemnify and hold harmless Avaya, Avaya's agents, servants and employees against all claims, lawsuits, demands and judgments arising out of, or in connection with, subsequent modifications, additions or deletions to this documentation, to the extent made by End User.

Link disclaimer

Avaya is not responsible for the contents or reliability of any linked Web sites referenced within this site or documentation(s) provided by Avaya. Avaya is not responsible for the accuracy of any information, statement or content provided on these sites and does not necessarily endorse the products, services, or information described or offered within them. Avaya does not guarantee that these links will work all the time and has no control over the availability of the linked pages.

Warranty

Avaya provides a limited warranty on this product. Refer to your sales agreement to establish the terms of the limited warranty. In addition, Avaya's standard warranty language, as well as information regarding support for this product, while under warranty, is available to Avaya customers and other parties through the Avaya Support Web site: <http://www.avaya.com/support>

Please note that if you acquired the product from an authorized reseller, the warranty is provided to you by said reseller and not by Avaya.

Licenses

THE SOFTWARE LICENSE TERMS AVAILABLE ON THE AVAYA WEBSITE, [HTTP://SUPPORT.AVAYA.COM/LICENSEINFO](http://support.avaya.com/LICENSEINFO) ARE APPLICABLE TO ANYONE WHO DOWNLOADS, USES AND/OR INSTALLS AVAYA SOFTWARE, PURCHASED FROM AVAYA INC., ANY AVAYA AFFILIATE, OR AN AUTHORIZED AVAYA RESELLER (AS APPLICABLE) UNDER A COMMERCIAL AGREEMENT WITH AVAYA OR AN AUTHORIZED AVAYA RESELLER. UNLESS OTHERWISE AGREED TO BY AVAYA IN WRITING, AVAYA DOES NOT EXTEND THIS LICENSE IF THE SOFTWARE WAS OBTAINED FROM ANYONE OTHER THAN AVAYA, AN AVAYA AFFILIATE OR AN AVAYA AUTHORIZED RESELLER, AND AVAYA RESERVES THE RIGHT TO TAKE LEGAL ACTION AGAINST YOU AND ANYONE ELSE USING OR SELLING THE SOFTWARE WITHOUT A LICENSE. BY INSTALLING, DOWNLOADING OR USING THE SOFTWARE, OR AUTHORIZING OTHERS TO DO SO, YOU, ON BEHALF OF YOURSELF AND THE ENTITY FOR WHOM YOU ARE INSTALLING, DOWNLOADING OR USING THE SOFTWARE (HEREINAFTER REFERRED TO INTERCHANGEABLY AS "YOU" AND "END USER"), AGREE TO THESE TERMS AND CONDITIONS AND CREATE A BINDING CONTRACT BETWEEN YOU AND AVAYA INC. OR THE APPLICABLE AVAYA AFFILIATE ("AVAYA").

Copyright

Except where expressly stated otherwise, no use should be made of the Documentation(s) and Product(s) provided by Avaya. All content in this documentation(s) and the product(s) provided by Avaya including the selection, arrangement and design of the content is owned either by Avaya or its licensors and is protected by copyright and other intellectual property laws including the sui generis rights relating to the protection of databases. You may not modify, copy, reproduce, republish, upload, post, transmit or distribute in any way any content, in whole or in part, including any code and software. Unauthorized reproduction, transmission, dissemination, storage, and or use without the express written consent of Avaya can be a criminal, as well as a civil offense under the applicable law.

Third Party Components

Certain software programs or portions thereof included in the Product may contain software distributed under third party agreements ("Third Party Components"), which may contain terms that expand or limit rights to use certain portions of the Product ("Third Party Terms"). Information regarding distributed Linux OS source code (for those Products that have distributed the Linux OS source code), and identifying the copyright holders of the Third Party Components and the Third Party Terms that apply to them is available on the Avaya Support Web site: <http://support.avaya.com/Copyright>.

Trademarks

The trademarks, logos and service marks ("Marks") displayed in this site, the documentation(s) and product(s) provided by Avaya are the registered or unregistered Marks of Avaya, its affiliates, or other third parties. Users are not permitted to use such Marks without prior written consent from Avaya or such third party which may own the Mark. Nothing contained in this site, the documentation(s) and product(s) should be construed as granting, by implication, estoppel, or otherwise, any license or right in and to the Marks without the express written permission of Avaya or the applicable third party. Avaya is a registered trademark of Avaya Inc. All non-Avaya trademarks are the property of their respective owners.

Downloading documents

For the most current versions of documentation, see the Avaya Support. Web site: <http://www.avaya.com/support>

Contact Avaya Support

Avaya provides a telephone number for you to use to report problems or to ask questions about your product. The support telephone number is 1-800-242-2121 in the United States. For additional support telephone numbers, see the Avaya Web site: <http://www.avaya.com/support>

Revision history

October 2010

Standard 06.04. This document is up-issued to support changes related to rebranding.

September 2010

Standard 06.03. This document is up-issued to include the Multi-Level Precedence and Preemption service.

August 2010

Standard 06.01. This document is up-issued to support SIP Software Release 3.2.

March 2010

Standard 04.01. This document is up-issued to support SIP software Release 3.0.

September 2008

Standard 03.05. This document is up issued to support corrections to graphics and technical information.

June 2008

Standard 03.04. This document is up issued to support SIP Firmware for IP Phone 1120E Maintenance Release 2.0.

July 2007

Standard 02.06. This document is up issued to support SIP Firmware for IP Phone 1120E Maintenance Release 1.1.

January 2007

Standard 01.02

Contents

Welcome	15
Basic features	15
Avaya 1120E IP Deskphone controls	17
Avaya 1120E IP Deskphone display	23
Cleaning the Avaya 1120E IP Deskphone LCD display screen	24
Context-sensitive soft keys	24
Idle display screen after dial pad input	30
In-call context-sensitive soft keys	31
Navigation keys	40
Using a USB Mouse	42
Available IP Deskphone call features	43
Security features	43
Secure connection	44
Regulatory and safety information	46
Other	49
DenAn regulatory notice for Japan	49
Using your Avaya 1120E IP Deskphone	50
Getting started	50
Before you begin	51
Connecting the components	51
Removing the stand cover	53
Connecting the AC power adapter (optional)	54
Connecting the handset	55
Connecting the headset (optional)	56
Selecting the headset tuning parameter	56
Connecting the LAN ethernet cable	57

Installing additional cables	58
Wall-mounting the IP Deskphone (optional)	58
Entering text	60
Entering text using the IP Deskphone dialpad	61
Enabling and disabling the # Ends Dialing feature	63
Configuring the dialpad to alphanumeric dialing	65
Entering text using the USB keyboard	66
Accessing the Avaya 1120E IP Deskphone	68
Logging on	68
Automatic login	69
Configuring the domain	69
Password protection for domains	71
Selecting a language	71
Logging on to your Avaya 1120E IP Deskphone	72
Configuring the duration of the login	76
Logging on multiple user accounts	77
Timed logoff	77
Timed logoff while IP Deskphone is idle	77
Timed logoff while on a call	78
Selecting a location	78
User Profile	80
Overwriting your personal Address Book	81
Confirmation logon screen	81
Logging off from the IP Deskphone	82
Logging off multiple user accounts	82
Making an emergency call	83
Location information	84
Configuring the Avaya 1120E IP Deskphone	86
Adjusting the display screen contrast	86
Creating the idle screen text display	87

Configuring the Backlight Screensaver	88
Configuring Menu Auto back-out	89
Selecting a ring pattern	91
Adjusting the volume	92
Adjusting the ring volume	92
Adjusting the volume of the Handset, Headset, and Handsfree mode	94
Selecting a language	97
Selecting the date and time format	98
USB headset	101
Headset menu	102
Presence of USB headset	106
Audio format selection	107
Generic USB headset	108
Avaya USB headset adapter with HID	108
Third-party USB headsets with HID	112
Analog Terminator Adapter for analog (500/2500-type) telephone or fax machine	117
Making a call	121
Making a call using off-hook dialing	122
Making a call using on-hook dialing	124
Using handsfree calling	124
Using Call Subjects	126
Managing Call Subjects	129
Adding a Call Subject	129
Deleting a Call Subject	130
Editing a Call Subject	131
Receiving a call	133
Caller identification	133
Answering an incoming call	134

- Redirecting an incoming call 134
- Declining an incoming call 137
 - Creating a new Call Decline Reason 138
 - Managing Call Decline Reasons 139
- Ignoring an incoming call 141
- Receiving intercom calls 143
- Receiving paging calls 143
- The Address Book 145**
 - Viewing the Address Book 145
 - Initiating a call from the Address Book 146
 - Adding a contact to your Address Book 148
 - Editing a contact in your Address Book 149
 - Copying information to the Address Book 153
 - Searching for a contact in the Address Book 155
 - Using the Search feature in the Address Book 156
 - Using the Search feature 157
 - Using Local Search 157
 - Using Global Search 159
- Call Inbox 163**
 - Accessing the Call Inbox 164
 - Managing calls in the Call Inbox while not on a call 164
 - Viewing the details of a call in the Call Inbox 167
 - Managing missed calls 167
 - Missed Calls Notification 169
 - Initiating a call from the Call Inbox 171
 - Deleting calls in your Call Inbox 172
 - Accessing the calls in your Call Inbox during a call 173
- Call Outbox 174**
 - Accessing the Call Outbox 175

Managing calls in the Call Outbox while not on a call . . .	175
Initiating a call from the Call Outbox	176
Deleting calls from your Call Outbox	177
Viewing the details of a call in the Call Outbox	178
Accessing the calls in your Call Outbox during a call . . .	179
Instant Messaging	181
Configuring Instant Messaging	181
Configuring IM automatic pop-up	181
Configuring Instant Messaging pop-ups	182
Configuring IM audible alert	183
Composing an Instant Message	184
Instant Message Inbox/Outbox	185
Accessing Instant Messages	186
Viewing the content of an Instant Message	188
Replying to an Instant Message	188
Initiating a call from an Instant Message	189
Deleting an Instant Message	190
While on an active call	192
Making a new call	192
Initiating a call using the active call context-sensitive soft key menu	193
Call Waiting	193
Placing a call On Hold	194
Multiple calls On Hold	195
Using 3-way calling	202
Configuring a conference call	204
Ad hoc conferencing when connecting to the Call Server . .	205
Edit Domain page	207
Transferring a call	209
Using the Park Call feature	213

Using Park Call	213
Retrieving a Parked Call	214
Additional features	216
Using the Friends feature	216
Accessing your Friends list	217
Editing information of a friend	220
Feature keys	224
Feature key programming	225
Remove a programmed feature key	238
Feature key autoprogramming	240
Creating a feature key using the Copy key	245
Using Call Forward	247
Configuring Do Not Disturb	251
Configuring a Presence state	252
Adding a new Presence state message	254
Configuring Privacy settings	255
Incoming call privacy	255
Outgoing call privacy	256
Multiple Appearance Directory Number	257
Audio Codecs	259
Audio Codec Selection	259
Audio Codec Ordering	260
PC Client softphone interworking with the IP Deskphone	260
Answer-Mode Settings	261
Automatic remote software updates	262
Multiusers	264
Initial login	265
Additional logins	265
Automatic login	266

Logging out	267
Primary account logout	267
Secondary account logout	268
Server failover	268
Cable unplugged	268
Upgrade impacts to user profiles	269
Line keys	270
Making a call	272
Receiving a call	273
Being in a call	273
Instant Messages	275
Menu features	275
Modifying settings	275
Per-account call notification options	275
IM Settings	276
Voice Mail settings	276
Remembering settings after logout	276
Programmable keys	276
Inbox, outbox, IM log	277
Address books	278
User status	279
Do Not Disturb	279
Call Forwarding	280
Presence	281
Notifications	282
Account Selection	283
Advanced features	284
Accessing the services menu	285
Checking for updates	286
Switching the proxy	286

Resetting the IP Deskphone	289
Erasing the user data	290
Network menu	295
USB flash drive	296
Presence of USB flash drive	297
Feature characteristics	297
Enabling or disabling the USB Port	297
Customizable banner for login	299
Phone Information - Details screen	300
Screensaver/screen lock	301
.....	309
.....	309
Background image	309
Selecting an image screen	310
Service Package Group Support	311
Speed Dial List	320
Speed Dial List screen	321
Auto retrieve flag	322
USB flash memory device support	323
Notes on File Manager	330
Visual indicators	334
Display screen icons	334
Visual Alerter/Message Waiting Indicators	336
Multi-Level Precedence and Preemption	339
Overview	339
Other MLPP service features	340
Making a call with MLPP	341
Making an MLPP call by going off-hook	341
Making an MLPP call using Inbox/Outbox, Address Book, and Friends List	345

Making an MLPP call from a received Instant Message	346
Making a call by using a programmed speed dial key . .	348
Incoming calls with precedence	349
Call transfer with precedence	350
Multiple calls	351
Preemption	352
Call Origination Busy	357
Re-authorization	360
Feature interactions with MLPP	360
Quick reference	363
Fixed keys	363
Commonly used functions	365
Context-sensitive soft keys	368
Display screen icons	372
Third party terms	375
Third Party Terms for Avaya 11xx 12xx sw release 3.0 thru 4.0 (Aug - Nov 2010)	375
GNU	376
Zlib	383
Libpng	383
Kern_random	386
Wchar functions	387
Libjpeg	388
T-Rex	389
Terms you should know	391
Index	397

Welcome

Your Avaya 1120E IP Deskphone brings voice and data to your desktop. The IP Deskphone connects directly to a Local Area Network (LAN) through an Ethernet connection. The IP Deskphone with SIP software communicates using Session Initiated Protocol (SIP) after the software is upgraded to a SIP-enabled version.

In this guide, user-defined feature key labels appear beside the keys and context-sensitive soft keys labels appear directly above the keys. [Figure 1](#) shows the user-defined feature keys and context-sensitive soft keys.

Figure 1: User-defined feature keys and context-sensitive soft keys

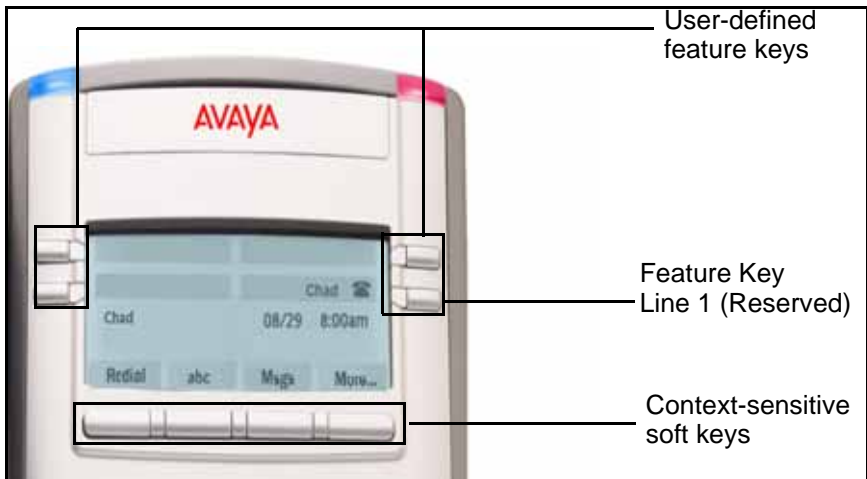

Basic features

Your Avaya 1120E IP Deskphone supports the following features:

- four user-defined feature keys with labels and indicators

Note: The IP Deskphone designates Key 1 as Feature Key 1 and reserves it as the line key for the IP Deskphone.

- four context-sensitive soft keys

- graphical, high-resolution LCD display, backlit, with adjustable contrast
- high-quality speaker phone
- volume control keys for adjusting the ringer, speaker, handset, and headset volume
- six specialized feature keys:
 - Quit
 - Directory
 - Inbox
 - Outbox
 - Services
 - Copy
- six call-processing fixed keys:
 - Mute
 - Handsfree
 - Goodbye
 - Instant Message Log
 - Headset
 - Hold
- gigabit Ethernet ports
- built-in gigabit Ethernet switch for shared PC access
- headset jack with an On/Off key
- USB port to support a keyboard or mouse
 - Note:** Powered downstream 1.1-compliant USB hubs are supported, including USB 2.0 hubs, if they offer USB 1.1 backwards compliancy.
- automatic Dynamic Host Configuration Protocol (DHCP) network configuration
- hearing aid compatibility
- intercom/paging support
- secure digits when accessing voice mail during a call

- logging off the IP Deskphone without entering a password
- dialing a call from the Inbox
- the capacity to attach up to three Expansion Modules for Avaya 1100 Series IP Deskphones, adding up to 54 programmable feature keys

Avaya 1120E IP Deskphone controls

Figure 2 on page 17 shows the Avaya 1120E IP Deskphone.

Figure 2: Avaya 1120E IP Deskphone



This section describes the controls on your IP Deskphone. Your IP Deskphone can have fixed keys with icons or with labels. This document presents both versions of the fixed key.



The keys on either side of the LCD display area are **User-defined feature keys**, with labels on the LCD. The system administrator can reserve some keys for specific functions during tasks and for advanced configuration.

You can define these keys for specific functions, such as Call Forward.

Note: The key on the lower right is reserved as your default line key.



Context-sensitive soft keys are located below the display area. The LCD label above each key changes based on the active feature.



Use the **Volume control** buttons to adjust the volume of the ringer, handset, headset, speaker, and the Handsfree feature. Press the top button to increase the volume, and press the bottom button to decrease the volume.



Press the **Mute** key to listen to the call without transmitting. Press the **Mute** key again to return to two-way conversation. The **Mute** key applies to handsfree, handset, and headset microphones.

Note: When you enable mute, a red LED on the **Mute** key remains lit.



Handsfree

Press the **Handsfree** key to activate the built-in speaker and microphone of the IP Deskphone.

Note: The Handsfree LED indicator on the **Handsfree** key lights to indicate when handsfree is active.



Use the **Navigation Key Cluster** to scroll through menus and lists that appear on the LCD display screen or for text entry. The outer part of this key cluster rocks for up, down, left, and right movements. For more information, see “[Navigation keys](#)” on [page 40](#).



Use the **Enter** key, at the center of the **Navigation Key Cluster**, to select menu items or to confirm changes.

Note: The **Enter** key has the same function as the context-sensitive soft keys **Select** and **Set**.



Goodbye

Press the **Goodbye/Release** key to terminate an active call. When multiple calls are active, press the **Goodbye/Release key** to end the highlighted call.

Use the **Goodbye/Release** to close menu navigation or cancel user tasks.



Expand

Press the **Expand** key to access the Instant Messaging Log.



Press the **Headset** key to answer a call using the headset or to switch a call from the handset or handsfree to the headset.

Note: The Headset LED indicator on the **Headset** key lights to indicate that the headset is in use.



Press the **Hold** key to put an active call on hold. Press the **Hold** fixed key to return to a call on hold.

You can have several calls in a hold state.



Use the **Dialpad** to enter numbers and text.

To navigate to an item in a menu, press the corresponding number on the dialpad to activate the item or continue navigate the list of items.



When you receive a voice message, the red **Visual Alerter/Message Waiting Indicator** lights. Also, when the ringer sounds, this indicator flashes.



When you receive an instant message (IM), the blue **Visual Alerter/Feature Status Indicator** lights.



Press the **Copy** key to copy contact information from one source such as the Address Book to a destination such as a feature key.

**Services**

Press the **Services** key to access the following features:

1. Search—search in the local directory (personal Address Book) and the global directory (network Address Book for names and telephone numbers)
2. Login—log in to your IP Deskphone only when the call server supports multiple user logins.
3. Logout—log out of your IP Deskphone.
4. Check For Updates—check for the latest software update for the IP Deskphone. Retrieve Parked Call (This feature is not available on all call servers.)
5. Reset Phone—reset your IP Deskphone.
6. File Manager—manage the IP Deskphone file system and USB Devices attached to the IP Deskphone.
7. Logging System—enable or disable the logging process.
8. Phone Information—view information about the hardware and software on your IP Deskphone, including user and location information.

Press the **Services** key twice quickly to access the Network menu.

**Quit**

Press the **Quit** key to cancel the current operation or to exit the menu.

Note: Pressing the **Quit** key does not affect the status of active calls.



Msg/Inbox

Press the **Inbox** key to access your call inbox.

The call inbox stores all incoming calls on an active IP Deskphone.

Note: This key does not function to send Instant Messages.



Shift/Outbox

Press the **Outbox** key to view a record of all outgoing calls.

Note: This key does not function as a *shift* key.



Directory

Press the **Directory** key to access the Address Book and the Friends list.

Note: You can access the Address Book while on a call and start a new call with a highlighted contact.

Avaya 1120E IP Deskphone display

Your Avaya 1120E IP Deskphone has three display areas:

- The upper display area provides line and feature key status.
- The middle display area contains single-line information for items such as caller number, caller name, menu items, feature prompt strings, user-entered digits, date and time information, and telephone information.
- The lower display area provides context-sensitive soft key label information.

Figure 3: IP Deskphone LCD screen

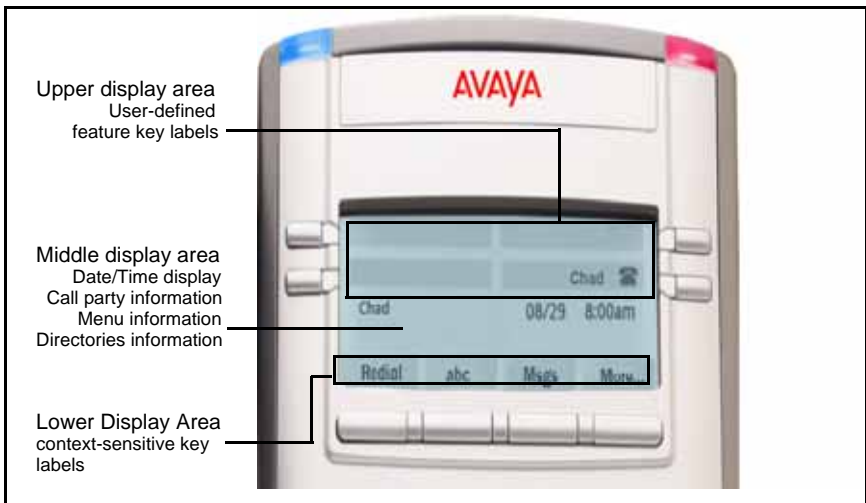

Cleaning the Avaya 1120E IP Deskphone LCD display screen

To clean the LCD display screen, gently wipe with a soft, dry cloth.

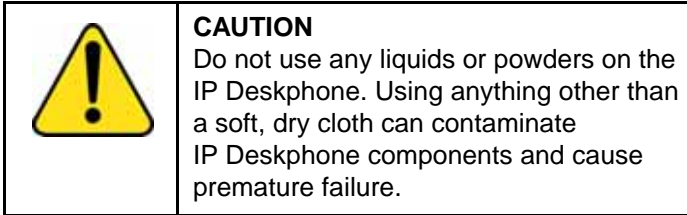

Context-sensitive soft keys

Your Avaya 1120 IP Deskphone has four context-sensitive soft keys beneath the LCD screen. The context-sensitive soft keys access different features and menus depending on the state of the IP Deskphone and the menu you access.

[Figure 4 on page 24](#) shows the context-sensitive soft keys while the IP Deskphone is in the idle state.

Figure 4: Context-sensitive soft keys when the IP Deskphone is in the idle state

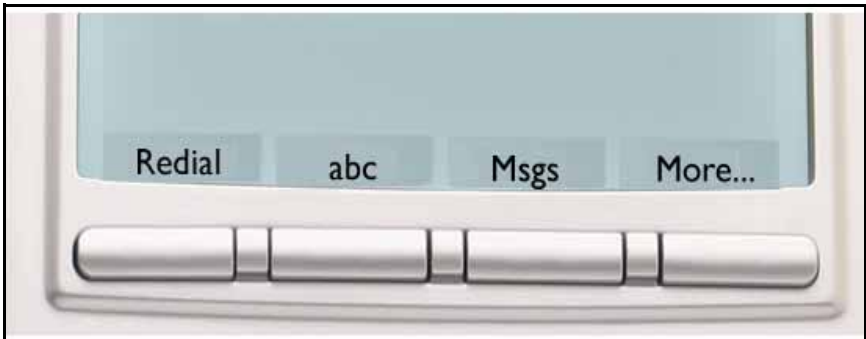

Table 1 on page 25 lists the context-sensitive soft keys that you can use to access menu items..

Table 1: Menu items accessed through context-sensitive soft keys (Part 1 of 6)



Item	Function
<p style="text-align: center;">Redial or NewCall</p> 	<p>Press the Redial context-sensitive soft key to redial the last dialed number.</p> <p>If there is no stored redial number, the NewCall context-sensitive soft key appears and has the same effect as pressing the primary user line key (dial prompt).</p>
<p style="text-align: center;">abc or 123</p> 	<p>Press the abc context-sensitive soft key to toggle between alpha and numeric input modes.</p> <ul style="list-style-type: none"> • To type letters, the abc context-sensitive soft key must be displayed. • To type numbers, press the abc context-sensitive soft key to display the 123 context-sensitive soft key on the menu list.
<p style="text-align: center;">Msgs</p> 	<p>Press the Msgs context-sensitive soft key to access the following features:</p> <ol style="list-style-type: none"> 1. Voice Mail—use to call your Voice Mail number. 2. Instant Messaging—use to access the Instant Messaging Inbox/Outbox. 3. Missed Call Notification—use to access your Missed Call details.

Table 1: Menu items accessed through context-sensitive soft keys (Part 2 of 6)

Item	Function
<p style="text-align: center;">More...</p> 	<p>Press the More... context-sensitive soft key to select a new menu list of context-sensitive soft keys (three menu lists are available).</p> <p>When you press the More... context-sensitive soft key, a different selection of context-sensitive soft keys appears.</p> <ul style="list-style-type: none"> • If you press the More... context-sensitive soft key once from the first menu list, you access the following context-sensitive soft keys: [CallFwd] [DND] [Retrvr] [More...] • If you press the More... context-sensitive soft key from the first menu list twice, you access the following context-sensitive soft keys: [ScrnSvr] [Presnce] [Prefs] [More...] • If you press the More... context-sensitive soft key from the first menu list three times, you return to the first menu list with the following context-sensitive soft keys: [Redial] [abc] [Msgs] [More...]
<p>When you press the More... context-sensitive soft key for the first time, the following context-sensitive soft keys appear on the menu list.</p>	

Table 1: Menu items accessed through context-sensitive soft keys (Part 3 of 6)

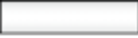



Item	Function
<p style="text-align: center;">CallFwd</p> 	<p>Press the CallFwd context-sensitive soft key to forward all calls to a specified address.</p>
<p style="text-align: center;">DND</p> 	<p>Press the DND context-sensitive soft key to block all calls.</p>
<p style="text-align: center;">Retrve</p> 	<p>Press the Retrve context-sensitive soft key to retrieve parked calls (local and server calls only).</p>
<p style="text-align: center;">More...</p> 	<p>Press the More... context-sensitive soft key to select a new menu list of context-sensitive soft keys.</p> <p>The next available menu list contains the following context-sensitive soft keys:</p> <p style="text-align: center;">[ScrnSvr] [Presnce] [Prefs] [More...]</p>
<p>When you press the More... context-sensitive soft key for the second time, the following context-sensitive soft keys appear on the menu list.</p>	
<p style="text-align: center;">ScrnSvr</p> 	<p>Press the ScrnSvr context-sensitive soft key to activate the screensaver (only if the screensaver feature is enabled).</p>

Table 1: Menu items accessed through context-sensitive soft keys (Part 4 of 6)



Item	Function
<p style="text-align: center;">Presnce</p> 	<p>Press the Presnce context-sensitive soft key to configure the presence status for your IP Deskphone.</p>
<p style="text-align: center;">Prefs</p> 	<p>Press the Prefs context-sensitive soft key to display the Preferences menu.</p> <p>The menu items include the following:</p> <ol style="list-style-type: none"> 1. Display—use to adjust the display settings of the LCD screen. 2. Audio—use to adjust tones and volume settings, access the Codecs menu to configure a USB headset. 3. Feature Options—use to configure the following: <ul style="list-style-type: none"> — Feature keys — Call Decline Reasons — Call Ignore Action — Call Subjects — Call Fwd Notification — Answer Mode Settings appear when the Auto Answer Mode is enabled on the IP Deskphone.

Table 1: Menu items accessed through context-sensitive soft keys (Part 5 of 6)



Item	Function
<p>Prefs</p> 	<ol style="list-style-type: none"> 4. Language—use to change the interface language. 5. Misc Options—use to access the following options: <ul style="list-style-type: none"> — Alpha Dialing — Search Method — Incoming Privacy — Outgoing Privacy — # Ends Dialing — Hold Mode: Private — Time 6. Network—use to access the following: <ul style="list-style-type: none"> — Server Settings — Device Settings — Diagnostics — Disable screensaver — Licensing — Lock 7. USB Locks—use to lock or unlock the following USB devices: <ul style="list-style-type: none"> — USB Mouse — USB Keyboard — USB Headset — USB flash drive

Table 1: Menu items accessed through context-sensitive soft keys (Part 6 of 6)

Item	Function
<p>Prefs</p> 	<p>8. User Settings - use to modify the following:</p> <ul style="list-style-type: none"> — Call Settings — IM Settings — Voice Mail Settings — Change Location
<p>More...</p> 	<p>Press the More... context-sensitive soft key to return to the first menu list of context-sensitive soft keys.</p> <p>The next available menu list contains the following context-sensitive soft keys:</p> <p>[Redial] [abc] [Msgs] [More...]</p>

Idle display screen after dial pad input

After you enter information using the dial pad (there is no dial tone or preceding line selection), the context-sensitive soft keys displayed on the idle screen appear as shown in [Figure 7 on page 62](#).

Figure 5: Idle display screen after dial pad input

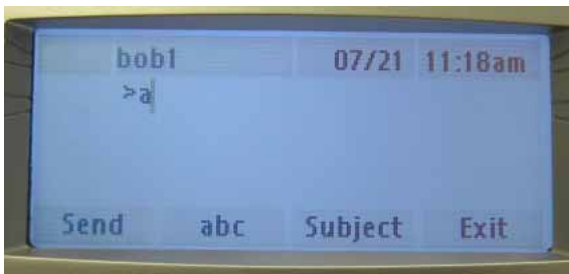
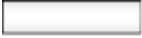

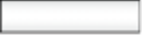

Table 2 on page 31 lists the context-sensitive soft keys that you can use to access menu items after dial pad input.

Table 2: Menu items accessed after dial pad input through context-sensitive soft keys

Item	Function
Send 	Press the Send context-sensitive soft key to dial out the user input using the primary login of the IP Deskphone. User input is run against the dialing plan.
abc or 123 	Press the abc or 123 context-sensitive soft key to toggle between alpha and numeric input mode.
Subject 	Press the Subject context-sensitive soft key to configure a subject line to your outgoing call before pressing the Send context-sensitive soft key.
Exit 	Press the Exit context-sensitive soft key to clear the user input and return to the initial idle screen that displays the following context-sensitive soft keys: [Redial] [abc] [Msgs] [More...]. See “Figure 4 on page 24 shows the context-sensitive soft keys while the IP Deskphone is in the idle state.” on page 24.

In-call context-sensitive soft keys

When a call is active, use the context-sensitive soft keys to access the menu items shown in Figure 6 on page 32.

Figure 6: In-call context-sensitive soft keys



lists the context-sensitive soft keys you can use to access menu items during an in-call session.

Table 3: Menu items accessed during an in-call session through context-sensitive soft keys (Part 1 of 9)



Item	Function
<p style="text-align: center;">Conf</p> 	<p>Press the Conf context-sensitive soft key to obtain a dial tone to place another call during an active call or to make a conference call.</p> <p>The Conf context-sensitive soft key behaves like the NewCall context-sensitive soft key.</p>
<p style="text-align: center;">Trnsfer</p> 	<p>Press the Trnsfer context-sensitive soft key to transfer the current call to another location or to another contact.</p>

Table 3: Menu items accessed during an in-call session through context-sensitive soft keys (Part 2 of 9)

Item	Function
<p data-bbox="235 331 317 358">Audio</p> 	<p data-bbox="471 324 878 415">Press the Audio context-sensitive soft key to access the following features:</p> <p data-bbox="471 435 551 462">Tones</p> <ul style="list-style-type: none"> <li data-bbox="471 483 889 589">• Ring Pattern <ul style="list-style-type: none"> <li data-bbox="519 532 889 589">— Select test patterns from 1 to 8 <li data-bbox="471 610 804 685">• Alerting Volume <ul style="list-style-type: none"> <li data-bbox="519 659 804 685">— Set Desired volume

Table 3: Menu items accessed during an in-call session through context-sensitive soft keys (Part 3 of 9)

Item	Function
<p style="text-align: center;">Audio</p> 	<p>Voice</p> <ul style="list-style-type: none"> • Configure the volume for the following: <ul style="list-style-type: none"> — Handset Volume — Headset Volume — Handsfree Volume <p>Codecs</p> <p>Select the Audio Codecs:</p> <ul style="list-style-type: none"> • G722 (wideband codec) • PCMU (standard u-law) • G729 (729 codec) • PCMA (standard a-law) <p>Headset Selection</p> <p>Select the active headset device:</p> <ul style="list-style-type: none"> • Wired, USB (if wired, then select type 1, 2 or 3) • Enable HID Commands (enable or disable) • MHA Headset Type: • MHA Back Light (enable or disable)

Table 3: Menu items accessed during an in-call session through context-sensitive soft keys (Part 4 of 9)



Item	Function
<p>Audio</p> 	<p>Note: You can change the audio settings to improve audio quality based on the available band width. If the Internet bandwidth is low, you can improve the audio quality by changing the audio setting to low.</p> <ul style="list-style-type: none"> • Monitor Audio Quality—used to view details about the audio quality of an active call. <p style="text-align: center;">OR</p>
<p>Activate</p> 	<p>The Activate context-sensitive soft key appears when the call is not active. The most common usage of this key is when the call displayed onscreen is a call that was parked against the user (or a call that the user placed on hold).</p> <p>Note: The Activate context-sensitive soft key never appears at the same time as the Audio context-sensitive soft key.</p>
<p>More...</p> 	<p>Press the More... context-sensitive soft key to select a new menu list of context-sensitive soft keys (three menu lists are available).</p> <p>When you press the More... context-sensitive soft key, a different selection of context-sensitive soft keys appears.</p>

Table 3: Menu items accessed during an in-call session through context-sensitive soft keys (Part 5 of 9)



Item	Function
<p>More...</p> 	<ul style="list-style-type: none"> If you press the More... context-sensitive soft key once from the first menu list, you access the following context-sensitive soft keys: [NewCall] [Park] [Retrve] [More....] If you press the More... context-sensitive soft key from the first menu list twice, you access the following context-sensitive soft keys: [Prefs] [] [] [More...] If you press the More... context-sensitive soft key from the first menu list three times, you return to the first menu list with the following context-sensitive soft keys. [Conf] [Tnsfer] [Audio] [More...
<p>When you press the More... context-sensitive soft key for the first time, the following context-sensitive soft keys appear on the menu list.</p>	
<p>NewCall</p> 	<p>Press the NewCall context-sensitive soft key to obtain a dial tone to place another call during an active call or to a make a conference call.</p> <p>The NewCall context-sensitive soft key behaves like the Conf context-sensitive soft key.</p>

Table 3: Menu items accessed during an in-call session through context-sensitive soft keys (Part 6 of 9)





Item	Function
Park 	Press the Park context-sensitive soft key to park the current call to the server or another user (not available for all call servers).
Retrve 	Press the Retrve context-sensitive soft key to retrieve parked calls (local and server parked calls only).
More... 	Press the More... context-sensitive soft key to select a new menu list of context-sensitive soft keys. The next available menu list contains the following context-sensitive soft keys: [Prefs] [] [] [More...]
When you press the More... context-sensitive soft key for the second time, the following context-sensitive soft keys appear on the menu list.	
Prefs 	Press the Prefs context-sensitive soft key to display the Preferences menu. The menu items include the following: <ol style="list-style-type: none"> 1. Display—use to adjust the display settings of the LCD screen.

Table 3: Menu items accessed during an in-call session through context-sensitive soft keys (Part 7 of 9)

Item	Function
<p style="text-align: center;">Prefs</p> 	<ol style="list-style-type: none"> 2. Audio—use to adjust tones and volume settings and to configure a USB headset. 3. Feature Options—use to configure the following: <ul style="list-style-type: none"> — Feature keys — Call Decline Reasons — Call Ignore Action — Call Subject — Call Fwd Notification — Missed Call Notification. 4. Language—use to change the interface language. 5. Misc Options—use to access the following options: <ul style="list-style-type: none"> — Alpha Dialing — Search Method — Incoming Privacy — Outgoing Privacy — # Ends Dialing — Hold Mode: Private — Time

Table 3: Menu items accessed during an in-call session through context-sensitive soft keys (Part 8 of 9)



Item	Function
<p>Prefs</p> 	<ol style="list-style-type: none"> 6. Network—use to access the following: <ul style="list-style-type: none"> — Server Settings — Device Settings — Diagnostics — Disable screensaver — Licensing — Lock 7. USB Locks—use to lock or unlock the following USB devices: <ul style="list-style-type: none"> — USB Mouse — USB Keyboard — USB Headset — USB flash drive 8. User Settings—use to modify the following: <ul style="list-style-type: none"> — Call Settings — IM Settings — Voice Mail Settings — Change Location

Table 3: Menu items accessed during an in-call session through context-sensitive soft keys (Part 9 of 9)

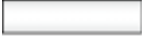
Item	Function
<p style="text-align: center;">More...</p> 	<p>Press the More... context-sensitive soft key to return to the first menu list of context-sensitive soft keys.</p> <p>The next available menu list contains the following context-sensitive soft keys:</p> <p style="text-align: center;">[Conf] [Trnsfer] [Audio] [More...]</p>
<p style="text-align: center;">Unlock</p> 	<p>The Unlock context-sensitive soft key appears if you answer a call when the IP Deskphone is locked with a password protected screensaver.</p>

Navigation keys

This section provides information about keys you can use to navigate within the menus of your Avaya 1120E IP Deskphone.

Note: Menu items are sorted by number.

You can select menu items in one of the following ways:

- Press the corresponding number on the dialpad and then press the **Select** soft key.
- Use the navigation key to scroll through the menu to highlight the item you want to select and then press the **Select** soft key.

Table 4 on page 41 describes the navigation keys and their functions.

Table 4: Navigation keys and functions (Part 1 of 2)



Key	Function
<p>Navigation Key Cluster</p> 	<p>Press the Left or Right arrows on the Navigation Key Cluster to:</p> <ul style="list-style-type: none"> • Scroll long lines of text when you view caller ID. <p>Note: The IP Deskphone automatically scrolls long lines of text from right to left for entries such as in your address book or your Call Inbox. When your Search Method is set to Index Search, you can increase the speed of the scrolling by repeatedly pressing the right navigation key or decrease the scrolling speed by repeatedly pressing the left navigation key. For more information, see “Searching for a contact in the Address Book” on page 155.</p> <ul style="list-style-type: none"> • Change the slide adjustment from left to right when you adjust such things as contrast or volume.
<p>Navigation Key Cluster</p> 	<p>Press the right side of the Navigation Key Cluster to:</p> <ul style="list-style-type: none"> • Create a space when you enter and edit text. • View the details of the selected call log entry in the Inbox and the Outbox.

Table 4: Navigation keys and functions (Part 2 of 2)

Key	Function
<p>Navigation Key Cluster</p> 	<p>Press the left side of the Navigation Key Cluster to:</p> <ul style="list-style-type: none"> • Move cursor to the left when you enter and edit text. • Leave the detail view of the Inbox or Outbox and return to the main Inbox or Outbox. Operates like the Back context-sensitive soft key. <p>Press the up or down arrows on the Navigation Key Cluster to:</p> <ul style="list-style-type: none"> • Erase a character (backspace) when you enter and edit text. • Highlight items in a list, such as Address Book entries or items in your Call Inbox. • Scroll lists and message contents when you view Instant Messages. <p>Note 1: Move the cursor from line to line when entering and editing text or data.</p> <p>Note 2: To scroll through a list of items, you can press and hold the up or down key.</p>

Using a USB Mouse

The IP Deskphone is equipped with a USB port in which you can connect a USB mouse. You can use the USB mouse to activate context-sensitive soft key items and menu items.

Use your mouse to click a context-sensitive soft key label of the LCD screen to activate that item. When a menu is open, double-click on a

menu item to activate it or click on the item to highlight it. For example, you can click the **View** context-sensitive soft key label to open that menu. Double-click the word **Inbox** in the menu list; you can then double-click a name in the Inbox list to initiate a call, or click the item to highlight the name.

To access the Network menu, right-click anywhere on the display.

Note: USB mouse support is available for the Avaya 1120E IP Deskphone but does not extend to added Expansion Modules.

Available IP Deskphone call features

The IP Deskphone is designed to be supported by various call servers. The specific call server in which the IP Deskphone is connected to determines whether certain features are available to your IP Deskphone. Call features must be assigned to your IP Deskphone and must be supported by call server software.

Note 1: Not all feature are available. To determine which features are available or to activate features, contact your system administrator or service provider.

Note 2: Not all service providers support the entry of a SIP address to initiate a call, for example, jim@company.com. Some service providers require that you enter a Directory Number (DN) to initiate a call, for example, 555-5555. Contact your system administrator to determine whether your call server supports SIP address dialing.

Security features

Before you can use your IP Deskphone, an ID and password must be assigned to your IP Deskphone. This security measure ensures that, after you log off, calls cannot be made from your IP Deskphone and features such as Address Book, Instant Message logs, and Call Outbox are inaccessible. Your ID and password also prevent unauthorized access to your user profile.

Secure connection

Call security is identified by the presence of a security icon (padlock)



that is displayed on the IP Deskphone screen.

After the IP Deskphone is registered with the SIP Proxy, you can view the security icon when:

- the IP Deskphone is idle
- you are on an active call

[Figure 7 on page 62](#) is an example of a secure connection when the IP Deskphone is idle. The security icon is visible on the IP Deskphone screen.

Figure 7: Example of a secure connection when the IP Deskphone is idle

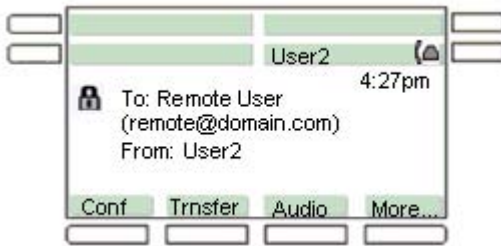

[Figure 8 on page 66](#) is an example of a secure connection when you are on an active call. The security icon is visible on the IP Deskphone screen.

Figure 8: Example of a secure connection during an active call

Regulatory and safety information

This equipment has been tested and found to comply with the limits for a Class B digital device, pursuant to part 15 of the FCC Rules. These limits are designed to provide reasonable protection against harmful interference in a residential installation. This equipment generates, uses and can radiate radio frequency energy and, if not installed and used in accordance with the instructions, may cause harmful interference to radio communications. However, there is no guarantee that interference will not occur in a particular installation. If this equipment does cause harmful interference to radio or television reception, which can be determined by turning the equipment off and on, the user is encouraged to try to correct the interference by one or more of the following measures:

- Reorient or relocate the receiving antenna.
- Increase the separation between the equipment and receiver.
- Connect the equipment into an outlet on a circuit different from that to which the receiver is connected.
- Consult the dealer or an experienced radio/ TV technician for help.

Note: The user should not make changes or modifications not expressly approved by Avaya. Any such changes could void the user authority to operate the equipment

This Class B digital apparatus complies with Canadian ICES-003. Cet appareil numérique de la classe B est conforme à la norme NMB-003 du Canada.

Warnings:

- This is a Class B product. In a domestic environment this product can cause radio interference in which case the user must take adequate measures.
- Operation is subject to the following two conditions: (1) this device may not cause interference, and (2) this device must accept any interference, including interference that may cause undesired operation of the device."

この装置は、情報処理装置等電波障害自主規制協議会（VCCI）の基準に基づくクラスB情報技術装置です。この装置は、家庭環境で使用することを目的としていますが、この装置がラジオやテレビジョン受信機に近接して使用されると、受信障害を引き起こすことがあります。

取扱説明書に従って正しい取り扱いをして下さい。

Table 5 lists EMC compliance for various jurisdictions.

Table 5: EMC compliance

Jurisdiction	Standard	Description
United States	FCC CFR 47 Part 15	Class B Emissions: FCC Rules for Radio Frequency Devices (see Notes 1 and 2)
Canada	ICES-003	Class B Emissions: Interference-Causing Equipment Standard: Digital Apparatus
Australia/ New Zealand	AS/NZ CISPR 22 CISPR 22	Class B Emissions: Information technology equipment - Radio disturbance
European Community	EN 55022	Class B Emissions: Information technology equipment - Radio disturbance
	EN 55024	Information technology equipment - Immunity characteristics Limits and methods of measurement
	EN 61000-3-2	Limits for harmonic current emissions (equipment input current \leq 16 A per phase)
	EN 61000-3-3	Limitation of voltage fluctuations and flicker in low-voltage supply systems for equipment with rated current \leq 16 A
Japan	VCCI	Regulations for voluntary control measures.

Table 6 lists Safety compliance for various jurisdictions.

Table 6: Safety compliance

Jurisdiction	Standard	Description
United States	UL 60950-1	Safety of Information Technology Equipment
Canada	CSA 60950-1-30	Safety of Information Technology Equipment
European Community	EN 60950-1	ITE equipment - Safety - Part 1: General requirements
Australia/New Zealand	AS/NZS 60950.1:2003	Safety of Information Technology Equipment

Other

US/Canada: Hearing Aid Compatibility (HAC) as per FCC Part 68

This equipment complies with the CE Marking requirements. 

EU Countries: This device complies with the essential requirements and other relevant provisions of Directive 1999/5/EC. A copy of the Declaration may be obtained from <http://support.avaya.com/css/appmanager/public/support>.

Australia: AS/ACIF S004: Voice Frequency Performance Requirements for Customer Equipment

DenAn regulatory notice for Japan

Warning

Please be careful of the following while installing the equipment:

- Please only use the Connecting cables, power cord, AC adaptors shipped with the equipment or specified by Nortel to be used with the equipment. If you use any other equipment, it may cause "failures, malfunctioning or fire".
- Power cords shipped with this equipment must not be used with any other equipment. In case the above guidelines are not followed, it may lead to death or severe injury

警告

本製品を安全にご使用頂くため、以下のことにご注意ください。

- 接続ケーブル、電源コード、ACアダプタなどの部品は、必ず製品に同梱されております。添付品または指定品をご使用ください。添付品・指定品以外の部品をご使用になると故障や動作不良、火災の原因となることがあります。
- 同梱されております付属の電源コードを他の機器には使用しないでください。上記注意事項を守らないと、死亡や大怪我など人身事故の原因となることがあります。

Using your Avaya 1120E IP Deskphone

After you familiarize yourself with the Avaya 1120E IP Deskphone features, you can start to use the IP Deskphone.

Getting started

This section provides information about how to use the IP Deskphone. Carefully read each section before you operate the new IP Deskphone.

The following sections describe details about the IP Deskphone:

- [“Before you begin” on page 51](#)
- [“Connecting the components” on page 51](#)
- [“Entering text” on page 60](#)
- [“Accessing the Avaya 1120E IP Deskphone” on page 68](#)
- [“Configuring the Avaya 1120E IP Deskphone” on page 86](#)

Before you begin

**CAUTION****Damage to Equipment**

Do not plug your IP Deskphone into a regular telephone jack. This can result in severe damage to the IP Deskphone. Consult your system administrator to ensure that you plug your telephone into a 10/100/1000 BaseT Ethernet jack.

**CAUTION**

Your IP Deskphone is designed for use in an indoor environment only.

**CAUTION**

Do not plug your Avaya 1120E IP Deskphone into an Integrated Service Digital Network (ISDN) connection. Severe damage to the Avaya 1120E IP Deskphone can result.

Connecting the components

Figure 9 on page 102 shows the connections on the IP Deskphone.

Figure 9: IP Deskphone connections

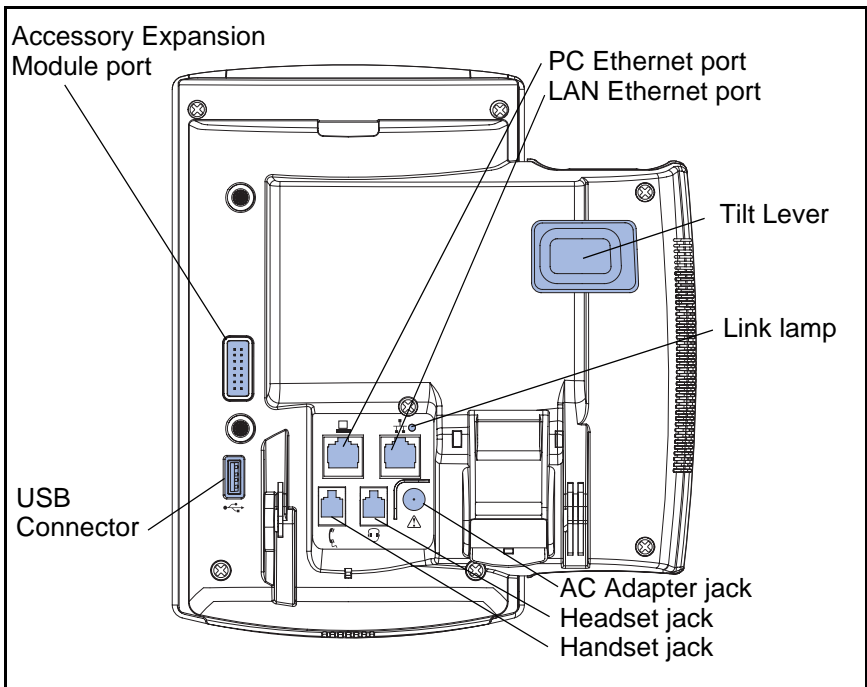

WARNING Ensure that the protective rubber cap on the Expansion Module port is in place when the port is not in use. Connection of anything other than the proper Expansion Module connector to this port can cause damage to the IP Deskphone.

Install your IP Deskphone by completing the following procedures in the order listed:

- [“Removing the stand cover” on page 53](#)
- [“Connecting the AC power adapter \(optional\)” on page 54](#)
- [“Connecting the handset” on page 55](#)
- [“Connecting the headset \(optional\)” on page 56](#)
- [“Connecting the LAN ethernet cable” on page 57](#)
- [“Installing additional cables” on page 58](#)

- “Wall-mounting the IP Deskphone (optional)” on page 58

Figure 10: Wall-mount lever

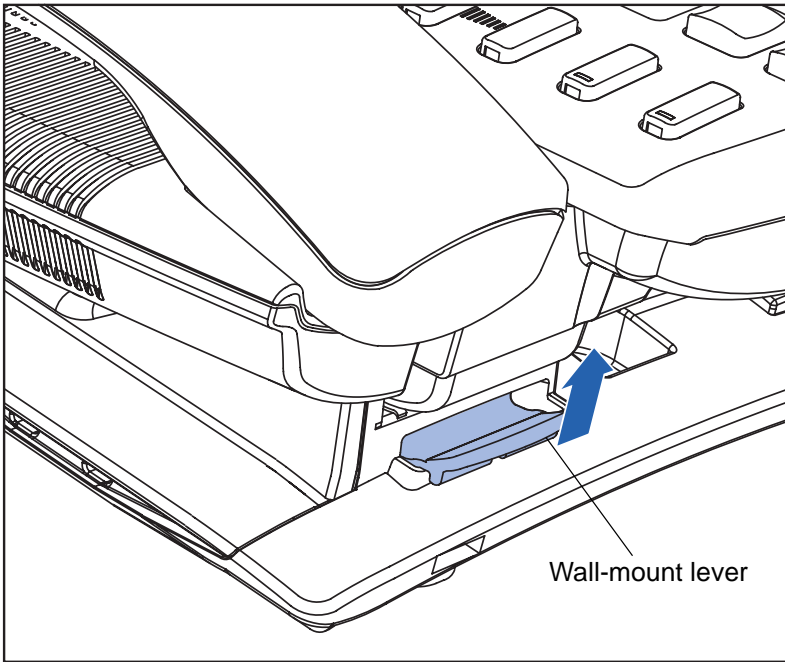

WARNING Your Avaya 1120E IP Deskphone is shipped with the base locked in position. To avoid damaging your phone, press the wall-mount lever, located under the Handsfree key as indicated in the previous figure, to release the base and pull it away from the IP Deskphone.

Removing the stand cover

To access the cable routing tracks and attach cables, you must remove the stand cover. Pull upward on the center catch as indicated in the following figure, and remove the stand cover. The cable routing tracks are now accessible.

Figure 11: Remove the stand cover

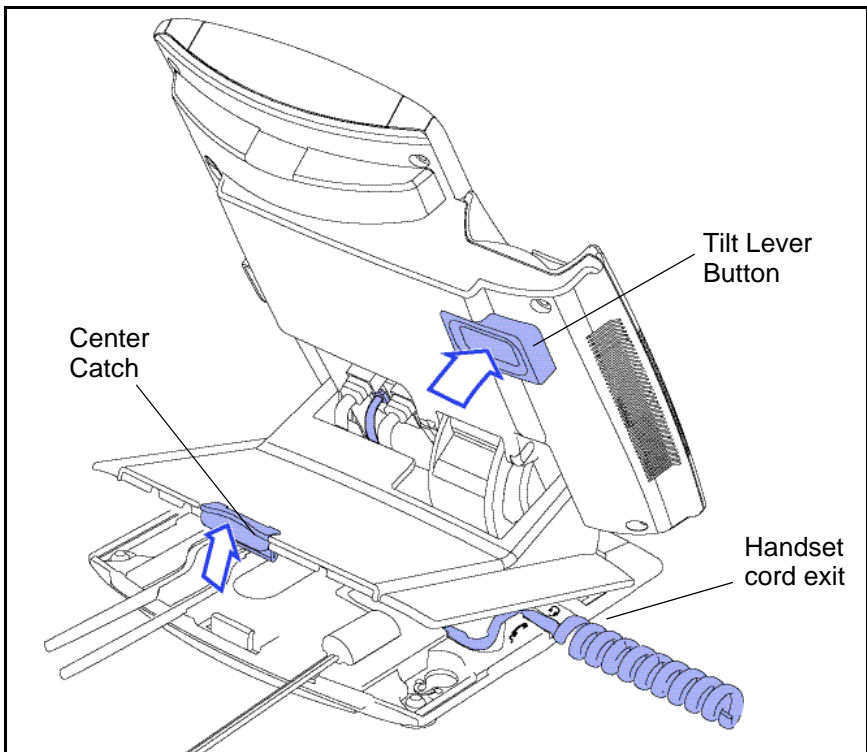

Connecting the AC power adapter (optional)

Your IP Deskphone supports AC power and Power over Ethernet (PoE) options, including IEEE 802.3af standard power. For AC power, use the Avaya AC adapter only. You can order the optional Avaya AC adapter (N0023000) separately.



WARNING

Use only the approved Avaya AC Adapter (model #N0023000) with your IP Deskphone.

To connect the AC adapter to the AC adapter jack in the bottom of the IP Deskphone use the following procedure:

1. Form a small bend in the cable.
2. Thread the adapter cord through the channels in the stand.

To use PoE, your connected LAN must support PoE. A PoE-enabled LAN delivers power to your IP Deskphone over the CAT-5 network cable and an AC adapter is not required.

**WARNING**

If you are connected to a PoE connection do not use the AC power adapter

To use gigabit Ethernet, you must connect to the LAN through CAT-5e (or later) cables.

Connecting the handset

Use the following procedure to connect the handset to the IP Deskphone.

1. Connect the end of the handset cable with a short straight section to the handset.
2. Connect the end of the handset cable with the long straight section, into the RJ-9 handset jack marked with the + symbol on the back of the IP Deskphone.
3. Form a small bend in the cable.
4. Thread the handset cord through the channels in the stand so that it exits behind the handset on the right side, using the handset cord exit in the stand base marked with the + symbol as shown in [Figure 11 on page 54](#).

Connecting the headset (optional)

Perform the following procedure to connect the optional headset to the IP Deskphone.

1. On the back of the IP Deskphone, plug the headset connector into the RJ-9 headset jack marked with the) symbol.
2. Thread the headset cord, along with the handset cord, through the channels in the stand so that the headset cord exits the channel marked with the) symbol.

Selecting the headset tuning parameter

You can select a headset from the following list of supported headsets.

- Type 1: Monaural and Binaural Headset
 - Monaural Headset: Plantronics Model number: H251N (Part number: 64338-01) with cable Model Number: A10 (Part Number: 66268-02)
 - Binaural Headset: Plantronics Model number: H261N (Part number: 64339-01) with cable Model Number: A10 (Part Number: 66268-02)
- Type 2: Monaural and Binaural Headset
 - Monaural Headset: Plantronics Model number: HW251N (Part number: 75100-06) with cable Model Number: A10 (Part Number: 66268-02)
 - Binaural Headset: Plantronics Model number: HW261N (Part number: 75101-06) with cable Model Number: A10 (Part Number: 66268-02)
- Type 3: Binaural Headset
 - Binaural Headset: GN Netcom Model number: GN 4800 (Part number: 48492-09)

After you select a headset, the corresponding tuning parameters are applied automatically.

Perform the following procedure to select a headset.

1. Press **Prefs**.
2. Select **Audio**.
3. Select **Headset Type**.

Connecting the LAN ethernet cable

Note: Your IP Deskphone supports both AC power and PoE options, including IEEE 802.3 standard power. To use local AC power, you can order the optional AC adapter separately. To use PoE, where power is delivered over the CAT5 cable, the LAN must support PoE, and you do not need an AC adapter.

To enable full functionality of your IP Deskphone, connect your IP Deskphone to your LAN using a CAT5e Ethernet cable. If your network is equipped with PoE, you can power your IP Deskphone through the LAN port.

To connect your IP Deskphone to your LAN use the following procedure:

1. Connect one end of the supplied Ethernet cable to the back of your IP Deskphone by using the RJ-45 connector marked with the % symbol.
2. Thread the network cable through the channel marked with the % symbol.
3. Connect the other end of the cable to your LAN Ethernet connection.

To connect your PC through your IP Deskphone use the following procedure:

1. Connect one end of the PC Ethernet cable to your IP Deskphone using the RJ-45 connector marked with the % symbol.
2. Thread the cable through the channel marked with the (symbol.
3. Connect the other end of the cable to the LAN connector on the back of your PC.

Installing additional cables

If applicable, you can plug an optional USB device such as a USB mouse or a USB keyboard into your IIP Deskphone. Connect the USB cable to the USB port on the back of the IP Deskphone.

Figure 12: Cable routing tracks and mounting holes

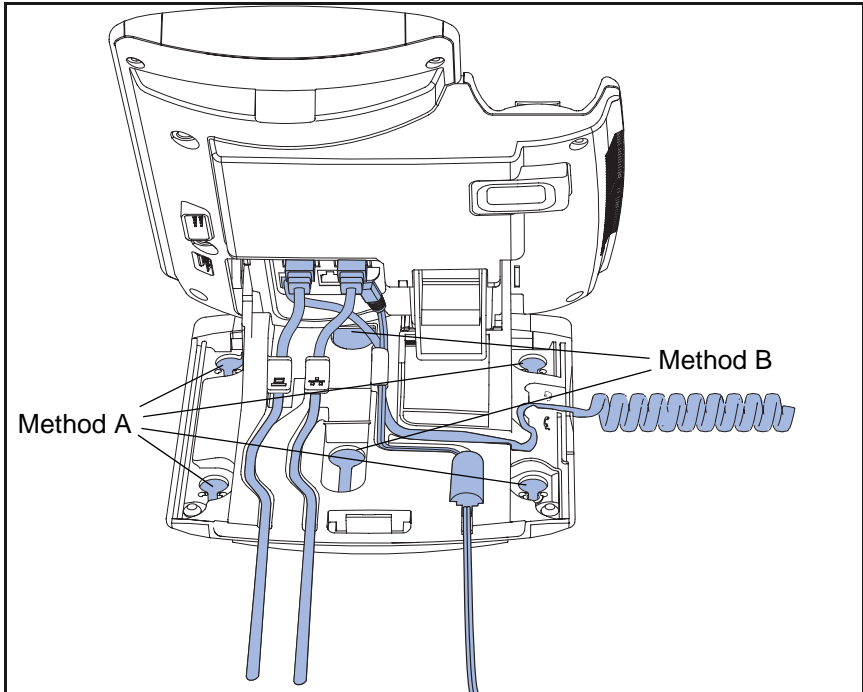

Wall-mounting the IP Deskphone (optional)

You can mount your Avaya 1120E IP Deskphone on a wall either by: (method A) using the mounting holes on the bottom of the IP Deskphone stand or (method B) using a traditional-style wall-mount box with an RJ-45 connector and 15 centimeter (cm) (6-inch) RJ-45 cord (not provided).

Complete steps 1-7, as needed, before you wall-mount your IP Deskphone:

Method A:

1. Press the wall-mount lever, and pull the IP Deskphone away from the stand, as shown in [Figure 13 on page 59](#).
2. Use the stand cover (the part you removed in "[Removing the stand cover](#)" on page 53), to mark the wall-mount holes by pressing the bottom of the stand cover firmly against the wall in the location where you wish to install the IP Deskphone. Four small pins on the bottom of the stand cover make marks on the wall.
3. Use the marks as a guideline for installing the wall-mount screws (not provided). Install the screws so that they protrude 3 millimeters (mm) (1/8 inch) from the wall.
4. Install the IP Deskphone stand mounting holes over the screw heads as indicated in [Figure 12 on page 58](#) (Method A). You need to remove the IP Deskphone from the wall to adjust the lower screws.
5. When the lower screws are snug, install the IP Deskphone on the mounting screws, and then tighten the top screws.

Figure 13: Rotate the IP Deskphone into the wall mount position

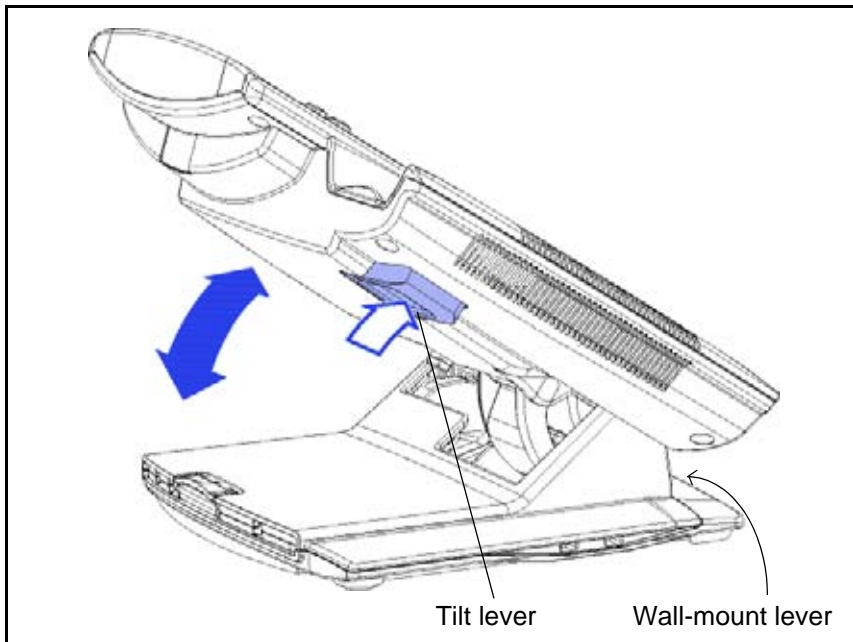

Method B:

1. Attach the 15-cm (6-inch) CAT5e cable.
2. Position the stand over the mounting rivets, and slide the IP Deskphone down the wall so that the rivets fit into the slots on the stand, indicated in [Figure 12 on page 58](#) (Method B).
3. Replace the stand cover. Ensure that all cables are neatly routed and press the stand cover into place until you hear a click.
4. Put the IP Deskphone in the wall-mount position (optional). If you wall-mount your IP Deskphone, put it in the wall-mount position by holding the Tilt Lever and pressing the IP Deskphone towards the base until the IP Deskphone is parallel with the base. Release the Tilt Lever and continue to push the IP Deskphone towards the base until you hear an audible click. Ensure the IP Deskphone is securely locked in position.

Attention: To add an Expansion Module for Avaya 1100 Series IP Deskphones see *Expansion Module for Avaya 1100 Series IP Deskphones (SIP Software) User Guide* (NN43110-301).

Entering text

You can use combinations of the letters and numbers on the dialpad of your IP Deskphone to, for example, spell names or words in Instant Messages (IMs), enter SIP addresses, create Address Book entries, and to designate feature key labels.

To make a call, you can dial an alphanumeric SIP address; for example, `jdoe2@domain.com`. You can enter and edit text on your IP Deskphone using the following methods:

Attention: Some service providers support only the use of a Directory Number (DN) such as 555-5555 to initiate a call to another IP Deskphone. Contact your system administrator or service provider to determine if alphanumeric dialing is supported. Alphanumeric dialing consists of a string of text that contains letters and numbers that make up, for example, a SIP address.

You can use the following methods to enter and edit text on your Avaya 1120E IP Deskphone:

- “Entering text using the IP Deskphone dialpad” on page 61
- “Entering text using the USB keyboard” on page 66

Entering text using the IP Deskphone dialpad

For applications that offer text input, when you use the dialpad to enter text the system activates the **abc/123** context-sensitive soft key.

You can toggle between numeric and alphabetic input as follows:

- When the context-sensitive soft key label is **abc**, you can enter alphabetic text.
- When the context-sensitive soft key label is **123**, you can enter numbers.

Figure 14: context-sensitive soft key abc/123

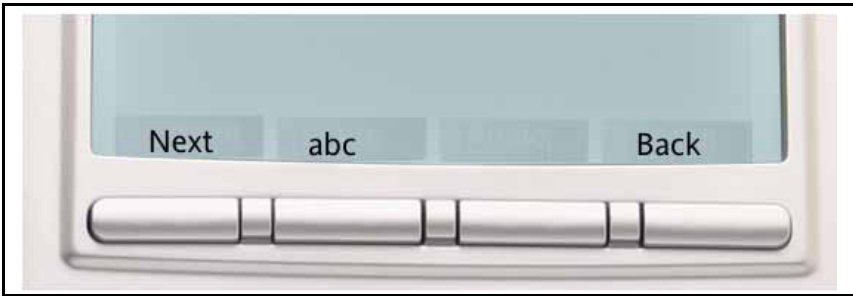

For example, if you want to enter the lower case letter a, press the **abc/123** context-sensitive soft key to toggle to alphabetic input. Then press the number **2** key once. If you want to enter the upper case letter C, press the number **2** key six times. You can cycle through the letters (and the numeral) by pressing the number button repeatedly.

To create names or words that contain two adjacent letters that appear on the same button, for example, the word *press*, you can do the following:

1. To enter the first character, press the dialpad key **6**.
2. Pause briefly.

- To enter the next letter, press the dialpad key 6 twice to cycle to the letter r.

When entering alphanumeric information, the **1** key on the dialpad represents the characters in [Table 7 on page 62](#). To enter a special character, press the dialpad number **1** to cycle through the characters until you reach the one you need. For example, to enter a question mark (?), press the number **1** key eight times.

Table 7: Alphanumeric characters for dialpad key 1 (Part 1 of 2)

Character	Name
@	at
.	period
-	dash
_	underscore
&	ampersand
'	apostrophe
^	carat
?	question mark
!	exclamation point
(left parentheses
)	right parentheses
,	comma
\	backslash
/	forward slash
:	colon

Table 7: Alphanumeric characters for dialpad key 1 (Part 2 of 2)

Character	Name
;	semi-colon
~	tilde
=	equal
+	plus
1	numeral 1

Note: No letters are associated with the 0 key.

Enabling and disabling the # Ends Dialing feature

You can enable the IP Deskphone to use the octothorpe (#) symbol to immediately dial the address or phone number.

To enable the # Ends Dialing feature:

Prefs



1. Press the **Prefs** context-sensitive soft key, and then select **Misc Options**. Highlight **# Ends Dialing** and press the **Change** context-sensitive soft key.

2. Choose one of the following:

On



or

Back

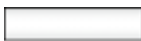

- Press the **On** context-sensitive soft key to turn on **# Ends Dialing**.
- Press the **Back** context-sensitive soft key to keep existing configurations and return to the **Preferences** menu.

To disable the # Ends Dialing feature:

Prefs

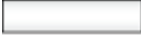

1. To turn off # Ends Dialing, press the **Prefs** context-sensitive soft key, and then select **Misc Options**. Highlight **# Ends Dialing** and press the **Change** context-sensitive soft key.

Off



or

Back



2. Choose one of the following:
 - Press the **Off** context-sensitive soft key to turn off **# Ends Dialing**.
 - Press the **Back** context-sensitive soft key to keep existing configurations and return to the **Preferences** menu.

Configuring the dialpad to alphanumeric dialing

To eliminate the need to press the **abc/123** context-sensitive soft key when you enter text, you can configure the Avaya 1120E IP Deskphone dialpad default to alphabetic mode.

To configure the dialpad to alphabetic mode as the default:

Prefs



1. Press the **Prefs** context-sensitive soft key, and then select **Misc Options**. Highlight **Alpha Dialing**, and then press the **Change** context-sensitive soft key.

2. Choose one of the following:

On



or

Back



- Press the **On** context-sensitive soft key to turn on alphanumeric dialing.
- Press the **Back** context-sensitive soft key to keep existing configurations and return to the **Preferences** menu.

To disable alphabetic mode and configure numeric mode as the default:

Prefs



1. Press the **Prefs** context-sensitive soft key, and then select **Misc Options**. Highlight **Alpha Dialing**, and then press the **Change** context-sensitive soft key.

2. Choose one of the following:

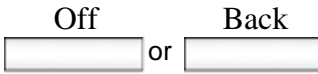

- Press the **Off** context-sensitive soft key to turn on alphanumeric dialing.
- Press the **Back** context-sensitive soft key to keep existing configurations and return to the **Preferences** menu.

Entering text using the USB keyboard

You can connect a USB keyboard to the USB port of your IP Deskphone to enter text and numbers, access some features, and duplicate some functions.

For example, to dial a directory number, you can use the keyboard number pad to enter digits and the asterisk (*) and octothorpe (#) characters and you can use the alphabetic keys to enter text.

[Table 8 on page 66](#) describes the associations between the USB keyboard function keys and the IP Deskphone fixed keys.

Table 8: USB keyboard functions (Part 1 of 2)

USB Keyboard Key	IP Deskphone Fixed Key
Esc	Quit
F1	Services
F2	Expand
F3	Inbox
F4	Outbox
F5	Address Book
F6	Copy
F7	Volume Down

Table 8: USB keyboard functions (Part 2 of 2)

USB Keyboard Key	IP Deskphone Fixed Key
F8	Volume Up
F9	Mute
F10	Hold
F11	Headset
F12	Handsfree
Break	Goodbye (Release)
Backspace	Left arrow of Navigation Cluster
Arrow Left	Left arrow of Navigation Cluster
Arrow Right	Right arrow of Navigation Cluster
Arrow Up	Up arrow of Navigation Cluster
Arrow Down	Down arrow of Navigation Cluster
Enter	Enter

Accessing the Avaya 1120E IP Deskphone

You require a log on ID and a password to log on to a server with your Avaya 1120E IP Deskphone.

Logging on

Whenever you log on to your Avaya 1120E IP Deskphone you must do the following:

- confirm your logon ID
- enter your password
- select the duration of this session

Release 2.2 supports admin password protection for login prompt that appears when you power up the IP Deskphone or after you log off.

[Figure 15 on page 68](#) shows the User Password protection for domains.

Figure 15: User login screen



When you log on to your Avaya 1120E IP Deskphone you must confirm your logon ID, enter your password, and select the duration of this

session. However, the first time you use your IP Deskphone, you need to complete some of the following procedures:

- [“Automatic login” on page 69](#)
- [“Configuring the domain” on page 69](#)
- [“Selecting a language” on page 71](#)
- [“Logging on to your Avaya 1120E IP Deskphone” on page 72](#)
- [“Configuring the duration of the login” on page 76](#)
- [“Selecting a location” on page 78](#)
- [“User Profile” on page 80](#)
- [“Overwriting your personal Address Book” on page 81](#)

Note: The system automatically logs you back on after a power outage or software upgrade. The system administrator configures this feature on a network-wide basis.

Automatic login

Before you first receive your Avaya 1120E IP Deskphone, your system administrator can configure your IP Deskphone with your user logon and password. If this is the case, after you plug in the IP Deskphone you can use it without further configuration.

Note: If the IP Deskphone is configured with automatic logon, you can not use the log off function, and you need a password to access some features and functions. Contact your system administrator or service provider for further information.

Configuring the domain

Before the log on process, if you need to change the domain or confirm that the domain you log on to is correct, press the **Domain** context-sensitive soft key from the logon prompt. The current domain appears on the IP Deskphone LCD screen. You can edit the domain that is listed or press the **Domain** context-sensitive soft key to access a list of available domains to which you can choose to connect.

Note 1: You must enter the admin password to edit domains.

Note 2: Check with your system administrator before editing or changing domains.

To change the domain:

Domain



1. Press the Domain context-sensitive soft key to change the current domain.

— Press the **Domain** context-sensitive soft key to change the current domain.

Note: You must enter an admin password before you can edit the domain in which the IP Deskphone connects.



2. Press the **Up/Down** navigation key to highlight the new domain you want to use.

Select



3. Choose one of the following:

— Press the **Select** context-sensitive soft key to change the domain to the highlighted domain from the list. The IP Deskphone returns to the **Current Domain** page, and the new domain appears.

Back



— Press the **Back** context-sensitive soft key to keep existing configurations and return to the previous menu.

Password protection for domains

This feature supports admin password protection for editing of the domain and is not required for switching domains. If you log on using the administrator password, you can use the editing domain option for both the Current Domain state and Domain List state.

After you press **back** on the edit page or on the password prompt, the idle display appears. You must enter the admin password to reenter the editing domain.

Password check to switch domains

When no one is logged on, a domain soft key appears. When you press the domain soft key, the current domain page appears without a password query.

Password protection for editing domain

When you press **Edit** for a domain, the admin password prompt appears. The editing domain page appears after you enter the correct admin password. If you do not enter the correct password, the message "incorrect password" appears with a prompt to retry.

Password request in server settings mode

When you edit the domain from the server settings under the Network menu, you are prompted to enter the admin password. After you enter the password, the Domain page appears. When you press the **Edit** context-sensitive soft key, there is no prompt for the admin password because you have already entered the admin password to load the Server Settings menu.

Selecting a language

Your IP Deskphone has the capacity to operate using other languages, such as French. The system administrator can provision the IP Deskphone with up to five languages. If the IP Deskphone is provisioned with other languages, you can choose an available language during the login process by pressing the **Lang** context-sensitive soft key on the **User Login** page.

To change the language:

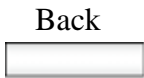

1. Choose one of the following:
 - Press the **Change** context-sensitive soft key to change the current language.
 - Press the **Back** context-sensitive soft key to keep existing language and return to the **User Login** screen.
2. Press the **Up/Down** navigation key to highlight the new language you want to use.
3. Choose one of the following:
 - Press the **Select** context-sensitive soft key to change the language to the highlighted language from the list. The IP Deskphone returns to the **User Login** screen and uses the selected language.
 - Press the **Back** context-sensitive soft key to keep the existing language and return to the **User Login** screen.

Logging on to your Avaya 1120E IP Deskphone

You need to log on to your Avaya 1120E IP Deskphone when you first install and restart your IP Deskphone and anytime you log off or reboot.

Note 1: When you log on to the IP Deskphone for the first time, the system prompts you for a location. For more information, see [“Selecting a location” on page 78](#).

Note 2: The IP Deskphone retains the previous user logon ID, which appears after the ID prompt whenever the IP Deskphone reboots.

If Authentication is enabled by your system administration, you can enter your authentication ID independent of your user ID. The authentication ID is used when the server challenges the IP Deskphone.

To logon to the IP Deskphone:



1. Press the **abc/123** context-sensitive soft key to toggle between alphabetic or numeric input.



2. Use the dialpad to enter your user ID login at the prompt.

Note: Use the left navigation key to backspace and remove a previous user ID.

Login

abc



Login

Login

3. Press the **Login** context-sensitive soft key.

If Authentication is enabled by your system administration, you are presented with the Authentication ID screen. The authentication ID is autofilled with your user ID.

If Authentication is not enabled, a new screen appears and prompts you for your password.

- a. Press the **abc/123** context-sensitive soft key to toggle between alphanumeric or numeric input.
- b. Use the dialpad to enter your authentication ID login at the prompt.
- c. Press the **Login** context-sensitive soft key.

A new screen appears and prompts you for your user password.



4. Enter your password by using the dialpad.

Note 1: When you enter your password, the last character entered appears. However, all previous characters are hidden.

Note 2: When you enter your password and you use the navigation key to backspace, you erase all the characters and must completely reenter your password again.

Next



Cancel



5. Press the **Next** context-sensitive soft key.

Note: You can cancel the login process by pressing one of the following keys:

- Cancel
- Goodbye
- Quit



Configuring the duration of the login

After you enter your logon ID and password the **Duration** screen appears. You can enter the maximum length of time of the session. If you choose to use the default duration Permanent, you remain logged on to the phone until you log off.

To configure the login duration:

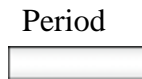

1. Choose one of the following:
 - Press the **Next** context-sensitive soft key to configure the logon duration to Permanent. A login confirmation screen appears.
 - Press the **Timed** context-sensitive soft key to open a screen to configure a maximum time to remain logged in.

Note: If you press the **Timed** context-sensitive soft key, you must then configure the duration of the login.

2. Press the **Period** context-sensitive soft key to toggle the logon duration entries between hours or days.
3. Do one of the following:
 - Use the dialpad to enter the number of hours or days you want to remain logged on and press the **Next** context-sensitive soft key.

Back



- Press the **Back** context-sensitive soft key to return to the permanent logon screen.

Cancel



- Press the **Cancel** context-sensitive soft key to return to the first logon screen.

Logging on multiple user accounts

The Avaya 1120E IP Deskphone has a multiuser feature that allows multiple SIP user accounts to be active on the IP Deskphone at the same time. For more information about logging on multiple users, see [“Multiuser” on page 264](#).

Timed logoff

When you determine a logon time other than permanent, the IP Deskphone reminds you of your expiry time.

Timed logoff while IP Deskphone is idle

When the login time expires and the IP Deskphone is idle (not on a call), you can do one of the following at the prompt:

- Press the **Yes** context-sensitive soft key to log off immediately.
- Press the **No** context-sensitive soft key to switch to Permanent logon.
- Press the **Quit** or **Release/Goodbye** key to logout immediately.

If you do not respond, the prompt times out in 45 seconds and the IP Deskphone logs off.

If you answer a call during the logout prompt, the logon switches to permanent login.

Timed logoff while on a call

When the login time expires while you are on a call, you can do one of the following at the prompt:

- Press the **Yes** context-sensitive soft key to log off immediately.
- Press the **No** context-sensitive soft key to switch to Permanent logon.
- Press the **Quit** key to dismiss the log out prompt and switch to permanent login.
- Press the **Release/Goodbye** key to dismiss the logout prompt and switch to permanent login.

Note: If you press the **Release/Goodbye** key to dismiss the logout prompt, you also terminate the call.

If you do not respond, the prompt times out in 45 seconds and the IP Deskphone switches to permanent login.

Selecting a location

When you first login to the IP Deskphone, the system prompts you for a location. The location you select is saved in your User Profile.

Depending on your service provider, the Enhanced Emergency Service uses the location you select or the Directory Number (DN) on the call server, when handling emergency calls. The configuration of the call server determines how emergency service calls are handled by your IP Deskphone.

Note 1: During an emergency call, you cannot log out from the IP Deskphone or release or disconnect the call. The IP Deskphone remains connected to the emergency service until the emergency service operator disconnects it.

Note 2: If the login time expires during an emergency call, a prompt does not appear and the IP Deskphone automatically switches to permanent login.

Note 3: When you configure your user profile for the first time, you must confirm that the selected location is correct. You can view your location by accessing the IP Deskphone information screen. For more

information, see [“Viewing the IP Deskphone information” on page 284.](#))

User Profile

Your User Profile contains your specific settings and data. You are prompted to create a User Profile the first time you log on to your IP Deskphone. If you delete your User Profile, the IP Deskphone reboots, and you must log on and create a new User Profile. When you log on to your IP Deskphone, your specific settings and data are automatically available for you.

The information stored in your user profile includes:

- Independent volume adjustments for handset, headset, and handsfree
- Alerting Volume adjustment
- Idle Screen display text
- Display Contrast and Backlight Screen Saver settings
- Voice Mail settings (number and mailbox ID)
- User location (from a server-provided list)
- Time, Date, and Zone format settings
- Call Subjects
- Call Decline reasons
- Instant Messaging settings and Instant Message Inbox/Outbox
- Default dialing (alpha/numeric)
- Call Ignore action (local/network)
- Search method (Name, First character, Index)
- User Presence selection
- Dialing pattern default (alpha/numeric)
- Address Book entries
- Call Inbox and Call Outbox entries
- Programmable keys configuration
- # Ends dialing configuration

Overwriting your personal Address Book

When an address book exists on a call server, such as an address book for a specific company, you can update your personal Address Book with an address book from the call server. The system administrator configures the system to enable this feature. If a new address book is available on the call server, the IP Deskphone prompts you to download the latest address book.

Confirmation logon screen

When you complete the logon process, the logon confirmation screen appears as shown in [Figure 16 on page 81](#). Press the **OK** context-sensitive soft key to complete the logon process.

If the login is unsuccessful, a login error message `Failed to login user, Authentication required` appears. Press the **OK** context-sensitive soft key to return to the first logon screen. The most common cause for logon failure is the incorrect entry of your password.

Note: In case of login failures, the IP Deskphone displays the message “Failed to login user” and then automatically returns to the login screen.

Figure 16: Logon confirmation screen



Logging off from the IP Deskphone

To log off from the IP Deskphone:



1. Press the **Services** fixed key, and then select **Logout** from the menu.

abc



2. Press the **abc/123** context-sensitive soft key to toggle between alphabetic or numeric input.



3. Use the dialpad to enter your password at the prompt.

Logout



or

Back



4. Choose one of the following:
 - Press the **Logout** context-sensitive soft key to complete the logout process. The IP Deskphone returns to the **User Login** screen.
 - Press the **Back** context-sensitive soft key to remain logged on and return to the **Services** menu.

Logging off multiple user accounts

The Avaya 1120E IP Deskphone has a multiuser feature that allows multiple SIP user accounts to be active on the IP Deskphone at the same time. By logging off of the primary account, all other accounts log off automatically. By logging off of a secondary account, you remove the selected secondary account from the autologin list. For more information about logging off when the IP Deskphone has multiple users, see [“Logging out” on page 267](#).

Making an emergency call

You can use the Avaya 1120E IP Deskphone to make an emergency call to the Public Safety Answering Point (PSAP) from any accessible screen without logging on.

When you pick up the handset, press the handsfree button or headset button without logging on, a message **"Emergency calls only"** appears, and the Avaya 1120E IP Deskphone can only be used to make an emergency call. All context-sensitive soft keys and feature keys are blank and unusable except for the second context-sensitive soft key which allows you to switch between numeric and alphabetic characters. If you hang up before the connection is established, the Avaya 1120E IP Deskphone returns to the initial state. After the connection is established, the call can be disconnected only by an operator. If you hang up after the connection has been made, the IP Deskphone switches to loudspeaker. If the loudspeaker is already on, and you press the hang up button, nothing happens. The call is not disconnected.

When you make an emergency call, the location of the IP Deskphone is forwarded to the PSAP.

Note: When the IP Deskphone is waiting for the user to log on or it is blocked by a screen saver, you can still make an emergency call. If you pick up the handset, a message "Emergency calls only" appears and the IP Deskphone can be used for making only emergency calls.

To make an emergency call:



1. Choose one of the following:
 - Pick up the handset.
 - Press the handsfree button.
 - Press the headset button.

Note: Hang up or switch off the handset to return to normal state.

2. Dial the emergency number that is provided by your dialing plan.
3. Press the **Send** context-sensitive soft key.
4. If you try to dial the number that does not match the dialing plan, a message appears to inform you that the number is incorrect.

Send



Location information

When you make an emergency call, the IP Deskphone provides the PSAP with the location information of the IP Deskphone. The IP Deskphone receives the location information when the IP Deskphone is first plugged in to the network and then stores it.

To view your location, press the **Services** hard key, choose Phone Information, and then press the **E911** context-sensitive soft key.

[Figure 17 on page 84](#) displays the Phone Information menu.

Figure 17: Phone information menu

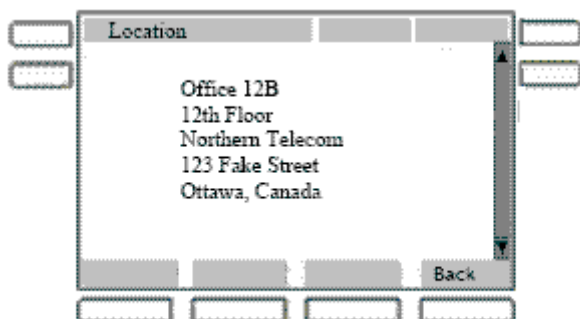

[Figure 18 on page 85](#) displays the location information.

Figure 18: Phone location display

You can obtain location information only if it has been configured on your system.

Configuring the Avaya 1120E IP Deskphone

You can adjust a few settings of the Avaya 1120E IP Deskphone to conform to the environment where you want to use the phone. These settings are saved to your User Profile. This chapter describes some of the settings that you can customize on your IP Deskphone.

- “Adjusting the display screen contrast” on page 86
- “Creating the idle screen text display” on page 87
- “Configuring the Backlight Screensaver” on page 88
- “Configuring Menu Auto back-out” on page 89
- “Selecting a ring pattern” on page 91
- “Adjusting the volume” on page 92
- “Selecting a language” on page 97
- “Selecting the date and time format” on page 98
- “USB headset” on page 101

Adjusting the display screen contrast

Note: Adjusting the display screen contrast of the IP Deskphone also adjusts the Expansion Module contrast, if you have an Expansion Module connected to your Avaya 1120E IP Deskphone.

To adjust the display screen contrast:



1. Press the **Prefs** context-sensitive soft key, select **Display, Display Settings** and then select **Contrast**.



2. Press the **Left/Right** navigation key to increase or decrease the display contrast level.

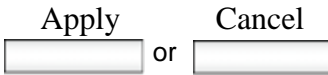

3. Choose one of the following:
 - Press the **Set** context-sensitive soft key to save the changes and return to the **Display** menu.
 - Press the **Back** context-sensitive soft key to keep the existing configurations and return to the **Display** menu.

Creating the idle screen text display

You can create a text to display on the screen, while the IP Deskphone is idle.

To create the idle screen display text:



1. Press the **Prefs** context-sensitive soft key, select **Display**, and select **Idle Screen Text Display**.

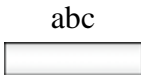

2. Press the **abc/123** context-sensitive soft key to toggle between alphabetic or numeric input.



3. Use the dialpad to enter the display text you want to appear on the idle screen display of the IP Deskphone.

4. Choose one of the following:

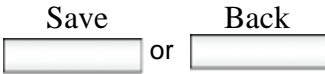

- Press the **Save** context-sensitive soft key to save the idle screen text display.
- Press the **Back** context-sensitive soft key to keep the existing screen display text and return to the **Display** menu.

Configuring the Backlight Screensaver

To configure the amount of time the LCD screen remains backlit:



1. Press the **Prefs** context-sensitive soft key, select **Display**, **Display Settings** and then select **Backlight Screensaver** from the menu.



2. Press the **Left/Right** navigation key to increase or decrease the length of time you want the idle screen to remain backlit.

3. Choose one of the following:

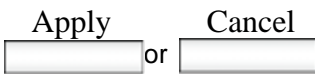

- Press the **Select** context-sensitive soft key to configure the length of time for the IP Deskphone to remain backlit and return to the **Display** menu.
- Press the **Back** context-sensitive soft key to keep the existing configurations and return to the **Display** menu.

Configuring Menu Auto back-out

You can use the Menu Auto back-out feature to configure the time interval required for the IP Deskphone to go back to the idle screen when the IP Deskphone is left inactive.

To configure Menu Auto back-out:

Prefs



1. Press the **Prefs** context-sensitive soft key, choose **Display**, and then **Menu Auto back-out**.

2. Choose one of the following:
 - Press the **Select** context-sensitive soft key.
 - Press the **Back** context-sensitive soft key to return to the previous menu.

Select



or

Back





3. Press the **Up/Down** navigation key to scroll through the screen and choose the required time interval.

Choose one of the following values:

- Never
- 10 min
- 5 min
- 2 min
- 1 min
- 30 sec
- 15 sec

Note: The Never option turns off Menu Auto back-out.

4. Choose one of the following:

Select or Back

- Press the **Select** context-sensitive soft key to configure the Auto back-out time to the selected (highlighted) value and return to the Display menu.
- Press the **Back** context-sensitive soft key to dismiss the Auto back-out time menu and return to the Display menu.

Note: When you enter the Auto back-out menu, the current configuration for the Menu Auto back-out time is pre-selected (highlighted) on the list.

When you press the **Select** context-sensitive soft key, the time interval is flagged to commit to the configured preferences (done after the idle screen is displayed), and is used for menu auto back-outs from that point forward.

Selecting a ring pattern

You can use the ring pattern feature to select the ring pattern for an incoming call.

To select the ring pattern for an incoming call:

Prefs



1. Press the **Prefs** context-sensitive soft key, select **Audio**, select **Tones**, and then select **Ring Pattern**.



2. Press the **Up/Down** navigation key to scroll through and highlight the different ring patterns displayed on the LCD screen.

Select



3. Choose one of the following:

- Press the **Select** context-sensitive soft key to configure the ring pattern and return to the Tones menu.
- Press the **Test** context-sensitive soft key to briefly play the selected ring pattern.
- Press the **Back** context-sensitive soft key to keep the existing configurations and return to the previous menu.

Test



Back



Adjusting the volume

You can adjust the volume of the IP Deskphone for the following:

- Ring Volume
- Handset Volume
- Headset Volume
- Handsfree Volume

A sliding scale appears on the LCD screen display when you adjust the volume. [Figure 19 on page 92](#) shows how to adjust the volume.

Figure 19: Adjusting the volume



Adjusting the ring volume

You can adjust the ring volume for an incoming call.

To adjust the ring volume for an incoming call:



1. Press the **Prefs** context-sensitive soft key, select **Audio**, select **Tones**, and then select **Alerting Volume**.



2. To adjust the ring volume of an incoming call do one of the following:
 - Press the **Left/Right** navigation key.
 - Press the **Volume** fixed keys to increase or decrease the volume.

Set



or

Back



3. Choose one of the following:
 - Press the **Set** context-sensitive soft key to configure the selected volume and return to the **Tones** menu.
 - Press the **Back** context-sensitive soft key to keep the existing configurations and return to the **Tones** menu.

Adjusting the volume of the Handset, Headset, and Handsfree mode

You can adjust the volume for the handset, headset, and the handsfree speaker of the IP Deskphone.

To adjust the volume of the handset:

Prefs



1. Press the **Prefs** context-sensitive soft key, select **Audio**, select **Voice**, and then select **Handset**.

2. To adjust the handset volume use one of the following methods:

- Press the **Left/Right** navigation key to increase or decrease the volume of the handset.
- Press the **Volume +** fixed key to increase the handset volume or press the **Volume -** fixed key to decrease the handset volume.



Note: To adjust the volume during a call, use only the **Volume +** and **Volume -** fixed keys.

3. Choose one of the following:

- Press the **Set** context-sensitive soft key to configure the selected volume and return to the **Voice** menu.
- Press the **Back** context-sensitive soft key to keep existing configurations and return to the **Voice** menu.

Set



or

Back



You can adjust the headset volume on the IP Deskphone.

To adjust the headset volume:

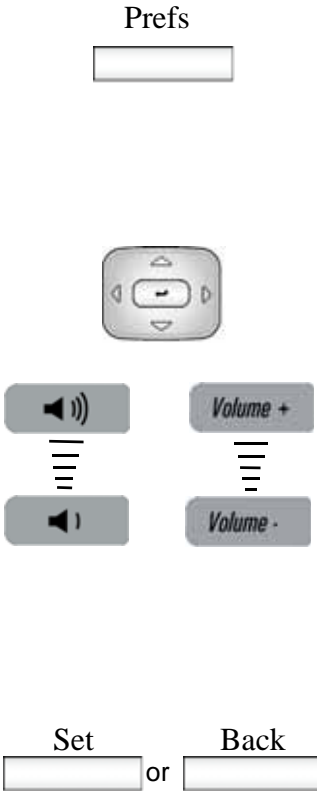

1. Press the **Prefs** context-sensitive soft key, select **Audio**, select **Voice**, and then select **Headset**.
2. To adjust the handset volume use one of the following methods:

- Press the **Left/Right** navigation key to increase or decrease the volume of the handset.
- Press the **Volume +** fixed key to increase the handset volume or press the **Volume -** fixed key to decrease the handset volume.

Note: To adjust the volume during a call, use only the **Volume +** and **Volume -** fixed keys.

3. Choose one of the following:
 - Press the **Set** context-sensitive soft key to set the selected volume and return to the **Voice** menu.
 - Press the **Back** context-sensitive soft key to keep the existing configurations and return to the **Voice** menu.

You can adjust the handsfree mode volume on the IP Deskphone.

To adjust the handsfree mode volume:

Prefs



1. Press the **Prefs** context-sensitive soft key, select **Audio**, select **Voice**, and then select **Handsfree**.

2. To adjust the handsfree volume use one of the following methods:

- Press the **Left/Right** navigation key to increase or decrease the volume of the handset.
- Press the **Volume +** fixed key to increase the handset volume or press the **Volume -** fixed key to decrease the handset volume.



Note: To adjust the volume during a call, use only the **Volume +** and **Volume -** fixed keys.

3. Choose one of the following:

- Press the **Set** context-sensitive soft key to configure the selected volume and return to the **Voice** menu.
- Press the **Back** context-sensitive soft key to keep the existing configurations and return to the **Voice** menu.

Set



or

Back



Selecting a language

The display is available in multiple languages. A maximum of five languages are accessible through the IP Deskphone. The system administrator determines which languages are available for your IP Deskphone.

To select a language:

Prefs



1. Press the **Prefs** context-sensitive soft key, and then select **Language**. The current language displays.

Change



2. Press the **Change** context-sensitive soft key to change the language.



3. Press the **Up/Down** navigation key to scroll and highlight the desired language (for example, German [Deutsche]).

Select



or

Back



4. Choose one of the following:
 - Press the **Select** context-sensitive soft key to save the desired language and return to the previous screen.
 - Press the **Back** context-sensitive soft key to keep the existing configurations and return to the **Preferences** menu.

Selecting the date and time format

Several date and time formats are available. Formats are based on the 12-hour and 24-hour clocks.

To select a date format:

Prefs



1. Press the **Prefs** context-sensitive soft key, select **Misc Options**, and then select **Time**.

Change



2. Press the **Change** context-sensitive soft key.



3. Press the **Up/Down** navigation key to highlight **Date Format** in the menu.

Change



4. Press the **Change** context-sensitive soft key to change the Date Format.



5. Press the **Up/Down** navigation key to scroll and highlight either a month/day (MM/DD) or a day/month (DD/MM) format.

6. Choose one of the following:

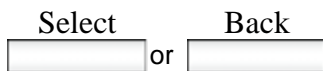

- Press the **Select** context-sensitive soft key to save the format and return to the Time Format menu.
- Press the **Back** context-sensitive soft key to keep the existing configurations and return to the **Time Format** menu.

You can select a time zone for your IP Deskphone.

To select a time zone:



1. Press the **Prefs** context-sensitive soft key, select **Misc Options**, and then select **Time**.



2. Press the **Change** context-sensitive soft key.



3. Press the **Up/Down** navigation key to highlight **Timezone** in the menu.
4. Press the **Change** context-sensitive soft key to change the Date Format.



5. Press the **Up/Down** navigation key to scroll through and highlight the time zones.

Note: Time zones are listed based on GMT format, for example:

- GMT -11:00 Samoa
- GMT -10:00 Hawaii

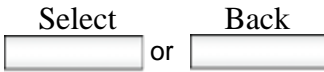

6. Choose one of the following:
 - Press the **Select** context-sensitive soft key to save the time zone selection and return to the Time Format menu.
 - Press the **Back** context-sensitive soft key to keep the existing configurations and return to the **Time Format** menu.

You can select the time zone format for your IP Deskphone.

To select a time format:



1. Press the **Prefs** context-sensitive soft key, select **Misc Options**, and then select **Time**.

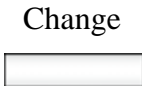

2. Press the **Change** context-sensitive soft key.



Change



Select or Back
 or

3. Press the **Up/Down** navigation key to highlight **Time Format** in the menu.
4. Press the **Change** context-sensitive soft key change the date format.
5. Press the **Up/Down** navigation key to scroll and highlight a time format:
 - 12-hour
 - 24-hour
 - French
6. Choose one of the following:
 - Press the **Select** context-sensitive soft key to save the time format and return to the **Time Format** menu.
 - Press the **Back** context-sensitive soft key to keep the existing configurations and return to the **Time Format** menu.

USB headset

You can attach only one USB headset to the Avaya 1120E IP Deskphone. (If you add an additional USB headset, the IP Deskphone ignores it without any message.) When you connect the USB headset to the USB port of the IP Deskphone, the IP Deskphone configures the headset to work with it.

[Table 9 on page 102](#) lists the types of USB headsets that work with the Avaya 1120E IP Deskphone.

Table 9: Supported USB headset types

Headset type	Frequency
Avaya Enhanced USB Headset Adapter	8 KHz
Avaya Mobile USB Headset Adapter	8 KHz
Plantronic CS50/CS60 Wireless USB Headsets	8-48 KHz Continuous Spectrum
GN Netcom 9300 series wired and wireless USB headsets	16 KHz
Algo Analog Terminal Adapter	8 KHz

Headset menu

The USB Audio feature adds the USB headset as an alternative headset in addition to the wired headset. You can add a headset to your preferences by clicking on the **Prefs** context-sensitive soft key, and then choosing **Audio**. The Audio option allows you to select and configure the preferred headset. [Figure 20 on page 103](#) displays the Audio menu with the **Headset Selection** menu item.

Figure 20: Preferences menu with Headset menu item



On the IP Deskphone, after you select the **Prefs**, **Audio**, and **Headset Selection** menu items, use the Headset screen to select the desired headset and corresponding functional parameters. [Figure 21 on page 103](#) displays the Headset screen.

Figure 21: Headset screen

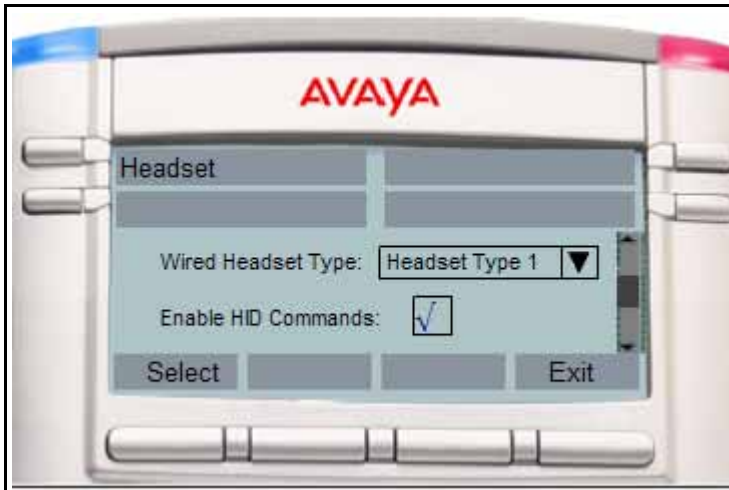

Table 10 on page 104 describes the configuration options on the Headset screen.

Table 10: Configuration options on the Headset screen (Part 1 of 3)

Option	Function
Active Headset Device	<p>Select the active headset device; either USB or Wired.</p> <p>Note: The headset can be selected before it is attached (wired or USB).</p> <p>Items below the Active Headset Device field are dimmed, if either USB headset is not selected or if the attached headset is not one of the Human Interface Device (HID) supported headset types.</p>
Wired Headset Type	<p>Select the type of wired headset you required.</p> <ul style="list-style-type: none"> • Headset Type 1 (Generic narrow band) • Headset Type 2 (Wideband) • Headset Type 3 (Wideband)

**Table 10: Configuration options on the Headset screen
(Part 2 of 3)**

Option	Function
Enable HID Commands	<p>Enable HID Commands only if USB headset is selected.</p> <p>The checkbox is used to enable the HID commands of supported headsets to allow the IP Deskphone to run in generic mode 1 operation, supporting both USB audio and HID commands. The configuration is ignored for non-supported USB headsets.</p>
MHS Headset Type	<p>Choose an MHS Headset Type only if Avaya headset adapter is detected.</p> <p>This list contains the different wired headset types that can be attached to the Avaya Enhanced or Mobile Adapters for loss plan adjustment. The command is ignored for other types of USB headsets. This item is dimmed if the attached headset is not one of the Avaya headset types.</p>

Table 10: Configuration options on the Headset screen (Part 3 of 3)

Option	Function
MHA Back Light	<p>Enable the MHA Back Light (only if Avaya headset adapter is detected).</p> <p>The checkbox is used to enable or disable the back light equipped in Avaya Enhanced or Mobile headsets. The command is ignored for other types of USB headsets. This item is dimmed if the attached headset is not one of the Avaya headset types.</p>

The changes in the menu take effect immediately if the device is attached. The active voice path switches to the selected headset if you are on an active call. If you press the **Apply** context-sensitive soft key, then the changes are applied, the settings are made permanent by storing the values in persistent storage, and they are applied every time the IP Deskphone starts up. However, all changes made are ignored and restored if you press the **Back** context-sensitive soft key.

Presence of USB headset

On the **System** menu, choose **Phone Information**, and then select **USB** to verify the presence of the USB headset attached to the IP Deskphone. When you select the **USB** menu, the attached USB headset is displayed along with other USB devices. The name of the USB device directly appears from the USB devices themselves. The product description has no explicit USB headset indications for the attached USB headset. The following figure displays the headset setting screen.

Figure 22: Presence of USB Headset screen

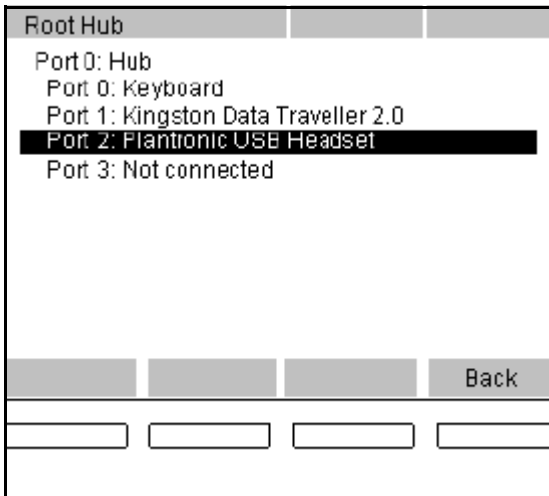

Audio format selection

After the IP Deskphone receives the endpoint configurations, it searches the records to select an audio format that matches the IP Deskphone requirements. If no match is found, then the default audio format is used. After you select the format, the IP Deskphone sends a command to the device to select the corresponding endpoints for audio transfers.

The IP Deskphone supports both 8KHz and 16KHz audio. You can select the 16KHz audio, if the headset supports it. The IP Deskphone is a mono device with only one voice channel. For stereo USB headsets detected, the IP Deskphone replicates one channel voice data to both left and right channels of the headsets to simulate stereo output. The following table lists the audio format requirements supported by the IP Deskphone.

Table 11: Supported USB audio formats

Audio Parameters	Values
Audio Format	PCM only
Subframe size	2
Bit Resolution	16 bits

Audio Parameters	Values
Frequency Type	Continuous (0) or Discrete (> 0)
Sample Frequency	If Continuous, default to 16 KHz. If Discrete, 8 KHz, 16KHz or 8KHz multiple. Preference is given to 16KHz audio, if supported
Audio Channel	Mono (1) or Stereo (2)

After you select the format and the Set Interface command is sent, the USB headset runs in Generic Mode 1 operation (both audio and HID) or Mode 2 operation (audio only). If the headset runs in Mode 1 operation, the IP Deskphone configures the task or callback to communicate with the USB HID control events between the IP Deskphone and the headset. You can insert the headset during an active call. The IP Deskphone synchronizes the headset state machine of the IP Deskphone to the current state of the headset to ensure the LED match status.

During the call, if the audio negotiated between the two parties is set to 8KHz audio and the IP Deskphone is setup for 16KHz USB Headset audio, the IP Deskphone performs the transcoding between 8KHz audio to 16KHz audio. Likewise, if the audio negotiated between the two parties is set to 16KHz audio and the headset supports only 8KHz audio, the IP Deskphone performs the transcoding between 16KHz audio to 8KHz audio.

Generic USB headset

When a generic USB headset (or supported headset with HID command disabled) is attached to the IP Deskphone and selected, it behaves like a wired headset. All call controls, on hook, off hook, mute, volume up, and volume down are performed using the keys on the IP Deskphone. The IP Deskphone does not use the User interface elements on the headset, including LEDs if present. When the USB headset is selected, the voice path to or from the USB headset is used in an active call.

Avaya USB headset adapter with HID

When you enable the HID support for Avaya USB Mobile or Enhanced adapter, then the IP Deskphone makes use of the UI elements on the

adapter. Both type of USB headsets are stimulus devices, as the IP Deskphone can have complete control of the LEDs. [Table 12 on page 109](#) lists the features of the Avaya USB headset Adapter.

Table 12: Avaya USB headset adapter with HID support

Feature	Description
Key Event	<p>Key press on the adapter generates events only with a state maintained and actions taken by the IP Deskphone. There is a one-to-one mapping on most of the keys on the adapter to the keys on the IP Deskphone (the Avaya Enhanced Adapter has a Avaya logo key which does not exist on the IP Deskphone). Table 13 on page 112 illustrates the mappings:</p> <p>Key press events on the adapter are sent to the IP Deskphone through the USB. When the IP Deskphone receives these events, it maps them to the corresponding key events as if the keys on the IP Deskphone are pressed.</p>
LED	<p>There are two LEDs on the adapters, one for the mute status and the other for message waiting. These two LEDs are also mapped to the corresponding LEDs on the IP Deskphone. The IP Deskphone synchronizes the LEDs status with that of the IP Deskphone: the Mute LED for mute indication and the Message Waiting LED for message waiting and incoming call (flash) indications. The Avaya USB Enhanced Adapter has an extra port to connect an external alerter. If there is an external alerter attached, the external alerter is kept synchronized with the Message Waiting LED.</p>

Feature	Description
Attached Indicator	When a Avaya USB Mobile or Enhanced Headset is connected to the IP Deskphone, after enumeration, the IP Deskphone flashes the LEDs on the headset for a short duration to indicate the headset is ready to use.
Back Light	Both adapters have a back light to allow easy identification of the adapters. If the back light is enabled in the Headset screen, the back light of the adapter turns on after enumeration.
Message Waiting	If there is voice message waiting on the IP Deskphone, the IP Deskphone turns on the red message waiting LED on the IP Deskphone and on the adapter. The IP Deskphone turns off the red message waiting LED if there is no voice message waiting.
External Alerter	The Avaya USB Enhanced Adapter has a port to allow an External Alerter (large LED indicator) to attach to the adapter. The IP Deskphone uses HID commands to keep the External Alerter synchronized with the red Message Waiting LED on the IP Deskphone and on the adapter.
Incoming Call	When there is an incoming call, the IP Deskphone sends an alerting event to the adapter. The red Message Waiting LED flashes to indicate there is an incoming call on the IP Deskphone.
Caller ID Information	Not applicable.

Feature	Description
Call Answer	You can answer an incoming call by pressing the Headset key on the IP Deskphone or the Off Hook (Green) key on the adapter. After a call is answered, audio data flows between the IP Deskphone and the headset adapter through the USB.
Outgoing Call	You can make an outgoing call by either pressing the Headset key on the IP Deskphone, or the Off Hook (Green) key on the adapter. When off hook, the IP Deskphone streams dial tone to the headset. The telephone number must be dialed using the key pad of the IP Deskphone. After a call is answered, audio data flows between the IP Deskphone and the headset adapter through the USB.
Call Release	You can release an incoming call or an outgoing call by pressing either the On Hook (Red) key on the adapter, or the Release (Goodbye) key on the IP Deskphone. After a call is released, audio data between the IP Deskphone and the headset stops.
Call Mute	Pressing the Mute key on the adapter is equivalent to pressing the Mute key on the IP Deskphone. After processing the mute event, the voice path from the IP Deskphone to the far end is muted. Both the Mute LED on the IP Deskphone and the LED on the adapter are lit to indicate the call is muted. When unmuted, the voice path resumes and both LEDs go off.

Feature	Description
Volume Up/Down	Pressing the Volume Up/Down key on the adapter is equivalent to pressing the Volume Up/Down key on the IP Deskphone. After processing the Volume Up/Down events, the system volume changes and affects the volume on the attached headset.
Audio Processing	Same as the wired headset. Audio quality is restricted to narrow band with mono voice channel only.

Table 13 on page 112 lists the Avaya USB adapter key mappings.

Table 13: Avaya USB adapter key mappings

Keys on adapter	Keys on the IP Deskphone
Blue Key	Expand Key
Green Key	Headset Key
Red Key	Release Key
Mute Key	Mute Key
Volume Up/Down	Volume Up/Down

The Blue key is mapped to the Expand key on the IP Deskphone. Therefore, pressing the Blue key invokes the Instant Messaging screen.

Third-party USB headsets with HID

Both USB Audio and USB HID commands are supported. The two classes of third-party USB headsets are as follows:

- Plantronics CS50/CS60 Wireless USB headsets
- GN Netcom 9300 series wired and wireless USB headsets

The HID support of third-party USB headsets performs differently from the Avaya Headset. The headsets are independent devices with an internal state machine to control LED operations and headset behavior.

Table 14 on page 113 lists the features of a third-party USB headset with HID support.

Table 14: Third-party USB headset with HID support features (Part 1 of 5) (Part 1 of 5)

Feature	Description
Key Events	<p>Both types of headsets have equivalent mechanisms to generate the following key events:</p> <ul style="list-style-type: none"> • On Hook • Off Hook • Mute • Volume Up/Down <p>The headsets send the corresponding HID commands to the IP Deskphone to synchronize call processing operations. When the IP Deskphone receives these commands, the IP Deskphone maps them to the corresponding key events (except the Volume Up/Down keys) as if the keys on the IP Deskphone are pressed.</p> <p>If the corresponding keys on the IP Deskphone are used instead, the IP Deskphone sends the HID commands to the headsets to allow the headsets to update their internal state machine.</p>

Table 14: Third-party USB headset with HID support features (Part 2 of 5) (Part 2 of 5)

Feature	Description
LEDs	Both types of headsets have LEDs on the base station for status indication. These LEDs are controlled by the headset base stations themselves according to their internal state machines. The IP Deskphone has no direct control of these LEDs.
Attached Indicator	Both types of headsets can have attached indications independent of the IP Deskphone operations. The GN Netcom (Jabra) 9350 headset can take over 3 seconds to complete the enumeration process after the headset is attached to the IP Deskphone. During enumeration, the LEDs at the bottom of the base station flash. The enumeration process is complete only when there is a blink at the headset piece and the base LEDs become solid.
Back Light	Not applicable
Message Waiting	Not applicable
External Alerter	Not applicable
Incoming Call	When there is an incoming call, the IP Deskphone sends an alerting event to the headset. Each type of headset has different incoming call indications.
Caller ID Information	Not applicable

Table 14: Third-party USB headset with HID support features (Part 3 of 5) (Part 3 of 5)

Feature	Description
Call Answer	You can answer an incoming call by pressing the Headset key on the IP Deskphone or the Off Hook equivalent key on the headset. The IP Deskphone coordinates the key events from both sources and performs the necessary call processing operations. Call connected indications, if available, are autonomous within the headset to match its internal state. After a call is answered, audio data flows between the IP Deskphone and the headset through the USB.
Outgoing Call	You can make an outgoing call by either pressing the Headset key on the IP Deskphone or the Off Hook equivalent key on the headset. When off hook, the IP Deskphone streams dial tone to the headset. This class of headset has no dial pad and the telephone number must be dialed using the key pad of the IP Deskphone. After the call is connected, voice data streams between the IP Deskphone and the headset.

Table 14: Third-party USB headset with HID support features (Part 4 of 5) (Part 4 of 5)

Feature	Description
Call Release	<p>You can release an incoming call or an outgoing call by pressing either the Release (Goodbye) key on the IP Deskphone or the On Hook equivalent key on the headset. After a call is released, audio data stops between the IP Deskphone and the headset.</p> <p>If you are using the Plantronic headset, to release a call, press and hold the answer/release toggle button for more than two seconds.</p>
Call Mute	<p>The mute key event is handled independently on the headset. The corresponding HID command is sent to the IP Deskphone to synchronize IP Deskphone status. Mute status indication on the headset is also independent. When muted, the headset streams blank audio to the IP Deskphone and the IP Deskphone also mutes the audio to the far end (double muted).</p>
Volume Up/Down	<p>This class of headsets manages volume changes locally whenever Volume Up/Down keys are pressed. Pressing the Volume Up/Down keys on the headset has no effect on system volume. The IP Deskphone ignores volume events from the headsets to avoid double volume changes. On the other hand, volume changes on the IP Deskphone change the system setting and indirectly affects the volume level on the headset.</p>

Table 14: Third-party USB headset with HID support features (Part 5 of 5) (Part 5 of 5)

Feature	Description
Audio Processing	Same as the wired headset. Both headsets support Wideband audio. The IP Deskphone selects to use 16KHz audio to match the audio characteristics of the headset.

Analog Terminator Adapter for analog (500/2500-type) telephone or fax machine

SIP Software Release 3.x supports the Analog Terminator Adapter (ATA) which is connected using the USB port. An analog (500/2500-type) telephone or fax machine can be connected to the ATA to convert the IP Deskphone to an analog system. The ATA is treated as an USB Headset device by the IP Deskphone.

SIP Software 3.0 supports On hook/Off hook and dial pad key events for HID support to allow the attached device to make outgoing calls directly without using the key pad on the IP Deskphone. If Calling Line ID (CLID) of the far-end is available, then the information is sent to the attached analog device. An analog (500/2500-type) telephone or fax machine that supports Calling Line ID displays the information on the screen.

Table 15 on page 118 displays the characteristics of ATA.

Table 15: Summary of ATA characteristics (Part 1 of 3)

Feature	Description
Key Events	In addition to On hook, Off hook events, dial pad digit events from the attached analog device are also supported. Key press events on the adapter are sent to the IP Deskphone through the USB. After the IP Deskphone receives these events, it maps them to the corresponding key events as if the keys on the IP Deskphone are pressed.
LEDs	Not applicable.
Attached Indicator	Not applicable.
Back Light	Not applicable.
Message Waiting	Not applicable.
External Alerter	Not applicable.
Incoming Call	When there is an incoming call, the IP Deskphone sends an alerting event to the adapter. The adapter produces the ring tones for the attached analog device to indicate there is an incoming call on the IP Deskphone.
Caller ID Information	Caller ID, if available, is also sent to the adapter. The adapter sends the CLID to the attached analog device for display.

Table 15: Summary of ATA characteristics (Part 2 of 3)

Feature	Description
Call Answer	You can answer an incoming call by pressing the Headset key on the IP Deskphone or the Off Hook key on the attached analog device. After a call is answered, the adapter converts the digital voice data to analog and sends it to the attached analog device.
Outgoing Call	You can make an outgoing call by either using the Headset key on the IP Deskphone or the Off Hook key on the attached analog device. When off hook, the IP Deskphone streams dial tone to the adapter. The telephone number can be dialed using the key pad of the IP Deskphone or the key pad of the analog device. After a call is answered, the adapter converts the digital voice data to analog and sends it to the attached analog device.
Call Release	You can release an incoming call or an outgoing call by either pressing the Release (Goodbye) key on the IP Deskphone or On Hook key on the analog device.
Call Mute	The analog device may have a mute key to stop voice transmission; however, the Mute key event on the analog device is not supported.
Volume Up/Down	The Volume Up/Down key on the analog device, if available, is independent of the IP Deskphone operation.

Table 15: Summary of ATA characteristics (Part 3 of 3)

Feature	Description
Audio Processing	Same as the wired headset. Audio quality is restricted to narrow band with mono voice channel only.

Making a call

This section describes the methods you can use to make a call. You can make a call from your IP Deskphone using one of the following:

- [“Making a call using off-hook dialing” on page 122](#)
- [“Making a call using on-hook dialing” on page 124](#)

You can also initiate a call while using one of the following features:

- [“The Address Book” on page 145](#)
- [“Call Inbox” on page 163](#)
- [“Call Outbox” on page 174](#)
- [“Instant Messaging” on page 181](#)

When an outgoing call fails to connect to the destination, one of the following messages appears:

- Declined, Temporarily unavailable
- Declined, Cannot find user
- Declined, User has declined call
- Declined, <user supplied reason> (for example, In a meeting.)

Making a call using off-hook dialing

To make a call using off-hook dialing:



1. Make a call by using one of the following off-hook dialing methods:

- Press the **Line** feature key
- Lift the handset
- Press the **Headset** fixed key
- Press the **Handsfree** fixed key



The IP Deskphone produces a dial tone.



2. You can make a call using one of the following methods:

- Enter the phone number or SIP address by using the dialpad.



abc



Note: The **abc/123** context-sensitive soft key toggles between alphabetic and numeric input.

Redial



- Press the **Redial** context-sensitive soft key to dial the last dialed number.

Note: The **Redial** context-sensitive soft key only appears if a number or address was previously entered.

VMail



- Press the **Msgs** context-sensitive soft key and then select **Voice Mail** from the **Messages** menu to access your voice mail.
- Press the **Speed dial** feature key that you programmed to call with a commonly used or important phone number or SIP address.

Note: You can program a feature key to use as a shortcut to dial a number or a SIP address. For more information, see [“Using Call Forward” on page 247](#).

Alex



3. Press the **Send** context-sensitive soft key to immediately initiate the call.

Note: The IP Deskphone automatically initiates a call shortly after you enter the SIP address or phone number.

Send



Making a call using on-hook dialing

You can make a call by using on-hook dialing. Enter the SIP address or the phone number before going off-hook.

Note: When you use this method, you cannot toggle between alphabetic or numeric input.

To make a call using on-hook dialing:



1. Dial the number or SIP address.

Chad



2. Continue the call by using one of the following methods:

- Press the **line** feature key.
- Press the **Headset** fixed key.
- Press the **Handsfree** fixed key.

3. To terminate the call, choose one of the following:

- Replace the handset into the cradle.
- Press the **Goodbye** key.



Using handsfree calling

While on an active call, you can switch between the handset and handsfree mode.

To end a handsfree call:

Press the **Goodbye** key

To mute a handsfree call:

1. Press the **Mute** key.
The LED indicator lights.



2. Press the **Mute** key again to return to a two-way handsfree conversation.

To switch from the handsfree to handset mode:

Lift the handset.

To switch from the handset mode to handsfree mode:

1. Press the **Handsfree** key.
The LED indicator lights with a solid red light.



2. Replace the handset.

To use a headset:

1. Connect the headset to the headset jack or the handset jack.



2. Press the **Headset** key. The LED indicator lights.



3. Press the **Goodbye** key or press the button on the wireless headset, if equipped, to release a call.

To switch from handsfree to headset:



1. Press the **Headset** key. The LED indicator lights.

Using Call Subjects

You have the option of sending a Call Subject when you initiate a call to a contact. Use this feature to indicate to the contact the reason for the call. The IP Deskphone contact displays a message, such as *Weekly report call* or *Daily status* when they receive the call. You can select a subject from a list you create. For more information, see [“Managing Call Subjects” on page 129](#), or you can create a new subject.

Note: The Call Subject feature is not available for all call servers. Contact your system administrator or service provider to determine if this feature is available to you.

Whenever you initiate a call by using off-hook dialing, the **Subject** context-sensitive soft key appears as an option to use. You can select a Call Subject from a list or create a new Call Subject to send.

To enter a call subject from a list:



1. Press the **Subject** context-sensitive soft key to send a Call Subject with the call you are making.

A list of Call Subjects appears on the LCD screen.



Select

2. Choose one of the following:

- Press the **Up/Down** navigation key to highlight the Call Subject you want to use and press the **Select** context-sensitive soft key.

The IP Deskphone sends the Call Subject to the contact you are calling.



New

- Press the **New** context-sensitive soft key to create a new Call Subject that is not on the list.



abc

3. Press the **abc/123** context-sensitive soft key to toggle between alphabetic and numeric characters.



4. Use the dialpad to enter the Call Subject.

Save



Clear



Back



5. Choose one of the following:
 - Press the **Save** context-sensitive soft key to continue.
 - Press the **Clear** context-sensitive soft key to clear the text.
 - Press the **Back** context-sensitive soft key to return to the previous menu.

Note: When you select a subject from this list, it appears on the screen before you send the call. If you want to change that subject press the **Subject** context-sensitive soft key to return to the Call Subject menu. You now have the option to select **No** to a Call Subject.

To create a new call subject while initiating a call:

Subject



New



abc



1. Press the **Subject** context-sensitive soft key to send a Call Subject with the call you are making.
2. Press the **New** context-sensitive soft key to create a new Call Subject.
3. Press the **abc/123** context-sensitive soft key to toggle between alphabetic and numeric characters.
4. Use the dialpad to enter the new Call Subject for the contact.

Save

Clear

Back

5. Choose one of the following:
 - Press the **Save** context-sensitive soft key to save the new Call Subject and use it with the call.
 - Press the **Clear** context-sensitive soft key to clear the text.
 - Press the **Back** context-sensitive soft key to return to the previous menu without sending the new Call Subject.

Note: The IP Deskphone saves the new Call Subject to the list of Call Subjects for later use.

Managing Call Subjects

You can create a list of Call Subjects to have ready to use when you initiate a phone call. The number of Call Subjects that are stored on the IP Deskphone depends on how the IP Deskphone was initially configured. You can modify, delete, and add Call Subjects while the IP Deskphone is in the idle state.

Adding a Call Subject

You can add a Call Subject while the IP Deskphones is idle.

To add a Call Subject while the IP Deskphone is idle:

Prefs

1. Press the **Prefs** context-sensitive soft key, select **Feature Options**, and then select **Call Subject** from the menu.

Add

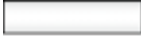

2. Press the **Add** context-sensitive soft key to create new Call Subject.

Note: If the Call Subject list is full, then the option to add a new Call Subject is not available. In this situation, you need to delete a Call Subject before you can add the new Call Subject.

abc



3. Press the **abc/123** context-sensitive soft key to toggle between alphabetic and numeric characters.



4. Use the dialpad to enter the new Call Subject.

Save



or

Back



5. Choose one of the following:
 - Press the **Save** context-sensitive soft key to add the new Call Subject.
 - Press the **Back** context-sensitive soft key to return to the previous menu without adding a new Call Subject.

Deleting a Call Subject

You can delete a Call Subject while the IP Deskphone is idle.

To delete a Call Subject while the IP Deskphone is idle:

Prefs



1. Press the **Prefs** context-sensitive soft key, select **Feature Options**, and then select **Call Subject** from the menu.



2. Press the **Up/Down** navigation key to scroll through and highlight the Call Subject to delete.

Delete



3. Press the **Delete** context-sensitive soft key to delete the selected Call Subject.

A confirmation screen appears with the question, Delete call subject?

4. Choose one of the following:

Ok



or

Back

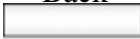

- Press the **Ok** context-sensitive soft key to confirm the deletion of the Call Subject.

- Press the **Back** context-sensitive soft key to not delete the Call Subject and return to the previous menu.

Editing a Call Subject

You can edit a Call Subject while the IP Deskphone is idle.

To edit a Call Subject while the IP Deskphone is idle:

Prefs



1. Press the **Prefs** context-sensitive soft key, select **Feature Options**, and then select **Call Subject** from the menu.



2. Press the **Up/Down** navigation key to scroll through and highlight the Call Subject to edit.

Edit



3. Press the **Edit** context-sensitive soft key to edit the selected Call Subject.

abc



4. Press the **abc/123** context-sensitive soft key to toggle between alphabetic and numeric characters.



5. Use the dialpad to edit the Call Subject.

Save



or

Back



6. Choose one of the following:
 - Press the **Save** context-sensitive soft key to confirm the changes.
 - Press the **Back** context-sensitive soft key to return to the previous menu without editing the Call Subject.

Receiving a call

When you receive a call, you are typically notified by the alerting ring, and the incoming caller identification appears on the LCD screen. The incoming call forces the screen to exit active menu activities and takes precedence over a pop-up Instant Message (IM).

Caller identification

When you receive an incoming SIP call, the Caller ID information appears on the LCD screen. When you receive a call from a contact that is entered in the IP Deskphone Address Book, the caller information appears as it is in the Address Book. See [Figure 23 on page 134](#).

You can restrict the information displayed for incoming calls or for calls you make. For more information, see [“Configuring Privacy settings” on page 255](#).

When you receive an incoming call you can do one of the following:

- Answer an incoming call. See [“Answering an incoming call” on page 134](#).
- Redirect an incoming call. See [“Redirecting an incoming call” on page 134](#).
- Decline an incoming call. See [“Declining an incoming call” on page 137](#).
- Ignore an incoming call. See [“Ignoring an incoming call” on page 141](#).
- Receive an intercom call. See [“Receiving intercom calls” on page 143](#).
- Receive paging calls. See [“Receiving paging calls” on page 143](#).

Figure 23: Incoming call screen

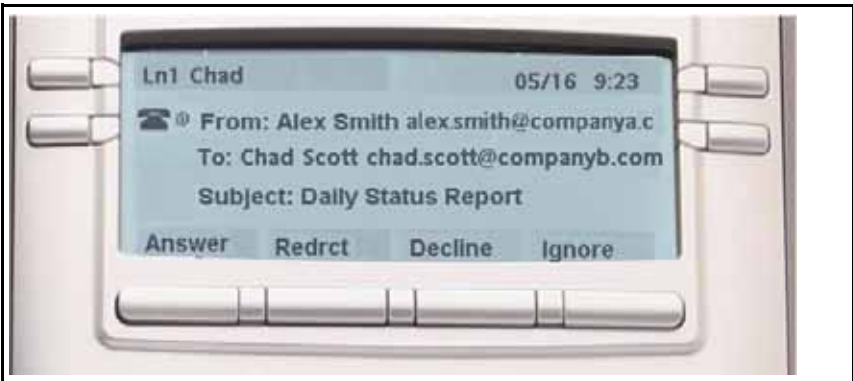

Answering an incoming call

When you can answer an incoming call, you can choose one of four methods.

To answer an incoming call:

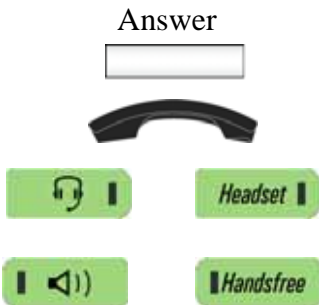

1. Choose one of the following:
 - Press the **Answer** context-sensitive soft key that activates a Handsfree call.
 - Lift the handset.
 - Press the **Headset** fixed key.
 - Press the **Handsfree** fixed key.

Redirecting an incoming call

When you receive a call, you can choose to redirect the call to another destination without answering the call.

To redirect a call, press the **Redrct** context-sensitive soft key. To enter a SIP address or phone number where you want the call redirected, use one of the following methods:

- Enter the SIP address or phone number by using the dialpad.
- Select a contact from the Address Book, Call Inbox, or Call Outbox.

To redirect an incoming call by using the dialpad:

Redrct



1. Press the **Redrct** context-sensitive soft key to redirect an incoming call. The LCD screen prompts you to enter an address to which you want the call directed.



2. Use the **Dialpad** to enter a phone number or SIP address.

Note: Do not use the # key to end dialing when you redirect a call. The call returns a busy signal and does not connect.

Redrct



Clear



Back



3. To redirect the call to the address you enter, choose one of the following:
 - Press the **Redrct** context-sensitive soft key.
 - Press the **Clear** context-sensitive soft key to clear the entry.
 - Press the **Back** context-sensitive soft key to return to the **Incoming Call** screen without redirecting the call.

To redirect a call by using the Address Book, Call Inbox, or Call Outbox:

Redrct



1. Press the **Redrct** context-sensitive soft key to redirect an incoming call.

2. To select a SIP address to redirect the call, do one of the following:



Directory

— Press the **Directory** fixed key to choose a SIP address from the Address Book.



Msg/Inbox

— Press the **Msg/Inbox** fixed key to choose a SIP address from the Call Inbox.



Shift/Outbox

— Press the **Shift/Outbox** fixed key to choose a SIP address from the Call Outbox.



3. Press the **Up/Down** navigation key to highlight a SIP address contact.

4. Choose one of the following:

Select



or

Back



— Press the **Select** context-sensitive soft key to select the highlighted SIP address.

— Press the **Back** context-sensitive soft key to return to the previous screen.

Redrct



5. Press the **Redrct** context-sensitive soft key to redirect the incoming call to the selected address.

Declining an incoming call

You can decline an incoming call by pressing the **Decline** context-sensitive soft key. You can decline a call with or without giving a reason. You can create custom decline reasons, and you have the option of selecting one. If you do not choose a custom decline reason, the IP Deskphone sends the default message: `User has declined call`.

Note: The Call Decline feature is not available for all call servers. Contact your system administrator or service provider to determine if this feature is available to you.

The treatment that an incoming call receives when Call Decline is invoked depends upon the call server. In a SIP environment the caller receives a call declined message, and they no longer hear ring back. In a non-SIP environment, the caller can continuously hear a ring back.

To decline an incoming call:

Decline



1. Press the **Decline** context-sensitive soft key to decline an incoming call.



New



2. Choose one of the following:
 - Press the **Up/Down** navigation key to highlight a Decline Call Reason.
 - Press the **New** context-sensitive soft key to create a new decline reason to send. For more information, see [“Creating a new Call Decline Reason”](#) on page 138.

Note: Highlight **None** to use the default system message `User has declined call`.

Send



Back



3. Choose one of the following:
 - Press the **Send** context-sensitive soft key to send the selected decline reason to the caller.
 - Press the **Back** context-sensitive soft key to abort the call decline and return to the incoming call screen.

Creating a new Call Decline Reason

You can create an new Call Decline Reason.

To create a New Decline Reason during an incoming call:

Decline



1. Press the **Decline** context-sensitive soft key to decline an incoming call.

New



2. Press the **New** context-sensitive soft key to create a new custom decline reason.

abc



3. Press the **abc/123** context-sensitive soft key to toggle between alphabetic and numeric characters.



4. Use the **Dialpad** to enter a new Call Decline Reason.

Send



5. Choose one of the following:

- Press the **Send** context-sensitive soft key to send the new custom decline reason to the caller.

Note: The IP Deskphone adds the new reason to the list of Decline Call Reasons for future use.

Back



- Press the **Back** context-sensitive soft key to return to the initial Decline Call screen.

Managing Call Decline Reasons

You can create Call Decline Reasons that you can access when you want to decline an incoming call. Also, you can edit and delete Call Decline Reasons from the list of Call Decline Reasons you create.

To create a Call Decline Reason:

Prefs



1. Press the **Prefs** context-sensitive soft key, select **Feature Options**, and then choose **Call Decline Reasons** from the menu.

Add



2. Press the **Add** context-sensitive soft key to add a new Call Decline Reason to the list of available Call Decline Reasons.



3. Use the dialpad to enter the new Call Decline Reason for the contact.

Save



Back



4. Choose one of the following:
 - Press the **Save** context-sensitive soft key to save the new Call Decline Reason.
 - Press the **Back** context-sensitive soft key to return to the previous menu without saving the new Call Decline Reason.

Note: The IP Deskphone saves the new Call Decline Reason to the list of Call Decline Reasons for later use.

To delete a Call Decline Reason:



Delete



1. Press the **Up/Down** navigation key to scroll through and highlight the Call Decline Reason to delete.
2. Press the **Delete** context-sensitive soft key to delete the selected Call Decline Reason.

A confirmation screen appears with the question `Delete Decline Reason?`

3. Choose one of the following:
 - Press the **Ok** context-sensitive soft key to confirm the deletion of the Call Decline Reason.
 - Press the **Back** context-sensitive soft key to return to the previous menu without deleting the Call Decline Reason.

Ok

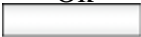

or

Back

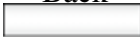

To edit a Call Decline Reason:

Edit



abc



Save



or

Back



1. Press the **Up/Down** navigation key to scroll through and highlight the Call Decline Reason to edit.
2. Press the **Edit** context-sensitive soft key to edit the selected Call Decline Reason.
3. Press the **abc/123** context-sensitive soft key to toggle between alphabetic and numeric characters.
4. Use the dialpad to edit the Call Decline Reason.
5. Choose one of the following:
 - Press the **Save** context-sensitive soft key to confirm the changes.
 - Press the **Back** context-sensitive soft key to return to the previous menu without editing the Call Decline Reason.

Ignoring an incoming call

You can terminate an incoming call alert without answering the call or sending a Decline Call reason by pressing the **Ignore** context-sensitive soft key or by pressing the **Goodbye** fixed key. The caller continues to hear the ringing tone but is unaware that you are ignoring the call.

You can configure the Call Ignore feature to either Local or Network. When Call Ignore is configured to Local, only that IP Deskphone is affected, and it stops ringing when you press the **Ignore** context-sensitive soft key. When Call Ignore is configured to Network and you press the **Ignore** context-sensitive soft key, the IP Deskphone stops ringing, and a message is sent to the network indicating that you are busy at all SIP IP Deskphones you are logged on to, and that server should stop trying to contact you.

To configure the Ignore feature to Local or Network press the **Prefs** context-sensitive soft key, select **Feature Options**, and then select **Call Ignore Action** from the menu. Press the **Change** context-sensitive key to change the Call Ignore setting to either Call Ignore: Local, or Call Ignore: Network.

Note: When you are on active call and you receive an incoming call, do not press the **Goodbye** fixed key to ignore an incoming call. If you press the **Goodbye** fixed key, the current call disconnects. Press the **Ignore** context-sensitive soft key to ignore the incoming call.

To ignore an incoming call:

Prefs



1. Press the **Prefs** context-sensitive soft key, select **Feature Options**, and then select **Call Ignore Action** from the menu.

Change



2. Press the **Change** context-sensitive key to change the Call Ignore setting to either Call Ignore: Local or Call Ignore: Network

Ignore



3. To terminate an incoming call alert and ignore the incoming call, do one of the following:
 - Press the **Ignore** context-sensitive soft key to terminate an incoming call.
 - Press the **Goodbye** fixed key when you are not on an active call.

Receiving intercom calls

Your IP Deskphone can be part of an intercom group. After you receive a call from the intercom group, the following occurs:

- You receive a call notification and the IP Deskphone rings; the display is similar to the display of a normal call.
- The IP Deskphone auto-answers the intercom call on handsfree after the configured number of seconds pass by.
- The IP Deskphone auto-answers only if you do not answer the call within the configured time limit.
- If you are on an active call, the IP Deskphone does not auto-answer the incoming intercom call.

Receiving paging calls

Your IP Deskphone can be part of a paging group. After you receive a call from the paging group, the following happens:

- The display on the screen includes a <<Paging>> tag, the From header, and optional subject.
- The IP Deskphone establishes a one-way speech path between the IP Deskphone and the caller; that is, you can only hear the call, you cannot respond.
- The IP Deskphone does not display context-sensitive soft keys.

- The IP Deskphone blocks all key events, such as line keys and digit keys, except for the Volume up and down keys, the Mute on and off key, and the Release key (Goodbye key).
- If you are on an active call, the IP Deskphone does not auto-answer the page call.
- While the page call is active, Do Not Disturb (DND) is enabled on the IP Deskphone; the IP Deskphone does not accept other incoming calls until the page call ends.
- If you are in the process of making an outgoing call and a page call comes in, the IP Deskphone ends the outgoing call and auto-answers the page call.

The Address Book

The Address Book is a personal directory of contacts from which you can make a phone call or send an Instant Message (IM). You can access the Address Book while on a call and start a new call from the highlighted contact. You can use the Address Book for the following:

- “Viewing the Address Book” on page 145
- “Initiating a call from the Address Book” on page 146
- “Adding a contact to your Address Book” on page 148
- “Editing a contact in your Address Book” on page 149
- “Copying information to the Address Book” on page 153
- “Searching for a contact in the Address Book” on page 155

Viewing the Address Book

To access the Address Book, press the **Directory** fixed key or press the **View** context-sensitive soft key, and then select **Address Book** from the menu. See [Figure 24 on page 145](#).

Figure 24: The Address Book

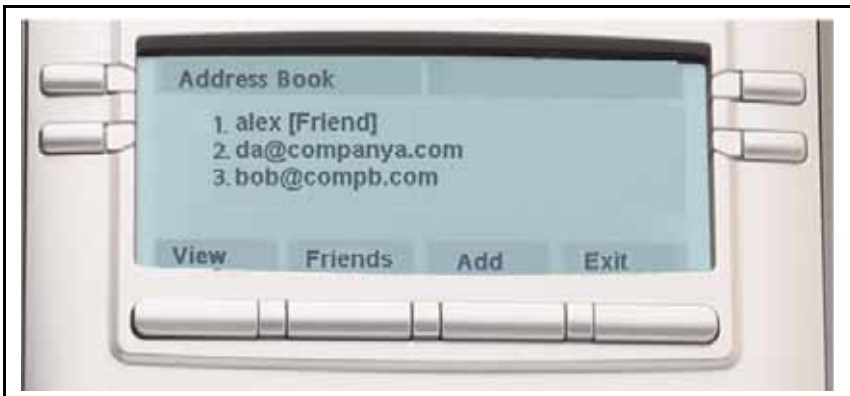

To view information about a contact use the navigation button to highlight a name, and then press the **View** context-sensitive soft key. The name,

SIP address, and designation of contact or not as `Friend` appears. See [Figure 25 on page 146](#).

When you view the details of a contact, you can:

- Send an IM. For more information, see [“Composing an Instant Message” on page 184](#).
- Edit the contact information. For more information, see [“Editing a contact in your Address Book” on page 149](#).

Figure 25: Contact details



Initiating a call from the Address Book

You can initiate a call directly from your IP Deskphone Address Book.

Note: If your service provider requires that a Directory Number (DN) be used to initiate a call, the Address Book entry must have the DN to initiate a call.

First, go off-hook by using one of the methods described in the section [“Making a call using off-hook dialing” on page 122](#). If needed, you can add a Call Subject. For more information, see [“Using Call Subjects” on page 126](#).

You can also access the Address Book while on an active call and initiate a new call. The IP Deskphone automatically places the active call on hold when you initiate a new call.

To initiate a call to a contact stored in the Address Book:



Directory

1. Press the **Directory** fixed key to select a contact from the Address Book to call.



2. Press the **Up/Down** navigation key to highlight a contact on the list.

View



3. Press the **View** context-sensitive soft key to make a call to the contact.

4. Choose one of the following:

Call



or

Back



- Press the **Call** context-sensitive soft key to make a call to the contact.
- Press the **Back** context-sensitive soft key to return to the off-hook screen.

Adding a contact to your Address Book

You can add a new contacts to the Address Book of the Avaya 1120E IP Deskphone.

To add a contact to your Address Book:



View



abc



Next



Back



1. Choose one of the following:
 - Press the **Directory** fixed key.
 - Press the **View** context-sensitive soft key, select **Address Book** from the menu, and then press the **New** context-sensitive soft key.
2. Press the **abc/123** context-sensitive soft key to toggle between alphabetic and numeric characters.
3. Choose one of the following:
 - Use the dialpad to enter a name for the new contact and press the **Next** context-sensitive soft key to continue.
 - Press the **Back** context-sensitive soft key to return to the previous menu.
4. Use the dialpad to enter a phone number or SIP address (URI) for the new contact.

Yes

No

Back

Ok

5. Do one of the following to complete the entry:
 - Press the **Yes** context-sensitive soft key to add the contact to a group and then select the group for the contact to be added.
 - Press the **No** context-sensitive soft key if you do not want to add the contact to your address book, and return to the address menu screen.
 - Press the **Back** context-sensitive soft key to return to the previous menu.

6. Press the **Ok** context-sensitive soft key to complete the entry and return to the Address Book menu.

Editing a contact in your Address Book

You can edit a contact in your Address Book.

To edit a contact in your Address Book:



Directory

1. Press the **Directory** fixed key:



View



Edit



abc



Next



Back



2. Press the **Up/Down** navigation key to highlight the contact you want to edit, and then press the **View** context-sensitive soft key.
3. Press the **Edit** context-sensitive soft key to edit the contact information.
4. Press the **abc/123** context-sensitive soft key to toggle between alphabetic and numeric characters.
5. Use the dialpad to enter the new name for the contact.
6. Choose one of the following:
 - Press the **Next** context-sensitive soft key to continue.
 - Press the **Back** context-sensitive soft key to return to the previous menu.

Note: If you only need to change the SIP address or phone number for the contact, press the **Next** context-sensitive soft key without making changes to the name.



Next

Back

Yes

No

Back

7. Use the dialpad to enter a new phone number or new SIP address (URI) for the contact.

8. Choose one of the following:

- Press the **Next** context-sensitive soft key to continue.
- Press the **Back** context-sensitive soft key to return to the previous menu.

9. Do one of the following to complete the entry:

- Press the **Yes** context-sensitive soft key to designate the contact as a friend and return to the address menu screen.
- Press the **No** context-sensitive soft key if you do not want a contact designated as a friend and return to the address menu screen.

Note: If the contact is already designated as a friend then the question *Remove from friends?* appears. Press the **Yes** context-sensitive soft key to remove the contact from your friends list or press the **No** context-sensitive soft key to keep the contact on your friends list.

- Press the **Back** context-sensitive soft key to return to the previous menu.

Ok



10. Press the **Ok** context-sensitive soft key to complete the entry and return to the previous menu.

To delete a contact from your Address Book:



View



1. Press the **Up/Down** navigation key to highlight the contact you want to delete and press the **View** context-sensitive soft key.

Edit



2. Press the **Edit** context-sensitive soft key to access the contact information.

Delete



3. Press the **Delete** context-sensitive soft key to completely delete the contact from the Address Book.

Ok



Back



4. Choose one of the following:
 - Press the **Ok** context-sensitive soft key to confirm.
 - Press the **Back** context-sensitive soft key to return to the previous menu.

Ok



5. Press the **Ok** context-sensitive soft key to complete the procedure and return to the Address Book.

Copying information to the Address Book

To copy information from the Call Inbox or the **Call Outbox** screen to the Address Book use the **Copy** fixed key.

Note: If you press the **Copy** fixed key while in idle mode the message, *No content selected for copying* appears on the screen. This message does not appear when an IM pop-up appears.

To copy a contact to the Address Book:



Copy

1. Press the **Up/Down** navigation key to highlight the contact in the Call Inbox or Call Outbox that you want to add to your Address Book and press the **Copy** fixed key.

A new screen appears offering the following destinations for the contact information:

- 1. Address Book
- 2. Speed Dial Key
- 3. Send IM Key
- 4. Call Forward Key



Select



2. Press the **Up/Down** navigation key to highlight the Address Book and press the **Select** context-sensitive soft key.

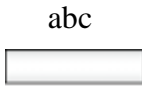

3. Press the **abc/123** context-sensitive soft key to toggle between alphabetic and numeric characters.

4. Use the dialpad to enter a name for the new entry.

5. Choose one of the following:

- Press the **Next** context-sensitive soft key to continue.
- Press the **Back** context-sensitive soft key to return to the previous menu.

Note: If you do not need to change the name for the contact, press the **Next** context-sensitive soft key.

6. Use the dialpad to enter a new phone number or new SIP address for the contact.

7. Choose one of the following:

- Press the **Next** context-sensitive soft key to continue.
- Press the **Back** context-sensitive soft key to return to the previous menu.

Note: If you do not need to change the name for the contact, press the **Next** context-sensitive soft key.

8. Do one of the following to complete the entry:

Yes

No

Back

- Press the **Yes** context-sensitive soft key to add the contact to a group and then select the group for the contact to be added.
- Press the **No** context-sensitive soft key if you do not want a contact designated as a friend and return to the address menu screen.
- Press the **Back** context-sensitive soft key to return to the previous menu.

9. Choose one of the following:

Yes

No

- Press the **Yes** context-sensitive soft key to designate the contact as a friend.
- Press the **No** context-sensitive soft key if you do not want to designate the contact as a friend and return to the address menu screen.

Ok

10. Press the **Ok** context-sensitive soft key to complete the entry and return to the previous menu.

Searching for a contact in the Address Book

When you access the IP Deskphone Address Book you can perform a search for a contact using one of the following methods:

- Index Search (performs a search based on the index number you enter)

- 1st Character Search (performs a search based on the first character you enter)
- Name Search (performs a search based on the name you enter)

To change the method the Avaya 1120E IP Deskphone uses to search.

Prefs



1. Press the **Prefs** context-sensitive soft key, select **Misc Options**, and then highlight **Search Method** from the menu.

Change



2. Press the **Change** context-sensitive soft key.



3. Press the **Up/Down** navigation key to highlight the Search Method you want to use as the default when you search for a contact:

- 1. Index Search
- 2. 1st Character Search
- 3. Name Search

Select



4. Press the **Select** context-sensitive soft key to select a search method, and then return to the previous menu.

Using the Search feature in the Address Book

To search for a contact while accessing your personal Address Book, use the dialpad to enter the search information. For example:

- Index Search—to search for a contact by using the Index Search method, enter the index number. When entering an index number larger than 9, you must enter the next digit quickly to move to that

item on the list. For example, if the address you need is item 28 on the list, you must enter the digit 8 quickly after entering the digit 2.

- **1st Character Search**—to search for a contact whose name begins with the letter *d*, using the dialpad, press the *d* (3) key on the dialpad. The first entry in the Address Book that begins with the letter *d* appears.
- **Name Search**—to search for a specific name in your personal Address Book, enter the name by using the dialpad.

Using the Search feature

You can search for a contact that is in your IP Deskphone Address Book (Local Search) or for a contact in a directory that is stored on the call server (Global Search). You can save a contact name and SIP address found on the call server to your personal Address Book stored in your IP Deskphone.

Using Local Search

You can search for a contact that is stored in your Address Book.

To search for a contact stored in your Address Book:



1. Press the **Services** fixed key, select **Search**, and then select **Local Search** from the menu.



Select



abc



Search



Back



2. Press the **Up/Down** navigation key and then press the **Select** context-sensitive soft key to choose a search criteria:
 - 1. User Name
 - 2. Name
 - 3. Phone Number

3. Press the **abc/123** context-sensitive soft key to toggle between alphabetic and numeric characters.

4. Use the dialpad to enter the search information for the contact.

5. Choose one of the following:
 - Press the **Search** context-sensitive soft key.
 - Press the **Back** context-sensitive soft key to return to the previous menu.

Note: When the search is unsuccessful, the following message appears:
No entries found for <search criteria>



Call



Search



Exit



Search



Exit



6. When a search result is successful, you can do one of the following:
 - Press the **Up/Down** navigation key to highlight a contact, from the search result and press the **Call** context-sensitive soft key to initiate a call.
 - Press the **Search** context-sensitive soft key to start a new search.
 - Press the **Exit** context-sensitive soft key to return to the idle screen.

7. When a search result is not successful, you can do one of the following:
 - Press the **Search** context-sensitive soft key to return to the search menu and begin a new search.
 - Press the **Exit** context-sensitive soft key to return to the idle screen.

Using Global Search

You can perform a global search for a contact.

To perform a Global Search for a contact:



Services

1. Press the **Services** fixed key, select **Search**, and then select **Global Search** from the menu.



Select



abc



Ok



Back



2. Press the **Up/Down** navigation key and then press the **Select** context-sensitive soft key to choose a search criteria:
 - 1. User Name
 - 2. Name
 - 3. First Name
 - 4. Last Name
 - 5. Phone Number

 3. Press the **abc/123** context-sensitive soft key to toggle between alphabetic and numeric characters.

 4. Use the dialpad to enter the search information for the contact.

 5. Choose one of the following:
 - Press the **Ok** context-sensitive soft key.
 - Press the **Back** context-sensitive soft key to return to the previous menu.
- Note:** When the search is unsuccessful, the following message appears:
No entries found for <search criteria>



Call



Save



Search



Back



6. When a search result is successful you can do one of the following:
- Press the **Up/Down** navigation key to highlight a contact from the search result and press the **Call** context-sensitive soft key to initiate a call.
 - Press the **Save** context-sensitive soft key to save the caller information to the Address Book.

A confirmation screen appears. You can edit the name you save in the Address book. Press the **Save** context-sensitive soft key to accept the entry. Press the **Yes** context-sensitive soft key or the **No** context-sensitive soft key to designate whether the new entry is a friend. The phone saves the entry to the Address Book and returns you to the Inbox screen.

7. Choose one of the following:
- Press the **Search** context-sensitive soft key to start a new search.
 - Press the **Back** context-sensitive soft key to return to the previous screen.

New



Back

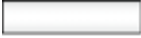

8. When a search result is not successful, you can do one of the following:
 - Press the **New** context-sensitive soft key to return to the search menu and begin a new search.
 - Press the **Back** context-sensitive soft key to return to the previous screen.

Call Inbox

While your IP Deskphone is active, all incoming calls are saved in your Call Inbox. You can view the following details about each call:

- Call status (Missed)
- Name of the caller
- SIP address
- Time of the call
- Number of consecutive calls each caller made to you
- Call Subject (if the caller sends a Call Subject)

You can configure the filter on your Call Inbox to display all incoming calls or missed calls. You can access your Call Inbox while the IP Deskphone is idle or while you are on a call. [Figure 26 on page 163](#) shows the Call Inbox while the IP Deskphone is idle.

Figure 26: Call Inbox while IP Deskphone is idle



Accessing the Call Inbox

You can access the Call Inbox and initiate a call when the IP Deskphone is:

- Idle. For more information, see [“Managing calls in the Call Inbox while not on a call” on page 164](#).
- Active. For more information, see [“Accessing the calls in your Call Inbox during a call” on page 173](#).

Managing calls in the Call Inbox while not on a call

You can manage calls in the Call Inbox while you are not on a call.

To manage calls in the Call Inbox while not on a call:



Msg/Inbox

1. Press the **Msg/Inbox** fixed key.



2. Press the **Up/Down** navigation key to highlight a call from the list of calls in your Call Inbox.

Note: You can initiate a call to the highlighted caller. For more information, see [“Initiating a call from the Call Inbox” on page 171](#).

Enter



Missed



All



Delete



Exit







3. Do one of the following:

- To place a call to the selected address using the primary login of the IP Deskphone, press the **Enter** key.
- To view the details of a highlighted call, press the **Right** navigation key. See [“Viewing the details of a call in the Call Inbox” on page 167](#).
- To leave the detail view and return to the main inbox screen, press the **Left** navigation key.
- Press the **Missed** context-sensitive soft key to toggle the view filter from the **All** context-sensitive soft key to the **Missed** context-sensitive soft key. See [“Managing missed calls” on page 167](#).
- The **All** context-sensitive soft key is displayed when the view mode is on **Missed**, and displays all the calls in the Call Inbox.
- Press the **Delete** context-sensitive soft key to delete the highlighted call or all calls in your Call Inbox. See [“Deleting calls in your Call Inbox” on page 172](#).
- Press the **Exit** context-sensitive soft key to exit the Call Inbox.

Table 16 on page 166 provides a list of additional user interactions for the main inbox screen.

Table 16: Additional user interactions

Item	Function
	<p>Use the Enter key to place a call to the selected address using the primary login of the IP Deskphone.</p> <p>The Enter key has the same behavior as the Call context-sensitive soft key.</p>
	<p>Use the Dial pad to select an item by index.</p>
	<p>To place a call to the address of the selected call log entry from the primary logged in user of the IP Deskphone, do one of the following:</p> <ul style="list-style-type: none"> — Lift the handset. — Press the Headset fixed key. — Press the Handsfree fixed key.
	<p>Press the Line key to place a call to the address of the selected call log entry from the user logged in on the selected line key.</p>

Viewing the details of a call in the Call Inbox

To view details of a call in the Call Inbox:

1. When you view the details of a call in the Call Inbox, you can do the following:

- Initiate a call to the caller displayed on the screen. For more information, see [“Initiating a call from the Call Inbox”](#) on page 171.



- Press the **Enter** key to place a call to the selected address using the primary login of the IP Deskphone.
- Press the **Prev** context-sensitive soft key to select and display the details of the previous entry in the call log.
- Press the **Next** context-sensitive soft key to select and display the details of the next entry in the call log.
- Press the **Back** context-sensitive soft key to leave the detail view and return to the main inbox screen.

Managing missed calls

When you do not answer incoming calls, the number of new calls appears on the IP Deskphone LCD screen. For example, if you miss three calls the following message appears: *3 new calls*.

Note: When you view a missed call in your Call Inbox, the new call message no longer appears on the LCD screen. The new calls are stored as missed calls.

To view missed calls:



1. Press the **Msg/Inbox** key and press the **Missed** context-sensitive soft key.



2. Press the **Up/Down** navigation key to highlight a call from the list of missed calls.



3. Press the **Right** context-sensitive soft key to view the details of the missed call.

Note: You manage the missed call the same as any call that is in your Call Inbox. For more information, see [“Viewing the details of a call in the Call Inbox” on page 167](#) and [“Initiating a call from the Call Inbox” on page 171](#).

All



4. To view all the calls in the Call Inbox, press the **All** context-sensitive soft key.

Delete



5. To delete the highlighted missed call or all missed calls, press the **Delete** context-sensitive soft key. For more information, see [“Deleting calls in your Call Inbox” on page 172](#).

Note: The IP Deskphone deletes only the missed calls from the Call Inbox.

Exit



6. To exit the Inbox and return to the idle phone screen, press the **Exit** context-sensitive soft key.

Missed Calls Notification

You can change the call log behavior so that the message `xx new calls` is cleared by entering the Inbox without having to select each missed call.

Figure 27 on page 169 displays the Message options screen.

Figure 27: Messages screen



Changing the Missed Calls Notification behavior:

Msgs



1. Press the **Msgs** context-sensitive soft key.



2. Press the **Up/Down** navigation key to highlight **Missed Calls Notification**.

Select



3. Choose one of the following:

- Press the **Select** context-sensitive soft key.
- Press the **Back** context-sensitive soft key to abort the changing of the configurations and return to the Message Options screen.

If you press the **Select** context-sensitive soft key, one of the following messages appears (based on the current setting of the option):

- Press Manual to change Missed Call Notification Message clearing mode
- Press Auto to change Missed Call Notification Message clearing mode

Auto



4. Choose one of the following:

- Press the **Auto** context-sensitive soft key to change the clearing mode for the `xx new calls missed call` message for the IP Deskphone.

Note: **Auto** means that the message is cleared from the idle screen as soon as you enter the Inbox.

Manual



- Press the **Manual** context-sensitive soft key to change the clearing mode for the `xx new calls missed call` message for the IP Deskphone.

Note: **Manual** means that the message is cleared from the idle screen only after you look at the call detail for every newly missed call in the Inbox.

Initiating a call from the Call Inbox

When you receive a call that is missed or answered, the calling number is listed in the Inbox. You can select the number, and then dial from the Inbox, or you can edit the number in the Inbox.

To initiate a call from the Call Inbox, press the **Msg/Inbox** fixed key and select **Inbox** from the menu.

Note 1: If your service provider requires that a Directory Number (DN) be used to initiate a call, the Call Inbox entry must have the DN to initiate a call.

Note 2: While you are on a call, you can initiate a new call from the Call Inbox. For more information, see [“Accessing the calls in your Call Inbox during a call” on page 173.](#)

To initiate a call from the Call Inbox:



Msg/Inbox

1. Press the **Msg/Inbox** fixed key.



2. Press the **Up/Down** navigation key to highlight a call from the list of calls in your Call Inbox.



3. To view details of the call, press the **Right** navigation key.

4. To place a call to the selected address, do one of the following:

- Lift the handset.
- Press the **Headset** fixed key.
- Press the **Handsfree** fixed key.



Edit



Call



or

Press the **Edit** context-sensitive soft key

Then press the **Send** context-sensitive soft key.

Deleting calls in your Call Inbox

When you delete calls from the Call Inbox, both missed calls and answered calls are deleted. When you view the missed calls and select delete, only the missed calls are deleted.

To delete calls from your Call Inbox:



Delete



1. Press the **Up/Down** navigation key to highlight a call from the list of calls in your Call Inbox.
2. Press the **Delete** context-sensitive soft key.

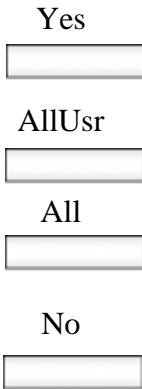

3. Select one of the following context-sensitive soft keys:
 - Press the **Yes** context-sensitive soft key to delete the highlighted call.
 - Press the **AllUsr** context-sensitive soft key to delete all the calls from the selected caller.
 - Press the **All** context-sensitive soft key to clear all calls from the Call Inbox.
 - Press the **No** context-sensitive soft key to return to the Inbox.

Accessing the calls in your Call Inbox during a call

You can access the calls in your Call Inbox while you are in an active call.

To access the calls in your Call Inbox during a call:



1. Press the **Up/Down** navigation key to highlight a call from the list of calls in your Call Inbox.
2. Choose one of the following:
 - Press the **Select** context-sensitive soft key to initiate a call to the highlighted caller.

Note: This places the current call on hold, if it is not already on hold.

 - Press the **Back** context-sensitive soft key to return to the in-call screen.

Call Outbox

The Call Outbox keeps a record of all outgoing calls made from your IP Deskphone. You can add the contact details of the calls in your outbox to your Address Book. You can access the following details about the outgoing calls:

- Name
- Address
- Time of the call
- Number of Calls
- Call Subject (when used for a call)

Figure 28 on page 174 shows details of the Call Outbox screen while the IP Deskphone is idle.

Figure 28: Call Outbox while IP Deskphone is idle

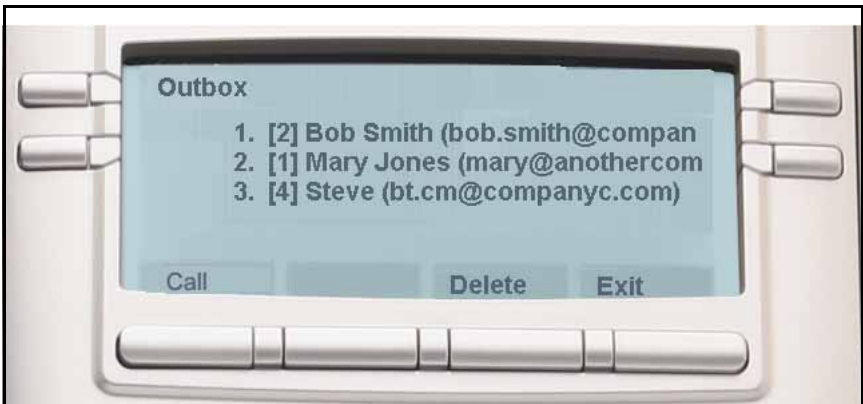

Accessing the Call Outbox

You can access the Call Outbox and initiate a call when the IP Deskphone is:

- Idle. For more information, see [“Initiating a call from the Call Outbox” on page 176](#).
- Active. For more information, see [“Accessing the calls in your Call Outbox during a call” on page 179](#).

Managing calls in the Call Outbox while not on a call

You can manage calls in the Call Outbox while you are not in an active call.

To manage calls in the Call Outbox while not on a call:



Shift/Outbox

1. Press the **Outbox** fixed key.



2. Press the **Up/Down** navigation key to highlight a call from the list of calls in your Call Outbox.



3. Choose one of the following:
 - To view details of the selected call, press the **Right** navigation key. See [“Viewing the details of a call in the Call Inbox” on page 167](#).
 - To leave the detail view and return to the main inbox screen, press the **Left** navigation key.

Delete



Exit



4. Press the **Delete** context-sensitive soft key to delete the highlighted call. For more information, see [“Deleting calls from your Call Outbox”](#) on page 177.
5. Press the **Exit** context-sensitive soft key to return to the idle screen.

Initiating a call from the Call Outbox

Note: If your service provider requires that a Directory Number (DN) be used to initiate a call, the Call Outbox entry must have a DN to initiate a call.

To initiate a call from the Call Outbox:



Shift/Outbox

1. Press the **Outbox** fixed key.



2. Press the **Up/Down** navigation key to highlight a call from the list of calls in your Call Outbox.



3. To view details of the selected call, press the **Right** navigation key. See [“Viewing the details of a call in the Call Outbox”](#) on page 178.

- You can initiate a call from the highlighted call of the Call Outbox list or from the details of a caller screen, by doing one of the following:



- Lift the handset.
- Press the **Headset** fixed key.
- Press the **Handsfree** fixed key.

Call



- Press the **Call** context-sensitive soft key.

Deleting calls from your Call Outbox

You can delete calls from your Call Outbox.

To delete calls from your Call Outbox:



- Press the **Up/Down** navigation key to highlight a call from the list of calls in your Call Outbox.

Delete



- Press the **Delete** context-sensitive soft key.

Yes

AllUsr

All

No

3. Select one of the following context-sensitive soft keys:

- Press the **Yes** context-sensitive soft key to delete the highlighted call.
- Press the **AllUsr** context-sensitive soft key to delete all the calls from the selected caller.
- Press the **All** context-sensitive soft key to clear all calls from the Call Outbox.
- Press the **No** context-sensitive soft key to return to the Outbox.

Viewing the details of a call in the Call Outbox

You can view details of a call in the Call Outbox.

To view details of a call in the Call Outbox:



Call



Prev



Next



Back

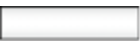

1. To view details of the selected call, press the **Right** navigation key
2. When you view the details of a call in the Call Outbox you can do one of the following:
 - Initiate a call to the caller displayed on the screen. See [“To initiate a call from the Call Outbox:”](#) on page 176.
 - View a previous caller in the Call Outbox list by pressing the **Prev** context-sensitive soft key and return to the **Outbox** screen.
 - View the next caller in the Call Outbox list by pressing the **Next** context-sensitive soft key and return to the **Outbox** screen.
 - Press the **Back** context-sensitive soft key to return to the Outbox.

Accessing the calls in your Call Outbox during a call

You can access the calls in your Call Outbox during an active call.

To access the calls in your Call Outbox during a call:



Shift/Outbox

1. To access the calls in your Call Outbox during a call, press the **Call Outbox** key



Select

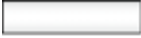

Back



2. Press the **Up/Down** navigation key to highlight a call from the list of calls in your Call Outbox.

3. Choose one of the following:

- Press the **Select** context-sensitive soft key to initiate a call to the highlighted caller.

Note: This places the current call on hold, if it is not already on hold.

- Press the **Back** context-sensitive soft key to return to the **Incall** screen.

Instant Messaging

You can use your IP Deskphone to send and receive an Instant Message (IM). You can access and respond to an IM while on a call. The blue LED (Feature Status Indicator) at the top left of the IP Deskphone lights accompanied by a beep when a new IM arrives.

Configuring Instant Messaging

You can configure your IP Deskphone settings to manage an incoming IM.

- Enable or disable the automatic pop-up of a new IM.
- Enable or disable an audible alert on a new IM.

Configuring IM automatic pop-up

You can configure the IP Deskphone to automatically display an incoming new IM as a pop-up. The IM pops up when the IP Deskphone is idle or while on a call. You can disable the IM pop-up feature.

Note: An IM pop-up does not occur if you are navigating the IM screens or navigating the menu structure in general. When this exception occurs, the IM goes directly to the IM Inbox, and the blue LED activates.

Figure 29 on page 182 shows the IM pop-screen on the Avaya 1120E IP Deskphone.

Figure 29: Instant Message pop-up

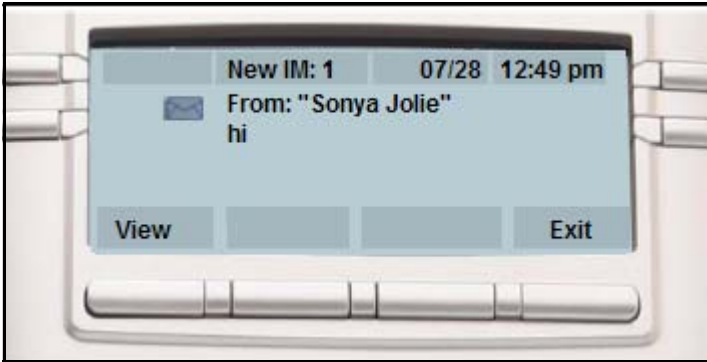

When an IM pop-up appears you can do the following:

- Press the **View** context-sensitive soft key to view the complete details of the IM.
- Press the **Prev** context-sensitive soft key to skip to a previous IM (if applicable).
- Press the **Next** context-sensitive soft key to skip to the next IM (if applicable).
- Press the **Exit** context-sensitive soft key, the **Goodbye** fixed key, or **Quit** fixed key to exit the IM pop-up screen and return to the idle screen when you are not on a call or to the In Call screen if the pop-up occurred during a call.

Configuring Instant Messaging pop-ups

You can configure Instant Messaging pop-ups.

To enable or disable automatic pop-up of a new IM:



1. Press the **Prefs** context-sensitive soft key, select **User Settings, IM Settings, IM Display: On/Off** from the menu.



Select



On



Back



2. Press the **Up/Down** navigation key to select the user (if multiple users are logged into the same deskphone).
3. Press the **Select** context-sensitive soft key.
4. Choose one of the following:
 - Press the **On/Off** context-sensitive soft key to toggle between enabling IM pop-ups or disabling IM pop-ups.
 - Press the **Back** context-sensitive soft key to return to the previous menu.

Configuring IM audible alert

You can configure the IP Deskphone to audibly alert you when a new IM arrives. The IP Deskphone audibly alerts you when the IP Deskphone is idle or while on a call. You can also choose to disable the audible alert of the IM feature.

To enable or disable the audible alerts of a new IM:

Prefs



Select

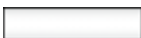

- Press the **Prefs** context-sensitive soft key, select **Message Options**, select **IM Settings**, and then select **IM Audible Alert: On/Off** from the menu.
5. Press the **Select** context-sensitive soft key.

On

Back

6. Choose one of the following:
 - Press the **On/Off** context-sensitive soft key to toggle between enabling IM audible alerts or disabling IM audible alerts.
 - Press the **Back** context-sensitive soft key to return to the previous menu.

Composing an Instant Message

When you compose an IM, enter the address of the recipient and then enter the message. When you reply to an Instant Message, the IP Deskphone automatically enters the address. For more information, see [“Replying to an Instant Message” on page 188](#). You can also send an IM directly from the Address Book. For more information, see [“Viewing the Address Book” on page 145](#).

To compose and send an Instant Message:

Msgs



Expand

Send IM

1. Do one of the following:
 - Press the **Msgs** context-sensitive soft key, select **Instant Messaging**, and press the **New IM** context-sensitive soft key
 - Access the list of IMs by pressing the **Expand** fixed key.
 - To compose an IM from the Avaya 1120E IP Deskphone Address Book, select an address and press the **Send IM** context-sensitive soft key.

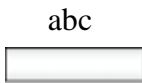

2. Press the **abc/123** context-sensitive soft key to toggle between numeric and alphabetic input.



3. Use the dialpad to enter the address of the contact.



4. Choose one of the following:

- Press the **Next** context-sensitive soft key to continue.
- Press the **Back** context-sensitive soft key to return to the previous menu.



5. Use the dialpad to enter the content of the message.



6. Choose one of the following:

- Press the **Send** context-sensitive soft key to send the IM to the contact.
- Press the **Back** context-sensitive soft key to return to the previous menu without sending the new IM.



Instant Message Inbox/Outbox

The IM Inbox contains a list of all incoming and outgoing Instant Messages. You can filter the IM list to track a series of correspondence to

a contact. The lit blue LED indicates the arrival of a new IM. An icon indicates the status of the IMs in your Instant Message Inbox/Outbox as follows:

Unread 

Read 

Replied to 

Sent No icon

Accessing Instant Messages

You can access and view the contents of the Instant Message Inbox/Outbox.

To access and view the contents of the Instant Message Inbox/Outbox:

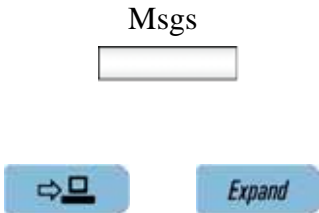

1. Choose one of the following:
 - Press the **Msgs** context-sensitive soft key, and then select **Instant Messaging** from the menu.
 - Press the **Expand** fixed key.



User



View



New IM



Back



2. Press the **Up/Down** navigation key to highlight an IM from the list of Instant Messages in your IM Inbox/Outbox.

Note: When you want to view only IMs from a specific contact, press the **User** context-sensitive soft key to filter all IMs based on the IM that you highlight. The LCD screen shows the list of all IMs from that contact.

3. Choose one of the following:

- Press the **View** context-sensitive soft key to view the details of the sender, followed by the message content. For more information, see [“Viewing the content of an Instant Message” on page 188](#).
- Press the **New IM** context-sensitive soft key to compose a new IM. For more information, see [“Composing an Instant Message” on page 184](#).
- Press the **Back** context-sensitive soft key to return to the idle screen.

Viewing the content of an Instant Message

When you view the content of an Instant Message, you can do the following:

- Reply to the Instant Message. See [“Replying to an Instant Message” on page 188](#).
- Initiate a Call to the contact. See [“Initiating a call from an Instant Message” on page 189](#).
- Delete the Instant Message. See [“Deleting an Instant Message” on page 190](#).

Replying to an Instant Message

You can reply to an Instant Message.

To reply to an Instant Message:

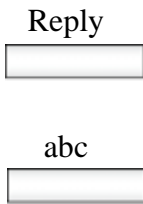

1. Press the **Reply** context-sensitive soft key to send an IM in response to the IM you are viewing.
2. Press the **abc/123** context-sensitive soft key to toggle between numeric and alphabetic input.
3. Enter the message you want to send as a reply.

Send



Back



4. Choose one of the following:
 - Press the **Send** context-sensitive soft key to send the IM when it is complete.
 - Press the **Back** context-sensitive soft key to return to the previous menu and not send the IM.

Initiating a call from an Instant Message

To initiate a call from the IM Inbox, press the **Expand** fixed key or press the **Msgs** context-sensitive soft key, and then select **Instant Messaging** from the menu.

Note: If your service provider requires that a Directory Number (DN) be used to initiate a call, you cannot initiate a call from an Instant Message.

To initiate a call from an Instant Message:

Msgs



1. Choose one of the following:
 - Press the **Msgs** context-sensitive soft key, and then select **Instant Messaging** from the menu.
 - Press the **Expand** fixed key.
2. Press the **Up/Down** navigation key to highlight an IM from the list of Instant Messages.

View



3. Press the **View** context-sensitive soft key to access the IM.

Call



4. To initiate a call to the contact who sent you an IM, press the **Call** context-sensitive soft key.

The IP Deskphone goes off-hook and initiates the call.

Deleting an Instant Message

To delete a single IM, all the IMs from one contact, or all the IMs in your IM Inbox complete the necessary steps in the following procedure.

Msgs



1. Choose one of the following:
 - Press the **Msgs** context-sensitive soft key, and then select **Instant Messaging** from the menu.
 - Press the **Expand** fixed key.

View



2. Press the **View** context-sensitive soft key.

Delete



Back

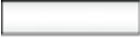

3. Select one of the following context-sensitive soft keys:
 - Press the **Delete** context-sensitive soft key to clear all IMs from the IM Inbox/Outbox.
 - Press the **Back** context-sensitive soft key to return to the previous screen.

While on an active call

You can use the following features during an active call:

- [“Making a new call” on page 192](#)
- [“Placing a call On Hold” on page 194](#)
- [“Using 3-way calling” on page 202](#)
- [“Transferring a call” on page 209](#)
- [“Using Park Call” on page 213](#)

You can use the **Action** context-sensitive soft key to perform the following actions with an active call:

1. **New Call**—to begin a new call while other calls are on hold.
2. **Release Call**—to release (hang-up) the selected call.
3. **Transfer Call**—to transfer the call to another phone number or SIP address.
4. **Park Call**—to park a call on the call server or to a specific user. You can access the call from any IP Deskphone and to keep your phone line clear. (Not available for all service providers.)

Making a new call

You can initiate a new call during a current call. If you do not place the current call on hold first, the IP Deskphone automatically places the current call on hold when you initiate a new call. You can initiate a new call by using any of the following methods:

- [“Initiating a call using the active call context-sensitive soft key menu” on page 193](#)
- [“Initiating a call from the Address Book” on page 146](#)
- [“Initiating a call from the Call Inbox” on page 171](#)
- [“Initiating a call from the Call Outbox” on page 176](#)

Initiating a call using the active call context-sensitive soft key menu

You can initiate a call using the active call context-sensitive soft key menu.

To initiate a call using the active call context-sensitive soft key menu:

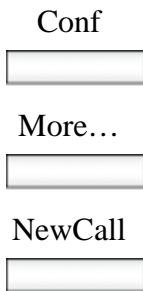

1. Choose one of the following:
 - Press the **Conf** context-sensitive soft key while on a call.
 - While on a call, press the **More...** context-sensitive soft key, and then the **NewCall** context-sensitive soft key.

The IP Deskphone produces a dial tone.



2. Choose one of the following:
 - Use the dial pad to dial the number or SIP address.

Note: This places the current call on hold, if it is not already on hold, and you can continue to initiate the call as normally.



- Press the **Back** context-sensitive soft key to return to the in-call screen.

Call Waiting

While you are on an active call and you receive an incoming call. You are notified of an incoming call by a message on the LCD screen and a notifying beep. Answering the new call places the active call on hold you

can also redirect the new call, decline the new call, transfer the new call, or ignore the new call. For more information, see [“Receiving a call” on page 133](#).

Placing a call On Hold

Use the Hold feature when you are talking to one contact and want to perform another action, such as answer a new incoming call, transfer a call, or initiate a new call. You can have a number of calls on hold at the same time.

To place a call on hold:



1. Press the **Hold** fixed key.

The LCD on hold icon flashes beside the line on hold.

[Figure 30 on page 194](#) shows the IP Deskphone display area when a call is placed on hold.

Figure 30: Call On Hold

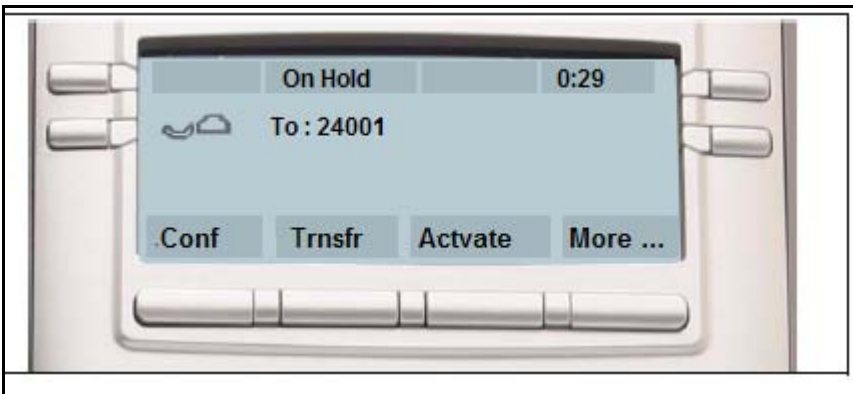

To retrieve a call on hold:

chad



1. To retrieve a call on hold do one of the following:

- Press the **Line** feature key beside the flashing LCD indicator.
- Press the **Hold** fixed key.



Multiple calls On Hold

When you have more than one call on hold, use the navigation key to highlight a call on the LCD screen. You can perform an action with that call by using the context-sensitive soft keys on the In-call menu list. The context-sensitive soft keys displayed vary depending on the type of call that is currently selected. For example, a held call has the **Activate** context-sensitive soft key instead of the **Audio** context-sensitive soft key.

When you highlight a call that is not active, you can retrieve the call from on hold and make it active by pressing the **Activate** context-sensitive soft key. You can also join the call with the active call to create a 3-way calling session. See [“Using 3-way calling” on page 202](#).

Multiple calls In-call mode

When the IP Deskphone has multiple calls connected at the same time, you can access the menu items shown in [Figure 31 on page 195](#).

Figure 31: Multiple calls In-call display screen with context-sensitive soft key menu list



The **Join** context-sensitive soft key appears when there are multiple calls on the IP Deskphone that can be joined for a conference call or 3-way calling.

context-sensitive soft keys for the multiple calls In-call display screen

Join



Press the **Join** context-sensitive soft key to join the eligible calls.

NewCall



Press **NewCall** context-sensitive soft key to obtain a dial tone to place another call. The **NewCall** context-sensitive soft key is used to make a conference call. This key behaves like the **Conf** context-sensitive soft key.

Audio/Activate



Press the **Audio** context-sensitive soft key to change the audio settings or the current active call.

The **Activate** context-sensitive soft key appears when the highlighted call is not the selected call.

Press the **Activate** context-sensitive soft key to place the current call on hold and activate the call you want to connect to.

This context-sensitive soft key is also used to retrieve calls parked against the user.

Note: The **Activate** context-sensitive soft key never appears at the same time as the **Audio** context-sensitive soft key

more...

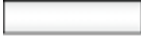

Press the **more...** context-sensitive soft key to select a new menu list of context-sensitive soft keys.

When you press the **more...** context-sensitive soft key, a different selection of context-sensitive soft keys appears.

- If you press the **more...** context-sensitive soft key once from the first menu list, you access the following context-sensitive soft keys:

[Trnsfer] [RlsCall] [Park] [more...]

- If you press the **more...** context-sensitive soft key from the first menu list twice, you access the following context-sensitive soft keys:

[Retrve] [Conf] [Prefs] [more...]

- If you press the **more...** context-sensitive soft key from the first menu list three times, you return to the first menu list with the following context-sensitive soft keys.

[Join] [NewCall] [Audio] [more...]

When you press the **more...** context-sensitive soft key for the first time, the following context-sensitive soft keys appear on the menu list.

Trnsfer



Press the **Trnsfer** context-sensitive soft key to transfer the current call.

RlsCall



Press the **RlsCall** context-sensitive soft key to release or hang up the highlighted call.

Park



Press the **Park** context-sensitive soft key to park the current call.

more...



Press the **more...** context-sensitive soft key to select a new menu list of context-sensitive soft keys.

The next available menu list contains the following context-sensitive soft keys:

[Retrve] [Conf] [Prefs] [more...]

When you press the **more...** context-sensitive soft key for the second time, the following context-sensitive soft keys appear on the menu list.

Retrve



Press the **Retrve** context-sensitive soft key to retrieve a parked call (by token). See ["Retrieving a Parked Call" on page 214.](#)

Conf



Press the **Conf** context-sensitive soft key to place another call, which can be used for a conference call. This context-sensitive soft key has the same behavior as the **NewCall** context-sensitive soft key.

Prefs



Press the **Prefs** context-sensitive soft key to display the Preferences menu.

The menu items include the following:

1. Display—use to adjust the display settings of the LCD screen.
2. Audio—use to adjust tones and volume settings and to configure a USB headset.
3. Feature Options—use to configure the following:
 - Feature keys
 - Call Decline Reasons
 - Call Ignore Action
 - Call Subjects
 - Call Fwd Notification
 - Answer Mode Settings appear when the Auto Answer Mode is enabled on the IP Deskphone.
4. Language—use to change the interface language.
5. Misc Options—use to access the following options:
 - Alpha Dialing
 - Search Method
 - Incoming Privacy
 - Outgoing Privacy
 - # Ends Dialing
 - Hold Mode: Private
 - Time

Prefs



6. Network—use to access the following:
 - Server Settings
 - Device Settings
 - Diagnostics
 - Disable screensaver
 - Licensing
 - Lock
7. USB Locks—use to lock or unlock the following USB devices:
 - USB Mouse
 - USB Keyboard
 - USB Headset
 - USB flash drive
8. User Settings—use to modify the following:
 - Call Settings
 - IM Settings
 - Voice Mail Settings
 - Change Location

more...



Press the **more...** context-sensitive soft key to return to the first menu list of context-sensitive soft keys.

The next available menu list contains the following context-sensitive soft keys:

[Join] [NewCall] [Audio] [more...]

To access a call on hold when multiple calls are on hold:



1. Press the **Up/Down** navigation key to highlight a call on hold.

Chad



2. To retrieve the highlighted call on hold do one of the following:

- Press the **Line** feature key beside the flashing LCD indicator.
- Press the **Hold** fixed key to retrieve a call on hold.



To make a call on hold the active call:



1. Press the **Up/Down** navigation key to highlight a call on hold.

Activate



2. Press the **Activate** context-sensitive soft key to make the highlighted call on hold the active call.

This removes the call from on hold and automatically places the previous call on hold.

Using 3-way calling

When you have more than one call and you want to join the incoming calls into one call, you can use 3-way calling or create a conference call.

Note: Your system administrator or service provider must enable 3-way calling and conference calls for your IP Deskphone. Contact your service provider or system administrator to determine if this feature is available.

The 3-way Call feature joins two calls on your IP Deskphone into one 3-way call. You and the other two callers can speak together. When you join more than two calls into one call, you must use the conference call feature. Your IP Deskphone manages the 3-way call, and the server manages a conference call. For more information, see [“Configuring a conference call” on page 204](#).

To activate the 3-way Call feature:



1. Press the **Join** context-sensitive soft key with either call, and then select **3-way Call** from the menu.

The IP Deskphone joins the two calls and creates a new call that appears on the LCD screen as [3-way Call]. For more information, see [Figure 32: “3-way Call” on page 203](#).

[Figure 33 on page 206](#) shows the IP Deskphone display screen when a 3-way call is in progress.

Figure 32: 3-way Call



Note 1: If you receive a new call during a 3-way call, you can answer the new call as usual. The IP Deskphone automatically puts the 3-way call on hold. If you want to join the new caller to a 3-way call, you must initiate a conference call with the server and join all callers to the conference call.

Note 2: If the host of a 3-way call presses the hold button, all callers in the 3-way call are put on hold.

Note 3: If the host of a 3-way call presses the Goodbye fixed key or selects Release Call from the Action menu, all calls in the 3-way call are terminated.

Configuring a conference call

When you want to invite three or more callers to a call, you can configure a conference call using the IP Deskphone. The call server handles conference calls. You can join incoming calls to the conference call, or you can join calls that you initiate.

Note: Your system administrator or service provider must enable 3-way calling and conference calls for your IP Deskphone. Contact your service provider or system administrator to determine if this feature is available.

To configure a conference call while on an active call with more than one other caller:



Join



1. Press the **Up/Down** navigation key to highlight one of the calls,
2. Press the **Join** context-sensitive soft key and select **Conference** from the menu.

The calls are joined together as a conference call on the call server.

When you receive a new call while on a conference call, you can answer, ignore, decline, or forward the call as you would any call. You can also initiate a new call while on a conference call in the normal way and return to the conference call after you complete the call. The conference call continues while you are on the other call.

Note: If you press the **Goodbye** key or select **Release** from the Action menu while on the conference call you leave the conference call. The conference call continues with the other callers.

To join a call to an existing conference call:



1. Press the **Up/Down** navigation key to highlight the call you want to join to the conference.

Join



2. Press the **Join** context-sensitive soft key to join the highlighted call to the conference.

Ad hoc conferencing when connecting to the Call Server

This feature allows you to make ad hoc conference calls when you connect to the Call Server.

Note: Your system administrator must enable ad hoc conferencing before you connect to the Call Server.

Press **Server settings**, and then **Domain settings** to open the **Domain** screen. [Figure 33 on page 206](#) shows the view details of the current domain.

Figure 33: Current Domain page

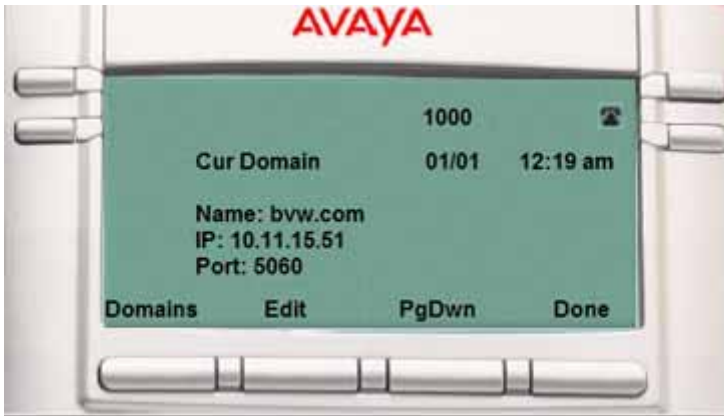

The context-sensitive soft keys available for viewing the conference details of the current domain are as follows:

- **Domains**—to select the domain.
- **Edit**—to edit the conference details.
- **PgDwn**—to move to the next screen containing conference parameters.
- **Done**—to confirm the details.

Figure 34 on page 207 shows the Domain page with conference parameters, including the conference URI and the maximum number of ports available for ad hoc conferencing.

Figure 34: Domain page with conference parameters



The context-sensitive soft keys available on the conference parameters page are as follows:

- **Domains**—to select the domain.
- **Edit**— to open the Edit Domain page that allows you to edit the conference details.
- **Pgup**—to return to the previous page.
- **Done**—to confirm the details.

Edit Domain page

The Edit Domain page displays the domain properties. It appears in the format <conferenceURI> : <Max Ad hoc Ports>.

Note: An admin password is required to access the Edit Domain page.

Figure 35 on page 208 displays the Edit Domain screen with the conference details.

Figure 35: Edit Domain screen

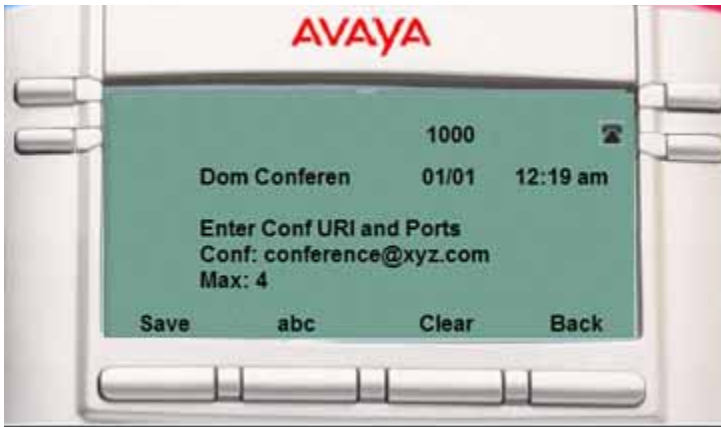

To edit the conference properties and maximum number of ports, press the **Edit** context-sensitive soft key to display the Domain Conference Edit screen.

[Figure 36 on page 208](#) provides an example of the Domain Conference Edit screen.

Figure 36: Domain Conference Edit screen



The context-sensitive soft keys available for the Domain Conference Edit screen are as follows:

- **Save**—to save the updated value to the system configuration file.
- **Abc (/123)**—to toggle the input mode to digits (or alphabets).
- **Clear**—to clear the character behind the cursor.
- **Back**—to return to the previous screen.

Note: For these configuration changes to take effect, you must manually log off and log on.

Transferring a call

Note 1: When more than one call is on hold, the call you want to transfer must be the active call. For more information, see [“To make a call on hold the active call:” on page 201](#).

Note 2: The IP Deskphone does not automatically place the call you want to transfer on hold. To prevent the caller from hearing the transfer process, place the caller on hold and then complete the transfer process.

To transfer a call to another telephone:



1. Press the **Up/Down** navigation key to highlight Transfer Call from the menu.

Transfer



2. Press the **Transfer** context-sensitive soft key while on a call to access the **Transfer** menu.

abc



3. Press the **abc/123** context-sensitive soft key to toggle between numeric and alphabetic input.



Select

Transfr

Clear

Back

4. Choose one of the following:
 - Enter the phone number or SIP address to which you are transferring the call.
 - Select a contact from the Address Book, Call Inbox, or Call Outbox by pressing the corresponding fixed key.
Highlight a contact from the list and then press the **Select** context-sensitive soft key.

5. Choose one of the following:
 - Press the **Transfr** context-sensitive soft key to connect the calling party.
 - To erase the address you enter, press the **Clear** context-sensitive soft key.
 - To return to the previous screen, press the **Back** context-sensitive soft key.

The IP Deskphone prompts you with the following question, Consult with party?

Yes

No

Back

6. Select one of the following context-sensitive soft keys:
 - Press the **Yes** context-sensitive soft key to consult with the contact to which you are transferring the call before completing the transfer.
 - Press the **No** context-sensitive soft key to transfer the call without consulting the contact to whom you want to transfer the call.
 - Press the **Back** context-sensitive soft key to return to the previous screen.

To transfer a call to Voice Mail:

Transfer

abc



1. Press the **Transfer** context-sensitive soft key while on a call to access the Transfer menu.
2. Press the **abc/123** context-sensitive soft key to toggle between numeric and alphabetic input.
3. Enter the Voice Mail ID, extension, or external number by using the dialpad.

toVM



Back



4. Choose one of the following:
 - Press the **toVM** context-sensitive soft key to connect the calling party to Voice Mail.
 - To return to the previous screen, press the **Back** context-sensitive soft key.

Note 1: The Transfer to Voice Mail feature is not available for all call servers. Contact your system administrator or service provider to determine if this feature is available to you.

Note 2: The Transfer to Voice Mail feature during a conference call is dependent on the call server and cannot be allowed. If the secure digits feature is enabled, and you connect to Voice Mail during an active call, the screen displays the last pressed key only, and the remaining digits appear as '*'.

You can press **Hide** or **Unhide** to hide or display the pressed keys.

Note: The Transfer to Voice Mail feature is available only when configured by your system administrator.

Using the Park Call feature

You can use the Park Call feature to temporarily park a call to the call server or to a specific user. You or another user can retrieve the parked call from another phone. Using Park Call does not tie up a line, since it is held on the call server.

Note 1: The Park Call feature is not available for all call servers. Contact your system administrator or service provider to determine if this feature is available to you.

Note 2: The behavior of the Park Call feature varies depending on the call server. This can affect the information appearing on the IP Deskphone.

Note 3: When you park a call to the server, the server returns a retrieval code. You must enter the code to retrieve the call from park.

Using Park Call

The IP Deskphone prompts you with, `Press Park for server or User to park to a user.`

To park a call to the server during a call:

Action

1. Press the **Action** context-sensitive soft and select **Park Call** from the menu.

Park

2. Press the **Park** context-sensitive soft key to park the call to the server.

To park a call to a specific user

User

1. Press the **User** context-sensitive soft key to park the call to a User.

abc



2. Press the **abc/123** context-sensitive soft key to toggle between alphabetic and numeric characters.

3. Use the **Dialpad** to enter the user name to whom you are parking the call.

Park

Clear

Back

4. You can do one of the following:
 - Press the **Park** context-sensitive soft key to park the call to the user and return to the previous menu.
 - Press the **Clear** context-sensitive soft key to erase the input field.
 - Press the **Back** context-sensitive soft key to return to the previous screen.

Retrieving a Parked Call

You must have the retrieval code to retrieve a parked call from the server. You can retrieve a parked call while the IP Deskphone is in the idle state or while on a call.

To retrieve a parked call from the server

Servcs

1. Press the **Servcs** context-sensitive soft key and select **Retrieve Parked Call** from the menu.



Retrve

Clear

Back

2. Use the **Dialpad** to enter the retrieval code of the parked call.

3. You can do one of the following:
 - Press the **Retrve** context-sensitive soft key to retrieve the parked call.

 - Press the **Clear** context-sensitive soft key to erase the input field.

 - Press the **Back** context-sensitive soft key to return to the previous screen.

Additional features

You can use the following additional features:

- [“Using the Friends feature” on page 216](#)
- [“Feature keys” on page 224](#)
- [“Using Call Forward” on page 247](#)
- [“Configuring Do Not Disturb” on page 251](#)
- [“Configuring a Presence state” on page 252](#)
- [“Configuring Privacy settings” on page 255](#)

Using the Friends feature

You can designate a contact you have frequent interaction with as a *friend*. Access your friends list in the Address Book to:

- Check the presence status of a friend. See [“To check the online status of a friend on your list:” on page 217](#).
- Initiate a call to a friend. See [“To initiate a call to a friend on the Friends list:” on page 218](#).
- Send an IM to a friend. See [“To send an IM to a friend on the Friends list:” on page 219](#).
- Edit the information about a friend. See [“To edit your Friends list:” on page 220](#).

Figure 37: Presence status of a friend



Accessing your Friends list

To check the online status of a friend on your list:



Directory

Filter



Select



1. Choose one of the following:
 - Press the **Directory** fixed key.
 - Press the **Filter** context-sensitive soft key, and select **Friends** from the menu.
 - Press the **Select** context-sensitive key.

Status

All

Edit

Exit

2. Do one of the following:
 - Press the **Status** context-sensitive soft key to view the current presence status of the friend.
 - Press the **All** context-sensitive soft key to view the contents of the Address book, including contacts designated as friends and regular contacts.
 - Press the **Edit** context-sensitive soft key to make changes to the information entered for a friend or to delete the contact from the friends list.
3. Press the **Exit** context-sensitive soft key to return to the idle screen.

To initiate a call to a friend on the Friends list:



Directory

Filter

Select

Status

1. Choose one of the following:
 - Press the **Directory** fixed key.
 - Press the **Filter** context-sensitive soft key, and select **Friends** from the menu.
 - Press the **Select** context-sensitive soft key while viewing the Address Book.
2. Press the **Status** context-sensitive soft key to view the information about the friend.

Call

3. Press the **Call** context-sensitive soft key to initiate a call to the friend.

The IP Deskphone uses the SIP address or phone number from your personal Address Book to make the call.

To send an IM to a friend on the Friends list:



Directory

Filter

Select

Status

SendIM

abc

1. Choose one of the following:
 - Press the **Directory** fixed key.
 - Press the **Filter** context-sensitive soft key, and select **Friends** from the menu.
 - Press the **Select** context-sensitive soft key while viewing the Address Book.
2. Press the **Status** context-sensitive soft key to view the information about the friend.
3. Press the **SendIM** context-sensitive soft key to send an IM to the friend.

The IP Deskphone uses the SIP address for the contact from your personal Address Book.
4. Press the **abc/123** context-sensitive soft key to toggle between numeric and alphabetic input.



Send

Back

5. Use the dialpad to enter the text of the message.
6. Choose one of the following:
 - Press the **Send** context-sensitive soft key to send the IM.
 - Press the **Back** context-sensitive soft key to return to the previous menu.

Editing information of a friend

You can edit information of a friend on the Friends list.

To edit your Friends list:



Directory

Filter

Select

1. Choose one of the following:
 - Press the **Directory** fixed key.
 - Press the **Filter** context-sensitive soft key, and select **Friends** from the menu.
 - Press the **Select** context-sensitive key.



Edit



2. Press the **Up/Down** navigation key to highlight the friend you want to edit and press the **Edit** context-sensitive soft key.

abc



3. Press the **abc/123** context-sensitive soft key to toggle between alphabetic and numeric characters.



4. Use the dialpad to enter the new name for the contact.

Next

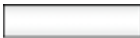

5. Choose one of the following:
 - Press the **Next** context-sensitive soft key to continue.

Back



- Press the **Back** context-sensitive soft key to return to the previous menu.

Delete



- To remove a contact from the Friends list, press the **Delete** context-sensitive soft key. This completely removes the contact from your personal Address Book.



Next

Back

Yes

No

Back

Ok

6. Use the dialpad to enter the new address for the contact.

7. Choose one of the following:
 - Press the **Next** context-sensitive soft key to complete the process.
 - Press the **Back** context-sensitive soft key to return to the previous menu.

8. Choose one of the following:
 - Press the **Yes** context-sensitive soft key, select the group and press the **Select** context-sensitive soft key to add contact to the group.
 - Press the **No** context-sensitive soft key to return to the previous menu without adding contact to the group.
 - Press the **Back** context-sensitive soft key to return to the previous menu.

9. Press the **Ok** contact-sensitive key to return to the friends list.

To delete a contact from your Friends list:



Directory

Friends



Select



Edit



Delete



Ok



Back



1. Choose one of the following:
 - Press the **Directory** fixed key.
 - Press the **Filter** context-sensitive soft key, and select **Friends** from the menu.
 - Press the **Select** context-sensitive soft key while viewing the Address Book.
2. Press the **Up/Down** navigation key to highlight the friend you want to delete and press the **Edit** context-sensitive soft key.
3. Press the **Delete** context-sensitive key. This completely removes the contact from your personal Address Book.
4. Choose one of the following:
 - Press the **Ok** context-sensitive soft key to continue.
 - Press the **Back** context-sensitive soft key to return to the previous menu.

Feature keys

Use the Feature key option to configure the feature keys on IP Deskphone and the Expansion Module for Avaya 1100 Series IP Deskphones.

Programmed keys are stored in the user profile. Each user can maintain a list of programmed feature keys. You can designate a feature key to act as a short cut for any of the following features:

- Speed Dial
- Call Forward
- Do Not Disturb
- Send IM
- Presence

The IP Deskphone designates the feature key on the bottom right of the four feature keys as Feature Key 1 and reserves it as the line key for the IP Deskphone. [Figure 38 on page 224](#) shows the Feature keys.

Figure 38: Feature keys



You can program the feature keys one at a time, or you can automatically program empty feature keys from your Friends list or Address Book. For information about how to autoprogram feature keys see, [“Feature key autoprogramming”](#) on page 240.

[Figure 39 on page 225](#) shows the feature key numbering for 3 Expansion Modules for Avaya 1100 Series IP Deskphones.

Figure 39: Feature key numbering

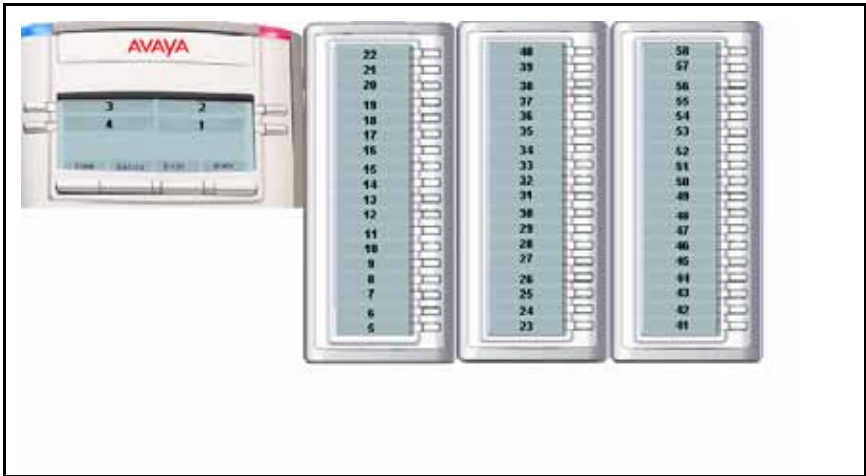

Feature key programming

You can program feature keys.

To access the Program Key screen:



1. Press the **Prefs** context-sensitive soft key, select **Feature Options**, and select **Feature Keys** from the menu.

The **Program Key** screen opens as shown in [“Feature keys”](#) on page 224.

The Program Key screen provides the following context-sensitive soft keys:

- **View**— to access the feature key detail screen.
- **Edit** —to edit the setting or modification of the selected programmable key.
- **Bulk**—to access the autoprogramming and auto removal feature.
- **Back**—to return to the previous screen.

To view feature key details



Back



1. To select a feature key to view, do one of the following:
 - Press the **Up/Down** navigation key to highlight the feature key to view and press the **View** context-sensitive soft key.
 - Press the **Feature** key that you want to view and press the **View** context-sensitive soft key.
 - Use the dialpad to select the **Feature** key that you want to view and press the **View** context-sensitive soft key.

The **Program Key** screen opens as shown in [Figure 40 on page 227](#).

2. Press the **Back** context-sensitive soft key to return to the previous screen.

[Figure 40 on page 227](#) shows the feature key details.

Figure 40: Feature key details



The **Program Key** screen displays the following:

- Key—programmed feature key number
- Label—label used for the feature key
- Service—services programmed to the feature key, such as:
 - Speed Dial
 - Call Forward
 - Do Not Disturb
 - Send IM
 - Presence
- User—current user to whom the programmed feature key is associated
- Address—SIP address for the feature key when programmed for Speed Dial, Call Forward, and Send IM.

Note 1: If you try to view a feature key that is not programmed the IP Deskphone displays the message: Program Key Not Available (Key is empty).

Note 2: If you try to view a feature key that is designated as a line key, the IP Deskphone displays the message: Program Key Not Available (Key is a line key).

To edit a feature key

1. To select a feature key to edit, do one of the following:



- Press the **Up/Down** navigation key to scroll through the feature keys to highlight the one you want to edit and then press the **Edit** context-sensitive soft key.
- Press the **Feature** key that you want to edit and then press the **Edit** context-sensitive soft key.
- Use the dialpad to select the **Feature** key that you want to view and then press the **Edit** context-sensitive soft key.

The **Program Key** screen opens as shown in [Figure 41 on page 229](#).

Back



2. Press the **Back** context-sensitive soft key to return to the previous screen.

[Figure 41 on page 229](#) shows the edit feature key screen.

Figure 41: Edit feature key screen

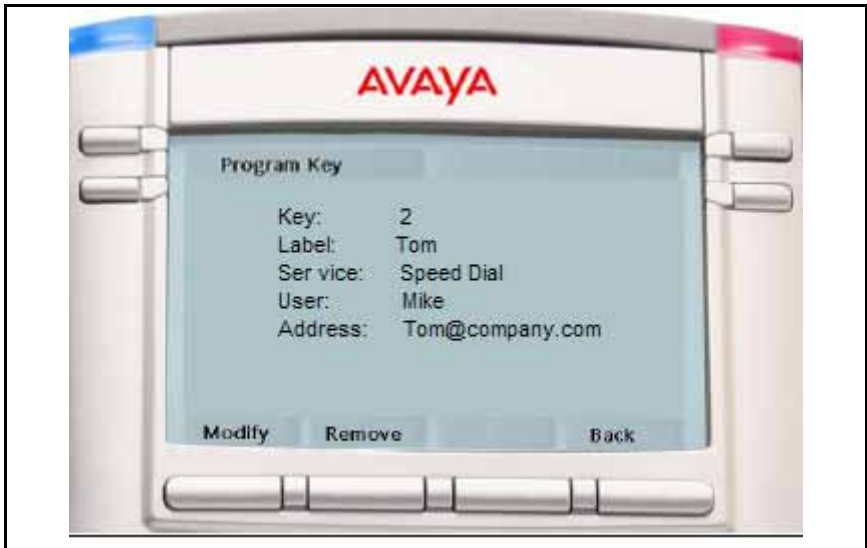

To modify a feature key:



1. Press the **Modify** context-sensitive soft.
The Select Service screen opens.



2. Press the **Up/Down** navigation key to highlight one of the following feature key services:
 - Speed Dial
 - Call Forward
 - Do Not Disturb
 - Send IM
 - Presence

Select



Back



abc



3. Choose one of the following:
 - Press the **Select** context-sensitive soft key to choose a service.

The next screen in the process opens.

- Press the **Back** context-sensitive soft key to return to the previous menu.
4. Press the **abc/123** context-sensitive soft key to toggle between numeric and alphabetic input.
5. Use the dialpad to enter the label for the feature key.

Next



6. Choose one of the following:
 - Press the **Next** context-sensitive soft key to continue. Continue to input information based on the following services:

Speed dial. See [“To program a Speed Dial feature key:”](#) on page 231.

Call Forward. See [“The following procedure continues from Step 6 on page 231.”](#) on page 233.

Do Not Disturb. See [“To program a Do Not Disturb feature key:”](#) on page 234.

Send IM. See [“To program a Send IM feature key:”](#) on page 235.

Presence. See [“To program a Presence feature key:”](#) on page 236.

- Press the **Back** context-sensitive soft key to return to the previous menu.

Back



The following procedure continues from [Step 6 on page 231](#).

To program a Speed Dial feature key:

Select



1. Press the **Select** context-sensitive soft key.
2. Select **Speed Dial**.

Select



3. Press the **Select** context-sensitive soft key.



Next



4. Use the dial pad to enter a key label.

5. Press the **Next** context-sensitive soft key to continue.



Next



6. Use the dial pad to enter an address.

7. Press the **Next** context-sensitive soft key to continue.



Ok



Cancel



8. Use the dial pad to enter a Call Subject associated with the Speed Dial contact. You can leave this blank if you do not want to include a Call Subject.

9. Choose one of the following:
 - Press the **Ok** context-sensitive soft key to confirm the entry and move to the next step.
 - Press the **Cancel** context-sensitive soft key to return to the previous step.

Yes

No

10. Choose one of the following:

- Press the **Yes** context-sensitive soft key to activate auto-retrieve of held call on hang up of speed dial.
- Press the **No** context-sensitive soft key to return to the previous step.

The following procedure continues from [Step 6 on page 231](#).

To program a Call Forward feature key:

1. Select **Call Forward**.



2. Use the dial pad to enter a key label.

Next

3. Press the **Next** context-sensitive soft key to continue.

4. Select a User.

Select

1. Press the **Select** context-sensitive soft key.

2. Use the dial pad to enter the address.



Finish



Clear



Back



3. Choose one of the following:
 - Press the **Finish** context-sensitive soft key to confirm the entry and complete the procedure.
 - Press the **Clear** context-sensitive soft key to erase the entry.
 - Press the **Back** context-sensitive soft key to return to the previous menu.

The following procedure continues from [Step 6 on page 231](#).

To program a Do Not Disturb feature key:

Select



1. Select **Do not disturb**.
2. Press the **Select** context-sensitive soft key.
3. Use the dial pad to enter a key label.
4. Select a User.

Select



1. Press the **Select** context-sensitive soft key.

Finish



Back



2. Choose one of the following:
 - Press the **Finish** context-sensitive soft key to confirm the entry and complete the procedure.
 - Press the **Back** context-sensitive soft key to return to the previous menu.

The following procedure continues from [Step 6 on page 231](#).

To program a Send IM feature key:

Select



Next



1. Select **Send IM**.
2. Press the **Select** context-sensitive soft key.
3. Use the dial pad to enter a key label.
4. Press the **Next** context-sensitive soft key.
5. Use the dial pad to enter an address.

Finish

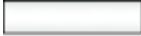

6. Press the **Finish** context-sensitive soft key to continue.

The following procedure continues from [Step 6 on page 231](#).

To program a Presence feature key:



1. Press the **Up/Down** navigation key to highlight one of the following:
 - Connected
 - Unavailable

Select



2. Choose one of the following:
 - Press the **Select** context-sensitive soft key to select Presence.
 - Press the **Back** context-sensitive soft key to return to the previous step.

Back





3. You can choose a more detailed message for other users to see or you can select **None** if you do not want to give additional information.
4. If you chose **Connected** in step 1, press the **Up/Down** navigation key to highlight one of the following details:
 - None
 - Away
 - Out to Lunch
 - Be Right Back

If you chose **Unavailable** in step 1, press the **Up/Down** navigation key to highlight one of the following details:

- None
- Busy
- On vacation
- Offline

Note: You can create your own Presence message to appear on screen, which become available when you program a feature key as a shortcut. For more information, see [“Adding a new Presence state message”](#) on page 254.

Finish



Back



5. Choose one of the following:
 - Press the **Finish** context-sensitive soft key to select the Presence detail and finish the procedure.
 - Press the **Back** context-sensitive soft key to return to the previous step.

Remove a programmed feature key

You can remove a feature key by using one of the following methods:

1. Edit context-sensitive soft keys. See [“To remove a feature key using the Edit context-sensitive soft key:”](#) on page 239.
- Bulk context-sensitive soft keys. See [“To remove all programmed feature keys by using the Bulk context-sensitive soft key:”](#) on page 242.

To remove a feature key using the Edit context-sensitive soft key:



Back



Remove



1. To select a feature key to remove, do one of the following:
 - Press the **Up/Down** navigation key to scroll through the feature keys to highlight one to remove and press the **Edit** context-sensitive soft key.
 - Press the **feature key** that you want to remove and then press the **Edit** context-sensitive soft key.
 - Use the dialpad to select the **Feature** key that you want to view and then press the **Edit** context-sensitive soft key.

The **Program Key** screen opens as shown in [Figure 41 on page 229](#).

2. Press the **Back** context-sensitive soft key to return to the previous screen.
3. Press the **Remove** context-sensitive soft.

The IP Deskphone displays *Confirm Remove key?*

Yes

No

4. Choose one of the following:

- Press the **Yes** context-sensitive soft key to confirm the removal of the feature key.
- Press the **No** context-sensitive soft key to return to the previous screen without removing the feature key.

Feature key autoprogramming

The feature key autoprogramming provides the user with the ability to cause the IP Deskphone to detect all unused programmable keys, and to automatically fill them as Speed Dial keys, Send IM keys, or Call Forwarding keys using the user Friends list or the user Address Book. The feature key autoprogramming also provides the user with the ability to remove all programmed feature keys from the IP Deskphone.

Autoprogramming does not overwrite feature keys already programmed and when the IP Deskphone detects if a feature key is already configured with Speed Dial, Send IM, or Call Forward for contact, it does not create a new instance.

Note: The autoprogramming feature options are dependent on your service provider and IP Deskphone configuration. If you attempt to use the autoprogram feature (**Bulk** context-sensitive soft key) for a feature that is not available to you, the IP Deskphone displays the message: `This feature is disabled. Contact your provider.`

To autoprogram feature keys:

Prefs

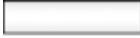

1. Press the **Prefs** context-sensitive soft key, select **Feature Options**, and select **Feature Keys** from the menu.

The **Program Key** screen opens as shown in, [Figure 38 on page 224](#).

Bulk



2. Choose one of the following:
 - Press the **Bulk** context-sensitive soft key.
 - Press the **Back** context-sensitive soft key to return to the previous step.

Back



3. Press the **Up/Down** navigation key to highlight one of the following services that you want to autoprogram:
 1. Speed Dial
 2. Send IM
 3. Call Forward

Select



1. Speed Dial
2. Send IM
3. Call Forward

Select



4. Choose one of the following:
 - Press the **Select** context-sensitive soft key to autoprogram the feature keys with the selected service.
 - Press the **Back** context-sensitive soft key to return to the previous step.

Back



To remove all programmed feature keys by using the Bulk context-sensitive soft key:

Bulk



Back



Select



All



Yes



No



5. Choose one of the following:
 - Press the **Bulk** context-sensitive soft key.
 - Press the **Back** context-sensitive soft key to return to the previous step.

6. Press the **Up/Down** navigation key to highlight **2. Feature key removal** and press the **Select** context-sensitive soft.
The **Program Key** screen opens listing all the feature keys.

7. Press the **All** context-sensitive soft key to remove all the programmed feature keys.

8. Choose one of the following:
 - Press the **Yes** context-sensitive soft key to confirm the removal of all the feature keys.
 - Press the **No** context-sensitive soft key to return to the previous screen without removing the feature keys.



Back



9. To select a single feature key to remove, do one of the following:
- Press the **Up/Down** navigation key to scroll through the feature keys and highlight the feature key to remove and press the **Remove** context-sensitive soft key.
 - Press the **Feature** key that you want to remove and press the **Remove** context-sensitive soft key.
 - Use the dialpad to select the **Feature** key that you want to view and press the **Remove** context-sensitive soft key.

or

Press the **Back** context-sensitive soft key to return to the previous menu.

To remove individual programmed feature keys using the Bulk context-sensitive soft key:

Bulk



Back



10. Choose one of the following:
- Press the **Bulk** context-sensitive soft key.
 - Press the **Back** context-sensitive soft key to return to the previous step.



Select



All



Yes



Or

No



11. Press the **Up/Down** navigation key to highlight **2. Feature key removal** and press the **Select** context-sensitive soft.

The **Program Key** screen opens listing all the feature keys.

12. Press the **All** context-sensitive soft key to remove all the programmed feature keys.

13. Choose one of the following:

- Press the **Yes** context-sensitive soft key to confirm the removal of all the feature keys.
- Press the **No** context-sensitive soft key to return to the previous screen without removing the feature keys.



Back



14. To select a single feature key to remove do one of the following:

- Press the **Up/Down** navigation key to scroll through the feature keys to highlight one and press the **Remove** context-sensitive soft key.
- Press the **Feature** key that you want to remove and then press the **Remove** context-sensitive soft key.
- Use the dialpad to select the **Feature** key that you want to view and then press the **Remove** context-sensitive soft key.

or

Press the **Back** context-sensitive soft key to return to the previous menu.

Creating a feature key using the Copy key

You can create a feature key for Speed Dial, Call Forward, or Send IM by pressing the **Copy** fixed key when you are viewing any of the following:

- a highlighted entry in an Address Book list
- a highlighted entry of your Call Inbox or Call Outbox

To designate a feature key by using the Copy key:



1. Open your Address Book, Call Inbox, or Call Outbox, highlight the entry you want to use for the feature key, and then press the **Copy** key.



2. Press the **Up/Down** navigation key to highlight Speed Dial, Call Forward, or Send IM from the menu.

Note: Presence and Do Not Disturb are not programmable by using the **Copy** key.

Select



3. Press the **Select** context-sensitive soft key.



Set



4. Choose one of the following:
 - Press the **Up/Down** navigation key to highlight the feature key to which to copy the information to and press **Set**.
 - Press the **Feature** key that you want to use for the service selected.



5. Use the dialpad to enter the label for the feature key.

Next



6. Press the **Next** context-sensitive soft key to continue. Continue to input information based on the selected service:

- “To program a Speed Dial feature key:” on page 231
- “To program a Call Forward feature key:” on page 233
- “To program a Send IM feature key:” on page 235
- “To program a Presence feature key:” on page 236

or

Back



Press the **Back** context-sensitive soft key to return to the previous menu.

Using Call Forward

Use the Call Forward feature to direct incoming calls to an alternate destination. You can continue to make calls from the IP Deskphone but all incoming calls are redirected to the new destination.

When you forward a call to another IP Deskphone, the IP Deskphone receives the call displays the name and SIP address (if present) of the caller, the name and SIP address (if present) of the original called party, and any subject message included with the call. This ensures that the user who receives the forwarded call knows that the call is forwarded from you, who the call is from, and any subject message that is included.

Note: Not all service providers display forwarded calls as described. Contact your system administrator or service provider for more information about Call Forward.

Figure 42 on page 248 shows the incoming call display for an incoming call.

Figure 42: Incoming call display for a forwarded call

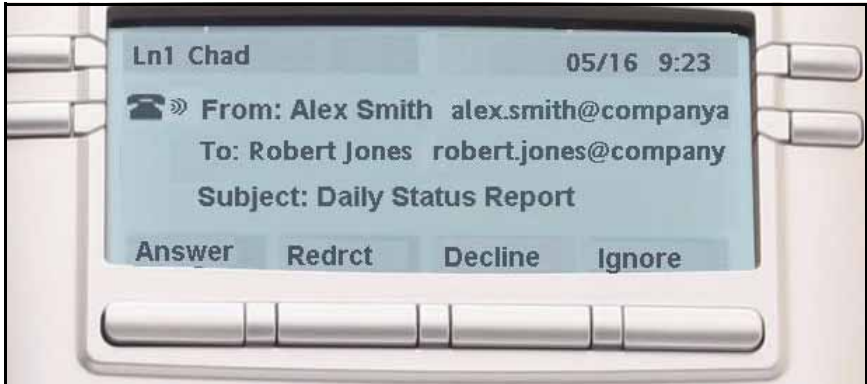

When the address or subject line is long, you can scroll by using the left and right navigation keys.

Table 17 on page 248 describes the Privacy setting and the display for a forwarded call on the IP Deskphone.

Table 17: Privacy setting and IP Deskphone display for Call Forward (Part 1 of 2)

Privacy setting	IP Deskphone display
None	From: Robert (robert@companyb.com) To: Alice (alice@companya.com) Subject: Calling to discuss budget.
All	From: Anonymous To: Alice (alice@companya.com) Subject: Calling to discuss budget.
Address	From: Robert To: Alice (alice@companya.com) Subject: Calling to discuss budget.

Table 17: Privacy setting and IP Deskphone display for Call Forward (Part 2 of 2)

Privacy setting	IP Deskphone display
Name	From: robert@companyb.com To: Alice (alice@companya.com) Subject: Calling to discuss budget.

When you forward your calls to another user or IP Deskphone, you have the option to program the IP Deskphone to remind you that incoming calls can be forwarded. This notification is an audible signal you hear when you go off hook and a change to the ring pattern when a call is incoming.

To activate or deactivate this notification:

Prefs

1. Press the **Prefs** context-sensitive soft key, select **Feature Options**, and select **Call Fwd Notification** from the menu.

On

1. Choose one of the following:
 - Press the **On** context-sensitive soft key to activate Call Forward Notification

Off

- If the Call Forward Notification is activated you press the **Off** context-sensitive soft key to deactivate the feature.

Note: If the IP Deskphone is ringing or is in Do Not Disturb mode, you cannot forward the call.

To forward your calls or change the number where calls are forwarded:

CallFwd



1. Press the **CallFwd** context-sensitive soft key.

2. Enter the phone number or SIP address where you want to forward your calls.

Forwrd

Clear

Back

3. Choose one of the following:
 - Press the **Forwrd** context-sensitive soft key to accept the number and return to the Services Menu.
 - Press the **Clear** context-sensitive soft key to clear the input line.
 - Press the **Back** context-sensitive soft key to cancel the input and return to the Services menu.

To deactivate Call Forward:

Disable

Back

1. Choose one of the following:
 - Press the **Disable** context-sensitive soft key to deactivate Call Forward and return to the Services Menu.
 - Press the **Back** context-sensitive soft key to cancel deactivating the Call Forward and return to the Services menu.

Configuring Do Not Disturb

Use Do Not Disturb to automatically block all incoming calls. When you activate this feature, the calling party receives a busy signal.

To enable Do Not Disturb:

DND

1. Press the **DND** context-sensitive soft key on the idle display (press the **More...** context-sensitive soft key until **DND** appears).

Enable

2. Choose one of the following:
 - Press the **Enable** context-sensitive soft key to configure the IP Deskphone to Do Not Disturb.
 - Press the **Back** context-sensitive soft key to return to the previous menu.

Back

Ok

3. Press the **Ok** context-sensitive soft key to return to the Services menu.

To disable Do Not Disturb:

Disable

1. Choose one of the following:
 - Press the **Disable** context-sensitive soft key to configure Do Not Disturb.
 - Press the **Back** context-sensitive soft key to return to the previous menu.

Back

Ok



2. Press the **Ok** context-sensitive soft key to return to the Services menu.

Configuring a Presence state

You can configure a presence state to enable other users to see information about your availability. You can select from a list of pre-made messages or create a new message to display for your presence state.

To select a Presence state:

Presnce



1. Press the **Presnce** context-sensitive soft key (press the **More...** context-sensitive soft until **Presnce** appears).

Change



Back



2. Choose one of the following:
 - Press the **Change** context-sensitive soft key to change your current presence state.
 - Press the **Back** context-sensitive soft key to return to the **Services** menu.



3. Press the **Up/Down** navigation key to highlight either:
 - Connected
 - Unavailable

Select



Back



4. Choose one of the following:
 - Press the **Select** context-sensitive soft key to continue to the next screen.
 - Press the **Back** context-sensitive soft key to return to the previous step.

You can choose a more detailed message for other users to see, or you can select **None** if you do not want to provide additional information.



5. If you chose **Connected** in step 2, press the **Up/Down** navigation key to highlight one of the following details:
 - None
 - Away
 - Out to Lunch
 - Be Right Back

If you chose **Unavailable** in step 2, press the **Up/Down** navigation key to highlight one of the following details:

- None
- Busy
- On vacation
- Offline

Note: You can create your own Presence messages to appear on screen, which become available when you program a feature key as a shortcut.

Select

Add

Back

OK

6. Choose one of the following:
 - Press the **Select** context-sensitive soft key to select the Presence detail and move to the confirmation screen.
 - Press the **Add** context-sensitive soft key to enter a custom note. For more information, see [“Adding a new Presence state message” on page 254](#).
 - Press the **Back** context-sensitive soft key to return to the previous step.

7. Press the **OK** context-sensitive soft key to confirm the Presence state selection.

Adding a new Presence state message

You can add a new Presence state message.

To add a new Presence state message:

Presnce

Change

1. Press the **Presnce** context-sensitive soft key (press the **More....** context-sensitive soft key until **Presnce** appears).
2. Press the **Change** context-sensitive soft key.
3. Select **Connected** or **Unavailable** from the menu.

Add



4. Press the **Add** context-sensitive soft key.

abc



5. Press the **abc/123** context-sensitive soft key to toggle between alphabetic and numeric characters.



6. Use the **Dialpad** to enter a new Presence state message.

Ok



7. Choose one of the following:

- Press the **Ok** context-sensitive soft key to confirm the entry and complete the procedure.

Back



- Press the **Back** context-sensitive soft key to return to the previous step.

Configuring Privacy settings

You can restrict caller information coming to the IP Deskphone or caller information leaving the IP Deskphone. You can restrict the name, SIP address, or both from appearing on the screen.

Incoming call privacy

You can restrict the information for incoming calls to your IP Deskphone by configuring the Incoming Call Privacy setting.

To configure Incoming Call Privacy:

Prefs



1. Press the **Prefs** context-sensitive soft key, select **Misc Options**, and then **Incoming Privacy** from the menu.



2. Press the **Up/Down** navigation key to highlight one of the following:
 - None (no restriction)
 - Name (restricts only the name)
 - Address (restricts only the address)
 - All (restricts name and number)

Change



3. Choose one of the following:
 - Press the **Change** context-sensitive soft key to change the Incoming Privacy restriction to the highlighted restriction.

Back



- Press the **Back** context-sensitive soft key to return to the previous menu without implementing any changes.

Outgoing call privacy

You can restrict the information for outgoing calls from your IP Deskphone by configuring the Outgoing Call Privacy setting.

To configure Outgoing Call Privacy:

Prefs



1. Press the **Prefs** context-sensitive soft key, select **Misc Options**, and then **Outgoing Privacy** from the menu.



2. Press the **Up/Down** navigation key to highlight one of the following:
 - None (no restriction)
 - Name (restricts only the name)
 - Address (restricts only the address)
 - All (restricts name and number)

Change



3. Choose one of the following:
 - Press the **Change** context-sensitive soft key to change the Outgoing Privacy restriction to the highlighted restriction.
 - Press the **Back** context-sensitive soft key to return to the previous menu without implementing any changes.

Back



Multiple Appearance Directory Number

Multiple Appearance Directory Number (MADN), also known as Bridge Line Appearance, and using Single Call Appearance (SCA) allows multiple IP Deskphones to appear as a single line to the caller. Any of the IP Deskphones with an active MADN feature can initiate or answer a call, but only one call can be active at a time. However, other clients that are part of the same MADN line can join the active call by going off hook.

You can prevent others from joining the call by using the MADN feature to make the call private. To make the call private you dial a special code (Vertical Service Code) so that the call server knows that the call is private. To dial a Vertical Service Code on an IP Deskphone, you must first initiate a new call by pressing the **Action** context-sensitive soft key, select **New Call/Conference**, and then dial the Vertical Service Code that is provided by your system administrator or service provider.

Note: The MADN feature is only available when you connect to a call server that supports it. Your system administrator manages the MADN feature and enables the MADN feature on your IP Deskphone if required.

When multiple IP Deskphones are configured with a MADN SCA feature, they share one single Directory Number (DN) that is available to the user. An incoming call to this DN or to any SIP address of the users of the MADN SCA group causes all the IP Deskphones to ring. Also, any user of the MADN SCA group can join a call initiated from any of the IP Deskphones of that group.

Any user that joins a call with the MADN SCA feature can put the call on hold and prevent other users within the MADN SCA group from joining.

Figure 43: MADN SCA shared line not active



Figure 44: MADN SCA shared line active



Audio Codecs

This feature allows you to specify a codec to which you can switch to during an active call. You can use the Preferences menu to modify the order of preference of the codecs between calls.

You can select an audio codec by name during a call, or while the handset is idle. The Audio Codecs feature also gives you control over the audio configuration that is used for inbound and outbound calls.

To change the codec while on the call, select **Audio, Change codec**, and then press **OK**.

The following context-sensitive soft keys are available on the Audio Codes page:

- **Ok**—to view the Audio Codec Selection screen.
- **Back**—to return to the previous screen.

Audio Codec Selection

The Audio Codec Selection allows you to select a codec to use during inbound and outbound calls.

The following context-sensitive soft keys are available for selecting the audio codes:

- **Select:** The IP Deskphone attempts to renegotiate the codec for the current call to use the selected codec.
- **Back:** Allows you to return to the Audio Codec screen.

Audio Codec Ordering

The Audio Codec Ordering allows you to modify the order of preference of codecs to use during inbound and outbound calls.

The following context-sensitive soft keys are available for the audio codec ordering page:

- **Save**—to save the current order as the new preferred codec order.
- **MoveUp**—to move the highlighted codec up in the list.
- **MoveDwn**—to move the highlighted codec down in the list.
- **Back**—to return to the Audio Codec screen.

The Audio Codec Ordering screen allows you to modify the order of preference of the codecs. You can reorder the preferences, and the changes to the ordering are saved.

PC Client softphone interworking with the IP Deskphone

This feature allows you to access the functionality of the IP Deskphone using a PC Client softphone. The Click-to-Answer function allows you to answer an incoming call to the IP Deskphone by clicking a button on your PC Client running on your PC. The call continues as if you answered it using the **Answer** context-sensitive soft key on the IP Deskphone.

This feature allows you to control a call coming to the IP Deskphone using a softphone client on the PC. The call data is actually sent and received by the IP Deskphone. This feature does not support the **Copy** context-sensitive soft key.

Answer-Mode Settings

For an Avaya 1120E IP Deskphone to automatically be answered on your PC Client softphone, you must pre-grant authorization to the user or user groups who are making the request for an automatic answer.

Press **Prefs**, **Feature Options**, and then select **Answer-Mode Settings** to request an automatic answer to the callers.

The following options are available for the Answer-Mode Settings page:

- **Allow Mode**—to select a mode. The options for the Allow Mode are as follows:
 - Disabled
 - Friends
 - Directory (includes all Friends)
 - Public (includes all users)
- **Allow Address**—to edit the list of address.

The following context-sensitive soft keys are available for the Answer-Mode Settings page:

- **Change**—to open the Allow Mode Settings page if option 1 is selected. Allows you to open the Allow Domain page shown if option 2 is selected.
- **Back**—to return to the Feature Options page.

Allow-Mode Settings

The Allow-Mode Settings screen allows you to enable or disable the feature, and to allow automatic requests for Friends, Directory, or Public users.

The following context-sensitive soft keys are available for the Allow mode settings page:

- **Select**—to enable the current selection.
- **Back**—to return to the previous screen.

Allow Domain setting

The Allow Addresses screen allows you to preauthorize requests to automatically answer to a list of user-entered domains, and SIP addresses.

Select **Prefs**, **Feature Options**, **Answer-Mode Settings**, and then press **Allow addresses** to view the Allow Addresses screen.

The screen displays the following instructions:

Domain or SIP address

[Typing cursor]

The following options are available for the Allow Addresses page:

- **Save**—to save the entered domain and SIP address into the list and displays the list.
- **abc/123**—to change between alphanumeric and numeric entry.
- **Clear**—to erase all entered characters.
- **Back**—to return to the previous screen.

The Allow Addresses screen displays the domains and SIP addresses in a list. If the list is long, you can scroll down the screen until you have reached the last entry.

The following context-sensitive soft keys are available for the Allow Addresses page:

- **Add**—to add the entry content.
- **Edit**—to select the current entry and edit the entry.
- **Delete**—to delete the selected domain from the list.
- **Back**—to return to the Answer-Mode Settings screen.

Automatic remote software updates

Note: Your system administrator must enable **Remote check for update** for this feature to work.

Your IP Deskphone may be configured to perform automatic software updates. If this feature is configured, the IP Deskphone displays when a software update is scheduled to occur, and **Yes** and **No** context-sensitive soft keys are displayed. If the IP Deskphone is idle and no key is pressed, the software update begins in one minute.

If you press **Yes**, the software download begins.

If you are using your IP Deskphone (this includes on hold, on a conference call, or when your IP Deskphone is ringing) and you press **No**, the call is not disconnected and the software update does not occur. The IP Deskphone displays the software download prompt again in three minutes a total of three times.

If, after the third notification, you press **No** or no key is pressed, the software update does not occur. Your IP Deskphone attempts the software download process again in two hours.

Note: If you allow the update to proceed and the server is down, the IP Deskphone does not ask for updates again.

Multiuser

The Multiuser feature allows multiple SIP user accounts to be active on the IP Deskphone at the same time. This allows a single IP Deskphone to be shared among multiple users each with their own account, allowing each user to receive calls without logging off other users.

You can have multiple user accounts (for example, a work account and a personal account) active at the same time on the same IP Deskphone.

You can use the following features during a call:

- [“Initial login” on page 265](#)
- [“Logging out” on page 267](#)
- [“Server failover” on page 268](#)
- [“Upgrade impacts to user profiles” on page 269](#)
- [“Line keys” on page 270](#)
- [“Making a call” on page 272](#)
- [“Receiving a call” on page 273](#)
- [“Being in a call” on page 273](#)
- [“Instant Messages” on page 275](#)
- [“Menu features” on page 275](#)
- [“Modifying settings” on page 275](#)
- [“Programmable keys” on page 276](#)
- [“Address books” on page 278](#)
- [“User status” on page 279](#)
- [“Notifications” on page 282](#)
- [“Account Selection” on page 283](#)

Initial login

For an initial login, you must enter a user name and password and specify your login to either be permanent or to expire. You can also specify which SIP domain you want to access. The Domain key allows you to select a domain from the configured list but you cannot modify the domains. You can change the language used at the login screen. [Figure 45 on page 265](#) shows the primary login screen.

Figure 45: Primary Login screen



After you are logged in, the IP Deskphone displays the Idle screen. You can configure up to five profiles. If the limit is exceeded, then the least recently used profile is automatically deleted.

Additional logins

The **Login** command in the **System** menu allows you to register additional accounts. You cannot change the language in a secondary login. [Figure 46 on page 266](#) shows the secondary login screens.

Figure 46: Secondary Login screens



You can specify the Line Key to which the new account is associated. By default, the first unused key is selected. If the configured limit is reached on concurrent logins, then the selected login command displays an error message. The initial login message **login in process** displays during the login operation.

During the login process, the IP Deskphone can receive calls for user accounts that are already registered; however, other features are not available until the login process is complete.

No profile selection prompt is displayed for the secondary account and no profile is created.

Automatic login

If you were logged in when the IP Deskphone was switched off, the IP Deskphone automatically logs you back in upon startup. If multiple users were logged in, then they are all logged back in one after the other.

If the automatic login feature is disabled, then the automatic login does not occur.

It is possible to provision the IP Deskphone with user credentials for automatic login even on the initial startup. With the addition of multiuser support, it is also possible to provision multiple accounts in the same way. For more information about different autologin scenarios, see [“Primary account logout” on page 267](#).

Logging out

The logout command prompts you to select an account, asks for confirmation, then proceeds to log out the account. Logging out an account frees the corresponding Line key. Logging out does not require a password. For more information about logging out, see [“Logging off from the IP Deskphone” on page 82](#).

Figure 47 on page 267 shows the logout screens.

Figure 47: Logout screens



Primary account logout

Logging out of the primary account causes all other accounts to log out automatically and the IP Deskphone to display the login screen. The secondary accounts are logged back in automatically when a new primary account is registered or the same primary account is re-registered.

If the IP Deskphone is restarted after logging out of the primary account, it returns to the login screen. Logging in a new primary account leads to automatic login of secondary accounts.

The list of programmed feature keys is part of the IP Deskphone profile. As a result, logging out of one primary account and logging in on a different account could change the set of feature keys. If a secondary account was assigned to a key that is also in the set of feature keys, the secondary account takes precedence: it is logged in, and the feature key

acts as a Line key. If the account is logged out manually, the programmed feature key becomes available.

Secondary account logout

You can log out of a secondary account by selecting the secondary account in the Logout **Select User** screen. This causes the secondary account to be removed from the autologin list. If you restart the IP Deskphone, the secondary account is not logged back in.

Server failover

If the connection to your account proxy is lost, then the IP Deskphone notifies your account and periodically attempts to reconnect. Some features remain accessible for other accounts (for example, incoming calls), but other features are not available until connection is re-established or you cancel the reconnection. Cancelling the call has the same effect as logging out. If you are the primary account, the IP Deskphone returns to the initial login screen. If you are logged in on a secondary account, that secondary account is removed from the list of secondary accounts that are logged in on automatic login.

If more than one account loses connection, the IP Deskphone attempts to reconnect to account in sequence. The first account to lose connection retries until it re-registers or you cancel the attempt, after which a reconnect attempt begins for the next account. Canceling the reconnection attempt of the primary account immediately abandons attempts for all other accounts, logs out secondary accounts that are still connected, and returns the IP Deskphone to the login screen.

A single login queue is used for automatic logins and failover. This means that if automatic logins are still pending when an account cannot connect, a reconnection attempt for that account only begins after all automatic logins have completed or are cancelled.

Cable unplugged

If the IP Deskphone detects that the network cables are unplugged while accounts were logged in, then the IP Deskphone assumes that all accounts have lost their connection to the server. When you reconnect

the cable, the IP Deskphone proceeds to re-register all accounts starting with the primary account.

Upgrade impacts to user profiles

In previous releases of the IP Deskphone software, user profiles were associated to user names rather than accounts; one user profile could be associated with multiple user names. After the IP Deskphone is upgraded to SIP Release 3.x software, the IP Deskphone may contain user profiles with old user name associations.

When a primary account with no associated profile is registered, the IP Deskphone looks for an old user profile associated with that user name. If an old user profile associated with that user name is found, the user profile becomes permanently associated with that account and is no longer associated to a list of user names.

Example:

- An Avaya 1120E IP Deskphone with SIP Software Release 2.x has the following user accounts logged in and logged out.
 - user1@domain1.com
 - user2@domain1.com
 - user1@domain2.com

A user profile is created for the first account and is reused for the second account. The third account reuses the same profile, as it has the same user name as the first account.

- The IP Deskphone is upgraded to SIP Software Release 3.x.
 - A user logs to the primary account "user3@domain1.com". No profile is found for that account; a new profile is created automatically.
 - The user logs out, then logs to the primary account "user2@domain1.com". No profile is found for that account, but a Release 2.x user profile is found to be associated to the user name "user2". The profile becomes associated to "user2@domain1.com". The profile is loaded and user2 now has

access to the call logs and most preferences available before the upgrade.

- User2 logs out, then logs in “user1@domain1.com”. User1 had a profile before the upgrade, but that profile has now been associated to the user2 account; therefore a new profile is created.

Not all the information in old profiles is preserved. The preference settings (for example, voice mail ID) are discarded in the upgrade.

Line keys

Each registered user is associated to a separate line key. Each line key displays the name of the registered account and some basic state information for that account.

The primary account is always associated to the first (bottom-right) line key of the IP Deskphone. If you are a secondary user, the order of the next available line key is from bottom to top and right to left on the IP Deskphone, followed by the keys on the Expansion Module from bottom to top and right to left. You can select a different available line key for secondary accounts during the login process.

[Figure 48 on page 271](#) shows the Avaya 1120E IP Deskphone with an Expansion Module for Avaya 1100 Series IP Deskphones and multiple accounts.

Figure 48: Avaya 1120E IP Deskphone with Expansion Module and multiple accounts

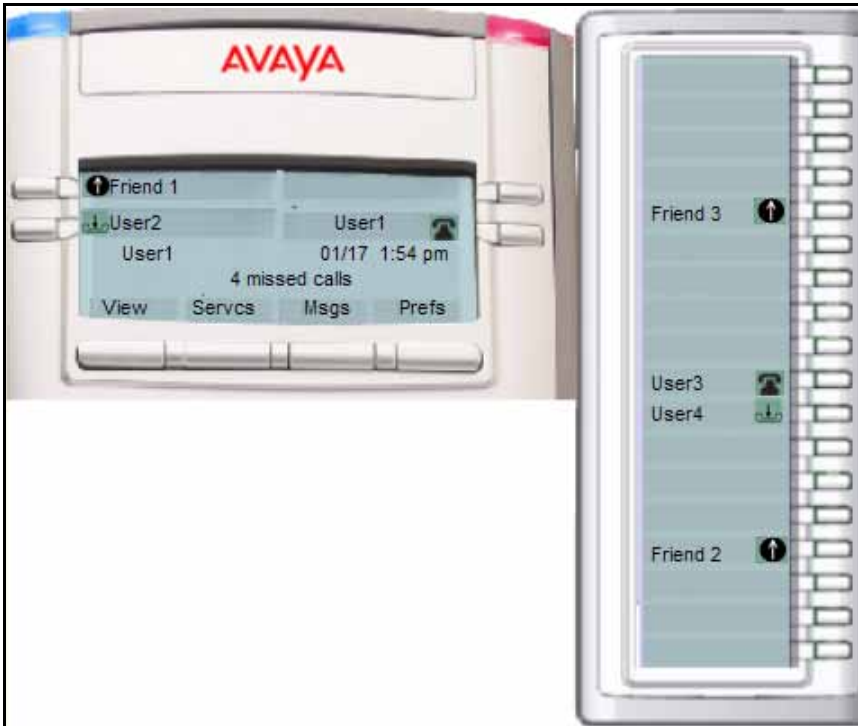

Pressing a line key either brings up a dialing prompt, initiates a call to a pre-selected target, or answers an incoming call. For more information see [“Making a call” on page 272](#).

At **select account** prompts (such as the Logout screen and User Settings screen), pressing a line key highlights the corresponding account.

Each line key reflects the state of its account.

- If there is a call for the account, a phone icon shows the state of the call whether it is on hold, or ringing.
- If there is more than one call, the state of the most active call is displayed. Missed incoming calls and new voice mail messages for the account are indicated with an icon. This supplements the **NN**

missed calls message on the idle screen and the red LED, which cannot provide per-account information.

MADN, Do Not Disturb, and Call Forwarding features also affect the appropriate line key icon of the account.

Making a call

You can place a call using any of the registered user accounts. The selected user account determines which proxy is used, which domain name is used for the call target if none was specified, who the target sees is calling, and what service package-dependent features are available.

The ways to initiate an outgoing call fall into two categories:

- always using the primary user's account
- using a different, explicitly selected account. The usual way to select an alternate account is to press the line key of that account to obtain a dialing prompt.

If you initiate dialing by pressing digits from the Idle screen, the primary account is used after you lift the handset, press the headset key or press the handsfree key. The same applies if you initiate a call from the inbox, outbox or Instant Messages screen.

Similarly, the primary account is used when a dial prompt is first obtained after you lift the handset, press the handset key, or press the headset key, and the call is initiated by pressing digits from the Idle screen or by pressing the **Send** context-sensitive soft key.

If you initiate a call by pressing a line key, the user account associated with that line key is used when the call is initiated.

If you initiate a call from the Address Book or Friends list, the account that is selected to display the list, is the same account that establishes the call. For more information, see [“Receiving a call” on page 273](#) and [“Menu features” on page 275](#).

In all cases, if you initiate the call by pressing a line key, then the account associated with that particular line key takes precedence.

For example, pressing Line Key 1 to obtain a dial prompt, dialing, then pressing Line Key 2 initiates the call using the account associated with Line Key 2. However, there are cases where pressing a Line Key does not initiate dialing (for example, Address Book in Select mode).

While the outgoing call is ringing, the selected account is displayed on screen on a **From:** line.

Receiving a call

When you receive an incoming call, the displayed information shows which account the call is intended to reach. The line key of the corresponding account displays an **incoming call** icon. The call can be answered by:

- pressing the Answer context-sensitive soft key
- taking the handset off hook
- pressing the headset or handsfree key
- pressing the appropriate line key of the account

Note: You cannot use a different account to answer the call.

If the IP Deskphone receives multiple calls at the same time, a list (sorted by the most recent incoming call first) of all active and incoming calls appears. After you select a specific call in the list, you can either answer the call or process the call.

If the calls are for different accounts, then the line keys associated with the accounts receiving the incoming calls display an incoming-call icon.

An incoming-call icon provides visual feedback. You can answer the call by pressing the line key directly without having to select the call. This automatically puts other active calls on hold.

Being in a call

When a single call is active, the screen displays the local account in use and the remote user. If multiple calls are active, each call appears on a

single line. The local account for the active call appears on the context line. Each line key reflects the most active call state of its account.

The active call is affected by operations such as transfer or call parking. One exception is the New Call action, which uses the primary account by default; this can be overridden by pressing another line key to initiate the call.

Joining calls into a specific conference always uses the conference server of the primary account. Accounts which cannot access the server cannot join the server.

After you create a ad-hoc conference, you can join additional calls into the same conference. You cannot create more than one ad-hoc conference at a time.

Three-way calls can join any two calls, regardless of the account. The service package of the account to which a call is associated determines which operations (for example, Call Park) are available on that call. After you have established a 3-way call, the join functionality becomes unavailable until the 3-way call is terminated.

Figure 49 on page 274 shows two examples of the Avaya 1120E IP Deskphone with one call and multiple calls.

Figure 49: Avaya 1120E IP Deskphone with one and multiple calls

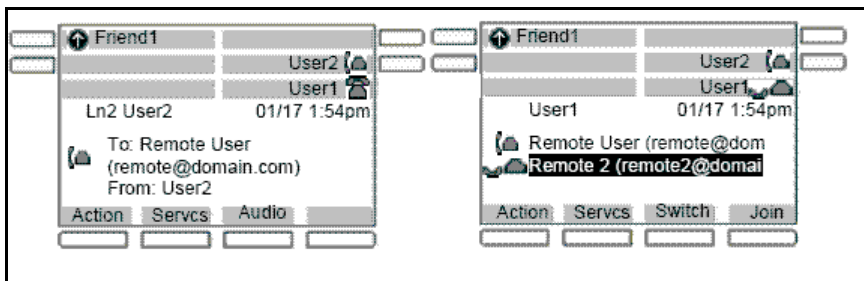

Instant Messages

Only the primary account can send or receive instant messages. Incoming messages for secondary accounts are rejected; they are not displayed on screen, and are not added to the instant message logs.

Menu features

The IP Deskphone menu displays are customized to match the service package of the active account that is accessing the menu. In most cases, menus are accessed from the Idle screen and the primary account is active. For example, you can only use the **Retrve** context-sensitive soft key to retrieve a parked call if call parking is allowed by the service package of the primary account.

Similarly, accessing the Address Book, either through the corresponding hard key or through the View menu, usually displays the Address Book of the primary account. However, accessing the Address Book in **select** mode (for example, while dialing, or selecting an item for a speed dial key) accesses the address book of the latest user account used on the address-input screen.

Modifying settings

A number of preferences, in particular Voice Mail and IM settings, are per-account. The main **Preferences** menu includes an **User Settings** entry. Selecting this entry prompts you to select a registered account. After selecting an account, a menu appears that lets you modify the settings of that account.

Per-account call notification options

The **Call Settings** entry in the **User Settings** menu provides a number of configuration options relating to how incoming calls for a particular account are treated:

- what kind of audio alert should be used (ring tone, beep, nothing)
- whether the red LED should blink
- whether the call should be added to the Incoming Calls log

IM Settings

IM Settings is located under **User Settings**. Any change in settings on the primary account takes effect immediately. You can also modify settings for a secondary account, but they do not take effect until that account registers as the primary account.

Voice Mail settings

Voice Mail Settings is located under **User Settings**. You can program different voice mail addresses and IDs for each account. To access the voice mail of a secondary account, press the line key of the secondary account to obtain a dial prompt, and then press the **VMail** context-sensitive soft key.

Waiting messages are reported in two ways:

- The red LED is lit if any account has a waiting message.
- A special icon (a shaded envelope) is displayed on the line key of each account with a waiting message (unless the account is in a call).

Remembering settings after logout

For each profile, up to 24 sets of per-account settings are always remembered. If you have configured settings for an account, after the account is logged out, the settings are restored when the account is logged back in as either a primary or secondary account.

When an account is logged in without settings saved in the profile, a new set of default settings is created for it. If there are already 24 sets of per-account settings in the profile, one setting for which the account is not currently registered is discarded, and the new setting is saved.

Programmable keys

A line key associated with a registered account cannot be used for programmable features. The **Program Key** screen lists all the line keys. All line keys associated with an account are displayed as such, and selecting them displays an error message.

The Do Not Disturb, Call Forward, and Presence keys are associated to a specific user account when they are created, and determine which account's status to affect. For more information see, [“User status” on page 279](#).

By default, you can press a Speed Dial programmed key to initiate a call using the primary account. If a line key is pressed to obtain a dialing prompt and then a speed dial key is pressed, the account of the line key is used. When accounts are registered on different domains, you can only program and use speed dial keys with targets that are reachable on the domain of the secondary account. It is possible to program and use speed dial keys with targets that are only reachable on the domain of a secondary account. The Speed Dial keys always uses the primary account to determine the presence state of the target.

Instant Message keys always use the primary account, because IM support is disabled for secondary accounts.

Inbox, outbox, IM log

There is a single inbox, a single outbox and a single instant message log for each profile. The detailed view of the call log entry indicates the local account associated to each entry; that is, the source of outgoing calls and the target of received calls.

[Figure 50 on page 277](#) shows the Inbox in call details view.

Figure 50: Inbox: call details view



Call logs and IM logs provide many ways of initiating a call to the address identified by the selected entry, such as lifting the handset. In most cases, the primary account is used. However, if you press a line key to initiate the call, the call uses the account associated with the line key.

If call logs and IM logs are invoked in **selection** mode; you cannot initiate a call directly. In this case, the **Select** context-sensitive soft key populates a dial prompt or other input field with the selected target. The operation already in progress determines which account to use. (For example, if you press the line key to obtain a dial prompt, press the Inbox key to select a target, press **Select**, then press **Send**, then the line key that was originally pressed determines the account.)

Address books

Each profile contains a local address book, which is independent from all network address books.

Accessing the Address Book in **view** mode (by pressing the Directory hard key from the Idle screen) displays the address book of the primary account. If the primary account does not have a network address book, then the local address book is accessed.

Accessing the Address Book in selection mode always accesses the address book of the current account. For example, after obtaining a dial prompt by pressing Line Key 2, pressing the Directory key accesses the address book of the account associated to Line Key 2. The network-based directory of the appropriate account is accessed only if it is available; otherwise, the local address book is used.

The network-based address book of secondary users can only be accessed in selection mode. You cannot modify an address book of a secondary account on the IP Deskphone. However, modifications made remotely to the address book, such as using a different client or the Personal Agent, are reflected on the IP Deskphone. The local address book is shared by all accounts that do not have a network-based address book.

You can modify the local address book only if the primary account has no network-based address book. Changes to the network-based address book of the primary account are not reflected in the local address book.

The Friends view always accesses and modifies the address book of the primary account (local or network-based). There is no selection mode for the Friends view. You can only monitor and view the presence information of Friends of the primary account in Friends view.

User status

This section describes the features associated with the User status.

Do Not Disturb

Selecting the **Do Not Disturb** command from the **Services** menu prompts you to specify which account should be placed in DND mode. The option **all** allows you to place all accounts in DND mode. Selecting an option requests you to confirm the operation before proceeding. The option **all** is highlighted by default.

Activating DND for a specific account automatically causes calls to that account to be rejected with a busy indication; however, calls to other accounts can be received. When DND mode is active for an account, the line key of the particular account periodically displays a DND indicator on its label.

The following scenarios apply to DND:

- If you select a single account and the account is already in DND mode, then you are asked if you want to disable DND rather than asked if you want to enable DND.
- If you select a single account and the account has Call Forwarding active, then an error message appears indicating that DND cannot be activated.
- If you select the option **all** and if at least one account is not in DND mode, then the DND mode is activated for all accounts. If any account is in Call Forward mode, Call Forward is disabled.
- If you select the option **all** when all accounts are in DND mode, DND mode is deactivated for all accounts.

When using a programmed DND feature key, the account that is impacted by the DND feature key is determined when the feature key is configured. When the DND feature key is pressed, the DND feature

behavior is the same as previously described, except no confirmation prompt is displayed. The operation is performed immediately, and a message indicating what was done is displayed.

DND mode for each account is persistent. If you restart the IP Deskphone, or log out and log in, the account maintains the original state.

Call Forwarding

Selecting the **Call Forward** command from the **Services** menu prompts you to specify which account must be placed in Call Forward mode. The option **forward all** places all accounts in Call Forward mode in one operation and the option **forward none** deactivates Call Forward for all accounts at once.

The following scenarios apply to Call Forward:

- If you activate Call Forward for a specific account, then all calls to the selected account are redirected automatically to the specified address. The target address of the account must be reachable from the domain. Calls to other accounts are still received. The line key label periodically indicates that Call Forward mode is active.
- If you select a single account with neither Call Forward nor DND active, then you are prompted to specify a forwarding target. Call Forward is then enabled. If DND is already active, a message indicating Call Forward cannot be activated displays. If Call Forward mode is already active, then you are prompted whether to deactivate it.
- If you select the **forward all** option, then all accounts are configured in Call Forward mode using the provided target. DND mode is deactivated for all accounts. If accounts are already in Call Forward mode for a different target, they are updated to use the new target.
- If you select the **forward none** option, the Call Forward feature is deactivated for all accounts for which it is currently active.

After a **single-account CFwd** programmed key is pressed:

- If the account is already forwarding calls to the programmed target, call forwarding is deactivated.

- If call forwarding is not already activated, then the account is configured to forward calls to the given target, disabling DND if necessary, and overriding any other call forward target that might be active for the account.

After a **forward all** programmed key is pressed:

- If all accounts are already configured to forward calls to the key's target, then Call Forward is disabled for all accounts.
- If not, Call Forward is activated for all accounts using the key's target.

For both **single** and **all** keys, you can treat the key as a toggle. If no Call Forward or DND operations are selected, pressing the key switches one or all accounts between forwarding to the key's target and not forwarding states.

The Call Forward mode and target for each account is persistent. If you restart the IP Deskphone or logout and login, the Call Forward state is retained.

Presence

Selecting the **Presence** command from the **Services** menu prompts you to specify which presence state of the account should be modified. The option **all** lets you configure all accounts to the same presence in one operation.

If you select a single account, then the current state of the account is displayed and you are prompted whether it should be changed. You are then prompted to enter the new presence state. The new presence state is applied after it is confirmed.

If the option is selected, no current state is displayed, and you are immediately prompted to select the new state. The new state is then applied to all registered accounts.

When using a programmed Presence feature key, the account that is impacted by the Presence feature key is determined after the feature key is configured.

After a single-account Presence programmed key is pressed:

- If the account is already configured to the programmed presence state, then the account is configured back to the **Connected** presence state.
- If not, the account is configured to the programmed presence state.

After the **all accounts** Presence programmed key is pressed:

- If all accounts are already configured to the programmed presence state, then all accounts are configured to the **Connected** state.
- If not, all accounts are configured to the programmed presence state.

As with Call Forwarding keys, this allows Presence keys to be used as toggles.

However the presence states are not entirely under your control. Some states are applied automatically (for example, On The Phone). All states are applied by sending a message to the SIP proxy, which can choose not to accept the change. As a result, it is possible for a **set all presence** operation to not result in all accounts being configured to the programmed presence. In such a case, pressing the key again would again attempt to apply the programmed presence; therefore it is more effective to program a separate Presence key to configure all accounts to the Connected state.

Events that update presence states automatically occur on a per-account basis. For example, the **On The Phone** state is applied to any account for which at least one call is active.

Account presence is not retained after logging out or rebooting.

Notifications

The system displays messages spontaneously on the screen to report events that are not initiated by you. This includes such events as failure to retrieve a service package and availability of a new Location list.

These spontaneous notifications do not indicate which account is affected by the event. In such cases, the affected account is indicated by the message itself.

Figure 51 on page 283 shows per account notification on the Avaya 1120E IP Deskphone.

Figure 51: Per-account notifications

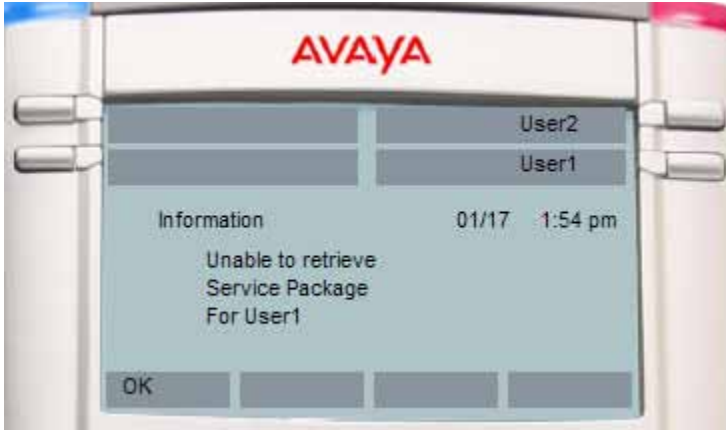

It is possible for the same event to occur for multiple accounts at the same time. In this case, they are displayed one after the other.

Account Selection

There are a number of scenarios where you are prompted to select an account (for example, logout, per-account settings, programming keys). These scenarios fall into two categories:

1. Prompts where exactly one account must be selected
2. Prompts where an “all” or “none” option is available

In the first case, if you have logged in only one account, then the prompt is not displayed. The single account is selected automatically, and the next screen is immediately displayed. Otherwise, the primary account is always at the top of the list, and is highlighted when the prompt is first displayed. In all cases, pressing the line key of an account highlights the corresponding item in the account list. If no selection is made in a certain amount of time, then the operation is cancelled.

Advanced features

The following chapter describes the following advanced features:

- “Viewing the IP Deskphone information” on page 284
- “Accessing the services menu” on page 285
- “Network menu” on page 295

Viewing the IP Deskphone information

To view the Phone information for the Avaya 1120E IP Deskphone:



1. Press the **Services** hard key and select **Phone Information** from the menu.

You can view the following information:

- Load Ver
- Software
- E.M Software
- Presence
- FeatActv
- Srv Pkg Location

Press the **Details** context-sensitive soft key to show:

- Primary User
- Primary Domain
- MAC
- IP
- License server
 - Status

Press the **Back** context-sensitive soft key to go back to the Phone Information Screen.

Note: You cannot make any changes to the setting from this menu.

To view information about the USB port press the **USB** context-sensitive soft key after you access the **Phone Information** screen. To view information about E911 press the **E911** context-sensitive soft key after you access the **Phone Information** screen.

Accessing the services menu

Some of the system features require your user password. You must consult with the system administrator or service provider before you can access some of the features.

To access the services menu:



Press the **Services** hard key.

The Avaya 1120E IP Deskphone displays the following menu:

1. Search—use to perform local/global search.
2. Login—use when the call server supports multiple user logons only
3. Logout— use to logoff the IP Deskphone. For more information, see [“Logging off from the IP Deskphone” on page 82](#).
4. Check for Updates—use to check for the latest software update for the IP Deskphone. For more information, see [“Checking for updates” on page 286](#).
5. Reset Phone—use to perform a reset of the IP Deskphone. For more information, see [“Resetting the IP Deskphone” on page 289](#).
6. File Manager—For more information, see [“Erasing the user data” on page 290](#).
7. Logging System—use to enable/disable SIP logging.

8. Phone Information—use to view phone details. For more information, see “Viewing the IP Deskphone information” on page 284.

Checking for updates

You can check for the latest software update for your Avaya 1120E IP Deskphone.

To check for the latest software update:



1. Press the **Services** fixed key.

2. Select **Check For Updates**.

Select

3. Press the **Select** context-sensitive soft key.

Yes

4. Choose one of the following:

- Press the **Yes** context-sensitive soft key check for the latest software update for your IP Deskphone.

- Press the **No** context-sensitive soft key to return to the previous menu without checking for an update.

No

Note: While the IP Deskphone checks for an update, it activates Do Not Disturb (DND).

Switching the proxy

When you switch proxy, you change the domain to which the IP Deskphone connects.

To switch the proxy:



1. Press the **Services** fixed key.

2. Select **Check For Updates**.

Select



3. Press the **Select** context-sensitive soft key.

abc



4. Press the **abc/123** context-sensitive soft key to toggle between alphabetic or numeric input.



5. Use the dialpad to enter your password.

Ok



6. Choose one of the following:

— Press the **Ok** context-sensitive soft key.

Back



— Press the **Back** context-sensitive soft key to return to the previous menu.

Yes

No

Domain

Domains

or

Done



The IP Deskphone prompts you with Switch to alternate proxy server?

7. Choose one of the following:

- Press the **Yes** context-sensitive soft key to proceed.
- Press the **No** context-sensitive soft key to return to the **System** menu.

The IP Deskphone logs you out from the current domain and returns you to the **User Login** screen.

8. Press the **Domain** context-sensitive soft key.

9. Choose one of the following:

- Press the **Domains** context-sensitive soft key to change the current domain.
- Press the **Done** context-sensitive soft key to keep the existing configurations and return to the **User Login** screen.

10. Press the **Up/Down** navigation key to highlight the new domain you want to use.

Select



Back



Done



11. Choose one of the following:

- Press the **Select** context-sensitive soft key to change the domain to the highlighted domain from the list.

The IP Deskphone returns to the **Current Domain** display screen, and the new domain appears.

- Press the **Back** context-sensitive soft key to keep the existing configurations and return to the Display menu.

12. Press the **Done** context-sensitive soft key to confirm the new Domain and return to the **User Login** screen.

13. Log on as usual.

Resetting the IP Deskphone

You can use this feature to reset the IP Deskphone without unplugging the power cable.

To reset the IP Deskphone:



Select



1. Press the **Services** fixed key, and then select **Reset Phone**.

2. Press the **Select** context-sensitive soft key.

abc



3. Press the **abc/123** context-sensitive soft key to toggle between alphabetic or numeric input.



4. Use the dialpad to enter your password.

Ok



Back



5. Choose one of the following:
 - Press the **Ok** context-sensitive soft key.
 - Press the **Back** context-sensitive soft key to return to the previous menu.

Yes



No



The IP Deskphone prompts you with **Reset Phone?**.

6. Choose one of the following:
 - Press the **Yes** context-sensitive soft key to proceed.
 - Press the **No** context-sensitive soft key to return to the System menu.

Erasing the user data

The IP Deskphone stores user files that you eventually want to delete. These files include:

1. Profiles—user profile settings
2. Sounds—downloaded tones or audio alerts
3. Languages—downloaded language files

4. System file—IP Deskphone system configuration file (Deleting this file returns the IP Deskphone to the factory default configuration settings.)

You can delete some or all of these files. The deletion of files is often necessary when the IP Deskphone is redeployed to a different user.

To delete user data files:



1. Press the **Services** fixed key.

2. Select **File Manager**.

Note: You must enter your login password to access the File Manager menu.

abc



3. Press the **abc/123** context-sensitive soft key to toggle between alphabetic or numeric input.



4. Use the dialpad to enter your password.

Ok



5. Choose one of the following:

- Press the **Ok** context-sensitive soft key.
- Press the **Back** context-sensitive soft key to return to the previous menu.

Back





6. Press the **Up/Down** navigation key to highlight one of the following:

- Profiles
- Sounds
- Languages
- System file
- All files

Select



Delete



Exit



Back



7. Choose one of the following:

- To enter the selected folder, press the **Select** context-sensitive soft key.
- To delete contents of the selected folder, press the **Delete** context-sensitive soft key.

Note: Folders cannot be deleted because they are on the IP Deskphone.

- If you are at the root folder of the flash disk, press the **Exit** context-sensitive soft key to return to the previous menu.
- If you are already inside the folder, press the **Back** context-sensitive soft key to return to the previous menu.

To delete a user profile:

Delete



Back



1. Press the **Up/Down** navigation key to highlight the user profile you want to delete.
2. Choose one of the following:
 - Press the **Delete** context-sensitive soft key to delete the highlighted user profile from the list.
 - Press the **Back** context-sensitive soft key to return to the previous menu.
3. Log off or restart the IP Deskphone to complete the process.

To delete a sound file:

Delete



Back



1. Press the **Up/Down** navigation key to highlight the sound file you want to delete.
2. Choose one of the following:
 - Press the **Delete** context-sensitive soft key to delete the highlighted sound file from the list.
 - Press the **Back** context-sensitive soft key to return to the previous menu.

To delete a language file:



1. Press the **Up/Down** navigation key to highlight the language file you want to delete.

Delete



2. Choose one of the following:
 - Press the **Delete** context-sensitive soft key to delete the highlighted language file from the list.
 - Press the **Back** context-sensitive soft key to return to the previous menu.

Back



To delete a log file:



1. Press the **Up/Down** navigation key to highlight the log file you want to delete.

Delete



2. Choose one of the following:
 - Press the **Delete** context-sensitive soft key to delete the highlighted language file from the list.
 - Press the **Back** context-sensitive soft key to return to the previous menu.

Back



To delete the system file without deleting the user profile:

Next

Back

1. Choose one of the following:
 - Press the **Next** context-sensitive soft key to delete the system file.
 - Press the **Back** context-sensitive soft key to return to the previous menu.
2. Log out or restart the IP Deskphone to complete the process.

To delete all files:

Next

Back

1. Choose one of the following:
 - Press the **Next** context-sensitive soft key to delete the system file and user profiles.
 - Press the **Back** context-sensitive soft key to return to the previous menu.
2. Log out or restart the IP Deskphone to complete the process.

Network menu

Primarily, the system administrator is the only person authorized to access the network menu and to use an administration password to access the items. For more information on how to access the network menu items, see *SIP Software for Avaya 1100 Series IP Deskphones - Administration* (NN43170-600).

The following Network menu items are available:

- Server Settings—to select and edit domains
- Device Settings—to configure the network settings
- Diagnostics—to run a trace route or send a ping to diagnose the network connection
 - IP Set and DHCP information
 - Network Diagnostics tools
 - Ethernet Statistics
 - IP Network Statistics
 - USB Devices
 - Advanced Diag Tools
 - Test Key
- Lock Menu—to access to the Network Menu

To access the Network menu:



Services

Prefs



1. Choose one of the following:

- Press the **Services** fixed key twice quickly.
- Press the **Prefs** context-sensitive soft key, and then select **Network** from the menu.

Note: You need to enter an administration password to access the Network menu items.

USB flash drive

A standard USB flash drive can be used for the following:

- To extend the hardware storage in the IP Deskphone.

- To support file transfer between the PCs and the IP Deskphone to upload specific files or preferences into the IP Deskphone.
- To backup data stored in the IP Deskphone.

Presence of USB flash drive

Navigate through the menus **Services**, **Phone Information**, **USB** to verify the presence of the USB flash drive attached to the IP Deskphone. After you select the **USB** menu, the attached USB flash drive is displayed along with other USB devices. The name of the USB device directly appears from the USB device itself. There is no explicit USB flash drive indication.

Feature characteristics

USB flash drives with 8GB or less are supported. A file browsing facility is available.

Most USB flash drives have an LED to indicate file operation in progress. After you attach the USB flash drive to the IP Deskphone, the IP Deskphone registers and mounts the USB file system. Mounting the file system causes the LED to flicker. If you disable USB device support, then the IP Deskphone does not mount the USB file system and the LED does not light.

There is no explicit safe removal. The USB flash drive can be removed safely when the LED indicator on the memory stick is off.

Enabling or disabling the USB Port

In the **Services**, **Phone Information**, **USB Devices** screen, if the value of **Enable USB Port** is **No** then the USB information does not display any USB devices connected. The screen displays the information that the USB port is disabled, as shown in [Figure 52 on page 298](#).

Figure 52: USB devices: USB port disabled screen

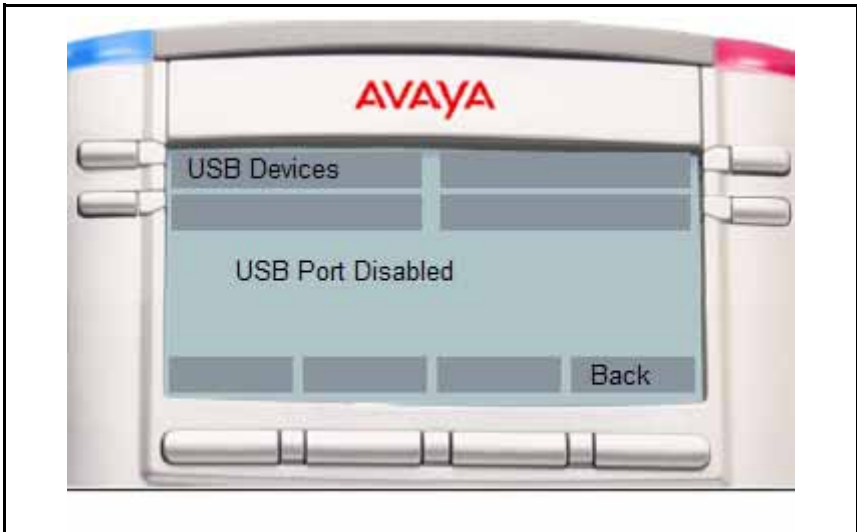

If the USB port is not disabled, then the USB menu displays information on all USB devices attached, even if the device is locked. An unsupported device is enumerated if it is attached to the IP Deskphone. To ensure you know about the USB lock status, the USB device information is followed by status information about supported USB devices. If the USB configurations do not match the USB device status because of the restart requirement, a warning that the **USB Update requires reboot** appears on the screen.

[Figure 53 on page 299](#) displays a sample USB information menu with the USB port enabled and selected device locked:

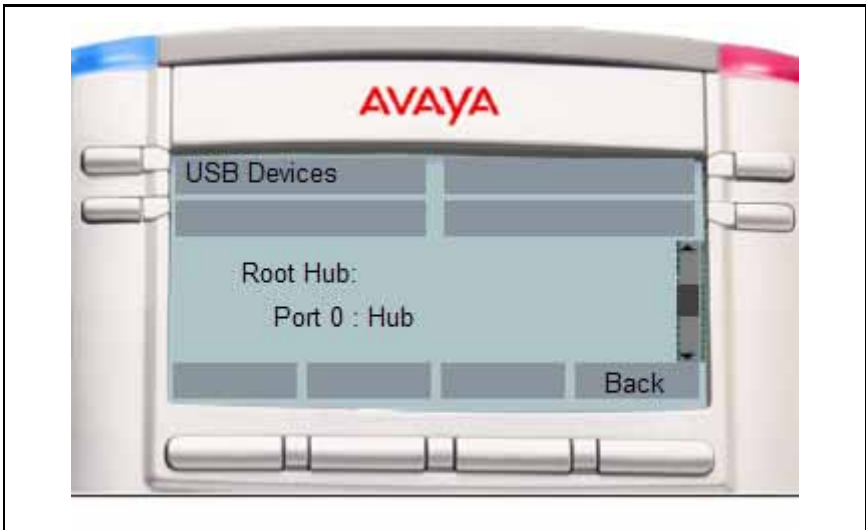
Figure 53: USB devices: Phone information screen

Customizable banner for login

If a login banner with login banner text is configured, the IP Deskphone displays the banner text on the screen as the user logs on.

Changing the IP Deskphone configured language does not change the banner text language. The banner appears only for the primary user of an IP Deskphone. In a multiuser configuration, even when the banner text is enabled, the banner does not appear to the secondary user logins.

[Figure 54 on page 300](#) displays the login banner screen.

Figure 54: Login banner screen



You can dismiss the banner screen. While you dismiss the banner screen, the IP Deskphone switches to DND mode until the banner is dismissed. Outgoing or incoming calls are not allowed other than emergency calls until you dismiss the banner.

You can see pop-up messages or prompts on the bottom of the banner screen after you dismiss the login banner.

Phone Information - Details screen

The Phone Information details screen displays the Primary user, Primary domain, MAC address, and IP address of the IP Deskphone. The contents of this screen include user and IP Deskphone identifiable information that may need to be protected (per US Federal/DoD requirements/guidelines).

Attention: To hide information that is protected, the administrator can disable the **Details** context-sensitive soft key on the main Phone Information screen.

If the **Details** context-sensitive soft key is disabled, you cannot view details on the Phone Information details screen.

If the **Details** context-sensitive soft key is enabled, you can view the Phone Information Details screen. In the Services menu, select Phone Information and then press the **Details** context-sensitive soft key.

Figure 55 on page 301 displays the Phone Information Details screen.

Figure 55: Phone Information Details screen



The Phone information details list the following:

- **Primary User:** Primary Logged in User name.
- **Primary Domain:** Primary login domain.
- **MAC:** Device MAC address.
- **IP:** IP Deskphone IP Address
- **Device Licensing/Token usage information:** License or token usage information for the IP Deskphone. It is an optional item in the IP Deskphone information.

To dismiss the details screen and return to the previous display, press the **Back** context-sensitive soft key.

Screensaver/screen lock

You can lock the display of the IP Deskphone using a timed Screensaver/ Lock.

When the screensaver is active, it clears the programmed keys of the plugged-in Expansion Module. If you have logged into the IP Deskphone, then you are not logged out, but the line key label clears and makes the IP Deskphone inactive.

The **ScrnSvr** context-sensitive soft key is located on the idle screen. This key is available only if the screensaver is enabled, and is accessed by pressing the **More...** context-sensitive soft key until **ScrnSvr** appears. Pressing the **ScrnSvr** context-sensitive soft key causes the current screensaver timer to turn off, and activates the previously-selected screensaver.

[Figure 56 on page 302](#) displays the menu with the option of selecting the display screensaver.

Figure 56: Display screensaver screen



Select the Display Screensaver menu item to display the screensaver settings screen.

The screensaver settings screen allows you to enable or disable your screensaver/lock. You can also configure various settings such as the delay before the screensaver starts, the background image to use, and the banner text to display when the screensaver/lock is active.

[Figure 57 on page 303](#) displays the screensaver settings screen.

Figure 57: Screensaver settings screen

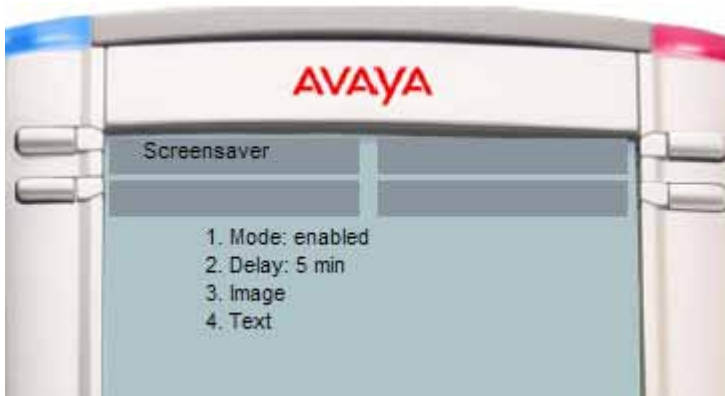

The following are the items on the displayed list:

- **Mode**—to enable or disable the screensaver and choose if the screensaver is to be password protected.
- **Delay**—to configure the time delay before the screensaver is invoked.
- **Image**—to select the background image to display when the screensaver is active.
- **Text**—to configure the text that appears on screen when the screensaver is active.

The following are the options available for the screensaver settings menu:

- **Select**—to select the currently highlighted setting.
- **Back**—to dismiss the screensaver setting.

Selecting the screensaver setting screen

The screensaver mode settings screen allows you to enable or disable the screensaver/lock.

Choose **Prefs**, **Display** and then select **Display Screensaver** to display the screensaver settings screen.

Figure 58 on page 304 shows the screensaver mode setting screen.

Figure 58: Screensaver mode setting screen

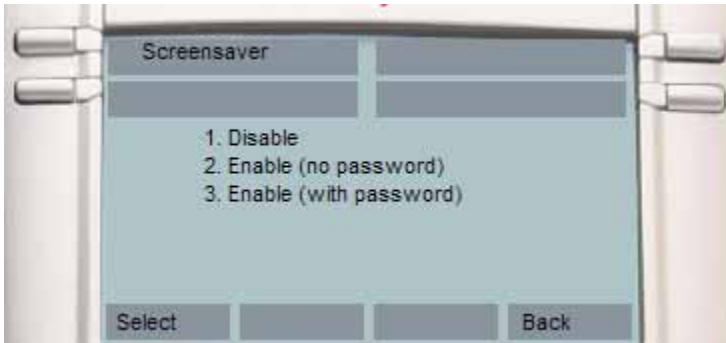

The screensaver mode setting lists the following items:

- **Disable**—to the disable the screensaver.
- **Enable (no password)**—to enable the screensaver with a password free mode.
- **Enable (with password)**—to enable the screensaver with a password mode.

The following are the options available for the screensaver settings menu:

- **Select**—to select the currently highlighted setting.
- **Back**—to dismiss the screensaver mode menu.

Note: Some options may not appear, depending on configuration.

Disabling the Screensaver displays a message confirming your selection. [Figure 59 on page 305](#) displays the screensaver disable message screen.

Figure 59: Screensaver disabled message



Enabling the screensaver in **no password** mode displays a message confirming your selection.

[Figure 60 on page 305](#) displays the screensaver enable message screen.

Figure 60: Screensaver enabled message



Note: If the device configuration does not allow the use of a password free screensaver, this menu option is unavailable to you.

Enabling the screensaver in **password protected** mode prompts you to enter the password before logging in.

The screen lets you launch the user-defined password definition screen if it is enabled in the configuration.

The text on screen displays *Enter user password to activate screensaver* followed by a user input prompt.

Figure 61 on page 306 displays the screensaver password screen.

Figure 61: Screensaver password screen



The options, which are available for the Enable (with password) mode are as follows:

- **Ok**—Screensaver enabled message appears if the password is valid. Invalid password message appears if the password is invalid.
- **123/abc**—to toggle input mode between numeric or alphabet.
- **Set**—context-sensitive soft key appears only if the feature allows the setting of user-defined passwords. This key invokes a password definition screen that allows you to configure a password.
- **Back**—to dismiss the Enable (with password) mode menu.

If the option to use a user-defined password is allowed, the interface (screen) to configure the password, is accessed through the **Set** context-sensitive soft key on that screen. If a user-defined password is not allowed, then the **Set** context-sensitive soft key is not visible, and you can

use only the primary user login password to enable the password-protected screensaver.

After the screensaver is activated, if the IP Deskphone is idle for the defined delay/time interval, the screensaver takes control of the IP Deskphone. [Figure 62 on page 307](#) displays the screen with locked screen.

Figure 62: Screensaver locked screen

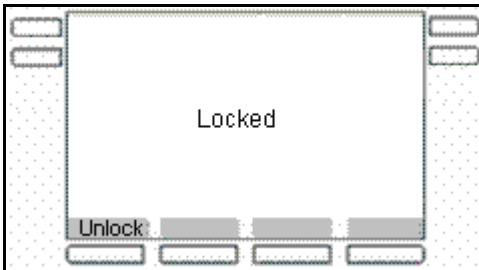

The following option is available for the Enable (with password) mode:

- **Unlock**—if the screensaver is not password protected, this key press (or any other) cancels the screensaver. If the screensaver is in a password-protected mode, pressing the **Unlock** context-sensitive soft key invokes a password input screen. The password must be correctly entered to cancel the screensaver.

If you enable the screensaver with **no password** mode:

- Any user interaction, key presses, mouse movement, or incoming call cancels the screensaver (without requiring a user password). This includes pressing the **Unlock** context-sensitive soft key.
- Incoming IMs do not cancel the screensaver.
- The programmed keys of attached Expansion Module(s) are cleared until the screensaver is deactivated. If you have logged on to the IP Deskphone, you are not logged out, but the line key labels clear and are inactive until the screensaver is deactivated.

If you reboot the IP Deskphone when there is an active screensaver:

- If you have enabled autologin, then the screensaver remains active after the IP Deskphone reboots and completes the login.

- If you have not enabled autologin, then the screensaver setting remains enabled, but not active, after you log back into the IP Deskphone manually.

If you enable the screensaver with a password protected mode:

- User interaction, key presses, and mouse movements do not cancel the screensaver.
- An incoming call displays showing caller ID and allows you to answer the call. You cannot make outgoing calls except an emergency call, and cannot view IMs or the Friends list until you unlock the IP Deskphone. An **Unlock** context-sensitive soft key appears on the screen. You can unlock the IP Deskphone after answering the call.
- Pressing the **Unlock** context-sensitive soft key prompts you to enter the password for the screensaver. The primary user line key is displayed (but not active) during the password prompt to give an indication about whose password is in use.
- Picking up the handset and dialing digits activates the line function display for emergency calls only. If you try to place an outgoing call, a message is displayed and the screensaver starts again.
- If you make an emergency call while the screensaver is active, the call is placed using the primary user.
- The Network menu is accessible to administrators (double press of the services key) even when the screensaver is active.
- If user-defined passwords are allowed, a mechanism to disable the screensaver (allowing the administrator to reset the user-defined password) is accessible through the network menu. This mechanism also invokes remotely from the IP Deskphone console through an SSH connection.
- All expansion modules are cleared of programmed keys until the screensaver is deactivated.
- If you reboot the IP Deskphone when there is an active screensaver:
 - If autologin is enabled, then the screensaver remains active after the IP Deskphone reboots and completes the login.
 - If autologin is not enabled, then the screensaver setting remains enabled but not active after you log back into the IP Deskphone manually.

Selecting an image to be viewed as a slideshow.

You can display all of the screensaver images that have been uploaded to your IP Deskphone in a slideshow format.

These files are loaded on the IP Deskphone using the USB flash drive.

Images for the 1120E IP Deskphone cannot exceed 128 KB. The images must be resized before they are loaded onto the IP Deskphone. The image size for the 1120E is 240 x 88.

Images can be displayed as a slideshow. Choose **Prefs, Display, Display Screensaver, Images** and then select **Slideshow**.

Background image

The IP Deskphone displays background images on the screen. From the preferences menu, you can browse the stored images on the file system and select an image for the user interface.

[Figure 63 on page 309](#) displays the background image menu.

Figure 63: Display menu



Selection of the menu item takes you to a new display list that contains all the available image files on the Flash File System.

Selecting an image screen

Select an image from a list of images currently stored on the Flash File System of the device.

1. To select background image, press the **Prefs** context-sensitive soft key, choose **Display**, and then **Background Image**.

[Figure 64 on page 310](#) displays the filenames of all image files currently stored on the Flash File System of the IP Deskphone.

Figure 64: File names containing image files



2. The following are the options available for the background selection screen.
 - **Select**—to select the currently highlighted image.
 - **Back**—to dismiss the Image selection screen.

After you select the background image you want to use, the confirmation screen appears.

[Figure 65 on page 311](#) displays the selected image in the background and the message to press **OK** to keep the selected image.

Figure 65: Background confirmation screen



Note: If the selected image is not effective, you need to cancel the selection.

3. The following are the options available for the background confirmation screen.
 - **OK**—to configure the selected image as background image.
 - **Cancel**—to cancel the selection. Also, the selected image is disregarded and returns to Images list screen if the screen time-outs after 15 seconds.

Service Package Group Support

The Service Package Group Support can help you program feature keys on an expansion module. You can view the group support feature in the feature key programming user interface and in the Friends list interface of the Address book.

You can use to the Service Package Group Support to help you do the following:

- to bulk-create feature keys, such as Speed Dial keys, based on one of your existing Directory Address Book groups. See [“To bulk-create feature keys based on an existing directory Address book group:” on page 312](#). To view existing groups in your address book if you selected Groups as the source data for the bulk key creation, see [“To view existing groups in your address Book if you selected Groups:” on page 314](#).
- to view the existing groups you have in your Address Book. See [“To view existing groups in your address Book if you selected Groups:” on page 314](#).
- to add a new contact to your Address Book. See [“To add a new contact to your Address Book” on page 317](#)

To bulk-create feature keys based on an existing directory Address book group:

Prefs



1. From the Idle screen, press the **Prefs** context-sensitive soft key (press the **More...** context-sensitive soft key until you see **Prefs**).



2. Press the **Up/Down** navigation key to highlight **Feature Options**, then choose **Feature keys**.

The main feature key programming screen appears.

Bulk



3. Press the **Bulk** context-sensitive soft key.

The Program Key Bulk commands screen appears



4. Press the **Up/Down** navigation key to highlight **Feature key creation**.

Select



5. Press the **Select** context-sensitive soft key.

The Create keys screen appears.



6. Press the **Up/Down** navigation key to highlight the type of programmed keys you want to create by bulk command.

You can choose one of the following options:

- Speed Dial
- Send IM
- Call Forward

Select



7. Choose one of the following:

- Press the **Select** context-sensitive soft key.

If you press the **Select** context-sensitive soft key, the Select Source screen appears.

Back



- Press the **Back** context-sensitive soft key to dismiss the screen.



8. Press the **Up/Down** navigation key to highlight the source data for the bulk key creation.

You can choose one of the following options:

- Friends
- Groups (if you have existing groups in your address book)
- Address book

Select



9. Press the **Select** context-sensitive soft key.

- If you choose **Friends**, the bulk key creation process begins.
- If you choose **Address Book**, the bulk key creation process begins.
- If you choose **Groups**, the Select Group screen appears and prompts you to select the specific group you want to use for key creation.

or

Back



Press the **Back** context-sensitive soft key to dismiss the screen.

You can view existing groups in your address book if you selected Groups as the source data for the bulk key creation.

To view existing groups in your address Book if you selected Groups:



1. Press the **Up/Down** navigation key to highlight the source data (group) for the bulk key creation.

Select



Back



2. Choose one of the following:
 - Press the **Select** context-sensitive soft key to begin the bulk key creation process for the selected group.
 - Press the **Back** context-sensitive soft key to dismiss the screen and return to the screen where you can select the source data for bulk key creation.

Note: After you select from one of your existing groups, the bulk creation of the keys happens automatically.

Viewing the existing groups you have in your Address Book



Directory

1. When the IP Deskphone is in the idle mode, press the **Directory** fixed key to access your Address Book.

Filter



2. Press the **Filter** context-sensitive soft key to filter the list of entries displayed in your Address Book.

The Select Filter screen appears and displays all the existing groups in your address book, as well as the Friends filter.



3. Press the **Up/Down** navigation key to highlight the required filter.

Select



Back



View



All



Edit



Back



4. Choose one of the following:
 - Press the **Select** context-sensitive soft key to choose the group you want to view (for example, if you choose personal, only address book entries that are part of the group personal are displayed).

You are presented with the list of contacts currently part of the group you selected.

- Press the **Back** context-sensitive soft key to return to the dismiss the screen and return to the main address book screen.
5. Press the **Up/Down** navigation key to highlight the required entry.
 6. Choose one of the following options:
 - Press the **View** context-sensitive soft key to display the address book entry details for the selected entry.
 - Press the **All** context-sensitive soft key to return to the main address book screen (no filtering)
 - Press the **Edit** context-sensitive soft key to modify or delete an entry.
 - Press the **Back** context-sensitive soft key to dismiss the screen and return to the filter selection screen.

After the screen displays the details of the selected address book entry, you can do the following:

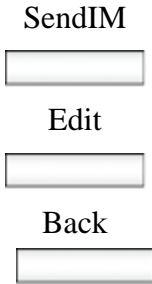

- Press the **SendIM** context-sensitive soft key to display the address book entry details for the selected entry.
- Press the **Edit** context-sensitive soft key to modify the displayed address book entry.
- Press the **Back** context-sensitive soft key to dismiss the screen and return to the main address book screen.

To add a new contact to your Address Book



Directory

1. When the IP Deskphone is in the idle mode, press the **Directory** fixed key to access your Address Book.

Add



2. Press the **Add** context-sensitive soft key.



Next

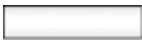

3. Choose one of the following:
 - Use the dialpad to enter a name for the new contact and press the **Next** context-sensitive soft key to continue.
 - Press the **Back** context-sensitive soft key to return to the previous menu.

Back





Next



Back



Yes



No



Back



4. Choose one of the following:
 - Use the dialpad to enter a telephone number or SIP address (URI) for the new contact. Press the **Next** context-sensitive soft key to continue.
 - Press the **Back** context-sensitive soft key to return to the previous menu.

5. Do one of the following to complete the entry:
 - Press the **Yes** context-sensitive soft key to add the new entry to an address book group.
 - Press the **No** context-sensitive soft key to add the entry to the address book without adding it to a group.
 - Press the **Back** context-sensitive soft key to return to the previous menu.

If you choose to add the new contact to a group, a list of all your existing groups is displayed, and the screen prompts you to select a group.

6. Press the **Up/Down** navigation key to highlight the required entry.

Select



Edit



Add



Back



7. Choose one of the following options:

- Press the **Select** context-sensitive soft key to assign your new address book entry to the group that you selected.
- Press the **Edit** context-sensitive soft key to modify the name of an existing group.
- Press the **Add** context-sensitive soft key to add a new group (invokes the add group screen).
- Press the **Back** context-sensitive soft key to dismiss the screen and return to the previous screen.

To add a new group:

Add



Ok

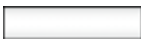

Back



1. From the Select Group screen, press the **Add** context-sensitive soft key.
2. Choose one of the following:
 - Use the dialpad to enter the group name, and then press the **Ok** context-sensitive soft key.

Note: If the name of the new group already exists, an error screen appears.

 - Press the **Back** context-sensitive soft key to return to the previous menu.

Speed Dial List

When configuring the provision, a feature key can be used as a Speed Dial List. You cannot modify or delete the feature key used by the Speed Dial List. Also, you cannot modify the content of the Speed Dial List.

Invocation of the speed dial list is similar to other feature key invocation. The Speed Dial List key causes a full screen list to appear and offers you a chance to automatically dial one of the offered choices.

The contents of the Speed Dial List varies based on the current call state of the IP Deskphone and the type of speed dial list entry configured.

Note: Only entries in the Speed Dial List can be context sensitive and not all speed dial keys/ individual feature keys.

A Speed Dial key or one included in a Speed Dial List can cause a call that it placed on hold (when invoked) to be un-held automatically (when call completes) based on a new value that must be configured when a Speed Dial key is created or configured.

Figure 66 on page 320 displays the feature key used by the speed dial list.

Figure 66: Main feature key screen



A feature key provisioned for use as a Speed Dial List has a similar appearance to all other programmed feature keys on the idle screen (or

in-call screen). The label used for the selected key is provided through provisioning.

The following is the icon for the Speed Dial List key.



After you press the feature key provisioned as a Speed Dial List, the list of Speed Dials configured appears on the screen and the you can select an item from that list to invoke a Speed Dial.

If the speed dial list is empty, or results in being empty due to context sensitive hiding of contents, an error message displays stating *There are no Speed Dials currently available.*

Speed Dial List screen

You can select the provisioned speed dial list entries from the speed dial list screen. [Figure 67 on page 321](#) displays the speed dial list screen with the list entries.

Figure 67: Speed dial list screen



The Speed Dial List screen displays all the speed dial list entries provisioned. The displayed list items are based on the provisioned list as well as the current Idle/Mid-call state of the IP Deskphone. After you invoke the speed dial list while the IP Deskphone is idle, only Speed Dial List entries that are configured to IDLE are displayed. Similarly, only items

marked as MID CALL are displayed if the Speed Dial List is invoked while the IP Deskphone is in a call.

The following are the options available for the Speed Dial List screen.

- **Dial**—invokes the selected speed dial.
- **Exit**— screen dismisses without invoking a Speed Dial List entry.

Auto retrieve flag

The Auto retrieve behavior is added to regular speed dial keys instead of speed dial list entries. To make sure that this flag is configured for programmed speed dial keys the screen in [Figure 68 on page 322](#) appears as the last step in Speed Dial Key creation.

Figure 68: Auto Retrieve enable screen

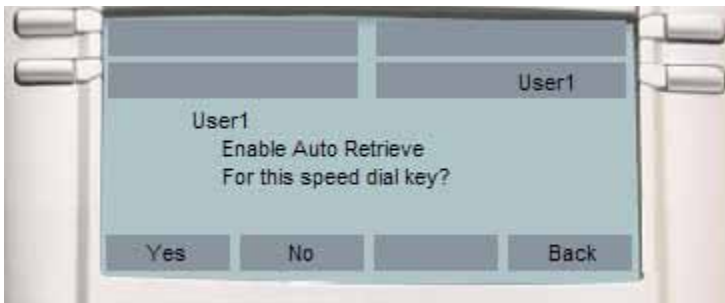

Auto Retrieve screen allows you to configure the auto retrieve behavior for the Speed Dial.

The following are the options available for the Auto Retrieve enable screen.

- **Yes**—to enable Speed Dial with Auto-Retrieve behavior.
- **No**—to disable Speed Dial with Auto-Retrieve behavior.
- **Back**—to dismiss the screen and sent you back to previous key programming screen.

If you enable the auto-retrieve behavior on a Speed Dial key or Speed Dial list entry that is invoked and place a call on hold to invoke the current key/entry, the IP Deskphone attempts to un-hold the call after the key or entry call completes.

For example:

- A is talking to B when A invokes their Speed Dial List and selects an entry.
- Selection/invocation of a Speed Dial List entry places the A-B call on hold and place another outgoing call to URI specified in the Speed Dial List entry, let's say C.
- When the A-C call completes, if the auto retrieve flag is enabled for the Speed Dial, then the IP Deskphone attempts to take call A-B off hold. This may not always happen if the IP Deskphone receives another call during the A-C call, or if the A-B call state is changed while A-C is active.

USB flash memory device support

The IP Deskphone supports the browsing of files on a USB flash memory device. A simple file browser allows you to select an image file (or other type of file) and upload onto the IP Deskphone file system. The file manager also allows you to browse and copy certain files from the phone file system onto a USB flash drive.

After you select the File Manager menu by choosing Services menu, you can navigate to the IP Deskphone file system and any USB drives attached. From there, you can either copy a file from the IP Deskphone onto their USB drive or from the USB drive to the IP Deskphone.

After you select a File manager, and there are no USB drives plugged into the IP Deskphone, the root screen of the IP Deskphone file system screen the screen that appears.

[Figure 69 on page 324](#) displays the root screen of the IP Deskphone file system.

Figure 69: Root screen



The following are the options available for the Root screen:

- **Select**—use to enter the selected folder.
- **Delete**—prompts you to delete contents of selected folder (folders are not deleted because they are on the IP Deskphone).
- **Exit**—If you are at the root folder of the flash disk, the screen is dismissed and you are sent back to previous menu. If you are already inside a folder, then the **Back** context-sensitive soft key acts the same as the **..** item and moves up one level in the directory structure.

After you select a File manager, and if the USB drives are plugged into the IP Deskphone, the screen that appears next is the **Select Device** screen. This screen lists the IP Deskphone, and USB drives that are available. After you select one of the items, the contents of that device (folders and files appears), and **..** allows you to navigate back to the select drive screen.

Figure 70 on page 325 displays the select device screen.

Figure 70: File manager select device screen

The following are the options available for the Select Device screen:

- **Select**—to enter the selected device.
- **Exit**—to dismiss the file manager and returns to the Services menu.

After you select the device you want to navigate, one of the following screens in [Figure 71 on page 326](#) appears:

Figure 71: File manager device browsing screen



The file manager browsing screen provides the following options:

Note: The context-sensitive soft keys change based on the selected item on the screen.

- **Select**—to enter into the selected folder.
- **Back**—to return to the previous screen
- **Delete:**
 - If you select a file, it prompts for deletion and deletes files. If you do not respond to the deletion prompt in 15 seconds, deletion is cancelled.
 - If you select a folder on IP Deskphone, it prompts for deletion of all contents of the folder but not the folder.
 - If you select a folder on USB device, it prompts for deletion of folder and all its contents. If you do not respond to the deletion prompt in 15 seconds, deletion is cancelled.
- **Send**—appears only after you select a file.
 - If you select a file on a USB device and press **Send**, you can send or copy the selected file to the IP Deskphone. Based on the file extension, the destination folder gets selected automatically (for example: PNG files are sent directly to Images folder on the IP Deskphone).
 - If you select a file on the IP Deskphone and press **Send**, an error message appears if there is no USB drive that is currently plugged into the IP Deskphone. Sending files from the IP Deskphone to another location on the IP Deskphone is not allowed.
 - If you select a file on the IP Deskphone and press **Send**, you are directed to the USB folder you want to send the file to [Select Destination Screen] while a USB drive is plugged in on the IP Deskphone.
- **Back**—to dismiss the current screen and returns you to the device selection screen.

File Manager Select Destination prompt screen

The File Manager Select Destination prompt screen allows you to select the folder you wish to send or copy the previously selected file into.

Figure 72 on page 328 displays the message to select the destination folder.

Figure 72: Select Destination

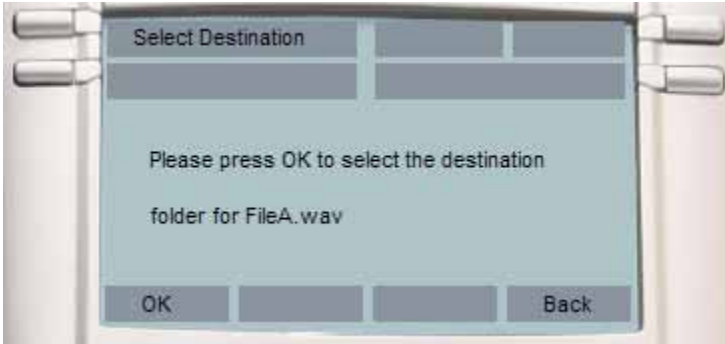

The following are the options available for the Select Destination screen.

- **OK**—to enter in to the selected folder.
- **Back**—to return to the previous screen.

After you have confirmed to send a file from the IP Deskphone to the USB drive, the Select Destination screen appears, as shown in [Figure 73 on page 329](#).

Figure 73: File Manager Select Destination screen



Note: The context-sensitive soft keys change based on the selected item on the screen.

Select—to enter the selected folder.

Done—to configure the current location as the destination for the send and initiates copy operation.

Back—to return to the previous screen.

Notes on File Manager

General notes for File Manager are as follows:

- Selection of the **..** item (or **Back** context-sensitive soft key) moves you one level up which results in going off the device and onto the **select device** screen in some cases. In the case of the current selection being a sub folder, the selection of **..** or the **Back** context-sensitive soft key has the identical behavior of moving up one level.
- Selection of a file causes the selected file to copy on to the IP Deskphone flash file system, or to invoke a specific handler for the selected file (configured after this screen is invoked by other mechanisms). Specific example of this is a device configuration file which causes the IP Deskphone to update with selected file rather than to copy the file to a folder.
- Based on the extension of the selected file, validation routines runs to verify the file size, the free space available on the FFS, including restrictions that can be defined for safe usage (example limit of XX images or ring tones on the IP Deskphone [based on model]).
- Files having unknown extension must not be available for any action. The IP Deskphone attempts to perform actions of file types and extensions it recognizes.

Scenarios for the use of the USB screens are as follows:

Scenario 1 - If you want to copy an image file from the USB drive into the IP Deskphone:

- Log on to the device and plug the USB flash drive into the IP Deskphone USB port.
- Press the **Services** hard key and choose **File Manager**.

- Select **Flash Disk device**. The contents of the device are displayed.
- Select the file you wish to copy and then press **Send**.
- You are prompted to select the device you wish to send the selected file.
- Select the IP Deskphone as the destination device.
- The file is validated based on the file extension and the passing of the validation routines and a handler is called for the file. In this case, the image file copies the **images** directory of the flash file system on the IP Deskphone.
- A success message appears on the screen displaying that the file is copied to the IP Deskphone successfully. [Figure 74 on page 331](#) displays a sample success message.

Figure 74: Sample success message for File Manager operation



Note: After a file is selected, there can be multiple reasons why the handling cannot complete. The file size may exceed allowed limits, there may not be enough space on disk, a file with the same name may already exist, or actions on the selected file type may not be allowed (configuration flag).

Error conditions display a message on the screen, and any action that may take some time to complete displays the *In progress...* message on the screen as shown in [Figure 75 on page 332](#).

Figure 75: Sample failure message for File Manager operation

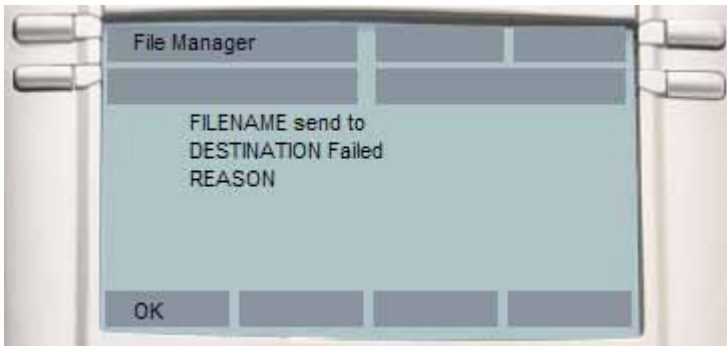

Scenario 2 - If you want to copy the ring tone from the IP Deskphone into the USB drive:

- Log into the device and plug the USB flash drive into the USB port of the IP Deskphone.
- Press the **Services** hard key and choose **File Manager**.
- Select the IP Deskphone from the select device screen.
- The contents of their IP Deskphone are displayed. Navigate to **Sounds** folder.
- Select the file you require and press the **Send** context-sensitive soft key.
- You are prompted to select the destination folder on the plugged in USB drive.
- Navigate to the folder **MyRings** and press the **Done** context-sensitive soft key to start the operation.
- The file is then validated (some files are not allowed to copy) and sent to the selected destination appears on the screen displaying that the file is copied on the IP Deskphone.

If file copying cannot complete due to insufficient space on the USB device, or due to the selected file type not being enabled in the File Manager (device configuration), then an error message is displayed on the screen.

An error message displays on the screen due to insufficient space on the USB device, or the selected file type not being enabled in the File Manager (device configuration).

Visual indicators

The IP Deskphone uses visual indicators or cues to indicate incoming calls and messages. The display icons on the IP Deskphone also indicate the current call state, the status of Inbox calls, and Instant Messages (IMs), and the Presence state of contacts designated as Friend.

Display screen icons

Table 18 on page 334 lists the display icons of the IP Deskphone.

Table 18: Display screen icons (Part 1 of 3)





Component	Icon
Call State	
On hook	
Incoming/Outgoing call (phone ringing)	
On the phone	
On hold	
Missed call	
Feature button icons	

Table 18: Display screen icons (Part 2 of 3)

















Component	Icon
Do Not Disturb	
Call Forward	
Speed Dial list	
Send IM	
Instant Messaging	
New, Unread	
Read	
Replied to	
Inbox	
Incoming Call Answered	
Incoming Call Missed, New	

Table 18: Display screen icons (Part 3 of 3)

Component	Icon
Incoming Call Missed, Reviewed	
Presence	
Terminated	
Connected Inactive	
Unavailable Busy or Offline	
Active Available	
On the Phone	
Unknown	

Visual Alerter/Message Waiting Indicators

The red LED light at the top right of the IP Deskphone lights to indicate incoming calls or when a caller leaves you voice mail. The blue LED light at the top left of the IP Deskphone lights to indicate when you receive a new Instant Message or when unread Instant Messages are present in your Instant Message Inbox.

Table 19 on page 337 lists the visual indicator and the LED status.

Table 19: Visual Alerter/Message Waiting Indicator

LED	Visual indicator	LED status
Red LED	Voice mail left by caller	Steady red light until message is reviewed.
	Incoming call (phone ringing)	Fast blinking red light.
Blue LED	New Instant Message received	Steady blue light until message is reviewed.
	New Instant Message received when other unread Instant Messages are in the Inbox	Single flash and returns to steady blue light.
	Instant Message pop-up appears and a new Instant Message received	Steady blue light until the Instant Message is reviewed or you press the Exit context-sensitive soft key.

Multi-Level Precedence and Preemption

Overview

The Multi-Level Precedence and Preemption (MLPP) service functionality allows you to place calls at varying levels of precedence; that is, you can specify the precedence level of each call you place.

Higher precedence calls preempt those lower in precedence when a user has no free call appearances.

**WARNING**

Emergency 911 calls are preempted when there are no available call appearances and there is an incoming above-Routine precedence call.

You can only initiate a call with a precedence level equal to or below the authorized precedence level that is configured for you. Any call you make automatically defaults to Routine, unless you choose a higher precedence. During call processing, this precedence level is used to assure preferential call completion of higher precedence calls within the same MLPP service domain, even if that means preempting lower precedence calls. Once you set the precedence level for a call, the precedence level for that call cannot be changed.

The precedence levels are:

- Routine
- Priority
- Immediate
- Flash
- Flash-Override

Other MLPP service features

The MLPP service also includes the following features:

- Call Origination Busy
- Re-authorization
- Speakerphone exclusive to 911 Emergency

Call Origination Busy

The Call Origination Busy feature prevents incoming calls from disrupting your outbound call address entry sequence. If enabled, this means that if you are placing an outbound call either by lifting the receiver and entering digits or your phone is on-hook and you are entering digits, you cannot be disturbed by any incoming call.

Re-authorization

With the re-authorization feature, you are asked to re-enter your password if your user password changes (changed by administrator) while you are logged in to your IP Deskphone. Previously, you would have had no indication that your password had been changed and would have constantly seen error messages when trying to place a call. The Re-authorization feature lets you enter your new password without having to log out of your IP Deskphone.

Speakerphone exclusive to 911 Emergency

If this feature is enabled, speakerphone is allowed only for making 911 Emergency calls or receiving calls from the 911 Emergency operator. The speakerphone restriction is applicable to both the Handsfree key and line keys. As well, when this feature is enabled, the Answer soft key is not displayed for an incoming call and you cannot answer a call by pressing the Handsfree key or line key, except for calls from the Emergency 911 operator. To answer any other call, you must go off-hook.

During an active call, you cannot go handsfree by pressing the Handsfree key.

Making a call with MLPP

If your IP Deskphone is configured for MLPP, the display screen is enhanced for making and receiving precedence calls. There are several ways to make outgoing calls from your IP Deskphone with MLPP, as follows:

- Make a call by going off-hook.
- Make a call by using an entry in the inbox or outbox call logs.
- Make a call from the personal and global Address Book, or from your Friends list.
- Make a call from a received Instant Message.
- Make a call from a programmed key.

The precedence level is not saved in any of the calling methods in the preceding list. For example, if you make a precedence call by going off-hook, and then call the party back using the Redial key, the precedence is not applied unless you select a precedence from the Redial menu. If a precedence level is not specified when dialing, the call is a Routine precedence call.

Precedence ringback tone

When you make a precedence call, you hear a ringback tone, indicating that you have made a precedence call.

Making an MLPP call by going off-hook

There are three ways to go off-hook in order to make a call.

1. **Handsfree key.** Press the Handsfree key to go off-hook on the primary line (the green line button) and produce a dial tone.
2. **Line keys.** Press any provisioned line key to go off-hook and produce a dial tone.
3. **Handset.** Pick up the handset to go off-hook on the primary line and produce a dial tone.

Once off-hook, the display prompts you for the destination address information. The icon on the display screen indicates the line is off-hook

and you can select the precedence of the call by pressing the **Prec** soft key.

Note: You can press the Good-bye key at any time to disconnect from the call.

1. Go off-hook and press the **Options** soft key. See [Figure 76](#).

Figure 76: Options soft key

	jdoe t ▲		
Ln1 jdoe	06/06 8:31am		
t ▲ >			
Routine			
Subj: Hello			
Redial	123	VMail	Options

The **Options** menu is displayed. See [Figure 77, "Options menu"](#), on page 343.

Figure 77: Options menu

	jdoe t ▲
Ln1 Options	06/06 8:31am
1. Precedence Level	
2. Subject	
Select	Back

- Use the up and down navigation keys to select **Precedence Level** and then press the **Select** soft key. The **Precedence Level** screen is displayed. An example is shown in [Figure 78](#).

Figure 78: Precedence Level menu example

	jdoe t ▲
Ln1 Precedence	06/06 8:31am
2. PRIORITY	
3. IMMEDIATE	
4. FLASH	
Select	Back

- Use the up and down navigation keys to select the desired precedence level and then press the **Select** soft key.
- Dial the destination of the call and press the **Send** soft key. See [Figure 79](#).

Figure 79: Off-hook screen with dialed destination and precedence

		jdoe t ▲	
Ln1 jdoe		06/06 8:31am	
t ▲ > jonn			
Flash			
Subj: Hello			
Send		Alpha	Options

Alternatively, press the **Redial** soft key to call the last dialed destination.

Note: The **Redial** soft key only appears if a number or address was previously entered

When either **Send** or **Redial** is pressed, the IP Deskphone places the call and displays the outgoing call. An example is shown in [Figure 80](#), "Outgoing call", on page 345

Figure 80: Outgoing call

	John T ▲
Ringing	06/06 8:31am
☎)) > To: john (john@xwz.com)	
Flash	
Subj: Hello	

Making an MLPP call using Inbox/Outbox, Address Book, and Friends List

You can place a call from multiple areas of the IP Deskphone interface, including the Inbox/Outbox, Call Logs, Address book, and Friends list.

1. Press the Inbox or Outbox key, or the Directory key to access your Address Book or Friends list, to choose from a list of previously-stored numbers.
2. Once in the application-specific menu, select the desired entry using the navigational up and down keys.
3. After the number is highlighted, press the **Select** soft key.
4. Go off-hook.

The IP Deskphone displays the off-hook screen containing the selected entry and the option to select the precedence.

5. Press the **Prec** soft key and navigate to the desired precedence.
6. Press the **Select** soft key.
7. Press the **Send** soft key to initiate the call.

Making an MLPP call from a received Instant Message

1. Navigate to the Instant Message (IM) inbox by pressing the **Msgs** context-sensitive soft key; then select **Instant Messaging** from the menu.

Alternatively, press the **Expand** fixed key.

2. Press the navigational up and down keys to highlight an IM from the list of Instant Messages in your IM Inbox/Outbox.
3. Press the **View** soft key to display the selected IM. See [Figure 81](#).

Figure 81: IM selection screen

IMBox: All			
1. ggrissom			
2. John			
View	User	New IM	Exit

The selected IM is displayed. See [Figure 82 on page 347](#).

Figure 82: IM display

Received			
From: "John"			
john@xyz.com			
Time: 04/02/07 11:54 AM			
Hello, this is an instant message!			
Reply	Call	Delete	Back

4. Press the **Call** soft key.

The IP Deskphone displays the off-hook screen containing the address in the idle screen and the precedence option. See [Figure 83](#).

Figure 83: IM screen with precedence option

		jdoe [▲]	
Ln1 jdoe	06/06 8:31am		
[▲] >John			
Routine			
Subj: Hello			
Send			Prec

5. Press the **Prec** soft key and navigate to the desired precedence.
6. Press the **Select** soft key to select the desired precedence.
7. Press the **Send** soft key to initiate the call.

Making a call by using a programmed speed dial key

1. Press the pre-programmed speed dial key.
2. Go off-hook.

The IP Deskphone displays the off-hook screen containing the address assigned to the speed dial key. See [Figure 84](#).

Figure 84: Off-hook speed dial screen

		jdoe [▲]	
Ln1 jdoe	06/06 8:31am		
[▲] >john			
Routine			
Subj: Hello			
Send			Prec

3. Press the **Prec** soft key and navigate to the desired precedence.
4. Press the **Select** soft key to select the desired precedence.
5. Press the **Send** soft key to initiate the call.

Incoming calls with precedence

Four types of incoming calls with precedence can be displayed.

1. Precedence call without subject
2. Precedence call with subject
3. Redirected precedence call without subject
4. Redirected precedence call with subject

Note: When there is a call with an incoming precedence level higher than Routine, the **Redirect** and **Decline** soft keys are not displayed.

Precedence alerting tone

A precedence alerting tone is played to alert you that a precedence call with a precedence level higher than Routine is arriving. This tone is delivered through the Handsfree speaker. This tone is played if there is no active call or if a call is on hold.

Precedence Call Waiting tone

When a call with a precedence level higher than Routine is received, and you are busy with another call, the precedence Call Waiting tone is played instead of the normal Call Waiting tone. This tone is delivered through the Handsfree speaker.

Incoming precedence call display

The first line of the IP Deskphone displays the caller's information (From) with the ringing phone icon.

The second line displays the precedence level.

The third line displays the person who is being called (callee). If the incoming call has a subject, the third line displays the subject alternating with the person who is being called. The display cycles between the two every six seconds. An example is shown in [Figure 85 on page 350](#).

Figure 85: Incoming precedence call with subject

		Jdoe 📞))	
Ln1 jdoe		06/06 8:31am	
📞)) > From: Smith (Smith@xyz.com)			
Flash			
To: Kelly (alternates with) Subj: Hello			
Answer		Ignore	

Incoming redirected precedence call display

The first line of the IP Deskphone always displays the caller's information (From) with the ringing phone icon.

The second line displays the precedence level.

The third line displays the original person who was being called (original callee). If the incoming call has a subject, the third line displays the subject alternating with the original person who was being called. The display cycles between the two every six seconds.

Call transfer with precedence

Direct transfer and transfer to voicemail

For a direct transfer or transfer to voicemail, the precedence level of the transferred call is re-used and the precedence selection screen is not shown.

Consultative transfer

When doing a consultative call transfer, the Call Server does not know if the precedence of the transferred call can be re-used. Therefore you can only use a precedence level that you are authorized to use.

You may want to transfer the call with a precedence level higher than the authorized level of the caller being transferred. You can specify the precedence to use when making the consultative call. To enable this, the precedence selection screen is displayed after you select a consultative transfer. For information on making a consultative transfer, see [“Transferring a call” on page 209](#).

You can only choose a precedence level that you are authorized to use. The default value is Routine.

In a consultative transfer, the precedence level of the transferred call is the higher level of the initial call and the consultative call. For example, Person A calls Person B with a precedence level of Immediate. During the call, Person B performs a consultative transfer to Person C with a precedence level of Flash during the consultation. When the call is finally transferred, the transferred call has a precedence level of Flash, even if the call initially had a precedence level of Immediate.

Multiple calls

When there are multiple calls on the IP Deskphone, each call is displayed as a single line on the screen.

If the line is wider than the screen capacity, scroll left and right to see more information.

If there are multiple incoming calls, calls are displayed on the IP Deskphone in the order of precedence from highest to lowest. If the calls have the same precedence, then the calls are displayed in order of the age of the call, from oldest to newest.

A maximum of two calls are presented at one time.

When a call is displayed, the related tone is played as well.

Example:

There are 4 incoming calls in the following order and you have not gone off-hook:

1. Caller A, Flash (oldest or first coming)
2. Caller B, Routine (next oldest or second coming)
3. Caller C, Routine (third oldest or third coming)
4. Caller D, Priority (newest or just coming)

The calls are presented in the following order.

1. The call from Caller A is displayed first, since it has the highest precedence of all incoming calls.
2. If Caller A's call is answered, then the call from Caller D is displayed using the other free call appearance, since it has the second-highest precedence of B,C, and D.
3. If Caller D's call is answered, then the call from Caller B is displayed, since it is the most recent (if Call A has ended. If not, Caller B hears a Busy signal, since call appearances are limited to two.)
4. If Caller B's call is answered, then the call from Caller C is displayed (if Caller D has hung up).

Preemption

Only two simultaneous calls can be presented. If your IP Deskphone reaches the maximum call limit and you receive a higher precedence call, then one of the existing calls is preempted in order to present the higher-precedence incoming call. An incoming call with a precedence level less than or equal to the already-received call precedence levels is not presented.

Note: Emergency 911 calls can be preempted when there are no available call appearances and there is an incoming above-Routine precedence call.

IM sessions cannot be preempted because they do not count as a call appearance.

Order of call preemption

The following is the order of call preemption:

1. the lowest precedence call
2. If there are multiple calls on the same precedence level, then the following order is used
 - a. any outgoing call that is unanswered
 - b. the oldest incoming call that is unanswered
 - c. the oldest held call

Preemption scenarios and behavior

The following table describes the IP Deskphone behaviors that occur when receiving a call of higher precedence than the presented current calls and no call appearances are available.

Table 20: When a preemption call is received

Call state	Preemption behavior
While on an active call	<ol style="list-style-type: none"> 1. Preemption tone is played through the Handsfree speaker. 2. The active call is removed. 3. The preemption acknowledgment screen is displayed. See Figure 86, "Preemption acknowledgement screen", on page 355. 4. When the preemption call is acknowledged by pressing OK, the preemption tone is ended and the new preemption precedence call is displayed.

Table 20: When a preemption call is received

Call state	Preemption behavior
While a call is on hold	<ol style="list-style-type: none"> 1. Preemption tone is played through the Handsfree speaker for three seconds. 2. The preempting call presents with the appropriate ringing. 3. The new preemption precedence call screen is displayed.
An incoming call is ringing	<ol style="list-style-type: none"> 1. The preempting call presents with the appropriate ringing. 2. The new preemption precedence call screen is displayed.
An outgoing call is ringing	<ol style="list-style-type: none"> 1. The preemption tone plays continuously in the Handsfree speaker for few seconds. 2. The outgoing call is removed. 3. The preemption acknowledgment screen is displayed. See Figure 86, "Preemption acknowledgement screen", on page 355. 4. 4.When the preemption is acknowledged, or after three seconds elapse: <ol style="list-style-type: none"> a. Preemption tone stops. b. The new preemption precedence call screen is displayed. c. The preempting call presents with the appropriate ringing.

Figure 86: Preemption acknowledgement screen

	jdoe [▲]
Ln1 jdoe	06/06 8:31am
[▲] > From: John	
(Routine)	
Reason: Preempted	
OK	

External preemption

The IP Deskphone supports preemption from external sources.

The following table describes the IP Deskphone behaviors that occur when receiving a call from an external source with higher precedence than the presented current calls and no call appearances are available.

Table 21: When a preemption call is received from an external source

Call state	Preemption behavior
While on an active call/music on hold	<ol style="list-style-type: none"> 1. Preemption tone is played through the handsfree speaker. 2. The active call is removed. 3. The preemption acknowledgment screen is displayed. See Figure 86, "Preemption acknowledgement screen", on page 355. 4. When the preemption call is acknowledged by pressing OK or after 5 minutes, the preemption tone is ended and the new preemption precedence call is displayed.
While a call is on hold (remote or local)	<ol style="list-style-type: none"> 1. Preemption tone is played through the handsfree speaker. 2. The new preemption precedence call screen is displayed. 3. 3. When preemption is acknowledged (or after 3 seconds), the preemption tone stops.
An incoming call is ringing	<ol style="list-style-type: none"> 1. The incoming call is removed.

Table 21: When a preemption call is received from an external source

Call state	Preemption behavior
An outgoing call is ringing	<ol style="list-style-type: none"> 1. The preemption tone plays continuously in the Handsfree speaker for few seconds. 2. The preemption acknowledgment screen is displayed. See Figure 86, "Preemption acknowledgement screen", on page 355. 3. When the preemption is acknowledged or after three seconds elapse, the preemption tone stops.

Call Origination Busy

When Call Origination Busy is enabled, incoming calls are prevented from disturbing you when you are in the process of making an outbound call.

When your IP Deskphone is on-hook or off-hook and you enter the first digit or character, then any call that comes in during the entry sequence is not presented to you.

Incoming calls are shown when you cancel the outbound call by pressing Goodbye, or when you place the receiver on-hook and the IP Deskphone goes back to the idle state.

If you place an outbound call, and that outbound call rings or receives a busy signal, any incoming call that was not presented is then presented.

Note: The outgoing call cannot be preempted by any call until the outgoing call rings or receives a busy signal.

The following sections describe Call Origination Busy behavior in various scenarios.

Incoming call while dialling outbound number + one free call appearance line

When you enter the first digit or character to make a new call, then any call that comes in during this time is not presented. The incoming call hears ringback tone.

Your dial pad entry sequence is not interrupted. The incoming call is shown to you when:

- you complete dialling your call and ring or busy signal is heard. The incoming call is presented if the incoming call has not hung up. You can decide to answer the call.
- you decide to cancel dialling by pressing Goodbye or hanging up. The incoming call is presented if the incoming call has not hung up. You can decide to answer the call.

Incoming call while dialling outbound number + held call with priority higher then incoming call

When you enter the first digit or character to make a new call, then any call that comes in during this time is not presented.

Your dial pad entry sequence is not interrupted. Since the incoming call is of lower precedence than the held call and you are entering digits for another call, the incoming call is sent a busy response. The caller sees a User is Busy message. See [Figure 87](#).

Figure 87: User is Busy message

	Declined		5:14
User is Busy			
OK			

Note: The held call and the process of placing the second call are counted as two consumed call appearances.

Incoming call while dialing outbound number + held call with priority lower then incoming call

When you enter the first digit or character to make a new call, then any call that comes in during this time is not presented.

If the held call is lower in precedence than the incoming call, the held call can be preempted and a notification is shown on screen for both local and remote users. You receive notification that the your held call has been preempted. See [Figure 88](#). After three seconds, or after you press the **OK** soft key on the preemption screen, you are then taken back to the previous screen where you were entering the address for your outgoing call. Your previously entered digits are not discarded.

Figure 88: Notification of preemption of held call

	jdoe [▲]
Ln1 jdoe	06/06 8:31am
[▲] > From: John	
(Routine)	
Reason: Preempted	
OK	

This temporary disturbance is allowed because the held call was known to you and you need to know that the call on hold has been preempted.

The incoming call that preempted the held call is shown when:

- you complete dialing the call and a ring or busy signal is heard. It may be possible that the outgoing call can be preempted but only after ring or busy signal is heard. The incoming call is presented if the incoming call has not hung up. You can decide to answer the new incoming call
- you decide to cancel dialing and the IP Deskphone goes back to the idle screen again. This allows the incoming call to be presented if the

incoming call has not hung up. You can decide to answer the new incoming call.

Re-authorization

While you are logged in to your IP Deskphone, the administrator may change your password. Consequently, any call or network request placed by you is responded to with an error message.

When the Re-authorization feature is enabled, your password is changed by the administrator, and you are trying to place a call, you can enter your new password, when prompted, without having to log out of your IP Deskphone.

If you enter the new password correctly, the call is placed and your password is updated on the IP Deskphone.

If you enter an incorrect password, then an error message is displayed, you hear a busy tone, and the IP Deskphone returns to the idle state.

Feature interactions with MLPP

Table 22 lists feature interactions with MLPP.

Table 22: Feature interactions with MLPP

Call Parking	Not available when MLPP is enabled.
Call Transfer - Direct	Available, but precedence of call must be maintained.
Call Transfer - Consultative	Available. A consultation call can have its own precedence level. The transferred call uses the greater precedence level of the initial call and the consultative call.
Conference call (Ad-hoc conference)	Available. The precedence level of the conference is the greatest of all the joined calls.

Table 22: Feature interactions with MLPP

Call Waiting Disabled	Not available when MLPP is enabled.
Multiuser	<p>When MLPP is enabled, only one user can be logged on to the IP Deskphone.</p> <p>If an MLPP user is logged on to the IP Deskphone, other user logons are blocked.</p> <p>If a non-MLPP user is logged on and a MLPP user attempts to log on, then when the IP Deskphone detects the new user is an MLPP user, the MLPP user is automatically logged off. The MLPP user cannot log on until the other user is logged off.</p>
Speakerphone	Available only for 911 calls when the Speakerphone Exclusive to 911 Emergency feature is enabled.









Quick reference







This section provides a quick reference guide for the IP Deskphone. See the following sections for more information:





- “Fixed keys” on page 363
- “Commonly used functions” on page 365
- “Context-sensitive soft keys” on page 368
- “Display screen icons” on page 372

Fixed keys

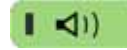
The Avaya 1120E IP Deskphone is available with either icon fixed keys or English text fixed keys. Both types are presented below.

Short-cut and navigation function keys	
 	Copy information from the Address Book, Inbox, Outbox, and IM log and to Feature keys and Address Book entries.
 	Access Search, Login, Logout, Check For Updates, Reset Phone, File Manager, Logging System, and Phone Information. Press twice quickly to access the Network menu.
 	Quit or exit from a menu.
 	Access your inbox to view all calls or missed calls and to return a call.

 <i>Shift/Outbox</i>	<p>Access your outbox to view all calls made and to place a call to a previously called contact.</p>
 <i>Directory</i>	<p>Access your address book to view, add or edit entries including your designated friends You can also send Instant Messages (IMs) or initiate a call.</p>
	<p>Use the Enter key to select highlighted menu items and to set preferences. The Enter key duplicates the function of the phone and select context-sensitive soft keys.</p>
<p>Telephone feature keys</p>	
 <i>Volume +</i>	<p>Use to increase the volume of the handset, headphones, phone speaker (handsfree) and alerting volume (phone ringing).</p>
 <i>Volume -</i>	<p>Use to decrease the volume of the handset, headphones, phone speaker (handsfree) and alerting volume (phone ringing).</p>
 <i>Mute</i>	<p>Use mute to listen to the call without transmitting. The red LED on the Mute key lights when the Mute feature is enabled.</p>
 <i>Handsfree</i>	<p>Activates the built in speaker and microphone. The red LED on the Handsfree key lights when the Handsfree feature is enabled.</p>

	<p>Use to release a call (hang up) and to exit a menu when not on an active call.</p>
	<p>Access Instant Message log to view and send IMs</p>
	<p>Activates your IP Deskphone headset when connected. The red LED of the Headset key lights when you use a headset.</p>
	<p>Use to place a call on hold or to retrieve a call on hold.</p>

Note: The **abc/123** context-sensitive soft key toggles between alphabetic and numeric input. When the context-sensitive soft key label is **abc**, you can enter alphabetic text and when the context-sensitive soft key label is **123**, you can enter numbers.

Commonly used functions

Procedures for the most commonly used functions are provided below.

Login

1. Enter your User ID and press the **Login** key.
2. Enter your password and press the **Next** key.
3. To permanently login, press the **Next** key.
To login for a period of time, press the **Timed** key, enter the duration of your login, and press the **Next** key.

Logout

1. Press the **Services** hard key and then select **Logout**.
2. Press the **abc/123** context-sensitive soft key to toggle between alphabet and numeric input.
3. Press **Logout** context-sensitive key.

Making a call

- Lift the **Handset** or press the **Headset** key, **Handsfree** key or the **Line** key and enter the SIP address or phone number and press send. Or, press the **Redial** key to call the previously entered SIP address or phone number.
- Press the **Directory** hard key, select **Friends**, select an entry, press **Status**, and then press the **Call** key.
- Press the **Services** hard key, select **Search**, select an entry in the Address Book, and then press the **Call** key. Lift the **Handset** or press the **Headset** key, **Handsfree** key or the **Line** feature key and dial from the Address Book or Inbox/Outbox as follows:
 - 1. Press the **Address Book** or **Inbox** or **Outbox** key.
 - 2. Navigate to the required entry.
 - 3. Press the **Select** key to connect.

Answering a call

Perform one of the following to answer a call:

- Press the **Handsfree** key
- Press the **Headset** key
- Press the **Line** key
- Press the **Answer** key
- Pick up the **Handset**.

If you choose not to answer the call, you can press one of the following keys:

- **Redrct**—Redirects the call to another party or number.
- **Decline**—Rejects the call and provides the caller with fast busy and no option to go to voice mail. You can provide a reason for declining the call.

Ignore—Stops call ringing

Making an emergency call

To make an emergency call, logging on is not required. Choose one of the following options:

- Lift the **Handset** and dial the emergency number.
- Press the **Handsfree** key and dial the emergency number.
- Press the **Headset** key and dial the emergency number.

Initiating a conference call

1. During a call, press the **Conf** Context-sensitive soft key.
2. Enter the SIP address or phone number or select an entry from the Address Book, Inbox, or Outbox and complete the call.
3. Press the **Join** key, select **Conference** and press the **OK** key to create a conference call. You can continue to add more callers to the conference call by repeating the above steps.

Context-sensitive soft keys

The following context-sensitive key menus are provided below:

- [“Idle phone display” on page 368](#)
- [“Active call display” on page 370](#)

Idle phone display

<p>Redial abc Msgs More...</p>
<p>More... context-sensitive soft key menu (first)</p> <p style="text-align: center;">CallFWD DND Retrve More...</p>
<p>More... context-sensitive soft key menu (second)</p> <p style="text-align: center;">ScrnSvr Presnce Prefs More...</p>

When you press the **More...** context-sensitive soft key for the third time, you return to the first menu list.

A description of the context-sensitive soft keys available with the phone is idle is provided below.

Redial or NewCall

Redial the last dialed number.

- If there is no stored redial number, **NewCall** appears and has the same effect as pressing the primary user line key (dial prompt).

abc or 123

Toggle between alpha and numeric input modes.

- To type letters, **abc** must be displayed.
- To type numbers, press **abc** to display **123** on the menu list.

Msgs

Display the Messages menu.

1. Voice Mail—Use to access your Voice Mail. The IP Deskphone connects to the server to retrieve your Voice Mail.

2. Instant Messaging—Use to access your IM box. From the IM box you can:

- View received Instant Messages
- Delete Instant Messages
- Send Instant Messages.

CallFwd

Forward all calls to a specified address.

DND

Block all calls.

Retrve

Retrieve parked calls (local and server parked calls only).

ScrnSvr

Activate the screensaver (only if the screensaver feature is enabled).

Presnce

Configure the presence status for your IP Deskphone.

Prefs

Display the Preferences menu.

1. **Display**—Adjust screen display settings.
2. **Audio**—Adjust tones and volume settings and configure a USB headset.
3. **Feature Options**—Program feature keys, call decline reasons, call ignore actions, and call subjects, call fwd notification.
4. **Language**—Change language.
5. **Misc Options**—Set alpha dialing, search method, privacy settings, # Ends dialing, location, and time.
6. **Network**—Access Server Settings, Device Settings, Diagnostics and Lock.
7. **USB Locks**—Enable or disable USB devices.
8. **User Settings**—Modify call settings, IM settings, voice mail setting, and remembering settings.

More

Select a new menu list.

- When you press **More...**, a different selection of Context-sensitive soft keys appears.
 - Press once to switch to: **[CallFwd] [DND] [Retrve]**.
 - Press twice to switch to: **[ScrnSvr] [Presnce] [Prefs]**.
 - Press three time to switch back to the main menu list: **[Redial] [abc] [Msgs]**.

Active call display

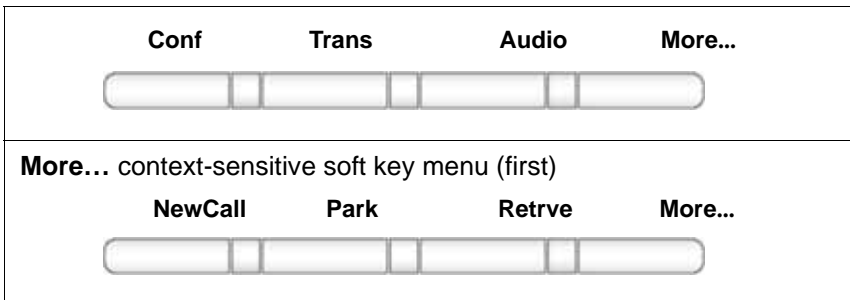

More... context-sensitive soft key menu (second)

When you press the **More...** context-sensitive soft key for the third time, you return to the first menu list.

A description of the context-sensitive soft keys available with the phone is idle is provided below.

Conf	
Obtain a dial tone to place another call during an active call. <ul style="list-style-type: none"> • Use to make a conference call. • Behaves like the NewCall Context-sensitive soft key. 	
Trnsfer	
<ul style="list-style-type: none"> • Transfer the current call to another location or contact. 	
Audio	
1. Change audio setting —Use to change the audio settings based on the available bandwidth. 2. Monitor audio quality —Diagnostic tool to monitor the audio quality.	
NewCall	
Obtain a dial tone to place another call during an active call. <ul style="list-style-type: none"> • Use to make a conference call. • Behaves like the Conf Context-sensitive soft key. 	
Park	
Park the current call to the server or another user (not available for all call servers).	
Retrve	
Retrieve parked calls (local and server parked calls only).	
Prefs	

See “Idle phone display” on page 368.

More...





Select a new menu list.











- When you press **More...**, a different selection of Context-sensitive soft keys appears.
 - Press once to switch to: **[NewCall] [Park] [Retrve]**.
 - Press twice to switch to: **[Prefs] [] []**.
 - Press three time to switch back to the main menu list: **[Conf] [Trnsfer] [Audio]**.





Display screen icons

The table below provides a list of the following display screen icons:

- **Call state**—Icons to indicate the Call state of your phone.
- **Instant Messaging**—Icons displayed when you view your instant message log. The icon appears beside each IM to indicate the status.
- **Inbox**—Icons to indicate the status of each incoming calls in your Inbox.
- **Presence**—Icons to indicate the presence state of those address book entries you designate as Friend.

Call state	Icon
On hook	
On the phone	
On hold	
Call Forward	

Do Not Disturb	
Outgoing call, Incoming call (ringing)	
Missed call	
Instant messaging	Icon
New, unread	
Read	
Replied to	
Inbox	Icon
Incoming Call Answered	
Incoming Call, Missed, New	
Incoming Call, Missed, Reviewed	
Presence	Icon
Terminated	
Connected Inactive (only available if audio presence is activated)	

Unavailable Busy, or Offline	
Active Available (only available if audio presence is activated)	
On the Phone (only available if audio presence is activated)	
Unknown	

Third party terms

Third Party Terms for Avaya 11xx 12xx sw release 3.0 thru 4.0 (Aug - Nov 2010)

Certain portions of the product ("Open Source Components") are licensed under open source license agreements that require Avaya to make the source code for such Open Source Components available in source code format to its licensees, or that require Avaya to disclose the license terms for such Open Source Components. For a period of three years from your date of purchase of a product containing any of the software listed below from Avaya Inc., any Avaya affiliate or an authorized Avaya reseller, we will provide upon request a complete machine readable copy of the source code for such Open Source Component on a medium customarily used for software interchange for a charge no more than our cost of physically performing source distribution. To get access to the source code, you may contact Avaya at (408) 577-7666.

The Open Source Components are provided "AS IS". ANY EXPRESS OR IMPLIED WARRANTIES, INCLUDING, BUT NOT LIMITED TO, THE IMPLIED WARRANTIES OF MERCHANTABILITY AND FITNESS FOR A PARTICULAR PURPOSE ARE DISCLAIMED. IN NO EVENT SHALL THE COPYRIGHT HOLDERS OR THE CONTRIBUTORS OF THE OPEN SOURCE COMPONENTS BE LIABLE FOR ANY DIRECT, INDIRECT, INCIDENTAL, SPECIAL, EXEMPLARY, OR CONSEQUENTIAL DAMAGES (INCLUDING, BUT NOT LIMITED TO, PROCUREMENT OF SUBSTITUTE GOODS OR SERVICES; LOSS OF USE, DATA, OR PROFITS; OR BUSINESS INTERRUPTION) HOWEVER CAUSED AND ON ANY THEORY OF LIABILITY, WHETHER IN CONTRACT, STRICT LIABILITY, OR TORT (INCLUDING NEGLIGENCE OR OTHERWISE) ARISING IN ANY WAY OUT OF THE USE OF THE PRODUCT, EVEN IF ADVISED OF THE POSSIBILITY OF SUCH DAMAGE.

The following component is licensed under Public Domain:

DateTime

*

PUBLIC DOMAIN NOTICE

* National Center for Biotechnology Information

*

* This software/database is a "United States Government Work" under the terms of the United States Copyright Act. It was written as part of the author's official duties as a United States Government employee and thus cannot be copyrighted. This software/database is freely available to the public for use. The National Library of Medicine and the U.S. Government have not placed any restriction on its use or reproduction.

*

* Although all reasonable efforts have been taken to ensure the accuracy and reliability of the software and data, the NLM and the U.S. Government do not and cannot warrant the performance or results that may be obtained by using this software or data. The NLM and the U.S. Government disclaim all warranties, express or implied, including warranties of performance, merchantability or fitness for any particular purpose.

*

* Please cite the author in any work or product based on this material.

*

* =====

*

* Authors: Anton Butanayev, Denis Vakatov, Vladimir Ivanov

END OF TERMS AND CONDITIONS

GNU

The following component is licensed under the GNU General Public V2 license:

libstdc++ Copyright (C) 1989, 1997, 1998, 1999 Free Software Foundation, Inc.

GNU General Public V2 License

GNU GENERAL PUBLIC LICENSE Version 2, June 1991 Copyright (C) 1989, 1991 Free Software Foundation, Inc. 59 Temple Place - Suite 330, Boston, MA 02111-1307, USA Everyone is permitted to copy and distribute verbatim copies of this license document, but changing it is not

allowed. Preamble The licenses for most software are designed to take away your freedom to share and change it. By contrast, the GNU General Public License is intended to guarantee your freedom to share and change free software--to make sure the software is free for all its users. This General Public License applies to most of the Free Software Foundation's software and to any other program whose authors commit to using it. (Some other Free Software Foundation software is covered by the GNU Library General Public License instead.) You can apply it to your programs, too. When we speak of free software, we are referring to freedom, not price. Our General Public Licenses are designed to make sure that you have the freedom to distribute copies of free software (and charge for this service if you wish), that you receive source code or can get it if you want it, that you can change the software or use pieces of it in new free programs; and that you know you can do these things. To protect your rights, we need to make restrictions that forbid anyone to deny you these rights or to ask you to surrender the rights. These restrictions translate to certain responsibilities for you if you distribute copies of the software, or if you modify it. For example, if you distribute copies of such a program, whether gratis or for a fee, you must give the recipients all the rights that you have. You must make sure that they, too, receive or can get the source code. And you must show them these terms so they know their rights. We protect your rights with two steps: (1) copyright the software, and (2) offer you this license which gives you legal permission to copy, distribute and/or modify the software. Also, for each author's protection and ours, we want to make certain that everyone understands that there is no warranty for this free software. If the software is modified by someone else and passed on, we want its recipients to know that what they have is not the original, so that any problems introduced by others will not reflect on the original authors' reputations. Finally, any free program is threatened constantly by software patents. We wish to avoid the danger that redistributors of a free program will individually obtain patent licenses, in effect making the program proprietary. To prevent this, we have made it clear that any patent must be licensed for everyone's free use or not licensed at all. The precise terms and conditions for copying, distribution and modification follow.

TERMS AND CONDITIONS FOR COPYING, DISTRIBUTION AND MODIFICATION

0. This License applies to any program or other work which contains a notice placed by the copyright holder saying it may be distributed under the terms of this General Public License. The "Program", below, refers to any such program or work, and a "work based on the Program" means either the Program or any derivative work under copyright law: that is to say, a work containing the Program or a

portion of it, either verbatim or with modifications and/or translated into another language. (Hereinafter, translation is included without limitation in the term "modification".) Each licensee is addressed as "you". Activities other than copying, distribution and modification are not covered by this License; they are outside its scope. The act of running the Program is not restricted, and the output from the Program is covered only if its contents constitute a work based on the Program (independent of having been made by running the Program). Whether that is true depends on what the Program does.

1. You may copy and distribute verbatim copies of the Program's source code as you receive it, in any medium, provided that you conspicuously and appropriately publish on each copy an appropriate copyright notice and disclaimer of warranty; keep intact all the notices that refer to this License and to the absence of any warranty; and give any other recipients of the Program a copy of this License along with the Program. You may charge a fee for the physical act of transferring a copy, and you may at your option offer warranty protection in exchange for a fee.
2. You may modify your copy or copies of the Program or any portion of it, thus forming a work based on the Program, and copy and distribute such modifications or work under the terms of Section 1 above, provided that you also meet all of these conditions:
 - * a) You must cause the modified files to carry prominent notices stating that you changed the files and the date of any change.
 - * b) You must cause any work that you distribute or publish, that in whole or in part contains or is derived from the Program or any part thereof, to be licensed as a whole at no charge to all third parties under the terms of this License.
 - * c) If the modified program normally reads commands interactively when run, you must cause it, when started running for such interactive use in the most ordinary way, to print or display an announcement including an appropriate copyright notice and a notice that there is no warranty (or else, saying that you provide a warranty) and that users may redistribute the program under these conditions, and telling the user how to view a copy of this License. (Exception: if the Program itself is interactive but does not normally print such an announcement, your work based on the Program is not required to print an announcement.)These requirements apply to the modified work as a whole. If identifiable sections of that work are not derived from the Program, and can be reasonably considered independent and separate works in themselves, then this License, and its terms, do not apply to those sections when you distribute them as separate works. But when you distribute the same sections as part of a whole which is a work based on the Program, the distribution of the whole must be on the terms of this License, whose permissions for other licensees extend to the entire whole, and thus to each and every part regardless of who wrote it.

Thus, it is not the intent of this section to claim rights or contest your rights to work written entirely by you; rather, the intent is to exercise the right to control the distribution of derivative or collective works based on the Program. In addition, mere aggregation of another work not based on the Program with the Program (or with a work based on the Program) on a volume of a storage or distribution medium does not bring the other work under the scope of this License. 3. You may copy and distribute the Program (or a work based on it, under Section 2) in object code or executable form under the terms of Sections 1 and 2 above provided that you also do one of the following: * a) Accompany it with the complete corresponding machine-readable source code, which must be distributed under the terms of Sections 1 and 2 above on a medium customarily used for software interchange; or, * b) Accompany it with a written offer, valid for at least three years, to give any third party, for a charge no more than your cost of physically performing source distribution, a complete machine-readable copy of the corresponding source code, to be distributed under the terms of Sections 1 and 2 above on a medium customarily used for software interchange; or, * c) Accompany it with the information you received as to the offer to distribute corresponding source code. (This alternative is allowed only for noncommercial distribution and only if you received the program in object code or executable form with such an offer, in accord with Subsection b above.) The source code for a work means the preferred form of the work for making modifications to it. For an executable work, complete source code means all the source code for all modules it contains, plus any associated interface definition files, plus the scripts used to control compilation and installation of the executable. However, as a special exception, the source code distributed need not include anything that is normally distributed (in either source or binary form) with the major components (compiler, kernel, and so on) of the operating system on which the executable runs, unless that component itself accompanies the executable. If distribution of executable or object code is made by offering access to copy from a designated place, then offering equivalent access to copy the source code from the same place counts as distribution of the source code, even though third parties are not compelled to copy the source along with the object code. 4. You may not copy, modify, sublicense, or distribute the Program except as expressly provided under this License. Any attempt otherwise to copy, modify, sublicense or distribute the Program is void, and will automatically terminate your rights under this License. However, parties who have received copies, or rights, from you under this License will not have their licenses terminated so long as such parties remain in full compliance. 5. You are not required to accept this License, since you

have not signed it. However, nothing else grants you permission to modify or distribute the Program or its derivative works. These actions are prohibited by law if you do not accept this License. Therefore, by modifying or distributing the Program (or any work based on the Program), you indicate your acceptance of this License to do so, and all its terms and conditions for copying, distributing or modifying the Program or works based on it. 6. Each time you redistribute the Program (or any work based on the Program), the recipient automatically receives a license from the original licensor to copy, distribute or modify the Program subject to these terms and conditions. You may not impose any further restrictions on the recipients' exercise of the rights granted herein. You are not responsible for enforcing compliance by third parties to this License. 7. If, as a consequence of a court judgment or allegation of patent infringement or for any other reason (not limited to patent issues), conditions are imposed on you (whether by court order, agreement or otherwise) that contradict the conditions of this License, they do not excuse you from the conditions of this License. If you cannot distribute so as to satisfy simultaneously your obligations under this License and any other pertinent obligations, then as a consequence you may not distribute the Program at all. For example, if a patent license would not permit royalty-free redistribution of the Program by all those who receive copies directly or indirectly through you, then the only way you could satisfy both it and this License would be to refrain entirely from distribution of the Program. If any portion of this section is held invalid or unenforceable under any particular circumstance, the balance of the section is intended to apply and the section as a whole is intended to apply in other circumstances. It is not the purpose of this section to induce you to infringe any patents or other property right claims or to contest validity of any such claims; this section has the sole purpose of protecting the integrity of the free software distribution system, which is implemented by public license practices. Many people have made generous contributions to the wide range of software distributed through that system in reliance on consistent application of that system; it is up to the author/donor to decide if he or she is willing to distribute software through any other system and a licensee cannot impose that choice. This section is intended to make thoroughly clear what is believed to be a consequence of the rest of this License. 8. If the distribution and/or use of the Program is restricted in certain countries either by patents or by copyrighted interfaces, the original copyright holder who places the Program under this License may add an explicit geographical distribution limitation excluding those countries, so that distribution is permitted only in or among countries not thus excluded. In such case, this License

incorporates the limitation as if written in the body of this License. 9. The Free Software Foundation may publish revised and/or new versions of the General Public License from time to time. Such new versions will be similar in spirit to the present version, but may differ in detail to address new problems or concerns. Each version is given a distinguishing version number. If the Program specifies a version number of this License which applies to it and \"any later version\", you have the option of following the terms and conditions either of that version or of any later version published by the Free Software Foundation. If the Program does not specify a version number of this License, you may choose any version ever published by the Free Software Foundation. 10. If you wish to incorporate parts of the Program into other free programs whose distribution conditions are different, write to the author to ask for permission. For software which is copyrighted by the Free Software Foundation, write to the Free Software Foundation; we sometimes make exceptions for this. Our decision will be guided by the two goals of preserving the free status of all derivatives of our free software and of promoting the sharing and reuse of software generally. NO WARRANTY

11. BECAUSE THE PROGRAM IS LICENSED FREE OF CHARGE, THERE IS NO WARRANTY FOR THE PROGRAM, TO THE EXTENT PERMITTED BY APPLICABLE LAW. EXCEPT WHEN OTHERWISE STATED IN WRITING THE COPYRIGHT HOLDERS AND/OR OTHER PARTIES PROVIDE THE PROGRAM \"AS IS\" WITHOUT WARRANTY OF ANY KIND, EITHER EXPRESSED OR IMPLIED, INCLUDING, BUT NOT LIMITED TO, THE IMPLIED WARRANTIES OF MERCHANTABILITY AND FITNESS FOR A PARTICULAR PURPOSE. THE ENTIRE RISK AS TO THE QUALITY AND PERFORMANCE OF THE PROGRAM IS WITH YOU. SHOULD THE PROGRAM PROVE DEFECTIVE, YOU ASSUME THE COST OF ALL NECESSARY SERVICING, REPAIR OR CORRECTION. 12. IN NO EVENT UNLESS REQUIRED BY APPLICABLE LAW OR AGREED TO IN WRITING WILL ANY COPYRIGHT HOLDER, OR ANY OTHER PARTY WHO MAY MODIFY AND/OR REDISTRIBUTE THE PROGRAM AS PERMITTED ABOVE, BE LIABLE TO YOU FOR DAMAGES, INCLUDING ANY GENERAL, SPECIAL, INCIDENTAL OR CONSEQUENTIAL DAMAGES ARISING OUT OF THE USE OR INABILITY TO USE THE PROGRAM (INCLUDING BUT NOT LIMITED TO LOSS OF DATA OR DATA BEING RENDERED INACCURATE OR LOSSES SUSTAINED BY YOU OR THIRD PARTIES OR A FAILURE OF THE PROGRAM TO OPERATE WITH ANY OTHER PROGRAMS), EVEN IF SUCH HOLDER OR OTHER PARTY HAS BEEN ADVISED OF THE POSSIBILITY OF SUCH DAMAGES. END OF TERMS AND CONDITIONS

How to Apply These

Terms to Your New Programs If you develop a new program, and you want it to be of the greatest possible use to the public, the best way to achieve this is to make it free software which everyone can redistribute and change under these terms. To do so, attach the following notices to the program. It is safest to attach them to the start of each source file to most effectively convey the exclusion of warranty; and each file should have at least the "copyright" line and a pointer to where the full notice is found. one line to give the program's name and an idea of what it does. Copyright (C) yyyy name of author This program is free software; you can redistribute it and/or modify it under the terms of the GNU General Public License as published by the Free Software Foundation; either version 2 of the License, or (at your option) any later version. This program is distributed in the hope that it will be useful, but WITHOUT ANY WARRANTY; without even the implied warranty of MERCHANTABILITY or FITNESS FOR A PARTICULAR PURPOSE. See the GNU General Public License for more details. You should have received a copy of the GNU General Public License along with this program; if not, write to the Free Software Foundation, Inc., 59 Temple Place - Suite 330, Boston, MA 02111-1307, USA. Also add information on how to contact you by electronic and paper mail. If the program is interactive, make it output a short notice like this when it starts in an interactive mode: Gnomovision version 69, Copyright (C) year name of author Gnomovision comes with ABSOLUTELY NO WARRANTY; for details type `show w`. This is free software, and you are welcome to redistribute it under certain conditions; type `show c` for details. The hypothetical commands `show w` and `show c` should show the appropriate parts of the General Public License. Of course, the commands you use may be called something other than `show w` and `show c`; they could even be mouse-clicks or menu items--whatever suits your program. You should also get your employer (if you work as a programmer) or your school, if any, to sign a "copyright disclaimer" for the program, if necessary. Here is a sample; alter the names: Yoyodyne, Inc., hereby disclaims all copyright interest in the program `Gnomovision` (which makes passes at compilers) written by James Hacker. signature of Ty Coon, 1 April 1989 Ty Coon, President of Vice This General Public License does not permit incorporating your program into proprietary programs. If your program is a subroutine library, you may consider it more useful to permit linking proprietary applications with the library. If this is what you want to do, use the GNU Lesser General Public License instead of this License.

END OF TERMS AND CONDITIONS

Zlib

The following component is licensed under zlib license:

Zlib 1.2.1

Zlib License

```
/* zlib.h -- interface of the 'zlib' general purpose compression library
version 1.2.4, March 14th, 2010
```

Copyright (C) 1995-2010 Jean-loup Gailly and Mark

This software is provided 'as-is', without any express or implied warranty. In no event will the authors be held liable for any damages arising from the use of this software. Permission is granted to anyone to use this software for any purpose, including commercial applications, and to alter it and redistribute it freely, subject to the following restrictions:

1. The origin of this software must not be misrepresented; you must not claim that you wrote the original software. If you use this software in a product, an acknowledgment in the product documentation would be appreciated but is not required.
2. Altered source versions must be plainly marked as such, and must not be misrepresented as being the original software.
3. This notice may not be removed or altered from any source distribution.

Jean-loup Gailly
Mark Adler

END OF TERMS AND CONDITIONS

Libpng

The following component is licensed under libpng license:

Libpng 1.2.37 - June 4, 2009

Libpng License

This copy of the libpng notices is provided for your convenience. In case of any discrepancy between this copy and the notices in the file png.h that is included in the libpng distribution, the latter shall prevail.

COPYRIGHT NOTICE, DISCLAIMER, and LICENSE:

If you modify libpng you may insert additional notices immediately following this sentence.

libpng versions 1.2.6, August 15, 2004, through 1.2.34, December 18, 2008, are Copyright (c) 2004, 2006-2008 Glenn Randers-Pehrson, and are distributed according to the same disclaimer and license as libpng-1.2.5 with the following individual added to the list of Contributing Authors

Cosmin Truta

libpng versions 1.0.7, July 1, 2000, through 1.2.5 - October 3, 2002, are Copyright (c) 2000-2002 Glenn Randers-Pehrson, and are distributed according to the same disclaimer and license as libpng-1.0.6 with the following individuals added to the list of Contributing Authors

Simon-Pierre Cadieux
Eric S. Raymond
Gilles Vollant

and with the following additions to the disclaimer:

There is no warranty against interference with your enjoyment of the library or against infringement. There is no warranty that our efforts or the library will fulfill any of your particular purposes or needs. This library is provided with all faults, and the entire risk of satisfactory quality, performance, accuracy, and effort is with the user.

libpng versions 0.97, January 1998, through 1.0.6, March 20, 2000, are Copyright (c) 1998, 1999 Glenn Randers-Pehrson, and are distributed according to the same disclaimer and license as libpng-0.96, with the following individuals added to the list of Contributing Authors:

Tom Lane
Glenn Randers-Pehrson
Willem van Schaik

libpng versions 0.89, June 1996, through 0.96, May 1997, are Copyright (c) 1996, 1997 Andreas Dilger
Distributed according to the same disclaimer and license as libpng-0.88, with the following individuals added to the list of Contributing Authors:

John Bowler
Kevin Bracey
Sam Bushell
Magnus Holmgren

Greg Roelofs
Tom Tanner

libpng versions 0.5, May 1995, through 0.88, January 1996, are Copyright (c) 1995, 1996 Guy Eric Schalnat, Group 42, Inc.

For the purposes of this copyright and license, "Contributing Authors" is defined as the following set of individuals:

Andreas Dilger
Dave Martindale
Guy Eric Schalnat
Paul Schmidt
Tim Wegner

The PNG Reference Library is supplied "AS IS". The Contributing Authors and Group 42, Inc. disclaim all warranties, expressed or implied, including, without limitation, the warranties of merchantability and of fitness for any purpose. The Contributing Authors and Group 42, Inc. assume no liability for direct, indirect, incidental, special, exemplary, or consequential damages, which may result from the use of the PNG Reference Library, even if advised of the possibility of such damage.

Permission is hereby granted to use, copy, modify, and distribute this source code, or portions hereof, for any purpose, without fee, subject to the following restrictions:

1. The origin of this source code must not be misrepresented.
2. Altered versions must be plainly marked as such and must not be misrepresented as being the original source.
3. This Copyright notice may not be removed or altered from any source or altered source distribution.

The Contributing Authors and Group 42, Inc. specifically permit, without fee, and encourage the use of this source code as a component to supporting the PNG file format in commercial products. If you use this source code in a product, acknowledgment is not required but would be appreciated.

A "png_get_copyright" function is available, for convenient use in "about" boxes and the like:

```
printf("%s",png_get_copyright(NULL));
```

Also, the PNG logo (in PNG format, of course) is supplied in the files "pngbar.png" and "pngbar.jpg (88x31)" and "pngnow.png" (98x31).

Libpng is OSI Certified Open Source Software. OSI Certified Open Source is a certification mark of the Open Source Initiative.

Glenn Randers-Pehrson
glennrp at users.sourceforge.net
December 18, 2008

END OF TERMS AND CONDITIONS

Kern_random

The following component is licensed under kern_random license:

Kern_random Copyright Theodore Ts'o, 1994, 1995. All rights reserved.

Kern-random License

.\" This code is derived from software contributed to Berkeley by Chris Torek. Redistribution and use in source and binary forms, with or without modification, are permitted provided that the following conditions are met:

.\" 1. Redistributions of source code must retain the above copyright notice, this list of conditions and the following disclaimer.

.\" 2. Redistributions in binary form must reproduce the above copyright notice, this list of conditions and the following disclaimer in the documentation and/or other materials provided with the distribution.

.\" 3. All advertising materials mentioning features or use of this software must display the following acknowledgement:

.\"This product includes software developed by the University of California, Berkeley and its contributors.

.\" 4. Neither the name of the University nor the names of its contributors may be used to endorse or promote products derived from this software without specific prior written permission.

.\"

.\" THIS SOFTWARE IS PROVIDED BY THE REGENTS AND CONTRIBUTORS ``AS IS'' AND ANY EXPRESS OR IMPLIED WARRANTIES, INCLUDING, BUT NOT LIMITED TO, THE IMPLIED WARRANTIES OF MERCHANTABILITY AND FITNESS FOR A PARTICULAR PURPOSE ARE DISCLAIMED. IN NO EVENT SHALL THE REGENTS OR CONTRIBUTORS BE LIABLE FOR ANY DIRECT, INDIRECT, INCIDENTAL, SPECIAL, EXEMPLARY, OR CONSEQUENTIAL DAMAGES (INCLUDING, BUT NOT LIMITED TO, PROCUREMENT OF SUBSTITUTE GOODS OR SERVICES; LOSS OF USE, DATA, OR PROFITS; OR BUSINESS INTERRUPTION)

HOWEVER CAUSED AND ON ANY THEORY OF LIABILITY, WHETHER IN CONTRACT, STRICT LIABILITY, OR TORT (INCLUDING NEGLIGENCE OR OTHERWISE) ARISING IN ANY WAY OUT OF THE USE OF THIS SOFTWARE, EVEN IF ADVISED OF THE POSSIBILITY OF SUCH DAMAGE.

."

END OF TERMS AND CONDITIONS

Wchar functions

The following component is licensed under wchar functions license:

Wchar functions

Wchar functions License

." Copyright (c) 1990, 1991, 1993

."The Regents of the University of California. All rights reserved.

."

Copyright (c) <YEAR>, <OWNER>

All rights reserved.

Redistribution and use in source and binary forms, with or without modification, are permitted provided that the following conditions are met:

Redistributions of source code must retain the above copyright notice, this list of conditions and the following disclaimer.

Redistributions in binary form must reproduce the above copyright notice, this list of conditions and the following disclaimer in the documentation and/or other materials provided with the distribution.

Neither the name of the <ORGANIZATION> nor the names of its contributors may be used to endorse or promote products derived from this software without specific prior written permission.

THIS SOFTWARE IS PROVIDED BY THE COPYRIGHT HOLDERS AND CONTRIBUTORS "AS IS" AND ANY EXPRESS OR IMPLIED WARRANTIES, INCLUDING, BUT NOT LIMITED TO, THE IMPLIED WARRANTIES OF MERCHANTABILITY AND FITNESS FOR A PARTICULAR PURPOSE ARE DISCLAIMED. IN NO EVENT SHALL THE COPYRIGHT HOLDER OR CONTRIBUTORS BE LIABLE FOR ANY DIRECT, INDIRECT, INCIDENTAL, SPECIAL, EXEMPLARY, OR CONSEQUENTIAL DAMAGES (INCLUDING, BUT NOT LIMITED TO, PROCUREMENT OF SUBSTITUTE GOODS OR SERVICES; LOSS OF

USE, DATA, OR PROFITS; OR BUSINESS INTERRUPTION) HOWEVER CAUSED AND ON ANY THEORY OF LIABILITY, WHETHER IN CONTRACT, STRICT LIABILITY, OR TORT (INCLUDING NEGLIGENCE OR OTHERWISE) ARISING IN ANY WAY OUT OF THE USE OF THIS SOFTWARE, EVEN IF ADVISED OF THE POSSIBILITY OF SUCH DAMAGE

END OF TERMS AND CONDITIONS

Libjpeg

The following component is licensed under libjpeg license:

Libjpeg

Libjpeg License

This software is copyright (C) 1991-1998, Thomas G. Lane.
All Rights Reserved except as specified below.

Permission is hereby granted to use, copy, modify, and distribute this software (or portions thereof) for any purpose, without fee, subject to these conditions:

- (1) If any part of the source code for this software is distributed, then this README file must be included, with this copyright and no-warranty notice unaltered; and any additions, deletions, or changes to the original files must be clearly indicated in accompanying documentation.
- (2) If only executable code is distributed, then the accompanying documentation must state that "this software is based in part on the work of the Independent JPEG Group".
- (3) Permission for use of this software is granted only if the user accepts full responsibility for any undesirable consequences; the authors accept NO LIABILITY for damages of any kind.

These conditions apply to any software derived from or based on the IJG code, not just to the unmodified library. If you use our work, you ought to acknowledge us.

Permission is NOT granted for the use of any IJG author's name or company name in advertising or publicity relating to this software or products derived from it. This software may be referred to only as "the Independent JPEG Group's software".

We specifically permit and encourage the use of this software as the basis of commercial products, provided that all warranty or liability claims are assumed by the product vendor.

END OF TERMS AND CONDITIONS

T-Rex

The following component is licensed under the T-Rex license:

T-Rex

T-Rex License

Copyright (C) 2003-2004 Alberto Demichelis

This software is provided 'as-is', without any express or implied warranty. In no event will the authors be held liable for any damages arising from the use of this software.

Permission is granted to anyone to use this software for any purpose, including commercial applications, and to alter it and redistribute it freely, subject to the following restrictions:

1. The origin of this software must not be misrepresented; you must not claim that you wrote the original software. If you use this software in a product, an acknowledgment in the product documentation would be appreciated but is not required.
2. Altered source versions must be plainly marked as such, and must not be misrepresented as being the original software.
3. This notice may not be removed or altered from any source distribution.

END OF TERMS AND CONDITIONS

Terms you should know

3-way Call

The 3-way Call feature joins two calls on your phone into one 3-way call. You and the other two callers can speak together.

Alphanumeric Dialing

Alphanumeric dialing refers to the spelling of names or words by entering alphabetic characters collocated with the numbers on the numeric dialpad of your Avaya 1120E IP Deskphone.

Call Decline

This is a feature that you can use to decline a call, which includes an option to send a reason for declining the call.

Call Forward

This is a feature that you can use to transfer incoming calls to a predefined phone number or SIP address.

Call Server

This is the equipment operated by your service provider that manages the calls to and from your phone.

Call Subject

This is a feature that you can use to send a message to the person you are contacting as they receive the call from you. A Call Subject appears on the display screen if the receiving telephone has a display screen and is capable of displaying Call Subjects.

Category 5 (Cat5)

This is a cable and its associated connecting hardware capable of transmitting at speeds up to 100 MHz used by 10BaseT, 100BaseT4, and 100BaseTX.

Category 5e (Cat5e)

Most Cat5 cable manufactured after 1996 also supports 1000BaseT (GigE) installations, and is designated Cat 5e. Normally, Cat5e cable has four pairs of copper wire.

Category 6 (Cat6)

This is a cable and its associated connecting hardware capable of transmitting at speeds up to 200 MHz. Designed specifically to support 1000BaseT (GigE), this cable is also compatible with 10BaseT, 100BaseT4, and 100BaseTX installations. Normally, this cable normally has four pairs of copper wire.

Copy Key

This is a fixed key used to copy entries to your Address Book, Speed Dial Key, Send IM Key, and Call Forward key.

Date/Time display

The Avaya 1120E IP Deskphone shows the current date and time when the telephone is in an idle state.

Directory Number (DN)

This is a telephone number you enter to initiate a call, for example, (555) 555-5555.

Domain

This is the Internet Protocol address to which the IP Deskphone connects when you logon.

Do Not Disturb

This is a feature you activate to block all incoming calls.

Enter key

The center key of the Navigation Cluster key is used to select menu items and to confirm changes. The Enter key duplicates the function of the context-sensitive soft keys Select, and Set.

Expansion Module

The Expansion Module is a hardware accessory that connects to the IP Deskphone and provides additional line appearances and feature keys. A maximum of three modules are supported. The Avaya 1120E IP Deskphone can have up to 54 additional line/feature keys with three Expansion Modules.

Feature Status Indicator

This refer to an LCD or an LED signal that indicates a data message, contact, or feature status by a flash, wink, steady on, or off.

Fixed keys

These are the hard-labeled keys of the IP Deskphone that have a specific function.

Goodbye key

This is the fixed key used to end an active call or exit an active menu.

Handsfree key

This is the fixed key used to activate Handsfree.

Hold key

This is the fixed key used to place an active call on hold.

IM (Instant Message)

You can use IMs to send a text message to a specific user. The user must be logged on to receive the IM.

Indicator

This is an LCD or an LED signal that indicates the status of a feature by the flash, blink, steady on, or off.

Message/Inbox

This is a fixed key on your Avaya 1120E IP Deskphone that connects to your Call Inbox.

Multiple Appearance Directory Number (MADN)

When multiple phones are configured with a MADN Single Call Appearance (SCA), they appear as a single Directory Number (DN).

Mute

This is a fixed key used to listen to a call without transmitting.

Navigation keys

These are keys used to scroll through menus and lists that appear on the LCD display screen.

Off-Hook

The term *off-hook* is applied when (a) the end user lifts up the handset, (b) the end user presses a line key, (c) the call is automatically answered at the telephone, or (d) a line is automatically selected for an outgoing call.

Parked Call

This is an active call you park on the server or to another user that can be retrieved from another phone.

Presence

This is a feature that you can use to set a presence state to be displayed to other users.

Quit key

This is a fixed key you use to exit an active menu.

Ringback/ring tone

This is a sound indicating that a call you make is ringing at its destination.

Shift/Outbox

This is a fixed key you can use to connect to your Call Outbox.

Session Initiation Protocol (SIP)

Session Initiation Protocol is an telephony signaling protocol for initiating interactive communication sessions between users.

SIP Address

This is an IP address that is assigned to a user, such as bob@ABC123.com that is used to send IMs and to initiate calls.

context-sensitive soft keys

This is a set of four programmed keys directly beneath the display area. You use these keys to access and select menu items.

Speed Dial

A user-defined feature key that you press to dial a preprogrammed SIP address or phone number.

User interface

This consists of screen displays that interact with the end user as a result of an action or event.

User Profile

Your User Profile that contains your specific settings and data saved and available when you logon to the IP Deskphone.

Visual Alerter/Message Waiting indicator

This is an LCD or an LED signal that flashes to indicate that a message is waiting or when the ringer is on.

Index

Symbols

Ends Dialing 63

Numerics

3-way calling 202

A

Action key 32, 193

Active Call features 192

Address Book 81, 145

Advance system features 284

Alphanumeric dialing 65

Answering a call 134

Audio key 33

B

Backlight Screensaver 88

Bluetooth wireless technology 118

C

Call Forward 247

Call Forward feature key programming 233

Call Inbox 163

Call Origination Busy 340, 357

Call Outbox 174

Call Parking with MLPP 360

Call Subjects 126

Call Transfer - Consultative with MLPP 360

Call Transfer - Direct with MLPP 360

Call transfer with precedence 350

Call Waiting Disabled with MLPP 361

Caller identification 133

Conference call (Ad-hoc conference) with MLPP 360

Conference calls 204

Configuring the phone 86

Connecting the components 50

Consultative transfer with MLPP 351

Context-sensitive soft keys 18, 24

Copy key 20, 153, 245

D

Date format 98

Declining a call 137

Directory key 22

Display screen contrast 86

Display screen icons 334

Do Not Disturb feature key programming 234

Domain 69

E

Emergency 911 339

Enter key 19

Entering Text 60

Erasing user data 290

Expand key 19

Expansion Module 17, 52, 60, 86, 393

Expansion Module for Avaya 1100 Series IP Deskphones 224
External preemption 355

F

Feature interactions with MLPP 360
Feature key auto-programming 240
Feature key options 224
Feature key programming 225
Feature keys 18
Feature Status Indicator 181
Flash 339
Flash-Override 339
Friends feature 216
Friends list 217

G

Global Search 159
Goodbye key 19

H

Handsfree (Speaker) key 19
Handsfree calling 124
Headset key 20
Hold key 20, 194

I

Ignoring a call 141
Immediate 339
Inbox key 22
Incoming call privacy 255
Incoming calls with precedence 349

Instant Message composing 184
Instant Message Inbox/Outbox 185

L

Language display 97
Language selection 71
Local Search 157
Logging in 68
Logging out 82

M

Making a call 121
Making a call by using a programmed speed dial key 348
Making a call with MLPP 341
Making an MLPP call by going off-hook 341
Making an MLPP call from a received Instant Message 346
Making an MLPP call using Inbox/Outbox, Address Book, and Friends List 345
Missed Calls 167
MLPP 339
MLPP, Feature interactions with 360
Msgs (Messages) key 25
Multi-Level Precedence and Preemption 339
Multiple Appearance Directory Number (MADN) 257
Multiuser 361
Mute key 18

N

Navigation key 19, 41
 Network Menu 295

O

Off-hook dialing 122
 On hold 194
 On-hook dialing 124
 Outbox key 22
 Outgoing call privacy 256

P

Park Call 213
 Park Call retrieval 214
 Prec soft key 342, 345, 348
 Precedence alerting tone 349
 precedence call display 349
 precedence call display, redirected call 350
 Precedence Call Waiting tone 349
 Precedence Level 343
 Preemption 352
 Prefs (Preferences) key 27, 30, 35, 37, 40, 197, 198, 200
 Presence feature key programming 236
 Priority 339
 Privacy settings 255
 Proxy (Domain) 286

Q

Quit key 21

R

Re-authorization 340, 360
 Redirecting a call 134
 Release key 19
 Resetting the phone 289
 Ring patterns 91
 Routine 339

S

Search function 157
 Security features 43
 Send IM feature key programming 235
 Servcs (Services) key 32, 36, 37
 Services key 21
 SIP (Session Initiated Protocol) 15
 Speakerphone exclusive to 911 Emergency 340
 Speakerphone with MLPP 361
 Speed Dial feature key 247
 Speed Dial feature key programming 231

T

Terms 363, 391
 Transferring a call 209
 Transfr (Transfer) key 210

U

Updates 286
 USB keyboard 66
 USB Mouse 42
 User profile 80

V

Visual Alerter 20, 336

Visual indicators 334

Voice Mail 25, 211

Volume adjustment 92

Volume control 18

Free Manuals Download Website

<http://myh66.com>

<http://usermanuals.us>

<http://www.somanuals.com>

<http://www.4manuals.cc>

<http://www.manual-lib.com>

<http://www.404manual.com>

<http://www.luxmanual.com>

<http://aubethermostatmanual.com>

Golf course search by state

<http://golfingnear.com>

Email search by domain

<http://emailbydomain.com>

Auto manuals search

<http://auto.somanuals.com>

TV manuals search

<http://tv.somanuals.com>