



**Avaya 1600 Series IP Deskphones**  
**Administrator Guide**  
**Release 1.3.x**

16-601443  
Issue 4  
April 2010

© 2010 Avaya Inc.  
All Rights Reserved.

#### Notice

While reasonable efforts were made to ensure that the information in this document was complete and accurate at the time of printing, Avaya Inc. can assume no liability for any errors. Changes and corrections to the information in this document may be incorporated in future releases.

**For full legal page information, please see the complete document, Avaya Legal Page for Hardware Documentation, Document number 03-600759.**

**To locate this document on our Web site, simply go to <http://www.avaya.com/support> and search for the document number in the search box.**

#### Documentation disclaimer

Avaya Inc. is not responsible for any modifications, additions, or deletions to the original published version of this documentation unless such modifications, additions, or deletions were performed by Avaya. Customer and/or End User agree to indemnify and hold harmless Avaya, Avaya's agents, servants and employees against all claims, lawsuits, demands and judgments arising out of, or in connection with, subsequent modifications, additions or deletions to this documentation to the extent made by the Customer or End User.

#### Link disclaimer

Avaya Inc. is not responsible for the contents or reliability of any linked Web sites referenced elsewhere within this documentation, and Avaya does not necessarily endorse the products, services, or information described or offered within them. We cannot guarantee that these links will work all of the time and we have no control over the availability of the linked pages.

#### Warranty

Avaya Inc. provides a limited warranty on this product. Refer to your sales agreement to establish the terms of the limited warranty. In addition, Avaya's standard warranty language, as well as information regarding support for this product, while under warranty, is available through the following Web site:

<http://www.avaya.com/support>

#### Copyright

Except where expressly stated otherwise, the Product is protected by copyright and other laws respecting proprietary rights. Unauthorized reproduction, transfer, and or use can be a criminal, as well as a civil, offense under the applicable law.

#### Avaya support

Avaya provides a telephone number for you to use to report problems or to ask questions about your product. The support telephone number is 1-800-242-2121 in the United States. For additional support telephone numbers, see the Avaya Web site:

<http://www.avaya.com/support>

#### Software License

USE OR INSTALLATION OF THE PRODUCT INDICATES THE END USER'S ACCEPTANCE OF THE TERMS SET FORTH HEREIN AND THE GENERAL LICENSE TERMS AVAILABLE ON THE AVAYA WEBSITE AT <http://support.avaya.com/LicenseInfo/> ("GENERAL LICENSE TERMS"). IF YOU DO NOT WISH TO BE BOUND BY THESE TERMS, YOU MUST RETURN THE PRODUCT(S) TO THE POINT OF PURCHASE WITHIN TEN (10) DAYS OF DELIVERY FOR A REFUND OR CREDIT.

Avaya grants End User a license within the scope of the license types described below. The applicable number of licenses and units of capacity for which the license is granted will be one (1), unless a different number of licenses or units of capacity is specified in the Documentation or other materials available to End User. "Designated Processor" means a single stand-alone computing device. "Server" means a Designated Processor that hosts a software application to be accessed by multiple users. "Software" means the computer programs in object code, originally licensed by Avaya and ultimately utilized by End User, whether as stand-alone Products or pre-installed on Hardware. "Hardware" means the standard hardware Products, originally sold by Avaya and ultimately utilized by End User.

#### License Type(s):

Designated System(s) License (DS). End User may install and use each copy of the Software on only one Designated Processor, unless a different number of Designated Processors is indicated in the Documentation or other materials available to End User. Avaya may require the Designated Processor(s) to be identified by type, serial number, feature key, location or other specific designation, or to be provided by End User to Avaya through electronic means established by Avaya specifically for this purpose.

#### Third-party Components

Certain software programs or portions thereof included in the Product may contain software distributed under third party agreements ("Third Party Components"), which may contain terms that expand or limit rights to use certain portions of the Product ("Third Party Terms"). Information identifying Third Party Components and the Third Party Terms that apply to them is available on Avaya's Web site at:

<http://support.avaya.com/ThirdPartyLicense/>

#### Interference

Using a cell, mobile, or GSM telephone, or a two-way radio in close proximity to an Avaya IP Telephone might cause interference.

#### Security

See <http://support.avaya.com/security> to locate and/or report known vulnerabilities in Avaya products. See <http://support.avaya.com> to locate the latest software patches and upgrades. For information about secure configuration of equipment and mitigation of toll fraud threats, see the Avaya Toll Fraud and Security Handbook at <http://support.avaya.com>.

# Contents

<b>Chapter 1: Introduction</b> . . . . .	<b>7</b>
About This Guide . . . . .	7
Document Organization . . . . .	8
Other Documentation . . . . .	9
<b>Chapter 2: Administration Overview and Requirements</b> . . . . .	<b>11</b>
1600 Series IP Telephones . . . . .	11
Parameter Data Precedence . . . . .	15
The Administrative Process. . . . .	15
Administrative Checklist . . . . .	16
Telephone Initialization Process . . . . .	17
Step 1: Telephone to Network . . . . .	17
Step 2: DHCP Server to Telephone. . . . .	18
Step 3: Telephone and File Server . . . . .	18
Step 4: Telephone and the Call Server . . . . .	18
Error Conditions . . . . .	19
<b>Chapter 3: Network Requirements</b> . . . . .	<b>21</b>
Network Assessment . . . . .	21
Hardware Requirements. . . . .	21
Server Requirements . . . . .	22
DHCP Server . . . . .	22
HTTP/HTTPS Server . . . . .	22
Required Network Information . . . . .	23
Other Network Considerations . . . . .	24
SNMP . . . . .	24
Reliability and Performance. . . . .	25
QoS . . . . .	25
IEEE 802.1P and 802.1Q. . . . .	25
Network Audio Quality Display on 1600 Series IP Telephones. . . . .	26
IP Address Lists and Station Number Portability . . . . .	26
TCP/UDP Port Utilization . . . . .	27
Security. . . . .	30
Registration and Authentication . . . . .	30

## Contents

<b>Chapter 4: Avaya Aura Communication Manager Administration . . . .</b>	<b>31</b>
Call Server Requirements . . . . .	31
Switch Compatibility and Aliasing IP Telephones. . . . .	31
Media Server (Switch) Administration . . . . .	33
IP Interface and Addresses . . . . .	33
UDP Port Selection . . . . .	34
RSVP and RTCP . . . . .	34
QoS . . . . .	34
IEEE 802.1P and 802.1Q . . . . .	34
NAT . . . . .	35
DIFFSERV . . . . .	35
Voice Mail Integration . . . . .	36
1600 Series IP Telephones with Avaya Aura Communication Manager 5.2 Native Support . . . . .	36
1600 Series IP Telephones Aliased as 4600 Series IP Telephones. . . . .	36
Telephone Administration. . . . .	37
System-Wide Administration . . . . .	37
Feature-Related System Parameters . . . . .	37
Administering Stations . . . . .	38
Aliasing 1600 Series IP Telephones . . . . .	39
Administering Features . . . . .	39
Feature Buttons and Call Appearances . . . . .	40
For the 1603/1603SW/1603-I/1603SW-I and 1608/1608-I IP Telephones . . . . .	40
For the 1616/1616-I IP Telephones . . . . .	40
Conference Details Screen for Ad-Hoc Conferences . . . . .	41
Shuffling . . . . .	41
Printing Button Labels . . . . .	42
<b>Chapter 5: Server Administration . . . . .</b>	<b>43</b>
Software Checklist. . . . .	43
DHCP and File Servers . . . . .	43
DHCP Server Administration . . . . .	44
DHCP Generic Setup . . . . .	44
Windows NT 4.0 DHCP Server . . . . .	48
Verifying the Installation of the DHCP Server . . . . .	48
Creating a DHCP Scope for the IP Telephones . . . . .	49
Editing Custom Options. . . . .	50
Adding the DHCP Option . . . . .	50
Activating the Leases . . . . .	51

Verifying Your Configuration . . . . .	51
Windows 2000 DHCP Server . . . . .	52
Verifying the Installation of the DHCP Server . . . . .	52
Adding DHCP Options . . . . .	54
Activating the New Scope . . . . .	55
HTTP Generic Setup . . . . .	55
HTTP Configuration for Backup/Restore . . . . .	56
For IIS Web Servers . . . . .	56
Web Configuration Tool . . . . .	58
<b>Chapter 6: Telephone Software and Application Files . . . . .</b>	<b>61</b>
General Download Process . . . . .	61
Software . . . . .	61
1600 Series IP Telephone Scripts and Application Files . . . . .	62
Choosing the Right Application File and Upgrade Script File . . . . .	62
Upgrade Script File . . . . .	62
Settings File . . . . .	63
Contents of the Settings File . . . . .	64
The GROUP System Value . . . . .	65
<b>Chapter 7: Administering Telephone Options . . . . .</b>	<b>67</b>
Administering Options for the 1600 Series IP Telephones . . . . .	67
VLAN Considerations . . . . .	73
VLAN Tagging . . . . .	73
VLAN Default Value and Priority Tagging . . . . .	74
VLAN Separation. . . . .	75
DNS Addressing . . . . .	76
IEEE 802.1X . . . . .	77
802.1X Pass-Through and Proxy Logoff . . . . .	78
802.1X Supplicant Operation . . . . .	78
Link Layer Discovery Protocol (LLDP) . . . . .	79
Local Administrative Options Using the Telephone Dialpad . . . . .	84
Clear Procedure . . . . .	84
Disable/Enable Debug Mode . . . . .	85
Group Identifier . . . . .	86
Reset System Values . . . . .	87
Restart the Telephone . . . . .	88

## Contents

<b>Interface Control . . . . .</b>	<b>89</b>
<b>The View Administrative Option . . . . .</b>	<b>91</b>
<b>Static Addressing Installation . . . . .</b>	<b>94</b>
<b>Disable/Enable Event Logging . . . . .</b>	<b>97</b>
<b>Logoff. . . . .</b>	<b>98</b>
<b>Self-Test Procedure . . . . .</b>	<b>99</b>
<b>Language Selection . . . . .</b>	<b>100</b>
<b>1600 Series Global Telephones. . . . .</b>	<b>100</b>
<b>1600 Series International Telephones . . . . .</b>	<b>102</b>
<b>Enhanced Local Dialing . . . . .</b>	<b>105</b>
<b>Backup/Restore . . . . .</b>	<b>106</b>
<b>Backup . . . . .</b>	<b>107</b>
<b>Restore . . . . .</b>	<b>108</b>
<b>Chapter 8: Administering Applications and Options . . . . .</b>	<b>111</b>
<b>Customizing 1600 Series IP Telephone Applications and Options. . . . .</b>	<b>111</b>
<b>The Application Status Flag (APPSTAT) . . . . .</b>	<b>114</b>
<b>Appendix A: Glossary of Terms . . . . .</b>	<b>117</b>
<b>Appendix B: Related Documentation . . . . .</b>	<b>119</b>
<b>IETF Documents . . . . .</b>	<b>119</b>
<b>ITU Documents. . . . .</b>	<b>120</b>
<b>ISO/IEC, ANSI/IEEE Documents . . . . .</b>	<b>121</b>
<b>Appendix C: Sample Administration Forms . . . . .</b>	<b>123</b>
<b>Index . . . . .</b>	<b>133</b>

# Chapter 1: Introduction

---

## About This Guide

This guide is for personnel who administer Avaya Aura™ Communication Manager, Avaya Aura Communication Manager Branch (formerly known as Avaya Distributed Office), DHCP, HTTP/HTTPS servers for Avaya 1600 Series IP Deskphones, a Local Area Network (LAN), or a Web server.

The 1600 Series IP Telephones use Internet Protocol (IP) technology with Ethernet line interfaces and support the H.323 protocol only. The 1600 Series IP Telephones provide support for DHCP, HTTP, and HTTPS over IPv4/UDP, which enhance the administration and servicing of the telephones. These telephones use DHCP to obtain dynamic IP Addresses, and HTTPS or HTTP to download new versions of software or customized settings for the telephones.



### **CAUTION:**

Avaya does not support many of the products mentioned in this document. Take care to ensure that there is adequate technical support available for servers used with any 1600 Series IP Telephone system. If the servers are not functioning correctly, the 1600 Series IP Telephones might not operate correctly.

---

## Document Organization

The guide contains the following sections:

<a href="#">Chapter 1: Introduction</a>	Provides an overview of this document.
<a href="#">Chapter 2: Administration Overview and Requirements</a>	Provides an overview of the administrative process and describes general hardware, software, and operational requirements.
<a href="#">Chapter 3: Network Requirements</a>	Describes administrative requirements for your Local Area Network.
<a href="#">Chapter 4: Avaya Aura Communication Manager Administration</a>	Describes how to administer Avaya Aura Communication Manager to operate with 1600 Series IP Telephones.
<a href="#">Chapter 5: Server Administration</a>	Describes DHCP, HTTP, and HTTPS administration for the 1600 Series IP Telephones.
<a href="#">Chapter 6: Telephone Software and Application Files</a>	Describes telephone software, covers application software downloads, and provides information about the configuration file.
<a href="#">Chapter 7: Administering Telephone Options</a>	Describes how to use file parameters and options to administer 1600 Series IP Telephones. Covers backup and restoration of telephone data. Also describes how to use local procedures to customize a single telephone from the dialpad.
<a href="#">Chapter 8: Administering Applications and Options</a>	Provides a table of customizable application-specific parameters, to provide administrative control of telephone functions and options.
<a href="#">Appendix A: Glossary of Terms</a>	Provides a glossary of terms used in this document or which can be applicable to 1600 Series IP Telephones.
<a href="#">Appendix B: Related Documentation</a>	Provides references to external documents that relate to telephony in general, which can provide additional information about specific aspects of the telephones.
<a href="#">Appendix C: Sample Administration Forms</a>	Provides examples of Avaya Aura Communication Manager forms related to system-wide and individual telephone administration.

---



---

## Other Documentation

See the Avaya support site at <http://www.avaya.com/support> for 1600 Series IP Telephone technical and end user documentation.

The following documents are available for the 1600 Series IP Telephones:

- *Avaya 1600 Series IP Deskphones Installation and Maintenance Guide*, Document Number 16-601438.
- *Avaya one-X™ Deskphone Value Edition 1600 Series IP Telephone Pre-Installation Checklist*, Document Number 16-601439.
- *Avaya one-X™ Deskphone Value Edition 1600 Series IP Telephone Safety Instructions*, Document Number 16-601440.
- *Avaya one-X™ Deskphone Value Edition 1600 Series IP Telephones BM32 Button Module Installation and Safety Instructions*, Document Number 16-601441.
- *Avaya one-X™ 9600 Series IP Telephone Application Programmer Interface (API) Guide*, Document Number 16-601442.
- *Avaya 1600 Series IP Deskphones Administrator Guide*, Document Number 16-601443.
- *Avaya 1603/1603SW/1603-I/1603SW-I IP Deskphone User Guide*, Document Number 16-601444.
- *Avaya 1608/1608-I IP Deskphone User Guide*, Document Number 16-601446.
- *Avaya 1616/1616-I IP Deskphone User Guide*, Document Number 16-601448.
- *Avaya one-X™ Deskphone Value Edition 1600 Series IP Telephones BM32 Button Module User Guide*, Document Number 16-601450
- *Avaya one-X™ Deskphone Value Edition 1600 Series IP Telephone Wall Mount Instructions*, Document Number 16-601453.
- *Avaya one-X™ Deskphone Value Edition 1600 Series IP Telephone Stand Instructions*, Document Number 16-601451.
- *Avaya 1603/1603SW/1603-I/1603SW-I IP Deskphone Quick Reference*, Document Number 16-601445.
- *Avaya 1608/1608-I IP Deskphone Quick Reference*, Document Number 16-601447.
- *Avaya 616/1616-I IP Deskphone Quick Reference*, Document Number 16-601449.

See [Appendix B: Related Documentation](#) for a list of non-Avaya documents, such as those published by the Internet Engineering Task Force (IETF) and the International Telecommunication Union (ITU).

## **Introduction**

## **10 Avaya 1600 Series IP Deskphones Administrator Guide**

# Chapter 2: Administration Overview and Requirements

---

## 1600 Series IP Telephones

The 1600 Series IP Telephones currently support the H.323 signaling protocol.

The H.323 standard provides for real time audio, video, and data communications transmission over a packet network. An H.323 telephone protocol stack comprises several protocols:

- H.225 for registration, admission, status (RAS), and call signaling,
- H.245 for control signaling,
- Real Time Transfer Protocol (RTP), and
- Real Time Control Protocol (RTCP)

The parameters under which the 1600 Series IP Telephones need to operate are summarized as follows:

- Telephone and System Administration on the Avaya Media Server, as covered in [Chapter 4: Avaya Aura Communication Manager Administration](#).
- IP address management for the telephone, as covered in [DHCP and File Servers](#) on page 43 for dynamic addressing. For static addressing, see the *Avaya 1600 Series IP Deskphones Installation and Maintenance Guide*.
- Tagging Control and VLAN administration for the telephone, if appropriate, as covered in [Chapter 7: Administering Telephone Options](#).
- Quality of Service (QoS) administration for the telephone, if appropriate. QoS is covered in [QoS](#) on page 25 and [QoS](#) on page 34.
- Interface administration for the telephone, as appropriate. Administer the telephone to LAN interface using the PHY1 parameter described in [Chapter 3: Network Requirements](#). Administer the telephone to PC interface using the PHY2 parameter described in “Local Procedures” in the *Avaya 1600 Series IP Deskphones Installation and Maintenance Guide*.
- Application-specific telephone administration, if appropriate, as described in [Chapter 8: Administering Applications and Options](#). An example of application-specific data is specifying the extent to which users can add/edit/delete data for Contacts entries.
- Protocol administration, for example, Simple Network Management Protocol (SNMP) and Link Layer Discovery Protocol (LLDP).

## Administration Overview and Requirements

[Table 1](#) indicates that you can administer system parameters in a variety of ways and use a variety of delivery mechanisms like:

- Maintaining the information on the call server.
- Manually entering the information by means of the telephone dialpad.
- Administering the DHCP server.
- Editing the configuration file on the applicable HTTP or HTTPS file server.
- User modification of certain parameters, when given administrative permission to do so.

**Note:**

Not all parameters can be administered on all delivery mechanisms.

**Table 1: Administration Alternatives and Options for 1600 Series IP Telephones**

Parameter(s)	Administrative Mechanisms	For More Information See:
Telephone Administration	Avaya call server	<a href="#">Chapter 4: Avaya Aura Communication Manager Administration</a> , <a href="#">Chapter 5: Server Administration</a> , and <a href="#">Appendix B: Related Documentation</a> .
IP Addresses	DHCP (strongly recommended)	<a href="#">DHCP and File Servers</a> on page 43, and especially <a href="#">DHCP Server Administration</a> on page 44.
	Configuration file	<a href="#">Chapter 6: Telephone Software and Application Files</a> and <a href="#">Chapter 7: Administering Telephone Options</a> .
	Manual administration at the telephone	“Static Addressing Installation” in the <i>Avaya 1600 Series IP Deskphones Installation and Maintenance Guide</i> .
	LLDP	<a href="#">Link Layer Discovery Protocol (LLDP)</a> on page 79.
Tagging and VLAN	LLDP	<a href="#">Link Layer Discovery Protocol (LLDP)</a> on page 79.
	DHCP	<a href="#">DHCP Server Administration</a> on page 44, and <a href="#">Chapter 7: Administering Telephone Options</a> .
	Configuration file (strongly recommended)	<a href="#">DHCP and File Servers</a> on page 43 and <a href="#">Chapter 7: Administering Telephone Options</a> .

---

**1 of 3**

**Table 1: Administration Alternatives and Options for 1600 Series IP Telephones (continued)**

<b>Parameter(s)</b>	<b>Administrative Mechanisms</b>	<b>For More Information See:</b>
	Manual administration at the telephone	“Static Addressing Installation” in the <i>Avaya 1600 Series IP Deskphones Installation and Maintenance Guide</i> .
	Avaya call server	Use the <b>change ip-network-map</b> command to configure the VLAN ID.

---

**2 of 3**

---

**Table 1: Administration Alternatives and Options for 1600 Series IP Telephones (continued)**

Parameter(s)	Administrative Mechanisms	For More Information See:
Quality of Service	Avaya call server (strongly recommended)	<a href="#">UDP Port Selection</a> on page 34 and <a href="#">Appendix B: Related Documentation</a> .
	DHCP	<a href="#">DHCP and File Servers</a> on page 43, and <a href="#">Chapter 7: Administering Telephone Options</a> .
	Configuration file	<a href="#">DHCP and File Servers</a> on page 43, and <a href="#">Chapter 7: Administering Telephone Options</a> .
Interface	DHCP	<a href="#">DHCP and File Servers</a> on page 43, and <a href="#">Chapter 6: Telephone Software and Application Files</a> .
	Configuration file (strongly recommended)	<a href="#">DHCP and File Servers</a> on page 43, and <a href="#">Chapter 6: Telephone Software and Application Files</a> .
	Manual administration at the telephone	“Ethernet (Hub) Interface Enable/Disable” in the <i>Avaya 1600 Series IP Deskphones Installation and Maintenance Guide</i> .
	LLDP	<a href="#">Link Layer Discovery Protocol (LLDP)</a> on page 79.
Application - specific parameters	DHCP	<a href="#">DHCP and File Servers</a> on page 43, and especially <a href="#">DHCP Server Administration</a> on page 44. Also, <a href="#">Chapter 8: Administering Applications and Options</a> .
	Configuration file (strongly recommended)	<a href="#">DHCP and File Servers</a> on page 43, and especially <a href="#">HTTP Generic Setup</a> on page 55. Also, <a href="#">Chapter 8: Administering Applications and Options</a> .

**3 of 3**

General information about administering DHCP servers is covered in [DHCP and File Servers](#) on page 43, and more specifically, [DHCP Server Administration](#) on page 44. General information about administering HTTP servers is covered in [DHCP and File Servers](#), and more specifically, [HTTP Generic Setup](#). Once you are familiar with that material, you can administer telephone options as described in [Chapter 7: Administering Telephone Options](#).

---

## Parameter Data Precedence

If a given parameter is administered in multiple places, the last server to provide the parameter has precedence. The precedence, from lowest to highest, is:

1. LLDP,
2. Manual administration, with the two exceptions described for the system parameter [STATIC](#) on page 72,
3. DHCP,
4. HTTP/HTTPS script file,
5. the Avaya Media Server, and finally,
6. Backup files, if administered and if permitted.

Settings the IP telephone receives from backup files or the media server overwrite any previous settings, including manual settings. The only exception to this sequence is in the case of VLAN IDs. In the case of VLAN IDs, LLDP settings of VLAN IDs are the absolute authority. Then the usual sequence applies through HTTP/HTTPS.

**Note:**

For the L2QVLAN and L2Q system values, LLDP settings of VLAN IDs are the absolute authority only if the LLDP task receives the VLAN IDs before DHCP and HTTP, and the DHCP client of the telephone is activated at all. If the LLDP task receives the VLAN IDs after DHCP negotiation, several criteria must be successful before the telephone accepts VLAN IDs from LLDP. For more information, see [Link Layer Discovery Protocol \(LLDP\)](#).

---

## The Administrative Process

The following list depicts administration for a typical 1600 Series IP Telephone network. Your own configuration might differ depending on the servers and system you have in place.

1. LAN and applicable servers administered to accept the telephones.
2. Telephone software downloaded from the Avaya support site.
3. 46xxsettings file updated with site-specific information, as applicable.
4. 1600 Series Telephones installed. For more information, see the *Avaya 1600 Series IP Deskphones Installation and Maintenance Guide*.
5. Individual 1600 Series IP Telephones updated using local procedures, as applicable. For more information, see "Local Administrative Procedures" in the *Avaya 1600 Series IP Deskphones Installation and Maintenance Guide*.

## Administrative Checklist

Use the following checklist as a guide to system and LAN administrator responsibilities. This high-level list helps ensure that all telephone system prerequisites and requirements are met prior to telephone installation.

**Note:**

One person might function as both the system administrator and the LAN administrator in some environments.

**Table 2: Administrative Checklist**

Task	Description	For More Information See:
Network Requirements Assessment	Determine that network hardware is in place and can handle telephone system requirements.	<a href="#">Chapter 3: Network Requirements.</a>
Administer the call server	Verify that the call server is licensed and is administered for Voice over IP (VoIP).  Verify the individual telephones are administered as desired.	<a href="#">Chapter 4: Avaya Aura Communication Manager Administration.</a>  <a href="#">Chapter 4: Avaya Aura Communication Manager Administration.</a>
DHCP server installation	Install a DHCP application on at least one new or existing PC on the LAN.	Vendor-provided instructions.
Administer DHCP application	Add IP telephone administration to DHCP application.	<a href="#">DHCP Server Administration</a> in <a href="#">Chapter 5: Server Administration.</a>
HTTP/HTTPS server installation	Install an HTTP/HTTPS application on at least one new or existing PC on the LAN.	Vendor-provided instructions.
Application file(s), script file, and settings file installation on HTTP/HTTPS server	Download the files from the Avaya support site.	<a href="http://www.avaya.com/support">http://www.avaya.com/support</a> <a href="#">Chapter 6: Telephone Software and Application Files.</a>
Modify settings file as desired	Edit the settings file as desired, using your own tools or the [Avaya] Web configuration tool.	<a href="#">Chapter 6: Telephone Software and Application Files</a> and <a href="#">Web Configuration Tool</a> on page 58.



**Table 2: Administrative Checklist (continued)**

Task	Description	For More Information See:
Administer telephones locally as applicable	As a Group:	<a href="#">The GROUP System Value</a> on page 65 and the <i>Avaya 1600 Series IP Deskphones Installation and Maintenance Guide</i> .
	Individually:	The applicable Local Procedures in the <i>Avaya 1600 Series IP Deskphones Installation and Maintenance Guide</i> .
Installation of telephones in the network		<i>Avaya 1600 Series IP Deskphones Installation and Maintenance Guide</i> .
Allow user to modify Options, if applicable		<a href="#">OPSTAT</a> on page 70 and the respective User Guide for the specific telephone model.
		<b>2 of 2</b>

**Note:**

The 1608/1608-I and 1616/1616-I telephones support the Top Line Text and Audio Push types (but not the WML Push type).

---

## Telephone Initialization Process

These steps offer a high-level description of the information exchanged when the telephone initializes and registers. This description assumes that all equipment is properly administered ahead of time. This description can help you understand how the 1600 Series IP Telephones relate to the routers and servers in your network.

---

### Step 1: Telephone to Network

The telephone is appropriately installed and powered. After a short initialization process, the telephone identifies the LAN speed and sends a message out into the network, identifying itself and requesting further information. A router on the network receives and relays this message to the appropriate DHCP server if the phone IP address is 0.0.0.0.

## Step 2: DHCP Server to Telephone

The DHCP file server provides information to the telephone, as described in [DHCP and File Servers](#) on page 43. Among other data passed to the telephone is the IP address of the HTTP or HTTPS server.

---

## Step 3: Telephone and File Server

The 1600 Series IP Telephones can download script files and settings files from either an HTTP or HTTPS server. These telephones can also download the application files from the HTTP server. The telephone queries the file server, which transmits a script file to the telephone. This script file, at a minimum, tells the telephone which application file the telephone must use. The application file is the software that has the telephony functionality.

The telephone uses the script file to determine if it has the proper application file. If the telephone determines the proper application file is missing, the telephone requests an application file download from the HTTP server. The telephone then downloads the file and conducts some checks to ensure that the file was downloaded properly. If the telephone determines it already has the proper file, the telephone proceeds as described in the next paragraph without downloading the application file again.

The telephone checks and loads the application file, then uses the script file to look for a settings file, if appropriate. The optional settings file can contain settings you have administered for any or all of the 1600 Series IP Telephones in your network. For more information about this download process and settings file, see [Chapter 6: Telephone Software and Application Files](#).

---

## Step 4: Telephone and the Call Server

The call server referred to in this step is the Avaya Media Server.

In this step, the telephone might prompt the user for an extension and password. The telephone uses that information to exchange a series of messages with the call server. For a new installation and for full service, the user can enter the telephone extension and password. For a restart of an existing installation, this information is already stored on the telephone, but the user might have to confirm the information. The telephone and the call server exchange more messaging. The expected result is that the telephone is appropriately registered and call server data such as feature button assignments are downloaded.

The 1600 Series IP Telephones support a feature called Unnamed Registration. Unnamed Registration allows a telephone to register with the Avaya Media Server without an extension, assuming the Avaya Media Server also supports this feature. To invoke Unnamed Registration, take no action. Allow the **Extension...** prompt to display for 60 seconds without making an entry. The telephone automatically attempts to register by means of Unnamed Registration. A telephone registered with Unnamed Registration has the following characteristics:

- only one call appearance,
- no administrable features,
- can make only outgoing calls, subject to call server Class of Restriction/Class of Service limitations, and
- can be converted to normal “named” registration by the user entering a valid extension and password (that is, logging in).

**Note:**

Unnamed Registration requires administration on the Avaya Aura Communication Manager system.

You can also administer the telephone to avoid unnamed registration and remain unregistered if no extension and password are provided. For more information, see [UNNAMEDSTAT](#) in [Table 8](#).

For more information about the installation process, see the *Avaya 1600 Series IP Deskphones Installation and Maintenance Guide*.

---

## Error Conditions

Assuming proper administration, most of the problems reported by telephone users are likely to be LAN-based. Quality of Service, server administration, and other issues can impact user perception of IP telephone performance.

The *Avaya 1600 Series IP Deskphones Installation and Maintenance Guide* covers possible operational problems that might be encountered after successful 1600 Series IP Telephone installation. The following User Guides also contain guidance for users having problems with specific IP telephone applications:

- *Avaya 1603/1603SW/1603-I/1603SW-I IP Deskphone User Guide*, Document Number 16-601444.
- *Avaya 1608/1608-I IP Deskphone User Guide*, Document Number 16-601446.
- *Avaya 1616/1616-I IP Deskphone User Guide*, Document Number 16-601448.
- *Avaya one-X™ Deskphone Value Edition 1600 Series IP Telephones BM32 Button Module User Guide*, Document Number 16-601450.

## Administration Overview and Requirements

# Chapter 3: Network Requirements

---

## Network Assessment

Perform a network assessment to ensure that the network will have the capacity for the expected data and voice traffic, and that it can support for all applications:

- H.323,
- DHCP,
- HTTP/HTTPS, and
- Jitter buffers

Also, QoS support is required to run VoIP on your configuration. For more information, see [Appendix B: Related Documentation](#) and [UDP Port Selection](#) on page 34.

---

## Hardware Requirements

To operate properly, you need:

- Category 5e cables designed to the IEEE 802.3af-2003 standard, for LAN powering,
- For Avaya Aura Communication Manager: TN2602 IP Media Processor circuit pack. Sites with a TN2302 IP Media Processor circuit pack are strongly encouraged to install a TN2602 circuit pack.
- For Avaya Aura Communication Manager: TN799C or D Control-LAN (CLAN) circuit pack.



**Important:**

IP telephone firmware Release 1.0 or greater requires TN799C V3 or greater CLAN circuit pack(s). For more information, see the *Avaya Aura Communication Manager Software and Firmware Compatibility Matrix* on the Avaya support Web site

<http://www.avaya.com/support>.

To ensure that the appropriate circuit pack(s) are administered on your media server, see [Chapter 4: Avaya Aura Communication Manager Administration](#). For more information about hardware requirements in general, see the *Avaya 1600 Series IP Deskphones Installation and Maintenance Guide*.

## Server Requirements

Two server types can be configured for the 1600 Series IP Telephones:

- DHCP
- HTTP or HTTPS

**Note:**

HTTPS does not provide all of the functionality of HTTP. For example, backup/restore is unavailable via HTTPS, and firmware cannot be downloaded via HTTPS.

While the servers listed provide different functions that relate to the 1600 Series IP Telephones, they are not necessarily different boxes. For example, DHCP provides file management whereas HTTP provides application management, yet both functions can co-exist on one hardware unit. Any standards-based server is recommended.

For parameters related to Avaya Media Server information, see [Chapter 4: Avaya Aura Communication Manager Administration](#), and the administration documentation for your call server. For parameters related to DHCP and file servers, see [Chapter 5: Server Administration](#).

 **CAUTION:**

The telephones obtain important information from the script files on the file server and depend on the application file for software upgrades. If the DHCP file server is unavailable when the telephones reset, the telephones register with the media server and operate. Some features might not be available. To restore them you need to reset the telephone(s) when the file server is available.

---

## DHCP Server

Avaya recommends that a DHCP server and application be installed and that static addressing be avoided. Install the DHCP server and application as described in [DHCP and File Servers](#) on page 43.

---

## HTTP/HTTPS Server

Administer the HTTP or HTTPS file server and application as described in [HTTP Generic Setup](#) on page 55.

## Required Network Information

Before you administer DHCP and HTTP, and TLS, as applicable, complete the information in [Table 3](#). If you have more than one Gateway, HTTP/TLS server, subnetwork mask, and Gatekeeper in your configuration, complete [Table 3](#) for each DHCP server.

The 1600 Series IP Telephones support specifying a list of IP addresses for a gateway/router, HTTP/HTTPS server, and Avaya Media Server Gatekeeper(s). Each list can contain up to 255 total ASCII characters, with IP addresses separated by commas with no intervening spaces. Depending on the specific DHCP application, only 127 characters might be supported.

When specifying IP addresses for the file server or media server, use either dotted decimal format (“xxx.xxx.xxx.xxx”) or DNS names. If you use DNS, the system value DOMAIN is appended to the IP addresses you specify. If DOMAIN is null, the DNS names must be fully qualified, in accordance with IETF RFCs 1034 and 1035. For more information about DNS, see [DHCP Generic Setup](#) on page 44 and [DNS Addressing](#) on page 76.

**Table 3: Required Network Information Before Installation - Per DHCP Server**

1. Gateway (router) IP address(es)	
2. HTTP server IP address(es)	
3. Subnetwork mask	
4. Avaya Media Server Gatekeeper IP address(es)	
5. Avaya Media Server Gatekeeper port	Although this can be a value between 0 and 65535, the default value is <b>1719</b> . Do not change the default value unless that value conflicts with an existing port assignment.
6. HTTP server file path	
7. Telephone IP address range	
From:	
To:	
8. DNS server address(es)	If applicable.
9. HTTPS server address(es)	If applicable.

The file server file path is the “root” directory used for all transfers by the server. All files are uploaded to or downloaded from this default directory. In configurations where the upgrade script and application files are in the default directory, do not use item 6 in [Table 3](#).

As the LAN or System Administrator, you are also responsible for:

- Administering the DHCP server as described in [Chapter 5: Server Administration](#).
- Editing the configuration file on the applicable HTTP or HTTPS file server, as covered in [1600 Series IP Telephone Scripts and Application Files](#).

---

## Other Network Considerations

---

### SNMP

The 1600 Series IP Telephones are fully compatible with SNMPv2c and with Structure of Management Information Version 2 (SMIV2). The telephones respond correctly to queries from entities that comply with earlier versions of SNMP, such as SNMPv1. “Fully compatible” means that the telephones respond to queries directed either at the MIB-II or the read-only Custom MIB. Read-only means that the values therein cannot be changed externally by means of network management tools.

You can use the system value SNMPADD to restrict the IP addresses from which the telephone accepts SNMP queries. You can also customize your community string with the system value SNMPSTRING. For more information, see [Chapter 5: Server Administration](#) and [Table 8: 1600 Series IP Telephone Customizable System Parameters](#).

**Note:**

As of Release 1.0, SNMP is disabled by default. Administrators must initiate SNMP by setting the SNMPADD and SNMPSTRING system values appropriately.

For more information about SNMP and MIBs, see the IETF references listed in [Appendix B: Related Documentation](#). The Avaya Custom MIB for the 1600 Series IP Telephones is available for download in \*.txt format on the Avaya support Web site at <http://www.avaya.com/support>.



---

## Reliability and Performance

All 1600 Series IP Telephones respond to a ping or traceroute message sent from the DEFINITY®, MultiVantage™, Avaya Aura Communication Manager, or Avaya Aura Communication Manager Branch system (formerly known as Avaya Distributed Office) or any other network source. The telephones do not originate a ping or traceroute. The 1600 Series IP Telephones offer and support “remote ping” and “remote traceroute.” The switch can instruct the telephone to originate a ping or a traceroute to a specified IP address. The telephone carries out that instruction and sends a message to the switch indicating the results. For more information, see your switch administration documentation.

If applicable, the telephones test whether the network Ethernet switch port supports IEEE 802.1P/Q tagged frames by ARPing the router with a tagged frame. For more information, see [VLAN Considerations](#) on page 73. If your LAN environment includes Virtual LANs (VLANs), your router must respond to ARPs for VLAN tagging to work properly.

---

## QoS

For more information about the extent to which your network can support any or all of the QoS initiatives, see your LAN equipment documentation. See [QoS](#) on page 34 about QoS implications for the 1600 Series IP Telephones.

All 1600 Series IP Telephones provide some detail about network audio quality. For more information see, [Network Audio Quality Display on 1600 Series IP Telephones](#) on page 26.

---

## IEEE 802.1P and 802.1Q

For more information about IEEE 802.1P and IEEE 802.1Q and the 1600 Series IP Telephones, see [IEEE 802.1P and 802.1Q](#) on page 34 and [VLAN Considerations](#) on page 73. Three bits of the 802.1Q tag are reserved for identifying packet priority to allow any one of eight priorities to be assigned to a specific packet.

- **7:** Network management traffic
- **6:** Voice traffic with less than 10ms latency
- **5:** Voice traffic with less than 100ms latency
- **4:** “Controlled-load” traffic for critical data applications
- **3:** Traffic meriting “extra-effort” by the network for prompt delivery, for example, executive e-mail
- **2:** Reserved for future use
- **0:** The default priority for traffic meriting the “best-effort” for prompt delivery of the network.
- **1:** Background traffic such as bulk data transfers and backups

**Note:**

Priority 0 is a higher priority than Priority 1.

---

## Network Audio Quality Display on 1600 Series IP Telephones

All 1600 Series IP Telephones give the user an opportunity to monitor network audio performance while on a call. For more information, see the telephone user guide.

While on a call, the telephones display network audio quality parameters in real-time, as shown in [Table 4](#):

**Table 4: Parameters in Real-Time**

Parameter	Possible Values
Received Audio Coding	<b>G.711, G.711u, G.711a, G.726, G.729A, or G.729B.</b>
Packet Loss	"No data" or a percentage. Late and out-of-sequence packets are counted as lost if they are discarded. Packets are not counted as lost until a subsequent packet is received and the loss confirmed by the RTP sequence number.
Packetization Delay	"No data" or an integer number of milliseconds. The number reflects the amount of delay in received audio packets, and includes any potential delay associated with the codec.
One-way Network Delay	"No data" or an integer number of milliseconds. The number is one-half the value RTCP computes for the round-trip delay.
Network Jitter Compensation Delay	"No data" or an integer number of milliseconds reporting the average delay introduced by the jitter buffer of the telephone.

The implication for LAN administration depends on the values the user reports and the specific nature of your LAN, like topology, loading, and QoS administration. This information gives the user an idea of how network conditions affect the audio quality of the current call. Avaya assumes you have more detailed tools available for LAN troubleshooting.

---

## IP Address Lists and Station Number Portability

The 1600 Series IP Telephones provide the capability to specify IP address lists. On startup or a reboot, the telephone attempts to establish communication with these various network elements in turn. The telephone starts with the first address on the respective list. If the communication is denied or times out, the telephone proceeds to the next address on the appropriate list and tries that one. The telephone does not report failure unless all the addresses on a given list fail, thereby improving the reliability of IP telephony.

This capability also has the advantage of making station number portability easier. Assume a situation where the company has multiple locations in London and New York, all sharing a corporate IP network. Users want to take their telephones from their offices in London and bring them to New York. When users start up their telephones in the new location, the local DHCP server usually routes them to the local call server. With proper administration of the local DHCP server, the telephone knows to try a second call server IP address, this one in London. The user can then be automatically registered with the London call server.

[Chapter 5: Server Administration](#) contains details on administration of DHCP servers for lists of alternate media servers, router/gateways, and HTTP/HTTPS servers. For more information, see [DNS Addressing](#) on page 76.

---

## TCP/UDP Port Utilization

The 1600 Series IP Telephones use a variety of protocols, particularly TCP and UDP, to communicate with other equipment in the network. Part of this communication identifies which TCP or UDP ports each piece of equipment uses to support each protocol and each task within the protocol. For additional TCP/UDP port utilization information as it applies to Avaya Aura Communication Manager, see [UDP Port Selection](#) on page 34.

Depending on your network, you might need to know what ports or ranges are used in the operation of 1600 Series IP Telephones. Knowing these ports or ranges helps you administer your networking infrastructure.

In [Figure 1](#) and [Figure 2](#):

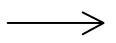
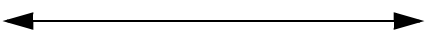
- The box on the left always represents the 1600 Series IP Telephone.
- Depending on the diagram, the boxes on the right refer to various pieces of network equipment with which the telephone can communicate.
- Open-headed arrows (for example, ) represent the direction(s) of socket initialization.
- Closed-headed arrows (for example, ) represent the direction(s) of data transfer.
- The text the arrows point to identifies the port or ports that the 1600 Series IP Telephones support for the specific situation. Brackets identify ranges when more than one port applies. The text indicates any additional qualifications or clarifications. In many cases, the ports used are the ones called for by IETF or other standards bodies.

**Figure 1: Signaling, Audio and Management Diagram**

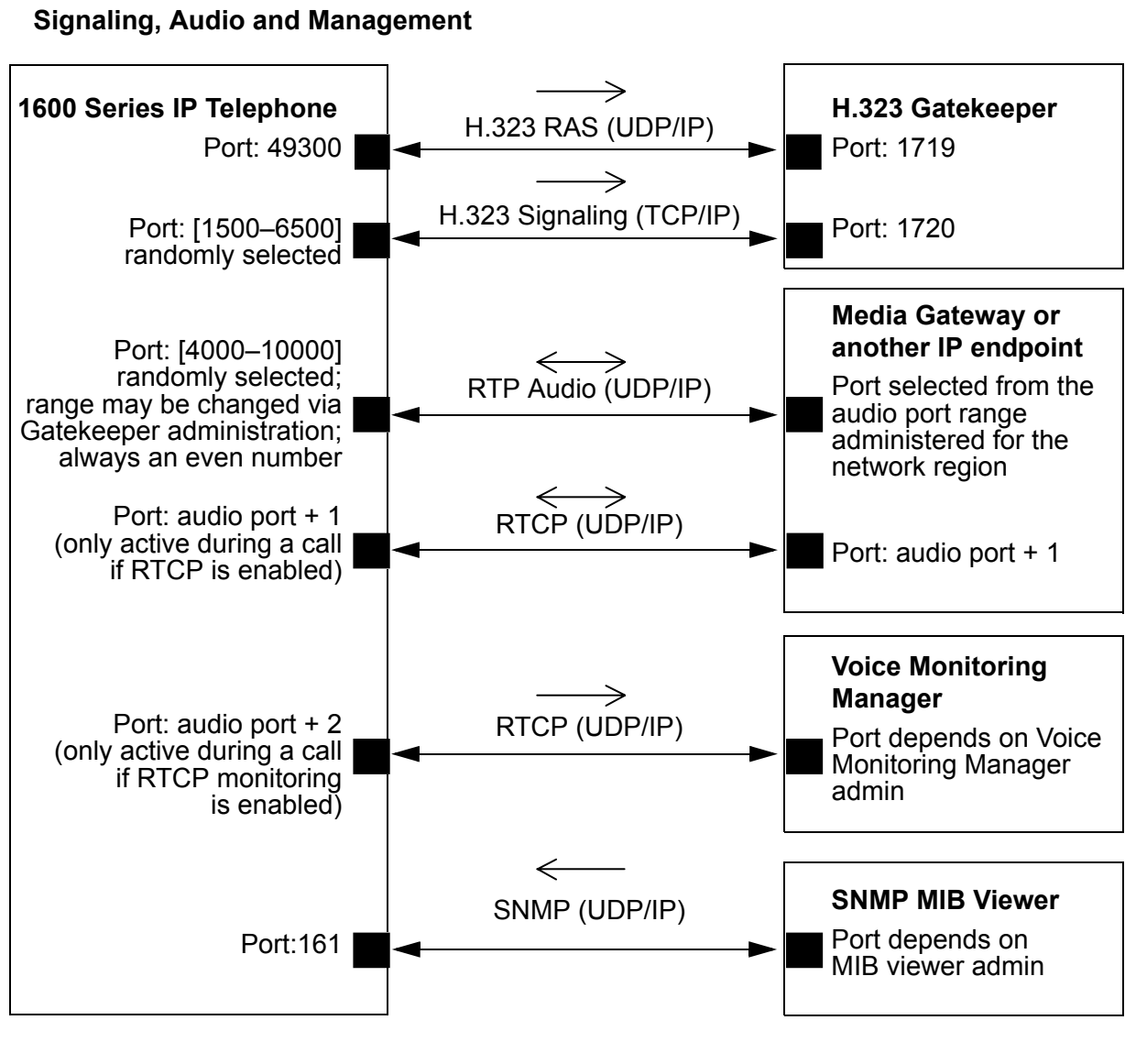
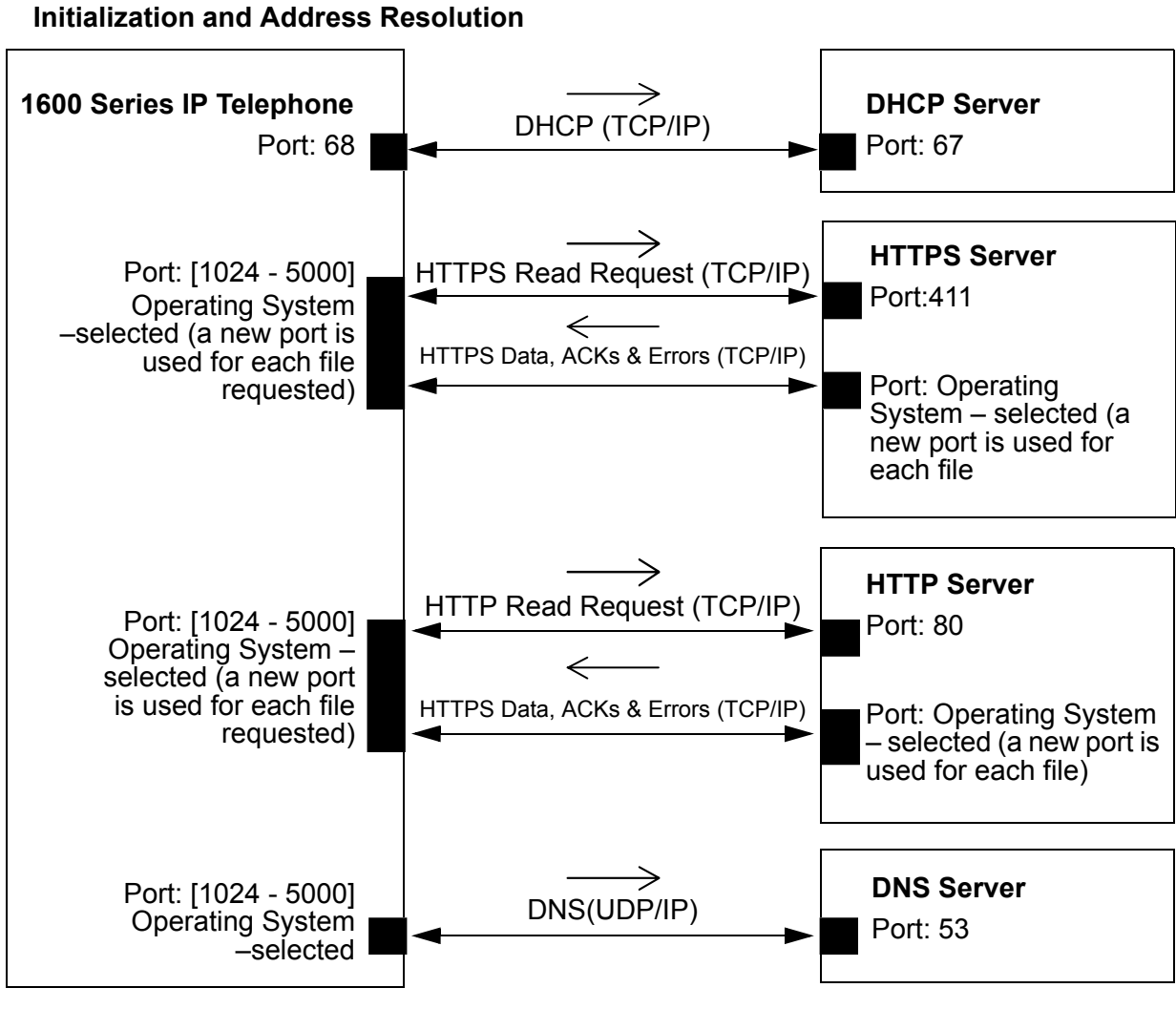

Figure 2: Initialization and Address Resolution Diagram



# Security

For information about toll fraud, see the DEFINITY<sup>®</sup>, Avaya Aura Communication Manager, or Avaya Aura Communication Manager Branch documents on the Avaya support Web site. The 1600 Series IP Telephones cannot guarantee resistance to all Denial of Service attacks. However, there are checks and protections to resist such attacks while maintaining appropriate service to legitimate users.

You also have a variety of optional capabilities to restrict or remove how crucial network information is displayed or used. These capabilities are covered in more detail in [Chapter 5: Server Administration](#).

- Support signaling channel encryption while registering, and when registered, with appropriately administered Avaya Media Servers.

**Note:**

Signaling and audio are not encrypted when unnamed registration is effective.

- Restricting the response of the 1600 Series IP Telephones to SNMP queries to only IP addresses on a list you specify.
- Specifying an SNMP community string for all SNMP messages the telephone sends.
- Restricting dialpad access to Local Administration Procedures, such as specifying IP addresses, with a password.
- Removing dialpad access to most Local Administration Procedures.
- Restricting the end user's ability to use a telephone Options application to view network data.

As of Release 1.1, three existing security-related parameters can be administered on the call server and downloaded with encrypted signaling, in addition to unencrypted HTTP or encrypted HTTPS. Those parameters are SNMP community string, SNMP Source IP Addresses, and Craft Access Code (PROCPSWD).

## Registration and Authentication

The Avaya Media Server supports using the extension and password to register and authenticate 1600 Series IP Telephones. For more information, see the current version of your call server administration manual.

# Chapter 4: Avaya Aura Communication Manager Administration

---

## Call Server Requirements

Before you perform administration tasks, ensure that the proper hardware is in place, and your call server software is compatible with the 1600 Series IP Telephones. Avaya recommends the latest PBX software and the latest IP telephone firmware.

---

## Switch Compatibility and Aliasing IP Telephones

As of Release 1.1, 1600 Series IP Telephones were natively supported by Avaya Aura Communication Manager Release 5.2. Native support means that if you have Avaya Aura Communication Manager Release 5.2, you:

- do not have to alias 1600 Series IP Telephones,
- can add up to two BM32 Button Modules on each 1616 Series IP Telephone, and
- can administer a call coverage telephone number on a station-by-station basis.

If you have Avaya Aura Communication Manager Release 5.1 or earlier, you must alias the telephones as follows:

<b>1600 Series Telephone Model</b>	<b>Aliased as...</b>	<b>Earliest Avaya Aura Communication Manager Release</b>
1603	4610	Avaya Aura Communication Manager 3.0
1603-I	4610	Avaya Aura Communication Manager 3.0
1603SW	4610	Avaya Aura Communication Manager 3.0
1603SW-I	4610	Avaya Aura Communication Manager 3.0
1608	4610	Avaya Aura Communication Manager 3.0

---

<b>1600 Series Telephone Model</b>	<b>Aliased as...</b>	<b>Earliest Avaya Aura Communication Manager Release</b>
1608-I	4610	Avaya Aura Communication Manager 3.0
1616	4620	Avaya Aura Communication Manager 3.0
1616-I	4620	Avaya Aura Communication Manager 3.0
BM32	EU24	Avaya Aura Communication Manager 3.0

The 1603, 1603SW, 1603-I, and 1603SW-I IP Telephones support three administrable call appearances or feature buttons. The 1608 and 1608-I IP Telephones support eight administrable call appearances or feature buttons. The 1616 and 1616-I IP Telephones support 16 administrable call appearances or feature buttons. In addition, the 1616/1616-I IP Telephones support the BM32 Button Module. The 1616/1616-I always support a single BM32, and with Avaya Aura Communication Manager Release 5.2 or later, support up to two BM32 Button Modules per telephone.

The BM32 Button Module provides another 32 administrable call appearances and features. When attached to a 1616/1616-I IP Telephone that is aliased as a 4620, the first 16 administered call appearances and features are placed directly on the telephone, and the next 32 administered call appearances and features are placed on the button module, for a total of 48 administrable buttons.

For more information about aliasing one telephone model as another, see “Using an Alias” in the *Administrator Guide for Avaya Aura™ Communication Manager* (Document 03-300509).

Avaya Aura Communication Manager Branch systems provide native support for the 1600 Series Telephones. See the Avaya Aura Communication Branch Device Manager online help for more information.



---

## Media Server (Switch) Administration

If you are using the 1600 Series IP Telephones with Avaya Aura Communication Manager, see the following documents on the Avaya support Web site for information about specific switch administration:

- The *Administrator Guide for Avaya Aura™ Communication Manager* (Document 03-300509) provides detailed instructions for administering an IP telephone system on Avaya Aura Communication Manager. See Chapter 3 “Managing Telephones,” which describes the process of adding new telephones. Also, you can locate pertinent screen illustrations and field descriptions in Chapter 19 “Screen References” of that guide.
- *Administration for Network Connectivity for Avaya Aura™ Communication Manager* (Document Number 555-233-504) provides detailed information about switch administration for your network.

If you are using the 1600 Series IP Telephones with Avaya Aura Communication Manager Branch, see the Avaya Aura Communication Manager Branch Device Manager online help for information about specific switch administration.

---

## IP Interface and Addresses

If you are using the 1600 Series IP Telephones with Avaya Aura Communication Manager, follow these general guidelines:

- Define the IP interfaces for each CLAN and Media processor circuit pack on the switch that uses the IP Interfaces screen. For more information, see *Administration for Network Connectivity for Avaya Aura™ Communication Manager* (Document 555-233-504).
- On the Customer Options form, verify that the **IP Stations** field is set to “y” (Yes). If it is not, contact your Avaya sales representative. The **IP Softphone** field does not have to be set to “y” (Yes).

If you are using the 1600 Series IP Telephones with Avaya Aura Communication Manager Branch, see the Avaya Aura Communication Manager Branch Device Manager online help for information about administering these telephones.

## UDP Port Selection

The 1600 Series IP Telephones can be administered from the Avaya Aura Communication Manager Network Region form to support UDP port selection. Locate specific port assignment diagrams in the *1600 IP Telephone Installation and Maintenance Guide*. For information about Avaya Aura Communication Manager implementation, see *Administration for Network Connectivity for Avaya Aura™ Communication Manager* (Document Number 555-233-504) on the Avaya support Web site.

Administer the switch to use a port within the proper range for the specific LAN, and the IP telephone(s) copy that port. If no UDP port range is administered on the switch, the IP telephone uses an even-numbered port, randomly selected from the interval 4000 to 10000.

---

## RSVP and RTCP

Avaya IP Telephones implement the Resource ReSerVation Protocol (RSVP) administered from the media server and the RTP Control Protocol (RTCP). The Avaya Voice over IP (VoIP) Monitoring Manager (VMON) software can then provide real-time monitoring and historical data of audio quality for VoIP calls.

The only way to change these parameters is by appropriate switch administration. For more information, see your Avaya Media Server administration documentation and *Administration for Network Connectivity for Avaya Aura™ Communication Manager* (Document Number 555-233-504).

---

## QoS

The 1600 Series IP Telephones support both IEEE 802.1P/Q and DiffServ. Other network-based QoS initiatives such as UDP port selection do not require support by the telephones. However, they contribute to improved QoS for the entire network.

---

## IEEE 802.1P and 802.1Q

The 1600 Series IP Telephones can simultaneously support receipt of packets using, or not using, 802.1Q parameters. To support IEEE 802.1P/Q, you can administer 1600 Series IP Telephones from the network by appropriate administration of the DHCP or HTTP/HTTPS servers, or by using dialpad input at the telephone.

 **Important:**

Avaya Aura Communication Manager administration always takes precedence over manual administration of IEEE 802.1P/Q data.

The four IEEE 802.1P/Q QoS parameters in the telephones that can be administered on the IP Network Region form are **L2Q, L2QVLAN, L2QAUD, and L2QSIG**. To set these parameters at the switch, see “About Quality of Service (QoS) and voice quality administration” in *Administration for Network Connectivity for Avaya Aura™ Communication Manager* (Document Number 555-233-504). To set these parameters manually see the *1600 IP Telephone Installation and Maintenance Guide*. You can specify VLAN ID and VLANTEST values with the ADDR Local Administrative Option.

**Note:**

All local administrative procedures are on a phone-by-phone basis. Administration using Avaya Aura Communication Manager, DHCP, and HTTP applies to the telephone system itself or to a range of telephones.

---

## NAT

Network Address Translation (NAT) usage can lead to problems that affect the consistency of addressing throughout your network. All H.323 IP Telephones support NAT interworking. Support for NAT does not imply support for Network Address Port Translation (NAPT). The telephones do not support communication to the PBX through any NAPT device.

NAT requires specific administration on the media server. A direct Avaya IP Telephone-to-Avaya IP Telephone call with NAT requires Avaya Aura Communication Manager Release 3.0 or greater software. For more information, see *Administration for Network Connectivity for Avaya Aura™ Communication Manager* (Document Number 555-233-504) on the Avaya support Web site.

---

## DIFFSERV

The DiffServ values change to the values administered on the media server as soon as the telephone registers. For more information, see Chapter 4 “Network Quality Administration” in *Administration for Network Connectivity for Avaya Aura™ Communication Manager* (Document Number 555-233-504). Unless there is a specific need in your enterprise LAN, Avaya recommends that you do not change the default values.

## Voice Mail Integration

---

### 1600 Series IP Telephones with Avaya Aura Communication Manager 5.2 Native Support

Release 1.1 provides native support for 1600 Series IP Telephones running on Avaya Aura Communication Manager Release 5.2 or later. When native support applies, pressing the **Messages** button causes the telephone to first determine if the call server has a dedicated number for retrieving voice mail and when found, to proceed with voice mail retrieval.

### 1600 Series IP Telephones Aliased as 4600 Series IP Telephones

When native support does not apply, 1600 Series IP Telephones are aliased as 4600 Series IP Telephones and run under an Avaya Aura Communication Manager Release earlier than 5.2. In this case, use the settings file to configure the **Messages** button by setting the system parameter [MSGNUM](#) to any dialable string. MSGNUM examples are:

- a standard telephone number the telephone should dial to access your voice mail system, such as AUDIX or Octel.
- a Feature Access Code (FAC) that allows users to transfer an active call directly to voice mail. FACs are supported only for QSIG-integrated voice mail systems like AUDIX or Octel. QSIG is an enhanced signaling system that allows the voice mail system and Avaya Aura Communication Manager Automated Call Processing (ACP) to exchange information.

When the user presses the **Messages** button on the telephone, that number or FAC is automatically dialed, giving the user one-touch access to voice mail.

The settings file specifies the telephone number to be dialed automatically when the user presses this button. The command is:

```
SET MSGNUM 1234
```

where **1234** is the Voice Mail extension (Avaya Aura Communication Manager hunt group or VDN). For more information, see [Table 8](#).

MSGNUM is used both in native support and when the telephone is aliased using non-native support. Messaging must be configured for native support.

A separate Voice Mail extension can be administered for each station.

---

## Telephone Administration

This section describes how to administer Avaya Aura Communication Manager for 1600 Series IP Telephones. For detailed information about administering Avaya Aura Communication Manager, see the following Avaya documents:

- *Administrator Guide for Avaya Aura™ Communication Manager* (Document 03-300509).
- *Feature Description and Implementation for Avaya Aura™ Communication Manager* (Document 555-245-770).

For detailed information about administering Avaya Aura Communication Manager Branch for 1600 Series IP Telephones, see the Avaya Aura Communication Manager Branch Device Manager online help.

---

## System-Wide Administration

This section refers to Avaya Aura Communication Manager administration on the Switch Administration Terminal (SAT) or by Avaya Site Administration. The system wide Avaya Aura Communication Manager form and the particular page that needs to be administered for each feature are provided. These features, which already exist, are not required but are recommended because they optimize the telephone user interface. Avaya Aura Communication Manager Release 3.0 or greater is required.

**Note:**

See [Appendix C: Sample Administration Forms](#) for illustrated examples of the pages used to administer Avaya Aura Communication Manager features.

---

## Feature-Related System Parameters

Release 1.1 supports the functionality introduced on Avaya Aura Communication Manager Release 5.2 that allows call server administration of three system-wide parameters. By administering these parameters on Avaya Aura Communication Manager, they can be automatically downloaded to the telephone during registration, instead of or in addition to from the settings file or locally per telephone. The three system parameters are: SNMP community

## Avaya Aura Communication Manager Administration

string, SNMP Source IP addresses, and Craft Access Code (PROCPSWD). Administer these three parameters using Page 3 of the change system-parameters ip-options form.

### Avaya Aura Communication Manager Feature Administration

Feature	Administration
<b>On-Hook Dialing</b>	Set up Avaya Aura Communication Manager so that the phone supports on-hook dialing. Use the System Parameters Features form page 10. Use the command <b>Change system-parameters features</b> to view the form and make the change.
<b>Auto Hold</b>	Set up Avaya Aura Communication Manager to enable <b>Auto Hold</b> , so that the phone automatically places an active call on hold when the user answers or resumes a call on another call appearance. Use the System Parameters Features form, page 6.
<b>Coverage Path</b>	Administer a coverage path for both phone demonstration and normal operations. Use the Coverage Path form and give it a number, for example, Coverage path 1. If Voice Mail is available, this is also where you administer the hunt group or VDN, depending on the type of Voice Mail system being used.
<b>Enhanced Conference Features</b>	Enable enhanced conference display to support the user experience for conferences. Block Enhanced Conference Display on the Class of Restriction (COR) form must be set to <b>No</b> . Use the command <b>Change COR</b> , followed by a number, to view the form and make the change. a sample of the Class of Restriction form.

---

## Administering Stations

This section refers to Avaya Aura Communication Manager administration on the Switch Administration Terminal (SAT) or by Avaya Site Administration. Administer the following items on the Station form, sample screens of which are provided in [Figure 3](#) through [Figure 6](#). Avaya recommends setting the features covered in this section because they optimize the user interface.

Release 1.1 supports the functionality introduced on Avaya Aura Communication Manager Release 5.2 that allows call server administration of the GROUP parameter on a station-by-station basis. As covered in [The GROUP System Value](#) on page 65, the GROUP Identifier can be used in conjunction with the 46xxsettings file to allow administration to apply to specific “groups” of telephones. Before Release 1.1, the Group Identifier had to be administered locally on each applicable telephone. As of Release 1.1, the Group Identifier can be administered centrally, and downloaded to each applicable telephone. The GROUP ID parameter is administered on page 3 of the Change Station Form. Once downloaded, the Group Identifier takes effect starting with the next telephone boot-up.

For sample Station Forms, see [Appendix C: Sample Administration Forms](#).

---

## Aliasing 1600 Series IP Telephones

Avaya Aura Communication Manager releases earlier than 5.2 do not provide native support for 1600 Series IP Telephones. On the Station Form, administer (alias) the telephones as follows:

Change Alias Station:

- Alias set up type 1603/1603SW/1603-I/1603SW-I to a 4610
- Alias set up type 1608/1608-I to a 4610
- Alias set up type 1616/1616-I to a 4620SW/4621SW

Avaya Aura Communication Manager Release 5.2 (and later) provides native support for the 1603,1603SW, 1603-I, 1603SW-I, 1608, 1608-I, 1616, and 1616-I.

---

## Administering Features

The following are administrable Station Features that Avaya recommends you administer for your 1600 Series IP Telephones for maximum user experience.

### Administrable Station Features

Feature	Administration
<b>Enhanced Conference Features</b>	Administer <b>Conf-dsp</b> (conference display) on the station form as a feature button. Doing so turns on enhanced conference features and gives users advanced conference features.
<b>Far End Mute</b>	Administer <b>fe-mute</b> (far end mute). When this is enabled the phone shows a "Silence" softkey on the Conference details screen. This feature works only for trunk calls.
<b>Send All Calls (SAC)</b>	On the Station form, administer <b>SAC</b> (send-calls) as a feature button. On the Station form to the right of where send all calls is administered, leave the extension box empty. This feature requires a coverage path to be administered on the station form.
<b>Coverage Path</b>	For normal operation, you must set up a coverage path for each telephone. Administer the Station form to point to the appropriate system coverage path, for example, coverage path 1.
<b>Auto select any idle appearance</b>	Set <b>Auto select any idle appearance</b> to <b>N</b> (no) to optimize answering calls.
<b>Restrict Last Call Appearance</b>	Set <b>Restrict Last Call Appearance</b> to <b>Y</b> (yes).
<b>Conference/Transfer on Primary Appearance</b>	Set <b>Conference/Transfer on Primary Appearance</b> to <b>Y</b> (yes) to ensure that conference/transfer of a bridged appearance works properly.

---

## Feature Buttons and Call Appearances

### For the 1603/1603SW/1603-I/1603SW-I and 1608/1608-I IP Telephones

You can administer Feature/Call Appearance Buttons 1 – 8 on the Avaya Aura Communication Manager Station form, which the telephone Feature screen then displays in sequence. The telephone does not display any of the Feature Button labels administered on buttons 9 – 24. These telephones do not support the BM32 Button Module.

### For the 1616/1616-I IP Telephones

You can administer Feature/Call Appearance Buttons 1 – 16 on the Avaya Aura Communication Manager Station form. The features administered on the Station form appear in the same sequence on the telephone Feature screen. Features administered on the Expansion Module BM32 Call Appearance buttons display on the telephone Features screen following the first 16 administered feature buttons. All administered BM32 Button Labels (Call Appearances and Feature Buttons) display on the corresponding BM32 module buttons.

In [Table 5](#) the term “phone screen” refers to either the call appearance screen or the features screen, as applicable to the button type.

**Table 5: Station Form Administration Results**

Feature / Call Appearance (CA) / Bridged Call Appearance (BA) buttons on the Station form...	Is displayed on the phone as:		
	1603/1603SW 1603-I/1603SW-I	1608/1608-I	1616/1616-I
1	Phone screen	Phone screen	Phone screen
2 to 16	CAs/BAs on Phone screen; must scroll to see more than 1	CAs/BAs on Phone screen; must scroll to see more than 1	CAs/BAs on Phone screen; must scroll to see more than 1
17 to 48	N/A	N/A	First BM32
49 to 80	N/A	N/A	Second BM32



For additional information about administering the call server for 1600 Series IP Telephones, see the following Avaya documents, available on the Avaya Support Web site:

- *Administrator Guide for Avaya Aura™ Communication Manager* (Document Number 03-300509).
- *Feature Description and Implementation for Avaya Aura™ Communication Manager* (Document Number 555-245-770).

---

## Conference Details Screen for Ad-Hoc Conferences

Conference Details allows the user to view parties on a conference call and selectively mute or drop individual parties for a conference call setup.

If administered on an Expansion Module button, the BM32 Button Module must be connected.

### To enable Conference Details capabilities:

1. On the Class of Restriction (COR) form make sure that **Block Enhanced Conference/ Transfer Displays** is set to **No**.
2. As described in [On-Hook Dialing](#), administer the Conference Display Feature Button to a Phone button on the Phone screen.

---

## Shuffling

Administer shuffling on three forms:

- Feature-Related Parameters form, shown in [Figure 7](#). Set the **Direct IP-IP Audio Connections?** field to **y** (yes).
- IP Network Region form, shown in [Figure 11](#). Set both the **Intra-region IP-IP Direct Audio** field and the **Inter-region IP-IP Direct Audio** field to **y** (yes).
- Station form, shown in [Figure 4](#). Set the **Direct IP-to-IP Audio Connection** to **y** (yes). The Station form setting overrides the network region, which overrides the system setting.

## Printing Button Labels

You can download software from [www.desi.com](http://www.desi.com) that enables you to print button labels for the 1600 series telephones. To download this software, perform the following steps:

1. Using your web browser, go to **www.desi.com**.
2. Click **DESI downloads**.
3. Download the appropriate application.

If you are using Avaya Aura Communication Manager Branch, you can export the button settings from Local Manager and import the settings into the DESI application. For more information, see the Avaya Aura Communication Manager Branch Device Manager online help.

# Chapter 5: Server Administration

---

## Software Checklist

Ensure that you own licenses to use the DHCP, HTTP, and HTTPS server software.

**Note:**

You can install the DHCP and HTTP server software on the same machine.

 **CAUTION:**

The firmware in the 1600 Series IP Telephones reserves IP addresses of the form **192.168.0.24** and **192.168.1.x** for internal communications. The telephone(s) improperly use addresses you specify if they are of that form.

---

## DHCP and File Servers

Dynamic Host Configuration Protocol (DHCP) minimizes maintenance for a 1600 Series IP Telephone network by removing the need to individually assign and maintain IP addresses and other parameters for each IP telephone on the network.

The DHCP server provides the following information to the 1600 Series IP Telephones:

- IP address of the 1600 Series IP Telephone(s)
- IP address of the Gatekeeper board on the Avaya Media Server
- IP address of the HTTP or HTTPS server
- The subnet mask
- IP address of the router
- DNS Server IP address

Administer the LAN so each IP telephone can access a DHCP server that contains the IP addresses and subnet mask.

The IP telephone cannot function without an IP address. The failure of a DHCP server at boot time leaves all the affected telephones unusable. A user can manually assign an IP address to an IP telephone. When the DHCP server finally returns, the telephone never looks for a DHCP server unless the static IP data is unassigned manually. In addition, manual entry of IP data is an error-prone process.

## Server Administration

Avaya recommends that:

- A minimum of two DHCP servers be available for reliability.
- A DHCP server be available when the IP telephone reboots.
- A DHCP server be available at remote sites if WAN failures isolate IP telephones from the central site DHCP server(s).

The file server provides the 1600 Series IP Telephone with a script file and, if appropriate, new or updated application software. See [Step 3: Telephone and File Server](#) on page 18 under [Telephone Initialization Process](#). In addition, you can edit an associated settings file to customize telephone parameters for your specific environment. For more information, see [Chapter 7: Administering Telephone Options](#).

---

## DHCP Server Administration

This document concentrates on the simplest case of the single LAN segment. Information provided here can be used for more complex LAN configurations.



### **CAUTION:**

Before you start, understand your current network configuration. An improper installation can cause network failures or reduce the reliability and performance of your network.

---

## DHCP Generic Setup

This document is limited to describing a generic administration that works with the 1600 Series IP Telephones. Three DHCP software alternatives are common to Windows operating systems:

- Windows NT<sup>®</sup> 4.0 DHCP Server
- Windows 2000<sup>®</sup> DHCP Server
- Windows 2003<sup>®</sup> DHCP Server

Any other DHCP application might work. It is the responsibility of the customer to install and configure the DHCP server correctly.

DHCP server setup involves:

1. Installing the DHCP server software according to vendor instructions.
2. Configuring the DHCP server with:
  - IP addresses available for the 1600 Series IP Telephones.
  - The following DHCP options:
    - **Option 1 - Subnet mask.**  
As described in [Table 3](#), item 3.
    - **Option 3 - Gateway (router) IP address(es).**  
As described in [Table 3](#), item 1. If using more than one address, the total list can contain up to 255 total ASCII characters. You must separate IP addresses with commas with no intervening spaces.
    - **Option 6 - DNS server(s) address list.**  
If using more than one address, the total list can contain up to 127 total ASCII characters. You must separate IP addresses with commas with no intervening spaces. At least one address in Option 6 must be a valid, non zero, dotted decimal address.
    - **Option 12 - Host Name.**  
Value is **AVohhhhhh**, where: o is "A" if the OID (first three octets) of the MAC address for the telephone is 00-04-0D. "E" if the OID is 00-09-6E, "L" if the OID is 00-60-1D, and "X" if the OID is anything else and where **hhhhh** are ASCII characters for the hexadecimal representation of the last three octets of the MAC address for the telephone.
    - **Option 15 - DNS Domain Name.**  
This string contains the domain name to be used when DNS names in system parameters are resolved into IP addresses. This domain name is appended to the DNS name before the 1600 IP Telephone attempts to resolve the DNS address. Option 15 is necessary if you want to use a DNS name for the HTTP server. Otherwise, you can specify a DOMAIN as part of customizing HTTP as indicated in [DNS Addressing](#) on page 76.
    - **Option 51 - DHCP lease time.**  
If this option is not received, the DHCP OFFER is not be accepted. Avaya recommends a lease time of six weeks or greater. If this option has a value of FFFFFFFF hex, the IP address lease is assumed to be infinite as per RFC 2131, Section 3.3, so that renewal and rebinding procedures are not necessary even if Options 58 and 59 are received. Expired leases cause Avaya IP Telephones to reboot. Avaya recommends providing enough leases so an IP address for an IP telephone does not change if it is briefly taken offline.

### Note:

The DHCP standard states that when a DHCP lease expires, the device should immediately cease using its assigned IP address. If the network has problems and the only DHCP server is centralized, the server is not accessible to the given telephone. In this case the telephone is not usable until the server can be reached.

Avaya recommends, once assigned an IP address, the telephone continues using that address after the DHCP lease expires, until a conflict with another device is detected. As [Table 8: 1600 Series IP Telephone Customizable System Parameters](#) indicates, the system parameter DHCPSTD allows an administrator to specify that the telephone will either:

- a). Comply with the DHCP standard by setting DHCPSTD to “1”, or
- b). Continue to use its IP address after the DHCP lease expires by setting DHCPSTD to “0.”

The latter case is the default. If the default is invoked, after the DHCP lease expires the telephone sends an ARP Request for its own IP address every five seconds.

The request continues either forever, or until the telephone receives an ARP Reply. After receiving an ARP Reply, the telephone displays an error message, sets its IP address to 0.0.0.0, and attempts to contact the DHCP server again.

- **Option 52 - Overload Option, if desired.**

If this option is received in a message, the telephone interprets the **sname** and **file** fields in accordance with IETF RFC 2132, Section 9.3, listed in [Appendix B: Related Documentation](#).

- **Option 53 - DHCP message type.**

Value is 1 (DHCPDISCOVER) or 3 (DHCPREQUEST).

- **Option 55 - Parameter Request List.**

Acceptable values are:

- 1 (subnet mask),
- 3 (router IP address[es])
- 6 (domain name server IP address[es])
- 15 (domain name)
- NVSSON (site-specific option number)

- **Option 57 - Maximum DHCP message size.**

- **Option 58 - DHCP lease renew time.**

If not received or if this value is greater than that for Option 51, the default value of T1 (renewal timer) is used as per IETF RFC 2131, Section 4.5, listed in [Related Documentation](#).

- **Option 59 - DHCP lease rebind time.**

If not received or if this value is greater than that for Option 51, the default value of T2 (rebinding timer) is used as per RFC 2131, Section 4.5

The 1600 Series IP Telephones do not support Regular Expression Matching, and therefore, do not use wildcards. For more information, see [Administering Options for the 1600 Series IP Telephones](#) on page 67.

In configurations where the upgrade script and application files are in the default directory on the HTTP server, do not use the HTTPDIR=<path>.

You do not have to use Option 242. If you do not use this option, you must ensure that the key information, especially HTTPSRVR and MCIPADD, is administered appropriately elsewhere.

Avaya recommends that you administer DHCP servers to deliver only the options specified in this document. Administering additional, unexpected options might have unexpected results, including causing the IP telephone to ignore the DHCP server.

The media server name and HTTP server name must each be no more than 32 characters in length.

Examples of good DNS administration include:

- Option 6: "**aaa.aaa.aaa.aaa**"
- Option 15: "**dnsexample.yourco.com,zzz.zzz.zzz.zzz**"
- Option 242: "**MCIPADD=xxxx.xxx.xxx.xxx**"

Depending on the DHCP application you choose, be aware that the application most likely does not immediately recycle expired DHCP leases. An expired lease might remain reserved for the original client a day or more. For example, Windows NT<sup>®</sup> DHCP reserves expired leases for about one day. This reservation period protects a lease for a short time. If the client and the DHCP server are in two different time zones, the clocks of the computers are not in sync, or the client is not on the network when the lease expires, there is time to correct the situation.

The following example shows the implication of having a reservation period: Assume two IP addresses, therefore two possible DHCP leases. Assume three IP telephones, two of which are using the two available IP addresses. When the lease for the first two telephones expires, the third telephone cannot get a lease until the reservation period expires. Even if the other two telephones are removed from the network, the third telephone remains without a lease until the reservation period expires.

In [Table 6](#), the 1600 Series IP Telephone sets the system values to the DHCPACK message field values shown.

**Table 6: DHCPACK Setting of System Values**

System Value	Set to
IPADD	The <b>yiaddr</b> field.
NETMASK	Option #1 (if received).
GIPADD	Option #3 (if received, which might be a list of IP addresses).
TLSSRVR	The <b>siaddr</b> field, if that field is non-zero.
HTTPSRVR	The <b>siaddr</b> field, if that field is non-zero.
DNSSRVR	Option #6 (if received, which might be a list of IP addresses).
DOMAIN	Option #15 (if received).
DHCP lease time	Option #51 (if received).
DHCP lease renew time	Option #58 (if received).
DHCP lease rebind time	Option #59 (if received).

The system values L2Q, L2QVLAN, and PHY2VLAN are not set from a *name=value* pair if those system values were previously set by LLDP. For more information, see [Link Layer Discovery Protocol \(LLDP\)](#).

---

## Windows NT 4.0 DHCP Server

### Verifying the Installation of the DHCP Server

Use the following procedure to verify whether the DHCP server is installed.

1. Select **Start-->Settings-->Control Panel**.
2. Double-click the **Network** icon.
3. Verify that **Microsoft DHCP Server** is listed as one of the Network Services on the **Services** tab.
4. If it is listed, continue with the next section. If it is not listed, install the DHCP server.



## Creating a DHCP Scope for the IP Telephones

Use the following procedure to create a DHCP scope for the IP telephones.

1. Select **Start-->Programs-->Admin Tools-->DHCP Manager**.
2. Expand **Local Machine** in the DHCP Servers window by double clicking it until the **+** sign changes to a **-** sign.
3. Select **Scope-->Create**.
4. Using information recorded in [Table 3: Required Network Information Before Installation - Per DHCP Server](#):

Define the **Telephone IP Address Range**.

Set the **Subnet Mask**.

To **exclude** any IP addresses you do not want assigned to IP telephones within the **Start** and **End** addresses range:

- a. In the **Exclusion Range Start Address** field, enter the **first IP Address** in the range that you want to exclude.
- b. In the **Exclusion Range End Address** field, enter the **last IP Address** in the range that you want to exclude.
- c. Click the **Add** button.
- d. Repeat steps a. through c. for each IP address range to be excluded.

**Note:**

Avaya recommends that you provision the 1600 Series IP Telephones with sequential IP addresses. Also do not mix 1600 Series IP Telephones and PCs in the same scope.

5. Under **Lease Duration**, select the **Limited To** option and set the **lease duration** to the maximum.
6. Enter a **sensible name** for the **Name** field, such as "DEFINITY IP Telephones."
7. Click **OK**.

A dialog box prompts you: Activate the new scope now?

8. Click **No**.

**Note:**

Activate the scope only after setting all options.

## Editing Custom Options

Use the following procedure to edit custom options.

1. Highlight the newly created scope.
2. Select **DHCP Options**-->**Defaults** in the menu.
3. Click the **New** button.
4. In the **Add Option Type** dialog box, enter an appropriate custom option name, for example, "1600OPTION."
5. Change the **Data Type Byte** value to **String**.
6. Enter **242** in the **Identifier** field.
7. Click the **OK** button.

The **DHCP Options** menu displays.

8. Select the **Option Name** for 242 and set the *value string*.
9. Click the **OK** button.
10. For the **Option Name** field, select **003 Router** from the drop-down list.
11. Click **Edit Array**.
12. Enter the **Gateway IP Address** recorded in [Table 3: Required Network Information Before Installation - Per DHCP Server](#) for the **New IP Address** field.
13. Select **Add** and then **OK**.

## Adding the DHCP Option

Use the following procedure to add the DHCP option.

1. Highlight the scope you just created.
2. Select **Scope** under **DHCP Options**.
3. Select the **242** option that you created from the **Unused Options** list.
4. Click the **Add** button.
5. Select option **003** from the **Unused Options** list.
6. Click the **Add** button.
7. Click the **OK** button.
8. Select the **Global parameter** under **DHCP Options**.
9. Select the **242** option that you created from the **Unused Options** list.
10. Click the **Add** button.
11. Click the **OK** button.

## Activating the Leases

Use the following procedure to activate the leases.

- Click **Activate** under the **Scope** menu.  
The light-bulb icon for the scope lights.

## Verifying Your Configuration

This section describes how to verify that the **1600OPTION** is correctly configured for the Windows NT<sup>®</sup> 4.0 DHCP server.

### Note:

Although this configuration represents that for 1600 Series IP Telephones, the file remains as 46XXOPTIONS. This allows shared use by 4600, 9600, and 1600 Series IP Telephones.

### Verify the Default Option, 242 1600OPTION

1. Select **Start-->Programs-->Admin Tools-->DHCP Manager**.
2. Expand **Local Machine** in the DHCP servers window by double clicking until the + sign changes to a - sign.
3. In the DHCP servers frame, click the *scope* for the IP telephone.
4. Select **Defaults** from the **DHCP\_Options** menu.
5. In the **Option Name** pull-down list, select **242 1600OPTION**.
6. Verify that the **Value String** box contains the correct string from [DHCP Server Administration](#).

If not, update the string and click the **OK** button twice.

### Verify the Scope Option, 242 1600OPTION

1. Select **Scope** under **DHCP OPTIONS**.
2. In the **Active Options:** scroll list, click **242 1600OPTION**.
3. Click the **Value** button.
4. Verify that the **Value String** box contains the correct string from [DHCP Generic Setup](#) on page 44.

If not, update the string and click the **OK** button.

### Verify the Global Option, 242 1600OPTION

1. Select **Global** under **DHCP OPTIONS**.
2. In the **Active Options:** scroll list, click **242 1600OPTION**.
3. Click the **Value** button.
4. Verify that the **Value String** box contains the correct value from [DHCP Generic Setup](#) on page 44.  
If not, update the string and click the **OK** button.

---

## Windows 2000 DHCP Server

### Verifying the Installation of the DHCP Server

Use the following procedure to verify whether the DHCP server is installed.

1. Select **Start-->Program-->Administrative Tools-->Computer Management**.
2. Under **Services and Applications** in the Computer Management tree, find **DHCP**.
3. If DHCP is not installed, install the DHCP server. Otherwise, proceed directly to [Creating and Configuring a DHCP Scope](#) for instructions on server configuration.

### Creating and Configuring a DHCP Scope

Use the following procedure to create and configure a DHCP scope.

1. Select **Start-->Programs-->Administrative Tools-->DHCP**.
2. In the console tree, click the *DHCP server* to which you want to add the DHCP scope for the IP telephones. This is usually the name of your DHCP server machine.
3. Select **Action-->New Scope** from the menu.  
Windows displays the **New Scope Wizard** to guide you through rest of the setup.
4. Click the **Next** button.  
The **Scope Name** dialog box displays.
5. In the **Name** field, enter a name for the scope such as "DEFINITY IP Telephones," then enter a brief comment in the **Description** field.
6. When you finish Steps 1 - 5, click the **Next** button.  
The **IP Address Range** dialog box displays.
7. Define the range of IP addresses used by the IP telephones listed in [Table 3: Required Network Information Before Installation - Per DHCP Server](#). The **Start IP Address** is the first IP address available to the IP telephones. The **End IP Address** is the last IP address available to the IP telephones.

**Note:**

Avaya recommends not mixing 1600 Series IP Telephones and PCs in the same scope.

8. Define the **subnet mask** in one of two ways:

- The number of bits of an IP address to use for the network/subnet IDs.
- The subnet mask IP address.

Enter only one of these values. When you finish, click the **Next** button.

The **Add Exclusions** dialog box displays.

9. Exclude any IP addresses in the range specified in the previous step that you do not want assigned to an IP telephone.

- a. In the **Start Address** field under **Exclusion Range**, enter the **first IP Address** in the range you want to exclude.
- b. In the **End Address** field under **Exclusion Range**, enter the **last IP Address** in the range you want to exclude.
- c. Click the **Add** button.
- d. Repeat steps a. through c. for each IP address range that you want to exclude.

**Note:**

You can add additional exclusion ranges later by right clicking the **Address Pool** under the newly created scope and selecting the **New Exclusion Range** option.

Click the **Next** button after you enter all the exclusions.

The **Lease Duration** dialog box displays.

10. For all telephones that obtain their IP addresses from the server, enter **30 days** in the **Lease Duration** field. This is the duration after which the IP address for the device expires and which the device needs to renew.

11. Click the **Next** button.

The **Configure DHCP Options** dialog box displays.

12. Click the **No, I will activate this scope later** button.

The **Router (Default Gateway)** dialog box displays.

13. For each router or default gateway, enter the **IP Address** and click the **Add** button.

When you are done, click the **Next** button.

The **Completing the New Scope Wizard** dialog box displays.

14. Click the **Finish** button.

The new scope appears under your server in the DHCP tree. The scope is not yet active and does not assign IP addresses.

15. Highlight the newly created scope and select **Action-->Properties** from the menu.

16. Under **Lease duration for DHCP clients**, select **Unlimited** and then click the **OK** button.



### **CAUTION:**

IP address leases are kept active for varying periods of time. To avoid having calls terminated suddenly, make the lease duration unlimited.

## Adding DHCP Options

Use the following procedure to add DHCP options to the scope you created in the previous procedure.

1. On the DHCP window, right-click the **Scope Options** folder under the scope you created in the last procedure.

A drop-down menu displays.

2. In the left pane of the DHCP window, right click the **DHCP Server name**, then click **Set Predefined Options...**

3. Under **Predefined Options and Values**, click **Add**.

4. In the **Option Type Name** field, enter *any appropriate name*, for example, "Avaya IP Telephones."

5. Change the **Data Type** to **String**.

6. In the **Code** field, enter **242**, then click the **OK** button twice.

The **Predefined Options and Values** dialog box closes, leaving the DHCP dialog box enabled.

7. Expand the newly created scope to reveal its **Scope Options**.

8. Click **Scope Options** and select **Action-->Configure Options** from the menu.

9. In the **General** tab page, under the **Available Options**, check the **Option 242** checkbox.

10. In the **Data Entry** box, enter the *DHCP IP telephone option string* as described in [DHCP Generic Setup](#) on page 44.

### **Note:**

You can enter the text string directly on the right side of the **Data Entry** box under the ASCII label.

11. From the list in **Available Options**, check option **003 Router**.

12. Enter the *gateway (router) IP Address* from the IP address field of [Table 3: Required Network Information Before Installation - Per DHCP Server](#).

13. Click the **Add** button.

14. Click the **OK** button.

## Activating the New Scope

Use the following procedure to activate the new scope.

1. In the DHCP console tree, click the **IP Telephone Scope** you just created.
2. From the **Action** menu, select **Activate**.

The small red down arrow over the scope icon disappears, indicating that the scope was activated.

---

## HTTP Generic Setup

You can store the same application software, script file, and settings file on an HTTP server as you can on a TFTP server. TFTP is not supported for 1600 Series IP Telephones. With proper administration, the telephone seeks out and uses that material. Some functionality might be lost by a reset if the HTTP server is unavailable. For more information, see [DHCP and File Servers](#) on page 43.

 **CAUTION:**

The files defined by HTTP server configuration must be accessible from all IP telephones invoking those files. Ensure that the file names match the names in the upgrade script, including case, since UNIX systems are case-sensitive.

**Note:**

Use any HTTP application you want. Commonly used HTTP applications include Apache<sup>®</sup> and Microsoft<sup>®</sup> IIS<sup>™</sup>.

 **Important:**

You must use the Avaya Web configuration server to obtain HTTPS so information is authenticated.

The Avaya Web configuration server does not support backup/restore. If you intend to use HTTP for backup/restore purposes, you must use an HTTP server that is independent of the Avaya Web configuration server.

To set up an HTTP server:

- Install the HTTP server application.
- Administer the system parameter HTTPSRVR to the address(es) of the HTTP server. Include these parameters in DHCP Option 242, or the appropriate SSON Option.

- Download the upgrade script file and application file(s) from the Avaya Web site <http://www.avaya.com/support> to the HTTP server. For more information, see [Contents of the Settings File](#) on page 64.

**Note:**

Many LINUX servers distinguish between upper and lower case names. Ensure that you specify the settings file name accurately, as well as the names and values of the data within the file.

If you choose to enhance the security of your HTTP environment by using Transport Layer Security (TLS), you also need to:

- Install the TLS server application.
- Administer the system parameter TLSSRV to the address(es) of the Avaya HTTPS server.

---

# HTTP Configuration for Backup/Restore

---

## For IIS Web Servers

For IIS 4.0 (WinNT4.0), IIS 5.0 (Win2000), IIS 5.1 (WinXP), IIS 6.0 (Win2003):

1. Create a "backup" folder under the root directory of your Web server. All backup files will be stored in that directory.

For example, if your backup folder is **C:/inetpub/wwwroot/backup** the 46xxsettings.txt file should have a line similar to:

```
[SET BRURI http://www.website.com/backup/]
```

If your backup folder is the root directory, the 46xxsettings.txt file should have a line similar to:

```
[SET BRURI http://www.website.com/]
```

2. Use **Internet Information Services Manager** or **Internet Information Services** depending on your OS. Go to **Start --> Settings --> Control Panel --> Administrative Tools**.
3. Right click on the folder created for backup, or right click on **Default Web Site** if there is no specific backup directory.
4. Select **Properties**.
5. In the Directory tab, make sure the **Write** box is checked.



Additional step for IIS 6.0 (Win2003):

1. Use **Internet Information Services**. Go to **Start --> Settings --> Control Panel --> Administrative Tools**.
2. Below Default Web Site select **Web Services Extension**.
3. Make sure the WebDAV option is set to **Allowed**.

For Apache Web servers:

1. Create a "backup" folder under the root directory of your Web server, and **make the folder writable by everyone**. All backup files will be stored in that directory.

If your backup folder is for instance **C:/Program Files/Apache Group/Apache2/htdocs/backup**, the 46xxsettings.txt file should have a line similar to:

```
[SET BRURI http://www.website.com/backup/]
```

If your backup folder is the root directory, the 46xxsettings.txt file should have a line similar to:

```
[SET BRURI http://www.website.com/]
```

2. Edit your Web server configuration file **httpd.conf**.
3. Uncomment the two LoadModule lines associated with DAV:

```
LoadModule dav_module modules/mod_dav.so
LoadModule dav_fs_module modules/mod_dav_fs.so
```

**Note:**

If these modules are not available on your system, typically the case on some Unix/Linux Apache servers, you have to recompile these two modules (mod\_dav & mod\_dav\_fs) into the server. Other ways to load these modules might be available. Check your Apache documentation at <http://httpd.apache.org/docs/> for more details.

4. Add the following lines in the **httpd.conf** file:

```
#
# WebDAV configuration
#
DavLockDB "C:/Program Files/Apache Group/Apache2/var/DAVLock"
  <Location />
    Dav On
  </Location>
```

For Unix/Linux Web servers the fourth line might look more like:

```
DavLockDB/usr/local/apache2/var/DAVLock
```

5. Create the var directory and **make it writable by everyone**. Right click **Properties-->Security-->Add-->Everyone-->Full Control**.

## Web Configuration Tool

Recent call server versions provide all the Web configuration support the 1600 Series IP Telephones require. Also, the media server has an easy to use, PC-based interface for creating script files. Given these resources, you do not need to manually create the text files discussed in [1600 Series IP Telephone Scripts and Application Files](#). For more information about the media server, see *Installation and Upgrades for Avaya G700 Media Gateway and Avaya S8300 Media Server*, available on the Avaya support Web site.

[Table 8: 1600 Series IP Telephone Customizable System Parameters](#) lists the parameters you can administer when manually creating the configuration file. Manual administration is discussed in [1600 Series IP Telephone Scripts and Application Files](#). When using the media server, you do not need to know the specific parameter names, since the media server handles that. For more information, [Table 7](#) lists the parameter names from [1600 Series IP Telephone Customizable System Parameters](#) and the corresponding field name from the media server HTTP server application. Any limits, restrictions, etc. about the parameters are built into the media server.

**Note:**

The Web Configuration application covers other IP telephones in addition to the 1600 Series IP Telephones. This document covers only data applicable to 1600 Series IP Telephones.

**Table 7: Media Server Field Names & Corresponding Script File Parameter Names**

Media Server Field Name	Script File Parameter Name
Handset Audio Gain Control Status	AGCHAND
Headset Audio Gain Control Status	AGCHEAD
Speaker Audio Gain Control Status	AGCSPKR
Application Status	APPSTAT
Script File Server Authentication	AUTH
<b>Note:</b> Applicable only when configuration file downloaded using HTTPS. Not applicable if file downloaded using HTTP.	
Idle Time Before Backlight Turnoff	BAKLIGHTOFF
Backup and Restore URI	BRURI
CNA Server Addresses	CNASRVR

**Table 7: Media Server Field Names & Corresponding Script File Parameter Names (continued)**

Media Server Field Name	Script File Parameter Name
CNA Port Number	CNAPORT
802.1X Supplicant Mode	DOT1X DOT1XSTAT
DHCP Lease Violation Flag	DHCPSTD
Domain Name	DOMAIN
Domain Name Server	DNSSRVR
HTTP Server IP Address	HTTPSRVR
HTTP Directory	HTTPDIR
Send Destination Unreachable Messages	ICMPDU
Process Received Redirect Messages	ICMPRED
Layer 2 Frame Tagging	L2Q
802.1A VLAN Identifier	L2QVLAN
System-Wide Language	LANGSYS
English Language Selection Status	LANG0STAT
Language File Name	LANGxFILE (with x being 1-4)
Font File Name	FONTFILE
Event Log Security Level	LOGLOCAL
Syslog Server Address	LOGSRVR
Management Complex IP Addresses	MCIPADD
Voice Mail Telephone Number	MSGNUM
User Options Access	OPSTAT
Telephone Country Code	PHNCC
Telephone Dial Plan Length	PHNDPLENGTH
International Access Code	PHNIC
Long Distance Access Code	PHNLD

**2 of 3**

**Table 7: Media Server Field Names & Corresponding Script File Parameter Names (continued)**

<b>Media Server Field Name</b>	<b>Script File Parameter Name</b>
National Telephone # Length	PHNLDLENGTH
Outside Line Access Code	PHNOL
Ethernet Line Interface Status	PHY1STAT
Secondary Ethernet Interface Layer 2 Priority Value	PHY2PRIO
Secondary Ethernet Line Interface Status	PHY2STAT
Secondary Ethernet Interface VLAN Identifier	PHY2VLAN
Local (dial pad) Procedure Password	PROCPSWD
Local Dialpad Procedures Allowed	PROCSTAT
Reregistration Timer	REREGISTER
RTCP Monitor IP Address	RTCPMON
Source IP Addresses for SNMP Queries	SNMPADD
SNMP Community String	SNMPSTRING
Subscription List	SUBSCRIBELIST
Trusted Domains/Paths	TPSLIST
Unnamed Registration Status	UNNAMEDSTAT
Secondary Ethernet Interface Layer 2 Frame Tagging	VLANSEP
Wait Time for DHCP Offer	VLANTEST

# Chapter 6: Telephone Software and Application Files

---

## General Download Process

The 1600 Series IP Telephones download script files and settings files from either an HTTP or HTTPS server. These telephones download the application files from the HTTP server. The HTTPS server applies only if the server supports Transport Layer Security (TLS) encryption.

**Note:**

The script files, application files, and settings files discussed in this chapter are identical for HTTP and HTTPS servers. The generic term “file server” refers to both “HTTP server” and “HTTPS server.”

The file downloading process is the same for both servers, except when you use an HTTPS server, a TLS server is contacted first. The telephone queries the file server, which transmits a script file to the telephone. The script file tells the telephone which application file the telephone must use. The application file is the software that has the telephony functionality, and is easily updated for future enhancements. In a newly installed telephone, the application file might be missing. In a previously installed telephone, the application file might not be the proper one. In both cases, the telephone requests a download of the proper application file from the HTTP server. The file server downloads the file and conducts some checks to ensure that the file was downloaded properly. If the telephone determines it already has the proper file, the telephone proceeds to the next step without downloading the application file again.

After checking and loading the application file, the 1600 Series IP Telephone, if appropriate, uses the script file to look for a settings file. The settings file contains options you have administered for any or all of the 1600 Series IP Telephones in your network. For more information about the settings file, see [Contents of the Settings File](#) on page 64.

---

## Software

When shipped from the factory, the 1600 Series IP Telephones might not contain sufficient software for registration and operation. When the telephone is first plugged in, a software download from an HTTP server starts to give the phone its proper functionality.

For software upgrade downloads, the call server provides the capability for a remote restart of the 1600 Series IP Telephone. As a result of restarting, the telephone automatically starts reboot procedures. If new software is available on the server, the telephone downloads it as part of the reboot process. The *Avaya 1600 Series IP Deskphones Installation and Maintenance Guide* covers upgrades to a previously installed telephone and related information.

---

# 1600 Series IP Telephone Scripts and Application Files

---

## Choosing the Right Application File and Upgrade Script File

The software releases containing the files needed to operate the 1600 Series IP Telephones are bundled together. You download this self-extracting executable file to your file server from the Avaya support Web site at: <http://www.avaya.com/support>. The file is available in both zipped and unzipped format.

The bundle contains:

- An upgrade script file and a settings file, which allow you to upgrade to new software releases and new functionality without having to replace IP telephones.
- Application files for all current 1600 Series IP Telephones.
- Other useful information such as a ReadMe file and a settings file template to customize parameters and settings, and the latest binary code.
- Font files
- Language files

---

## Upgrade Script File

An upgrade script file tells the IP telephone whether the telephone needs to upgrade software. The Avaya IP Telephones attempt to read this file whenever they reset. The upgrade script file also points to the settings file.

You download a default upgrade script file, sometimes called the “script file,” from <http://www.avaya.com/support>. This file allows the telephone to use default settings for customer-definable options. This file must reside in the same directory as the upgrade script file, and must be called **46xxsettings.txt**. The settings file contains settings for 1600, 9600, and 4600 Series IP Telephones.

**Note:**

Avaya recommends that the settings file have the extension **\*.txt**. The Avaya IP Telephones can operate without this file. You can also change these settings with DHCP or, in some cases, from the dialpad of the telephone.

## Settings File

The settings file contains the option settings you need to customize the Avaya IP Telephones for your enterprise.

**Note:**

You can use one settings file for all your Avaya IP Telephones. The settings file includes the 1600 Series IP Telephones covered in this document as well as 9600 Series IP Telephones and 4600 Series IP Telephones.

The settings file can include any of five types of statements, one per line:

- Comments, which are statements with a “#” character in the first column.
- Tags, which are comments that have exactly one space character after the initial #, followed by a text string with no spaces.
- Goto commands, of the form **GOTO tag**. Goto commands cause the telephone to continue interpreting the configuration file at the next line after a # tag statement. If no such statement exists, the rest of the configuration file is ignored.
- Conditionals, of the form **IF \$name SEQ string GOTO tag**. Conditionals cause the Goto command to be processed if the value of *name* is a case-insensitive equivalent to *string*. If no such *name* exists, the entire conditional is ignored. The only system values that can be used in a conditional statement are: BOOTNAME, GROUP, and SIG.
- SET commands, of the form **SET parameter\_name value**. Invalid values cause the specified value to be ignored for the associated *parameter\_name* so the default or previously administered value is retained. All values must be text strings, even if the value itself is numeric, a dotted decimal IP address, and so on.

**Note:**

Enclose all data in quotation marks for proper interpretation.

The upgrade script file Avaya provides includes a line that tell the telephone to **GET 46xxsettings.txt**. This line causes the telephone to use HTTP or HTTPS to attempt to download the file specified in the **GET** command. If the file is obtained, its contents are interpreted as an additional script file. That is how your settings are changed from the default settings. If the file cannot be obtained, the telephone continues processing the upgrade script file.

If the configuration file is successfully obtained but does not include any setting changes the telephone stops using HTTP. This happens when you initially download the script file template from the Avaya support Web site, before you make any changes. When the configuration file contains no setting changes, the telephone does not go back to the upgrade script file.

Avaya recommends that you do **not** alter the upgrade script file. If Avaya changes the upgrade script file in the future, any changes you have made will be lost. Avaya recommends that you use the **46xxsettings** file to customize your settings instead. However, you can change the settings file name, if desired, as long as you also edit the corresponding **GET** command in the upgrade script file.

For more information on customizing your settings file, see [Contents of the Settings File](#).

## Contents of the Settings File

After checking the application software, the 1600 Series IP Telephone looks for a 46xxsettings file. This optional file is where you identify non-default option settings, application-specific parameters, and so on. You can download a template for this file from the Avaya support Web site. An example of what the file might look like follows.

**Note:**

The following is intended only as a simple example. Your settings will vary from the settings shown. This sample assumes specification of a DNS Server and turning off enhanced local dialing for 96xx Series IP Telephones.

```
DNSSRVR="dnsexample.yourco.com"
```

```
ENDIALSTAT=0
```

See [Chapter 7: Administering Telephone Options](#) for details about specific values. You need only specify settings that vary from defaults, although specifying defaults is harmless.

VLAN separation controls whether or not traffic received on the secondary Ethernet interface are forwarded on the voice VLAN and whether network traffic received on the data VLAN are forwarded to the telephone. Add commands to the 46xxsettings.txt file to enable VLAN separation. The following example assumes the voice VLAN ID is "xxx", the data VLAN ID is "yyy" and the data traffic priority is "z":

```
SET VLANSEP 1  
SET L2Q 1 (or 0 for auto)  
SET L2QVLAN xxx  
SET PHY2VLAN yyy  
SET PHY2PRIO z
```

**Note:**

Also configure the network switch so that 802.1Q tags are not removed from frames forwarded to the telephone.



---

## The GROUP System Value

You might have different communities of users, all of which have the same telephone model, but which require different administered settings. For example, you might want to restrict Call Center agents from being able to Logoff, which might be an essential capability for “hot-desking” associates. We provide examples of the group settings for each of these situations later in this section.

Use the GROUP system value for this purpose:

1. identify which telephones are associated with which group, and designate a number for each group. The number can be any integer from 0 to 999, with 0 as the default, meaning your largest group is assigned as Group 0.
2. At each non-default telephone, instruct the installer or user to invoke the GROUP Local (dialpad) Administrative procedure as specified in the *Avaya 1600 Series IP Deskphones Installation and Maintenance Guide* and specify which GROUP number to use. The GROUP System value can only be set on a phone-by-phone basis.
3. Once the GROUP assignments are in place, edit the configuration file to allow each telephone of the appropriate group to download its proper settings.

Here is an example of the configuration file for the Call Center agent:

```
IF $GROUP SEQ 1 goto CALLCENTER
IF $GROUP SEQ 2 goto HOTDESK
{specify settings unique to Group 0}
goto END

# CALLCENTER
{specify settings unique to Group 1}
goto END

# HOTDESK
{specify settings unique to Group 2}

# END
{specify settings common to all Groups}
```



# Chapter 7: Administering Telephone Options

---

## Administering Options for the 1600 Series IP Telephones

This chapter explains how to change parameters by means of the DHCP or HTTP servers. In all cases, you are setting a system parameter in the telephone to a desired value. [Table 8](#) lists:

- the parameter names,
- their default values,
- the valid ranges for those values, and
- a description of each one.

For DHCP, the DHCP Option sets these parameters to the desired values as discussed in [DHCP and File Servers](#) on page 43. For HTTP, the parameters in [Table 8](#) are set to desired values in the script file. For more information, see [Contents of the Settings File](#) on page 64. When using a media server, see [Table 7: Media Server Field Names & Corresponding Script File Parameter Names](#) on page 58 for information on parameters set by the media server application.

Avaya recommends that you administer options on the 1600 Series IP Telephones using script files. Some DHCP applications have limits on the amount of user-specified information. The administration required can exceed those limits for the more full-featured telephone models.

You might choose to completely disable the capability to enter or change option settings from the dialpad. You can set the system value, PROCPSWD, as part of standard DHCP/HTTP administration. Alternately, you can set PROCPSWD on the system-parameters ip-options form, as of Avaya Aura Communication Manager Release 5.2. If PROCPSWD is non-null and consists of 1 to 7 digits, the user cannot invoke any “dialpad options” without first pressing **Mute** and entering the PROCPSWD value. For more information on dialpad options, see the *Avaya 1600 Series IP Deskphones Installation and Maintenance Guide*.

 **CAUTION:**

PROCPSWD is likely stored on the server “in the clear” and is sent to the telephone in the clear. Therefore, do not consider PROCPSWD as a high-security technique to inhibit a sophisticated user from obtaining access to local procedures.

Administering this password can limit access to all local procedures, including V I E W. VIEW is a read-only option that allows review of the current telephone settings.

**Table 8: 1600 Series IP Telephone Customizable System Parameters**

Parameter Name	Default Value	Description and Value Range
AGCHAND	1	Automatic Gain Control status for handset (0=disabled, 1=enabled).
AGCHEAD	1	Automatic Gain Control status for headset (0=disabled, 1=enabled).
AGCSPKR	1	Automatic Gain Control status for Speaker (0=disabled, 1=enabled).
APPNAME	" " (Null)	Primary application image file name, as provided in the 1600upgrade.txt file.
APPSTAT	1	Controls whether specific applications are enabled, restricted, or disabled. Values are: 1=all applications enabled, 2=Speed Dial (Contacts) changes and Call Log disabled and Redial last number only, 3=Speed Dial (Contacts) changes disabled, 0=Speed Dial (Contacts) changes, Call Log, and Redial disabled.
AUTH	0	Script file authentication value (0=HTTP is acceptable, 1=HTTPS is required).
BAKLIGHTOFF	120	Number of minutes without display activity to wait before turning off the backlight. Values: 0-999, no spaces and no null value. A value of 0 means the backlight never turns off.
BRURI	" " (Null)	URL used for backup and retrieval of user data. Specify HTTP server and directory path to backup file. Do not specify backup file name. Value: 0-255 ASCII characters. Null is a valid value and spaces are allowed.
DHCPSTD	0	DHCP Standard lease violation flag. Indicates whether to keep the IP address if there is no response to lease renewal. If set to "1" (No) the telephone strictly follows the DHCP standard with respect to giving up IP addresses when the DHCP lease expires. If set to "0" (Yes) the telephone continues using the IP address until it detects reset or a conflict (see <a href="#">DHCP Generic Setup</a> ).
DNSSVR	0.0.0.0	Text string containing the IP address of zero or more DNS servers, in dotted-decimal format, separated by commas with no intervening spaces (0-255 ASCII characters, including commas).
DOMAIN	" " (Null)	Text string containing the domain name to be used when DNS names in system values are resolved into IP addresses. Valid values are 0-255 ASCII characters. If Null, no spaces allowed.
DOT1X	0	802.1X Supplicant operation mode. Valid values are: 0=With PAE pass-through, 1=with PAE pass-through and proxy Logoff, 2=without PAE pass-through or proxy Logoff. For more information, see <a href="#">IEEE 802.1X</a> on page 77.

Table 8: 1600 Series IP Telephone Customizable System Parameters (continued)

Parameter Name	Default Value	Description and Value Range
DOT1XSTAT	0	Determines how the telephone handles Supplicants. Valid values are: 0=Supplicant operation is completely disabled. 1=Supplicant operation is enabled, but responds only to received unicast EAPOL messages. 2=Supplication operation is enabled and responds to received unicast and multicast EAPOL messages. For more information, see <a href="#">IEEE 802.1X</a> on page 77.
ENHDIALSTAT	1	Enhanced Dialing Status. If set to "1" the <a href="#">Enhanced Local Dialing</a> feature is turned on for all associated applications. If set to "0" the feature is turned off.
FONTFILE	" " (Null)	Name of the font file for a language for a 1600 Series International telephone.
HTTPDIR	" " (Null)	HTTP server directory path. The path name prepended to all file names used in HTTP and HTTPS get operations during initialization. Value: 0-127 ASCII characters, no spaces. Null is a valid value. Leading or trailing slashes are not required.
HTTPSRVR	" " (Null)	Text list of HTTP server addresses in dotted decimal or DNS format, separated by commas (0-255 ASCII characters, including commas).
ICMPDU	0	Controls whether ICMP Destination Unreachable messages will be processed. Values are: 0=No, 1=Send limited Port Unreachable messages, 2=Send Protocol and Port Unreachable messages.
ICMPRED	0	Controls whether ICMP Redirect messages will be processed. Values are: 0=No, 1=Yes.
L2Q	0	Controls whether Layer 2 frames have IEEE 802.1Q tags (0=auto, 1=enabled, 2=disabled).
L2QVLAN	0	802.1Q VLAN Identifier (0 to 4094). Null (" ") is not a valid value and the value cannot contain spaces. VLAN identifier used by IP telephones. Set this parameter only when IP telephones are to use a VLAN that is separate from the default data VLAN. If the VLAN identifier is to be configured via H.323 signaling based on Avaya Aura Communication Manager administration forms, it should not be set here.
LANG0STAT	1	Controls whether the built-in English language text strings can be selected by the user. Valid values are: 0 = User cannot select English language text strings 1 = User can select English language text strings/
LANGxFILE	" " (Null)	Name of the language file in use: LANG1FILE = LANG2FILE = LANG3FILE = LANG4FILE =

Table 8: 1600 Series IP Telephone Customizable System Parameters (continued)

Parameter Name	Default Value	Description and Value Range
LANGSYS	" " (Null)	0 to 32 ASCII characters. The file name of the system default language file, if any.
LOGLOCAL	0	Event Log Severity Level (one 0-8 ASCII numeric digit). Controls the level of events logged in the endptRecentLog and endptResetLog objects in the SNMP MIB. Events with the selected level and with a higher severity level will be logged. Valid values are: 0=Disabled, 1=emergencies, 2=alerts, 3=critical, 4=errors, 5=warnings, 6=notices, 7=information, 8=debug.
LOGSRVR	" " (Null)	Voice Monitoring Manager (VMM) Server Address. Zero or one IP address in dotted-decimal format or DNS Name format (0-15 ASCII characters).
MCIPADD	0.0.0.0	Call Server Address. Zero or more Avaya Aura Communication Manager server IP addresses. Format is dotted-decimal or DNS name format, separated by commas without intervening spaces (0-255 ASCII characters, including commas). Null is a valid value.
MSGNUM	" " (Null)	Voice mail telephone number. Specifies the number to be dialed automatically when the telephone user presses the <b>Message</b> button. Value: 0-30 ASCII dialable characters (0-9, * and #) and no spaces. Null is a valid value.
OPSTAT	111	Options status flag(s) (1 or 3 ASCII numeric digits) indicate which options are user-selectable. The default of 111 grants access to all options and related applications. Single digit valid values are: 1=user can access all options, including Logout, 2= user can access only view-oriented applications.  Three-digit valid values are a concatenation of binary values, in the form <i>abc</i> , where each letter represents a 0 (disabled/off) or 1 (enabled/on), interpreted as: <i>a</i> = base settings for all user options and related applications, except as noted in <i>b</i> or <i>c</i> . <i>b</i> = setting for view-oriented applications (for example, the Network Information application), as applicable. <i>c</i> = setting for Logout application, if applicable. The binary "0" does not allow an end user to see or invoke options and related applications. The binary "1" allows full display and access to all options and related applications.
PHNCC	1	Telephone country code. The administered international country code for the location by the algorithm that dials calls from the incoming Call Log or from Web pages. Range: 1-3 digits, from "1" to "999."

Table 8: 1600 Series IP Telephone Customizable System Parameters (continued)

Parameter Name	Default Value	Description and Value Range
PHNDPLENGTH	5	Internal extension telephone number length. Specifies the number of digits associated with internal extension numbers by the algorithm that dials calls from the incoming Call Log or from Web pages. Range: 1 or 2 digits, from "3" to "10."
PHNIC	011	Telephone international access code. The maximum number of digits, if any, dialed to access public network international trunks by the algorithm that dials calls from the incoming Call Log or from Web pages. Range: 0-4 digits.
PHNLD	1	Telephone long distance access code. The digit, if any, dialed to access public network long distance trunks by the algorithm that dials calls from the incoming Call Log or from Web pages. Range: 1 digit or "" (Null).
PHNLLENGTH	10	Length of national telephone number. The number of digits in the longest possible national telephone number by the algorithm that dials calls from the incoming Call Log or from Web pages. Range: 1 or 2 digits, from "3" to "10." Range: 1 or 2 ASCII numeric characters, from "5" to "15."
PHNOL	9	Outside line access code. The character(s) dialed, including # and *, if any, to access public network local trunks by the algorithm that dials calls from the incoming Call Log or from Web pages. Range: 0-2 dialable characters, including "" (Null).
PHY1STAT	1	Ethernet line interface setting (1=auto-negotiate, 2=10Mbps half-duplex, 3=10Mbps full-duplex, 4=100Mbps half-duplex, 5=100Mbps full-duplex, and 6=1000Mbps full-duplex if supported by the hardware).
PHY2PRIO	0	Layer 2 priority value for frames received on or forwarded to the secondary Ethernet interface. Set this parameter only when VLAN separation is "1" (enabled). Values are from 0-7 and correspond to the drop-down menu selection.
PHY2STAT	1	Secondary Ethernet interface setting (0=Secondary Ethernet interface off/disabled, 1=auto-negotiate, 2=10Mbps half-duplex, 3=10Mbps full-duplex, 4=100Mbps half-duplex, 5=100Mbps full-duplex), and 6=1000Mbps full-duplex if supported by the hardware).
PHY2VLAN	0	VLAN identifier used by frames received on or forwarded to the secondary Ethernet interface. Set this parameter only when VLAN separation is "1" (enabled). Value is 1-4 ASCII numeric digits from "0" to "4094." Null is not a valid value, nor can the value contain spaces. If this value is set by LLDP using the Port VLAN ID TLV value, it will not change regardless of settings from other sources. For more information, see <a href="#">Parameter Data Precedence</a> .

**Table 8: 1600 Series IP Telephone Customizable System Parameters (continued)**

Parameter Name	Default Value	Description and Value Range
PROCPSWD	" " (Null)	Text string containing the local (dialpad) procedure password (Null or 1-7 ASCII digits). If set, password must be entered immediately after Mute is pressed and before entry of a procedure command (for example, VIEW). Intended to facilitate restricted access to local procedures even when command sequences are known. Password is viewable, not hidden.
PROCSTAT	0	Local (dialpad) Administrative procedures status (0=Local procedures enabled, 1=all Administrative Options are disabled).
REREGISTER	20	Registration timer in minutes. Controls an H.323 protocol timer that should only be changed under very special circumstances by someone who fully understands the system operation impact. Value is 1-120.
RTCPMON	" " (Null)	Text string containing the 4-octet IP address of the RTCP monitor currently in use, in dotted decimal or DNS Name format (0-15 ASCII characters, no spaces).
SNMPADD	" " (Null)	Text string containing zero or more allowable source IP addresses for SNMP queries, in dotted decimal or DNS format, separated by commas, with up to 255 total ASCII characters including commas.
SNMPSTRING	" " (Null)	Text string containing the SNMP community name string (up to 32 ASCII characters, no spaces).
STATIC	0	Static programming override flag. If set to "0" static programming never overrides call server (DHCP) or call server administered data. If set to "1" static programming overrides only file server administered data. If set to "2" static programming overrides only call server administered data. If set to "3" static programming overrides both file server- and call server-administered data. Allows a call server IP address that has been manually programmed into a telephone to override any value received via DHCP or via this configuration file. A manually programmed IP address will only be used if it is not 0.0.0.0, so this parameter may be used to allow only specific telephones to use a different value than otherwise provided by this configuration file. If STATIC is to be used to select a manual override of file server IP address(es), STATIC must be set via DHCP, not via this configuration file.
SUBSCRIBELIST	" " (Null)	One or more Push application server subscription URLs, separated by commas without any intervening spaces (0-255 ASCII characters, including commas).



**Table 8: 1600 Series IP Telephone Customizable System Parameters (continued)**

Parameter Name	Default Value	Description and Value Range
TPSLIST	"" (Null)	One or more trusted domain/path strings, separated by commas without any intervening spaces (0-255 ASCII characters, including commas). A URL pushed to a telephone must contain one of these strings if it is to be used to obtain content to be rendered by the telephone.
UNNAMEDSTAT	1	Unnamed Registration Status. Specifies whether unnamed registration is initiated if the user fails to enter a value at the <code>Extension:</code> prompt or Login screen. Unnamed registration provides the telephone with a TTI-level service, enabling a user, for example, to dial emergency services like 911. Value 1=Yes, 0=No.
VLANSEP	1	VLAN separation. Controls whether frames to/from the secondary Ethernet interface receive IEEE 802.1Q tagging treatment. The tagging treatment enables frames to be forwarded based on their tags in a manner separate from telephone frames. If tags are not changed, no tag-based forwarding is employed. Values are: 1=On/Enabled, 0= Off/Disabled. This parameter is used with several related parameters. For more information, see <a href="#">VLAN Separation</a> on page 75.
VLANTEST	60	Number of seconds to wait for a DHCP OFFER when using a non-zero VLAN ID (1-3 ASCII digits, from "0" to "999").

**6 of 6****Note:**

[Table 8](#) applies to all 1600 Series IP Telephones. Certain 1600 IP Telephones might have additional, optional information that you can administer. For more information, see [Chapter 8: Administering Applications and Options](#).

---

## VLAN Considerations

If your LAN environment does not include Virtual LANs (VLANs), ignore this section. Otherwise, this section contains information on how to administer 1600 Series IP Telephones to minimize registration time and maximize performance in a VLAN environment.

---

### VLAN Tagging

IEEE 802.1Q tagging (VLAN) is a useful method of managing VoIP traffic in your LAN. Avaya recommends that you establish a *voice* LAN, set L2QVLAN to that VLAN, and provide voice traffic with priority over other traffic. If LLDP was used to set the telephones' VLAN, that setting

has absolute authority. Otherwise, you can set VLAN tagging manually, by DHCP, or in the 46xxsettings.txt file.

If VLAN tagging is enabled (L2Q=0 or 1), the 1600 Series IP Telephones set the VLAN ID to L2QVLAN, and VLAN priority for packets from the telephone to L2QAUD for audio packets and L2QSIG for signalling packets. The default value (6) for these parameters is the recommended value for voice traffic in IEEE 802.1D.

Regardless of the tagging setting, a 1600 Series IP Telephone will always transmit packets from the telephone at absolute priority over packets from secondary Ethernet. The priority settings are useful only if the downstream equipment is administered to give the *voice LAN* priority.

---

## VLAN Default Value and Priority Tagging

The system value **L2QVLAN** is initially set to “0” and identifies the 802.1Q VLAN Identifier. This default value indicates “priority tagging” as defined in IEEE 802.1Q Section 9.3.2.3. Priority tagging specifies that your network closet Ethernet switch automatically insert the switch port default VLAN without changing the user priority of the frame (cf. IEEE 802.1P and 802.1Q).

If you do not want the default VLAN to be used for voice traffic:

- Ensure that the switch configuration lets frames tagged by the 1600 Series IP Telephone through without overwriting or removing them.
- Set the system value **L2QVLAN** to the **VLAN ID** appropriate for your voice LAN.

Another system value you can administer is **VLANTEST**. VLANTEST defines the number of seconds the 1600 IP Series Telephone waits for a DHCP OFFER message when using a non-zero VLAN ID. The VLANTEST default is “60” seconds. Using VLANTEST ensures that the telephone returns to the default VLAN if an invalid VLAN ID is administered or if the phone moves to a port where the L2QVLAN value is invalid. The default value is long, allowing for the scenario that a major power interruption is causing the phones to restart. Always allow time for network routers, the DHCP servers, etc. to be returned to service. If the telephone restarts for any reason and the VLANTEST time limit expires, the telephone assumes the administered VLAN ID is invalid. The telephone then initiates registration with the default VLAN ID.

Setting **VLANTEST** to “0” has the special meaning of telling the phone to use a non-zero VLAN indefinitely to attempt DHCP. In other words, the telephone does not return to the default VLAN.

### Note:

If the telephone returns to the default VLAN but must be put back on the L2QVLAN VLAN ID, you must Reset the telephone. See the Reset procedure in the *Avaya 1600 Series IP Deskphones Installation and Maintenance Guide*.

## VLAN Separation

VLAN separation controls whether or not traffic received on the secondary Ethernet interface can be forwarded on the voice VLAN. VLAN separation also controls whether network traffic received on the data VLAN can be forwarded to the telephone. The following system parameters control VLAN separation:

- **VLANSEP** - enables (1) or disables (0) VLAN separation. The default is 1 (on), which allows full separation. When set to 0 (off), VLAN IDs are not used as a criteria for forwarding frames.
- **L2Q** - 802.1Q tagging must be set to 1 (on) or 0 (auto).
- **L2QVLAN** - must be set to the non-zero VLAN ID of the voice VLAN.
- **PHY2VLAN** - must be set to the non-zero VLAN ID of the data VLAN, which cannot be the same as the voice VLAN ID.
- **PHY2PRIO** - the layer 2 priority value to be used for tagged frames received on the secondary Ethernet interface.

[Table 9](#) provides several VLAN separation guidelines.

**Table 9: VLAN Separation Rules**

If		Then
VLANSEP is "0" (Off/Disabled),	<b>OR</b> the telephone is not tagging frames,  <b>OR</b> the telephone is tagging frames with a VLAN ID equal to PHY2VLAN.	Frames received on the secondary Ethernet interface will not be changed before forwarding. For example, tagging is not added or removed and the VLAN ID and tagged frames priority are not changed. The Ethernet switch forwarding logic determines that frames received on the Ethernet line interface are forwarded to the secondary Ethernet interface or to the telephone without regard to specific VLAN IDs or the existence of tags.
VLANSEP is "1" (On/Enabled)		All tagged frames received on the secondary Ethernet interface are changed before forwarding to make the VLAN ID equal to the PHY2VLAN value and the priority value equal to the PHY2PRIO value.  Untagged frames received on the secondary Ethernet interface are not changed before forwarding.

1 of 2

**Table 9: VLAN Separation Rules (continued)**

If		Then
VLANSEP is “1” (On/Enabled)	<p><b>AND</b> the telephone is not tagging frames,</p> <p><b>OR</b> if the telephone is tagging frames with a VLAN ID equal to PHY2VLAN,</p> <p><b>OR</b> if the PHY2VLAN value is zero.</p>	<p>The Ethernet switch forwarding logic determines that frames received on the Ethernet line interface are forwarded to the secondary Ethernet interface or to the telephone without regard to specific VLAN IDs or the existence of tags.</p>
VLANSEP is “1” (On/Enabled)	<p><b>AND</b> the telephone is tagging frames with a VLAN ID not equal to PHY2VLAN,</p> <p><b>AND</b> the PHY2VLAN value is not zero.</p>	<p>Tagged frames received on the Ethernet line interface will only be forwarded to the secondary Ethernet interface if the VLAN ID equals PHY2VLAN.</p> <p>Tagged frames received on the Ethernet line interface will only be forwarded to the telephone if the VLAN ID equals the VLAN ID used by the telephone.</p> <p>Untagged frames will continue to be forwarded or not forwarded as determined by the Ethernet switch forwarding logic.</p>

## DNS Addressing

The 1600 IP Telephones support DNS addresses and dotted decimal addresses. The telephone attempts to resolve a non-ASCII-encoded dotted decimal IP address by checking the contents of DHCP Option 6. See [DHCP Generic Setup](#) on page 44 for information. At least one address in Option 6 must be a valid, non-zero, dotted decimal address, otherwise, DNS fails. The text string for the **DOMAIN** system parameter (Option 15, [Table 8](#)) is appended to the address(es) in Option 6 before the telephone attempts DNS address resolution. If Option 6 contains a list of DNS addresses, those addresses are queried in the order given if no response is received from previous addresses on the list. As an alternative to administering DNS by DHCP, you can specify the DNS server and/or Domain name in the HTTP script file. But first **SET** the **DNSSRVR** and **DOMAIN** values so you can use those names later in the script.

**Note:**

Administer Options 6 and 15 appropriately with DNS servers and Domain names respectively.

---

## IEEE 802.1X

Certain 1600 Series IP Telephones support the IEEE 802.1X standard for pass-through and Supplicant operation. The system parameter [DOT1X](#) determines how the telephones handle 802.1X multicast packets and proxy logoff, as follows:

- When DOT1X = 0, the telephone forwards 802.1X multicast packets from the Authenticator to the PC attached to the telephone and forwards multicast packets from the attached PC to the Authenticator (multicast pass-through). Proxy Logoff is not supported.
- When DOT1X = 1, the telephone supports the same multicast pass-through as when DOT1X=0. Proxy Logoff is supported.
- When DOT1X = 2, the telephone forwards multicast packets from the Authenticator only to the telephone, ignoring multicast packets from the attached PC (no multicast pass-through). Proxy Logoff is not supported.
- Regardless of the DOT1X setting, the telephone always properly directs unicast packets from the Authenticator to the telephone or its attached PC, as dictated by the MAC address in the packet.

All 1600 Series telephones support Supplicant operation and parameter values as specified in IEEE 802.1X, but, as of software Release 1.3, only if the value of the parameter DOT1XSTAT is "1" or "2". If DOT1XSTAT has any other value, Supplicant operation is not supported.

IP telephones will respond to unicast EAPOL frames (frames with the telephone's MAC address as the destination MAC address, and a protocol type of 88-8E hex) received on the Ethernet line interface if the value of DOT1XSTAT is "1" or "2", but will only respond to EAPOL frames that have the PAE group multicast address as the destination MAC address if the value of DOT1XSTAT is "2". If the value of DOT1XSTAT is changed to "0" from any other value after the Supplicant has been authenticated, an EAPOL-Logoff will be transmitted before the Supplicant is disabled.

As of software Release 1.3, the system parameter DOT1XSTAT determines how the telephone handles Supplicants as follows:

- When DOT1XSTAT=0, Supplicant operation is completely disabled. This is the default value.
- When DOT1XSTAT=1, Supplicant operation is enabled, but responds only to received unicast EAPOL messages.
- When DOT1XSTAT=2, Supplicant operation is enabled and responds to received unicast and multicast EAPOL messages.

### Note:

If the Ethernet line interface link fails, the 802.1X Supplicant, if enabled, enters the Disconnected state. The 802.1X Supplicant variable userLogoff normally has a value of FALSE. This variable will be set to TRUE before the telephone drops the link on the Ethernet line interface (and back to FALSE after the link has been restored). The userLogoff variable may also be briefly set to TRUE to force the Supplicant into the LOGOFF state when new credentials are entered.

---

## 802.1X Pass-Through and Proxy Logoff

1600 Series IP Telephones with a secondary Ethernet interface support pass-through of 802.1X packets to and from an attached PC. This enables an attached PC running 802.1X supplicant software to be authenticated by an Ethernet data switch.

The IP Telephones support two pass-through modes:

- pass-through and
- pass-through with proxy logoff.

The DOT1X parameter setting controls the pass-through mode. In Proxy Logoff mode (DOT1X=1), when the secondary Ethernet interface loses link integrity, the telephone sends an 802.1X EAPOL-Logoff message to the data switch on behalf of the attached PC. The message alerts the switch that the device is no longer present. For example, a message would be sent when the attached PC is physically disconnected from the IP telephone. When DOT1X = 0 or 2, the Proxy Logoff function is not supported

---

## 802.1X Supplicant Operation

1600 IP Telephones that support Supplicant operation also support Extensible Authentication Protocol (EAP), but only with the MD5-Challenge authentication method as specified in IETF RFC 3748 [8.5-33a].

A Supplicant identity (ID) and password of no more than 12 numeric characters are stored in reprogrammable non-volatile memory. The ID and password are not overwritten by telephone software downloads. The default ID is the MAC address of the telephone, converted to ASCII format without colon separators, and the default password is null. Both the ID and password are set to defaults at manufacture. EAP-Response/Identity frames use the ID in the Type-Data field. EAP-Response/MD5-Challenge frames use the password to compute the digest for the Value field, leaving the Name field blank.

When a telephone is installed for the first time and 802.1x is in effect, the dynamic address process prompts the installer to enter the Supplicant identity and password. The IP telephone does not accept null value passwords. See "Dynamic Addressing Process" in the *Avaya 1600 Series IP Deskphones Installation and Maintenance Guide*. The IP telephone stores 802.1X credentials when successful authentication is achieved. Post-installation authentication

attempts occur using the stored 802.1X credentials, without prompting the user for ID and password entry.

An IP telephone can support several different 802.1X authentication scenarios, depending on the capabilities of the Ethernet data switch to which it is connected. Some switches may authenticate only a single device per switch port. This is known as single-supplicant or port-based operation. These switches typically send multicast 802.1X packets to authenticating devices.

These switches support the following three scenarios:

- **Standalone telephone (Telephone Only Authenticates)** - When the IP telephone is configured for Supplicant Mode (DOT1XSTAT=2), the telephone can support authentication from the switch.
- **Telephone with attached PC (Telephone Only Authenticates)** - When the IP telephone is configured for Supplicant Mode (DOT1X=2 and DOT1XSTAT=2), the telephone can support authentication from the switch. The attached PC in this scenario gains access to the network without being authenticated.
- **Telephone with attached PC (PC Only Authenticates)** - When the IP telephone is configured for Pass-Through Mode or Pass-Through Mode with Logoff (DOT1X=0 or 1 and DOT1XSTAT=0), an attached PC running 802.1X supplicant software can be authenticated by the data switch. The telephone in this scenario gains access to the network without being authenticated.

Some switches support authentication of multiple devices connected through a single switch port. This is known as multi-supplicant or MAC-based operation. These switches typically send unicast 802.1X packets to authenticating devices. These switches support the following two scenarios:

- **Standalone telephone (Telephone Only Authenticates)** - When the IP telephone is configured for Supplicant Mode (DOT1XSTAT=2), the telephone can support authentication from the switch. When DOT1X is "0" or "1", the telephone is unable to authenticate with the switch.
- **Telephone and PC Dual Authentication** - Both the IP telephone and the connected PC can support 802.1X authentication from the switch. The IP telephone may be configured for Pass-Through Mode or Pass-Through Mode with Logoff (DOT1X=0 or 1 and DOT1XSTAT=1 or 2). The attached PC must be running 802.1X supplicant software.

---

## Link Layer Discovery Protocol (LLDP)

Release 1.1 1600 Series IP Telephones support IEEE 802.1AB. Link Layer Discovery Protocol (LLDP) is an open standards layer 2 protocol IP Telephones use to advertise their identity and capabilities and to receive administration from an LLDP server. LAN equipment can use LLDP to manage power, administer VLANs, and provide some administration.

The transmission and reception of LLDP is specified in IEEE 802.1AB-2005. The 1600 Series IP Telephones use Type-Length-Value (TLV) elements specified in IEEE 802.1AB-2005, TIA

## Administering Telephone Options

TR-41 Committee - Media Endpoint Discovery (LLDP-MED, ANSI/TIA-1057), and Proprietary elements. LLDP Data Units (LLDPDUs) are sent to the LLDP Multicast MAC address (01:80:c2:00:00:0e).

These telephones:

- do not support LLDP on the secondary Ethernet interface.
- will not forward frames received with the 802.1AB LLDP group multicast address as the destination MAC address between the Ethernet line interface and the secondary Ethernet interface.

A 1600 Series IP Telephone initiates LLDP after receiving an LLDPDU message from an appropriate system. Once initiated, the telephones send an LLDPDU every 30 seconds with the following contents:

**Table 10: LLDPDU Transmitted by the 1600 Series IP Telephones**

Category	TLV Name (Type)	TLV Info String (Value)
Basic Mandatory	Chassis ID	IPv4 IP Address of telephone.
Basic Mandatory	Port ID	MAC address of the telephone.
Basic Mandatory	Time-To-Live	120 seconds.
Basic Optional	System Name	The Host Name sent to the DHCP server in DHCP option 12.
Basic Optional	System Capabilities	Bit 2 (Bridge) will be set in the System Capabilities if the telephone has an internal Ethernet switch. If Bit 2 is set in Enabled Capabilities then the secondary port is enabled.  Bit 5 (Telephone) will be set in the System Capabilities. If Bit 5 is set in the Enabled Capabilities then the telephone is registered.
Basic Optional	Management Address	Mgmt IPv4 IP Address of telephone.  Interface number subtype = 3 (system port). Interface number = 1.  OID = SNMP MIB-II sysObjectID of the telephone.
IEEE 802.3 Organization Specific	MAC / PHY Configuration / Status	Reports autonegotiation status and speed of the uplink port on the telephone.
TIA LLDP MED	LLDP-MED Capabilities	Media Endpoint Discovery - Class III - IP Telephone.

**1 of 3**



Table 10: LLDPDU Transmitted by the 1600 Series IP Telephones (continued)

Category	TLV Name (Type)	TLV Info String (Value)
TIA LLDP MED	Extended Power-Via-MDI	Power Value = 0 if the telephone is not currently powered via PoE, else the maximum power usage of the telephone plus all modules and adjuncts powered by the telephone in tenths of a watt.
TIA LLDP MED	Network Policy	Tagging Yes/No, VLAN ID for voice, L2 Priority, DSCP Value.
TIA LLDP MED	Inventory – Hardware Revision	MODEL - Full Model Name.
TIA LLDP MED	Inventory – Firmware Revision	BOOTNAME.
TIA LLDP MED	Inventory – Software Revision	APPNAME.
TIA LLDP MED	Inventory – Serial Number	Telephone serial number.
TIA LLDP MED	Inventory – Manufacturer Name	Avaya.
TIA LLDP MED	Inventory – Model Name	MODEL with the final Dxxx characters removed.
Avaya Proprietary	PoE Conservation Level Support	Provides Power Conservation abilities/settings, Typical and Maximum Power values.  OUI = 00-40-0D (hex), Subtype = 1.
Avaya Proprietary	Call Server IP Address	Call Server IP Address.  Subtype = 3.
Avaya Proprietary	IP Phone Addresses	Phone IP Address, Phone Address Mask, Gateway IP Address.  Subtype = 4.
Avaya Proprietary	CNA Server IP Address	CNA Server IP Address = in-use value from CNASRVR.  Subtype = 5.
Avaya Proprietary	File Server	File Server IP Address.  Subtype = 6.

2 of 3

**Table 10: LLDPDU Transmitted by the 1600 Series IP Telephones (continued)**

Category	TLV Name (Type)	TLV Info String (Value)
Avaya Proprietary	802.1Q Framing	802.1Q Framing = 1 if tagging or 2 if not.  Subtype = 7.
Basic Mandatory	End-of-LLDPDU	Not applicable.

**3 of 3**

On receipt of a LLDPDU message, the Avaya IP Telephones will act on the TLV elements described in [Table 11](#):

**Table 11: Impact of TLVs Received by 1600 Series IP Telephones on System Parameter Values**

System Parameter Name	TLV Name	Impact
PHY2VLAN	IEEE 802.1 Port VLAN ID	System value changed to the Port VLAN identifier in the TLV.
L2QVLAN and L2Q	IEEE 802.1 VLAN Name	<p>The system value is changed to the TLV VLAN Identifier. L2Q will be set to 1 (ON).</p> <p>VLAN Name TLV is only effective if:</p> <ul style="list-style-type: none"> <li>● The telephone is not registered with the Call Server.</li> <li>● Name begins with VOICE (case does not matter).</li> <li>● The VLAN is not zero.</li> <li>● DHCP Client is activated.</li> <li>● The telephone is registered but is not tagging layer 2 frames with a non-zero VLAN ID.</li> </ul> <p>If VLAN Name causes the telephone to change VLAN and the telephone already has an IP Address the telephone will release the IP Address and reset.</p> <p>If the TLV VLAN ID matches the VLAN ID the telephone is using, the VLAN ID is marked as set by LLDP. Otherwise, if already registered, the telephone waits until there are no active calls, releases its IP Address, turns on tagging with the TLV VLAN ID, sets L2Q to "on," changes the default L2Q to "on," and resets. If there is no valid IP Address, the telephone immediately starts tagging with the new VLAN ID without resetting.</p>

**Table 11: Impact of TLVs Received by 1600 Series IP Telephones on System Parameter Values (continued)**

System Parameter Name	TLV Name	Impact
L2Q, L2QVLAN, L2QAUD, L2QSIG, DSCPAUD, DSCPSIG	MED Network Policy TLV	<p>L2Q - set to "2" (off) if T (the Tagged Flag) is set to 0; set to "1" (on) if T is set to 1.</p> <p>L2QVLAN - set to the VLAN ID in the TLV.</p> <p>L2QAUD and L2QSIG - set to the Layer 2 Priority value in the TLV.</p> <p>DSCPAUD and DSCPSIG - set to the DSCP value in the TLV.</p> <p>A check is made as to whether a reset is necessary to obtain a new IP address due to a change in the values of the parameters L2Q or L2QVLAN.</p> <p>This TLV is ignored if:</p> <ul style="list-style-type: none"> <li>the value of USE_DHCP is "0" and the value of IPADD is not "0.0.0.0", or</li> <li>the Application Type is not 1 (Voice) and is not 2 (Voice Signaling), or</li> <li>the Unknown Policy Flag (U) is set to 1.</li> </ul>
MCIPADD	Proprietary Call Server TLV	MCIPADD will be set to this value if it has not already been set.
TLSSRVR and HTTPSRVR	Proprietary File Server TLV	TLSSRVR and HTTPSRVR will be set to this value if neither of them have already been set.
L2Q	Proprietary 802.1 Q Framing	The default L2Q is set to the value of this TLV. No change is made to the current L2 tagging, but the new default value is used on the next reboot. If TLV = 1, L2Q set to "1" (On). If TLV = 2, L2Q set to "2" (Off). If TLV = 3, L2Q set to "0" (Auto).
	Proprietary - PoE Conservation TLV	This proprietary TLV can initiate a power conservation mode. The telephones that support this will turn on/off the telephone backlight and the backlight of an attached Button Module in response to this TLV.
	Extended Power-Via-MDI	Power conservation mode will be enabled if the received binary Power Source value is 10, and power conservation mode will be disabled if the received binary Power Source value is not 10. Power conservation mode is enabled even if the telephone is not powered over Ethernet because the telephone sends information about the power source that it is using in a TIA LLDP MED Extended Power-Via-MDI TLV; it is assumed that the power management system intends to conserve local power as well.

---

## Local Administrative Options Using the Telephone Dialpad

The local procedures you use most often as an administrator are:

- **CLEAR** - Remove all administered values, user-specified data, option settings, etc. and return a telephone to its initial “out of the box” default values.
- **DEBUG** - Enable or disable debug mode for the button module serial port.
- **GROUP** - Set the group identifier on a per-phone basis.
- **RESET** - Reset all system values and system initialization values except AUTH, NVAUTH, registration extension, and password to the default values. Also resets the 802.1X identity and password to the default values.
- **VIEW** - Review the 1600 IP Telephone system parameters to verify current values and file versions.
- **Ethernet (Hub) Interface Enable/Disable** - Enable or disable the Ethernet hub locally.

---

### Clear Procedure

Sometimes, you might want to remove *all* administered values, user-specified data, and option settings. Essentially, you want to return a telephone to its initial “clean slate” or out of the box condition. This is usually done when passing a telephone to a new, dedicated user when the user’s **LOG OFF** option is not sufficient. For example, a new user is assigned the same extension, but requires different permissions than the previous user.

The **CLEAR** option erases all administered data—static programming, file server and call server programming, and user settings including Contact button labels and locally programmed Feature button labels, and restores all such data to default values. The **CLEAR** option does not affect the software load itself. If you have upgraded the telephone, the telephone retains the latest software. Once you have cleared a telephone, you can administer it normally.



**CAUTION:**

This procedure erases all administered data, without any possibility of recovering the data.

Use the following procedure to clear the telephone of its administrative, user-assigned and options values.

1. While the telephone is on-hook and idle, press the following sequence of keys on the faceplate of the telephone:

**Mute 2 5 3 2 7 # (Mute CLEAR #)**

**Note:**

Press the **Mute** button momentarily. Do not press this button while pressing other keys/buttons.

The following text displays left-justified at the top of the display:

```
Clear all values?  
*=no      #=yes
```

2. If you do not want to clear all values, press \* (no) to terminate the procedure and retain the current values.

A screen displays the following prompt on the top line:

```
Are you sure?  
*=no      #=yes
```

3. Press the \* button to terminate the procedure without clearing the values. Press the # button to clear all values to their initial default values.

A confirmation tone sounds and the following text displays left-justified at the top of the display:

```
Clearing values.
```

The telephone is cleared to its “out of the box” state.

---

## Disable/Enable Debug Mode

Use the following procedure to turn the debug mode for the button module serial port on or off.

1. While the telephone is on-hook and idle, press the following sequence of keys on the faceplate of the telephone:

**Mute 3 3 2 8 4 # (Mute D E B U G #)**

**Note:**

Press the **Mute** button momentarily. Do not press this button while pressing other keys/buttons.

## Administering Telephone Options

2. After entry of the command sequence, the following displays, based on the current value of the system value NVDEBUG:

If NVDEBUG = 1:

```
Debug mode=on
0=off #=OK
```

If NVDEBUG = 0:

```
Debug mode=off
1=on #=OK
```

If a value different from the current NVDEBUG value is entered, the following text displays left-justified at the top of the display:

```
Save new value?
*=no    #=yes
```

3. Press the \* button to terminate the procedure, or the # button to save the new value. If you press the # button, the telephone displays the following text:

```
New value being saved
```

The telephone saves the new value.

---

## Group Identifier

Use the following procedure to set or change the Group Identifier.

**Note:**

Perform this procedure only if the LAN Administrator instructs you to do so.  
For more information about groups, see [The GROUP System Value](#) on page 65.

While the telephone is on-hook and idle, press the following sequence of keys on the faceplate of the telephone:

**Mute 4 7 6 8 7 (Mute G R O U P)**

**Note:**

Press the **Mute** button momentarily. Do not press this button while pressing other keys/buttons.

The following text displays left-justified at the top of the display:

```
Group=ddd
New=_
```

where **ddd** is the Group value.

1. Enter a valid **Group** value (0-999).

If a value different from the current Group value is entered, the following text displays left-justified at the top of the display:

```
Save new value?  
*=no    #=yes
```

2. Press the \* button to terminate the procedure, or the # button to save the new value.

If you press the # button, the following text displays:

```
New value  
being saved
```

The new value is saved and the user interface is restored to its previous state.

---

## Reset System Values

Use the following procedure to reset all system values and system initialization values except AUTH, NVAUTH, registration extension, and password to the default values. Also resets the 802.1X identity and password to the default values.

 **CAUTION:**

This procedure erases all static information except the extension number and password, without any possibility of recovering the data.

1. While the telephone is on-hook and idle, press the following sequence of keys on the faceplate of the telephone:

**Mute 7 3 7 3 8 # (Mute R E S E T #)**

**Note:**

Press the **Mute** button momentarily. Do not press this button while pressing other keys/buttons.

The IP telephones display the following text left-justified at the top of the display:

```
Reset values?  
*=no    #=yes
```

 **CAUTION:**

As soon as you press the # button, all static information except the extension number and password will be erased, without any possibility of recovering the data.

## Administering Telephone Options

2. If you do not want to reset the system values, press \* (no) and proceed to Step 4.

The following prompt displays on the top line:

```
Are you sure?  
*=no    #=yes
```

3. Press the \* button to continue without resetting the values and proceed to Step 4. Or, press the # button to reset values to their defaults.

All telephones display the following text left-justified at the top of the display while the system values are reset to defaults:

```
Resetting  
values.
```

The telephone resets from the beginning of registration, which takes a few minutes.

4. If you do not reset the telephone, the telephone displays the following prompt:

```
Restart phone?  
*=no    #=yes
```

5. Press the \* key to terminate the procedure without restarting the telephone. Otherwise, press # and perform the following Restart procedure.

---

## Restart the Telephone

Use the following procedure to restart the telephone.

1. While the telephone is on-hook and idle, press the following sequence of keys on the faceplate of the telephone:

**Mute 7 3 7 3 8 # (Mute R E S E T #)**

**Note:**

Press the **Mute** button momentarily. Do not press this button while pressing other keys/buttons.

The IP telephones display the following text left-justified at the top of the display:

```
Reset values?  
*=no    #=yes
```



- Press the **#** button to reset values to their defaults, or **\*** to continue a restart without resetting the values to their defaults.

The telephones display the following text left-justified at the top of the display while the system values are reset to defaults:

```
Resetting
values.
```

Once the system values are reset, the following prompt displays on all IP telephones:

```
Restart phone?
*=no    #=yes
```

- Press the **\*** key to terminate the procedure without restarting the telephone.

Press the **#** key to restart the telephone.

The remainder of the procedure depends on the status of the boot and application files.

## Interface Control

Use the following procedure to set or change the interface control value.

- While the telephone is on-hook and idle, press the following sequence of keys on the faceplate of the telephone:

**Mute 4 6 8 # (Mute I N T #)**

**Note:**

Press the **Mute** button momentarily. Do not press this button while pressing other keys/buttons.

- After entry of the command sequence, telephones with an internal Ethernet switch display the following text, depending on the current interface control value:

```
PHY1=status
*=change #=OK
```

where ***status*** is the value of PHY1STAT, defined as:

- Status is **auto** when PHY1STAT = 1
- Status is **10Mbps HDX** when PHY1STAT = 2
- Status is **10Mbps FDX** when PHY1STAT = 3
- Status is **100Mbps HDX** when PHY1STAT = 4

## Administering Telephone Options

- Status is **100Mbps FDX** when PHY1STAT = 5

3. To change the PHY1 value, press \*.

Depending on the current value, the next sequential valid PHY1 value is selected and displayed as the status. For example, if the current value is 10Mbps HDX (2), pressing \* changes the value to 3 (10Mbps FDX).

4. Press the \* button to terminate the procedure, or the # button to save the new value. If you press the # button, the following text displays:

PHY2=**status**  
\*=change #=OK

where **status** is the value of PHY2STAT, defined as:

- Status is **disabled** when PHY2STAT = 0
- Status is **auto** when PHY2STAT = 1
- Status is **10Mbps HDX** when PHY2STAT = 2
- Status is **10Mbps FDX** when PHY2STAT = 3

- Status is **100Mbps HDX** when PHY2STAT = 4
  - Status is **100Mbps FDX** when PHY2STAT = 5
5. To change the PHY2 value, press \*.

Depending on the current value, the next sequential valid PHY2 value is selected and displayed as the status. For example, if the current value is 10Mbps HDX (2), pressing \* changes the value to 3 (10Mbps FDX).

The following text displays left-justified at the top of the display:

```
Save new value?
*=no      #=yes
```

6. Press the \* button to terminate the procedure, or the # button to save the new values. If you press the # button, the following text displays.

```
New value
being saved
```

The new values are saved and a restart occurs automatically. The user interface is restored to its previous state.

---

## The View Administrative Option

If you are using static addressing and encounter problems, use the following procedure to verify the current values of system parameters and file versions.

### Note:

Unless otherwise prevented using administration, the user can view but not change most of the parameters associated with Local Administrative Procedures. For more information about this option, see the applicable user guide(s).

### Note:

If the View Network Information option is not available due to being disabled by administration, use the **ADDR** option to view IP addresses. See [Static Addressing Installation](#) on page 94. The IP addresses might have been entered incorrectly. Verify whether you were provided with correct IP addresses.

## Administering Telephone Options

1. While the telephone is on-hook and idle, press the following sequence of keys on the faceplate of the telephone:

**Mute 8 4 3 9 # (Mute V I E W #)**

**Note:**

Press the **Mute** button momentarily. Do not press this key while pressing other keys.

The following text displays left-justified at the top of the display:

```
View settings
*=next   #=exit
```

2. Press the \* button at any time during viewing to display the next name and system value pair or filename from [Table 12](#). The first pair returns after the last pair displays. Values that cannot display on one line wrap to the next line.

Press the # button at any time during viewing to terminate the procedure and restore the user interface to its previous state. The names and values display in the following order:

**Table 12: Parameter Values**

Name	System Value	Format
Model	<b>16ccDccc</b>	Up to 8 ASCII characters: MODEL value.
Phone SN	<b>cccccccccccccccccc</b>	Telephone Serial Number, up to 18 ASCII characters.
PWB SN	<b>cccccccccccccccccc</b>	Printed Wiring Board (circuit board) Serial Number, up to 18 ASCII characters. Applies only to 16xx IP Telephones that have a software-readable PWB serial number and comcode.
PWB comcode	<b>nnnnnnnnn</b>	9 ASCII numeric characters. Applies only to 16xx IP Telephones that have a software-readable PWB serial number and comcode.
MAC address	<b>hh:hh:hh:hh:hh:hh</b>	Each octet of the MAC address displays as a pair of hexadecimal numbers.

**1 of 3**

Table 12: Parameter Values (continued)

Name	System Value	Format
L2 tagging	<b>ccccccccc</b>	Up to 9 ASCII characters: “on” if NVL2Q = 1 “off” if NVL2Q = 2 “auto: on” if NVL2Q = 0 and 802.1Q tagging is on “auto: off” if NVL2Q = 0 and 802.1Q tagging is off
VLAN ID	<b>cccc</b>	Up to 4 ASCII characters. Value is L2QVLAN if 802.1Q tagging is on or “none” if 802.1Q tagging is off.
IP address	<b>nnn.nnn.nnn.nnn</b>	Up to 15 ASCII characters: IPADD value.
Subnet mask	<b>nnn.nnn.nnn.nnn</b>	Up to 15 ASCII characters: NETMASK value.
Router	<b>nnn.nnn.nnn.nnn</b>	Up to 15 ASCII characters: the IP address of the router in use.
File server	<b>nnn.nnn.nnn.nnn.nnnnn</b>	Up to 21 ASCII characters: IP address and port of last file server used successfully during initialization or “0.0.0.0” if no file server was used successfully.
Call server	<b>nnn.nnn.nnn.nnn.nnnnn</b>	Up to 21 ASCII characters: IP address and port of the call server currently in use, otherwise “0.0.0.0.”
802.1X	If DOT1X = 0 If DOT1X = 1 If DOT1X = 2	Pass-thru mode. Pass-thru with Logoff. Supplicant mode.
Group	<b>nnn</b>	Up to 3 ASCII numeric characters: GROUP value.

2 of 3

**Table 12: Parameter Values (continued)**

Name	System Value	Format
Protocol:	<b>ccccccc</b>	Up to 8 ASCII characters, currently only "H.323."
	<b>filename.ext</b>	4 to 32 ASCII characters. The name of the primary ("big app") image file currently stored in the telephone (endptAPPINUSE).
	<b>ccccccc Ethernet</b>	2 to 7 ASCII characters, either "100Mbps", "10Mbps", or "No" depending on the current speed of the Ethernet line interface.
	<b>bootcodename</b>	1 to 32 ASCII characters. The name of the backup ("little app") image file currently stored in the telephone (endptBOOTNAME).
Button Module 1	<b>cccccccccccc</b>	Up to 14 ASCII characters. The version identifier of the software in the Button Module, if applicable.
Button Module 2	<b>cccccccccccc</b>	Up to 14 ASCII characters. The version identifier of the software in the Button Module, if applicable.
Button Module 3	<b>cccccccccccc</b>	Up to 14 ASCII characters. The version identifier of the software in the Button Module, if applicable.

**3 of 3**

## Static Addressing Installation

The usual way to assign IP addresses to IP telephones is the automatic method. There might be times, however, when manual assignment of IP addresses is desired.



**CAUTION:**

Static addressing is necessary when a DHCP server is unavailable.

Because of the increased opportunities for text entry errors associated with static addressing, we very strongly recommend that a DHCP server be installed and static addressing avoided.

Use the following procedure to invoke manual address information programming.

1. Start manual address programming by performing one of the following steps:

- a. During normal DHCP processing, press the \* key while “\* to program” displays during the DHCP process.

or

- b. While the telephone is on-hook and idle, press the following sequence of keys on the faceplate of the telephone:

**Mute 2 3 3 7 # (Mute A D D R #)**

**Note:**

Press the **Mute** button momentarily. Do not press this button while pressing other keys/buttons.

The telephone displays:

<b>Phone=nnn.nnn.nnn.nnn</b> <b>New=_</b>
--

where *nnn.nnn.nnn.nnn* is the current IP address system value of the telephone.

2. Enter the **telephone's IP address** followed by the # button.

The telephone displays:

<b>CallSv=nnn.nnn.nnn.nnn</b> <b>New=_</b>
---

where *nnn.nnn.nnn.nnn* is the current system value of the media server/gatekeeper IP address.

3. Enter the **Gatekeeper IP address** followed by the # button.

The telephone displays:

<b>Router=nnn.nnn.nnn.nnn</b> <b>New=_</b>
---

where *nnn.nnn.nnn.nnn* is the current system value of the gateway/router IP address.

4. Enter the **Gateway router IP address** followed by the # button.

The telephone displays:

<b>Mask=nnn.nnn.nnn.nnn</b> <b>New=_</b>
---

where *nnn.nnn.nnn.nnn* is the current system value of the IP netmask.

## Administering Telephone Options

5. Enter the **IP netmask** followed by the **#** button.

The telephone displays:

```
FileSv=nnn.nnn.nnn.nnn
New=_
```

where **nnn.nnn.nnn.nnn** is the current system value of the HTTP/HTTPS server IP address.

6. Enter the **File server** followed by the **#** button.

The telephone displays one of the following texts, depending on the current setting of the system parameter NVL2Q (802.1Q):

If NVL2Q is 0:

```
802.1Q=auto
*=change #=OK
```

If NVL2Q is 1:

```
802.1Q=on
*=change #=OK
```

If NVL2Q is 2:

```
802.1Q=off
*=change #=OK
```

7. Press **\*** to change **802.1Q** to the next sequential value. For example, if the current value is 0 (auto) pressing **\*** changes it to 1 (on) and if the current value is 2 (off), pressing **\*** changes it to 0 (auto).

The display is updated to show the current status of 802.1Q.

8. Press the **#** button to continue the procedure without changing the displayed status of 802.1Q

The telephone displays the following text:

```
VLAN ID=dddd
New=_
```

where **dddd** is the current system value of the 802.1 VLAN ID.

9. Enter a valid value between 0 and 4094 for the new value of the 802.1 **VLAN ID**.

The telephone displays the following message:

```
VLAN test=ddd
New=_
```

where **ddd** is the number of seconds to wait for a **DHCPOFFER** on a non-zero VLAN.



10. Enter a valid value between 0 and 999 for the new value of the **DHCPOFFER** wait period.

The telephone displays:

```
Save new values?
*=no #=yes
```

11. Press the **#** button to save the new values you entered.

The telephone displays:

```
New values
being saved
```

Once the new values are stored, the telephone is reset.

If a new boot program is downloaded from the HTTP server after you enter static addressing information, you must reenter your static addressing information.

---

## Disable/Enable Event Logging

Use the following procedure to enable or disable logging of system events.

1. While the telephone is on-hook and idle, press the following sequence of keys on the faceplate of the telephone:

**Mute 5 6 4 # (Mute L O G #)**

**Note:**

Press the **Mute** button momentarily. Do not press this button while pressing other keys/buttons.

2. After entry of the command sequence, the telephone displays the following text, depending on the current value of the system parameter NVLOGSTAT:

```
Log=status
*=change #=OK
```

where ***status*** is the type of logging indicated by the NVLOGSTAT value, defined as:

- Status is **disabled** when NVLOGSTAT = 0
- Status is **emergencies** when NVLOGSTAT = 1
- Status is **alerts** when NVLOGSTAT = 2
- Status is **critical** when NVLOGSTAT = 3
- Status is **errors** when NVLOGSTAT = 4
- Status is **warnings** when NVLOGSTAT = 5

## Administering Telephone Options

- Status is **notices** when NVLOGSTAT = 6
  - Status is **information** when NVLOGSTAT = 7
  - Status is **debug** when NVLOGSTAT = 8
3. To change the logging status, press \*.

Depending on the current value, the next sequential valid NVLOGSTAT value is selected and displayed as the status. For example, if the current value is alerts (2), pressing \* changes the value to 3 (critical). If the current value is debug (8), pressing \* changes the value to 0 (disabled).

If a value different from the current NVLOGSTAT value is entered, the following text displays left-justified at the top of the display:

Save new value? *=no   #=yes
---------------------------------

4. Press the \* button to terminate the procedure, or the # button to save the new value. If you press the # button, the telephone displays the following text:

New value being saved
-----------------------

The telephone saves the new value.

---

## Logoff

Use the following procedure to log off a telephone.

 **CAUTION:**

Once a telephone is logged off, a password and extension might be needed to log back on.

1. While the telephone is on-hook and idle, press the following sequence of keys on the faceplate of the telephone:

**Mute 5 6 4 6 3 3 # (Mute L O G O F F #)**

**Note:**

Press the **Mute** button momentarily. Do not press this button while pressing other keys/buttons.

2. After entry of the command sequence, the telephone unregisters from the call server. The telephone display clears and then displays the following prompt for subsequent login:

Enter Extension
-----------------

EXT= #=OK
-----------

---

## Self-Test Procedure

**Note:**

Replace variable w/ short product names store two software code images in reprogrammable non-volatile memory. The primary image, called the “big app” must be running to perform a self-test. The backup image, called the “little app” does not support the self-test.

For self-testing, use the following procedure:

1. To invoke Replace variable w/ short product name self-test procedures, press the following sequence of keys on the faceplate of the telephone:

**Mute 8 3 7 8 # (Mute T E S T #)**

**Note:**

Press the **Mute** button momentarily. Do not press this button while pressing other keys/buttons.

All telephones show the following text, left-justified at the top of the display, for 1 second after self-test is invoked:

```
Self test
#=end
```

A block character with all pixels on then displays in all display character locations for 5 seconds. Display of the block character helps to find bad display pixels.

The telephone displays one of the following:

If self-test passes:

```
Self test passed
#=end
```

If self-test fails:

```
Self test failed
#=end
```

2. To terminate the self-test, press the # button on the dial pad at any time. Doing so generates a confirmation tone, and returns the user interface to its previous state.

## Language Selection

1600 Series IP Telephones are factory-set to display information in the English language. The languages available depend of the type of telephone you have. The following 1600 Series IP Telephones are available:

- Global telephones
  - 1603
  - 1603SW
  - 1608
  - 1616
- International telephones
  - 1603-I
  - 1603SW-I
  - 1608-I
  - 1616-I

---

## 1600 Series Global Telephones

The 1600 Series Global Telephones consist of the following telephone models:

- 1603
- 1603SW
- 1608
- 1616

As of Release 1.0, all software downloads include language files for 9 additional languages. Administrators can specify from one to four of those languages per telephone to replace English. End users can then select which of those languages they want their telephone to display.

All downloadable language files contain:

- UTF-16 encoded Unicode characters (only)
- a file name ending in .txt
- the language name as it should be presented to the user for selection
- a translation of each available language name into all other languages
- an indication of the preferred character input method as shown in [Table 13](#)

- text string replacements for the built-in English text strings, for example, entry prompts and error messages
- an indication of the font corresponding to the language

**Table 13: Language Files Available with Software Downloads for 1600 Series Global Telephones**

Language	Character Input Method to be specified in each respective language file	Font
Dutch	Latin-1	Default
English	Latin-1	Default
French (Canadian)	French	Default
French (Parisian)	French	Default
German	German	Default
Italian	Italian	Default
Portuguese (Brazilian)	Portuguese	Default
Russian	Russian	Default
Spanish (Castilian)	Spanish	Default
Spanish (Latin American)	Spanish	Default

**Note:**

The 1600 Series Global Telephones also support half-width Katakana.

There are no dependencies between the languages available from the software download and the actual character input method. If a character input method is not supported, ASCII is used instead. Acceptable input methods are as follows:

- ASCII
- Latin-1
- German
- French
- Italian
- Spanish
- Portuguese

## Administering Telephone Options

Use the configuration file and these parameters to customize the settings for up to four languages:

- **LANGxFILE** - The name of a selected language file, for example, "French". In addition to providing the language name as this value, replace the "x" in this parameter with a "1", "2", "3", or "4" to indicate which of four languages you are specifying. For example, to indicate German and French are the available languages, the setting is:  
**LANG1FILE=mlf\_german.txt** and **LANG2FILE=mlf\_french.txt**.
- **LANG0STAT** - Allows the user to select the built-in English language when other languages are downloaded. If LANG0STAT is "0" and at least one language is downloaded, the user cannot select the built-in English language. If LANG0STAT is "1" the user can select the built-in English language text strings.
- **LANGSYS** = The file name of the system default language file, if any.

For more information, see [1600 Series IP Telephone Customizable System Parameters](#). To view multiple language strings, see the MLS local procedure in the *Avaya 1600 Series IP Deskphones Installation and Maintenance Guide*.

**Note:**

Specifying a language other than English in the configuration file has no impact on Avaya Aura Communication Manager settings, values, or text strings.

---

## 1600 Series International Telephones

The 1600 Series International Telephones consist of the following telephone models:

- 1603-I
- 1603SW-I
- 1608-I
- 1616-I

As of Release 1.1, all software downloads include language files for six additional languages. Administrators can specify one of those languages per telephone to replace English.

All downloadable language files contain:

- UTF-16 encoded Unicode characters (only)
- a file name ending in .txt. (This is the language file.)
- a file name ending in .lzma. (This is the font file.)
- the language name as it should be presented to the user for selection
- a translation of each available language name into all other languages
- an indication of the preferred character input method as shown in [Table 14](#)

- text string replacements for the built-in English text strings, for example, entry prompts and error messages
- an indication of the font corresponding to the language

**Note:**

The 1600 Series International Telephones also require a font file (\*.lзма) that must be paired with the language file. Both the language file and corresponding font file must reside on the HTTP server.

**Table 14: Language Files Available with Software Downloads for 1600 Series International Telephones**

Language	Character Input Method to be specified in each respective language file	Font
Arabic	Latin-1	Arabic/Hebrew
Chinese - Simplified	Latin-1	Simplified Chinese
Chinese - Traditional	Latin-1	Traditional Chinese
Hebrew	Latin-1	Arabic/Hebrew
Japanese Katakana	Latin-1	Default
Korean	Latin-1	Korean

**Note:**

The 1600 Series International Telephones also support half-width Katakana.

There are no dependencies between the languages available from the software download and the actual character input method. If a character input method is not supported, ASCII is used instead. Acceptable input methods are as follows:

- ASCII
- Arabic
- Chinese - Simplified
- Chinese - Traditional
- Hebrew
- Korean

Use the configuration file and these parameters to customize the settings for one language:

## Administering Telephone Options

- **FONTFILE** - The name of the selected font file for a language to be downloaded. You must specify this parameter for any language except Japanese Katakana. For example, to use Arabic, the setting is: **SET FONTFILE Arabic\_b004i.rbm.lzma.**

**Note:**

Arabic and Hebrew share one font file.

- **LANGxFILE** - The name of a selected language file. In addition to providing the language name as this value, replace the "x" in this parameter with a "1" For example, to use Arabic, the setting is: **SET LANG1FILE=mlf\_arabic\_b004i.txt.**
- **LANG0STAT** - Allows the user to select the built-in English language when other languages are downloaded. If LANG0STAT is "0" and at least one language is downloaded, the user cannot select the built-in English language. If LANG0STAT is "1" the user can select the built-in English language text strings.
- **LANGSYS** = The file name of the system default language file, if any.

For more information, see [1600 Series IP Telephone Customizable System Parameters](#). To view multiple language strings, see the MLS local procedure in the *Avaya 1600 Series IP Deskphones Installation and Maintenance Guide*.

**Note:**

Keep in mind the following information:

- Specifying a language other than English in the configuration file has no impact on Avaya Aura Communication Manager settings, values, or text strings.
- You can download only one language (with the corresponding font file and language file) at a time.
- The font files for the five languages also contain the font information for the languages supported on the 1600 Series Global Telephones.
- You can use the GROUP feature to logically separate the 1600 Series Global Telephones from the 1600 Series International Telephones in one enterprise network by specifying different language/font files in the 46xxsettings.txt file.



---

## Enhanced Local Dialing

The 1600 Series IP Telephones have a variety of telephony-related applications that might obtain a telephone number during operation. For example, the Call Log saves a number of an incoming caller. The telephones can evaluate a raw telephone number. Based on administered parameters, the telephone can automatically prepend the correct digits, saving the user time and effort. This is the Enhanced Dialing feature. The key to the success of this feature is accurate administration of several important values, summarized below.

**Note:**

In all cases, the values you administer are the values relevant to the location of the Avaya Media Server at which the IP telephones are registered. If a telephone is in Japan, but its media server is in the United States, set the **PHNCC** value to "1" for the United States.

In all cases, the digits the telephones insert and dial are subject to standard Avaya Media Server features and administration. This includes Class of Service (COS), Class of Restriction (COR), Automatic Route Selection (ARS), and so on.

As indicated in [Table 8](#), you can administer the system parameter **ENHDIALSTAT** to turn off the Enhanced Local Dialing feature.

The system values relevant to the Enhanced Dialing Feature are:

- **PHNCC** - the international country code of the media server.  
For example, "1" for the United States, "44" for the United Kingdom, and so on.
- **PHNDLENGTH** - the length of the dial plan on the media server.
- **PHNIC** - the digits the media server dials to access public network international trunks.  
For example, "011" for the United States.
- **PHNLD** - the digit dialed to access public network long distance trunks on the media server.
- **PHNLDLENGTH** - the maximum length, in digits, of the national telephone number for the country in which the Avaya Media Server is located.
- **PHNOL** - the character(s) dialed to access public network local trunks on the media server.

## Backup/Restore

The 1600 Series IP Telephones support the HTTP client to back up and restore the user-specific data indicated in [Table 16](#). For backup, the telephone creates a file with all the user-specific data if a backup file location is specified in system parameter BRURI. The file is sent to the server by an HTTP PUT message, with appropriate success or failure confirmation.

For restore, the initiating process must supply only the backup file name. The file is requested from the server by an HTTP GET message. If successful, the file is returned to the initiating process, otherwise a failure message is returned.

Backup and restore operations construct the URI used in the HTTP message from the value of the BRURI parameter and from the file name as follows:

- If BRURI ends with / (a forward slash), the file name is appended.
- Otherwise, a forward slash is appended to the BRURI value, then the file name is appended to that.

**Note:**

A directory path and/or a port number can be included in BRURI as specified in IETF RFCs 2396 and 3986.

HTTP authentication is supported for both backup and restore operations. The authentication credentials and realm are stored in re-programmable, non-volatile memory, which is not overwritten when new telephone software is downloaded. Both the authentication credentials and realm have a default value of null, set at manufacture or at any other time user-specific data is removed from the telephone.

The new value(s) replace the currently stored values when HTTP authentication for backup or restore succeeds.

If HTTP authentication fails, the user is prompted to enter new credentials.

**Note:**

Users can request a backup or restore using the Advanced Options Backup/Restore screen, as detailed in the user guide for their specific telephone model. or specific error messages relating to Backup/Restore, see the *Avaya 1600 Series IP Deskphones Installation and Maintenance Guide*.

## Backup

When the system parameter BRURI is non-null, user changes are automatically backed up to the file **ext\_16xxdata.txt** (where **ext** is the value of NVPHONEXT) on the HTTP server to a user-specified directory. Backup formats are as follows:

**Table 15: Backup File Formats**

Item/Data Value	Format
Generic	<i>name=value</i>
Contacts	ABKNAME <i>mmm</i> =ENTRY_NAME ABKNUMBER <i>mmm</i> =ENTRY_NUMBER_1 (where <i>mmm</i> is the one-, two-, or three-digit entry ID, with leading zeros for single and double-digit entry IDs)

In addition to the parameters listed in [Table 8](#), a backup saves the options and non-password parameters shown in [Table 16](#).

**Table 16: Options and Non-Password Parameters Saved During Backup**

Parameter Name	Setting
LANGUSER	Display Language
LOGACTIVE	Call Log Active
LOGBRIDGED	Log Bridged Calls
LOGLINEAPPS	Log Line Calls
LOGOTHERANS	Log Calls Answered By Others
OPTAGCHAND	Handset Automatic Gain Control
OPTAGCHEAD	Headset Automatic Gain Control
OPTAGCSPKR	Speaker Automatic Gain Control
OPTAUDIOPATH	Audio Path
OPTCLICKS	Button Clicks
OPTERRORTONE	Error Tone
PERSONALRING	Personalized Ring
PHNRDIAL	Redial
PHNSCRONCALL	Go to Phone Screen on Calling
PHNSCRONALERT	Go to Phone Screen on Ringing
PHNTIMERS	Call Timer
PHNVISUALALERT	Visual Alerting

---

## Restore

When automatic or user-requested retrieval of backup data is initiated, system values and internal values are set to values contained in the backup file. This occurs only if the OPSTAT parameter setting allows the user to change those values. Therefore, any restrictions set using OPSTAT are recognized and honored.

The backup file value is not retrieved, and the current setting remains valid:

- when a value in the backup file has changed and
- that value corresponds to an application that OPSTAT indicates should not be changed.

This prevents a user from bypassing the administration of OPSTAT and changing options settings in the backup file.

**Note:**

If you administered the APPSTAT parameter to suppress changes to one or more applications, the telephone backs up and restores data as usual, but ignores data for “suppressed” applications. This prevents a user from bypassing your APPSTAT restrictions by editing the backup file. For information about APPSTAT, see [The Application Status Flag \(APPSTAT\)](#) on page 114.

During backup file restoration, user activity is prohibited until a `Restore successful` or `Restore Failed` message displays. When a restore attempt fails, if a retrieved file has no valid data, or if a retrieved file cannot be successfully stored, a `Retrieval Failed` message displays at the telephone until the user takes another action.

Data retrieval considerations are as follows:

- When you create a backup file rather than edit an existing one, be sure to create the file with UTF-16 LE (little endian) characters, with Byte Order Mark (BOM) for LE of 0xFFFE.
- Backup saves data values using the generic format *name=value*. For specific formats, see [Backup](#).
- All identifiers, for example, *names*, are interpreted in a case-insensitive manner, but the case of parameter values, Contact names, and numbers is preserved.
- Spaces preceding, within, or following a *name* are treated as part of the *name*.
- <CR> and <LF> (UTF-16 characters 0x000D and 0x000A, respectively) are interpreted as line termination characters.
- Blank lines are ignored.
- When an identifier is not recognized or is invalid, the entire line is ignored. Likewise, if an identifier is valid but the data itself is invalid or incomplete, the line is ignored.
- When an identifier is valid with valid and complete data, but the data is not applicable to the current state of the telephone, the data is retained for possible use later, and is considered data to be backed up at the appropriate time.
- When more than one line contains a value for an option, parameter, or Contacts entry, the last value read is retrieved, to allow new values to overwrite previous values as lines are read from the backup file. In all other cases, the line order in the backup file has no bearing on retrieval.
- The existence of invalid data does not constitute a failed retrieval. The success of the retrieval process requires the telephone to obtain the backup file and successfully restore valid data.

## **Administering Telephone Options**

# Chapter 8: Administering Applications and Options

---

## Customizing 1600 Series IP Telephone Applications and Options

The 1600 Series IP Telephones have some unique and powerful capabilities that take advantage of their display and access to LAN facilities. You need to provide the information called for in relevant sections of [Table 17](#) in a customized script file. For more information, see [1600 Series IP Telephone Scripts and Application Files](#) on page 62.

 **CAUTION:**

For the telephones to work properly, you must have a *46xxsettings.txt* file in the same directory as the application file. If you do not edit the *46xxsettings.txt* file, those telephones use default settings only. The *46xxsettings* file is available as a standalone download. If you already have such a file because you downloaded it for a previous 1600 Series, 9600 Series, or 4600 Series IP Telephone release, installing the standalone file overwrites the original file.

**Note:**

To facilitate administration, the 1600 Series, 9600 Series, and 4600 Series IP Telephones use the same *46xxsettings.txt* file.

In [Table 17](#), parameters shown with a **Mandatory** status must be accurate and non-null for the application to work. You can change parameters with an **Optional** status to suit your environment. If you do not change parameters, the defaults are used.

**Table 17: 1600 Series IP Telephone Customizable System Parameters**

Parameter Name	Default Value	Status	Description and Value Range
<b>General User Parameters:</b>			
APPSTAT	1	Optional	Applications status flag. See <a href="#">The Application Status Flag (APPSTAT)</a> on page 114 for a description. See <a href="#">Table 18</a> for the range of values.
OPSTAT	111	Optional	Options status flag(s) (1 or 3 ASCII numeric digits) indicate which options are user-selectable. The default of 111 grants access to all options and related applications. Single digit valid values are: 1=user can access all options, including Logout, 2= user can access only view-oriented applications.  Three-digit valid values are a concatenation of binary values, in the form <i>abc</i> , where each letter represents a 0 (disabled/off) or 1 (enabled/on), interpreted as: <i>a</i> = base settings for all user options and related applications, except as noted in <i>b</i> or <i>c</i> . <i>b</i> = setting for view-oriented applications (for example, the Network Information application), as applicable. <i>c</i> = setting for Logout application, if applicable. The binary "0" does not allow an end user to see or invoke options and related applications. The binary "1" allows full display and access to all options and related applications.

---

**1 of 2**



**Table 17: 1600 Series IP Telephone Customizable System Parameters (continued)**

Parameter Name	Default Value	Status	Description and Value Range
<b>Web Access Application Parameters:</b>			
SUBSCRIBELIST	" " (Null)	Optional	Subscription list for potential pushed content. List of zero or more fully qualified URLs, separated by commas without intervening spaces, with up to 255 total characters.
TPSLIST	" " (Null)	Optional	List of Trusted Push Servers. List of zero or more fully qualified domain/path strings, separated by commas without intervening spaces, with up to 255 total characters. For more information, see the <i>9600 Series IP Telephone Application Programmer Interface (API) Guide</i> (Document Number 16-601442).
<b>Backup/Restore Parameters</b>			
BRURI	" " (Null)	Mandatory	URL used for backup and retrieval of user data. Specify HTTP server and directory path to backup file. Do not specify backup file name. Value: 0-255 ASCII characters. Null is a valid value and spaces are allowed. If this value is null or begins with a character sequence other than <i>http://</i> or <i>https://</i> the Backup/Restore option will not display to the telephone user.
<b>Backlight Parameters</b>			
BAKLIGHTOFF	120	Optional	Number of idle minutes after which the backlight turns off (1-3 ASCII digits, from 0-999).

---

## The Application Status Flag (APPSTAT)

The 1600 Series IP Telephones offer the user numerous applications like Contacts, Call Log, Redial, and so on. Each of these applications allows the user to add, delete, or in some cases, edit entries. You, as the administrator, might not want the user to have that level of functionality. For example, a hotel lobby telephone probably should not allow a user to delete the concierge's contact number. Further, for privacy reasons, that same telephone should not allow a Call Log display. You can use the Application Status Flag, APPSTAT, to administer specific application functionality permission levels for one or more telephones.

APPSTAT consists of one number, specifying a certain level of allowed functionality. A Zero ("0") value is the most limiting setting. Values "2" and "3" allow increasing levels of functionality, and "1" allows the user complete application functionality.

**Table 18: Application Status Flags and Their Meaning**

APPSTAT Value	Meaning
0	Redial and Call Log are suppressed. Contact changes are not allowed.
1	<b><i>All administered applications are displayed, with full functionality. This is the default value.</i></b>
2	Call Log is suppressed. Contact changes are not allowed. Only one-number Redial is allowed.
3	Contact changes are not allowed.

In [Table 18](#), "suppressed" applications are not displayed to the user. Softkey labels, application tabs, and so on are not labeled or displayed. Options associated with suppressed applications can continue to display unless you override them by appropriate OPSTAT parameter administration. Displayed options have no effect while the application is suppressed.

In [Table 18](#), "Contact changes are not allowed" means the Contact application displays and the user can make calls as normal. Any controls that allow the user to change any aspect of the Contact application do not display. This restriction includes the ability to add, delete, or edit any Contact name or number.

In [Table 18](#), "Only one-number Redial is allowed" means the user Option that allows a choice between displaying last numbers dialed is suppressed. The Redial buffer stores only one number. The Redial application does not display since the user can redial only one number. This restriction allows privacy once a given user has left the telephone.

You can:

- set **APPSTAT** to **1**, for example, in a staging area,
- administer a given telephone with Contact entries of your choice, like the **Concierge telephone number** button in the earlier example,
- then move the telephone to where it will be used, where you have administered APPSTAT to be, for example, 0 (zero).

When the relocated telephone resets, it retains its Contact entries, like Concierge, but does not allow the user to create new entries.

When you set APPSTAT to any valid value other than 1, the telephone does not accept any Contact button label changes that might have been made directly on a backup file. Only the existing labels of the telephone are used. This restriction prevents circumvention of the APPSTAT restrictions.

---

## Variable parameters for improving audio quality

Set the following parameters to improve the audio quality of the 46xx phones (4610/20/21/22/25) using the script file variable.

The system downloads these variable names and their values from the script file at initialization, and then decodes and stores the variable names and their values in internal RAM memory (volatile memory) for use by the audio software.

**Table 19: Variable parameters for improving audio quality**

Parameter Name	Default Value	Status	Description and Value Range
<p><b>AUDIOENV:</b> The value associated with this script file variable (range of 0 to 299) controls the following four audio flags. The AUDIOENV value serves as an index into a table where the system extracts the flags for the four parameters. Each flag allows the audio code to set a PhonexChange register to a specific value to accomplish the required audio performance characteristic. If you set the AUDIONEV values outside the valid range or set non-numeric values, the system ignores these values and retains the default values for these parameters.</p>			
AGC_Dyn_Range	0 for +/-9dB 1 for +/-12 dB 2 for +/-15 dB 3 for +/-18 dB		0 for +/-9dB This is the default setting (typical office environment). The system uses this setting if you do not specify any values or set any values in the script file.

## Administering Applications and Options

Parameter Name	Default Value	Status	Description and Value Range
NR_thresh_Hd	0 (6dB noise reduction) for a typical office environment  1 (15dB noise reduction) for call center applications  2 (24dB noise reduction) for "other" audio environments  3 (0 dB noise reduction) for disabling the noise reduction algorithm altogether  4 (48dB noise reduction)		The transmit noise reduction threshold for the headset. These thresholds correspond to the maximum amount of noise reduction that is applied in the transmit path.

---

**2 of 8**

---

Parameter Name	Default Value	Status	Description and Value Range
NR_thresh_Hs	<p>0 (6dB noise reduction) for a typical office environment</p> <p>1 (15dB noise reduction) for call center applications</p> <p>2 (24dB noise reduction) for "other" audio environments</p> <p>3 (0 dB noise reduction) for disabling the noise reduction algorithm altogether</p> <p>4 (48dB noise reduction)</p>		The transmit noise reduction threshold for the handset. The values are same as the headset noise reduction threshold.
Hd_Tx_Gain	<p>0 for normal transmit gain</p> <p>1 for +6dB</p> <p>2 for -6dB</p>		The transmit noise gain threshold for the headset.

Parameter Name	Default Value	Status	Description and Value Range
EXP_slope_Hd	<p>0 for a typical office environment</p> <p>1 for call center applications</p> <p>2 for other audio environments</p> <p>3 for disabling the noise reduction algorithm altogether</p>		<p>The expander threshold for the headset.</p> <p>These thresholds correspond to the maximum amount of expansion that is applied in the transmit path. These numbers define the slope of the expander curve.</p> <p><b>Note:</b></p> <p>When Noise Reduction is enabled, you can use the same values from NR_thresh_Hd in EXP_slope_Hd. They have analogous meanings. For example, the NR numbers refer to noise reduction thresholds while the EXP numbers refer to the slope of the expander curve. NR_thresh_Hd=3 means that there is no Noise Reduction and EXP_slope_Hd means that the slope is linear (Expander is off).</p>

Parameter Name	Default Value	Status	Description and Value Range
EXP_slope_Hs	<p>0 for a typical office environment</p> <p>1 for call center applications</p> <p>2 for other audio environments</p> <p>3 for disabling the noise reduction algorithm altogether</p>		The expander threshold for the handset. The values are same as the expander threshold for the headset.

Parameter Name	Default Value	Status	Description and Value Range
<b>AUDIOSTHD:</b> The value associated with this script file variable controls the side tone for the headset.			
AUDIOSTHD	0 for default setting		The system ignores values other than the ones specified and retains the default values for Sidetone_Gain_Hd.
	1 for 3 steps below default		
	2 for infinite loss or no sidetone		
	3 for one step below default		
	4 for 2 steps below default		
	5 for 4 steps below default		
	6 for 5 steps below default		
	7 for 6 steps below default		
	8 for 1 step above default		
	9 for 2 steps above default		



Parameter Name	Default Value	Status	Description and Value Range
<b>AUDIOSTHS:</b> The value associated with this script file variable controls the side tone for the handset.			
AUDIOSTHS	0 for default setting		The system ignores values other than the ones specified and retains the default values for Sidetone_Gain_Hs.
	1 for 3 steps below default		
	2 for infinite loss or no sidetone		
	3 for one step below default		
	4 for 2 steps below default		
	5 for 4 steps below default		
	6 for 5 steps below default		
	7 for 6 steps below default		
	8 for 1 step above default		
	9 for 2 steps above default.		

Parameter Name	Default Value	Status	Description and Value Range
EXPANENHS			If this system variable is 1, then the system changes the default noise-reduction algorithm operating in the transmit path, and uses an actual expander algorithm. If the value is 0 or not specified, then the system takes the normal noise-reduction algorithms.
EXPANENHD			If this system variable is 1, then the system changes the default noise-reduction algorithm operating in the transmit path changes, and uses an actual expander algorithm. If the value is 0 or not specified, then the system takes the normal noise-reduction algorithms.

**8 of 8**

An example of the format for setting the script file variables is as follows:

**SET AUDIOENV 14**

**SET AUDIOSTHD 1**

**SET AUDIOSTHS 2**

# Appendix A: Glossary of Terms

<b>802.1P</b> <b>802.1Q</b>	802.1Q defines a layer 2 frame structure that supports VLAN identification and a QoS mechanism usually referred to as 802.1P.
<b>802.1X</b>	Authentication method for a protocol requiring a network device to authenticate with a back-end Authentication Server before gaining network access. Applicable 1600 Series IP telephones support IEEE 802.1X for pass-through and for Supplicant operation with the EAP-MD5 authentication method.
<b>ARP</b>	Address Resolution Protocol, used, for example, to verify that the IP address provided by the DHCP server is not in use by another IP telephone.
<b>CELP</b>	Code-excited linear-predictive. Voice compression requiring only 16 kbps of bandwidth.
<b>CLAN</b>	Control LAN, type of Gatekeeper circuit pack.
<b>CNA</b>	Converged Network Analyzer, an Avaya product to test and analyze network performance.
<b>DHCP</b>	Dynamic Host Configuration Protocol, an IETF protocol used to automate IP address allocation and management.
<b>DiffServ</b>	Differentiated Services, an IP-based QoS mechanism.
<b>DNS</b>	Domain Name System, an IETF standard for ASCII strings to represent IP addresses. The Domain Name System (DNS) is a distributed Internet directory service. DNS is used mostly to translate between domain names and IP addresses. Avaya 1600 Series IP Telephones can use DNS to resolve names into IP addresses. In DHCP, TFTP, and HTTP files, DNS names can be used wherever IP addresses were available as long as a valid DNS server is identified first.
<b>Gatekeeper</b>	H.323 application that performs essential control, administrative, and managerial functions in the media server. Sometimes called CLAN in Avaya documents.
<b>H.323</b>	A TCP/IP-based protocol for VoIP signaling.
<b>HTTP</b>	Hypertext Transfer Protocol, used to request and transmit pages on the World Wide Web.
<b>HTTPS</b>	A secure version of HTTP.
<b>IETF</b>	Internet Engineering Task Force, the organization that produces standards for communications on the internet.
<b>LAN</b>	Local Area Network.
<b>LLDP</b>	Link Layer Discovery Protocol. All IP telephones with an Ethernet interface support the transmission and reception of LLDP frames on the Ethernet line interface in accordance with IEEE standard 802.1AB.
<b>MAC</b>	Media Access Control, ID of an endpoint.

## Glossary of Terms

<b>Media Channel Encryption</b>	Encryption of the audio information exchanged between the IP telephone and the call server or far end telephone.
<b>NAPT</b>	Network Address Port Translation.
<b>NAT</b>	Network Address Translation.
<b>OPS</b>	Off-PBX Station.
<b>PHP</b>	Hypertext Preprocessor, software used to assist in the format and display of Web pages.
<b>PSTN</b>	Public Switched Telephone Network, the network used for traditional telephony.
<b>QoS</b>	Quality of Service, used to refer to several mechanisms intended to improve audio quality over packet-based networks.
<b>RSVP</b>	Resource ReSerVation Protocol, used by hosts to request resource reservations throughout a network.
<b>RTCP</b>	RTP Control Protocol, monitors quality of the RTP services and can provide real-time information to users of an RTP service.
<b>RTP</b>	Real-time Transport Protocol. Provides end-to-end services for real-time data such as voice over IP.
<b>SDP</b>	Session Description Protocol. A well-defined format for conveying sufficient information to discover and participate in a multimedia session.
<b>Signaling Channel Encryption</b>	Encryption of the signaling protocol exchanged between the IP telephone and the call server. Signaling channel encryption provides additional security to the security provided by media channel encryption.
<b>SIP</b>	Session Initiation Protocol. An alternative to H.323 for VoIP signaling. This protocol is not applicable to 1600 Series IP Telephones.
<b>SNTP</b>	Simple Network Time Protocol. An adaptation of the Network Time Protocol used to synchronize computer clocks in the internet.
<b>TCP/IP</b>	Transmission Control Protocol/Internet Protocol, a network-layer protocol used on LANs and internets.
<b>TFTP</b>	Trivial File Transfer Protocol, used to provide downloading of upgrade scripts and application files to certain IP telephones.
<b>TLS</b>	Transport Layer Security, an enhancement of Secure Sockets Layer (SSL). TLS is compatible with SSL 3.0 and allows for privacy and data integrity between two communicating applications.
<b>UDP</b>	User Datagram Protocol, a connectionless transport-layer protocol.
<b>Unnamed Registration</b>	Registration with Avaya Aura Communication Manager by an IP telephone with no extension. Allows limited outgoing calling.
<b>VLAN</b>	Virtual LAN.
<b>VoIP</b>	Voice over IP, a class of technology for sending audio data and signaling over LANs.

2 of 2

# Appendix B: Related Documentation

---

## IETF Documents

The following documents provide standards relevant to IP Telephony and are available for free from the IETF Web site: <http://www.ietf.org/rfc.html>.

- *Requirements for Internet Hosts - Communication Layers*, October 1989, by R. Braden (STD 3: RFC 1122)
- *Requirements for Internet Hosts - Application and Support*, October 1989, by R. Braden (STD 3: RFC 1123)
- *Internet Protocol (IP)*, September 1981, by Information Sciences Institute (STD 5: RFC 791), as amended by *Internet Standard Subnetting Procedure*, August 1985, by J. Mogul and J. Postel (STD 5: RFC 950)
- *Broadcasting Internet Datagrams*, October 1984, by J. Mogul (STD 5: RFC 919)
- *Broadcasting Internet Datagrams in the Presence of Subnets*, October 1984, by J. Mogul (STD 5: RFC 922)
- *User Datagram Protocol (UDP)*, August 28, 1980, by J. Postel (STD 6: RFC 768)
- *Transmission Control Protocol (TCP)*, September 1981, by Information Sciences Institute (STD 7: RFC 793)
- *Domain Names - Concepts and Facilities (DNS)*, November, 1987, by P. Mockapetris (STD 13: RFC 1034)
- *Domain Names - Implementation and Specification (DNS)*, November 1987, by P. Mockapetris (STD 13: RFC 1035)
- *An Ethernet Address Resolution Protocol (ARP)*, November 1982, by David C. Plummer (STD 37: RFC 826)
- *Dynamic Host Configuration Protocol (DHCP)*, March 1997, by R. Droms (RFC 2131)
- *DHCP Options and BOOTP Vendor Extensions*, March 1997, by S. Alexander and R. Droms (RFC 2132)
- *RTP: A Transport Protocol for Real-Time Applications (RTP/RTCP)*, January 1996, by H. Schulzrinne, S. Casner, R. Frederick, V. Jacobson (RFC 1889)
- *Definition of the Differentiated Services Field (DS Field) in the IPv4 and IPv6 Headers, (DIFFSRV)*, December 1998, by K. Nichols, S. Blake, F. Baker and D. Black (RFC 2474)

## Related Documentation

- *Management Information Base for Network Management of TCP/IP Internets: MIB-II*, March 1991, edited by K. McCloghrie and M. Rose (RFC 1213)
- *SNMPv2 Management Information Base for the Internet Protocol using SMIv2*, November 1996, edited by K. McCloghrie (RFC 2011)
- *Structure of Management Information Version 2 (SMIv2)*, April 1999, edited by K. McCloghrie, D. Perkins, and J. Schoenwaelder (RFC 2578)
- *Resource ReSerVation Protocol VI*, September 1997, by R. Braden, L. Zhang, S. Berson, S. Herzog, and S. Jamin (RFC 2205)
- *The TLS Protocol Version 1.0*, January 1999, by T. Dierks and C. Allen (RFC 2246)

---

## ITU Documents

The following documents are available for a fee from the ITU Web site: <http://www.itu.int>.

- *Recommendation G.711, Pulse Code Modulation (PCM) of Voice Frequencies*, November 1988
- *Recommendation G.722, 7 kHz Audio-Coding within 64 kbit/s*, November 1988
- *Recommendation G.729, Coding of speech at 8 kbit/s using Conjugate-Structure Algebraic-Code-Excited Linear-Prediction (CS-ACELP)*, March 1996
- *Annex A to Recommendation G.729: Reduced complexity 8 kbit/s CS-ACELP speech codec*, November 1996
- *Annex B to Recommendation G.729: A silence compression scheme for G.729 optimized for terminals conforming to Recommendation V.70*, November 1996
- *Recommendation H.225.0, Call signalling protocols and media stream packetization for packet-based multimedia communications systems*, February 1998
- *Recommendation H.245, Control protocol for multimedia communication*, February 1998
- *Recommendation H.323, Packet-based multimedia communications systems*, February 1998

---

## ISO/IEC, ANSI/IEEE Documents

The following documents are available for a fee from the ISO/IEC standards Web site:  
<http://www.iec.ch>.

- *International Standard ISO/IEC 8802-2:1998 ANSI/IEEE Std 802.2, 1998 Edition, Information technology - Telecommunications and information exchange between systems - Local and metropolitan area networks- Specific requirements- Part 2: Logical Link Control*
- *ISO/IEC 15802-3: 1998 ANSI/IEEE Std 802.1D, 1998 Edition, Information technology- Telecommunications and information exchange between systems- Local and metropolitan area networks- Common specifications- Part 3: Media Access Control (MAC) Bridges*
- *IEEE Std 802.1Q-1998, IEEE Standards for Local and Metropolitan Area Networks: Virtual Bridged Local Area Networks*
- *IEEE Std 802.3af-2003, IEEE Standard for Information technology- Telecommunications and information exchange between systems- Local and metropolitan area networks- Specific requirements- Part 3: Carrier Sense Multiple Access with Collision Detection (CSMA/CD) Access Method and Physical Layer Specifications- Amendment: Data Terminal Equipment (DTE) Power via Media Dependent Interface (MDI)*
- *IEEE Std. 802.1X-2004, IEEE Standard for Local and Metropolitan Area Networks - Port-Based Network Access Control. For more information about 802.1X, see: <http://www.standards.ieee.org/getieee802/download/802.1X-2004.pdf>*

## Related Documentation



# Appendix C: Sample Administration Forms

Use the sample screens that follow as guidelines for telephone setup.

**Figure 3: Station Form - Basic Telephone Information**

The screenshot shows a window titled "Native Configuration Manager Version 5.2-5 connected to 135.11.193.7 : 5022". The interface includes a menu bar (File, View, Help), a command input field containing "display sta 101-0008", and a toolbar with buttons for CANCEL, REFRESH, F1-F8, HELP, NEXT PA..., and PREV PA... The main display area shows the output of the command:

```
display station 101-0008                               Page 1 of 5
                                     STATION
Extension: 101-0008                                Lock Messages? n          BCC: 0
Type: 1616                                          Security Code: *         TN: 1
Port: S06042                                       Coverage Path 1:         COR: 1
Name: GG                                           Coverage Path 2:         COS: 1
                                                    Hunt-to Station:
STATION OPTIONS
Loss Group: 19                                     Time of Day Lock Table:
                                                    Personalized Ringing Pattern: 1
Speakerphone: 2-way                                Message Lamp Ext: 101-0008
Display Language: english                          Mute Button Enabled? y
Survivable GK Node Name:                            Button Modules: 0
Survivable COR: internal                            Media Complex Ext:
Survivable Trunk Dest? y                            IP SoftPhone? n
```

An "Info:" field is visible at the bottom left of the window.

Figure 4: Station Form - Feature Options

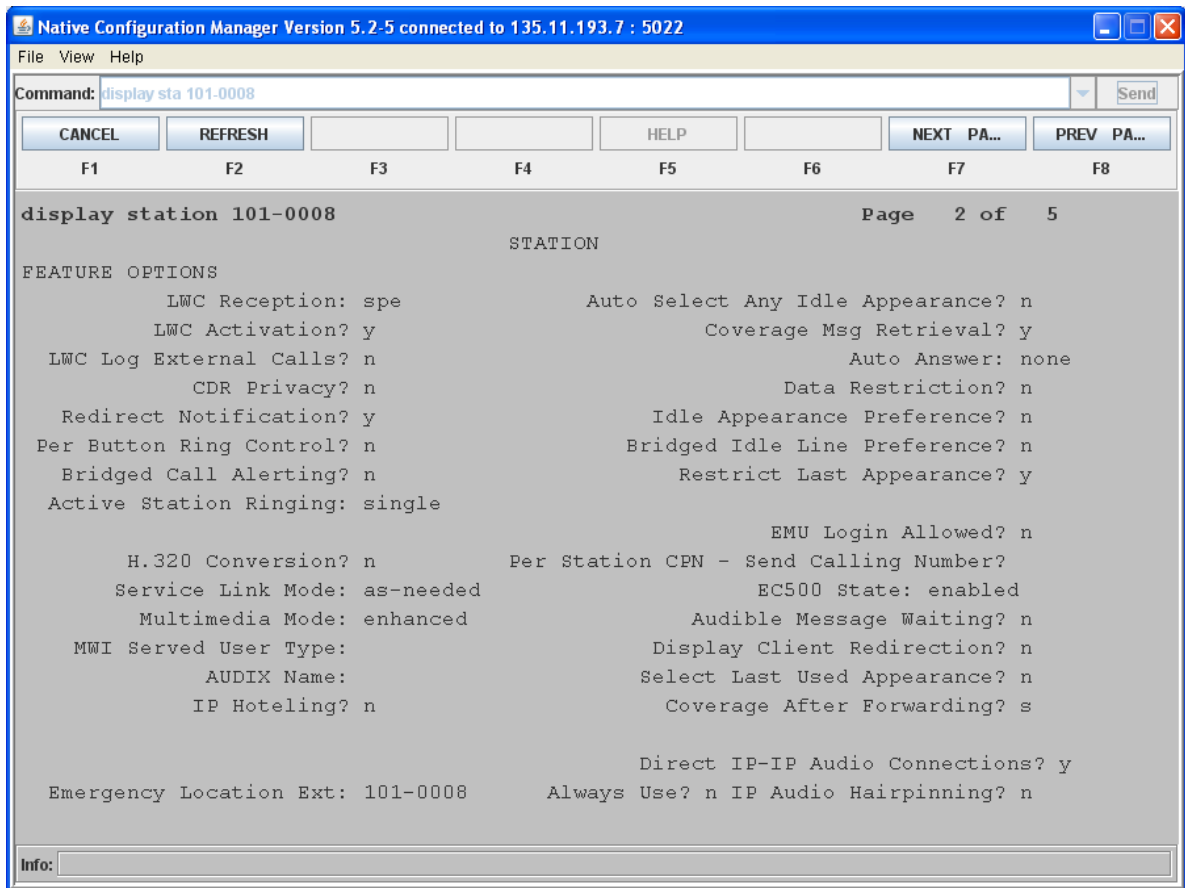

**Figure 5: Station Form - IP Phone Group ID, Bridged Calls, and Enhanced Call Forwarding**

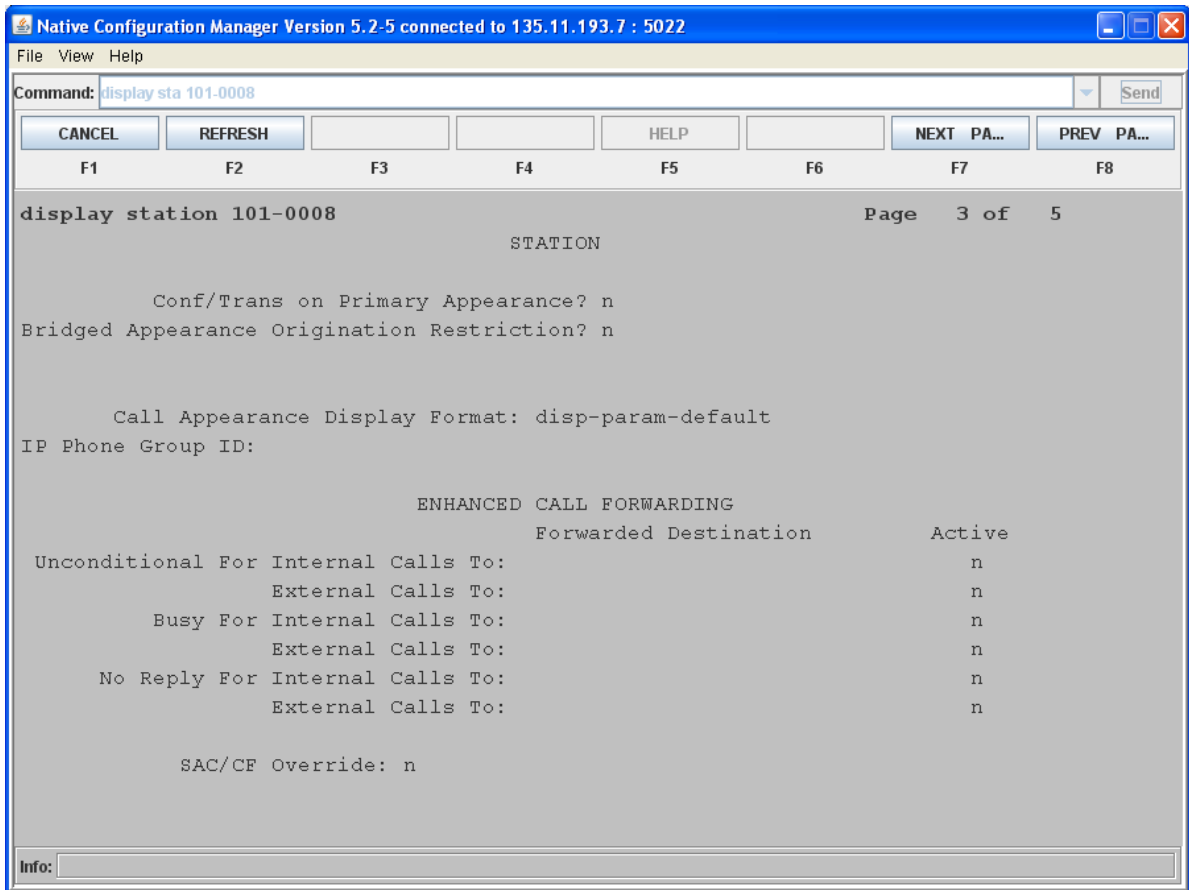
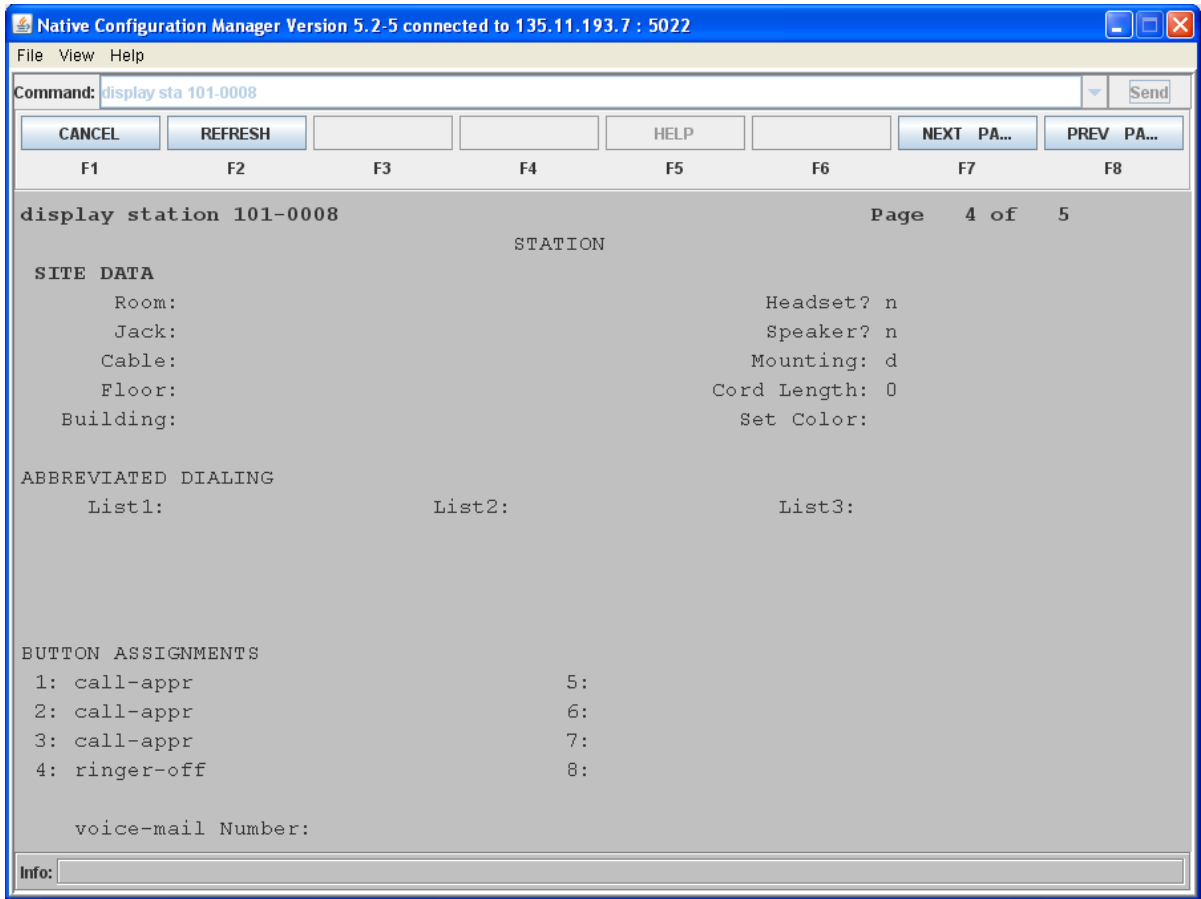

Figure 6: Station Form - Site Data, Abbreviated Dial, and Button Assignments



**Figure 7: Feature-Related System Parameters Form**

The screenshot shows a window titled "Native Configuration Manager Version 5.2-5 connected to 135.11.193.7 : 5022". The window has a menu bar with "File", "View", and "Help". Below the menu bar is a "Command:" field containing "change system-parameters features" and a "Send" button. A toolbar contains buttons for "CANCEL", "REFRESH", "ENTER", "CLEAR FL...", "HELP", "NEXT PA...", and "PREV PA...", with function key labels F1 through F8 below them. The main display area shows the command "change system-parameters features" and "Page 19 of 19". The content is titled "FEATURE-RELATED SYSTEM PARAMETERS" and is divided into sections: "IP PARAMETERS" and "CALL PICKUP".

**change system-parameters features** Page 19 of 19

**FEATURE-RELATED SYSTEM PARAMETERS**

**IP PARAMETERS**

Direct IP-IP Audio Connections?

IP Audio Hairpinning?

SDP Capability Negotiation for SRTP?

**CALL PICKUP**

Maximum Number of Digits for Directed Group Call Pickup:

Call Pickup on Intercom Calls?       Call Pickup Alerting?

Temporary Bridged Appearance on Call Pickup?       Directed Call Pickup?

Extended Group Call Pickup:

Enhanced Call Pickup Alerting?

Enhanced Call Pickup Delay Timer (sec.) Display:       Audible Notification:

Display Information With Bridged Call?

Keep Bridged Information on Multiline Displays During Calls?

PIN Checking for Private Calls?

**Info:** Right-click in a field to see valid entries or help text.

Figure 8: IP Address Mapping Form

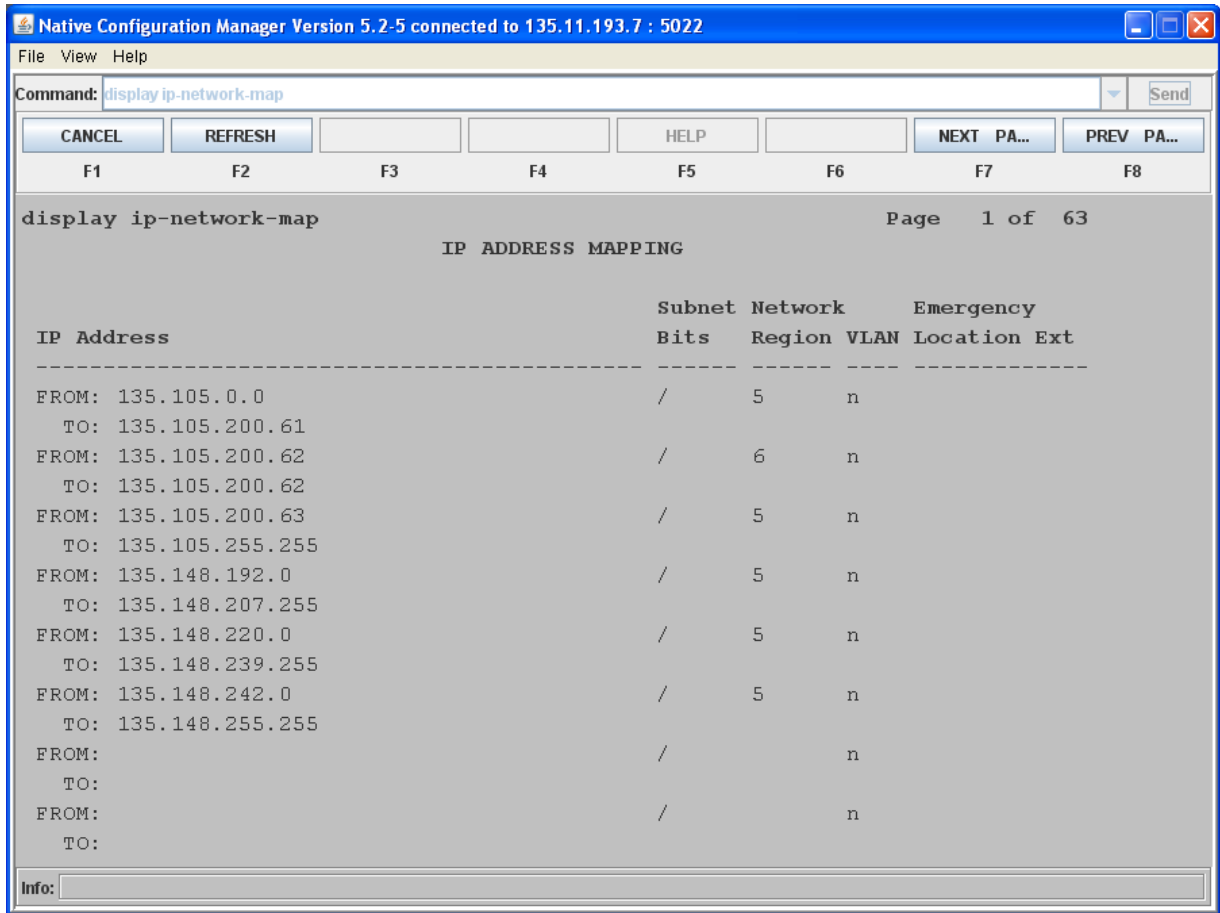
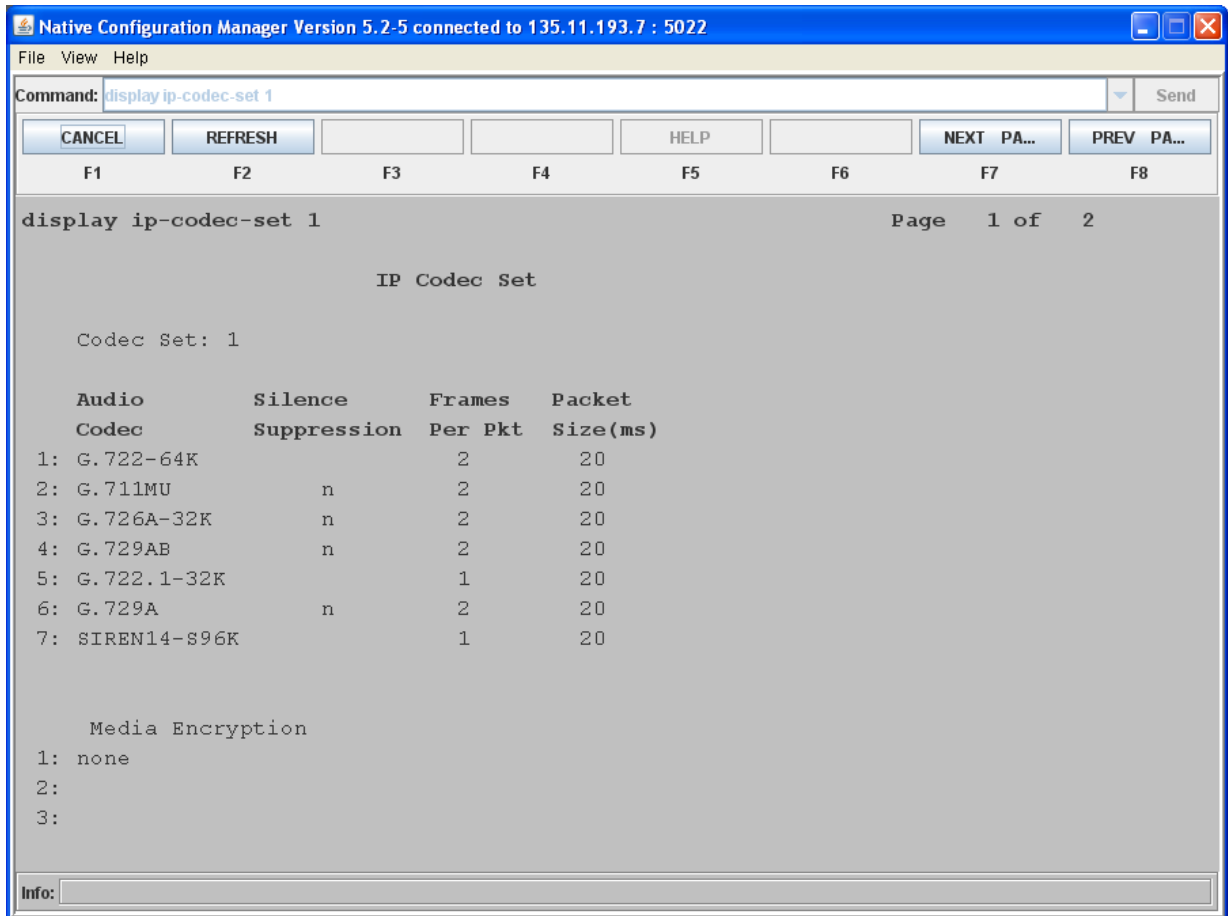
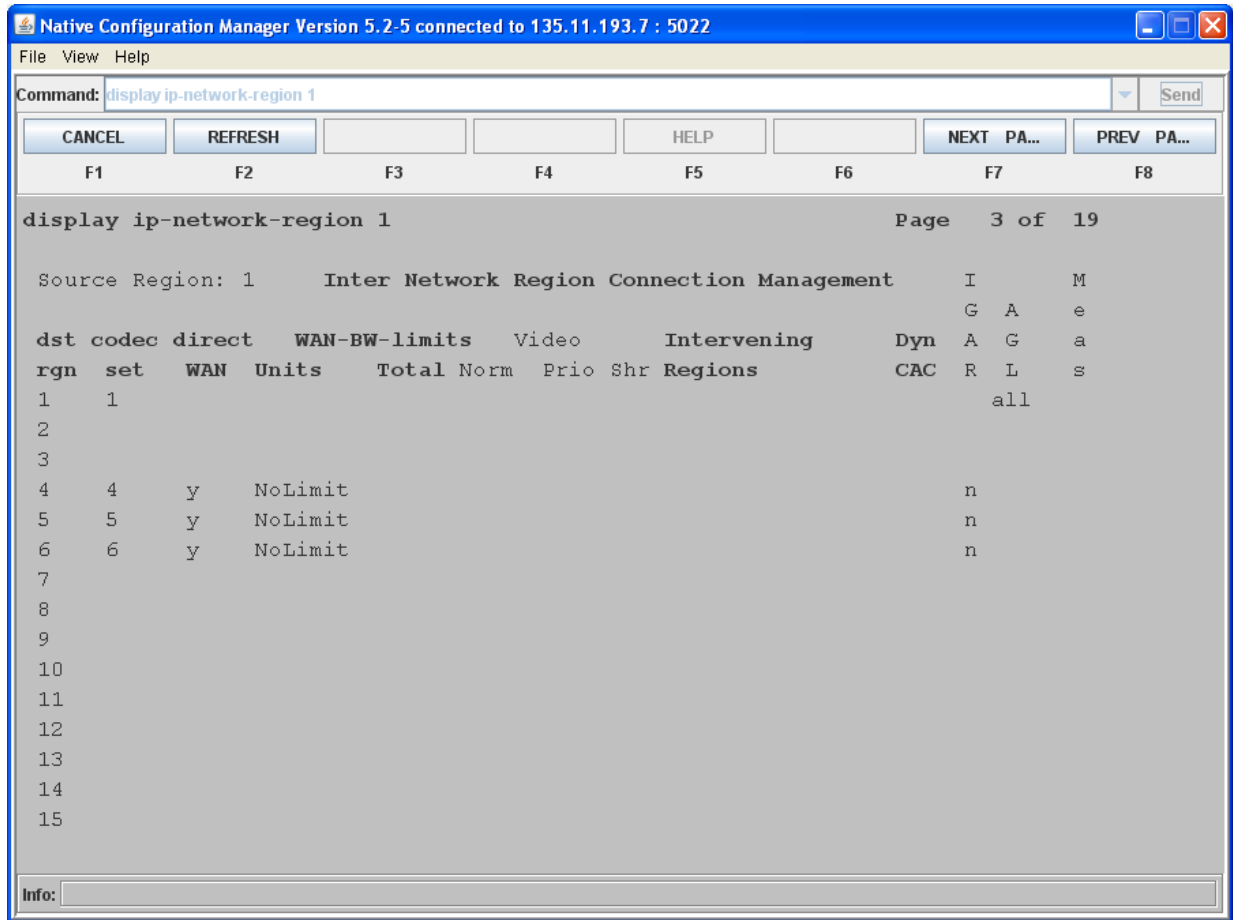

Figure 9: IP Codec Set Form



**Figure 10: Inter-Network Region Connection Management Form**



The entries on the IP Address network map shown in [Figure 8](#) might redirect endpoints into a particular network region. That region could be different from what is administered on the previous forms.



Figure 11: IP Network Region Form

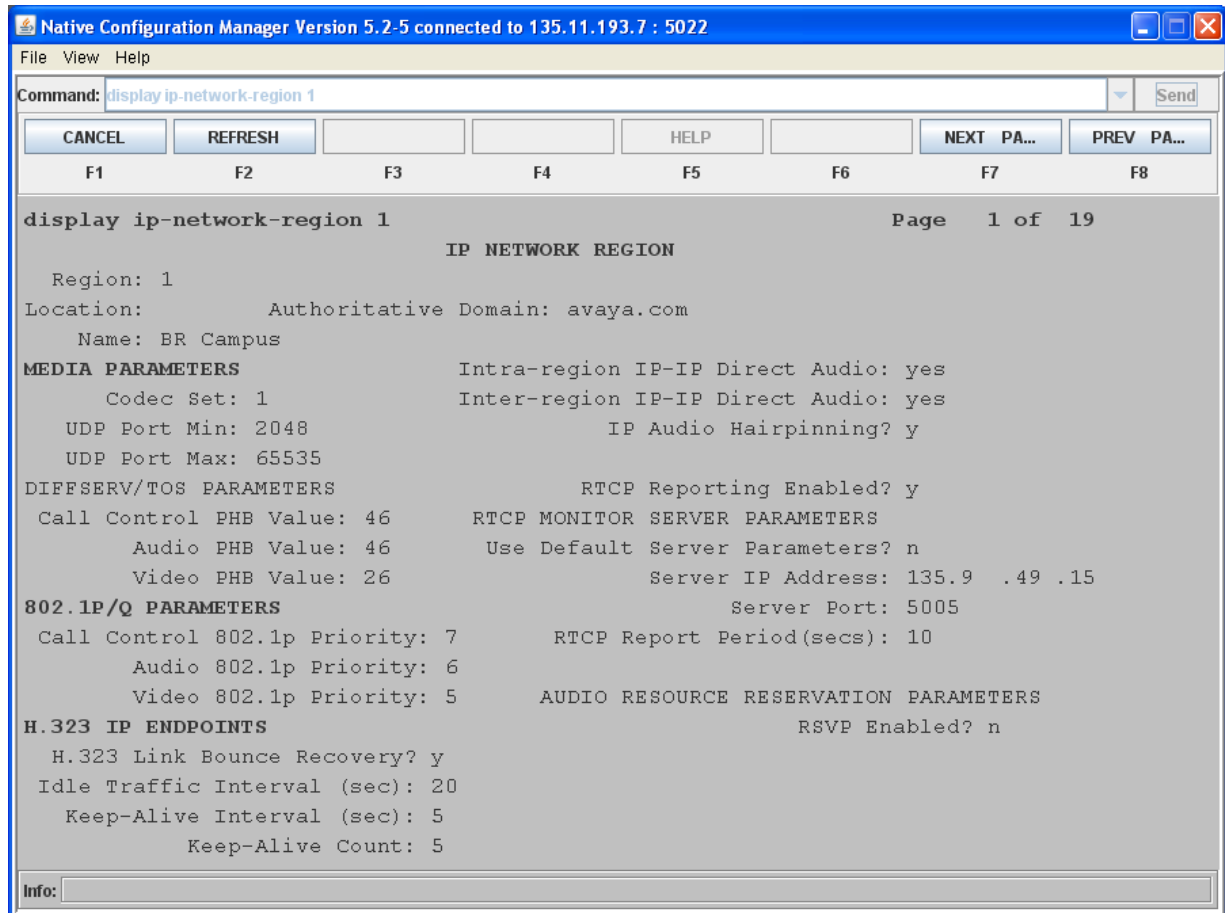

Figure 12: IP-Options System Parameters Form

The screenshot shows a window titled "Native Configuration Manager Version 5.2.5 connected to 135.11.193.7 : 5022". The window has a menu bar with "File", "View", and "Help". Below the menu bar is a "Command:" field containing "change system-parameters ip-options" and a "Send" button. A toolbar contains buttons for "CANCEL", "REFRESH", "ENTER", "CLEAR FL...", "HELP", "NEXT PA...", and "PREV PA...", with function key labels F1 through F8 below them. The main area displays the command "change system-parameters ip-options" and "Page 3 of 3". The content is titled "IP-OPTIONS SYSTEM PARAMETERS" and is divided into three sections: "SNMP PARAMETERS", "SOURCE ADDRESSES", and "SERVICES DIAL PAD PARAMETERS".

**SNMP PARAMETERS**  
Download Flag?   
Community String:

**SOURCE ADDRESSES**

1.	<input type="text"/>	4.	<input type="text"/>
2.	<input type="text"/>	5.	<input type="text"/>
3.	<input type="text"/>	6.	<input type="text"/>

**SERVICES DIAL PAD PARAMETERS**  
Download Flag?   
Password: \*

**Info:** Right-click in a field to see valid entries or help text.

# Index

## Numerical

1600 Series IP Telephone	
Restart . . . . .	<a href="#">88</a>
1600 Series IP Telephones	
Administering Options for . . . . .	<a href="#">67</a>
Administration Alternatives and Options . . . . .	<a href="#">12</a>
Customizable System Parameters . . . . .	<a href="#">68</a>
Customizing Applications and Options . . . . .	<a href="#">111</a>
Initialization Process . . . . .	<a href="#">17</a>
Network Audio Quality Display . . . . .	<a href="#">26</a>
Scripts and Application Files . . . . .	<a href="#">62</a>
1603/1603SW/1603-I IP Telephone . . . . .	<a href="#">40</a>
1608/1608-I IP Telephone . . . . .	<a href="#">40</a>
1616/1616-I IP Telephones . . . . .	<a href="#">40</a>
802.1X . . . . .	<a href="#">77</a>

## A

About This Guide . . . . .	<a href="#">7</a>
ADDR Option . . . . .	<a href="#">94</a>
Ad-Hoc Conferences . . . . .	<a href="#">41</a>
Administering Applications and Options . . . . .	<a href="#">111</a>
Administering Avaya Communication Manager . . . . .	<a href="#">31</a>
Administering Features . . . . .	<a href="#">39</a>
Administering Telephone Options . . . . .	<a href="#">67</a>
Administration Alternatives and Options for 1600 Series IP Telephones . . . . .	<a href="#">12</a>
Administration Forms . . . . .	<a href="#">123</a>
Administration Forms, Samples . . . . .	<a href="#">123</a>
Administration, for Avaya Communication Manager . . . . .	<a href="#">31</a>
Administration, for Telephones on media server . . . . .	<a href="#">37</a>
Administrative Checklist . . . . .	<a href="#">16</a>
Administrative Options, Local . . . . .	<a href="#">84</a>
Administrative Process, The . . . . .	<a href="#">15</a>
Aliasing . . . . .	<a href="#">31</a>
Aliasing 1600 Series IP Telephones . . . . .	<a href="#">39</a>
Alternatives, Administration . . . . .	<a href="#">12</a>
ANSI/IEEE Documents . . . . .	<a href="#">121</a>
Application File and Upgrade Script, Choosing . . . . .	<a href="#">62</a>
Application Files and Telephone Software . . . . .	<a href="#">61</a>
Application Files, and Scripts for 1600 Series IP Telephones . . . . .	<a href="#">62</a>
Application Status Flag (APPSTAT) . . . . .	<a href="#">114</a>
Application Status Flags and Their Meaning . . . . .	<a href="#">114</a>
Applications and Options, Administering . . . . .	<a href="#">111</a>
Applications, Customizing . . . . .	<a href="#">111</a>
Application-specific parameters, administering . . . . .	<a href="#">14</a>
APPSTAT . . . . .	<a href="#">114</a>

Assessment, of Network . . . . .	<a href="#">21</a>
Auto Hold administration . . . . .	<a href="#">38</a>
Auto select any idle appearance administration . . . . .	<a href="#">39</a>

## B

Backup . . . . .	<a href="#">107</a>
Backup File Formats . . . . .	<a href="#">107</a>
Backup, Options and Non-Password Parameters Saved . . . . .	<a href="#">108</a>
Backup/Restore . . . . .	<a href="#">106</a>
Backup/Restore HTTP Configuration . . . . .	<a href="#">56</a>
button labels . . . . .	<a href="#">42</a>

## C

Call Appearances and Feature Buttons . . . . .	<a href="#">40</a>
Call Server Requirements . . . . .	<a href="#">31</a>
Call Transfer Considerations . . . . .	<a href="#">37</a>
Checklist, Administrative . . . . .	<a href="#">16</a>
Clear Procedure . . . . .	<a href="#">84</a>
Communication Manager Administration . . . . .	<a href="#">31</a>
Conference/Transfer on Primary Appearance administration . . . . .	<a href="#">39</a>
Contents of the Settings File . . . . .	<a href="#">64</a>
Coverage Path administration . . . . .	<a href="#">38, 39</a>
Customizable System Parameters . . . . .	<a href="#">68</a>
Customizing 1600 Series IP Telephone Applications and Options . . . . .	<a href="#">111</a>

## D

Debug Procedure . . . . .	<a href="#">85</a>
DHCP and File Servers . . . . .	<a href="#">43</a>
DHCP Generic Setup . . . . .	<a href="#">44</a>
DHCP options . . . . .	<a href="#">45</a>
DHCP Server . . . . .	<a href="#">22</a>
DHCP Server Administration . . . . .	<a href="#">44</a>
DHCP Server Setup . . . . .	<a href="#">44</a>
DHCP Server to Telephone initialization . . . . .	<a href="#">18</a>
DHCP Server, Windows 2000 Setup . . . . .	<a href="#">52</a>
DHCP Server, Windows NT 4.0 Setup . . . . .	<a href="#">48</a>
DIFFSERV . . . . .	<a href="#">35</a>
Disable Event Logging . . . . .	<a href="#">97</a>
DNS Addressing . . . . .	<a href="#">76</a>
Document Organization . . . . .	<a href="#">8</a>
Documentation, Related . . . . .	<a href="#">9, 119</a>

## Index

---

### E

Enable Event Logging . . . . .	<a href="#">97</a>
Enhanced Conference Features administration . . . . .	<a href="#">38, 39</a>
Enhanced Dialing Procedures . . . . .	<a href="#">105</a>
Enhanced Local Dialing . . . . .	<a href="#">105</a>
Error Conditions . . . . .	<a href="#">19</a>
Event Logging . . . . .	<a href="#">97</a>

---

### F

Far End Mute administration . . . . .	<a href="#">39</a>
Feature Administration for Avaya Communication Manager . . . . .	<a href="#">38</a>
Feature Buttons and Call Appearances . . . . .	<a href="#">40</a>
Feature-Related System Parameters Form . . . . .	<a href="#">127</a>
Feature-Related System Parameters, administering on CM . . . . .	<a href="#">37</a>
Features, Administering . . . . .	<a href="#">39</a>
File download	
Choosing the Right Application and Upgrade Script File. . . . .	<a href="#">62</a>
Download File Content . . . . .	<a href="#">62</a>
from. . . . .	<a href="#">42</a>

---

### G

General Download Process. . . . .	<a href="#">61</a>
Generic Setup, for DHCP. . . . .	<a href="#">44</a>
Glossary of Terms . . . . .	<a href="#">117</a>
Group Identifier . . . . .	<a href="#">86</a>
GROUP System Value . . . . .	<a href="#">65</a>

---

### H

Hardware Requirements . . . . .	<a href="#">21</a>
HTTP Configuration for Backup/Restore. . . . .	<a href="#">56</a>
HTTP/HTTPS Server. . . . .	<a href="#">22</a>

---

### I

IEC/ISO Documents . . . . .	<a href="#">121</a>
IEEE 802.1D and 802.1Q. . . . .	<a href="#">25, 34</a>
IEEE 802.ID/Q QoS parameters . . . . .	<a href="#">35</a>
IEEE/ANSI Documents . . . . .	<a href="#">121</a>
IETF Documents. . . . .	<a href="#">119</a>
Initialization and Address Resolution Diagram . . . . .	<a href="#">29</a>
Initialization Process, for 1600 Series IP Telephones. . . . .	<a href="#">17</a>
Installation, Network Information Required before installing . . . . .	<a href="#">23</a>
Interface Control. . . . .	<a href="#">89</a>
Interface, administering the. . . . .	<a href="#">14</a>
Inter-Network Region Connection Management Form . . . . .	<a href="#">130</a>

IP Address Lists and Station Number Portability . . . . .	<a href="#">26</a>
IP Address Mapping Form . . . . .	<a href="#">128</a>
IP Addresses, administering. . . . .	<a href="#">12</a>
IP Codec Set Form . . . . .	<a href="#">129</a>
IP Interface and Addresses, for media servers . . . . .	<a href="#">33</a>
IP-Options System Parameters Form . . . . .	<a href="#">132</a>
ISO/IEC, ANSI/IEEE Documents . . . . .	<a href="#">121</a>
ITU Documents. . . . .	<a href="#">120</a>

---

### L

Language Selection . . . . .	<a href="#">100</a>
Link Layer Discovery Protocol (LLDP) . . . . .	<a href="#">79</a>
LLDP Data Units Transmitted . . . . .	<a href="#">80</a>
Local Administrative Options . . . . .	<a href="#">84</a>
LOG Procedure . . . . .	<a href="#">97</a>
Logoff Procedure . . . . .	<a href="#">98</a>

---

### M

Media Server (Switch) Administration . . . . .	<a href="#">33</a>
Media Server Administration, Other Considerations. . . . .	<a href="#">36</a>
Media Server Field Names and Corresponding Script File Parameter Names . . . . .	<a href="#">58</a>

---

### N

NAT . . . . .	<a href="#">35</a>
Network Assessment . . . . .	<a href="#">21</a>
Network Audio Quality Display. . . . .	<a href="#">26</a>
Network Considerations, Other . . . . .	<a href="#">24</a>
Network Information, Required . . . . .	<a href="#">23</a>
Network Region Form. . . . .	<a href="#">131</a>
Network Requirements . . . . .	<a href="#">21</a>

---

### O

On-Hook Dialing administration . . . . .	<a href="#">38</a>
Options and Applications, Administering . . . . .	<a href="#">111</a>
Options, Administering . . . . .	<a href="#">67</a>
Options, Customizing . . . . .	<a href="#">111</a>
Options, entering using the Telephone Dialpad . . . . .	<a href="#">84</a>
Options, for 1600 Series IP Telephone Administration . . . . .	<a href="#">12</a>
Other Considerations, for media server administration. . . . .	<a href="#">36</a>
Other Network Considerations. . . . .	<a href="#">24</a>

**P**

Parameter Data Precedence . . . . .	<a href="#">15</a>
Parameter Values . . . . .	<a href="#">92</a>
Parameters in Real-Time . . . . .	<a href="#">26</a>
Parameters Saved During Backup . . . . .	<a href="#">108</a>
Parameters, Customizable . . . . .	<a href="#">68</a> , <a href="#">112</a>
Pass-Through and Proxy Logoff, 802.1X . . . . .	<a href="#">78</a>
Port Utilization	
Selection . . . . .	<a href="#">34</a>
TCP/UDP . . . . .	<a href="#">27</a>
Proxy Logoff and Pass-Through, 802.1X . . . . .	<a href="#">78</a>

**Q**

QoS. . . . .	<a href="#">25</a> , <a href="#">34</a>
Administrative Parameters . . . . .	<a href="#">14</a>
IEEE 802.1D and 802.1Q . . . . .	<a href="#">34</a>

**R**

Registration and Authentication . . . . .	<a href="#">30</a>
Related Documentation . . . . .	<a href="#">119</a>
Reliability and Performance. . . . .	<a href="#">25</a>
Requirements . . . . .	<a href="#">11</a>
Call Server . . . . .	<a href="#">31</a>
Hardware . . . . .	<a href="#">21</a>
Network . . . . .	<a href="#">21</a>
Server . . . . .	<a href="#">22</a>
Reset System Values . . . . .	<a href="#">87</a>
Restore . . . . .	<a href="#">108</a>
Restore/Backup . . . . .	<a href="#">106</a>
Restrict Last Call Appearance administration . . . . .	<a href="#">39</a>
RSVP and RTCP . . . . .	<a href="#">34</a>
RTCP and RSVP . . . . .	<a href="#">34</a>

**S**

Sample Administration Forms. . . . .	<a href="#">123</a>
Script File Parameter Names and Corresponding Media Server Field Names . . . . .	<a href="#">58</a>
Scripts and Application Files, for 1600 Series IP Telephones . . . . .	<a href="#">62</a>
Security . . . . .	<a href="#">30</a>
Send All Calls (SAC) administration . . . . .	<a href="#">39</a>
Server Administration . . . . .	<a href="#">43</a>
Server Administration, DHCP . . . . .	<a href="#">44</a>
Server Requirements. . . . .	<a href="#">22</a>
Settings File . . . . .	<a href="#">63</a>
Settings File, Contents . . . . .	<a href="#">64</a>
SNMP. . . . .	<a href="#">24</a>
Software . . . . .	<a href="#">61</a>
Software Checklist . . . . .	<a href="#">43</a>
Software, Telephone. . . . .	<a href="#">61</a>

**Static Addressing**

Installation . . . . .	<a href="#">94</a>
Station Form	
Basic Telephone Information . . . . .	<a href="#">123</a>
Feature Options . . . . .	<a href="#">124</a>
IP Phone Group ID, Bridged Calls & Enhanced Call Forwarding . . . . .	<a href="#">125</a>
Site Data, Abbreviated Dialing, & Button Assignments. . . . .	<a href="#">126</a>
Station Form - Basic Telephone Information . . . . .	<a href="#">123</a>
Station Form - Feature Options . . . . .	<a href="#">124</a>
Station Form Administration Results Chart . . . . .	<a href="#">40</a>
Station Number Portability and IP Address Lists . . . . .	<a href="#">26</a>
Supplicant Operation, 802.1X . . . . .	<a href="#">78</a>
Switch Administration . . . . .	<a href="#">33</a>
Switch Compatibility and Aliasing IP Telephones . . . . .	<a href="#">31</a>
System Parameter Values, Impact of Received TLVs . . . . .	<a href="#">82</a>
System Parameter Values, troubleshooting. . . . .	<a href="#">92</a>
System Parameters. . . . .	<a href="#">37</a>
System Parameters, Customizable . . . . .	<a href="#">68</a> , <a href="#">112</a>
System Values, Reset . . . . .	<a href="#">87</a>

**T**

Tagging and VLAN, administering . . . . .	<a href="#">12</a>
TCP/UDP Port Utilization . . . . .	<a href="#">27</a>
Telephone Administration . . . . .	<a href="#">12</a> , <a href="#">37</a>
Telephone and Call Server initialization . . . . .	<a href="#">18</a>
Telephone and File Server initialization . . . . .	<a href="#">18</a>
Telephone Initialization Process . . . . .	<a href="#">17</a>
Telephone Options, Administering . . . . .	<a href="#">67</a>
Telephone Software and Application Files . . . . .	<a href="#">61</a>
Telephone to Network initialization. . . . .	<a href="#">17</a>
Terms, Glossary of . . . . .	<a href="#">117</a>
TEST Procedure . . . . .	<a href="#">99</a>
TLVs Received, Impact on System Parameter Values. . . . .	<a href="#">82</a>
Troubleshooting	
Parameter Values . . . . .	<a href="#">92</a>
VIEW Administrative Option . . . . .	<a href="#">91</a>

**U**

UDP Port Selection . . . . .	<a href="#">34</a>
UDP/TCP Port Utilization . . . . .	<a href="#">27</a>
Unnamed Registration . . . . .	<a href="#">19</a>
Upgrade Script and Application File, Choosing the Right . . . . .	<a href="#">62</a>
Upgrade Script File . . . . .	<a href="#">62</a>
Upgrade Script, contents of . . . . .	<a href="#">64</a>

## Index

---

### V

VIEW Administrative Option . . . . .	<a href="#">91</a>
VLAN Considerations . . . . .	<a href="#">73</a>
VLAN Default Value . . . . .	<a href="#">74</a>
VLAN Separation . . . . .	<a href="#">75</a>
VLAN Separation Rules . . . . .	<a href="#">75</a>
VLAN tagging . . . . .	<a href="#">73</a>
Voice Mail Integration . . . . .	<a href="#">36</a>

---

### W

Web Configuration Tool . . . . .	<a href="#">58</a>
----------------------------------	--------------------

## Free Manuals Download Website

<http://myh66.com>

<http://usermanuals.us>

<http://www.somanuals.com>

<http://www.4manuals.cc>

<http://www.manual-lib.com>

<http://www.404manual.com>

<http://www.luxmanual.com>

<http://aubethermostatmanual.com>

Golf course search by state

<http://golfingnear.com>

Email search by domain

<http://emailbydomain.com>

Auto manuals search

<http://auto.somanuals.com>

TV manuals search

<http://tv.somanuals.com>