

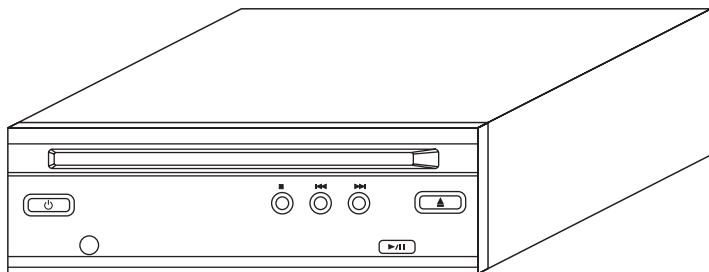

# OWNER'S MANUAL

## Mobile Video System

### MMDV2

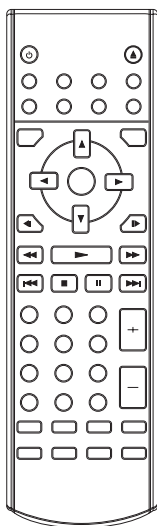

- **Multi-subtitle Languages Function**
- **Multi-audio Languages Function**
- **Multi-angle Function**
- **Parental Control**

## FEATURES

### **Compatible with PAL DVD (Video CD) and NTSC DVD (Video CD)**

This player can play discs recorded in either PAL or NTSC format.

- A single LSI chip now integrates all major DVD playback circuit functions including MPEG2 decoder, video D/A converter, and audio decoders.
- L/R stereo analog audio outputs for connection to existing head unit aux inputs. Video output is composite video.
- Supplied remote handles multi-function software (multi-language audio-track/subtitle, multi-angle, multi-story, etc.), plus all basic functions.

## USE THIS PRODUCT SAFELY

### **When Driving**

Keep the volume level low enough to be aware of road and traffic conditions.

### **When Car Washing**

Do not expose the product to water or excessive moisture. This could cause electrical shorts, fire or other damage.

### **When Parked**

Parking in direct sunlight can produce very high temperatures inside your vehicle. Give the interior a chance to cool down before starting playback.

### **Use the Proper Power Supply**

This product is designed to operate with a 12 volt DC, negative ground battery system (the regular system in a North American car).

### **Protect the Disc Mechanism**

Avoid inserting any foreign objects into the slot of this player.

Failure to observe this may cause malfunction due to the precise mechanism of this unit.

### **Use Authorized Service Centres**

Do not attempt to disassemble or adjust this precision product. Please refer to the Service Centre list included with this product for service assistance.

### **For Installation**

The unit should be installed in a horizontal position with the front end up at a convenient angle, but not more than 30°.

# CONTENTS

---

<b>Safety Information .....</b>	<b>4</b>
<b>Disc Notes .....</b>	<b>5</b>
<b>Installation .....</b>	<b>6</b>
<b>Electrical Connections .....</b>	<b>7</b>
<b>Remote Control .....</b>	<b>8</b>
Preparing the Remote Control .....	10
Loading a DVD/VCD/CD Disc .....	10
Ejecting a Disc .....	10
<b>Basic Operation .....</b>	<b>11</b>
On-Screen Display Function .....	13
Multi-audio Language Function .....	14
Menu Function (For DVD only) .....	14
Title Menu Function (For DVD only) .....	14
Multi-subtitle Language Function (For DVD only) .....	14
Multi-angle Function (For DVD only) .....	14
MP3 Disc Play .....	15
<b>Setup .....</b>	<b>16</b>
Initial Setup .....	16
General Setup .....	16
Speaker Setup .....	18
Audio Setup .....	18
Preferences Setup .....	19
Defaults Table .....	21
<b>Specifications .....</b>	<b>22</b>

# SAFETY INFORMATION

---

## **CAUTION:**

THIS MOBILE DVD PLAYER IS A CLASS I LASER PRODUCT. HOWEVER THIS MOBILE DVD PLAYER USES A VISIBLE/INVISIBLE LASER BEAM WHICH COULD CAUSE HAZARDOUS RADIATION EXPOSURE IF DIRECTED. BE SURE TO OPERATE THE MOBILE DVD PLAYER CORRECTLY AS INSTRUCTED.

USE OF CONTROLS OR ADJUSTMENTS OR PERFORMANCE OF PROCEDURES OTHER THAN THOSE SPECIFIED HEREIN MAY RESULT IN HAZARDOUS RADIATION EXPOSURE. DO NOT OPEN COVERS AND - DO NOT REPAIR YOURSELF. REFER SERVICING TO QUALIFIED PERSONNEL.

## **WARNING:**

- TO REDUCE THE RISK OF FIRE OR ELECTRIC SHOCK, DO NOT EXPOSE THIS EQUIPMENT TO RAIN OR MOISTURE.
- TO REDUCE THE RISK OF FIRE OR ELECTRIC SHOCK, AND ANNOYING INTERFERENCE, USE ONLY THE RECOMMENDED ACCESSORIES.
- THIS DEVICE IS INTENDED FOR CONTINUOUS OPERATION.

This product incorporates copyright protection technology that is protected by method claims of certain U.S. patents and other intellectual property rights owned by Macrovision Corporation and other rights owners. Use of this copyright protection technology must be authorized by Macrovision Corporation, and is intended for home and other limited viewing uses only unless otherwise authorized by Macrovision Corporation. Reverse engineering or disassembly is prohibited.

## **Region Management Information**

Region Management Information:

This Mobile DVD Player is designed and manufactured to respond to the Region Management Information that is recorded on a DVD disc. If the Region number described on the DVD disc does not correspond to the Region number of this Mobile DVD Player, this Mobile DVD Player cannot play this disc.

# DISC NOTES

## Disc formats supported by this player



**DVD**  
12 cm disc  
(Single-sided disc only)



**Video CD**  
12 cm disc



**CD**  
12 cm disc



**MP3**  
12 cm disc

## Discs which cannot be played with this player

- DVD-ROM
- DVD-R/DVD-RAM
- CDV
- CD-G

## Handling and Cleaning

- Dirt, dust, scratches and warping disc will cause erratic operation.
- Do not place stickers or make scratches on discs.
- Do not warp discs.
- A disc should always be kept in its case when not in use to prevent from damage.
- Do not place discs in the following places:
  1. Direct sunlight
  2. Dirty, dusty and damp areas
  3. Near car heaters
  4. On the seats or dashboard

## Disc Cleaning

Use a dry soft cloth to wipe the surface. If the disc is quite dirty, use a soft cloth slightly moistured with isopropyl (rubbing) alcohol. Never use solvents such as benzine, thinner or conventional record cleaners as they may mar the surface of the disc.

### Note:

A disc may become somewhat scratched (although not enough to make it unusable) depending on you handle it and conditions in the usage environment.

Note these scratches are not an indication of any problem with the player.

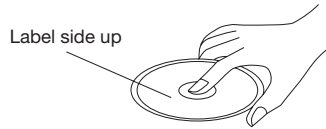

Do not touch the underside of the disc

Do not bend

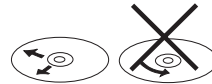

Wipe the disc from center toward the outside edge

# INSTALLATION

---

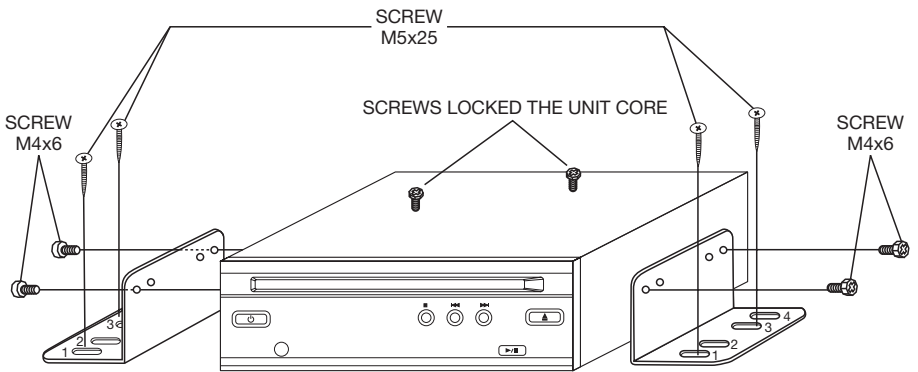

## Note:

1. First remove the two transport screws that lock the unit core; then attach the brackets on both sides of unit with screws (M4x6). Install the unit with screws (M5x25).
2. When installing the unit, you can slide the screw (M5x25) to left side or right side to adjust to the required position. In the figure above, select 1 and 3 positions to align the bracket, or you can also select 2 and 4 positions to align the bracket.

# ELECTRICAL CONNECTIONS

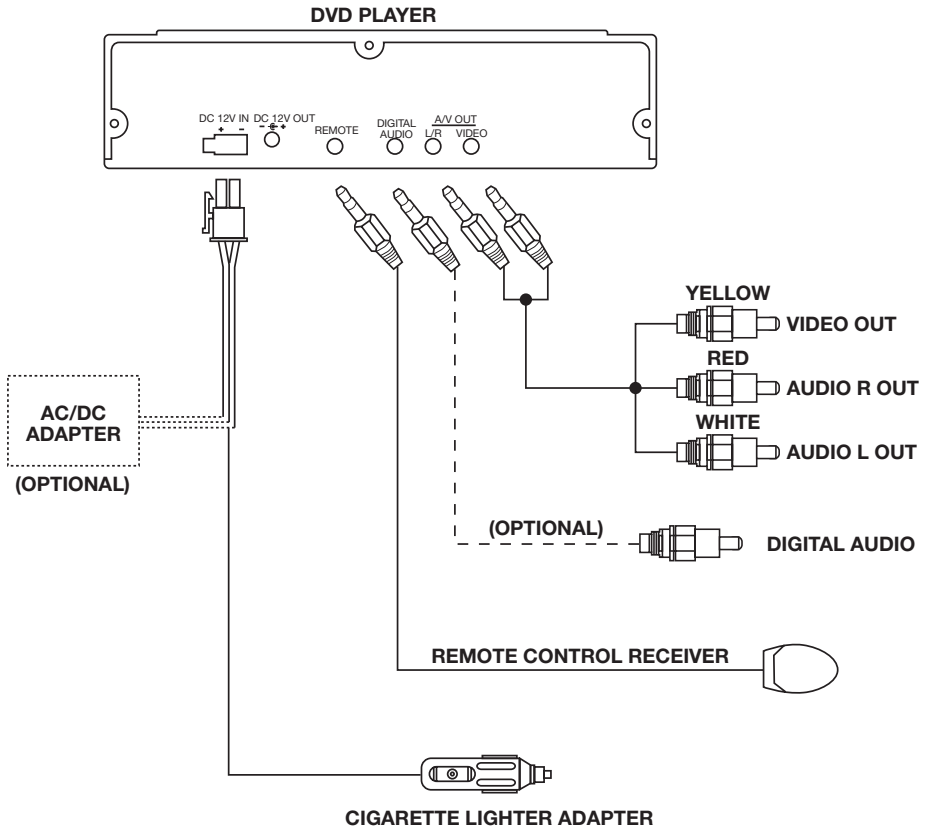

# REMOTE CONTROL



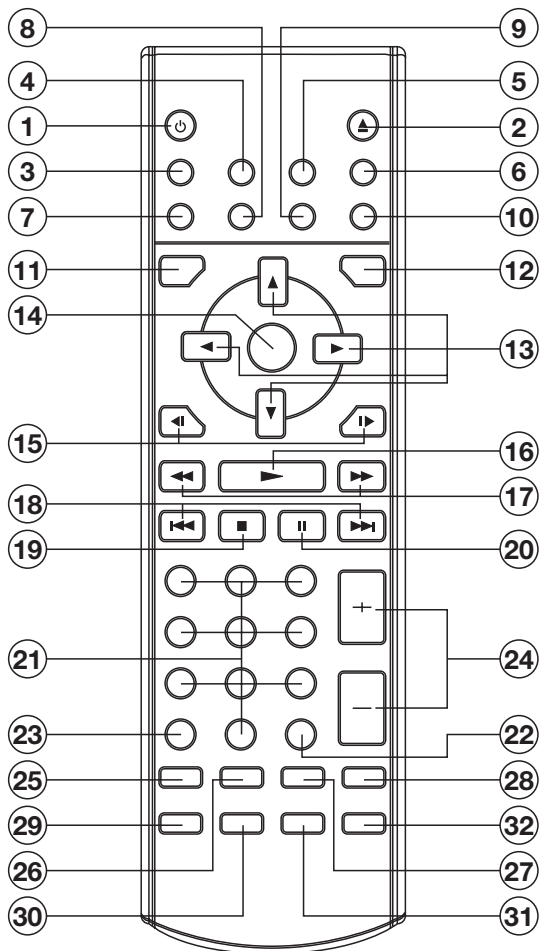



















---





# REMOTE CONTROL

---

1.  POWER Press POWER to turn the unit ON or OFF.
2. EJECT Press to eject the disc.
3. MUTE Press to mute the sound.
4. SUBTITLE Change the SUBTITLE language on multi-subtitle language DVD disc.
5. ANGLE Change the view angle on multi-angle DVD disc.
6. DISPLAY Display statistical disc information during playback.
7. PBC Change between PBC ON and PBC OFF on the VCD disc.
8. SETUP Display the SETUP menu.
9. PAL/NTSC Switch between PAL mode and NTSC mode.
10. AUDIO Change the AUDIO soundtrack on multi-audio soundtrack DVD disc. Change of the sound mode of the VCD/CD disc.
11. TITLE Display the TITLE menu that is stored in DVD disc.
12. MENU Display the root menu that is stored on the DVD disc
13. / , /  In case of MENU mode, / , / , buttons served as cursor buttons to select item left/right, ahead/back.
14. ENTER Confirm the Track/Chapter selected with the numeric buttons or selected with the cursor buttons on TV screen.
15. /  Change the slow forward/reverse playback motion.
16.  Press to play the disc.
17. /  Press  to start forward rapidly &  to reverse rapidly.
18. /  Press  to skip to the next track & press  to skip back one track.
19.  Press to stop playback.
20.  Press to pause playback.
21. 0 - 9 Numeric buttons
22. 10+ Digital select button, used in conjunction with numeric buttons.
23. CLEAR When you input a number in error, press the button to clear it.
24. VOLUME+/- Press VOLUME+/- button to increase or decrease the volume level.
25. ZOOM Allows the picture to be increased or decreased in size.
26. RESUME When in stop mode, press the button, then play can be resumed from the stop point.
27. GOTO Disc search button, used in conjunction with numeric buttons.
28. STEP Press to stop at the next picture.
29. RANDOM Allows tracks to be played in random order.
30. PROGRAM Allows the tracks to be played in the order you programmed.
31. REPEAT Switch the Repeat mode of discs.
32. A-B A-B repeat allows a passage to be repeated continuously.

# REMOTE CONTROL

---

## Preparing the Remote Control

### *Inserting the Batteries*

1. Open the battery compartment cover.
2. Insert two new AAA batteries. Make sure that the positive and negative terminals of the batteries are oriented as indicated.
3. Close the cover

### *Using the Remote Control*

Point the remote control towards the player front panel IR mark (remote control signal receiver).

Operation angle: About  $\pm 30$  degree in each direction with respect to of the front of the IR mark.

**To prevent damage to the unit, be sure to follow the connection diagram (page 7).**

## Loading a DVD/VCD/CD Disc

1. Turn the ignition to the accessory position.
2. Press the POWER button (1).
3. Insert the disc into the disc slot (2) with printed side facing up.
4. The player starts playback automatically.

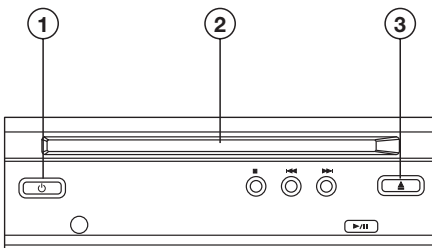

## Ejecting a Disc

Press  (EJECT) button (3) to eject the disc.

# BASIC OPERATION

## Stopping Play

- Briefly press the ■ (Stop) button to stop the unit playback, when the ► (Play) button is pressed, continuous normal playback is enabled.
- Press ■ (Stop) button twice, it will stop the playback and go back to initial Track/Chapter.

## Rapid Forward/Rapid Reverse

Press ►► & ◀◀ during play. Each time the button is pressed, the speed of rapid forward/reverse changes depending on the type of disc as follows.

DVD:

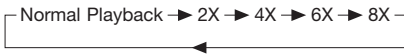

VCD/CD:

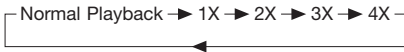

MP3:



## Skipping Track

Press SKIP ►►/◀◀ on the remote control or ◀◀/►► buttons on the front panel during playback.

Press ►► to skip to next track, and ◀◀ to back one track.

Note: For some VCD 2.0 discs (PBC-playback control), ►►/◀◀ buttons may be unavailable.

## Slow Motion Play

Press 1►/◀1 during play.

Each time the button is pressed, the speed of slow forward/reverse changes according to the disc as follows.

DVD:



## Pause (still picture)

Pressing II during playback will stop play temporary. To return to normal playback, press ► once again.

## MUTE

Will mute the sound, but the disc continues playing. When you unmute the sound (press MUTE again), a later passage will be playing.

## Repeat

FOR DVD:

Press the REPEAT button to select repeat mode as follows.



FOR VCD/CD:

Press the REPEAT button to select repeat mode as follows.



1. Continuously repeat at the current chapter/track, when REP-ONE mode is selected.
2. Select REP-ALL mode to continuously repeat all chapter/track on the current disc.
3. When the player finishes playback, the current disc last chapter/track will stop displaying the elapsed time. When REPEAT OFF mode is selected, REP-ONE & REP-ALL disappear from the screen display.
4. REPEAT feature does not support VCD2.0 (with PBC ON).

# BASIC OPERATION

---

## Repeat A-B

A-B repeat allows a passage to be repeated continuously. Press **A-B** button at the start of the required passage, then press **A-B** button again at the end of the passage. To revert to normal playing, press **A-B** button again. Each time the button is pressed, the screen will display the following:

A TO B SET A → A TO B SET B → A TO B CANCELLED

## Disc Search (GOTO)

FOR DVD

Press **GOTO** button twice, the screen will display the following message:

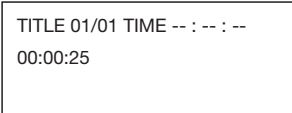

TITLE 01/01 TIME -- : -- : --  
00:00:25

You can select the item you want to watch through TIME setting by using numeric buttons and ENTER key.

FOR VCD (WITH PBC OFF)/CD:

Press **GOTO** button once, the screen will display the following message:

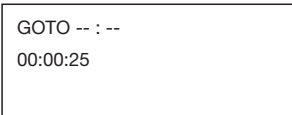

GOTO -- : --  
00:00:25

Use numeric buttons to input the time directly.

## ZOOM

Allows the picture to be increased or decreased in size. Press **ENTER** to toggle among 1.5 scale, 2.0 scale and 3.0 scale.

## RANDOM

Press **RANDOM** button, track selection will be made in random order. The display screen will show "SHUFFLE ON" in the right-top corner. Press **RANDOM** button again, "SHUFFLE OFF" appears and releases the mode.

## PROGRAM

In stop mode, press **PROGRAM** button, the screen will display "PROGRAM P00:00". For example: press numeric button 4 and ► button, "PROGRAM P01:04" appears. It means track 4 will be played first.

## Reset

Reset button is located on the front panel and must be activated with a ball point pen or thin metal object. Reset button is to be activated for the following reasons:

- Initial installation of the unit when all wiring is completed.
- All the function buttons do not operate.
- Error symbol on the display.

## Remote Sensor (IR)

Point the remote control at the remote sensor. The IR sensor receives the signal from the remote control.

## Turning the player on/off

Press the ⏻ (**POWER**) button on front of panel or press ⏻ (**POWER**) button on remote control to turn the player on or off.

# BASIC OPERATION

## On-Screen Display Function

Press the **DISPLAY** button during playback to display the contents of the current disc on the screen.

Example:

DVD:

(1) Press **DISPLAY** for the first time:

```
TITLE 01/03 CHAPTER 002/025
00:02:25
```

Title Number, Total Title Number, Chapter Number, Total Chapter Number of this Title of the disc currently being played will be shown on the screen, along with the elapsed time.

(2) Press **DISPLAY** for the second time:

```
TITLE REMAIN
01:46:58
```

(3) Press **DISPLAY** for the third time:

```
CHAPTER ELAPSED
00:00:24
```

(4) Press **DISPLAY** for the fourth time:

```
CHAPTER REMAIN
00:01:39
```

(5) Press **DISPLAY** for the fifth time:

The message on the screen will be cleared.

VCD:

(1) Press **DISPLAY** for the first time:

```
SINGLE ELAPSED
00:00:25
```

(2) Press **DISPLAY** for the second time:

```
SINGLE REMAIN
00:03:15
```

(3) Press **DISPLAY** for the third time:

```
TOTAL ELAPSED
00:00:25
```

(4) Press **DISPLAY** for the fourth time:

```
TOTAL REMAIN
00:40:35
```

(5) Press **DISPLAY** for the fifth time:

The message on the screen will be cleared.

CD:

(1) Press **DISPLAY** for the first time:

```
SINGLE ELAPSED
00:00:25
TOTAL TRACK : 14
TRACK : - 01
```

(2) Press **DISPLAY** for the second time:

```
SINGLE REMAIN
00:03:15
TOTAL TRACK : 14
TRACK : - 01
```

(3) Press **DISPLAY** for the third time:

```
TOTAL ELAPSED
00:00:25
TOTAL TRACK : 14
TRACK : - 01
```

# BASIC OPERATION

(4) Press **DISPLAY** for the fourth time:

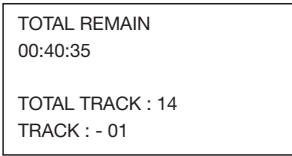

(5) Press **DISPLAY** for the fifth time:

The message on the screen will be cleared.

MP3 (When set to NO MENU in SMART NAV item):

(1) Press **DISPLAY** for the first time:



(2) Press **DISPLAY** for the second time:

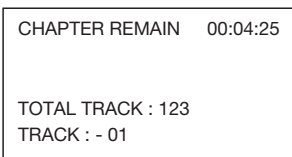

(3) Press **DISPLAY** for the third time:

The message on the screen will be cleared.

## Multi-audio Language Function

### For DVD:

Press **AUDIO** during playback. Each time the button is pressed, number of the audio soundtrack language changes on sequential order.

Notes:

- The language number is different according to the disc.
- Some disc only contain one language soundtrack.
- When no different language soundtrack are recorded, will be displayed at screen left top corner.

### For VCD/CD:

Press **AUDIO** during playback. It is possible to switch the sound between monaural and stereo sound.



## MENU Function (For DVD Only)

Press **MENU** button while the disc is playing and the disc menu will be displayed. You can navigate with the remote control navigation keys and select a feature with the **ENTER** key.

## TITLE Menu Function (For DVD only)

If the DVD has multiple titles recorded on the disc. It can select preferred title from the title menu to start playback.

- Press **TITLE** during playback. The title menu is display.
- Press the cursor button shown in TV screen, select preferred title by the cursor button and confirmed by **ENTER** key.

## Multi-subtitle Language Function (For DVD only)

Press **SUBTITLE** during playback. Each time the button is pressed, number of the subtitle language changes in sequential order.

Notes:

- The language number is different according to the disc.
- Some discs only contain one subtitle language.
- When no different subtitle language are recorded, will be displayed at screen left top corner.

## Multi-angle Function (For DVD only)

Press **ANGLE** during playback. Each time the button is pressed, number of the angle changes in sequential order.

Notes:

- The angle number is different according to the disc.
- The function only works for discs having scenes recorded at different angles.
- When no different angle are recorded, will be displayed at screen left top corner.

# BASIC OPERATION

---

## MP3 Disc Play

MP3 disc is playing as the format of FOLDER.

For example:

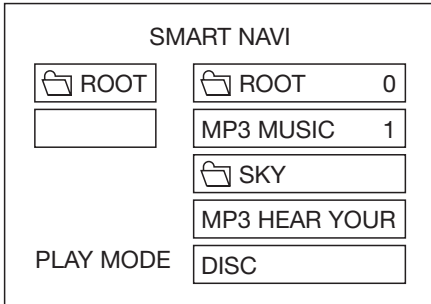

Select **STOP** button or use the **▶▶** / **◀◀** buttons to change tracks.

Pressing **REPEAT** button repeatedly can select three kinds of repeat play mode.

**REP-ONE:**

Play the same song over and over again.

**FOLDER REPEAT:**

Play all songs in the current directory in sequence, over and over again.

**FOLDER:**

Play all songs in the current directory once.

When select **PLAY MODE**, press **▲** / **▼** to change between the following mode:

SINGLE → REP-ONE → FOLDER → FOLDER REP →  
DISC SCAN → **DISC** → DISC REP → RANDOM →  
SHUFFLE ON → PROGRAM PXXX

In the playback, use **▲** or **▼** to skip an item ahead or back.

**◀◀**: Rapid reverse, **▶▶**: Rapid advance

Note: The **FOLDER** cannot be selected during playing. It can be selected after

**■** (Stop) button pressed.

# SETUP

## INITIAL SETUP

SETUP MENU --- MAIN PAGE

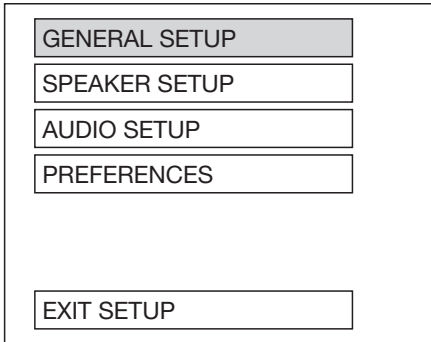

1. Press **SETUP** in the stop mode.  
(Press the stop button twice to ensure the player under STOP mode.)
2. The initial SETUP menu is displayed.
3. Select the preferred item by using the ▲/▼ buttons.
4. Press ENTER buttons.
  - a. **GENERAL SETUP**  
This setup page includes all the item of TV display & audio output feature. The detail please refer to **GENERAL SETUP MENU**.
  - b. **SPEAKER SETUP**  
This is to activate the audio output from DOLBY AC3 5.1 DOWNMIX to 2 channel mode. Please refer to **SPEAKER SETUP MENU**.
  - c. **AUDIO SETUP**  
This setup page includes all the items for AUDIO. Please refer to **AUDIO SETUP MENU**.
  - d. **PREFERENCE SETUP**  
This setup page includes all the configuration of support feature. The detail please refer to **PREFERENCES SETUP MENU**.

## GENERAL SETUP

--- GENERAL PAGE ---

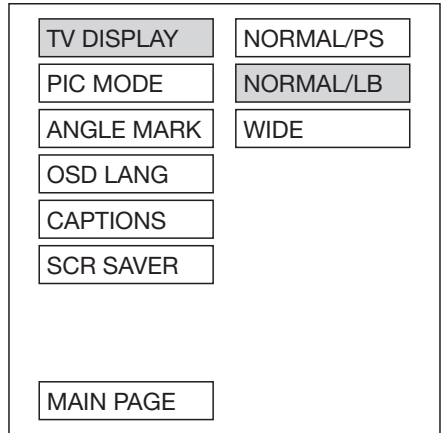

Video Material	TV Screen			
	4:3			Wide (16:9)
	Normal	Pan Scan	Letter-box	
4:3				
16:9				

### TV display setup

This is to select the appropriate TV aspect (4:3 or 16:9) according to the connected TV set.

#### Normal/PS (For 4:3 TV)

Played back in the PAN & SCAN style. (If connected to wide-screen TV, the left and right edges are cut off.)

#### Normal/LB (For 4:3 TV)

Played back in letterbox style. (If connected to wide-screen TV, black bands appear at top and bottom of the screen.)

#### Wide (For 16:9 TV)

Select when a wide-screen TV set is connected.



# SETUP

--- GENERAL PAGE ---

TV DISPLAY	
PIC MODE	AUTO
ANGLE MARK	HI-RES
OSD LANG	N-FLICKER
CAPTIONS	
SCR SAVER	
MAIN PAGE	

## PIC mode setup

Select AUTO, the player PIC mode will depend on DVD disc.  
Select HI-RES format for best image resolution.  
Select N-FLICKER format on format on image or picture under noise affect.

--- GENERAL PAGE ---

TV DISPLAY	
PIC MODE	
ANGLE MARK	
OSD LANG	ENGLISH
CAPTIONS	
SCR SAVER	
MAIN PAGE	

## OSD LANG type setup

Select the preferred OSD language by using the ▲/▼ buttons.

--- GENERAL PAGE ---

TV DISPLAY	
PIC MODE	
ANGLE MARK	ON
OSD LANG	OFF
CAPTIONS	
SCR SAVER	
MAIN PAGE	

## ANGLE MARK display setup

If it is set to ON, when the multi-angle DVD disc is playing, 𐄂 (the angle mark) will appear on the screen; if is set to OFF, the mark will not appear.

--- GENERAL PAGE ---

TV DISPLAY	
PIC MODE	
ANGLE MARK	
OSD LANG	
CAPTIONS	ON
SCR SAVER	OFF
MAIN PAGE	

## CAPTIONS setup

Activate the CAPTIONS feature by selecting ON. And release this feature by selecting OFF.

# SETUP

--- GENERAL PAGE ---

TV DISPLAY	
PIC MODE	
ANGLE MARK	
OSD LANG	
CAPTIONS	
SCR SAVER	ON
	OFF
MAIN PAGE	

## SCR SAVER setup

Select the SCR SAVER output ON/OFF.

## SPEAKER SETUP

--- SPEAKER SETUP PAGE ---

DOWNMIX	LT/RT
	STEREO
MAIN PAGE	

This is to activate the audio output from DOLBY AC3 5.1 DOWNMIX to 2 channel mode. Select the preferred SPEAKER connection by using the cursor buttons.

- Select the LT/RT to activate the Dolby surround compatible output.
- Select the STEREO to activate simple stereo mode.

## AUDIO SETUP

--- AUDIO SETUP ---

AUDIO OUT	ANALOG
OP MODE	SPDIF/RAW
DYNAMIC	SPDIF/PCM
LPCM OUTPUT	
MAIN PAGE	

## AUDIO OUT

This is to activate the audio output from ANALOG mode to SPDIF/RAW mode to SPDIF/PCM mode.

--- AUDIO SETUP ---

AUDIO OUT	LINE OUT
OP MODE	RF REMOD
DYNAMIC	
LPCM OUTPUT	
MAIN PAGE	

## OP MODE

There are two operating modes for the Dolby Digital decoder: LINE OUT and RF REMOD.

# SETUP

--- AUDIO SETUP ---

AUDIO OUT	
OP MODE	
DYNAMIC	
LPCM OUTPUT	
	FULL
	6/8
	4/8
	2/8
	OFF
MAIN PAGE	

## Dynamic Range Control

Select DRC and adjust the dynamic range of a Dolby Digital encoded program. There are 8 steps between full compression and off compression.

--- AUDIO SETUP ---

AUDIO OUT	
OP MODE	
DYNAMIC	
LPCM OUTPUT	LPCM 48K
	LPCM 96K
MAIN PAGE	

## LPCM OUTPUT

Select the LPCM OUTPUT between LPCM 48K and LPCM 96K.

## PREFERENCES SETUP

NOTE: Preferences can only be accessed while the background screen is visible.

--- PREFERENCES PAGE ---

TV TYPE	AUTO
AUDIO	NTSC
SUBTITLE	PAL
DISC MENU	
PARENTAL	
PASSWORD	
DEFAULTS	
SMART NAV	
MAIN PAGE	

## TV type setup

This player can play discs recorded in either PAL or NTSC format.

Select NTSC format, when you connected to NTSC TV.

Select PAL format, when you connected to PAL TV.

Select AUTO format, the player TV output format will according to the DVD disc format.

--- PREFERENCES PAGE ---

TV TYPE	
AUDIO	ENGLISH
SUBTITLE	FRENCH
DISC MENU	SPANISH
PARENTAL	CHINESE
PASSWORD	JAPANESE
DEFAULTS	
SMART NAV	
MAIN PAGE	

## AUDIO language setup

Select the preferred AUDIO soundtrack by using the cursor buttons.

# SETUP

--- PREFERENCES PAGE ---

TV TYPE	
AUDIO	
SUBTITLE	ENGLISH
DISC MENU	FRENCH
PARENTAL	SPANISH
PASSWORD	CHINESE
DEFAULTS	JAPANESE
SMART NAV	OFF
MAIN PAGE	

## SUBTITLE language setup

Select the preferred SUBTITLE language by using the cursor buttons.

--- PREFERENCES PAGE ---

TV TYPE	1 G
AUDIO	2
SUBTITLE	3 PG
DISC MENU	4 PG 13
PARENTAL	5
PASSWORD	6 PG-R
DEFAULTS	7 NC-17
SMART NAV	8 ADULT
MAIN PAGE	NO_PARENTAL

## PARENTAL

Select suitable parental guidance by the cursor buttons and conformed by pressing ENTER button.

--- PREFERENCES PAGE ---

TV TYPE	
AUDIO	
SUBTITLE	
DISC MENU	ENGLISH
PARENTAL	FRENCH
PASSWORD	SPANISH
DEFAULTS	CHINESE
SMART NAV	JAPANESE
MAIN PAGE	

## DISC MENU language setup

Select the preferred DISC MENU language by using the cursor buttons.

--- PREFERENCES PAGE ---

TV TYPE	
AUDIO	
SUBTITLE	
DISC MENU	
PARENTAL	
PASSWORD	CHANGE
DEFAULTS	
SMART NAV	
MAIN PAGE	

## PASSWORD

Select the change and press ENTER button. Type the old password (The initial factory code is 3308) and key in 4 characters password now you want to use, and retype again to confirm key in correctly.

# SETUP

--- PREFERENCES PAGE ---

TV TYPE
AUDIO
SUBTITLE
DISC MENU
PARENTAL
PASSWORD
DEFAULTS
SMART NAV
MAIN PAGE

**RESET**

## DEFAULTS

Select reset to become factory initial setting.

--- PREFERENCES PAGE ---

TV TYPE
AUDIO
SUBTITLE
DISC MENU
PARENTAL
PASSWORD
DEFAULTS
SMART NAV
MAIN PAGE

**NO MENU**  
**WITH MENU**

## SMART NAV

In this item, you can select NO MENU mode or WITH MENU mode.

## DEFAULTS TABLE

General Setup	TV Display	Normal/LB
	PIC Mode	AUTO
	Angle Mark	ON
	OSD Language	English
	Captions	ON
	SCR Saver	ON
Speaker Setup	Downmix	Stereo
Audio Setup	Audio Out	SPDIF/RAW
	OP Mode	Line Out
	Dynamic	FULL
	LPCM Output	LPCM 96K
Preferences	TV Type	AUTO
	Audio	English
	Subtitle	English
	DISC Menu	English
	Parental	NO Parental
	Password	3308
	Smart NAV	With Menu

# SPECIFICATIONS

---

Supply Voltage	: 12V DC (11V-15V), test voltage 14.4V, negative ground
Current Consumption	: Less than 2A
Signal System	: Compositive video 1.0Vp-p 75Ω
Discs Played	: (1) DVD-VIDEO Disc 5" (12 cm) single-sided, single-layer 5" (12 cm) single-sided, double-layer (2) Compact Disc (CD-DA, VIDEO CD) 5" (12cm) disc
Audio Output Level	: 600Ω (2 ch 2.0 Vrms)
Audio Signal Output Characteristics	: (1) Frequency Response 20 Hz - 20 KHz (2) S/N Ratio 90 dB (JIS) (3) Wow and Flutter Below measurable limits

**Note:**

Specifications and design are subject to modification, without notice, due to improvements in technology.

**This product incorporates copyright protection technology that is protected by method claims of certain U.S. patents and other intellectual property rights owned by Macrovision Corporation and other rights owners. Use of this copyright protection technology must be authorized by Macrovision Corporation, and is intended for home and other limited viewing uses only unless otherwise authorized by Macrovision Corporation. Reverse engineering or disassembly is prohibited.**

## Free Manuals Download Website

<http://myh66.com>

<http://usermanuals.us>

<http://www.somanuals.com>

<http://www.4manuals.cc>

<http://www.manual-lib.com>

<http://www.404manual.com>

<http://www.luxmanual.com>

<http://aubethermostatmanual.com>

Golf course search by state

<http://golfingnear.com>

Email search by domain

<http://emailbydomain.com>

Auto manuals search

<http://auto.somanuals.com>

TV manuals search

<http://tv.somanuals.com>