

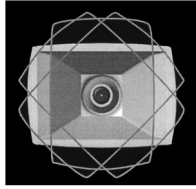

APX20TN, APX40TN
Constant-Directivity Paging Loudspeakers

INSTALLATION INSTRUCTIONS



ROTATING BELL

Lets you respond to specific coverage needs quickly in precise 15° increments.

EASY ACCESS & ADJUSTMENT

Includes security cap, partially-captive screws and swing-open access to terminal connections without losing hardware.

Screwdriver adjustable rotary dial adjusts power taps on the 25/70/100V transformer.

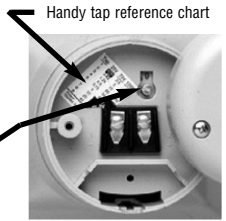

TRIPLE LOCK SECURITY

Loudspeaker quickly snap-locks to base to allow easy wiring connections, then secures with screws to withstand weather conditions and external forces that, traditionally, cause sagging or repositioning of the loudspeaker bell.

- ① Loudspeaker snap-locks to base sleeve
- ② Snap-lock Plastite® type screw secures assembly
- ③ Security cap screw-locks base between cap and speaker with (2) two screws

Multi-Purpose Base accepts 1-gang, 2-gang or 4" Sq. E.O. Boxes in recessed surface and indoor or outdoor styles.

The base may also be clamped or band mounted to poles or beams, removed for flush/bulk-head installation, or removed to retrofit existing speaker installations with AP Series Omni-Purpose® mount.

Cap and base have a K.O. for 1/2" flex conduit

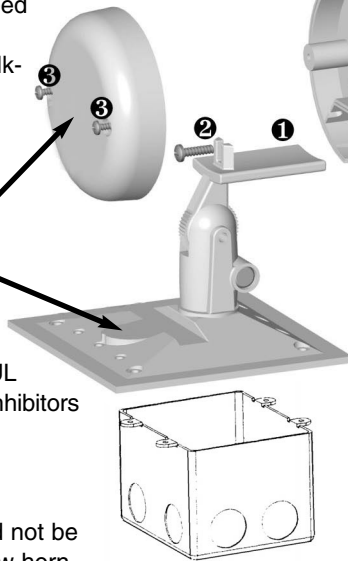

QUALITY MATERIALS

Enjoy long-term reliability of UL recognized plastics with UV inhibitors and a five-year warranty.

DRIVER PROTECTION:

The horn loudspeaker should not be operated at frequencies below horn cut-off. It is suggested that any program material be high-passed at 400Hz with a 6dB per octave filter. This can be done by a low level filter at the amplifier input or by a series capacitor at each loudspeaker. Electrolytic capacitors can be used but they must be non-polarized.

"POWER STRIPE" CODE

Lets you identify power handling at a distance.

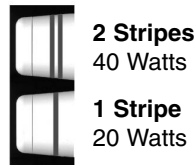

Wiring Exit
(Can be enlarged using needle-nosed pliers)

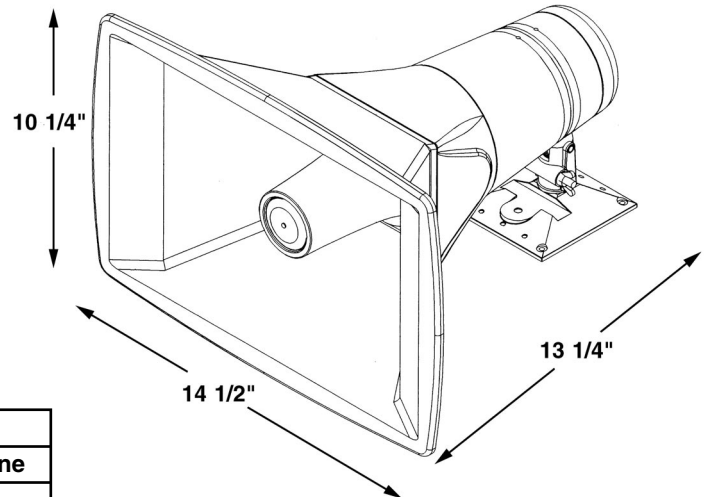

TYPICAL CAPACITOR VALUES

8 Ohm Driver	25Volt Line	70Volt line	100Volt Line
70 mfd	15 mfd	2 mfd	1 mfd

Specifications are subject to change without notice

www.AtlasSound.com

1601 JACK MCKAY BOULEVARD ENNIS, TEXAS 75119 U.S.A. • TELEPHONE: (800) 876-3333 • FAX: (800) 765-3435

© 2003 ATLAS SOUND LP

Printed in U.S.A.

00803

ATS000706 RevC 8/03

PN 416689



INSTALLATION MADE EASY

INSTALLATION INSTRUCTIONS

1. REMOVE BRACKET, END CAP AND HORN FROM CONTAINER.

2. DETERMINE MOUNTING REQUIREMENTS:

NOTE! It is the installer's responsibility to mount the product in a safe manner. When selecting a mounting location, make sure that the location and mounting method will support the weight of the loudspeaker. Additionally, take into consideration other factors such as wind, vibration, snow/ice accumulation, etc. to eliminate the possibility of injury or property damage.

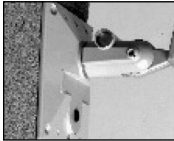

WALL MOUNT

Attach base directly to wall via (4) holes provided in base using screws provided or suitable strength fasteners.



STRAP OR CLAMP MOUNT TO A POLE OR BEAM

Attach base directly to pole or beam via a 1/2" hose clamp or suitable banding strap. A beam clamp may also be utilized with the APX base. Make sure that the strap, banding or clamp is correct for the application environment.

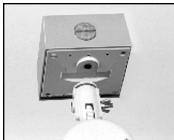

SINGLE GANG, TWO GANG OR 4" SQ. E.O. BOX MOUNT

Using a box screw (#6) or a nail, align center 2 knock out holes (4 on 2 gang) in base and knock out holes with hammer. Pull speaker wire through rubber grommet in base. Attach base through 2 center knocked out holes (4 outer holes on 2 gang box).



EXTERIOR BOX WITH FLEXIBLE CONDUIT

Using a hammer and a box screw (#6) or a nail, knock out holes in base. Knock out 1/2" K.O. in base plus the back cap with hammer and screwdriver or pliers. Attach BX adapters and flex conduit to base and backcap. Place gasket on box (not provided). Pull speaker wire through box gasket, base and flex conduit.

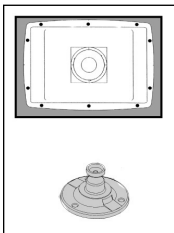

FLUSH/BULKHEAD STYLE MOUNTING

Cutout size of the loudspeaker is 13 1/8" x 8 5/8". K.O.'s are 1/4" holes.

NOTE! In retrofit applications, if you are replacing Atlas Sound AP Series speakers, you may use the existing AP bracket for the APX Series. Simply unscrew wing nut on the APX to remove base and mount to AP bracket. (if color match AP base is desired, order XS8200601)

3. TO SET POWER TAPS, ROTATE SWITCH WITH FLAT BLADE SCREWDRIVER TO DESIRED POWER OR IMPEDANCE.

Tap	25V	70V	100V
1	1.25	2.5	
2	0.63	5	10
3	1.25	10	20
4	1.88	15	
5	2.5	20	
6	5		
7	10		
8	10		
9	20		

Tap	25V	70V	100V
1	2.5	5	
2	0.63	5	10
3	1.25	10	20
4	2.5	20	40
5	3.75	30	
6	5	40	
7	10		
8	20		
9	40		



4. SLIDE LOUDSPEAKER ONTO BASE SLEEVE UNTIL IT SNAP-LOCKS. INSERT AND TIGHTEN BASE SLEEVE SCREW TO DOUBLE LOCK SPEAKER TO BASE.

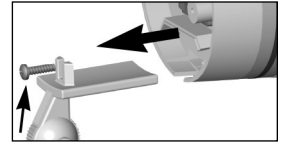

NOTE! To remove speaker from snap-lock-base sleeve, first remove base sleeve screw. Then insert screwdriver in opening under sleeve and gently pry snap lock up to remove base sleeve.

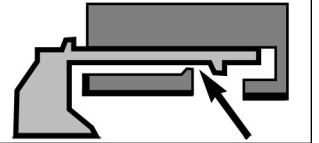

5. FEED HOOK UP WIRES TO UNIT AND WRAP AROUND CAP SCREWPOSTS AND/OR THE WIRE BARRIER BRACKET FOR STRAIN-RELIEF.

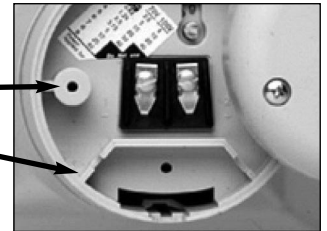

6. ATTACH WIRE TO SCREW TERMINALS AND SECURE CAP WITH TWO PARTIALLY CAPTIVE SCREWS. THIS STEP "TRIPLE LOCKS" THE LOUDSPEAKER TO THE BASE.

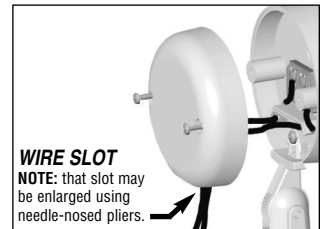

WIRE SLOT
NOTE: that slot may be enlarged using needle-nosed pliers.

NOTE! For wiring adjustments, back-out the right screw on the security cap more than the left screw to provide swing-open access!

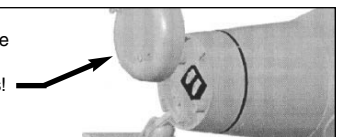

7. AIM HORN IN THE APPROPRIATE DIRECTION AND LOCK INTO PLACE BY TIGHTENING WINGNUT ON BASE ASSEMBLY.

8. ROTATE BELL (if needed)

Loosen the tip assembly in horn bell by turning 1/2 turn counter clockwise, rotate bell to position (in 15° increments) and lock back in place by turning tip back 1/2 turn clockwise.

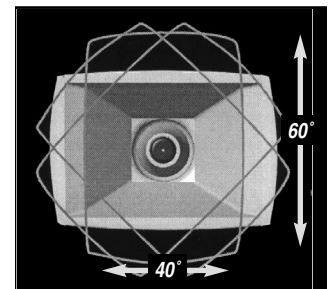

Specifications are subject to change without notice



www.AtlasSound.com

1601 JACK MCKAY BOULEVARD ENNIS, TEXAS 75119 U.S.A. • TELEPHONE: (800) 876-3333 • FAX: (800) 765-3435

© 2003 ATLAS SOUND LP

Printed in U.S.A.

00803

ATS000706 RevC 8/03

PN 416689

Free Manuals Download Website

<http://myh66.com>

<http://usermanuals.us>

<http://www.somanuals.com>

<http://www.4manuals.cc>

<http://www.manual-lib.com>

<http://www.404manual.com>

<http://www.luxmanual.com>

<http://aubethermostatmanual.com>

Golf course search by state

<http://golfingnear.com>

Email search by domain

<http://emailbydomain.com>

Auto manuals search

<http://auto.somanuals.com>

TV manuals search

<http://tv.somanuals.com>