



# **RS500A-E6 / PS4**

## *1U Rackmount Server*

### *User Guide*



E6164

Second Edition V2

October 2010

**Copyright © 2010 ASUSTeK COMPUTER INC. All Rights Reserved.**

No part of this manual, including the products and software described in it, may be reproduced, transmitted, transcribed, stored in a retrieval system, or translated into any language in any form or by any means, except documentation kept by the purchaser for backup purposes, without the express written permission of ASUSTeK COMPUTER INC. ("ASUS").

ASUS provides this manual "as is" without warranty of any kind, either express or implied, including but not limited to the implied warranties or conditions of merchantability or fitness for a particular purpose. In no event shall ASUS, its directors, officers, employees, or agents be liable for any indirect, special, incidental, or consequential damages (including damages for loss of profits, loss of business, loss of use or data, interruption of business and the like), even if ASUS has been advised of the possibility of such damages arising from any defect or error in this manual or product.

Specifications and information contained in this manual are furnished for informational use only, and are subject to change at any time without notice, and should not be construed as a commitment by ASUS. ASUS assumes no responsibility or liability for any errors or inaccuracies that may appear in this manual, including the products and software described in it.

Product warranty or service will not be extended if: (1) the product is repaired, modified or altered, unless such repair, modification or alteration is authorized in writing by ASUS; or (2) the serial number of the product is defaced or missing.

Products and corporate names appearing in this manual may or may not be registered trademarks or copyrights of their respective companies, and are used only for identification or explanation and to the owners' benefit, without intent to infringe.

# Contents

Contents .....	iii
Notices .....	vii
Safety information .....	viii
About this guide .....	ix

## Chapter 1: Product introduction

1.1	System package contents .....	1-2
1.2	Serial number label .....	1-2
1.3	System specifications .....	1-3
1.4	Front panel features.....	1-5
1.5	Rear panel features.....	1-5
1.6	Internal features .....	1-6
1.7	LED information .....	1-7
1.7.1	Front panel LEDs .....	1-7
1.7.2	LAN (RJ-45) LEDs .....	1-7
1.7.3	HDD status LED.....	1-8

## Chapter 2: Hardware setup

2.1	Chassis cover.....	2-2
2.2	Central Processing Unit (CPU) .....	2-3
2.2.1	Installing the CPU .....	2-3
2.2.2	Installing the CPU heatsink and airduct .....	2-6
2.3	System memory .....	2-7
2.3.1	Overview .....	2-7
2.3.2	Memory Configurations .....	2-7
2.3.3	Installing a DIMM .....	2-9
2.3.4	Removing a DIMM .....	2-9
2.4	Hard disk drives .....	2-10
2.5	Expansion slot.....	2-12
2.5.1	Installing an expansion card to the riser card bracket... 2-12	
2.5.2	Configuring an expansion card .....	2-14
2.6	Cable connections .....	2-15
2.7	SATAII/SAS backplane cabling .....	2-16
2.8	Removable/optional components.....	2-17
2.8.1	System fans .....	2-17

# Contents

- 2.8.2 Installing ASUS PIKE RAID card (optional) ..... 2-18
- 2.8.3 Installing ASMB4 series management board (optional)... 2-22

## Chapter 3: Installation options

- 3.1 Installing friction rail kit items ..... 3-2**
  - 3.1.1 Attaching the fixing latches to the server ..... 3-2
  - 3.1.2 Attaching the rack rails..... 3-3
  - 3.1.3 Mounting the server to the rack ..... 3-4
- 3.2 Installing optional ball-bearing rail kit items ..... 3-5**
  - 3.2.1 Attaching the rails to the server ..... 3-5
  - 3.2.2 Attaching the rack rails..... 3-6
  - 3.2.3 Mounting the server to the rack ..... 3-7

## Chapter 4: Motherboard information

- 4.1 Motherboard layouts..... 4-2**
- 4.2 Jumpers ..... 4-4**
- 4.3 Internal connectors..... 4-8**

## Chapter 5: BIOS setup

- 5.1 Managing and updating your BIOS ..... 5-2**
  - 5.1.1 ASUS EZ Flash 2 utility..... 5-2
  - 5.1.2 BUPDATER utility..... 5-3
  - 5.1.3 ASUS CrashFree BIOS 3 utility ..... 5-5
- 5.2 BIOS setup program ..... 5-6**
  - 5.2.1 BIOS menu screen..... 5-7
  - 5.2.2 Menu bar..... 5-7
  - 5.2.3 Navigation keys..... 5-7
  - 5.2.4 Menu items ..... 5-8
  - 5.2.5 Submenu items ..... 5-8
  - 5.2.6 Configuration fields ..... 5-8
  - 5.2.7 Pop-up window ..... 5-8
  - 5.2.8 Scroll bar..... 5-8
  - 5.2.9 General help ..... 5-8
- 5.3 Main menu ..... 5-9**
  - 5.3.1 System Time [xx:xx:xx] ..... 5-9
  - 5.3.2 System Date [Day xx/xx/xxxx]..... 5-9
  - 5.3.3 SATA1–6 ..... 5-10

# Contents

5.3.4	Storage Configuration .....	5-11
5.3.5	System Information .....	5-12
<b>5.4</b>	<b>Advanced menu .....</b>	<b>5-14</b>
5.4.1	CPU Configuration .....	5-14
5.4.2	Chipset Configuration .....	5-16
5.4.3	Onboard Devices Configuration .....	5-25
5.4.4	USB Configuration .....	5-26
5.4.5	PCI/PnP .....	5-27
<b>5.5</b>	<b>Server menu .....</b>	<b>5-28</b>
<b>5.6</b>	<b>Power menu.....</b>	<b>5-30</b>
5.6.1	Suspend Mode [Auto] .....	5-30
5.6.2	Repost Video on S3 Resume [No] .....	5-30
5.6.3	ACPI 2.0 Support [ACPI v2.0] .....	5-30
5.6.4	ACPI APIC support [Enabled] .....	5-30
5.6.5	APM Configuration .....	5-31
5.6.6	Hardware Monitor .....	5-32
<b>5.7</b>	<b>Boot menu .....</b>	<b>5-34</b>
5.7.1	Boot Device Priority .....	5-34
5.7.2	Hard Disk Drives; CDROM Drives .....	5-34
5.7.3	Boot Settings Configuration .....	5-35
5.7.4	Security .....	5-36
<b>5.8</b>	<b>Tools menu .....</b>	<b>5-38</b>
5.8.1	ASUS EZ Flash 2.....	5-38
<b>5.9</b>	<b>Exit menu.....</b>	<b>5-39</b>
 <b>Chapter 6: RAID configuration</b>		
<b>6.1</b>	<b>Setting up RAID.....</b>	<b>6-2</b>
6.1.1	RAID definitions .....	6-2
6.1.2	Installing hard disk drives.....	6-3
6.1.3	Setting the RAID item in BIOS .....	6-3
<b>6.2</b>	<b>FastBuild Utility.....</b>	<b>6-4</b>
6.2.1	Creating a RAID set (RAID 0, RAID 1, RAID 10, RAID 5, SPAN or JBOD) .....	6-5
6.2.2	Deleting a RAID set .....	6-11
6.2.3	Viewing the Drive Assignment.....	6-13
6.2.4	Viewing the Controller Configuration.....	6-14

# Contents

## Chapter 7: Driver installation

<b>7.1</b>	<b>RAID driver installation .....</b>	<b>7-2</b>
7.1.1	Creating a RAID driver disk .....	7-2
7.1.2	Installing the RAID controller driver .....	7-4
<b>7.2</b>	<b>AMD® processor driver installation .....</b>	<b>7-14</b>
<b>7.3</b>	<b>LAN driver installation.....</b>	<b>7-15</b>
<b>7.4</b>	<b>Display driver installation .....</b>	<b>7-19</b>
<b>7.5</b>	<b>ATI SM Bus controller driver installation.....</b>	<b>7-22</b>
<b>7.6</b>	<b>Management applications and utilities installation .....</b>	<b>7-23</b>
7.6.1	Running the support DVD .....	7-23
7.6.2	Drivers menu.....	7-23
7.6.3	Utilities menu .....	7-24
7.6.4	Make disk menu.....	7-24
7.6.5	Contact information.....	7-24

# Notices

## Federal Communications Commission Statement

This device complies with Part 15 of the FCC Rules. Operation is subject to the following two conditions:

- This device may not cause harmful interference, and
- This device must accept any interference received including interference that may cause undesired operation.

This equipment has been tested and found to comply with the limits for a Class A digital device, pursuant to Part 15 of the FCC Rules. These limits are designed to provide reasonable protection against harmful interference in a residential installation. This equipment generates, uses and can radiate radio frequency energy and, if not installed and used in accordance with manufacturer's instructions, may cause harmful interference to radio communications. However, there is no guarantee that interference will not occur in a particular installation. If this equipment does cause harmful interference to radio or television reception, which can be determined by turning the equipment off and on, the user is encouraged to try to correct the interference by one or more of the following measures:

- Reorient or relocate the receiving antenna.
- Increase the separation between the equipment and receiver.
- Connect the equipment to an outlet on a circuit different from that to which the receiver is connected.
- Consult the dealer or an experienced radio/TV technician for help.



---

**WARNING!** The use of shielded cables for connection of the monitor to the graphics card is required to assure compliance with FCC regulations. Changes or modifications to this unit not expressly approved by the party responsible for compliance could void the user's authority to operate this equipment.

---

## Canadian Department of Communications Statement

This digital apparatus does not exceed the Class A limits for radio noise emissions from digital apparatus set out in the Radio Interference Regulations of the Canadian Department of Communications.

This Class A digital apparatus complies with Canadian ICES-003.

## REACH Information

Complying with the REACH (Registration, Evaluation, Authorization, and Restriction of Chemicals) regulatory framework, we publish the chemical substances in our products at ASUS REACH website at <http://csr.asus.com/english/REACH.htm>.

# Safety information

## Electrical Safety

- Before installing or removing signal cables, ensure that the power cables for the system unit and all attached devices are unplugged.
- To prevent electrical shock hazard, disconnect the power cable from the electrical outlet before relocating the system.
- When adding or removing any additional devices to or from the system, ensure that the power cables for the devices are unplugged before the signal cables are connected. If possible, disconnect all power cables from the existing system before you add a device.
- If the power supply is broken, do not try to fix it by yourself. Contact a qualified service technician or your dealer.

## Operation Safety

- Any mechanical operation on this server must be conducted by certified or experienced engineers.
- Before operating the server, carefully read all the manuals included with the server package.
- Before using the server, ensure all cables are correctly connected and the power cables are not damaged. If any damage is detected, contact your dealer as soon as possible.
- To avoid short circuits, keep paper clips, screws, and staples away from connectors, slots, sockets and circuitry.
- Avoid dust, humidity, and temperature extremes. Place the server on a stable surface.



---

This product is equipped with a three-wire power cable and plug for the user's safety. Use the power cable with a properly grounded electrical outlet to avoid electrical shock.

---

### Lithium-Ion Battery Warning

**CAUTION!** Danger of explosion if battery is incorrectly replaced. Replace only with the same or equivalent type recommended by the manufacturer. Dispose of used batteries according to the manufacturer's instructions.

### CD-ROM Drive Safety Warning

**CLASS 1 LASER PRODUCT**

### Heavy System

**CAUTION!** This server system is heavy. Ask for assistance when moving or carrying the system.





---

**DO NOT** throw the motherboard in municipal waste. This product has been designed to enable proper reuse of parts and recycling. This symbol of the crossed out wheeled bin indicates that the product (electrical and electronic equipment) should not be placed in municipal waste. Check local regulations for disposal of electronic products.

---



---

**DO NOT** throw the mercury-containing button cell battery in municipal waste. This symbol of the crossed out wheeled bin indicates that the battery should not be placed in municipal waste.

---

## About this guide

### Audience

This user guide is intended for system integrators, and experienced users with at least basic knowledge of configuring a server.

### Contents

This guide contains the following parts:

**1. Chapter 1: Product introduction**

This chapter describes the general features of the server, including sections on front panel and rear panel specifications.

**2. Chapter 2: Hardware setup**

This chapter lists the hardware setup procedures that you have to perform when installing or removing system components.

**3. Chapter 3: Installation options**

This chapter describes how to install optional components into the barebone server.

**4. Chapter 4: Motherboard information**

This chapter gives information about the motherboard that comes with the server. This chapter includes the motherboard layout, jumper settings, and connector locations.

**5. Chapter 5: BIOS information**

This chapter tells how to change system settings through the BIOS Setup menus and describes the BIOS parameters.

**6. Chapter 6: RAID configuration**

This chapter tells how to change system settings through the BIOS Setup menus. Detailed descriptions of the BIOS parameters are also provided.

**7. Chapter 7: Driver installation**

This chapter provides instructions for installing the necessary drivers for different system components.

## Conventions

To ensure that you perform certain tasks properly, take note of the following symbols used throughout this manual.



**DANGER/WARNING:** Information to prevent injury to yourself when trying to complete a task.



**CAUTION:** Information to prevent damage to the components when trying to complete a task.



**IMPORTANT:** Instructions that you **MUST** follow to complete a task.



**NOTE:** Tips and additional information to help you complete a task.

## Typography

### **Bold text**

Indicates a menu or an item to select.

### *Italics*

Used to emphasize a word or a phrase.

### <Key>

Keys enclosed in the less-than and greater-than sign means that you must press the enclosed key.

Example: <Enter> means that you must press the Enter or Return key.

### <Key1+Key2+Key3>

If you must press two or more keys simultaneously, the key names are linked with a plus sign (+).

Example: <Ctrl+Alt+D>

### **Command**

Means that you must type the command exactly as shown, then supply the required item or value enclosed in brackets.

Example: At the DOS prompt, type the command line: **format A:/S**

## References

Refer to the following sources for additional information, and for product and software updates.

### 1. **ASUS Server Web-based Management (ASWM) user guide**

This manual tells how to set up and use the proprietary ASUS server management utility.

### 2. **ASUS websites**

The ASUS websites worldwide provide updated information for all ASUS hardware and software products. Refer to the ASUS contact information.

# Chapter 1

This chapter describes the general features of the chassis kit. It includes sections on front panel and rear panel specifications.

# Product introduction

## 1.1 System package contents

Check your system package for the following items.

Model Name	RS500A-E6/PS4
Chassis	ASUS R10A 1U Rackmount Chassis
Motherboard	ASUS KGNE-D16 Server Board
Component	1 x 500W 80+ Single Power Supply 4 x Hot-swap 3.5" HDD trays (varies by territories) 1 x SAS/SATAII HDD Backplane (BP4LX-R10A) 1 x PCI Riser Card (RE16L-R10) 1 x Front I/O Shield (FPB-AR14) 5 x System Fans (40 x 56mm) 1 x Air Duct
Accessories	1 x RS500A-E6/PS4 User Guide 1 x ASUS ASWM 2.0 User Guide 1 x RS500A-E6/PS4 Support CD (including ASWM*) 1 x Bag of Screws 1 x AC Power Cable 1 x Friction Rail Kit
Optional Items	2 x CPU Heatsinks (varies by territories) 1 x Slim-type Optical Device 1 x ASMB4-iKVM Remote Management Card 1 x PIKE RAID Card 1 x Anti-virus CD 1 x Semi-ball Bearing Rail Kit

### \*ASUS System Web-based Management



If any of the above items is damaged or missing, contact your retailer.

## 1.2 Serial number label

Before requesting support from the ASUS Technical Support team, you must take note of the product's serial number containing 12 characters such as xxS0xxxxxxx. See the figure below.

With the correct serial number of the product, ASUS Technical Support team members can then offer a quicker and satisfying solution to your problems.



## 1.3 System specifications

The ASUS RS500A-E6/PS4 is a server featuring the ASUS KGNE-D16 server board. The server supports AMD® LGA 1944 Opteron™ 6100 series processors with HyperTransport™ technology, plus other latest technologies through the chipsets onboard.

<b>Processor Support / System Bus</b>		2 x Socket G34 (LGA 1944)
		8/12 Core AMD® Opteron™ 6100 Series (ACP<=80W) HyperTransport™ Technology 3.0, 6.4 GT/s per link (triple link)
<b>Core Logic</b>		AMD® SR5650 AMD® SP5100
<b>Memory</b>	Total Slots	16 (4-channel per CPU)
	Capacity	Maximum up to 256GB (RDIMM) Maximum up to 64GB (UDIMM)
	Memory Type	DDR3 800/1066/1333 UDIMM with ECC / non ECC DDR3 800/1066/1333 RDIMM
	Memory Size	1GB, 2GB, 4GB, 8GB, 16GB (RDIMM) 1GB, 2GB, 4GB (UDIMM)
<b>Expansion Slots</b>	Total PCI/PCI-X/ PCI-E Slots	1
	Slot Type	<b>Default Riser Card:</b> 1 x PCI-E G2 x16 slot (G2 x16 link) (Full-Height/ Half-Length)
	Additional Slot	1 x PIKE Slot for Storage Enhancement
<b>Storage</b>	SATA Controller	<b>AMD® SP5100:</b> 6 x SATA2 300MB/s ports <b>PROMISE® SW RAID (For Linux/Windows)</b> Supports software RAID 0, 1, 10 & 5
	SAS Controller	<b>Optional:</b> ASUS PIKE 1064E 4-port SAS RAID card ASUS PIKE 1078 8-port SAS HW RAID card ASUS PIKE 2008 8-port SAS2 6G RAID card ASUS PIKE 2008/IMR 8-port SAS2 6G RAID card
<b>HDD Bays</b>	I = Internal A or S will be hot-swappable	4 x Hot-Swap 3.5" SAS/SATA2 HDD Bays
<b>Networking</b>	LAN	2 x Intel® PCI-E GbE LAN (82574L) 1 x Mgmt LAN
<b>Graphic</b>	VGA	Aspeed AST2050 8MB

(continued on the next page)

<b>Auxiliary Storage CD / DVD</b>		1 x Slim-type Optical Device Bay (Options: No Device / DVD-RW)
<b>Onboard I/O</b>		3 x RJ-45 ports (One for ASMB4-iKVM) 4 x USB 2.0 ports (Front x 2, Rear x 2) 1 x External Serial Port 1 x VGA port 1 x PS/2 keyboard port 1 x PS/2 mouse port 1 x Internal A Type USB port
<b>OS Support</b>		Windows® Server 2008 R2 Windows® Server 2008 Enterprise 32/64-bit Windows® Server 2003 R2 Enterprise 32/64-bit RedHat® Enterprise Linux AS5.0 32/64-bit SuSE® Linux Enterprise Server 10 32/64-bit (Subject to change without any notice)
<b>Anti-virus Software</b>		Optional CA® eTrust™ 7.1 anti-virus software
<b>Management Solution</b>	<b>Software</b>	ASWM 2.0
	<b>Out of Band Remote Management</b>	Optional ASMB4-iKVM for KVM-over-IP support
<b>Dimension (HH x WW x DD)</b>		615mm x 444mm x 43.6mm (1U)
<b>Net Weight Kg (CPU, DRAM &amp; HDD not included)</b>		15 Kg
<b>Power Supply</b>		500W 80+ Single Power Supply (Gold Level)
<b>Environment</b>		Operation temperature: 10°C — 35°C / Non operation temperature: -40°C — 70°C Non operation humidity: 20% — 90% (Non-condensing)

\*Specifications are subject to change without notice.

## 1.4 Front panel features

The barebone server displays a simple yet stylish front panel with easily accessible features. The power and reset buttons, LED indicators, optical drive, and two USB ports are located on the front panel.



Refer to section 1.7.1 **Front panel LEDs** for the LED descriptions.

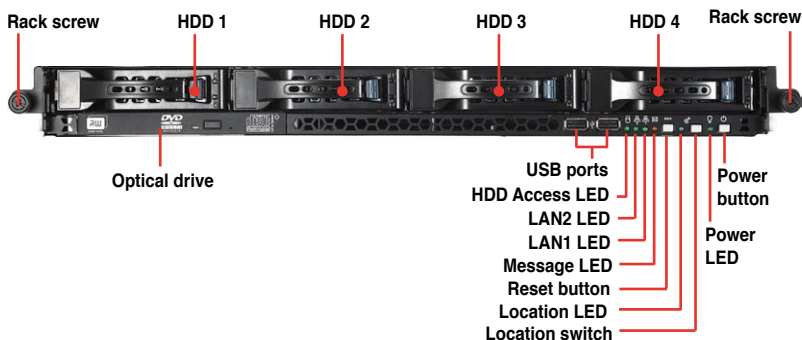

## 1.5 Rear panel features

The rear panel includes the expansion slots, system power socket, and rear fans. The middle part includes the I/O shield with openings for the rear panel connectors on the motherboard.

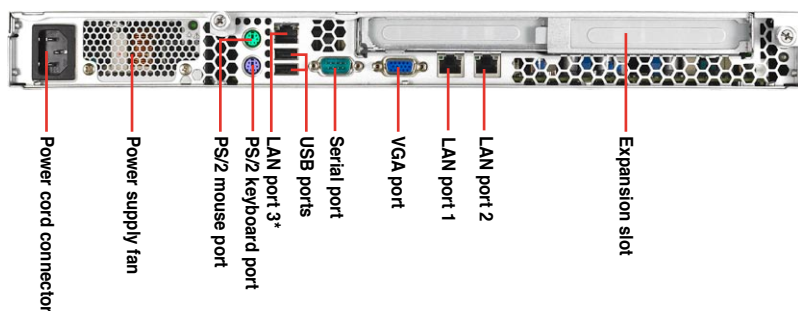

- The ports for the PS/2 keyboard, PS/2 mouse, USB, VGA, and Gigabit LAN do not appear on the rear panel if motherboard is not present.
- \*The port is for ASUS ASMB4-iKVM controller card only.

## 1.6 Internal features

The barebone server includes the basic components as shown.

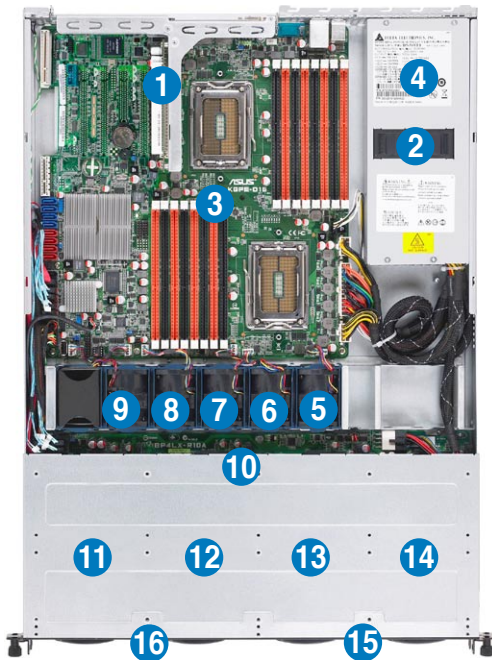

1. PCI Express G2 x16 slot Riser Card (G2 x16 link)
2. Power fans
3. ASUS KGNE-D16 server board
4. Power supply
5. System fan 1\* - Connects to CPU\_FAN2 connector
6. System fan 2\* - Connects to FRNT\_FAN1 connector
7. System fan 3\* - Connects to FRNT\_FAN2 connector
8. System fan 4\* - Connects to FRNT\_FAN3 connector
9. System fan 5\* - Connects to FRNT\_FAN4 connector

10. SAS/SATAII backplane
11. Hot-Swap HDD tray 1 - Connects to SATA1 port (Port 0)
12. Hot-Swap HDD tray 2 - Connects to SATA2 port (Port 1)
13. Hot-Swap HDD tray 3 - Connects to SATA3 port (Port 2)
14. Hot-Swap HDD tray 4 - Connects to SATA4 port (Port 3)
15. Front I/O board (hidden)
16. Slim-type optical drive



The barebone server does not include a floppy disk drive. Connect a USB floppy disk drive to any of the USB ports on the front or rear panel if you need to use a floppy disk.

**\*WARNING**  
**HAZARDOUS MOVING PARTS**  
**KEEP FINGERS AND OTHER BODY PARTS AWAY**



## 1.7 LED information

### 1.7.1 Front panel LEDs

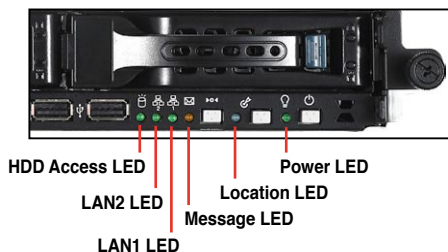

LED	Icon	Display status	Description
Power LED		ON	System power ON
HDD Access LED		OFF Blinking	No activity Read/write data into the HDD
Message LED		OFF Blinking	System is normal; no incoming event ASWM indicates a HW monitor event
Location LED		OFF ON	Normal status Location switch is pressed (Press the location switch again to turn off)
LAN LEDs		OFF Blinking ON	No LAN connection LAN is transmitting or receiving data LAN connection is present



The Message LED functions only when you install the optional ASMB4-iKVM server management board. Contact the local sales or dealer for detailed information on purchasing the server management board.

### 1.7.2 LAN (RJ-45) LEDs

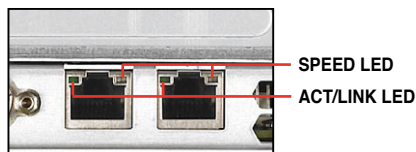

ACT/LINK LED		SPEED LED	
Status	Description	Status	Description
OFF	No link	OFF	10 Mbps connection
GREEN	Linked	ORANGE	100 Mbps connection
BLINKING	Data activity	GREEN	1 Gbps connection

### 1.7.3 HDD status LED

HDD status LED

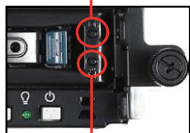

HDD Activity LED

SATAII/SAS HDD LED Description			
HDD Status LED	GREEN	ON	SATAII/SAS HDD power ON
	RED*	ON	HDD has failed and should be swapped immediately
	GREEN/ RED*	Blinking	RAID rebuilding
HDD Activity LED	GREEN	Blinking	Read/write data from/into the SATAII/SAS HDD



\*The LED status functions only when you install the optional PIKE RAID card.

# Chapter 2

This chapter lists the hardware setup procedures that you have to perform when installing or removing system components.

# Hardware setup

## 2.1 Chassis cover

### Removing the rear cover

1. Loosen the two thumbscrews on the rear panel to release the rear cover from the chassis.

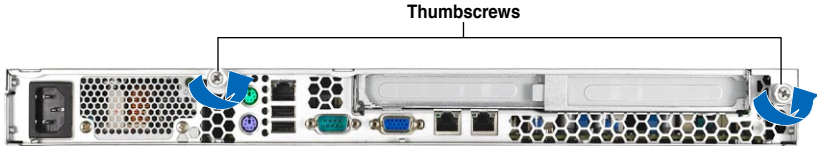

2. Firmly hold the cover and slide it toward the rear panel for about half an inch until it is disengaged from the chassis.

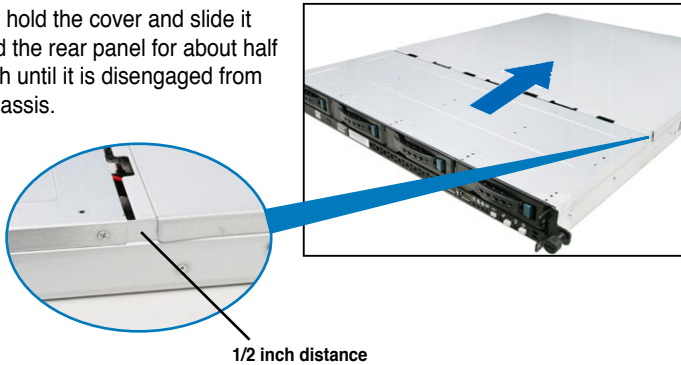

3. Lift the cover from the chassis.

## 2.2 Central Processing Unit (CPU)

The motherboard comes with dual surface mount LGA 1944 Socket designed for the AMD® Opteron™ 6100 series CPU in the Land Grid Array (LGA) package.



- Upon purchase of the motherboard, ensure that the PnP cap is on the socket and the socket contacts are not bent. Contact your retailer immediately if the PnP cap is missing, or if you see any damage to the PnP cap/socket contacts/motherboard components. ASUS shoulders the repair cost only if the damage is shipment/transit-related.
- Keep the cap after installing the motherboard. ASUS will process Return Merchandise Authorization (RMA) requests only if the motherboard comes with the cap on the Socket 1944.
- The product warranty does not cover damage to the socket contacts resulting from incorrect CPU installation/removal, or misplacement/loss/incorrect removal of the PnP cap.

### 2.2.1 Installing the CPU

To install a CPU:

1. Locate the CPU socket on the motherboard.

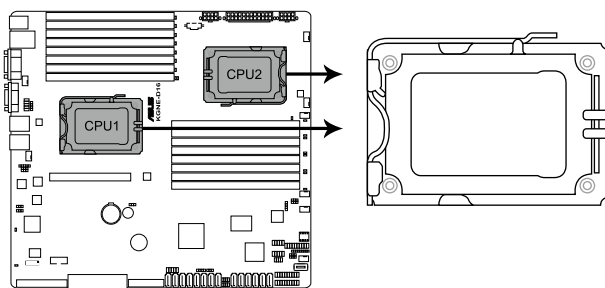

**KGNE-D16 CPU LGA1944 Socket**



Before installing the CPU, ensure that the socket box is facing toward you and the load lever is on your left.

2. Press the load lever with your thumb (A), then move it to the left (B) until it is released from the retention tab.



To prevent damage to the socket pins, do not remove the PnP cap unless you are installing a CPU.

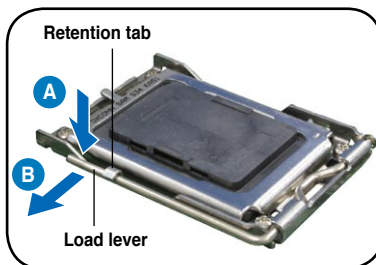

3. Lift the load lever in the direction of the arrow to a 135° angle.
4. Lift the load plate with your thumb and forefinger to a 100° angle.
5. Remove the PnP cap from the CPU socket.

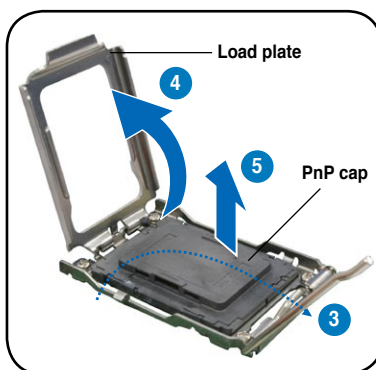

6. Position the CPU over the socket, ensuring that the gold triangle is on the bottom-right corner of the socket, and then fit the socket alignment key into the CPU notch.



The CPU fits in only one correct orientation. DO NOT force the CPU into the socket to prevent bending the connectors on the socket and damaging the CPU!

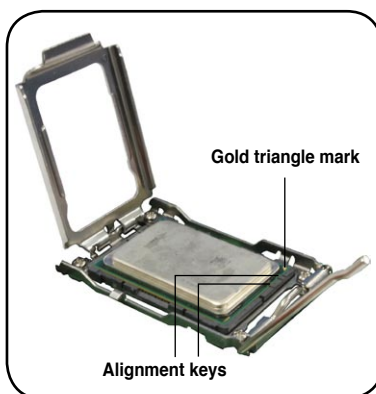

7. Close the load plate (A), then push the load lever (B) until it snaps into the retention tab.

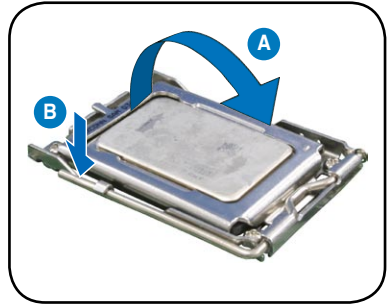

---

Apply some Thermal Interface Material to the exposed area of the CPU that the heatsink will be in contact with, ensuring that it is spread in an even thin layer. Some heatsinks come with pre-applied Thermal Interface Material. If so, skip this step.

---

## 2.2.2 Installing the CPU heatsink and airduct

To install the CPU heatsink:

1. Place the heatsink on top of the installed CPU, ensuring that the two fasteners match the holes on the motherboard.

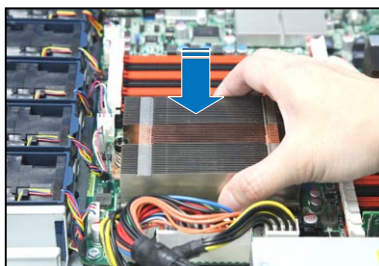

2. Twist each of the two screws with a Philips (cross) screwdriver just enough to attach the heatsink to the motherboard. When the two screws are attached, tighten them one by one to completely secure the heatsink.

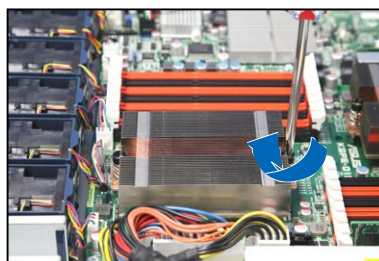

To install the airduct:

1. Position the airduct on top of the heatsink.
2. Carefully lower the airduct until it fits in place.

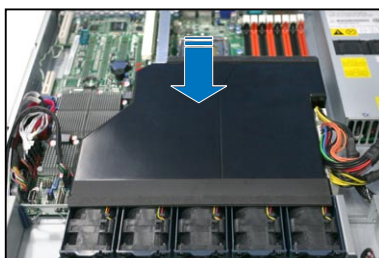



## 2.3 System memory

### 2.3.1 Overview

The motherboard comes with sixteen (16) Double Data Rate 3 (DDR3) Dual Inline Memory Modules (DIMM) sockets.

The figure illustrates the location of the DDR3 DIMM sockets:

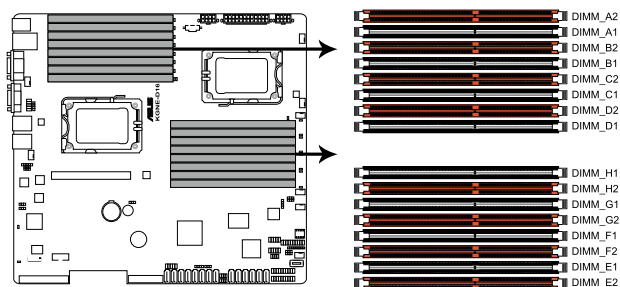

KGNE-D16 240-pin DDR3 DIMM sockets

### 2.3.2 Memory Configurations

You may install 1GB/2GB/4GB/8GB/16GB Registered or 1GB/2GB/4GB Unbuffered with ECC/Non-ECC DDR3 DIMMs into the DIMM sockets using the memory configurations in this section.



- Always install DIMMs with the same CAS latency. For optimum compatibility, it is recommended that you obtain memory modules from the same vendor.
- For CPU1 configuraton, install DIMMs from the orange slots and in the order as follows: DIMM\_A2 -> DIMM\_C2 -> DIMM\_B2 -> DIMM\_D2.  
For CPU1 + CPU2 configuraton, install DIMMs from the orange slots and in the order as follows: DIMM\_A2 -> DIMM\_E2 -> DIMM\_C2 -> DIMM\_G2.
- **For Quad Ranks DIMMs, when installing less than or equal to four DIMMs:**  
For CPU1 configuration, install DIMMs to the orange slots and in the order as follows: DIMM\_A2 -> DIMM\_C2 -> DIMM\_B2 -> DIMM\_D2.  
For CPU1 + CPU2 configuration, install DIMMs to the orange slots and in the order as follows: DIMM\_A2 -> DIMM\_E2 -> DIMM\_C2 -> DIMM\_G2.
- **For Quad Ranks DIMMs, when installing more than four DIMMs:**  
For CPU1 configuration, install DIMMs in the order as follows: DIMM\_A2 -> DIMM\_C2 -> DIMM\_B2 -> DIMM\_D2 -> DIMM\_A1 -> DIMM\_C1 -> DIMM\_B1 -> DIMM\_D1.  
For CPU1 + CPU2 configuration, install DIMMs in the order as follows: DIMM\_A2 -> DIMM\_E2 -> DIMM\_C2 -> DIMM\_G2 -> DIMM\_B2 -> DIMM\_F2 -> DIMM\_D2 -> DIMM\_H2 -> DIMM\_A1 -> DIMM\_E1 -> DIMM\_C1 -> DIMM\_G1 -> DIMM\_B1 -> DIMM\_F1 -> DIMM\_D1 -> DIMM\_H1.

## Memory population table

*For UDIMM (Single Rank, Dual Ranks)*

CPU1 Configuration																
	A2	A1	B2	B1	C2	C1	D2	D1								
2 DIMMs	V				V											
4 DIMMs	V		V		V		V									
6 DIMMs	V	V	V		V	V	V									
8 DIMMs	V	V	V	V	V	V	V	V								
CPU1 + CPU2 Configuration																
	A2	A1	B2	B1	C2	C1	D2	D1	E2	E1	F2	F1	G2	G1	H2	H1
2 DIMMs	V								V							
4 DIMMs	V				V				V				V			
6 DIMMs	V		V		V				V		V		V			
8 DIMMs	V		V		V		V		V		V		V		V	
10 DIMMs	V	V	V		V		V		V	V	V		V		V	
12 DIMMs	V	V	V		V	V	V		V	V	V		V	V	V	
14 DIMMs	V	V	V	V	V	V	V		V	V	V	V	V	V	V	
16 DIMMs	V	V	V	V	V	V	V	V	V	V	V	V	V	V	V	V

*For RDIMM (Single Rank, Dual Ranks & Quad Ranks)*

CPU1 Configuration																
	A2	A1	B2	B1	C2	C1	D2	D1								
2 DIMMs	V				V											
4 DIMMs	V		V		V		V									
6 DIMMs	V	V	V		V	V	V									
8 DIMMs	V	V	V	V	V	V	V	V								
CPU1 + CPU2 Configuration																
	A2	A1	B2	B1	C2	C1	D2	D1	E2	E1	F2	F1	G2	G1	H2	H1
2 DIMMs	V								V							
4 DIMMs	V				V				V				V			
6 DIMMs	V		V		V				V		V		V			
8 DIMMs	V		V		V		V		V		V		V		V	
10 DIMMs	V	V	V		V		V		V	V	V		V		V	
12 DIMMs	V	V	V		V	V	V		V	V	V		V	V	V	
14 DIMMs	V	V	V	V	V	V	V		V	V	V	V	V	V	V	
16 DIMMs	V	V	V	V	V	V	V	V	V	V	V	V	V	V	V	V

### 2.3.3 Installing a DIMM



Ensure to unplug the power supply before adding or removing DIMMs or other system components. Failure to do so may cause severe damage to both the motherboard and the components.

1. Unlock a DIMM socket by pressing the retaining clips outward.
2. Align a DIMM on the socket such that the notch on the DIMM matches the break on the socket.

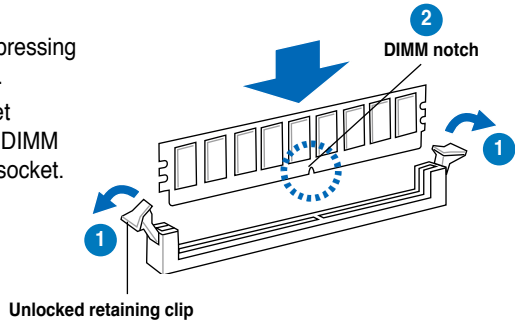

A DIMM is keyed with a notch so that it fits in only one direction. **DO NOT** force a DIMM into a socket to avoid damaging the DIMM.

3. Firmly insert the DIMM into the socket until the retaining clips snap back in place and the DIMM is properly seated.

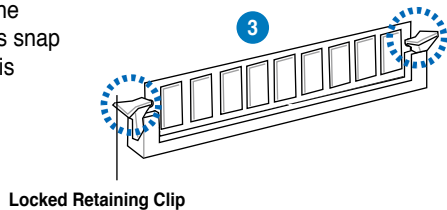

### 2.3.4 Removing a DIMM

Follow these steps to remove a DIMM.

1. Simultaneously press the retaining clips outward to unlock the DIMM.

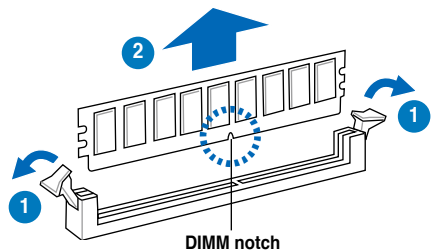

Support the DIMM lightly with your fingers when pressing the retaining clips. The DIMM might get damaged when it flips out with extra force.

2. Remove the DIMM from the socket.

## 2.4 Hard disk drives

The system supports four hot-swap SATAII/SAS hard disk drives. The hard disk drive installed on the drive tray connects to the motherboard SATAII/SAS ports via the SATAII/SAS backplane.

To install a hot-swap SATAII/SAS HDD:

1. Release a drive tray by pushing the spring lock to the right, then pulling the tray lever outward. The drive tray ejects slightly after you pull out the lever.

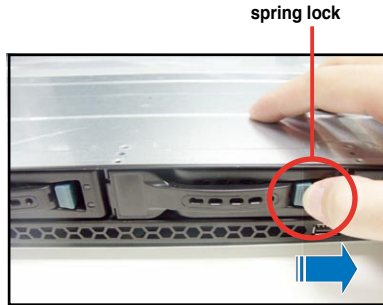

2. Firmly hold the tray lever and pull the drive tray out of the bay.



3. Take note of the drive tray holes. Each side has three holes to fit different types of hard disk drives. Use two screws on each side to secure the hard disk drive.



4. Place a SATAII/SAS hard disk drive on the tray, then secure it with four screws.



5. Carefully insert the drive tray and push it all the way to the depth of the bay until just a small fraction of the tray edge protrudes.



When installed, the SATAII/SAS connector on the drive connects to the SATAII/SAS interface on the backplane.

6. Push the tray lever until it clicks, and secures the drive tray in place. The drive tray is correctly placed when its front edge aligns with the bay edge.
7. Repeat steps 1 to 6 if you wish to install a second SATAII/SAS drive.



## 2.5 Expansion slot

### 2.5.1 Installing an expansion card to the riser card bracket

The barebone server comes with a riser card bracket. You need to remove the bracket if you want to install a PCI Express expansion card.

To install a PCI Express expansion card:

1. Firmly hold the riser card bracket, then pull it up to detach it from the PCI Express x16 slot on the motherboard.

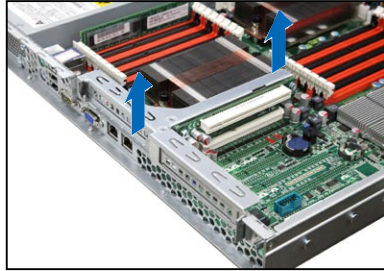

2. Place the riser card bracket on a flat and stable surface, then remove the screw from the slot bay.

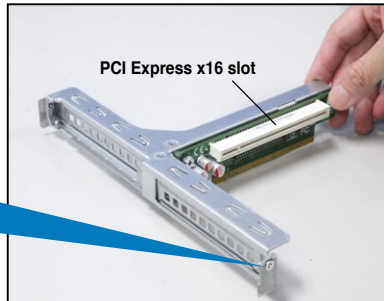

3. Install a PCI Express expansion card to the bracket as shown, then secure the card with a screw.

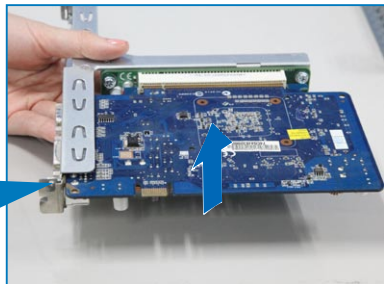

To reinstall the riser card bracket:

1. Align the riser card bracket with the cards to the PCI Express x16 slot on the motherboard.



2. Press the riser card bracket until the golden connectors completely fit the slot and the bracket aligns with the rear panel.
3. Connect the cable(s) to the card, if applicable.

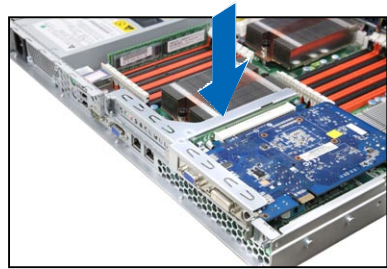

## 2.5.2 Configuring an expansion card

After installing the expansion card, configure the it by adjusting the software settings.

1. Turn on the system and change the necessary BIOS settings, if any. See Chapter 5 for information on BIOS setup.
2. Assign an IRQ to the card. Refer to the following tables.
3. Install the software drivers for the expansion card.

### Standard Interrupt assignments

IRQ	Priority	Standard function
0	1	System Timer
1	2	Keyboard Controller
2	-	Programmable Interrupt
3*	11	Communications Port (COM2)
4*	12	Communications Port (COM1)
5*	13	--
6	14	Floppy Disk Controller
7*	15	--
8	3	System CMOS/Real Time Clock
9*	4	ACPI Mode when used
10*	5	IRQ Holder for PCI Steering
11*	6	IRQ Holder for PCI Steering
12*	7	PS/2 Compatible Mouse Port
13	8	Numeric Data Processor
14*	9	Primary IDE Channel
15*	10	Secondary IDE Channel

\* These IRQs are usually available for ISA or PCI devices.



## 2.6 Cable connections



- The bundled system cables are pre-connected before shipment. You do not need to disconnect these cables unless you will remove pre-installed components to install additional devices.
- Refer to Chapter 4 for detailed information on the connectors.

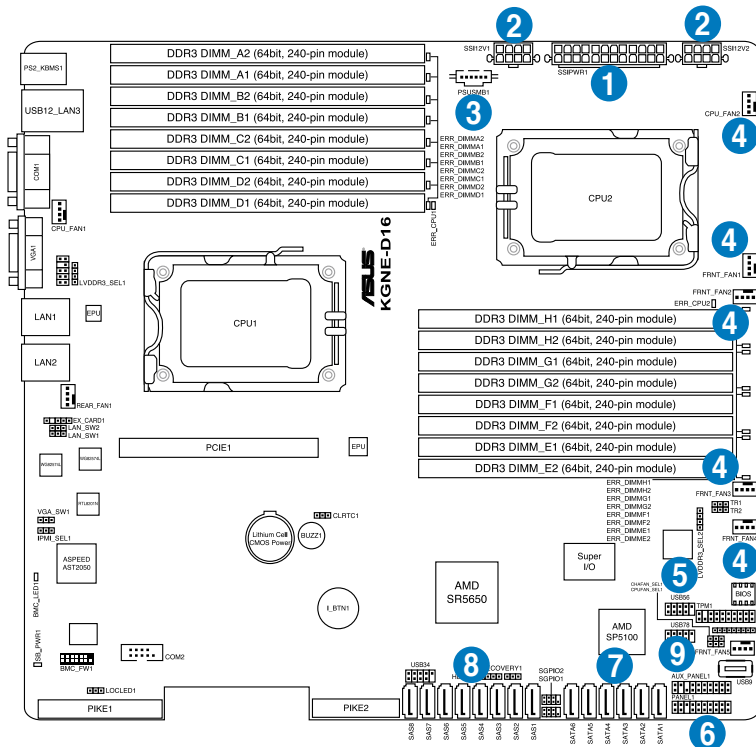

### Pre-connected system cables

1. 24-pin SSI power connector (from power supply to motherboard)
2. 8-pin SSI power connectors (from power supply to motherboard)
3. Power supply SMBus connector (from power supply to motherboard)
4. System fan connectors (from motherboard CPU\_FAN2, FRNT\_FAN1, FRNT\_FAN2, FRNT\_FAN3, and FRNT\_FAN4 to system fans)
5. USB connector (from motherboard to front I/O board)
6. Panel connector (from motherboard to front I/O board)
7. SATA connectors (from motherboard to SATAII/SAS backplane board)
8. SAS connectors (from motherboard to SATAII/SAS backplane board)
9. Auxiliary panel connector (from motherboard to front I/O board)

## 2.7 SATAII/SAS backplane cabling

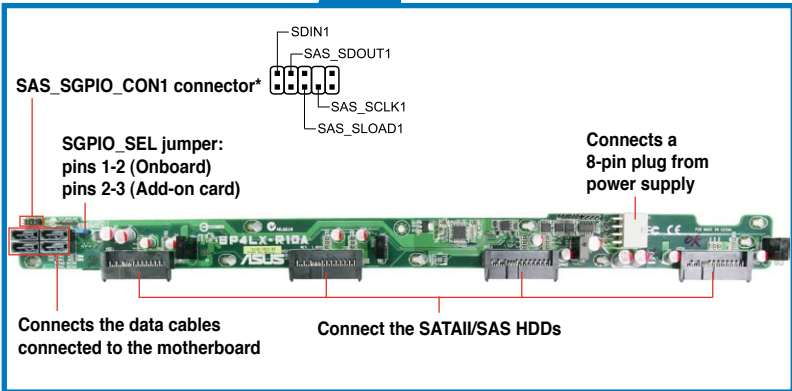
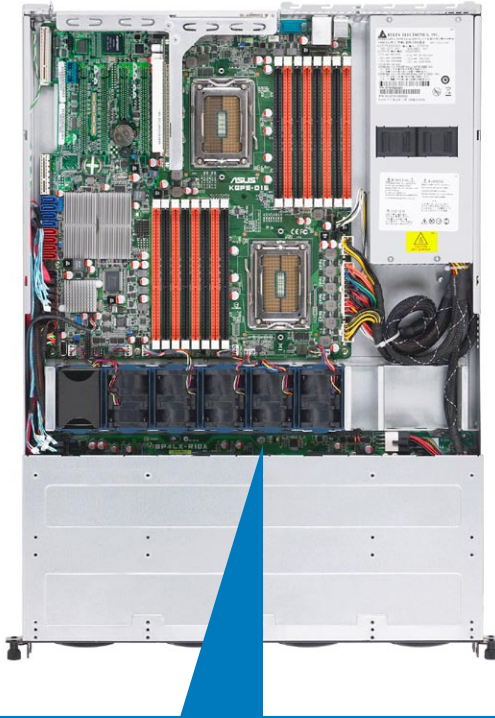

\* For PIKE RAID solution, ensure to connect SAS\_SGPIO\_CON1 to the SGPIO1 connector on the motherboard.

## 2.8 Removable/optional components

You may need to remove previously installed system components when installing or removing system devices. Or you may need to install the optional components into the system. This section tells how to remove/install the following components:

1. System fans
2. ASUS PIKE RAID card (optional)
3. ASUS ASMB4-iKVM (optional)



Ensure that the system is turned off before removing any components.

### 2.8.1 System fans

To uninstall the system fans:

1. Disconnect the system fan cable from the fan connector on the motherboard.
2. Lift the fan, then set aside.
3. Repeat steps 1 to 2 to uninstall the other system fans.

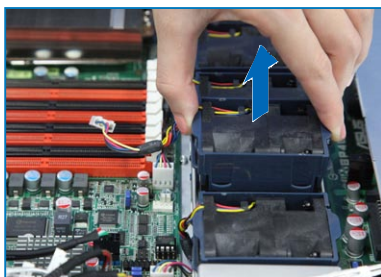
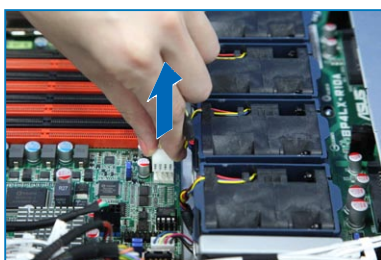

To reinstall the system fans

1. Insert the fan to the fan cage. The airflow directional arrow on the fan side should point towards the system rear panel.
2. Connect the system fan cable to the fan connector on the motherboard.

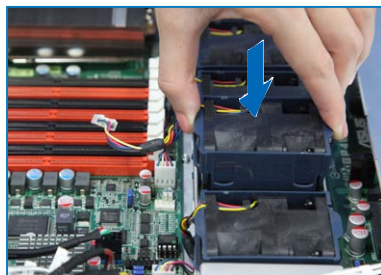

## 2.8.2 Installing ASUS PIKE RAID card (optional)

Follow the steps below to install an optional ASUS RAID card on your motherboard. If you install the PIKE 1078 or PIKE 2008 Series SAS RAID card, follow steps 1 and 2 to remove the outer heatsink on RAID card.

1. Remove the two screws that secure the heatsink bracket on the back of the SAS RAID card.



Heatsink bracket

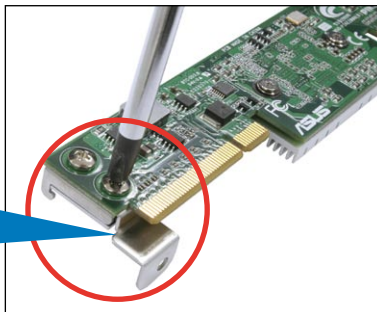

2. Remove the two screws that secure the outer heatsink on the front of the SAS RAID card.



DO NOT remove the inner heatsink from the SAS RAID card.

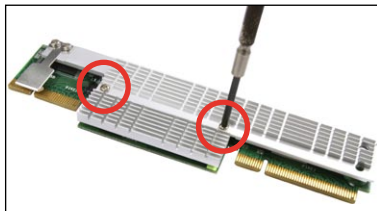

3. Locate the PIKE RAID card slot on the motherboard.

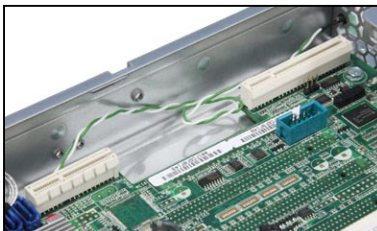

4. Align the golden fingers of the RAID card with the PIKE RAID card slot.

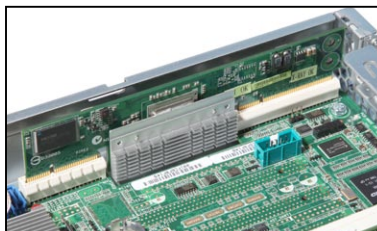

5. Insert the RAID card into the PIKE RAID card slot. Ensure that it is completely seated on the PIKE RAID card slot.

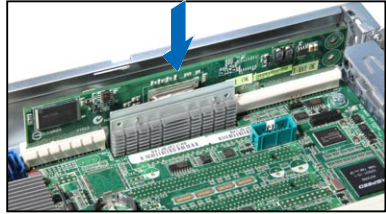

6. Remove the data cables connected to the SATA connectors on the motherboard.

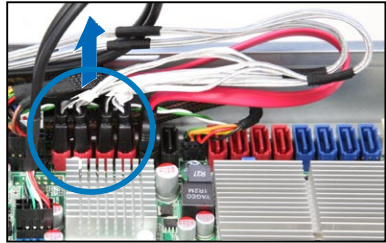

7. Connect the data cables, by numerical order, to the SAS connectors labeled SAS1-4 (red) on the motherboard.



8. Remove the SGPIO cable from the SGPIO3 connector on the motherboard.

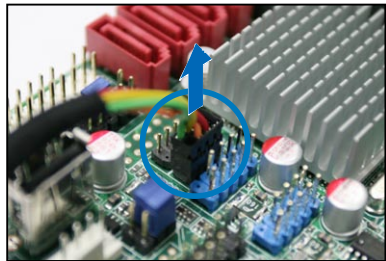

9. Connect the SGPIO cable to the SGPIO1 connector on the motherboard.

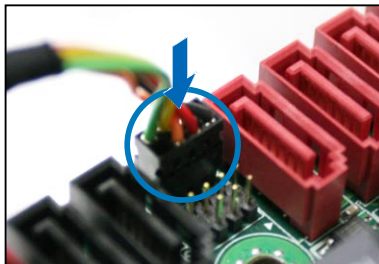

10. Set the SGPIO\_SEL1 jumper on the backplane to pin 2-3 when connecting data cables to the SAS connectors on the motherboard.



---

The heatsink on PIKE 1078/PIKE 2008 Series might interfere the components on the expansion card. Ensure that the height of the components is less than 5.8 mm.

---

## Installing i Button (for PIKE 1078 only)

Follow the steps below to install an optional i Button on your motherboard.

1. Locate the I Button slot on the motherboard.

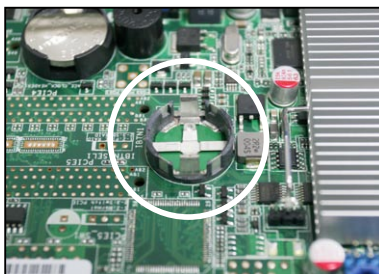

2. Snap the I Button in place.

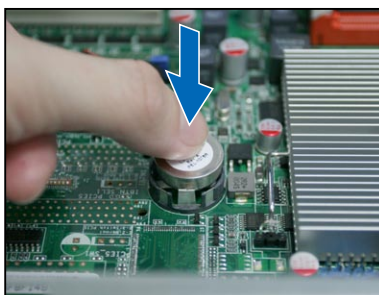

## 2.8.3 Installing ASMB4 series management board (optional)

Follow the steps below to install an optional ASMB4 series management board on your motherboard.

1. Locate the BMC\_FW header on the motherboard.

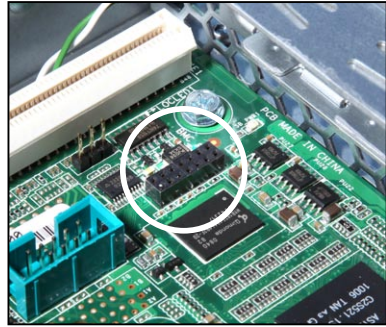

2. Orient and press the ASMB4 management card in place.

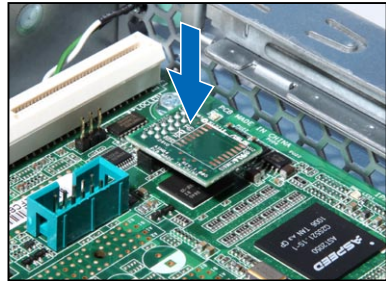

3. Insert the LAN cable plug to the LAN port 3 (dedicated LAN) or LAN port 1 (shared LAN) for server management.

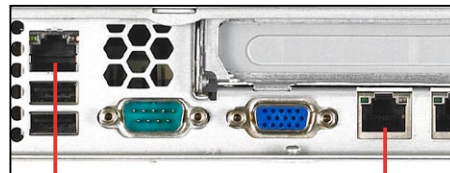

LAN port 3

LAN port 1



# Chapter 3

This chapter describes how to install the optional components and devices into the barebone server.

# Installation options

### 3.1 Installing friction rail kit items

Your friction rail kit package contains:

- Two pairs of rack rails (for the rack)
- Nut-and-bolt type screws and one pair of server latches

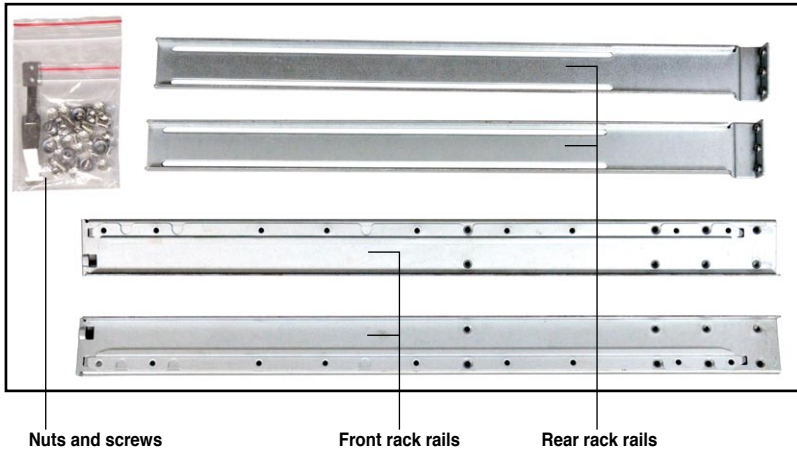

#### 3.1.1 Attaching the fixing latches to the server

Refer to the image below for the locations to attach the two fixing latches to the two sides of the server with four screws.



### 3.1.2 Attaching the rack rails

To attach the rack rails

1. Place the two front rail rack joints into the rear rail rack slots, as shown in the following figure.
2. Attach the front and rear rail racks with eight screws and nuts, as shown in the following figure. Do not secure the screws too tight so that you can still adjust the length of the rack rails to meet the depth of the server rack.

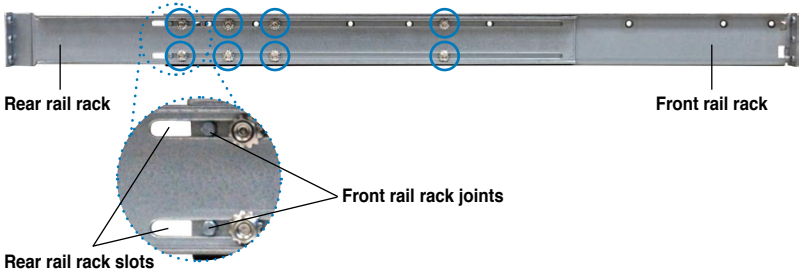

3. Select one unit of space (1U) on the rack where you want to install the barebone server.
4. Measure the depth of the rack to determine the length of the rack rails.
5. Adjust the rack rail to ensure that it fits the rack.
6. Position the rack rail to the 1U space on the rack. Ensure that the front end of the rack rail goes to the front of the rack space.
7. Secure the front end of the rail with two rack screws, as shown in the right figure.
8. Secure the rear end of the rail with two rack screws, as shown in the right figure.
9. Fasten the eight screw you secure in step 2, as shown in the right figure.
10. Repeat steps 6 to 9 to assemble and attach the rack rail on the other side.

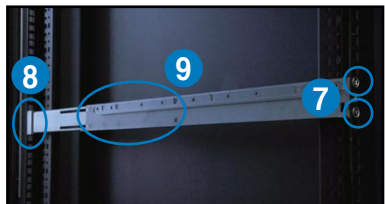
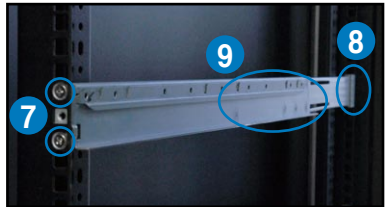

### 3.1.3 Mounting the server to the rack

To mount the server to the rack

1. Place the server on the rack rails, and then push the server all the way to the depth of the rack.



2. Tighten the two rack screws to secure the server in place.

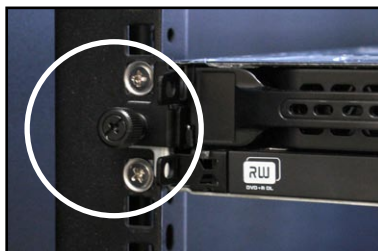

To uninstall the server from the rack

1. Loosen the rack screws that secured the server to the rack.
2. Pull the server from the rack.



Remember to press the latches on both sides to release the server from the rack.

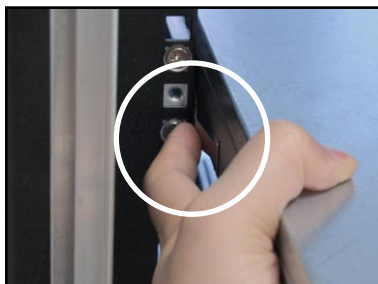

## 3.2 Installing optional ball-bearing rail kit items

Your optional ball-bearing rail kit package contains:

- two pair of server rails (for the server)
- two pairs of rack rails (for the rack)
- Nut-and-bolt type screws

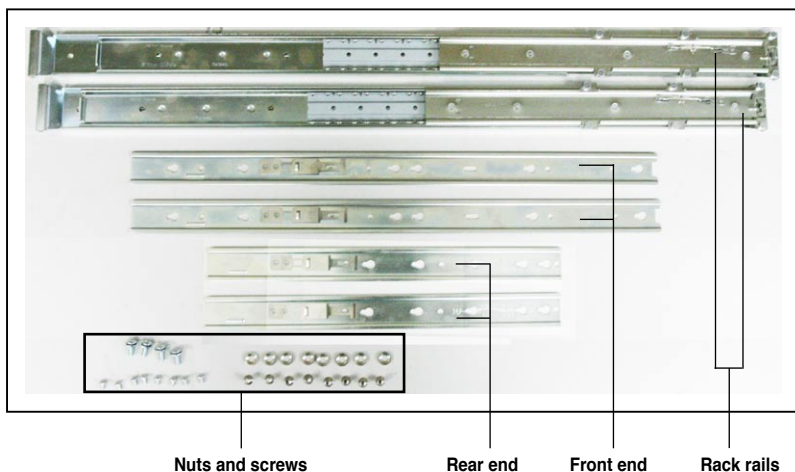

### 3.2.1 Attaching the rails to the server

To attach the server rails:

1. Attach the front end of the server rail to the side of the chassis, matching each of the three hooks to the holes on the rail. Then slide the rail toward the front panel until it locks in place.

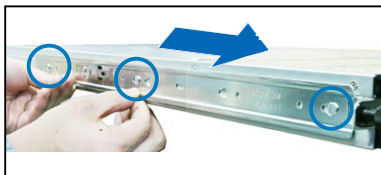

2. Secure the front end of the server rail to the side of the chassis with one screw.



3. Attach the rear end of the server rail to the side of the chassis, matching each of the two hooks to the holes on the rail. Then slide the rail toward the front panel until it locks in place.



4. Secure the rear end of the server rail to the side of the chassis with one screw.



5. Repeat steps 1 to 4 to attach the second server rail to the other side of the chassis.

### 3.2.2 Attaching the rack rails

To attach the rack rails:

1. Select one unit of space (1U) on the rack where you want to install the barebone server.
2. Install the nuts on the holes of the 1U space on the rack front.
3. Install the nuts on the holes of the 1U space on the corresponding rack rear.
4. Measure the depth of the rack to determine the length of the rack rails.
5. Measure the rack rail when assembled to ensure that it fits the rack.
6. Position the rack rail to the 1U space on the rack. Ensure that the front end of the rack rail goes to the front of the rack space.
7. Secure the front end of the rail with two rack screws.
8. Secure the rear end of the rail with two rack screws.
9. Repeat steps 5 to 8 to assemble and attach the second rack rail.



### 3.2.3 Mounting the server to the rack

To mount the server to the rack:

1. Align the server rails with the rack rails, then push the server all the way to the depth of the rack.
2. Tighten the two rack screws to secure the server in place.

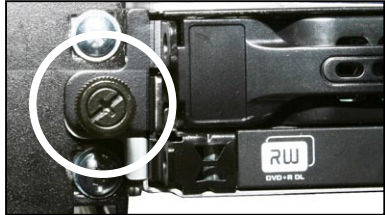

To uninstall the server from the rack:

1. Loosen the rack screws that secured the server to the rack.
2. Pull the server from the rack.



Remember to press the latches on both sides to release the server from the rack.

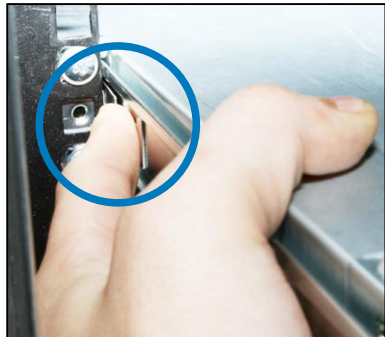





# Chapter 4

This chapter includes the motherboard layout, and brief descriptions of the jumpers and internal connectors.

# Motherboard info

# 4.1 Motherboard layouts

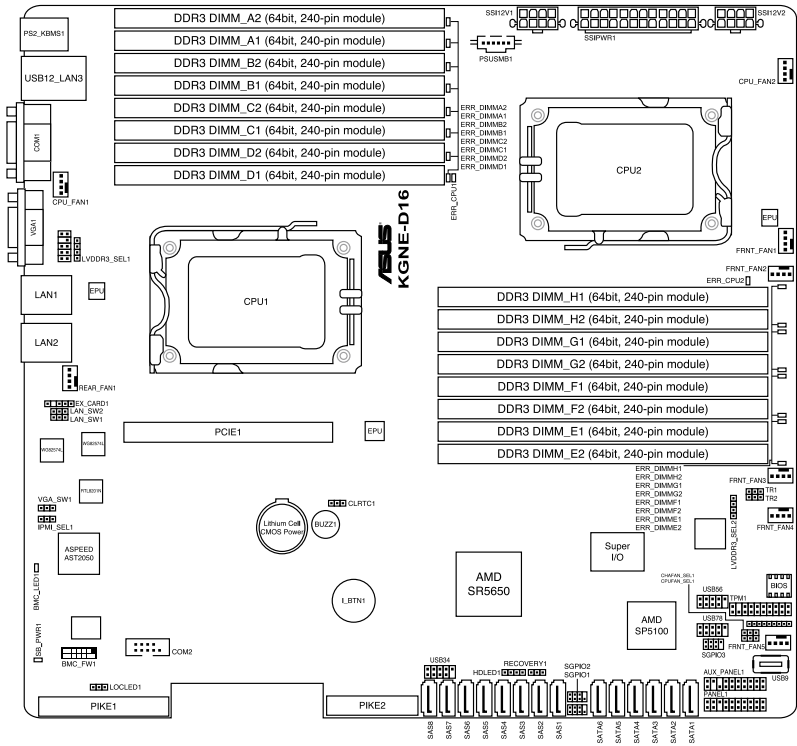

## Layout contents

Jumpers		Page
1.	Clear RTC RAM (CLRTC1)	4-4
2.	VGA controller setting (3-pin VGA_SW1))	4-5
3.	CPU Fan and Chassis Fan control setting (3-pin CPUFAN_SEL1, CHAFAN_SEL1)	4-5
4.	LAN controller setting (3-pin LAN_SW1, LAN_SW2)	4-6
5.	DDR3 voltage control setting (4-pin LVDDR3_SEL1; LVDDR3_SEL2)	4-6
6.	Force BIOS recovery setting (3-pin RECOVERY1)	4-7

Internal connectors		Page
1.	Serial ATA connectors (7-pin SATA1, SATA2, SATA3, SATA4; RED) (7-pin SATA5, SATA6; Black)	4-8
2.	SAS connectors (7-pin SAS1, SAS2, SAS3, SAS4; Red) (7-pin SAS5, SAS6, SAS7, SAS8; Blue)	4-8
3.	Hard disk activity LED connector (4-pin HDLED1)	4-9
4.	USB connector (10-1 pin USB34, USB56; USB78; A-Type USB9)	4-9
5.	Thermal sensor cable connectors (3-pin TR1, TR2)	4-10
6.	CPU, front and rear fan connectors (4-pin CPU_FAN1, CPU_FAN2, FRNT_FAN1, FRNT_FAN2, FRNT_FAN3, FRNT_FAN4, FRNT_FAN5, REAR_FAN1)	4-10
7.	Serial General Purpose Input/Output connectors (8-1 pin SGPIO1/2)	4-11
8.	Serial General Purpose Input/Output connector (8-1 pin SGPIO3)	4-11
9.	Serial port connector (10-1 pin COM2)	4-12
10.	BMC header (BMC_FW1)	4-12
11.	TPM connector (20-1 pin TPM1)	4-13
12.	Power Supply SMBus connector (5-pin PSUSMB1)	4-13
13.	SSI power connectors (24-pin SSIPWR1, 8-pin SSI12V1, 8-pin SSI12V2)	4-14
14.	System panel connector (20-1 pin PANEL1)	4-15
15.	Auxiliary panel connector (20-2 pin AUX_PANEL1)	4-16

## 4.2 Jumpers

### 1. Clear RTC RAM (CLRRTC1)

This jumper allows you to clear the Real Time Clock (RTC) RAM in CMOS. You can clear the CMOS memory of date, time, and system setup parameters by erasing the CMOS RTC RAM data. The onboard button cell battery powers the RAM data in CMOS, which include system setup information such as system passwords.

To erase the RTC RAM:

1. Turn OFF the computer and unplug the power cord.
2. Move the jumper cap from pins 1–2 (default) to pins 2–3. Keep the cap on pins 2–3 for about 5–10 seconds, then move the cap back to pins 1–2.
3. Plug the power cord and turn ON the computer.
4. Hold down the <Del> key during the boot process and enter BIOS setup to re-enter data.



Except when clearing the RTC RAM, never remove the cap on CLRRTC1 jumper default position. Removing the cap will cause system boot failure!



If the steps above do not help, remove the onboard battery and move the jumper again to clear the CMOS RTC RAM data. After the CMOS clearance, reinstall the battery.

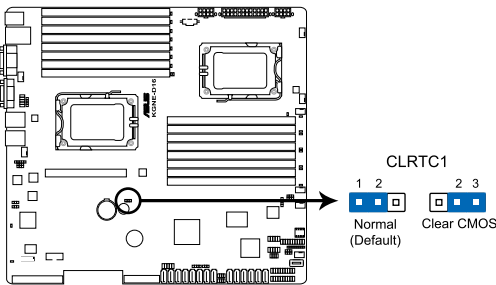

**KGNE-D16 Clear RTC RAM**

## 2. VGA controller setting (3-pin VGA\_SW1)

This jumper allows you to enable or disable the onboard VGA controller. Set to pins 1–2 to activate the VGA feature.

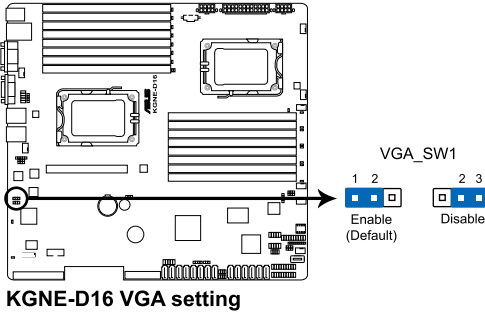

## 3. CPU Fan and Chassis Fan control setting (3-pin CPUFAN\_SEL1, CHAFAN\_SEL1)

These jumpers allow you to switch for fan pin selection. The CPUFAN\_SEL1 jumper is for the CPU fans control and the CHAFAN\_SEL1 jumper is for the front fans and rear fans control. Set to pins 1–2 when using 4-pin fans or pins 2–3 when using 3-pin fans.

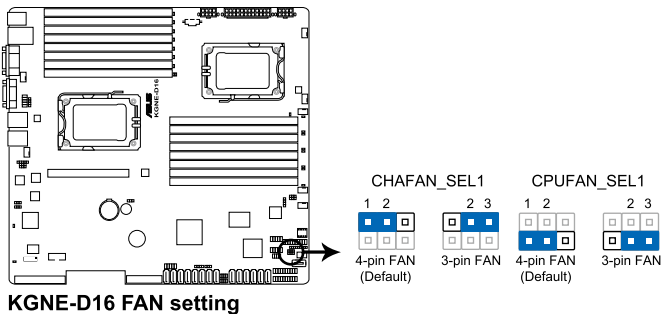

- If you use a 4-pin fan but set the jumper to pin 2-3, the fan you installed may not work.
- If you use a 3-pin fan but set the jumper for a 4-pin fan, the fan control will not work and the fan you installed will always run at full speed.

#### 4. LAN controller setting (3-pin LAN\_SW1, LAN\_SW2)

These jumpers allow you to enable or disable the onboard Intel® 82574L Gigabit LAN controllers. Set to pins 1-2 to activate the Gigabit LAN feature.

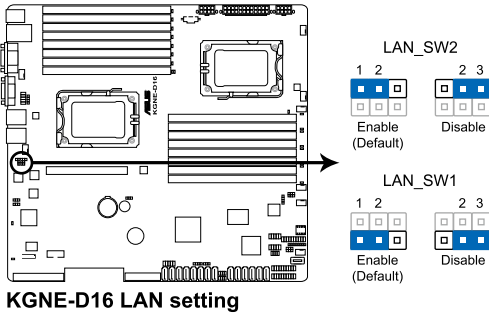

#### 5. DDR3 voltage control setting (4-pin LVDDR3\_SEL1; LVDDR3\_SEL2)

These jumpers allow you to adjust the DIMM voltage. Set to pins 1-2 to select 1.5V BIOS control, pins 2-3 to select 1.2V Force or 3-4 to select 1.35V Force.

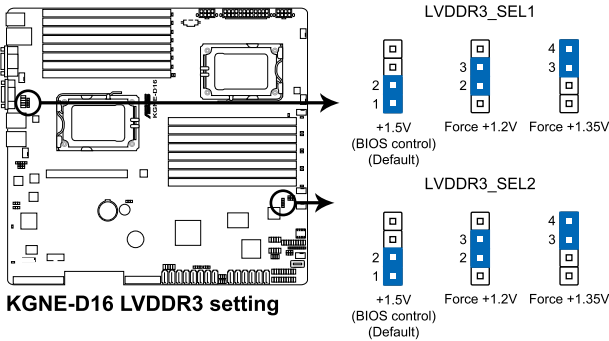

## 6. Force BIOS recovery setting (3-pin RECOVERY1)

This jumper allows you to quickly update or recover the BIOS settings when it becomes corrupted.

To update the BIOS:

1. Set the jumper to pins 2–3.
2. Insert the USB flash that contains the original or latest BIOS and turn on the system to recover or update the BIOS.
3. Shut down the system.
4. Set the jumper back to pins 1–2.
5. Turn on the system.

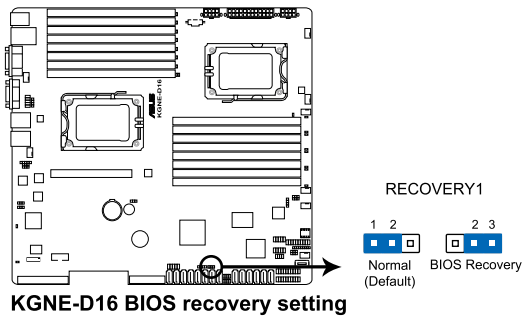

## 4.3 Internal connectors

### 1. Serial ATA connectors

(7-pin SATA1, SATA2, SATA3, SATA4; RED)

(7-pin SATA5, SATA6; Black)

Supported by the AMD® SP5100 chipset, these connectors are for the Serial ATA signal cables for Serial ATA hard disk drives that allows up to 3Gb/s of data transfer rate.

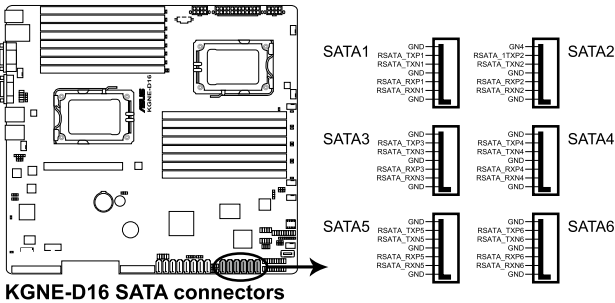

**KGNE-D16 SATA connectors**

### 2. SAS connectors

(7-pin SAS1, SAS2, SAS3, SAS4; Red)

(7-pin SAS5, SAS6, SAS7, SAS8; Blue)

This motherboard comes with eight (8) Serial Attached SCSI (SAS) connectors, the next-generation storage technology that supports both Serial Attached SCSI (SAS) and Serial ATA (SATA). Each connector supports one device.



- These connectors function only when you install a PIKE RAID card.
- Connect the SAS hard disk drives to SAS connectors 1–4 (red) when installing a 4-port PIKE RAID card.

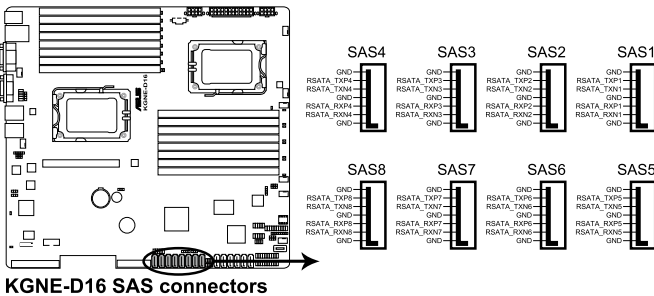

**KGNE-D16 SAS connectors**



### 3. Hard disk activity LED connector (4-pin HDLED1)

This LED connector is for the storage add-on card cable connected to the SATA or SAS add-on card. The read or write activities of any device connected to the SATA or SAS add-on card causes the front panel LED to light up.

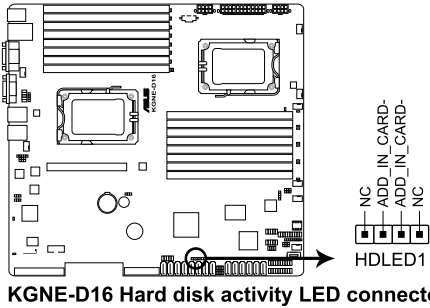

### 4. USB connector (10-1 pin USB34, USB56; USB78; A-Type USB9)

These connectors are for USB 2.0 ports. Connect the USB module cables to connectors USB34 and USB56, then install the modules to a slot opening at the back of the system chassis. These USB connectors comply with USB 2.0 specification that supports up to 480 Mbps connection speed.

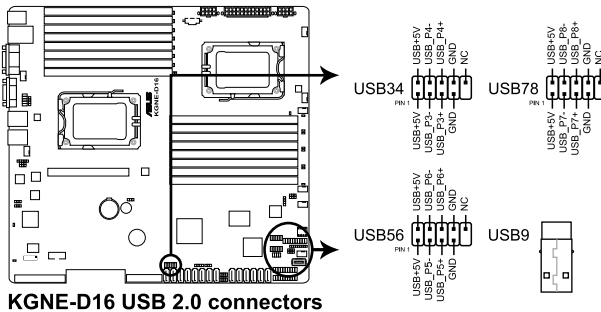

### 5. Thermal sensor cable connectors (3-pin TR1, TR2)

These connectors are for temperature monitoring. Connect the thermal sensor cables to these connectors and place the other ends to the devices, which you want to monitor temperature.

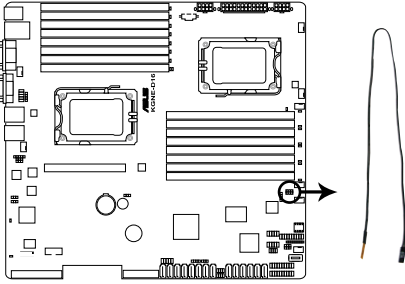

KGNE-D16 Thermal sensor cable connectors

### 6. CPU, front and rear fan connectors (4-pin CPU\_FAN1, CPU\_FAN2, FRNT\_FAN1, FRNT\_FAN2, FRNT\_FAN3, FRNT\_FAN4, FRNT\_FAN5, REAR\_FAN1)

The fan connectors support cooling fans of 350 mA–740 mA (8.88 W max.) or a total of 3.15 A–6.66 A (53.28 W max.) at +12V. Connect the fan cables to the fan connectors on the motherboard, ensuring that the black wire of each cable matches the ground pin of the connector.



- DO NOT forget to connect the fan cables to the fan connectors. Insufficient air flow inside the system may damage the motherboard components.
- These are not jumpers! DO NOT place jumper caps on the fan connectors!
- All fans feature the ASUS Fan Speed technology.

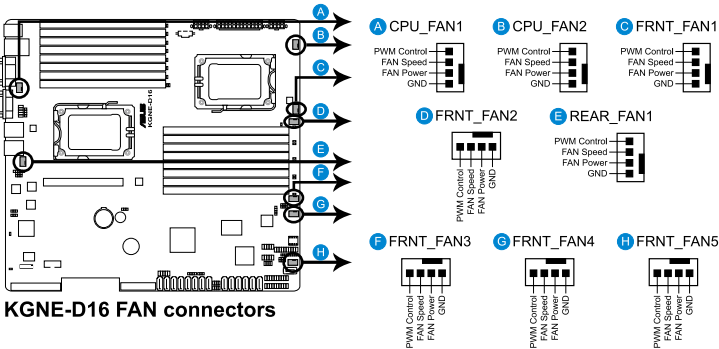

## 7. Serial General Purpose Input/Output connectors (8-1 pin SGPIO1/2)

These connectors are used for the SAS chip SGPIO interface that controls the LED pattern generation, device information and general purpose data.

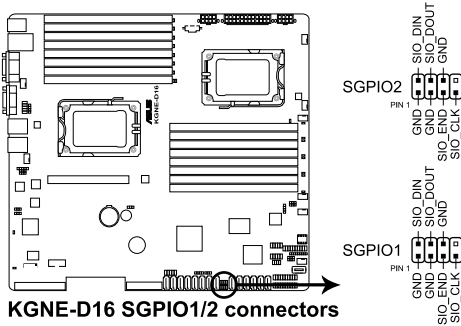

These connectors functions only when you install an ASUS PIKE SAS RAID card.

## 8. Serial General Purpose Input/Output connector (8-1 pin SGPIO3)

This connector is used for the SGPIO peripherals of the PROMISE<sup>®</sup> RAID SATA LED.

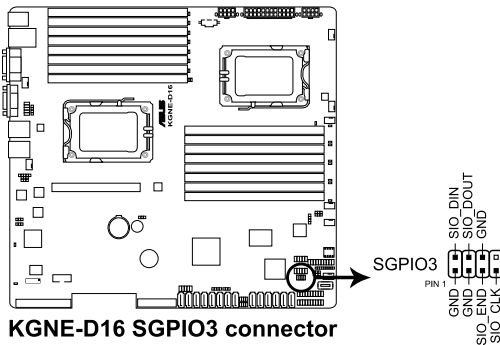

**9. Serial port connector (10-1 pin COM2)**

This connector is for a serial (COM) port. Connect the serial port module cable to this connector, then install the module to a slot opening at the back of the system chassis.

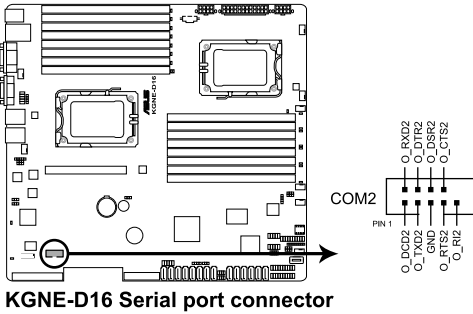

The serial port module is purchased separately.

**10. BMC header (BMC\_FW1)**

The BMC connector on the motherboard supports an ASUS® Server Management Board 4 Series (ASMB4).

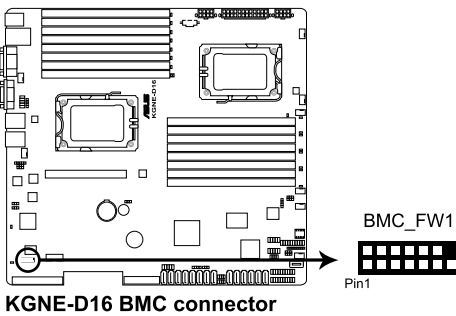

### 11. TPM connector (20-pin TPM)

This connector supports a Trusted Platform Module (TPM) system, which can securely store keys, digital certificates, passwords, and data. A TPM system also helps enhance network security, protects digital identities, and ensures platform integrity.

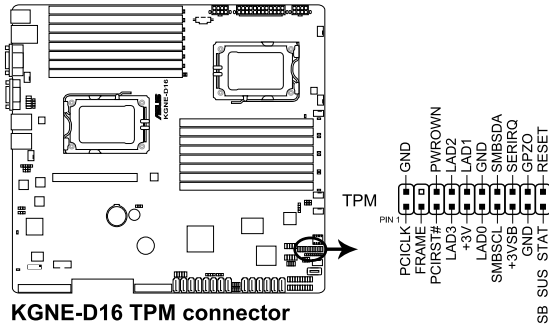

### 12. Power Supply SMBus connector (5-pin PSUSMB1)

This connector allows you to connect SMBus (System Management Bus) to the power supply unit to read PSU information. Devices communicate with an SMBus host and/or other SMBus devices using the SMBus interface.

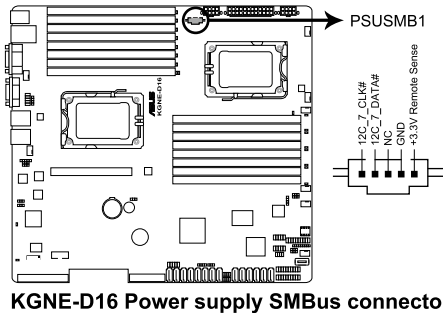

### 13. SSI power connectors (24-pin SSIPWR1, 8-pin SSI12V1, 8-pin SSI12V2)

These connectors are for the SSI power supply plugs. The power supply plugs are designed to fit these connectors in only one orientation. Find the proper orientation and push down firmly until the connectors completely fit.



- DO NOT forget to connect the 24+8+8-pin power plugs; otherwise, the system will not boot up.
- Use of a PSU with a higher power output is recommended when configuring a system with more power-consuming devices. The system may become unstable or may not boot up if the power is inadequate.
- Ensure that your power supply unit (PSU) can provide at least the minimum power required by your system.

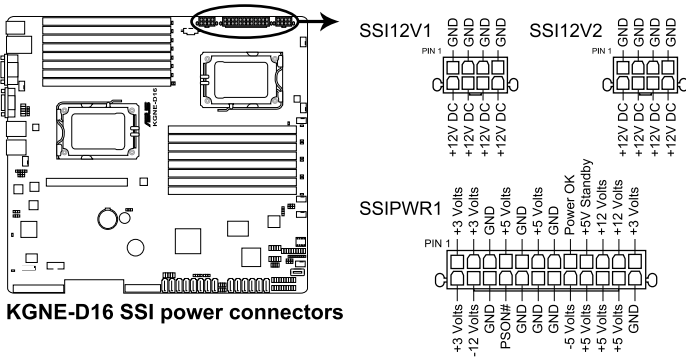

## 14. System panel connector (20-pin PANEL1)

This connector supports several chassis-mounted functions.

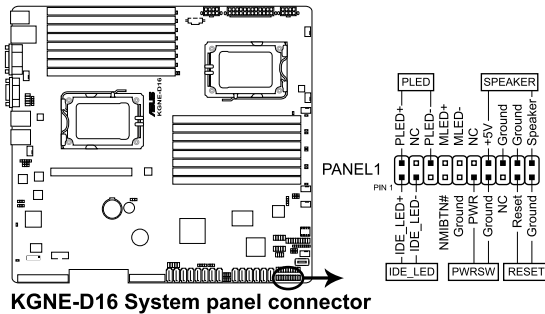

### 1. System power LED (3-pin PLED)

This 3-pin connector is for the system power LED. Connect the chassis power LED cable to this connector. The system power LED lights up when you turn on the system power, and blinks when the system is in sleep mode.

### 2. Message LED (2-pin MLED)

This 2-pin connector is for the message LED cable that connects to the front message LED. The message LED is controlled by Hardware monitor to indicate an abnormal event occurrence.

### 3. System warning speaker (4-pin SPEAKER)

This 4-pin connector is for the chassis-mounted system warning speaker. The speaker allows you to hear system beeps and warnings.

### 4. Hard disk drive activity LED (2-pin HDDLED)

This 2-pin connector is for the HDD Activity LED. Connect the HDD Activity LED cable to this connector. The IDE LED lights up or flashes when data is read from or written to the HDD.

### 5. SSI power button/soft-off button (2-pin PWRSW)

This connector is for the system power button. Pressing the power button turns the system on or puts the system in sleep or soft-off mode depending on the BIOS settings. Pressing the power switch for more than four seconds while the system is ON turns the system OFF.

### 6. Reset button (2-pin RESET)

This 2-pin connector is for the chassis-mounted reset button for system reboot without turning off the system power.

## 15. Auxiliary panel connector (20-pin AUX\_PANEL1)

This connector is for additional front panel features including front panel SMB, locator LED and switch, chassis intrusion, and LAN LEDs.

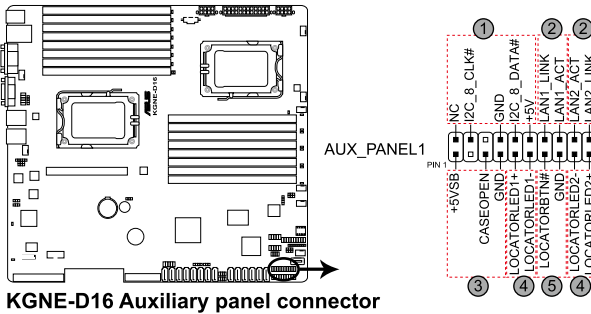

**KGNE-D16 Auxiliary panel connector**

- 1. Front panel SMB (6-1 pin FPSMB)**  
These leads connect the front panel SMBus cable.
- 2. LAN activity LED (2-pin LAN1\_LED, LAN2\_LED)**  
These leads are for Gigabit LAN activity LEDs on the front panel.
- 3. Chassis intrusion (4-1 pin CHASSIS)**  
These leads are for the intrusion detection feature for chassis with intrusion sensor or microswitch. When you remove any chassis component, the sensor triggers and sends a high-level signal to these leads to record a chassis intrusion event. The default setting is short CASEOPEN and GND pin by jumper cap to disable the function.
- 4. Locator LED (2-pin LOCATORLED1 and 2-pin LOCATORLED2)**  
These leads are for the locator LED1 and LED2 on the front panel. Connect the Locator LED cables to these 2-pin connector. The LEDs will light up when the Locator button is pressed.
- 5. Locator Button/Switch (2-pin LOCATORBTN)**  
These leads are for the locator button on the front panel. This button queries the state of the system locator.



# Chapter 5

This chapter tells how to change the system settings through the BIOS Setup menus. Detailed descriptions of the BIOS parameters are also provided.

# BIOS setup

## 5.1 Managing and updating your BIOS

The following utilities allow you to manage and update the motherboard Basic Input/Output System (BIOS) setup:

1. **ASUS EZ Flash 2** (Updates the BIOS using a USB flash disk.)
2. **BUPDATER utility** (Updates the BIOS in DOS mode using a bootable USB flash disk drive.)
3. **ASUS CrashFree BIOS 3** (To recover the BIOS using a bootable USB flash disk drive when the BIOS file fails or gets corrupted.)

Refer to the corresponding sections for details on these utilities.



Save a copy of the original motherboard BIOS file to a bootable USB flash disk drive in case you need to restore the BIOS in the future. Copy the original motherboard BIOS using the ASUS Update or AFUDOS utilities.

### 5.1.1 ASUS EZ Flash 2 utility

The ASUS EZ Flash 2 feature allows you to update the BIOS without having to use a DOS-based utility.



Before you start using this utility, download the latest BIOS from the ASUS website at [www.asus.com](http://www.asus.com).

To update the BIOS using EZ Flash 2

1. Insert the USB flash disk that contains the latest BIOS file to the USB port.
2. Enter the BIOS setup program. Go to the **Tools** menu to select **EZ Flash 2** and press <Enter> to enable it.  
Or, press <Alt> + <F2> during the POST to enable EZ Flash 2.

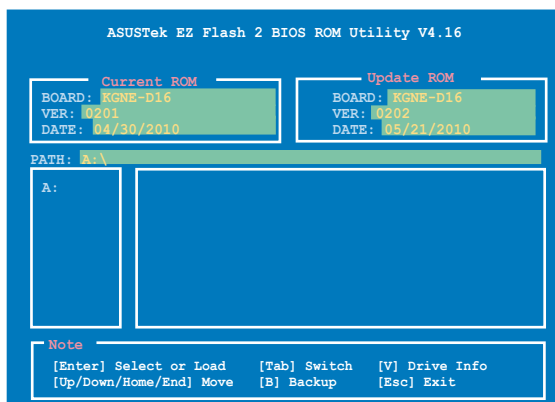

3. Press <Tab> to switch between drives until the correct BIOS file is found. When found, EZ Flash 2 performs the BIOS update process and automatically reboots the system when done.



- This function can support devices such as a USB flash disk with FAT 32/16 format and single partition only.
- DO NOT shut down or reset the system while updating the BIOS to prevent system boot failure!



Ensure to load the BIOS default settings to ensure system compatibility and stability. Select the **Load Setup Defaults** item under the **Exit** menu. See section **5.9 Exit Menu** for details.

### 5.1.2 BUPDATER utility



The succeeding BIOS screens are for reference only. The actual BIOS screen displays may not be the same as shown.

The BUPDATER utility allows you to update the BIOS file in DOS environment using a bootable USB flash disk drive with the updated BIOS file.

#### Updating the BIOS file

To update the BIOS file using the BUPDATER utility:

1. Visit the ASUS website at [www.asus.com](http://www.asus.com) and download the latest BIOS file for the motherboard. Save the BIOS file to a bootable USB flash disk drive.
2. Copy the BUPDATER utility (BUPDATER.exe) from the ASUS support website at [support.asus.com](http://support.asus.com) to the bootable USB flash disk drive you created earlier.
3. Boot the system in DOS mode, then at the prompt, type:

```
BUPDATER /i [filename] .ROM
```

where [filename] is the latest or the original BIOS file on the bootable USB flash disk drive, then press <Enter>.

```
A:\>BUPDATER /i [file name] .ROM
```

- The utility verifies the file, then starts updating the BIOS file.

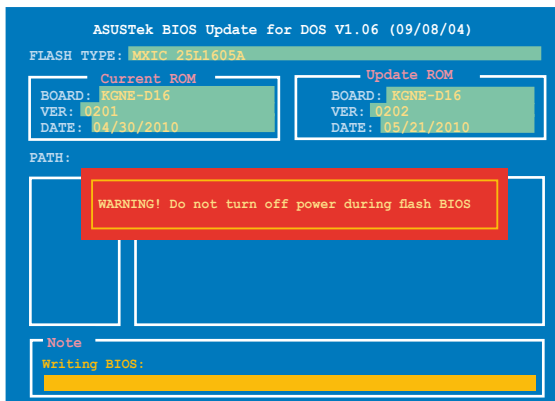

---

DO NOT shut down or reset the system while updating the BIOS to prevent system boot failure!

---

- The utility returns to the DOS prompt after the BIOS update process is completed. Reboot the system from the hard disk drive.



### 5.1.3 ASUS CrashFree BIOS 3 utility

The ASUS CrashFree BIOS 3 is an auto recovery tool that allows you to restore the BIOS file when it fails or gets corrupted during the updating process. You can update a corrupted BIOS file using a USB flash drive that contains the updated BIOS file.



---

Prepare a USB flash drive containing the updated motherboard BIOS before using this utility.

---

#### Recovering the BIOS from a USB flash drive

To recover the BIOS from a USB flash drive:

1. Insert the USB flash drive with the original or updated BIOS file to one USB port on the system.
2. The utility will automatically recover the BIOS. It resets the system when the BIOS recovery finished.



---

DO NOT shut down or reset the system while recovering the BIOS! Doing so would cause system boot failure!

---



---

The recovered BIOS may not be the latest BIOS version for this motherboard. Visit the ASUS website at [www.asus.com](http://www.asus.com) to download the latest BIOS file.

---

## 5.2 BIOS setup program

This motherboard supports a programmable firmware chip that you can update using the provided utility described in section 5.1 **Managing and updating your BIOS**.

Use the BIOS Setup program when you are installing a motherboard, reconfiguring your system, or prompted to “Run Setup.” This section explains how to configure your system using this utility.

Even if you are not prompted to use the Setup program, you can change the configuration of your computer in the future. For example, you can enable the security password feature or change the power management settings. This requires you to reconfigure your system using the BIOS Setup program so that the computer can recognize these changes and record them in the CMOS RAM of the firmware chip.

The firmware chip on the motherboard stores the Setup utility. When you start up the computer, the system provides you with the opportunity to run this program. Press <Del> during the Power-On Self-Test (POST) to enter the Setup utility; otherwise, POST continues with its test routines.

If you wish to enter Setup after POST, restart the system by pressing <Ctrl+Alt+Delete>, or by pressing the reset button on the system chassis. You can also restart by turning the system off and then back on. Do this last option only if the first two failed.

The Setup program is designed to make it as easy to use as possible. Being a menu-driven program, it lets you scroll through the various submenus and make your selections from the available options using the navigation keys.



- 
- The default BIOS settings for this motherboard apply for most conditions to ensure optimum performance. If the system becomes unstable after changing any BIOS settings, load the default settings to ensure system compatibility and stability. Select the **Load Setup Defaults** item under the Exit Menu. See section 5.9 **Exit Menu**.
  - The BIOS setup screens shown in this section are for reference purposes only, and may not exactly match what you see on your screen.
  - Visit the ASUS website ([www.asus.com](http://www.asus.com)) to download the latest BIOS file for this motherboard.
-

## 5.2.1 BIOS menu screen

Menu items	Menu bar	Configuration fields	General help
<b>BIOS SETUP UTILITY</b>			
Main    Advanced    Server    Power    Boot    Tools    Exit			
System Time System Date		[13:44:30] [Fri 05/07/2010]	Use [ENTER], [TAB] or [SHIFT-TAB] to select a field.
▶ SATA 1 ▶ SATA 2 ▶ SATA 3 ▶ SATA 4 ▶ SATA 5 ▶ SATA 6  ▶ Storage Configuration ▶ System Information	:	[ST3160812AS] [Not Detected] [Not Detected] [Not Detected] [Not Detected] [Not Detected]	Use [+] or [-] to configure system Time.
			←→ Select Screen ↑↓ Select Item +- Change Field Tab Select Field F1 General Help F10 Save and Exit ESC Exit
v02.61 (C) Copyright 1985-2010, American Megatrends, Inc.			
Submenu items			Navigation keys

## 5.2.2 Menu bar

The menu bar on top of the screen has the following main items:

<b>Main</b>	For changing the basic system configuration
<b>Advanced</b>	For changing the advanced system settings
<b>Server</b>	For changing the advanced server settings
<b>Power</b>	For changing the advanced power management (APM) configuration
<b>Boot</b>	For changing the system boot configuration
<b>Tools</b>	For configuring options for special functions
<b>Exit</b>	For selecting the exit options and loading default settings

To select an item on the menu bar, press the right or left arrow key on the keyboard until the desired item is highlighted.

## 5.2.3 Navigation keys

At the bottom right corner of a menu screen are the navigation keys for that particular menu. Use the navigation keys to select items in the menu and change the settings.



The navigation keys differ from one screen to another.

## 5.2.4 Menu items

The highlighted item on the menu bar displays the specific items for that menu. For example, selecting Main shows the Main menu items.

The other items (Advanced, Power, Boot, and Exit) on the menu bar have their respective menu items.

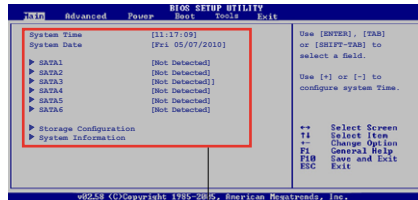

Main menu items

## 5.2.5 Submenu items

A solid triangle before each item on any menu screen means that the item has a submenu. To display the submenu, select the item and press <Enter>.

## 5.2.6 Configuration fields

These fields show the values for the menu items. If an item is user-configurable, you can change the value of the field opposite the item. You cannot select an item that is not user-configurable.

A configurable field is enclosed in brackets, and is highlighted when selected. To change the value of a field, select it then press <Enter> to display a list of options. Refer to 5.2.7 Pop-up window.

## 5.2.7 Pop-up window

Select a menu item then press <Enter> to display a pop-up window with the configuration options for that item.

## 5.2.8 Scroll bar

A scroll bar appears on the right side of a menu screen when there are items that do not fit on the screen. Press the Up/Down arrow keys or <Page Up> /<Page Down> keys to display the other items on the screen.

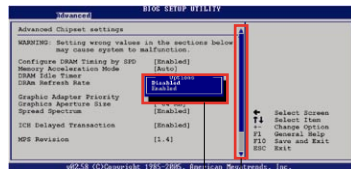

Pop-up window

Scroll bar

## 5.2.9 General help

At the top right corner of the menu screen is a brief description of the selected item.



## 5.3 Main menu

When you enter the BIOS Setup program, the Main menu screen appears, giving you an overview of the basic system information.



Refer to section **5.2.1 BIOS menu screen** for information on the menu screen items and how to navigate through them.

```
BIOS SETUP UTILITY
Main  Advanced  Server  Power  Boot  Tools  Exit

System Time          [13:44:30]
System Date          [Fri 05/07/2010]
▶ SATA 1             : [ST3160812AS]
▶ SATA 2             : [Not Detected]
▶ SATA 3             : [Not Detected]
▶ SATA 4             : [Not Detected]
▶ SATA 5             : [Not Detected]
▶ SATA 6             : [Not Detected]
▶ Storage Configuration
▶ System Information

Use [ENTER], [TAB]
or [SHIFT-TAB] to
select a field.

Use [+] or [-] to
configure system Time.

←→ Select Screen
↑↓ Select Item
+- Change Field
Tab Select Field
F1 General Help
F10 Save and Exit
ESC Exit

v02.61 (C)Copyright 1985-2010, American Megatrends, Inc.
```

### 5.3.1 System Time [xx:xx:xx]

Allows you to set the system time.

### 5.3.2 System Date [Day xx/xx/xxxx]

Allows you to set the system date.

### 5.3.3 SATA1-6

The items in this menu allow you to set or change the configurations for the SATA devices installed in the system. Select an item then press <Enter> if you wish to configure the item.

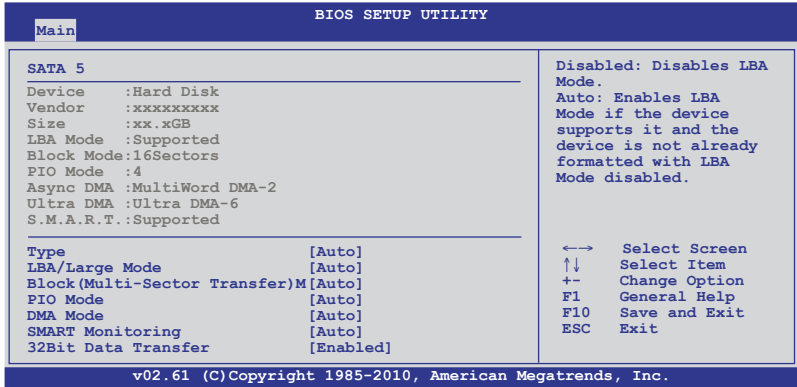

The BIOS automatically detects the values opposite the dimmed items (Device, Vendor, Size, LBA Mode, Block Mode, PIO Mode, Async DMA, Ultra DMA, and S.M.A.R.T. monitoring). These values are not user-configurable. These items show **Not Detected** if no SATA device is installed in the system.

#### Type [Auto]

Selects the type of SATA drive. Setting to [Auto] allows automatic selection of the appropriate SATA device type. Select [CDROM] if you are specifically configuring a CD-ROM drive. Select [ARMD] (ATAPI Removable Media Device) if your device is either a ZIP, LS-120, or MO drive.

Configuration options: [Not Installed] [Auto] [CDROM] [ARMD]



This item appears in SATA 5/6 only.

#### LBA/Large Mode [Auto]

Enables or disables the LBA mode. Setting to [Auto] enables the LBA mode if the device supports this mode, and if the device was not previously formatted with LBA mode disabled. Configuration options: [Disabled] [Auto]

#### Block (Multi-Sector Transfer) M [Auto]

Enables or disables data multi-sectors transfers. When set to [Auto], the data transfer from and to the device occurs multiple sectors at a time if the device supports multi-sector transfer feature. When set to [Disabled], the data transfer from and to the device occurs one sector at a time.

Configuration options: [Disabled] [Auto]

### PIO Mode [Auto]

Allows you to select the data transfer mode.  
Configuration options: [Auto] [0] [1] [2] [3] [4]

### DMA Mode [Auto]

DMA (Direct Memory Access) allows your computer to transfer data to and from the hardware devices installed with much less CPU overhead.

The DMA mode consists of SDMA (single-word DMA), MDMA (multi-word DMA), and UDMA (Ultra DMA). Setting to [Auto] allows automatic selection of the DMA mode.

### SMART Monitoring [Auto]

Sets the Smart Monitoring, Analysis, and Reporting Technology.  
Configuration options: [Auto] [Disabled] [Enabled]

### 32Bit Data Transfer [Enabled]

Enables or disables 32-bit data transfer.  
Configuration options: [Disabled] [Enabled]

## 5.3.4 Storage Configuration

The items in this menu allow you to set or change the configurations for the SATA devices installed in the system. Select an item then press <Enter> if you wish to configure the item.

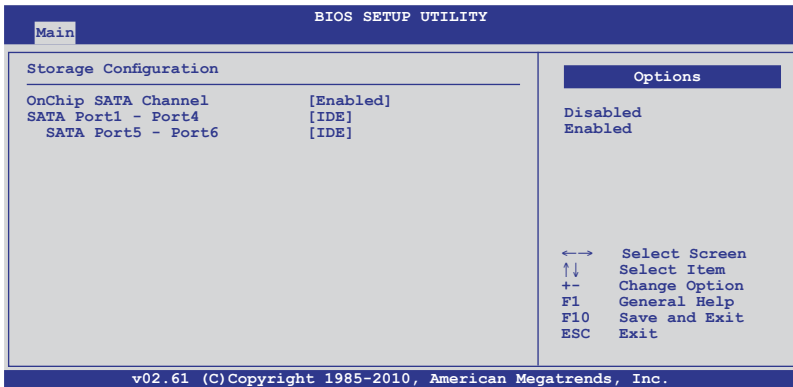

### OnChip SATA Channel [Enabled]

Allows you to enable or disable the onboard SATA channel.  
Configuration options: [Disabled] [Enabled]



The following two items appear only when you set the **OnChip SATA Channel** item to [Enabled].

### SATA Port1 - Port4 [IDE]

Sets the configuration for the Serial ATA connectors supported by the Southbridge chip. Configuration options: [IDE] [RAID] [AHCI]



- If you want to use the Serial ATA hard disk drives as Parallel ATA physical storage devices, keep the default setting [IDE].
- If you want to create RAID sets with the PROMISE<sup>®</sup> RAID utility from the Serial ATA hard disk drives, set this item to [RAID].
- If you want the Serial ATA hard disk drives to use the Advanced Host Controller Interface (AHCI), set this item to [AHCI]. The AHCI allows the onboard storage driver to enable advanced Serial ATA features that increases storage performance on random workloads by allowing the drive to internally optimize the order of commands.
- When this item is set [AHCI], the information of the SATA connectors 1-6 can be seen only under the OS environment or during POST.

### SATA Port5 - Port6 [IDE]

Setting this item to [IDE] instead of [AHCI] allows the system to recognize the optical drives connected to the SATA connectors 5 or 6 when installing OS.



If you use a SATA optical drive to run the OS installation disk, we strongly recommend that you install the optical drive to the SATA connectors 5/6 and set them to [IDE] mode.

## 5.3.5 System Information

This menu gives you an overview of the general system specifications. The BIOS automatically detects the items in this menu.

BIOS SETUP UTILITY	
Main	
<b>BIOS Information</b> Version :0201 Build Date :04/30/10  <b>Processor</b> Type :AMD Opteron(tm) Processor 6172 Speed :2100MHZ  <b>System Memory</b> Usable Size : 2048MB  ▶ System Memory Information	←→ Select Screen ↑↓ Select Item Enter Go to Sub Screen F1 General Help F10 Save and Exit ESC Exit
v02.61 (C) Copyright 1985-2010, American Megatrends, Inc.	

## BIOS Information

Displays the auto-detected BIOS information.

## Processor

Displays the auto-detected CPU specification.

## System Memory

Displays the auto-detected system memory.

## System Memory Information

Displays system memory information.

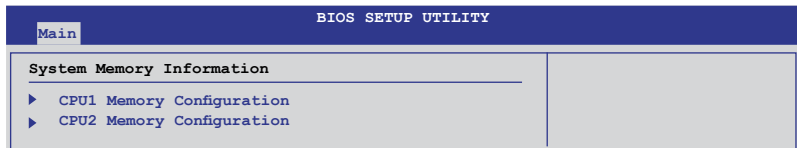

### CPU1/2 Memory Configuration

Allows you to check information of installed memory (8 DIMMs per CPU).

#### **CPU1/2 Memory Configuration**

Displays the auto-detected memory specification.

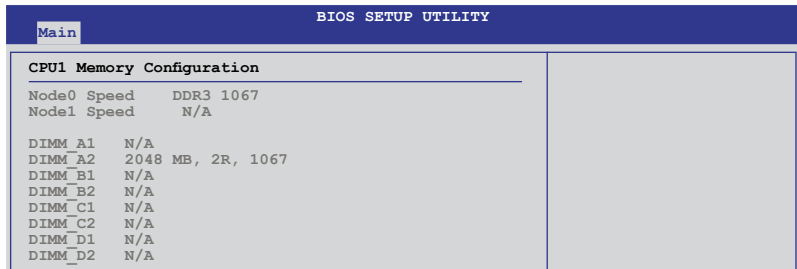

## 5.4 Advanced menu

The Advanced menu items allow you to change the settings for the CPU and other system devices.



Take caution when changing the settings of the Advanced menu items. Incorrect field values can cause the system to malfunction.

```
BIOS SETUP UTILITY
Main  Advanced  Server  Power  Boot  Tools  Exit
-----
▶ CPU Configuration
▶ Chipset Configuration
▶ Onboard Devices Configuration
▶ USB Configuration
▶ PCIPnP

Configure CPU.

←→ Select Screen
↑↓ Select Item
Enter Go to Sub Screen
F1 General Help
F10 Save and Exit
ESC Exit

v02.61 (C) Copyright 1985-2010, American Megatrends, Inc.
```

### 5.4.1 CPU Configuration

The items in this menu show the CPU-related information that the BIOS automatically detects. Some items may not appear if your CPU does not support the related functions.

```
BIOS SETUP UTILITY
Advanced
-----
CPU Configuration
Module Version: 5.1102.1
Physical Count: 2
Logical Count : 12

AMD Opteron(tm) Processor 6172
Revision: D1
Cache L1: 128KB
Cache L2: 512KB
Cache L3: 12MB
Speed : 2100MHz, NB Clk: 1800MHz
Able to Change Freq. : Yes
uCode Patch Level : 0x10000C4

GART Error Reporting [Disabled]
Microcode Updation [Enabled]
Secure Virtual Machine Mode [Enabled]
PowerNow [Enabled]
PowerCap [P-state 0]
ACPI SRAT Table [Enabled]
CIE Support [Enabled]

This option should remain disabled for the normal operation.
The driver developer may enable it for testing purpose.

←→ Select Screen
↑↓ Select Item
+/- Change Option
F1 General Help
F10 Save and Exit
ESC Exit

v02.61 (C) Copyright 1985-2010, American Megatrends, Inc.
```

Scroll down for more items.

```
-----
CPU2 [Enabled]
-----

v02.61 (C) Copyright 1985-2010, American Megatrends, Inc.
```

### **GART Error Reporting [Disabled]**

This option should remain disabled for the normal operation. The driver developer may enable it for testing purpose. Configuration options: [Disabled] [Enabled]

### **Microcode Updation [Enabled]**

Allows the system to update the Microcode automatically, enhancing system performance. Configuration options: [Disabled] [Enabled]

### **Secure Virtual Machine Mode [Enabled]**

Allows you to enable or disable the AMD Secure Virtual Machine. Configuration options: [Disabled] [Enabled]

### **PowerNow [Enabled]**

Allows you to enable or disable the generation of ACPI\_PPC/\_PSS/\_PCT objects. Configuration options: [Enabled] [Disabled]

### **PowerCap [P-state 0]**

Allows you to select the highest performance P-state in OS. Configuration options: [P-state 0] [P-state 1] [P-state 2] [P-state 3] [P-state 4]

### **ACPI SRAT Table [Enabled]**

Allows you to enable or disable the building of ACPI SRAT Table. Configuration options: [Enabled] [Disabled]

### **C1E Support [Enabled]**

Allows you to enable or disable the C1E support function. This item should be enabled in order to enable the Enhanced Halt State. Configuration options: [Disabled] [Enabled]

### **CPU2 [Enabled]**

Allows you to enable or disable CPU2. Configuration options: [Enabled] [Disabled]

## 5.4.2 Chipset Configuration

The Chipset configuration menu allows you to change advanced chipset settings. Select an item then press <Enter> to display the submenu.

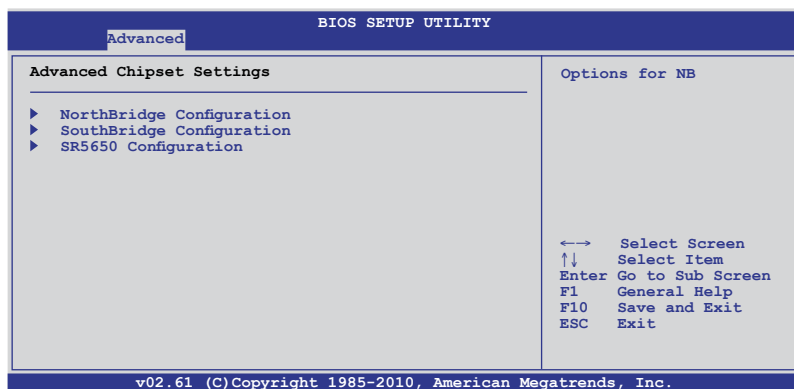

## NorthBridge Configuration

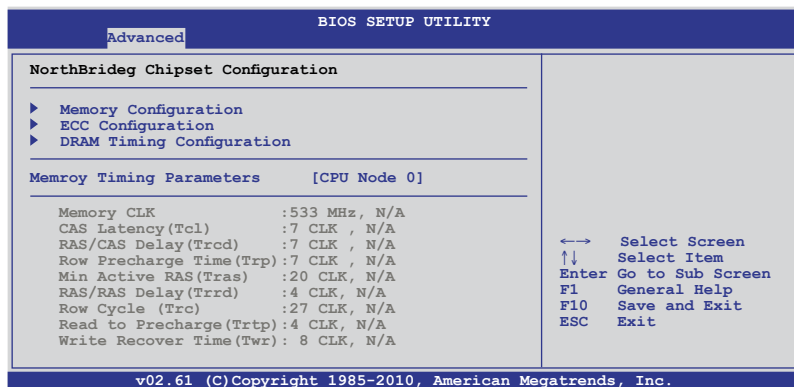



## Memory Configuration

The memory configuration menu allows you to change the memory settings.

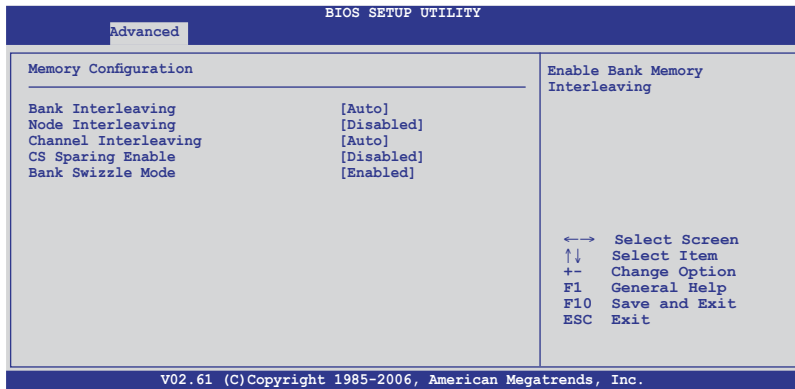

### Bank Interleaving [Auto]

Enables the Bank memory interleaving.

Configuration options: [Disabled] [Auto]

### Node Interleaving [Disabled]

Enables the Node memory interleaving.

Configuration options: [Disabled] [Auto]

### Channel Interleaving [Auto]

Enables the Channel memory interleaving.

Configuration options: [Disabled] [Auto]

### CS Sparing Enable [Disabled]

Allows you to reserve a spare memory rank in each node.

Configuration options: [Disabled] [Enabled]

### Bank Swizzle Mode [Enabled]

Allows you to enable or disable the Bank Swizzle mode.

Configuration options: [Disabled] [Enabled]

## ECC Configuration

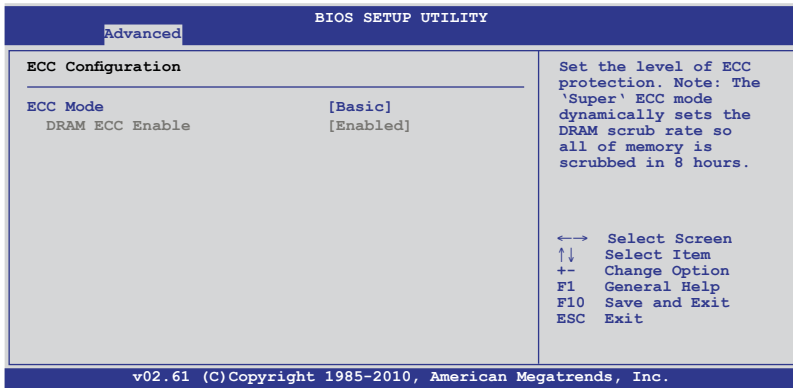

### ECC Mode [Basic]

Disables or sets the DRAM ECC mode that allows the hardware to report and correct memory errors.

Configuration options: [Disabled] [Basic] [Good] [Super] [Max] [User]

## DRAM Timing Configuration

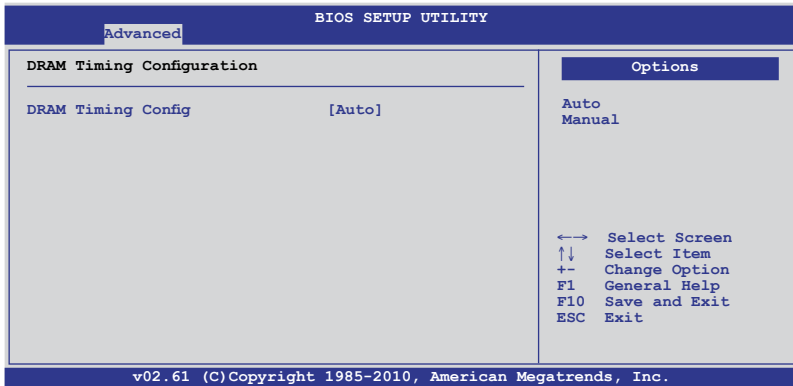

### DRAM Timing Config [Auto]

Allows you to select the DRAM timing mode. Configuration options: [Auto] [Manual]

### Memory Clock Speed [400 MHz]

This item appears only when you set the **DRAM Timing Config** item to [Manual] and allows you to set the memory clock frequency.

Configuration options: [400 MHz] [533 MHz] [667 MHz]

## Memory Timing Parameters [CPU Node 0]

Allows you to select which node's timing parameters to display.

## SouthBridge Configuration

BIOS SETUP UTILITY	
Advanced	
<b>SouthBridge Chipset Configuration</b>	<b>Options for SB Debug Features</b>
SP5100 CIMx Version : 5.5.0	
<b>SB Debug Configuration</b>	
OHCI HC (Bus 0 Dev 18 Fn 0)	[Enabled]
OHCI HC (Bus 0 Dev 18 Fn 1)	[Enabled]
EHCI HC (Bus 0 Dev 18 Fn 2)	[Enabled]
OHCI HC (Bus 0 Dev 19 Fn 0)	[Enabled]
OHCI HC (Bus 0 Dev 19 Fn 1)	[Enabled]
EHCI HC (Bus 0 Dev 19 Fn 2)	[Enabled]
OHCI HC (Bus 0 Dev 20 Fn 5)	[Enabled]
←→ Select Screen ↑↓ Select Item Enter Go to Sub Screen F1 General Help F10 Save and Exit ESC Exit	
v02.61 (C) Copyright 1985-2010, American Megatrends, Inc.	

## SB Debug Configuration

SouthBridge Debug Configuration	
Advanced	
A15 ECOs	[Disable]
Port 0 ESP	[ISP]
Port 1 ESP	[ISP]
Port 2 ESP	[ISP]
Port 3 ESP	[ISP]
Port 4 ESP	[ISP]
Port 5 ESP	[ISP]
Dis #THRMTRIP Before KBRst	[Enabled]
SATA-IDE Ports Auto Clk Ctrl	[Disable]
SATA-AHCI Ports Auto Clk Ctrl	[Disable]
SATA PORT0 MODE	[Auto]
SATA PORT1 MODE	[Auto]
SATA PORT2 MODE	[Auto]
SATA PORT3 MODE	[Auto]
SATA PORT4 MODE	[Auto]
SATA PORT5 MODE	[Auto]
<b>Options</b>	
Disable Enabled	
←→ Select Screen ↑↓ Select Item +- Change Option F1 General Help F10 Save and Exit ESC Exit	
v02.61 (C) Copyright 1985-2010, American Megatrends, Inc.	

### A15 ECOs [Disable]

Configuration options: [Disable] [Enabled]

### Port 0/1/2/3/4/5 ESP [ISP]

Selects the type or the Port ESP help.

Configuration options: [ISP] [ESP]

### Dis #THRMTRIP Before KBRst [Enabled]

Configuration options: [Enabled] [Disabled]

### SATA-IDE Ports Auto Clk Ctrl [Disable]

When set to [Enabled], the system will turn off the clocks for the unused SATA ports in IDE modes. Doing so will enable some power savings.

Configuration options: [Disable] [Enabled]



The hot-plug function will be disabled when turning off the clock for the SATA port.

SATA-AHCI Ports Auto Clk Ctrl [Disable]

When set to [Enabled], the system will turn off the clocks for the unused SATA ports in AHCI modes. Doing so will enable some power savings.

Configuration options: [Disable] [Enabled]



---

The hot-plug function will be disabled when turning off the clock for the SATA port.

---

SATA PORT0/1/2/3/4/5 MODE [Auto]

When set to [GEN1], the SATA port will run at GEN1 mode. Setting to [Auto] will leave the SATA port to run at the default mode.

Configuration options: [Auto] [GEN1]

**OHCI HC (Bus 0 Dev 18 Fn 0) [Enabled]**

Configuration options: [Disabled] [Enabled]

**OHCI HC (Bus 0 Dev 18 Fn 1) [Enabled]**

Configuration options: [Disabled] [Enabled]

**EHCI HC (Bus 0 Dev 18 Fn 2) [Enabled]**

Configuration options: [Disabled] [Enabled]

**OHCI HC (Bus 0 Dev 19 Fn 0) [Enabled]**

Configuration options: [Disabled] [Enabled]

**OHCI HC (Bus 0 Dev 19 Fn 1) [Enabled]**

Configuration options: [Disabled] [Enabled]

**EHCI HC (Bus 0 Dev 19 Fn 2) [Enabled]**

Configuration options: [Disabled] [Enabled]

**OHCI HC (Bus 0 Dev 20 Fn 5) [Enabled]**

Configuration options: [Disabled] [Enabled]

## SR5650 Configuration

Advanced	
<b>SR5650 Configuration</b>	<b>PCI Express Configur</b>
▶ PCI Express Configuration	
▶ Hyper Transport Configuration	
IOMMU [Disabled]	
Primary Video Controller [Slot1-PIKE-PCI]	
▶ Debug Option	
	←→ Select Screen ↑↓ Select Item Enter Go to Sub Screen F1 General Help F10 Save and Exit ESC Exit
v02.61 (C)Copyright 1985-2010, American Megatrends, Inc.	

## PCI Express Configuration

Advanced	
<b>PCI Express Configuration</b>	
▶ PCIE Slot 1 Features	
▶ PIKE Slot Features	
▶ NB-SB Port Features	
▶ PCIE Slot 1 Core Setting	
▶ PIKE Slot Core Setting	
▶ SB Core Setting	
	←→ Select Screen ↑↓ Select Item Enter Go to Sub Screen F1 General Help F10 Save and Exit ESC Exit
v02.61 (C)Copyright 1985-2010, American Megatrends, Inc.	

### PCIE Slot 1/PIKE Slot Features

Select an item, and then press <Enter> to display its sub-items.

#### **Gen2 High Speed Mode [Auto]**

Configuration options: [Auto] [Disabled] [Software Initiated] [Advertised RC]

#### **Link ASPM [Disabled]**

Configuration options: [Disabled] [L0s] [L1] [L0s & L1] [L0s Downstream] [L0s Downstream + L1]

#### **Compliance Mode [Disabled]**

Configuration options: [Disabled] [Enable]

#### **Lane Reversal [Disabled]**

Configuration options: [Disabled] [Enabled]

### NB-SB Port Features

Press <Enter> to display the sub-items.

#### **NB-SB Link ASPM [L1]**

Configuration options: [Disabled] [L1]

#### **NP NB-SB VC1 Traffic Support [Disabled]**

Configuration options: [Disabled] [Enabled]

#### **Complicance Mode [Disabled]**

Configuration options: [Disabled] [Enable]

### PCIe Slot 1/PIKE Slot/SB Core Setting

Select an item, and then press <Enter> to display its sub-items.

#### **Powerdown Unused lanes [Enabled]**

This item is available only for the **PCIe Slot 1/PIKE Slot Core Setting**.

Configuration options: [Disabled] [Enabled]

#### **Turn Off PLL During L1/L23 [Enable]**

This item is available only for the **PCIe Slot 1/PIKE Slot Core Setting**.

Configuration options: [Enable] [Disabled]

#### **TX Drive Strength [Auto]**

Configuration options: [Auto] [26mA] [20mA] [22mA] [24mA]

#### **TXCLK Clock Gating in L1 [Enable]**

Configuration options: [Enable] [Disabled]

#### **LCLK Clock Gating in L1 [Enable]**

Configuration options: [Enable] [Disabled]

## Hyper Transport Configuration

Advanced	
<b>Hyper Transport Configuration</b>	
HT Extended Address	[Disabled]
HT3 Link Power State	[Auto]
UnitID Clumping	[Auto]
HT Link Tristate	[Auto]
NB Deempasies Level	[Disabled]

Options
Auto
Disabled
Enabled
←→ Select Screen
↑↓ Select Item
+− Change Option
F1 General Help
F10 Save and Exit
ESC Exit

v02.61 (C) Copyright 1985-2010, American Megatrends, Inc.

### HT Extended Address [Disabled]

Configuration options: [Auto] [Disabled] [Enable]

### HT3 Link Power State [Auto]

Configuration options: [Auto] [LS0] [LS1] [LS2] [LS3]

### UnitID Clumping [Auto]

Configuration options: [Auto] [Disabled] [UnitID 2/3] [UnitID B/C]  
[UnitID 2/3&B/C]

### HT Link Tristate [Auto]

Configuration options: [Auto] [Disabled] [CAD/CTL] [CAD/CTL/CLK]

### NB Deempasies Level [Disabled]

Configuration options: [Disabled] [-0.4dB] [-1.32dB] [-2.08dB] [-3.1dB]  
[-4.22dB] [-5.50dB] [-7.05dB]

## **IOMMU [Disabled]**

Configuration options: [Disabled] [Enable]

## **Primary Video Controller [Slot1-PIKE-PCI]**

Allows you to select the primary video controller.

Configuration options: [Slot1-PIKE-PCI] [PIKE-Slot1-PCI] [PCI-Slot1-PIKE]

## Debug Option

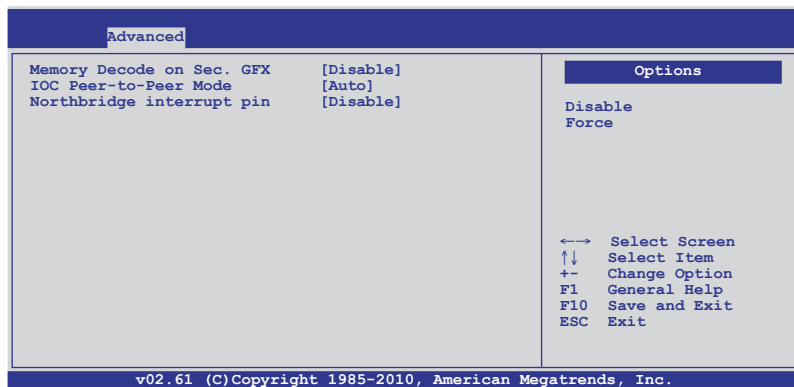

### Memory Decode on Sec. GFX [Disable]

Configuration options: [Disable] [Force]

### IOC Peer-to-Peer Mode [Auto]

Configuration options: [Auto] [Default] [Mode 1] [Mode 2]

### Northbridge interrupt pin [Disable]

Configuration options: [Disable] [Enabled]



## 5.4.3 Onboard Devices Configuration

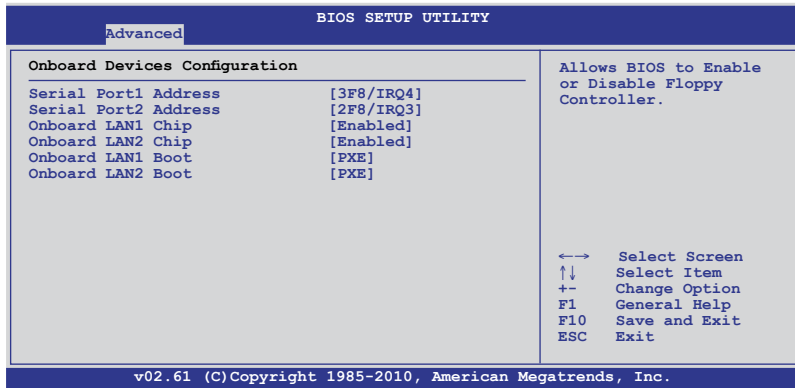

### Serial Port1 Address [3F8/IRQ4]

Allows you to select the Serial Port1 base address.

Configuration options: [Disabled] [3F8/IRQ4] [3E8/IRQ4] [2E8/IRQ3]

### Serial Port2 Address [2F8/IRQ3]

Allows you to select the Serial Port2 base address.

Configuration options: [Disabled] [2F8/IRQ3] [3E8/IRQ4] [2E8/IRQ3]

### Onboard LAN1/LAN2 Chip [Enabled]

Enables or disables the onboard LAN1/2 controller.

Configuration options: [Disabled] [Enabled]

### Onboard LAN1/LAN2 Boot [PXE]

Allows you to configure the onboard LAN1/2 boot mode.

Configuration options: [Disabled] [PXE] [iSCSI]

## 5.4.4 USB Configuration

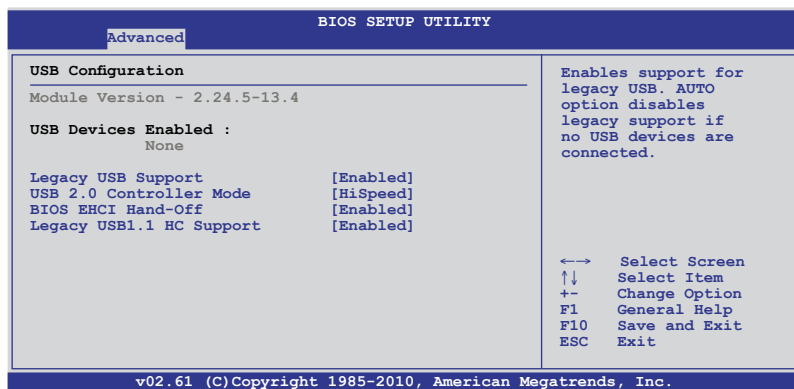

The **USB Devices Enabled** item shows the auto-detected values. If no USB device is detected, the item shows **None**.

### Legacy USB Support [Enabled]

Allows you to enable or disable support for legacy USB devices. Setting to [Auto] allows the system to detect the presence of USB devices at startup. If detected, the USB controller legacy mode is enabled. If no USB device is detected, the legacy USB support is disabled. Configuration options: [Disabled] [Enabled] [Auto]

### USB 2.0 Controller Mode [HiSpeed]

Allows you to set the USB 2.0 controller to HiSpeed (480Mbps) or FullSpeed (12Mbps). Configuration options: [FullSpeed] [HiSpeed]

### BIOS EHCI Hand-Off [Enabled]

Enables or disables the BIOS EHCI hand-off support. Configuration options: [Disabled] [Enabled]



The following item appears only when you set **Legacy USB Support** to [Enabled].

### Legacy USB1.1 HC Support [Enabled]

This item appears only when you set Legacy USB Support to [Enabled], and allows you to configure the Legacy USB1.1 HC support. Configuration options: [Disabled] [Enabled]

## 5.4.5 PCIPnP

The PCIPnP menu items allow you to change the advanced settings for PCI/PnP devices.



Take caution when changing the settings of the PCI/PnP Configuration menu items. Incorrect field values can cause the system to malfunction.

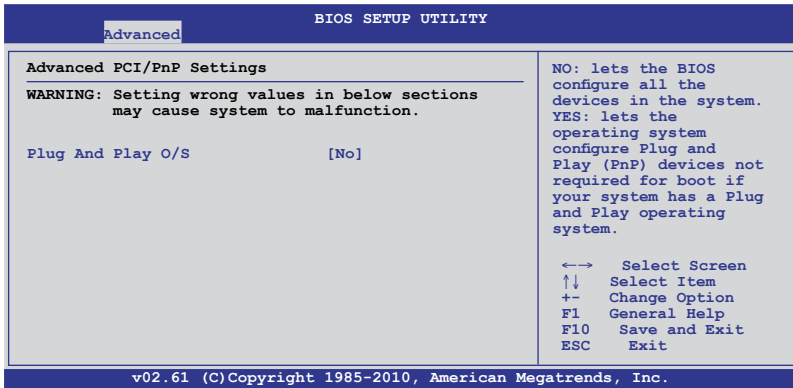

### Plug And Play O/S [No]

When set to [No], BIOS configures all the devices in the system. When set to [Yes] and if you install a Plug and Play operating system, the operating system configures the Plug and Play devices not required for boot.

Configuration options: [No] [Yes]

## 5.5 Server menu

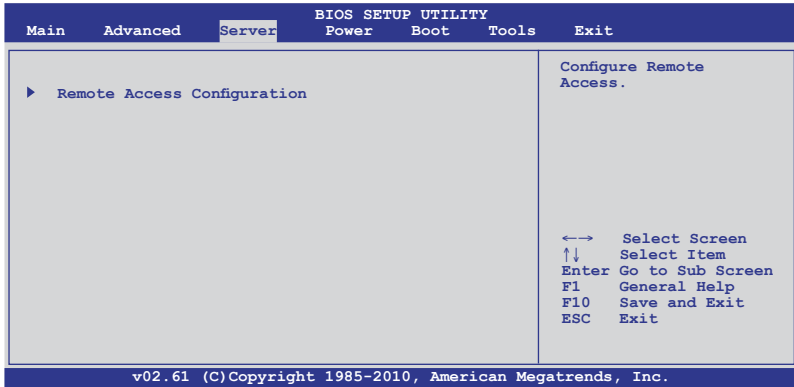

### Remote Access Configuration

The items in this menu allows you to configure the Remote Access features. Select an item then press <Enter> to display the configuration options.

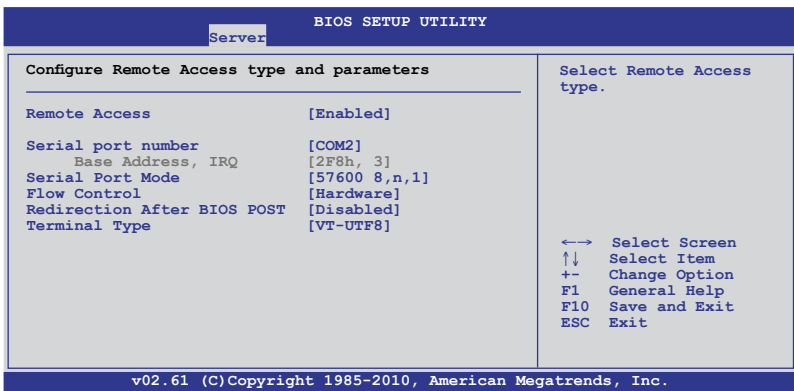

### Remote Access [Enabled]

Enables or disables the remote access feature.

Configuration options: [Disabled] [Enabled]



The following items appear only when **Remote Access** is set to [Enabled].

### Serial port number [COM2]

Selects the serial port for console redirection.

Configuration options: [COM1] [COM2]

Base Address, IRQ [2F8h, 3]

This item is not user-configurable and changes with the configuration of Serial port number.

### **Serial Port Mode [57600 8,n,1]**

Sets the Serial port mode.

Configuration options: [115200 8,n,1] [57600 8,n,1] [38400 8,n,1] [19200 8,n,1] [09600 8,n,1]

### **Flow Control [Hardware]**

Allows you to select the flow control for console redirection.

Configuration options: [None] [Hardware] [Software]

### **Redirection After BIOS POST [Disabled]**

Sets the redirection mode after the BIOS Power-On Self-Test (POST). Some operating systems may not work when set to [Always].

Configuration options: [Disabled] [Boot Loader] [Always]

### **Terminal Type [VT-UTF8]**

Allows you to select the target terminal type.

Configuration options: [ANSI] [VT100] [VT-UTF8]

## 5.6 Power menu

The Power menu items allow you to change the settings for the Advanced Power Management (APM). Select an item then press <Enter> to display the configuration options.

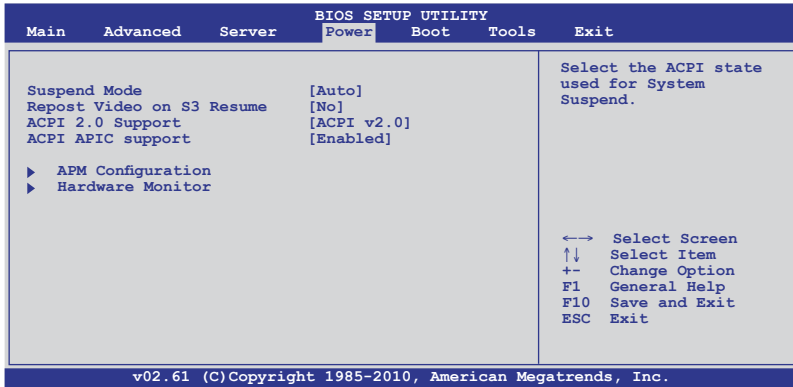

### 5.6.1 Suspend Mode [Auto]

Allows you to select the Advanced Configuration and Power Interface (ACPI) state to be used for system suspend.

Configuration options: [S1 (POS) only] [S3 only] [Auto]

### 5.6.2 Repost Video on S3 Resume [No]

Determines whether to invoke VGA BIOS POST on S3/STR resume.

Configuration options: [No] [Yes]

### 5.6.3 ACPI 2.0 Support [ACPI v2.0]

Specifies the Advanced Configuration and Power Interface (ACPI) version supported. Configuration options: [ACPI v1.0] [ACPI v2.0] [ACPI v3.0]

### 5.6.4 ACPI APIC support [Enabled]

Allows you to enable or disable the Advanced Configuration and Power Interface (ACPI) support in the Advanced Programmable Interrupt Controller (APIC). When set to Enabled, the ACPI APIC table pointer is included in the RSDT pointer list.

Configuration options: [Disabled] [Enabled]

## 5.6.5 APM Configuration

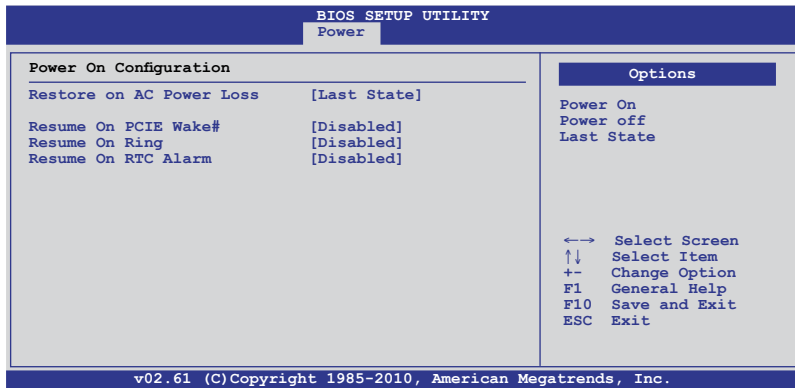

### Restore on AC Power Loss [Last State]

When set to [Power Off], the system goes into off state after an AC power loss. When set to [Power On], the system will reboot after an AC power loss. When set to [Last State], the system goes into either off or on state, whatever the system state was before the AC power loss.

Configuration options: [Power Off] [Power On] [Last State]

### Resume On PCIE Wake# [Disabled]

When set to [Enabled], the system enables the PCI-E to generate a wake event while the computer is in Soft-off mode.

Configuration options: [Disabled] [Enabled]

### Resume On Ring [Disabled]

When set to [Enabled], the system enables RI to generate a wake event while the computer is in Soft-off mode. Configuration options: [Disabled] [Enabled]

### Resume On RTC Alarm [Disabled]

Allows you to enable or disable RTC to generate a wake-up event.

Configuration options: [Disabled] [Enabled]



The following items appear only when the **Resume On RTC Alarm** item is set to [Enabled].

#### RTC Alarm Date [15]

To set the alarm date, highlight this item and press the <+> or <-> key to make the selection.

#### System Time [12:30:30]

Use the <ENTER>, <TAB> or <SHIFT-TAB> key to select a field. Use the <+> or <-> key to configure alarm time.

## 5.6.6 Hardware Monitor

BIOS SETUP UTILITY	
Power	
Hardware Monitor	
CPU1 Temperature	[ 27.5°C/ 81.5°F ]
CPU2 Temperature	[ N/A ]
TR1 Temperature	[ N/A ]
TR2 Temperature	[ N/A ]
CPU Fan1 Speed	[ N/A ]
CPU Fan2 Speed	[ N/A ]
Front Fan1 Speed	[ 6221RPM ]
Front Fan2 Speed	[ 6164RPM ]
Front Fan3 Speed	[ 6221RPM ]
Front Fan4 Speed	[ 6490RPM ]
Front Fan5 Speed	[ 6585RPM ]
Rear Fan1 Speed	[ N/A ]
Fan Speed Control	[Generic Mode]
VCORE1 Voltage	[ 1.090 V ]
VCORE2 Voltage	[ N/A ]
P1DDR3 Voltage	[ 1.532 V ]
P2DDR3 Voltage	[ N/A ]
P1 +1.2V Voltage	[ 1.220 V ]

←→ Select Screen  
↑↓ Select Item  
+/- Change Option  
F1 General Help  
F10 Save and Exit  
ESC Exit

v02.61 (C)Copyright 1985-2010, American Megatrends, Inc.

Scroll down for more items.

P2 +1.2V Voltage	[ N/A ]
P1_VDDNB Voltage	[ 1.092 V ]
+1.8V Voltage	[ 1.822 V ]
+1.2V Voltage	[ 1.208 V ]
+1.1V Voltage	[ 1.110 V ]
+12V Voltage	[ 12.360 V ]
+5V Voltage	[ 5.036 V ]
+3.3V Voltage	[ 3.282 V ]
+5VSB Voltage	[ 5.088 V ]
+3.3VSB Voltage	[ 3.306 V ]
VBAT Voltage	[ 3.132 V ]

←→ Select Screen  
↑↓ Select Item  
+/- Change Option  
F1 General Help  
F10 Save and Exit  
ESC Exit

v02.61 (C)Copyright 1985-2010, American Megatrends, Inc.

### CPU1/2 Temperature [xxx°C/xxx°F]

### TR1/2 Temperature [xxx°C/xxx°F]

The onboard hardware monitor automatically detects and displays the motherboard component and CPU temperatures. Select [Ignored] if you do not wish to display the detected temperatures.

### CPU Fan1/2; Front Fan1-5 Speed [xxxxRPM] or [Ignored] / [N/A]

### Rear Fan1 Speed [xxxxRPM] or [Ignored] / [N/A]

The onboard hardware monitor automatically detects and displays the speed of CPU fans, front fans, and rear fan in rotations per minute (RPM). If the fan is not connected to the motherboard, the field shows [N/A].

### Fan Speed Control [Generic Mode]

Allows you to configure the ASUS Smart Fan feature that smartly adjusts the fan speeds for more efficient system operation.

Configuration options: [Full Speed Mode] [Whisper Mode] [Generic Mode] [High Density Mode]



**VCORE1/2 Voltage, P1/2DDR3 Voltage, P1/2\_+1.2V Voltage,  
P1\_VDDNB Voltage, +1.8V Voltage, +1.2V Voltage, +1.1V Voltage,  
+12V Voltage, +5V Voltage, +3.3V Voltage, +5VSB Voltage, +3.3VSB  
Voltage, VBAT Voltage**

The onboard hardware monitor automatically detects the voltage output through the onboard voltage regulators. Select [Ignored] if you do not want to detect this item.

## 5.7 Boot menu

The Boot menu items allow you to change the system boot options. Select an item then press <Enter> to display the submenu.

BIOS SETUP UTILITY						
Main	Advanced	Server	Power	Boot	Tools	Exit
<b>Boot Settings</b> <ul style="list-style-type: none"> <li>▶ Boot Device Priority</li> <li>▶ Hard Disk Drives</li> <li>▶ CDROM Drives</li> <li>▶ Boot Settings Configuration</li> <li>▶ Security</li> </ul>			Specifies the Boot Device Priority sequence.  A virtual floppy disk drive (Floppy Drive B:) may appear when you set the CD-ROM drive as the first boot device.  ←→ Select Screen ↑↓ Select Item Enter Go to Sub Screen F1 General Help F10 Save and Exit ESC Exit			
v02.61 (C)Copyright 1985-2010, American Megatrends, Inc.						

### 5.7.1 Boot Device Priority

BIOS SETUP UTILITY	
Boot	
<b>Boot Device Priority</b>	
1st Boot Device [Removable Dev.] 2nd Boot Device [ATAPI CD-ROM] 3rd Boot Device [Hard Drive] 4th Boot Device [Network:IBA GE Slo] 5th Boot Device [Network:IBA GE Slo]	Specifies the Boot Device Priority sequence.  A device enclosed in parenthesis has been disabled in the corresponding type menu.  ←→ Select Screen ↑↓ Select Item +- Change Option F1 General Help F10 Save and Exit ESC Exit
v02.61 (C)Copyright 1985-2010, American Megatrends, Inc.	

#### 1st-xth Boot Device [XXXXXXX]

These items specify the boot device priority sequence from the available devices. The number of device items that appears on the screen depends on the number of devices installed in the system.

Configuration options: [Removable Dev.] [ATAPI CD-ROM] [Hard Drive] [Network:IBA GE Slot 0300 v1234] [Ntework:IBA GE Slot 0200 v1324] [Disabled]

### 5.7.2 Hard Disk Drives; CDROM Drives

These two items appear only when you install hard disk drives or optical drives to you system. These items allow you to specify the boot priority sequence of the hard disk drives or the optical drives.

## 5.7.3 Boot Settings Configuration

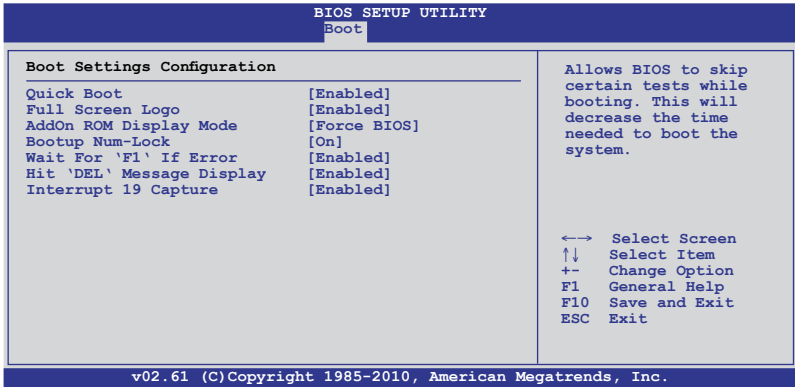

### Quick Boot [Enabled]

Enabling this item allows the BIOS to skip some power on self tests (POST) while booting to decrease the time needed to boot the system. When set to [Disabled], BIOS performs all the POST items. Configuration options: [Disabled] [Enabled]

### Full Screen Logo [Enabled]

Allows you to enable or disable the full screen logo display feature. Configuration options: [Disabled] [Enabled]



Set this item to [Enabled] to use the ASUS MyLogo2™ feature.

### AddOn ROM Display Mode [Force BIOS]

Allows you to set the display mode for Options ROM. Configuration options: [Force BIOS] [Keep Current]

### Bootup Num-Lock [On]

Allows you to select the power-on state for the NumLock. Configuration options: [Off] [On]

### Wait For 'F1' If Error [Enabled]

When set to [Enabled], the system waits for the <F1> key to be pressed when error occurs. Configuration options: [Disabled] [Enabled]

### Hit 'DEL' Message Display [Enabled]

When set to [Enabled], the system displays the message "Press DEL to run Setup" during POST. Configuration options: [Disabled] [Enabled]

### Interrupt 19 Capture [Enabled]

When set to [Enabled], this function allows the option ROMs to trap Interrupt 19. Configuration options: [Disabled] [Enabled]

## 5.7.4 Security

The Security menu items allow you to change the system security settings. Select an item then press <Enter> to display the configuration options.

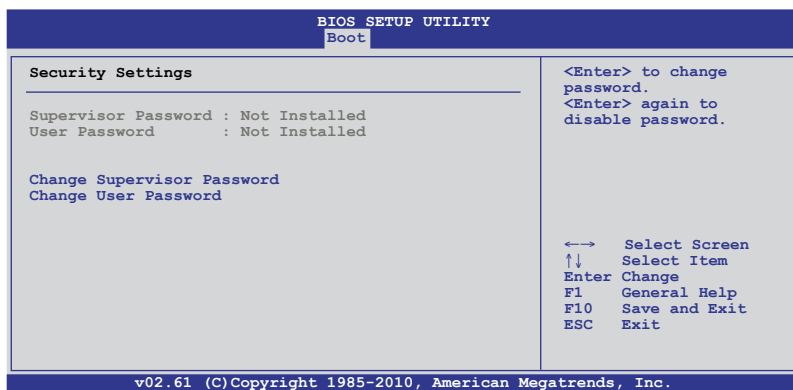

### Change Supervisor Password

Select this item to set or change the supervisor password. The **Supervisor Password** item on top of the screen shows the default **Not Installed**. After you set a password, this item shows **Installed**.

To set a Supervisor Password:

1. Select the **Change Supervisor Password** item and press <Enter>.
2. From the password box, type a password composed of at least six letters and/or numbers, then press <Enter>.
3. Confirm the password when prompted.

The message "Password Installed" appears after you successfully set your password.

To change the supervisor password, follow the same steps as in setting a user password.

To clear the supervisor password, select the **Change Supervisor Password** then press <Enter>. The message "Password Uninstalled" appears.



---

If you forget your BIOS password, you can clear it by erasing the CMOS Real Time Clock (RTC) RAM. See section **4.2 Jumpers** for information on how to erase the RTC RAM.

---

After you have set a supervisor password, the other items appear to allow you to change other security settings.

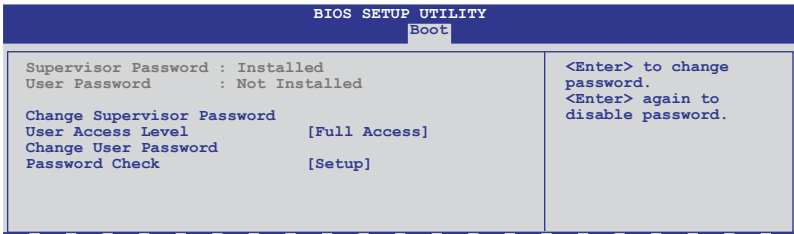

### User Access Level [Full Access]

This item allows you to select the access restriction to the Setup items. Configuration options: [No Access] [View Only] [Limited] [Full Access]

**No Access** prevents user access to the Setup utility.

**View Only** allows access but does not allow change to any field.

**Limited** allows changes only to selected fields, such as Date and Time.

**Full Access** allows viewing and changing all the fields in the Setup utility.

### Change User Password

Select this item to set or change the user password. The **User Password** item on top of the screen shows the default **Not Installed**. After you set a password, this item shows Installed.

To set a User Password:

1. Select the **Change User Password** item and press <Enter>.
2. On the password box that appears, type a password composed of at least six letters and/or numbers, then press <Enter>.
3. Confirm the password when prompted.

The message "Password Installed" appears after you set your password successfully.

To change the user password, follow the same steps as in setting a user password.

### Password Check [Setup]

When set to [Setup], BIOS checks for user password when accessing the Setup utility. When set to [Always], BIOS checks for user password both when accessing Setup and booting the system. Configuration options: [Setup] [Always]

## 5.8 Tools menu

The Tools menu items allow you to configure options for special functions. Select an item then press <Enter> to display the submenu.

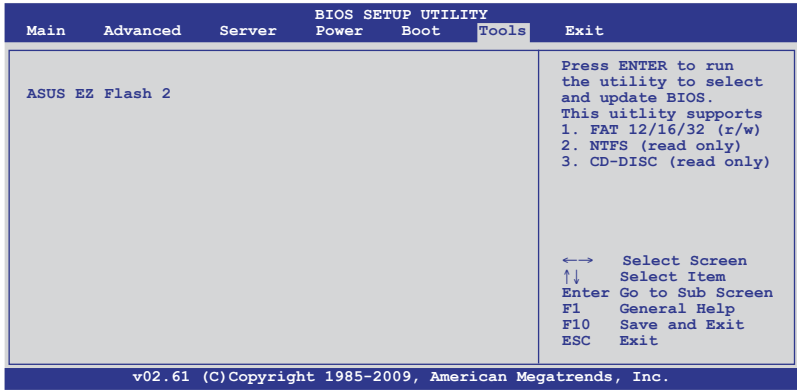

### 5.8.1 ASUS EZ Flash 2

Allows you to run ASUS EZ Flash 2. When you press <Enter>, a confirmation message appears. Use the left/right arrow key to select between [Yes] or [No], then press <Enter> to confirm your choice. Check section **5.1.1 ASUS EZ Flash 2 utility** for details.

## 5.9 Exit menu

The Exit menu items allow you to load the optimal or failsafe default values for the BIOS items, and save or discard your changes to the BIOS items.

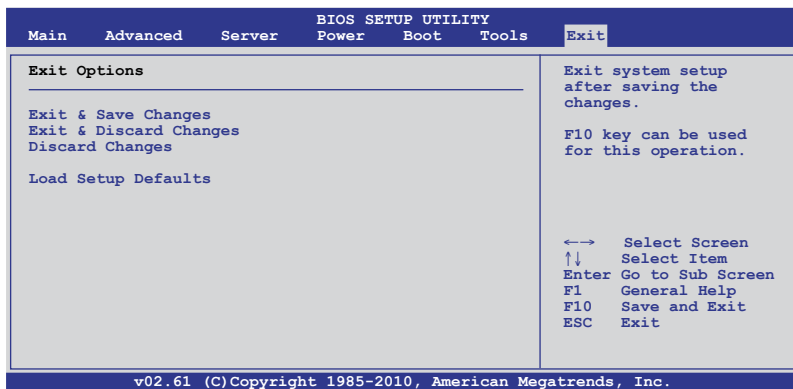

Pressing <Esc> does not immediately exit this menu. Select one of the options from this menu or <F10> from the legend bar to exit.

### Exit & Save Changes

Once you are finished making your selections, choose this option from the Exit menu to ensure the values you selected are saved to the CMOS RAM. An onboard backup battery sustains the CMOS RAM so it stays on even when the PC is turned off. When you select this option, a confirmation window appears. Select YES to save changes and exit.



If you attempt to exit the Setup program without saving your changes, the program prompts you with a message asking if you want to save your changes before exiting. Press <Enter> to save the changes while exiting.

### Exit & Discard Changes

Select this option only if you do not want to save the changes that you made to the Setup program. If you made changes to fields other than System Date, System Time, and Password, the BIOS asks for a confirmation before exiting.

### Discard Changes

This option allows you to discard the selections you made and restore the previously saved values. After selecting this option, a confirmation appears. Select YES to discard any changes and load the previously saved values.

### Load Setup Defaults

This option allows you to load the default values for each of the parameters on the Setup menus. When you select this option or if you press <F5>, a confirmation window appears. Select **YES** to load default values. Select **Exit & Save Changes** or make other changes before saving the values to the non-volatile RAM.





# Chapter 6

This chapter provides instructions for setting up, creating and configuring RAID sets using the available utilities.

# RAID configuration

# 6.1 Setting up RAID

## 6.1.1 RAID definitions

**RAID 0** (*Data striping*) optimizes two identical hard disk drives to read and write data in parallel, interleaved stacks. Two hard disks perform the same work as a single drive but at a sustained data transfer rate, double that of a single disk alone, thus improving data access and storage. Use of two new identical hard disk drives is required for this setup.

**RAID 1** (*Data mirroring*) copies and maintains an identical image of data from one drive to a second drive. If one drive fails, the disk array management software directs all applications to the surviving drive as it contains a complete copy of the data in the other drive. This RAID configuration provides data protection and increases fault tolerance to the entire system. Use two new drives or use an existing drive and a new drive for this setup. The new drive must be of the same size or larger than the existing drive.

**RAID 10** is data striping and data mirroring combined without parity (redundancy data) having to be calculated and written. With the RAID 10 configuration you get all the benefits of both RAID 0 and RAID 1 configurations. Use four new hard disk drives or use an existing drive and three new drives for this setup.

**RAID 5** stripes both data and parity information across three or more hard disk drives. Among the advantages of RAID 5 configuration include better HDD performance, fault tolerance, and higher storage capacity. The RAID 5 configuration is best suited for transaction processing, relational database applications, enterprise resource planning, and other business systems. Use a minimum of three identical hard disk drives for this setup.

**JBOD** (Spanning) stands for Just a Bunch of Disks and refers to hard disk drives that are not yet configured as a RAID set. This configuration stores the same data redundantly on multiple disks that appear as a single disk on the operating system. Spanning does not deliver any advantage over using separate disks independently and does not provide fault tolerance or other RAID performance benefits.

**SPAN** helps to combine the capacity of multiple physical disk drives into one single large drive volume, making the small-sized disk drives more useful. The disk drives in this mode need not to be identical in size or speed.



---

If you want to boot the system from a hard disk drive included in a created RAID set, copy first the RAID driver from the support CD to a floppy disk before you install an operating system to the selected hard disk drive.

---

## 6.1.2 Installing hard disk drives

The motherboard supports Serial ATA for RAID set configuration. For optimal performance, install identical drives of the same model and capacity when creating a disk array.

To install the SATA hard disks for RAID configuration:

1. Install the SATA hard disks into the drive bays following the instructions in the system user guide.
2. Connect a SATA signal cable to the signal connector at the back of each drive and to the SATA connector on the motherboard.
3. Connect a SATA power cable to the power connector on each drive.

## 6.1.3 Setting the RAID item in BIOS

You must set the RAID item in the BIOS Setup before you can create a RAID set from SATA hard disk drives attached to the SATA connectors supported by AMD SP5100 chipset. To do this:

1. Enter the BIOS Setup during POST.
2. Go to the **Main Menu > Storage Configuration**, then press <Enter>.
3. Set **SATA Port1-4** to [RAID] and **SATA Port5-6** will be set to [RAID] too.
4. Press <F10> to save your changes and exit the BIOS Setup.



---

Refer to Chapter 5 for details on entering and navigating through the BIOS Setup.

---

## 6.2 FastBuild Utility

The FastBuild Utility allows you to create RAID 0, RAID 1, RAID 10 ,and RAID 5, SPAN and JBOD set(s) from Serial ATA hard disk drives that are connected to the Serial ATA connectors supported by the Promise RAID.

To enter the FastBuild Utility:

1. Install all the Serial ATA hard disk drives at Red SATA Connector.
2. Turn on the system.
3. During POST, press <Ctrl> + <F> to enter the utility main menu.

```
FastBuild (tm) Utility (c) 2004-2010 Promise Technology, Inc.
[ Main Menu ]
View Drive Assignment .....[ 1 ]
LD View / LD Define Menu .....[ 2 ]
Delete LD Menu .....[ 3 ]
Controller Configuration .....[ 4 ]
[ Keys Available ]
Press 1..4 to Select Option [ESC]Exit
```



The RAID BIOS setup screens shown in this section are for reference only and may not exactly match the items on your screen.

## 6.2.1 Creating a RAID set (RAID 0, RAID 1, RAID 10, RAID 5, SPAN or JBOD)

To create a RAID set:

1. From the main control panel, press <2> to enter the **LD View Menu**.

```
FastBuild (tm) Utility (c) 2004-2010 Promise Technology, Inc.
[ Main Menu ]
View Drive Assignment .....[ 1 ]
LD View / LD Define Menu ....[ 2 ]
Delete LD Menu .....[ 3 ]
Controller Configuration .....[ 4 ]

[ Keys Available ]
Press 1..4 to Select Option [ESC]Exit
```

```
FastBuild (tm) Utility (c) 2004-2010 Promise Technology, Inc.
[ LD View Menu ]
< There is no any LD >

[ Keys Available ]
[↑] Up [↓] Down [PaUp/PaDn] Switch Page [Ctrl+C] Define LD
[Enter] View LD [Ctrl+V] View JBOD Disk [ESC] Exit
```

- Press <Ctrl> + <C> to define an LD and use <Spacebar> to select a desired RAID mode.

```
FastBuild (tm) Utility (c) 2004-2010 Promise Technology, Inc.
[ LD Define Menu ]
LD No LD Name RAID Mode Drv
LD 1 Logical Drive 1 RAID 1 0
Stripe Block 128 KB Initialization Fast
Gigabyte Boundary ON Write Policy WriteThru
Read Policy NA

[ Drives Assignments ]
Port:ID Drive Model Capabilities Capacity(GB) Assignment
01:01 HDTXXXXXXXXXXXXX SATA 3G 250.05 N
02:01 HDTXXXXXXXXXXXXX SATA 3G 250.05 N
03:01 HDTXXXXXXXXXXXXX SATA 3G 250.05 N
04:01 HDTXXXXXXXXXXXXX SATA 3G 250.05 N

[ Keys Available ]
[↑] Up [↓] Down [PaUp/PaDn] Switch Page [Space] Change Option
[Ctrl+Y] Save [ESC] Exit
```

- Use <Spacebar> to set Read Policy to Read Cache and Write Policy to WriteBack.

```
FastBuild (tm) Utility (c) 2004-2010 Promise Technology, Inc.
[ LD Define Menu ]
LD No LD Name RAID Mode Drv
LD 1 Logical Drive 1 RAID 1 0
Stripe Block 128 KB Initialization Fast
Gigabyte Boundary ON Write Policy WriteBack
Read Policy Read Cache

[ Drives Assignments ]
Port:ID Drive Model Capabilities Capacity(GB) Assignment
01:01 HDTXXXXXXXXXXXXX SATA 3G 250.05 N
02:01 HDTXXXXXXXXXXXXX SATA 3G 250.05 N
03:01 HDTXXXXXXXXXXXXX SATA 3G 250.05 N
04:01 HDTXXXXXXXXXXXXX SATA 3G 250.05 N

[ Keys Available ]
[↑] Up [↓] Down [PaUp/PaDn] Switch Page [Space] Change Option
[Ctrl+Y] Save [ESC] Exit
```

- After you have selected the desired RAID mode, use the down arrow key to select desired disks for the RAID set.

```
FastBuild (tm) Utility (c) 2004-2010 Promise Technology, Inc.
[ LD Define Menu ]
LD No  LD Name          RAID Mode  Drv
LD  1  Logical Drive 1  RAID 1    1

Stripe Block      128 KB      Initialization  Fast
Gigabyte Boundary ON           Write Policy    WriteBack
Read Policy        Read Cache

[ Drives Assignments ]
Port:ID  Drive Model  Capabilities  Capacity (GB)  Assignment
01:01    HDTXXXXXXXXX SATA 3G        250.05         Y
02:01    HDTXXXXXXXXX SATA 3G        250.05         N
03:01    HDTXXXXXXXXX SATA 3G        250.05         N
04:01    HDTXXXXXXXXX SATA 3G        250.05         N

[ Keys Available ]
[↑] Up [↓] Down [PaUp/PaDn] Switch Page [Space] Change Option
[Ctrl+Y] Save [ESC] Exit
```

- After you have selected desired disks for the RAID set, press <Ctrl> + <Y> to start building the RAID set.

```
FastBuild (tm) Utility (c) 2004-2010 Promise Technology, Inc.
[ LD Define Menu ]
LD No  LD Name          RAID Mode  Drv
LD  1  Logical Drive 1  RAID 1    2

Stripe Block      128 KB      Initialization  Fast
Gigabyte Boundary ON           Write Policy    WriteBack
Read Policy        Read Cache

[ Drives Assignments ]
Port:ID  Drive Model  Capabilities  Capacity (GB)  Assignment
01:01    HDT         Please Press Ctr-Y key to input the LD name
02:01    HDT         or press any key to exit.
03:01    HDT         If you do not input any LD name, the default
04:01    HDT         LD name will be used.
                                Y
                                Y
                                N
                                N

[ Keys Available ]
[↑] Up [↓] Down [PaUp/PaDn] Switch Page [Space] Change Option
[Ctrl+Y] Save [ESC] Exit
```

- Press <Ctrl> + <Y> again and enter the LD name. Press <Enter> to continue.

```
FastBuild (tm) Utility (c) 2004-2010 Promise Technology, Inc.
[ LD Define Menu ]
LD No  LD Name          RAID Mode  Drv
LD  1  Logical Drive 1  RAID 1    2

Stripe Block  128 KB      Initialization  Fast
Gigabyte Boundary  ON          Write Policy    WriteBack
Read Policy    Read Cache

[ Drives Assignments ]
Port:ID  Drive Model  Capabilities  Capacity(GB)  Assignment
01:01   HDTXXXXXXXXXX  SATA 3G      250.05        Y
02:01   HDTXXXXXXXXXX  SATA 3G      250.05        Y
03:01   HDTXXXXXXXXXX  SATA 3G      250.05        N
04:01   HDTXXXXXXXXXX  SATA 3G      250.05        N
         Enter the LD name here: XXXX

[ Keys Available ]
[↑] Up [↓] Down [PaUp/PaDn] Switch Page [Space] Change Option
[Ctrl+Y] Save [ESC] Exit
```

- All the data on the selected disk drives will be deleted. Press <Ctrl> + <Y> to continue.

```
FastBuild (tm) Utility (c) 2004-2010 Promise Technology, Inc.
[ LD Define Menu ]
LD No  LD Name          RAID Mode  Drv
LD  1  Logical Drive 1  RAID 1    2

Stripe Block  128 KB      Initialization  Fast
Gigabyte Boundary  ON          Write Policy    WriteBack
Read Policy    Read Cache

[ Drives Assignments ]
Port:ID  Drive Model  Capabilities  Capacity(GB)  Assignment
01:01   HDTXXXXXXXXXX  SATA 3G      250.05        Y
02:01   HDTXXXXXXXXXX  SATA 3G      250.05        Y
03:01   HDTXXXXXXXXXX  SATA 3G      250.05        N
04:01   HDTXXXXXXXXXX  SATA 3G      250.05        N
         Fast Initialization Option has been selected.
         It will erase the MBR data of the disks.
         <Press Ctrl-Y Key if you are sure to erase it>
         <Press any other key to ignore this option>

[ Keys Available ]
[↑] Up [↓] Down [PaUp/PaDn] Switch Page [Space] Change Option
[Ctrl+Y] Save [ESC] Exit
```



- Press <Ctrl> + <Y> to modify the disk array size or press any other key to use all the available capacity of the disk drive.

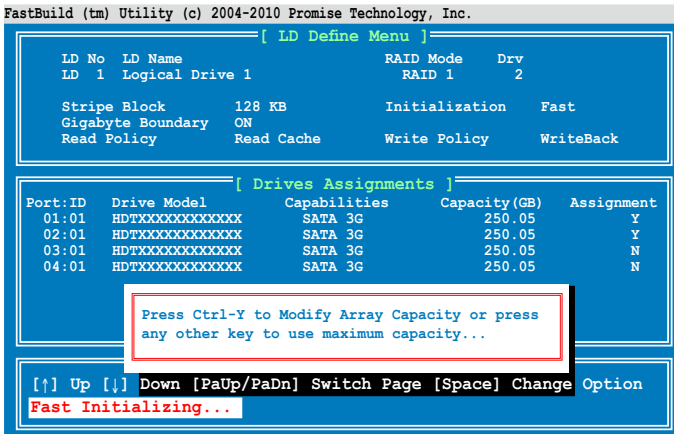

- Use the number keys to enter your desired array capacity.

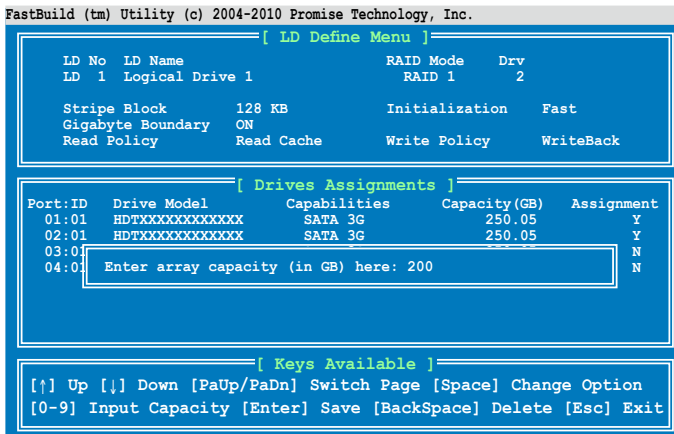

- The RAID set has been built successfully and press <Enter> to view the content.

```
FastBuild (tm) Utility (c) 2004-2010 Promise Technology, Inc.
[ LD View Menu ]
LD No      RAID Mode      Drv      Capacity (GB)      Status
LD 1      RAID 1          2        199.99             Functional
[ Keys Available ]
[↑] Up [↓] Down [PaUp/PaDn] Switch Page [Ctrl+C] Define LD
[Enter] View LD [Ctrl+V] View JBOD Disk [ESC] Exit
```

- Press any key to return to the main control panel.

```
FastBuild (tm) Utility (c) 2004-2010 Promise Technology, Inc.
[ View LD Definition Menu]
LD No  LD Name      RAID Mode      Drv      Capacity (GB)
LD 1   RAID1          RAID 1          2        199.99
Stripe Block      NA
Read Policy      Read Cache      Write Policy      WriteBack
[ Drives Assignments ]
Port:ID  Drive Model      Capabilities      Capacity (GB)
01:01   HDTXXXXXXXXXXXX  SATA 3G           250.05
02:01   HDTXXXXXXXXXXXX  SATA 3G           250.05
Any Key To Continue.....
```

## 6.2.2 Deleting a RAID set

To delete a RAID set:

1. From the main control panel, press <3> to to enter the **Delete LD Menu**.

```
FastBuild (tm) Utility (c) 2004-2010 Promise Technology, Inc.
[ Main Menu ]
View Drive Assignment .....[ 1 ]
LD View / LD Define Menu .....[ 2 ]
Delete LD Menu .....[ 3 ]
Controller Configuration .....[ 4 ]
[ Keys Available ]
Press 1..4 to Select Option [ESC]Exit
```

2. Select the RAID set you would like to delete and press <Del>/<Alt>+<D> to delete the selected RAID set.

```
FastBuild (tm) Utility (c) 2004-2010 Promise Technology, Inc.
[ Delete LD Menu ]
LD No      RAID Mode  Drv      Capacity (GB)  Status
LD 1      RAID 1     2        199.99         Functional
[ Keys Available ]
[↑] Up [↓] Down [PaUp/PaDn] Switch Page [Del/Alt+D] Delete LD
[Ctrl+V] View JBOD Disk [ESC] Exit
```

- Press <Ctrl>+<Y> to confirm and delete the selected RAID set.

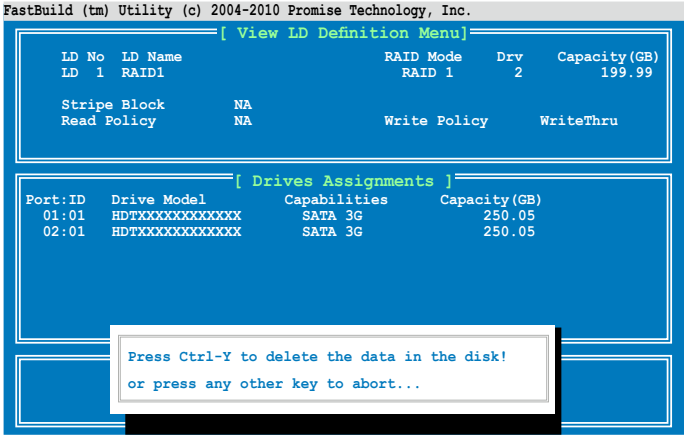

- The selected RAID set has been deleted.

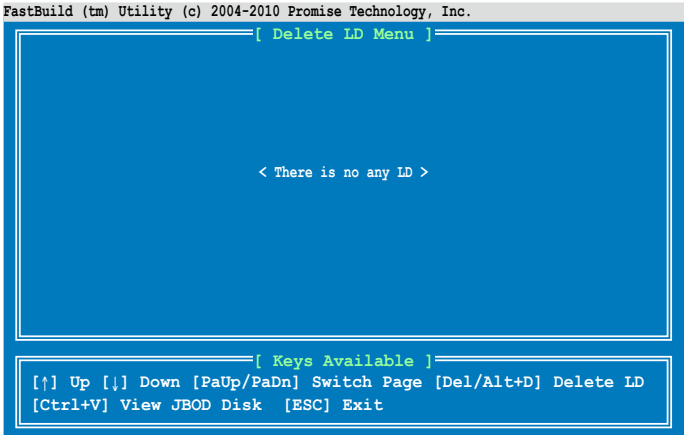

## 6.2.3 Viewing the Drive Assignment

To view the drive assignment:

1. From the main control panel, press <1> to enter the **Drive Assignment Menu**.

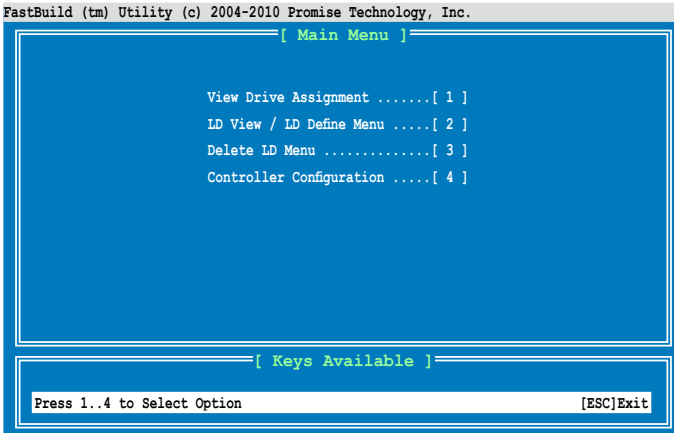

2. The drive assignment is displayed as shown.

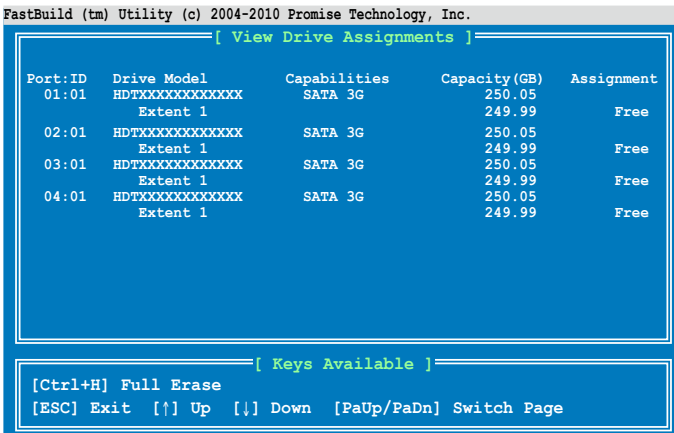

## 6.2.4 Viewing the Controller Configuration

To view the controller configuration:

1. From the main control panel, press <4> to enter the **Controller Configuration Menu**.

```
FastBuild (tm) Utility (c) 2004-2010 Promise Technology, Inc.
[ Main Menu ]
View Drive Assignment .....[ 1 ]
LD View / LD Define Menu .....[ 2 ]
Delete LD Menu .....[ 3 ]
Controller Configuration .....[ 4 ]

[ Keys Available ]
Press 1..4 to Select Option [ESC]Exit
```

2. The system resources configuration is displayed as shown.

```
FastBuild (tm) Utility (c) 2004-2010 Promise Technology, Inc.
[ Adapter Configuration - Options ]
No Parameters Defined for Current Disk(s)...

[ System Resources Configuration ]
Controller IRQ: 10
AHCI HBA MMIO Base Address: FAF FE400

[ Keys Available ]
[ESC] Exit
```

# Chapter 7

This chapter provides instructions for installing the necessary drivers for different system components.

# Driver installation

## 7.1 RAID driver installation

After creating the RAID sets for your server system, you are now ready to install an operating system to the independent hard disk drive or bootable array. This part provides instructions on how to install the RAID controller drivers during OS installation.



The RAID card driver might be included in the Linux OS installation CD, and could be loaded automatically during the OS installation. However, we recommend you use the RAID driver packaged in the RAID card support CD for a better reliability.

### 7.1.1 Creating a RAID driver disk



The system does not include a floppy drive. You have to use a USB floppy drive when creating a SATA RAID driver disk.



When you use a SATA optical drive and PROMISE RAID, you cannot boot into FreeDOS using this support CD. Either reset **SATA Port1-4** in BIOS to [IDE] and boot again or create the RAID driver in another computer.

A floppy disk with the RAID driver is required when installing Windows® or Red Hat® Enterprise operating system on a hard disk drive that is included in a RAID set. You can create a RAID driver disk in DOS (using the Makedisk application in the support DVD).

To create a RAID driver disk in DOS environment

1. Place the motherboard support DVD in the optical drive.
2. Restart the computer, and then enter the BIOS Setup.
3. Select the optical drive as the first boot priority to boot from the support DVD. Save your changes, and then exit the BIOS Setup.
4. Restart the computer. The Makedisk menu appears.

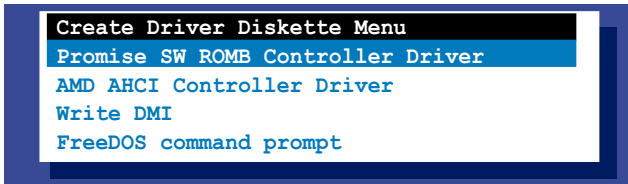



5. Use the arrow keys to select the type of RAID driver disk you want to create and press <Enter> to enter the sub-menu.

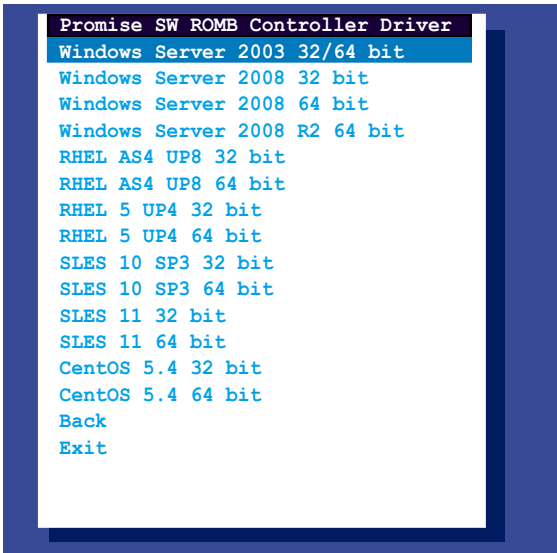

6. Locate the RAID driver and place a blank, high-density floppy disk to the floppy disk drive.
7. Press <Enter>.
8. Follow screen instructions to create the driver disk.

## 7.1.2 Installing the RAID controller driver

### Windows® Server OS

During Windows® Server OS installation

To install the RAID controller driver when installing Windows® Server OS:

1. Boot the computer using the Windows® Server installation DVD. The Windows® Server OS Setup starts.

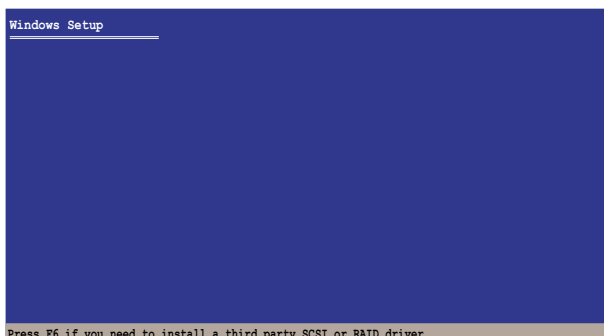

2. Press <F6> when the message “Press F6 if you need to install a third party SCSI or RAID driver...” appears at the bottom of the screen.
3. When prompted, press <S> to specify an additional device.



4. Insert the RAID driver disk you created earlier to the floppy disk drive, then press <Enter>.

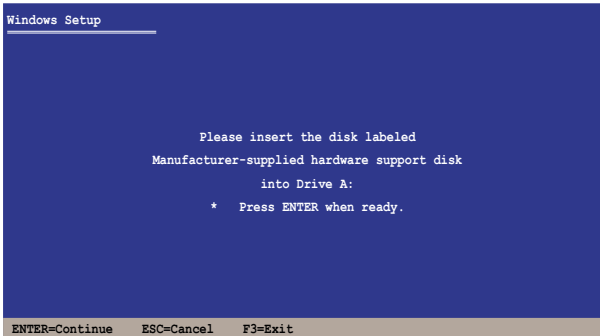

5. Select the RAID controller driver you need from the list, then press <Enter>.
6. The Windows® Setup loads the RAID controller drivers from the RAID driver disk. When prompted, press <Enter> to continue installation.
7. Setup then proceeds with the OS installation. Follow screen instructions to continue.

### To an existing Windows® Server OS

To install the RAID controller driver on an existing Windows® Server OS

1. Restart the computer, and then log in with **Administrator** privileges.
2. Windows® automatically detects the RAID controller and displays a **New Hardware Found** window. Click **Cancel**.
3. Right-click the **My Computer** icon on the Windows® desktop, and then select **Properties** from the menu.
4. Click the **Hardware** tab, and then click the **Device Manager** button to display the list of devices installed in the system.
5. Right-click the **RAID controller** item, then select **Properties**.
6. Click the **Driver** tab, and then click the **Update Driver** button.
7. The **Upgrade Device Driver Wizard** window appears. Click **Next**.
8. Insert the RAID driver disk you created earlier to the floppy disk drive.
9. Select the option **Install the software automatically (Recommended)**, and then click **Next**.
10. The wizard searches the RAID controller drivers. When found, click **Next** to install the drivers.
11. Click **Finish** after the driver installation is done.

To verify the RAID controller driver installation:

1. Right-click the **My Computer** icon on the Windows® desktop, and then select **Properties** from the menu.
2. Click the **Hardware** tab, and then click the **Device Manager** button.
3. Click the “+” sign before the item **SCSI and RAID controllers**, and then the **Promise AHCI Compatible RAID Controller** item should appear.

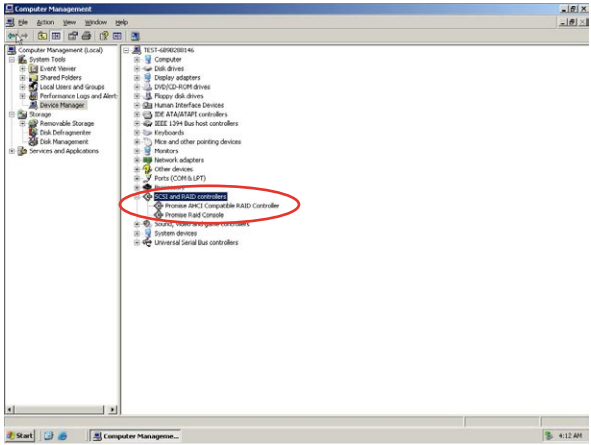

---

The screen differs based on the controller.

---

4. Right-click the **RAID controller** driver item, and then select **Properties** from the menu.
5. Click the **Driver** tab, and then click the **Driver Details** button to display the RAID controller drivers.
6. Click **OK** when finished.

## Red Hat® Enterprise Linux OS 4.7/4.8

To install the RAID controller driver when installing Red Hat® Enterprise OS:

1. Boot the system from the Red Hat® OS installation CD.
2. At the `boot:`, type `linux dd`.
3. Press <Enter>.

```
- To install or upgrade in graphical mode, press the <ENTER> key.
- To install or upgrade in text mode, type: linux text <ENTER>.
- Use the function keys listed below for more information.
[F1-Main] [F2-Options] [F3-General] [F4-Kernel] [F5-Rescue]
boot: linux dd
```

4. Select **Yes** using the <Tab> key when asked if you have the driver disk, then press <Enter>.

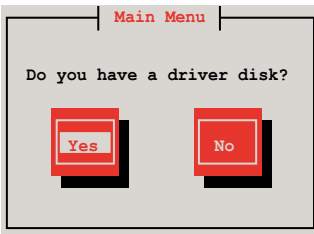

5. Press <Enter> to continue.

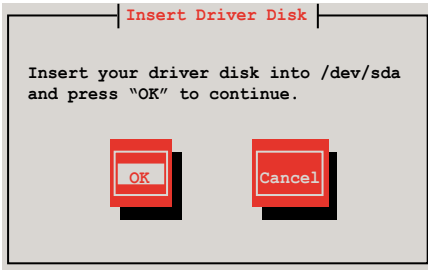

6. Select **No** and press <Enter> to continue.

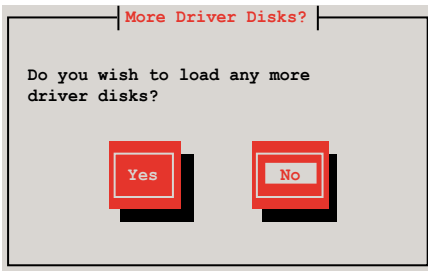

7. Select **Skip** and press <Enter> to continue.

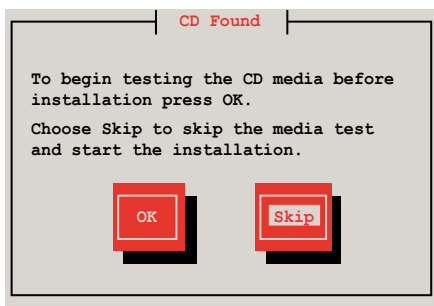

8. Follow the onscreen instructions to finish installing the RedHat operating system.

## Red Hat® Enterprise Linux OS 5.0

To install the RAID controller driver when installing Red Hat® Enterprise OS:

1. Boot the system from the Red Hat® OS installation CD.
2. At the `boot:`, type `linux dd`
3. Press <Enter>.

```
- To install or upgrade in graphical mode, press the <ENTER> key.
- To install or upgrade in text mode, type: linux text <ENTER>.
- Use the function keys listed below for more information.
[F1-Main] [F2-Options] [F3-General] [F4-Kernel] [F5-Rescue]
boot: linux dd
```

4. Select **Yes** using the <Tab> key when asked if you have the driver disk, then press <Enter>.

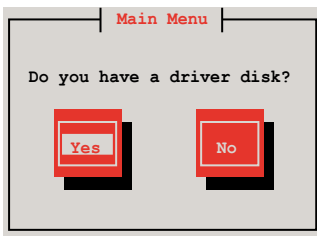

5. Insert the Red Hat® Enterprise RAID driver disk to the floppy disk drive, select **OK**, then press <Enter>.

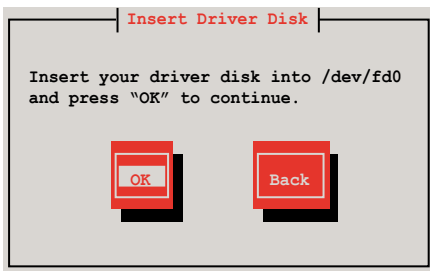

The drivers for the RAID card are installed to the system.

- When asked if you will load additional RAID controller drivers, select **No**, then press <Enter>.

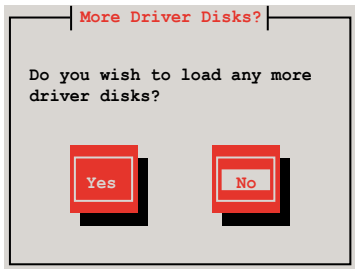

- Follow the onscreen instructions to finish the OS installation.



## SUSE Linux 11 OS

To install the RAID controller driver when installing SUSE Linux Enterprise Server OS:

1. Boot the system from the SUSE OS installation CD.
2. Use the arrow keys to select **Installation** from the **Boot Options** menu.

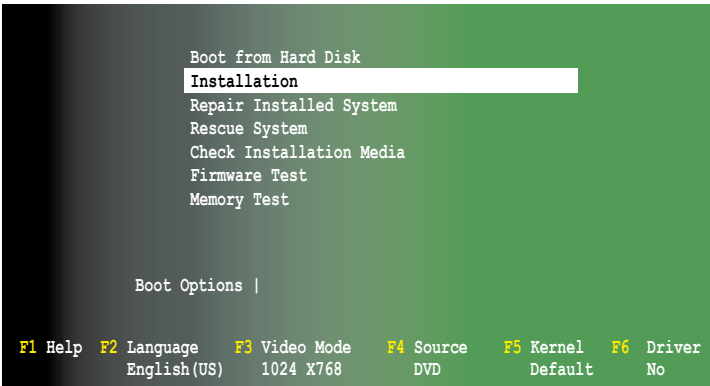

3. Press <F6>, then select **Yes** from the menu. Press <Enter>.

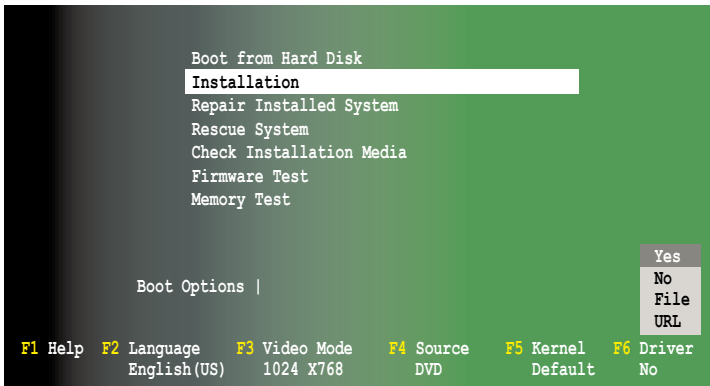

4. Insert the RAID driver disk to the floppy disk drive. Type the command **acpi=off apic=bigsmc brokenmodules=ahci** in **Boot Options** field, and press <Enter>.

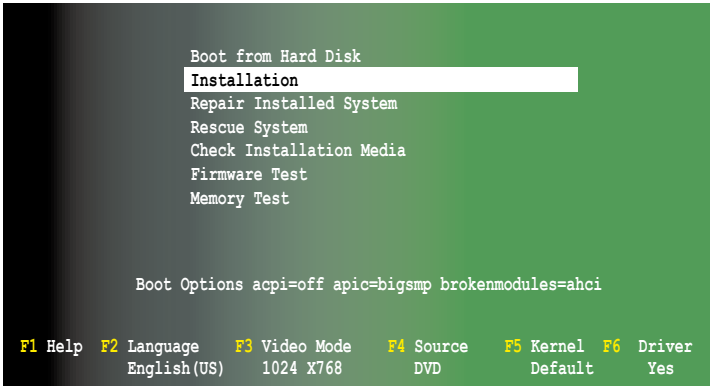

5. When below screen appears, select the USB floppy disk drive (sda) as the driver update medium. Select **OK**, then press <Enter>.

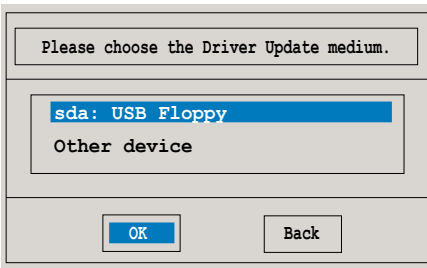

- The drivers for the RAID controller are installed to the system as shown below.

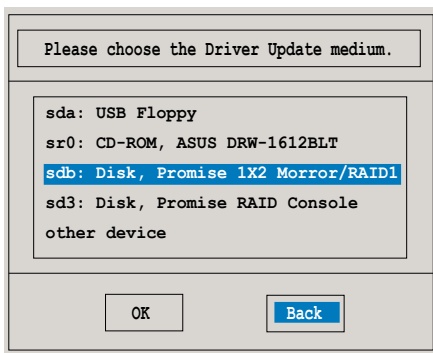

- Select **Back** and follow the onscreen instructions to finish the installation.

## 7.2 AMD® processor driver installation

This section provides instructions on how to install the AMD® processor driver on the system.

You need to manually install the AMD® processor driver on a Windows Server 2003 operating system.

To install the Intel® chipset device software:

1. Restart the computer, then log on with **Administrator** privileges.
2. Insert the motherboard/system support DVD to the optical drive. The support DVD automatically displays the **Drivers** menu if Autorun is enabled in your computer.



---

If Autorun is NOT enabled in your computer, browse the contents of the support DVD to locate the file **AUTORUN.EXE** and double-click the **AUTORUN.EXE** to run the support DVD.

---

3. Click the item **AMD Processor Driver** from the menu, and then follow the onscreen instructions to complete the installation.



## 7.3 LAN driver installation

This section provides the instructions on how to install Intel® Gigabit LAN controller drivers.

To install the Intel® Gigabit LAN controller driver on a Windows® OS:

1. Restart the computer, and then log on with **Administrator** privileges.
2. Insert the motherboard/system support DVD to the optical drive. The DVD automatically displays the **Drivers** menu if Autorun is enabled in your computer.



If **Autorun** is NOT enabled in your computer, browse the contents of the support DVD to locate the file **AUTORUN.EXE** and double-click the **AUTORUN.EXE** and follow step 4 to run the installation.

3. Click **Intel® PRO/1000 Gigabit Adapters Driver**.



4. When the **Intel® Network Connections – InstallShield Wizard** window appears, click **Next** to start the installation.

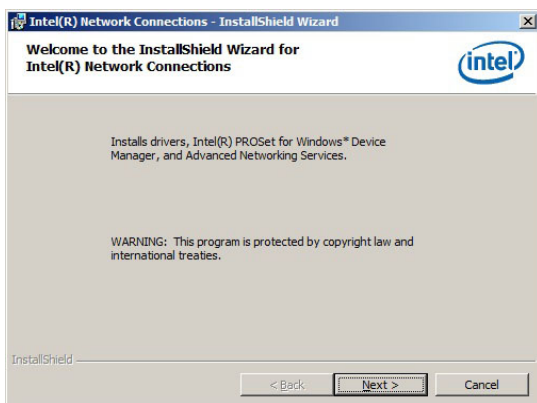

5. Click **I accept the terms in the license agreement** and then click **Next** to continue.

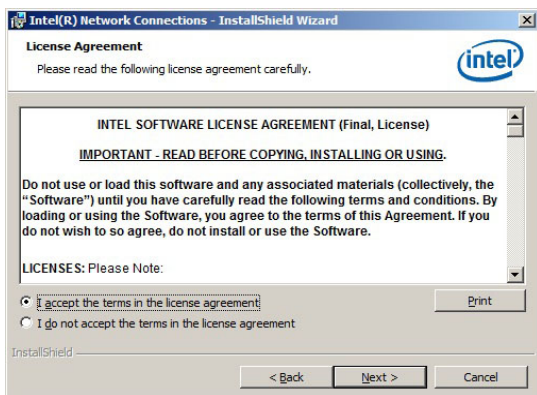

6. Select the programs you want to install and click **Next** to continue.

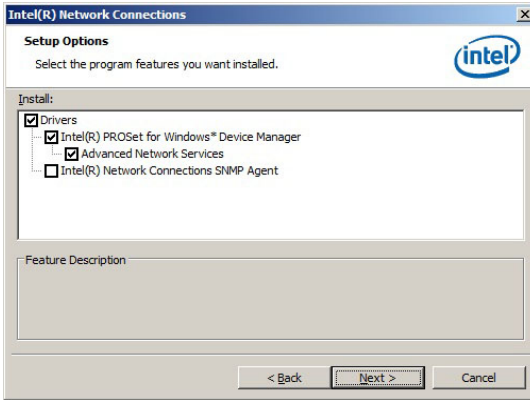

7. Click **Install** to start the installation.

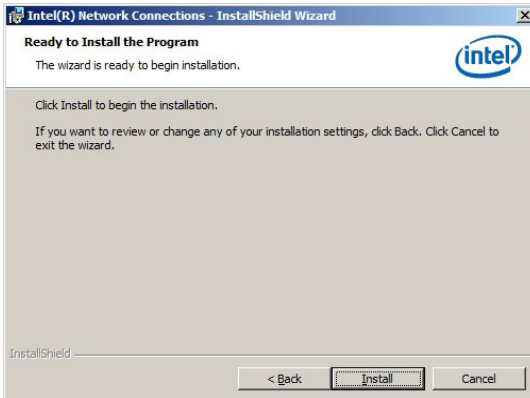

8. The programs you select are being installed.

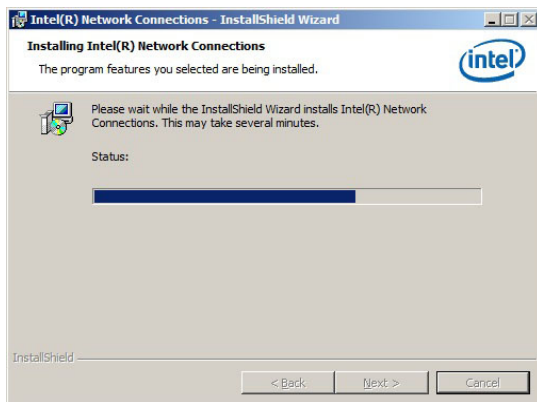

9. Click **Finish** to finish the installation.

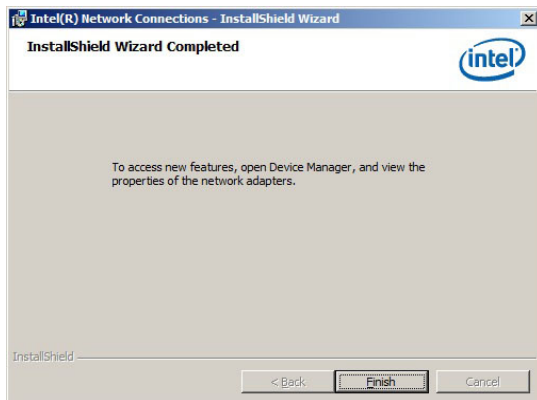



## 7.4 Display driver installation

This section provides instructions on how to install the ASPEED display driver.

To install the ASPEED display driver:

1. Restart the computer, then log on with Administrator privileges.
2. Insert the motherboard/system support DVD to the optical drive. The support DVD automatically displays the Drivers menu if Autorun is enabled in your computer.



If Autorun is NOT enabled in your computer, browse the contents of the support DVD to locate the file **AUTORUN.EXE** and double-click the **AUTORUN.EXE** to run the support DVD.

3. Click **ASPEED AST2050 Display Driver**.



4. When the **ASPEED InstallShield Wizard** window appears, click **Next** to continue.

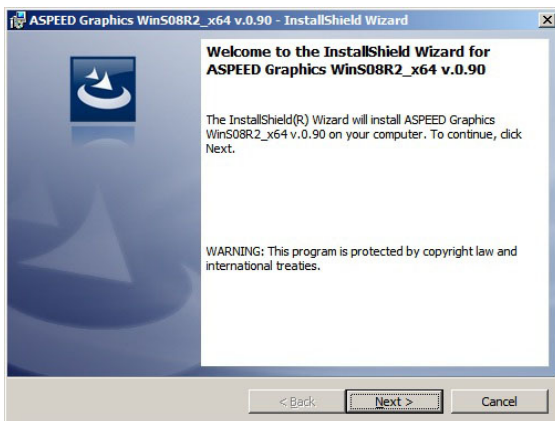

5. Click **Install** to start the installation.

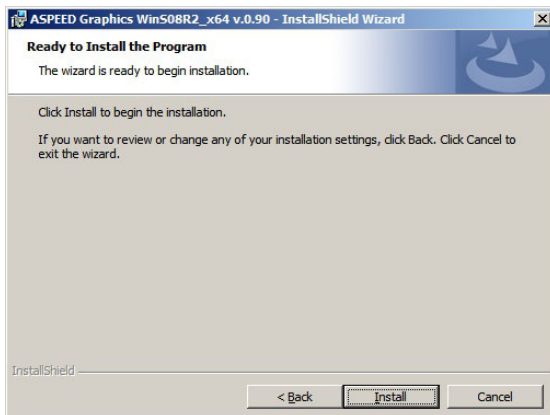

6. The system installs the driver automatically.

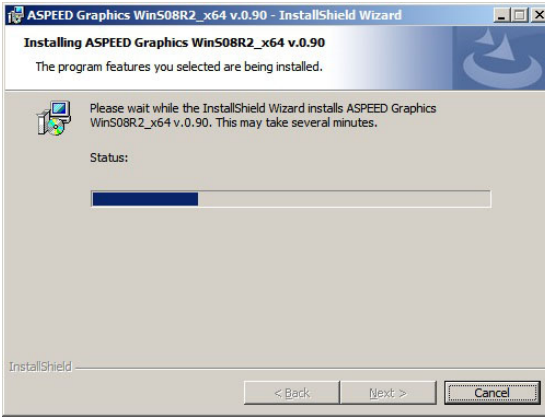

7. When the installation completes, click **Finish** to exit the wizard.

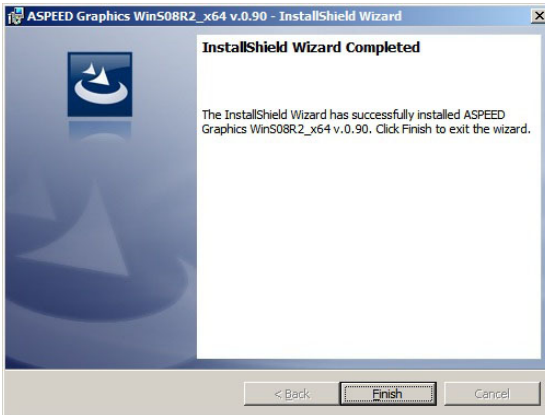

## 7.5 ATI SM Bus controller driver installation

This section provides instructions on how to install the ATI SM Bus driver on the system.

You need to manually install the ATI SMBus driver on a Windows® Server 2003 operating system. To install the driver:

1. Restart the computer, then log on with **Administrator** privileges.
2. Insert the motherboard/system support DVD to the optical drive. The support DVD automatically displays the **Drivers** menu if Autorun is enabled in your computer.



If Autorun is NOT enabled in your computer, browse the contents of the support DVD to locate the file **AUTORUN.EXE** and double-click the **AUTORUN.EXE** to run the support DVD.

3. Click the item **ATI SM Bus Controller Driver** from the menu, and then follow the onscreen instructions to complete the installation.



## 7.6 Management applications and utilities installation

The support DVD that came with the motherboard package contains the drivers, management applications, and utilities that you can install to avail all motherboard features.



The contents of the support DVD are subject to change at any time without notice. Visit the ASUS website ([www.asus.com](http://www.asus.com)) for updates.

### 7.6.1 Running the support DVD

Place the support DVD to the optical drive. The DVD automatically displays the Drivers menu if Autorun is enabled in your computer.



If Autorun is NOT enabled in your computer, browse the contents of the support DVD to locate the file ASSETUP.EXE from the BIN folder. Double-click the ASSETUP.EXE to run the DVD.

### 7.6.2 Drivers menu

The Drivers menu shows the available device drivers if the system detects installed devices. Install the necessary drivers to activate the devices.



The screen display and driver options vary under different operating system versions.



## 7.6.3 Utilities menu

The Utilities menu displays the software applications and utilities that the motherboard supports. Click an item to install.



## 7.6.4 Make disk menu

The Make disk menu contains items to create the RAID driver disk.



## 7.6.5 Contact information

Click the Contact tab to display the ASUS contact information. You can also find this information on the inside front cover of this user guide.

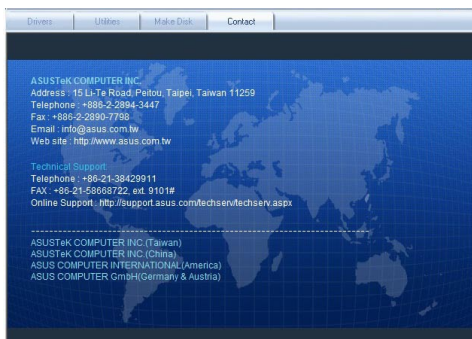

## Free Manuals Download Website

<http://myh66.com>

<http://usermanuals.us>

<http://www.somanuals.com>

<http://www.4manuals.cc>

<http://www.manual-lib.com>

<http://www.404manual.com>

<http://www.luxmanual.com>

<http://aubethermostatmanual.com>

Golf course search by state

<http://golfingnear.com>

Email search by domain

<http://emailbydomain.com>

Auto manuals search

<http://auto.somanuals.com>

TV manuals search

<http://tv.somanuals.com>