

# Z10PA-D8 Series

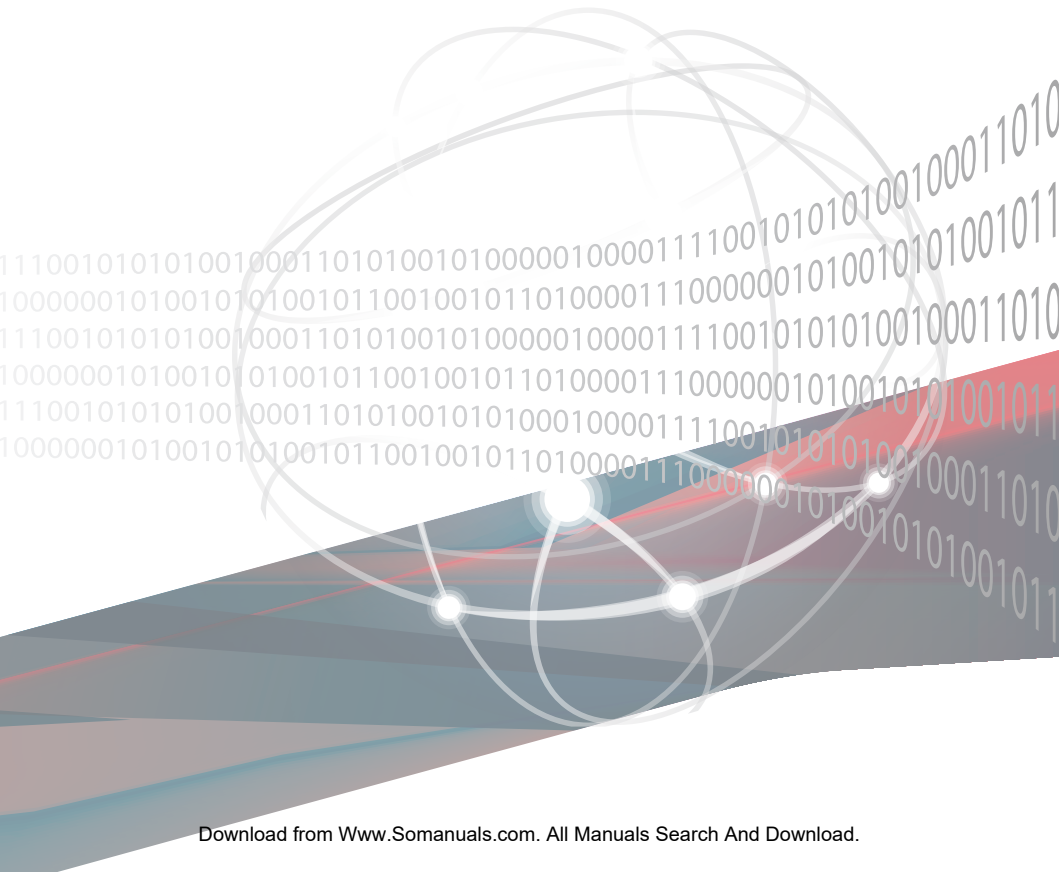

**Copyright © 2014 ASUSTeK COMPUTER INC. All Rights Reserved.**

No part of this manual, including the products and software described in it, may be reproduced, transmitted, transcribed, stored in a retrieval system, or translated into any language in any form or by any means, except documentation kept by the purchaser for backup purposes, without the express written permission of ASUSTeK COMPUTER INC. ("ASUS").

Product warranty or service will not be extended if: (1) the product is repaired, modified or altered, unless such repair, modification or alteration is authorized in writing by ASUS; or (2) the serial number of the product is defaced or missing.

ASUS PROVIDES THIS MANUAL "AS IS" WITHOUT WARRANTY OF ANY KIND, EITHER EXPRESS OR IMPLIED, INCLUDING BUT NOT LIMITED TO THE IMPLIED WARRANTIES OR CONDITIONS OF MERCHANTABILITY OR FITNESS FOR A PARTICULAR PURPOSE. IN NO EVENT SHALL ASUS, ITS DIRECTORS, OFFICERS, EMPLOYEES OR AGENTS BE LIABLE FOR ANY INDIRECT, SPECIAL, INCIDENTAL, OR CONSEQUENTIAL DAMAGES (INCLUDING DAMAGES FOR LOSS OF PROFITS, LOSS OF BUSINESS, LOSS OF USE OR DATA, INTERRUPTION OF BUSINESS AND THE LIKE), EVEN IF ASUS HAS BEEN ADVISED OF THE POSSIBILITY OF SUCH DAMAGES ARISING FROM ANY DEFECT OR ERROR IN THIS MANUAL OR PRODUCT.

SPECIFICATIONS AND INFORMATION CONTAINED IN THIS MANUAL ARE FURNISHED FOR INFORMATIONAL USE ONLY, AND ARE SUBJECT TO CHANGE AT ANY TIME WITHOUT NOTICE, AND SHOULD NOT BE CONSTRUED AS A COMMITMENT BY ASUS. ASUS ASSUMES NO RESPONSIBILITY OR LIABILITY FOR ANY ERRORS OR INACCURACIES THAT MAY APPEAR IN THIS MANUAL, INCLUDING THE PRODUCTS AND SOFTWARE DESCRIBED IN IT.

Products and corporate names appearing in this manual may or may not be registered trademarks or copyrights of their respective companies, and are used only for identification or explanation and to the owners' benefit, without intent to infringe.

# Contents

<b>Notices</b> .....	<b>viii</b>
Federal Communications Commission Statement.....	viii
Canadian Department of Communications Statement.....	viii
REACH .....	viii
<b>Safety information</b> .....	<b>ix</b>
Electrical safety .....	ix
Operation safety.....	ix
Australia statement notice.....	x
How this guide is organized .....	xi
Where to find more information.....	xi
<b>Z10PA-D8 Series specifications summary</b> .....	<b>xiii</b>

## Chapter 1: Product Introduction

<b>1.1</b>	<b>Welcome!</b> .....	<b>1-2</b>
<b>1.2</b>	<b>Package contents</b> .....	<b>1-2</b>
<b>1.3</b>	<b>Serial number label</b> .....	<b>1-3</b>
<b>1.4</b>	<b>Special features</b> .....	<b>1-3</b>
1.4.1	Product highlights.....	1-3
1.4.2	Innovative ASUS features.....	1-4

## Chapter 2: Hardware Information

<b>2.1</b>	<b>Before you proceed</b> .....	<b>2-2</b>
<b>2.2</b>	<b>Motherboard overview</b> .....	<b>2-3</b>
2.2.1	Placement direction.....	2-3
2.2.2	Screw holes.....	2-3
2.2.3	Motherboard layout .....	2-4
2.2.4	Layout contents.....	2-6
<b>2.3</b>	<b>Central Processing Unit (CPU)</b> .....	<b>2-8</b>
2.3.1	Installing the CPU .....	2-8
<b>2.4</b>	<b>System memory</b> .....	<b>2-13</b>
2.4.1	Overview .....	2-13
2.4.2	Memory Configurations.....	2-13
2.4.3	Installing a DIMM on a single clip DIMM socket.....	2-15

# Contents

<b>2.5</b>	<b>Expansion slots</b> .....	<b>2-16</b>
2.5.1	Installing an expansion card.....	2-16
2.5.2	Configuring an expansion card .....	2-16
2.5.3	Interrupt assignments.....	2-17
2.5.4	PCI Express x16 slot (x16 link) .....	2-17
2.5.5	PCI Express x8 slot (x8 link) .....	2-17
2.5.6	PCI Express x8 slot (x4 link) .....	2-17
2.5.7	Installing ASMB8 series management board .....	2-19
<b>2.6</b>	<b>Onboard LEDs</b> .....	<b>2-20</b>
<b>2.7</b>	<b>Jumpers</b> .....	<b>2-25</b>
<b>2.8</b>	<b>Connectors</b> .....	<b>2-29</b>
2.8.1	Rear panel connectors.....	2-29
2.8.2	Internal connectors.....	2-30

## Chapter 3: Powering Up

<b>3.1</b>	<b>Starting up for the first time</b> .....	<b>3-2</b>
<b>3.2</b>	<b>Powering off the computer</b> .....	<b>3-3</b>
3.2.1	Using the OS shut down function.....	3-3
3.2.2	Using the dual function power switch.....	3-3

## Chapter 4: BIOS setup

<b>4.1</b>	<b>Managing and updating your BIOS</b> .....	<b>4-2</b>
4.1.1	ASUS CrashFree BIOS 3 utility.....	4-2
4.1.2	ASUS EZ Flash Utility .....	4-3
4.1.3	BUPDATER utility .....	4-4
<b>4.2</b>	<b>BIOS setup program</b> .....	<b>4-6</b>
4.2.1	BIOS menu screen.....	4-7
4.2.2	Menu bar .....	4-7
4.2.3	Menu items.....	4-8
4.2.4	Submenu items .....	4-8
4.2.5	Navigation keys.....	4-8
4.2.6	General help.....	4-8
4.2.7	Configuration fields .....	4-8
4.2.8	Pop-up window.....	4-8
4.2.9	Scroll bar .....	4-8
<b>4.3</b>	<b>Main menu</b> .....	<b>4-9</b>
4.3.1	System Date [Day xx/xx/xxxx].....	4-9
4.3.2	System Time [xx:xx:xx] .....	4-9



# Contents

<b>4.4</b>	<b>Advanced menu</b> .....	<b>4-10</b>
4.4.1	ACPI Settings.....	4-11
4.4.2	Smart Settings.....	4-11
4.4.3	NCT6779D Super IO Configuration .....	4-12
4.4.4	Intel LAN I210 IO Configuration .....	4-13
4.4.5	Serial Port Console Redirection .....	4-14
4.4.6	APM .....	4-17
4.4.7	PCI Subsystem Settings .....	4-18
4.4.8	Network Stack Configuration.....	4-19
4.4.9	CSM Configuration.....	4-20
4.4.10	Trusted Computing.....	4-21
4.4.11	USB Configuration .....	4-22
4.4.12	iSCSI Configuration.....	4-23
<b>4.5</b>	<b>IntelRCSetup menu</b> .....	<b>4-24</b>
4.5.1	Processor Configuration.....	4-25
4.5.2	Advanced Power Management Configuration.....	4-27
4.5.3	Common RefCode Configuration.....	4-28
4.5.4	QPI Configuration.....	4-29
4.5.5	Memory Configuration.....	4-30
4.5.6	IIO Configuration .....	4-33
4.5.7	PCH Configuration .....	4-34
4.5.8	Miscellaneous Configuration .....	4-38
4.5.9	Server ME Configuration.....	4-38
4.5.10	Runtime Error Logging Support .....	4-39
<b>4.6</b>	<b>Server Mgmt menu</b> .....	<b>4-39</b>
<b>4.7</b>	<b>Event Logs menu</b> .....	<b>4-44</b>
4.7.1	Change Smbios Event Log Settings .....	4-44
4.7.2	View Smbios Event Log .....	4-45
<b>4.8</b>	<b>Monitor menu</b> .....	<b>4-46</b>
<b>4.9</b>	<b>Security menu</b> .....	<b>4-47</b>
<b>4.10</b>	<b>Boot menu</b> .....	<b>4-50</b>
<b>4.11</b>	<b>Tool menu</b> .....	<b>4-51</b>
<b>4.12</b>	<b>Exit menu</b> .....	<b>4-52</b>

# Contents

## Chapter 5: RAID Configuration

<b>5.1</b>	<b>Setting up RAID</b> .....	<b>5-2</b>
5.1.1	RAID definitions .....	5-2
5.1.2	Installing hard disk drives.....	5-3
5.1.3	Setting the RAID item in BIOS .....	5-3
5.1.4	RAID configuration utilities.....	5-3
<b>5.2</b>	<b>LSI Software RAID Configuration Utility (Z10PA-D8 only)</b> .....	<b>5-4</b>
5.2.1	Creating a RAID set.....	5-5
5.2.2	Adding or viewing a RAID configuration.....	5-11
5.2.3	Initializing the virtual drives .....	5-12
5.2.4	Rebuilding failed drives.....	5-16
5.2.5	Checking the drives for data consistency.....	5-18
5.2.6	Deleting a RAID configuration.....	5-21
5.2.7	Selecting the boot drive from a RAID set.....	5-22
5.2.8	Enabling WriteCache .....	5-23
<b>5.3</b>	<b>Intel® Rapid Storage Technology enterprise</b>	
	<b>SATA/SSATA Option ROM Utility</b> .....	<b>5-24</b>
5.3.1	Creating a RAID set.....	5-25
5.3.2	Deleting a RAID set.....	5-27
5.3.3	Resetting disks to Non-RAID .....	5-28
5.3.4	Exiting the Intel® Rapid Storage Technology enterprise SATA/SSATA Option ROM utility.....	5-29
5.3.5	Rebuilding the RAID.....	5-29
5.3.6	Setting the Boot array in the BIOS Setup Utility.....	5-31
<b>5.4</b>	<b>Intel® Rapid Storage Technology enterprise (Windows)</b> .....	<b>5-32</b>
5.4.1	Creating a RAID set.....	5-33
5.4.2	Changing a Volume Type.....	5-35
5.4.3	Deleting a volume .....	5-36
5.4.4	Preferences.....	5-37

# Contents

## Chapter 6: Driver installation

<b>6.1</b>	<b>RAID driver installation .....</b>	<b>6-2</b>
6.1.1	Creating a RAID driver disk.....	6-2
6.1.2	Installing the RAID controller driver.....	6-3
<b>6.2</b>	<b>Management applications and utilities installation .....</b>	<b>6-13</b>
<b>6.3</b>	<b>Running the Support DVD .....</b>	<b>6-13</b>
<b>6.4</b>	<b>Intel® chipset device software installation .....</b>	<b>6-17</b>
<b>6.5</b>	<b>Installing the Intel® I210 Gigabit Adapters driver.....</b>	<b>6-19</b>
<b>6.6</b>	<b>VGA driver installation .....</b>	<b>6-22</b>
<b>6.7</b>	<b>Intel® Rapid Storage Technology enterprise 4.0 installation .....</b>	<b>6-24</b>

## Appendix A: Reference Information

<b>A.1</b>	<b>Z10PA-D8 Series block diagram.....</b>	<b>A-2</b>
	Z10PA-D8 .....	A-2
	Z10PA-D8C.....	A-3
	<b>ASUS contact information.....</b>	<b>1</b>

## Notices

### Federal Communications Commission Statement

This device complies with Part 15 of the FCC Rules. Operation is subject to the following two conditions:

- This device may not cause harmful interference, and
- This device must accept any interference received including interference that may cause undesired operation.

This equipment has been tested and found to comply with the limits for a Class B digital device, pursuant to Part 15 of the FCC Rules. These limits are designed to provide reasonable protection against harmful interference in a residential installation. This equipment generates, uses and can radiate radio frequency energy and, if not installed and used in accordance with manufacturer's instructions, may cause harmful interference to radio communications. However, there is no guarantee that interference will not occur in a particular installation. If this equipment does cause harmful interference to radio or television reception, which can be determined by turning the equipment off and on, the user is encouraged to try to correct the interference by one or more of the following measures:

- Reorient or relocate the receiving antenna.
- Increase the separation between the equipment and receiver.
- Connect the equipment to an outlet on a circuit different from that to which the receiver is connected.
- Consult the dealer or an experienced radio/TV technician for help.



---

The use of shielded cables for connection of the monitor to the graphics card is required to assure compliance with FCC regulations. Changes or modifications to this unit not expressly approved by the party responsible for compliance could void the user's authority to operate this equipment.

---

### Canadian Department of Communications Statement

This digital apparatus does not exceed the Class B limits for radio noise emissions from digital apparatus set out in the Radio Interference Regulations of the Canadian Department of Communications.

This class B digital apparatus complies with Canadian ICES-003.

### REACH

Complying with the REACH (Registration, Evaluation, Authorization, and Restriction of Chemicals) regulatory framework, we publish the chemical substances in our products at ASUS REACH website at <http://csr.asus.com/english/REACH.htm>.

# Safety information

## Electrical safety

- To prevent electrical shock hazard, disconnect the power cable from the electrical outlet before relocating the system.
- When adding or removing devices to or from the system, ensure that the power cables for the devices are unplugged before the signal cables are connected. If possible, disconnect all power cables from the existing system before you add a device.
- Before connecting or removing signal cables from the motherboard, ensure that all power cables are unplugged.
- Seek professional assistance before using an adapter or extension cord. These devices could interrupt the grounding circuit.
- Make sure that your power supply is set to the correct voltage in your area. If you are not sure about the voltage of the electrical outlet you are using, contact your local power company.
- If the power supply is broken, do not try to fix it by yourself. Contact a qualified service technician or your retailer.

## Operation safety

- Before installing the motherboard and adding devices on it, carefully read all the manuals that came with the package.
- Before using the product, make sure all cables are correctly connected and the power cables are not damaged. If you detect any damage, contact your dealer immediately.
- To avoid short circuits, keep paper clips, screws, and staples away from connectors, slots, sockets and circuitry.
- Avoid dust, humidity, and temperature extremes. Do not place the product in any area where it may become wet.
- Place the product on a stable surface.
- If you encounter technical problems with the product, contact a qualified service technician or your retailer.



---

**DO NOT** throw the motherboard in municipal waste. This product has been designed to enable proper reuse of parts and recycling. This symbol of the crossed out wheeled bin indicates that the product (electrical and electronic equipment) should not be placed in municipal waste. Check local regulations for disposal of electronic products.

---



---

**DO NOT** throw the mercury-containing button cell battery in municipal waste. This symbol of the crossed out wheeled bin indicates that the battery should not be placed in municipal waste.

---

## **Australia statement notice**

From 1 January 2012 updated warranties apply to all ASUS products, consistent with the Australian Consumer Law. For the latest product warranty details please visit <http://support.asus.com>. Our goods come with guarantees that cannot be excluded under the Australian Consumer Law. You are entitled to a replacement or refund for a major failure and compensation for any other reasonably foreseeable loss or damage. You are also entitled to have the goods repaired or replaced if the goods fail to be of acceptable quality and the failure does not amount to a major failure.

If you require assistance please call ASUS Customer Service 1300 2787 88 or visit us at <http://support.asus.com>

## About this guide

This user guide contains the information you need when installing and configuring the motherboard.

## How this guide is organized

This user guide contains the following parts:

- **Chapter 1: Product introduction**  
This chapter describes the features of the motherboard and the new technologies it supports.
- **Chapter 2: Hardware information**  
This chapter lists the hardware setup procedures that you have to perform when installing system components. It includes description of the switches, jumpers, and connectors on the motherboard.
- **Chapter 3: Powering up**  
This chapter describes the power up sequence and ways of shutting down the system.
- **Chapter 4: BIOS setup**  
This chapter tells how to change system settings through the BIOS Setup menus. Detailed descriptions of the BIOS parameters are also provided.
- **Chapter 5: RAID configuration**  
This chapter provides instructions for setting up, creating, and configuring RAID sets using the available utilities.
- **Chapter 6: Driver installation**  
This chapter provides instructions for installing the necessary drivers for different system components.
- **Appendix: Reference information**  
This appendix includes additional information that you may refer to when configuring the motherboard.

## Where to find more information

Refer to the following sources for additional information and for product and software updates.

1. **ASUS websites**  
The ASUS website provides updated information on ASUS hardware and software products. Refer to the ASUS contact information.
2. **Optional documentation**  
Your product package may include optional documentation, such as warranty flyers, that may have been added by your dealer. These documents are not part of the standard package.

## Conventions used in this guide

To ensure that you perform certain tasks properly, take note of the following symbols used throughout this manual.



**DANGER/WARNING:** Information to prevent injury to yourself when trying to complete a task.



**CAUTION:** Information to prevent damage to the components when trying to complete a task.



**IMPORTANT:** Instructions that you **MUST** follow to complete a task.



**NOTE:** Tips and additional information to help you complete a task.

### Typography

**Bold text**

Indicates a menu or an item to select.

*Italics*

Used to emphasize a word or a phrase.

<Key>

Keys enclosed in the less-than and greater-than sign means that you must press the enclosed key.

Example: <Enter> means that you must press the Enter or Return key.

<Key1> + <Key2> + <Key3>

If you must press two or more keys simultaneously, the key names are linked with a plus sign (+).

Example: <Ctrl> + <Alt> + <Del>

**Command**

Means that you must type the command exactly as shown, then supply the required item or value enclosed in brackets.

Example: At DOS prompt, type the command line:

**format A: /S**



## Z10PA-D8 Series specifications summary

Model Name		Z10PA-D8	Z10PA-D8C
<b>Processor Support / System Bus</b>		2 x Socket R3 (LGA 2011-3) Intel® Xeon® processor E5-2600 V3 product family QPI 6.4 / 8.0 / 9.6 GT/s	
<b>Core Logic</b>		Intel® C612 PCH	
<b>Form Factor</b>		12 in. x 10 in.	
<b>ASUS Features</b>	Fan Speed Control	✓	
	Rack Ready (Rack and Pedestal dual use)	✓	
	ASWM Enterprise	✓	
<b>Memory</b>	<b>Total Slots</b>	8 (4 channels per CPU, 4 DIMMs per CPU)	
	<b>Voltage</b>	1.2 V	
	<b>Capacity</b>	Maximum up to 512 GB	
	<b>Memory Type</b>	DDR4 2133 / 1866 / 1600 / 1333 RDIMM / LR-DIMM / NVDIMM	
	<b>Memory Size</b>	4 GB, 8 GB, 16 GB, 32 GB (RDIMM) 32 GB, 64 GB (LR-DIMM)	
<b>Expansion Slots (follow SSI Location number)</b>	<b>Total PCI / PCI-E Slots</b>	6	
	<b>Slot Location 1</b>	1 x PCI-E x8 (x4 Gen2 link)	
	<b>Slot Location 2</b>	1 x PCI-E x8 (x8 Gen3 link)	
	<b>Slot Location 3</b>	1 x PCI-E x16 (x16 Gen3 link) (Auto switch to x8 Link if slot 4 is occupied.)	
	<b>Slot Location 4</b>	1 x PCI-E x8 (x8 Gen3 link)	
	<b>Slot Location 5</b>	1 x PCI-E x16 (x16 Gen3 link) (Auto switch to x8 Link if slot 6 is occupied.)	
	<b>Slot Location 6</b>	1 x PCI-E x8 (x8 Gen3 link); MIO supported	
<b>Networking</b>	<b>LAN</b>	2 x Intel I210AT 1 x Management port	2 x Intel I210AT
<b>Storage</b>	<b>SATA Controller</b>	Intel® C612 - 10 x SATA 6Gb/s ports or 9 x SATA 6Gb/s ports with 1 x M.2 connector (support both SATA and PCI-E interface.) Intel® RSTe (for Windows only; Support software RAID 0, 1, 10 & 5) LSI MegaRAID driver supports software RAID 0, 1& 10 (Windows & Linux)	Intel® C612 - 10 x SATA 6Gb/s ports or 9 x SATA 6Gb/s ports with 1 x M.2 connector (support both SATA and PCI-E interface.) Intel® RSTe (for Windows® only; support software RAID 0, 1, 10, and 5)

(continued on the next page)

## Z10PA-D8 Series specifications summary

Model Name		Z10PA-D8	Z10PA-D8C
Storage	SAS Controller	Optional kits: ASUS PIKE 3008 8-port SAS 12G RAID card ASUS PIKE 3108 8-port SAS 12G HW RAID card	
		Aspeed AST2400 32 MB	Aspeed AST1400 64MB
Graphic	VGA	Aspeed AST2400 32 MB	
Onboard I/O Connectors	TPM Header	1	
	PSU Connector	24-pin SSI power connector + 8-pin SSI 12V power connector (85W or below CPU only)	
		24-pin SSI power connector + 8-pin SSI 12V power connector + 8-pin SSI 12V power connector (Support both ATX and SSI Power Supply)* <sup>1</sup>	
	Management connector	Onboard socket for optional management card	—
	USB Connectors	1 x USB 3.0 pin header (up to 2 devices)	
		1 x USB 2.0 pin header (up to 2 devices)	
	Fan Header	8 x 4-pin	
	SMBus	1	
	Chassis Intruder	1	
	Front LAN LED	2	
Serial Port Header	1		
M.2 Connector	1 (NGFF Type 2242, Capacity 16 ~ 128 GB)		
Rear I/O Connectors	VGA Port	1	
	External USB Port	2 x USB 3.0	
		2 x USB 2.0	
	RJ-45	2 x GbE LAN 1 x Management LAN	2 x GbE LAN
PS/2 KB/Mouse	1		
Management Solution	Software	ASWM Enterprise	
	Out of Band Remote Management	Optional ASMB8-iKVM for KVM-over-Internet	
Monitoring	CPU Temperature	✓	
	FAN RPM	✓	
Environment		<b>Operation temperature:</b> 10°C ~ 35°C <b>Non operation temperature:</b> -40°C ~ 70°C <b>Non operation humidity:</b> 20% ~ 90% (Non condensing)	

\* Specifications are subject to change without notice.

<sup>1</sup> Minimum requirement of ATX power supply are the following:

- 500 W
- All +12 V output ≥ 20 A

# Product introduction

# 1

This chapter describes the motherboard features and the new technologies it supports.

## 1.1 Welcome!

Congratulations and thank you for buying an ASUS® Z10PA-D8 Series motherboard!

The motherboard delivers a host of new features and latest technologies, making it another standout in the long line of ASUS quality motherboards!

Before you start installing the motherboard and hardware devices on it, check the items in your package with the list below.

## 1.2 Package contents

Check your motherboard package for the following items.

		Standard Gift Box Pack	Standard Bulk Pack
I/O Shield		1	1
	SATA 6G cable	10	-
Application CD	Support DVD	1	1 piece per carton
	ASWM Enterprise SDVD	1	1 piece per carton
Packaging Quantity		1 piece per carton	10 pieces per carton



If any of the above items is damaged or missing, contact your retailer.

Optional items	Description
PIKE 3008	LSI 8-port SAS 12G RAID card
PIKE 3108	LSI 8-port SAS 12G HW RAID card
ASMB8-iKVM	Remote management solution provides KVM over IP solution
PEM-FDR	Mellanox ConnectX-3 FDR card
PEB-10G/57840-2S	Dual port 10G SFP+ Ethernet Adapter
PEB-10G/57811-1S	Single port 10G SFP+ Ethernet Adapter



The ASUS PIKE 3008, PIKE 3108, and PEM-FDR cards must be installed on PCI-E slot 2/3/4/5.

## 1.3 Serial number label

Before requesting support from the ASUS Technical Support team, you must take note of the motherboard's serial number containing 12 characters xxS2xxxxxxx shown in the figure below. With the correct serial number of the product, ASUS Technical Support team members can then offer a quicker and satisfying solution to your problems.



## 1.4 Special features

### 1.4.1 Product highlights

#### Latest Processor Technology

The motherboard supports Intel Xeon® processor E5-2600 V3 product family which provides compelling IPC increases for legacy performance improvements, floating point improvement, easire multi-core programming, and with next-generation processor power management. Intel® Xeon processor E5-2600 v3 product family also improve the I/O capabilities and support QPI link speed of up to 9.6GT/s.

#### Intel® AVX 2.0

Intel® AVX 2.0 extends 256-bit vector support for integer vector operations, doubles fixed point arithmetic throughput, adds support for new vector gather, permutes/blend, vector shifts resulting in fixed and floating-point algorithm improvements. Also, Intel's new microarchitecture doubles the cache bandwidth at L1/L2 to support higher FLOPS and contributes to greater performance in signal and image processing applications.

#### Next Generation of processor power management

Intel® Xeon processor E5-2600 v3 product family enhances the processor power management with the features of Energy Efficient Turbo, Uncore Frequency Scaling, and Per-Core P-state. Also, the Integrated Voltage Regulator enables generational performance and power improvements that the standard VR solutions cannot provide.

#### DDR4 memory support

The motherboard supports DDR4 memory that features faster clock frequencies and higher data transfer rates of 1333 MT/s to 2133 MT/s (million transfers per second). DDR4 offers a lower voltage standard of 1.2V that reduces memory power demand and provides improved performance.

## **M.2 Support**

This motherboard features the M.2 slot, which shares bandwidth with the SATA 6Gb/s port and PCI-E Gen2 x1 and is dedicated to the operating system.

## **PCI Express 3.0**

PCI Express 3.0 (PCIe 3.0) is the PCI Express bus standard that provide twice the performance and speed of PCIe 2.0. It provides an optimal graphics performance, unprecedented data speed, and seamless transition with its complete backward compatibility to PCIe 2.0 devices.

## **Intel® I210AT LAN Solution**

The motherboard comes with two Gigabit LAN controllers and ports which provide a total solution for your networking needs. The onboard Intel® I210AT Gigabit LAN controllers use the PCI Express interface and could achieve network throughput close to Gigabit bandwidth.

## **Intel® C612 Series Chipset**

The Intel® C612 series chipset supports with enterprise class features which is targeted for Cloud and Storage applications. It is optimized and validated to work with the latest Xeon® processor E5-2600 v3 product family, compared with the last generation, it also reduces the TDP, supports USB 3.0 with up to 10 SATA III ports thus bringing more features and benefits to the target users.

## **Serial ATA III technology**

The motherboard supports the Serial ATA III technology through the Serial ATA interface and Intel® C612 chipset, delivering up to 6 Gb/s data transfer rates. It also provides enhanced scalability, faster data retrieval, and double the bandwidth of current bus systems.

## **Temperature, fan, and voltage monitoring**

The CPU temperature is monitored to prevent overheating and damage. The system fan rotations per minute (RPM) is monitored for timely failure detection. The chip monitors the voltage levels to ensure a stable supply of current for critical components.

## **1.4.2 Innovative ASUS features**

### **ASUS Fan Speed control technology**

The ASUS Fan Speed control technology smartly adjusts the fan speeds according to the system loading to ensure a quiet, cool, and efficient operation.

# Hardware Information

# 2

This chapter lists the hardware setup procedures that you have to perform when installing system components. It includes description of the jumpers and connectors on the motherboard.

## 2.1 Before you proceed

Take note of the following precautions before you install any motherboard component or change any motherboard settings.



- Unplug the power cord from the wall socket before touching any component.
  - Use a grounded wrist strap or touch a safely grounded object or a metal object, such as the power supply case, before handling components to avoid damaging them due to static electricity.
  - Hold components by the edges to avoid touching the ICs on them.
  - Whenever you uninstall any component, place it on a grounded antistatic pad or in the bag that came with the component.
  - Before you install or remove any component, ensure that the power supply is switched off or the power cord is detached from the power supply. Failure to do so may cause severe damage to the motherboard, peripherals, and/or components.
-



## 2.2 Motherboard overview

Before you install the motherboard, study the configuration of your chassis to ensure that the motherboard fits into it.

To optimize the features of your motherboard, we highly recommend that you install it in an ATX 2.2 compliant chassis.



Ensure to unplug the chassis power cord before installing or removing the motherboard. Failure to do so can cause you physical injury and damage motherboard components!

### 2.2.1 Placement direction

When installing the motherboard, ensure that you place it into the chassis in the correct orientation. The edge with external ports goes to the rear part of the chassis as indicated in the image below.

### 2.2.2 Screw holes

Place nine (9) screws into the holes indicated by circles to secure the motherboard to the chassis.



DO NOT overtighten the screws! Doing so can damage the motherboard.

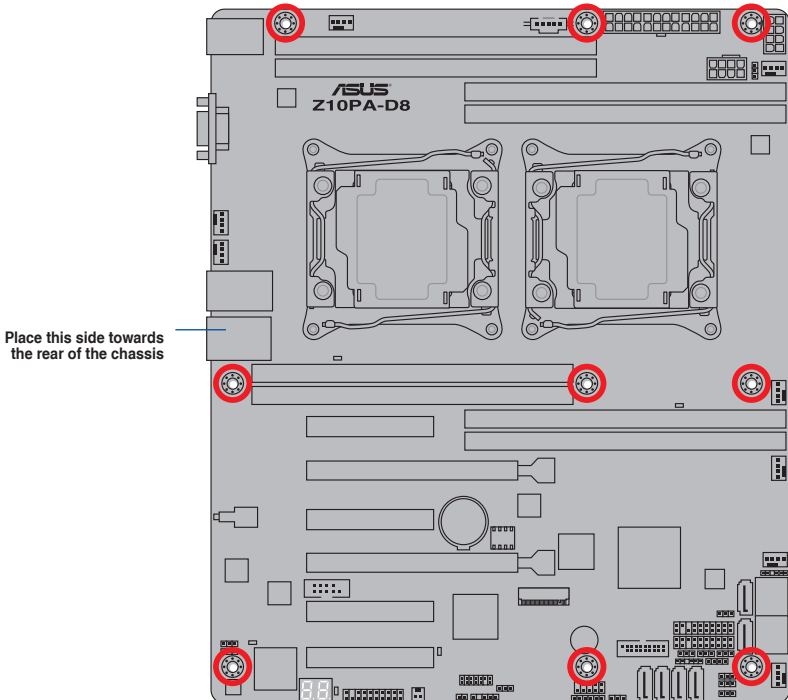



# Z10PA-D8C

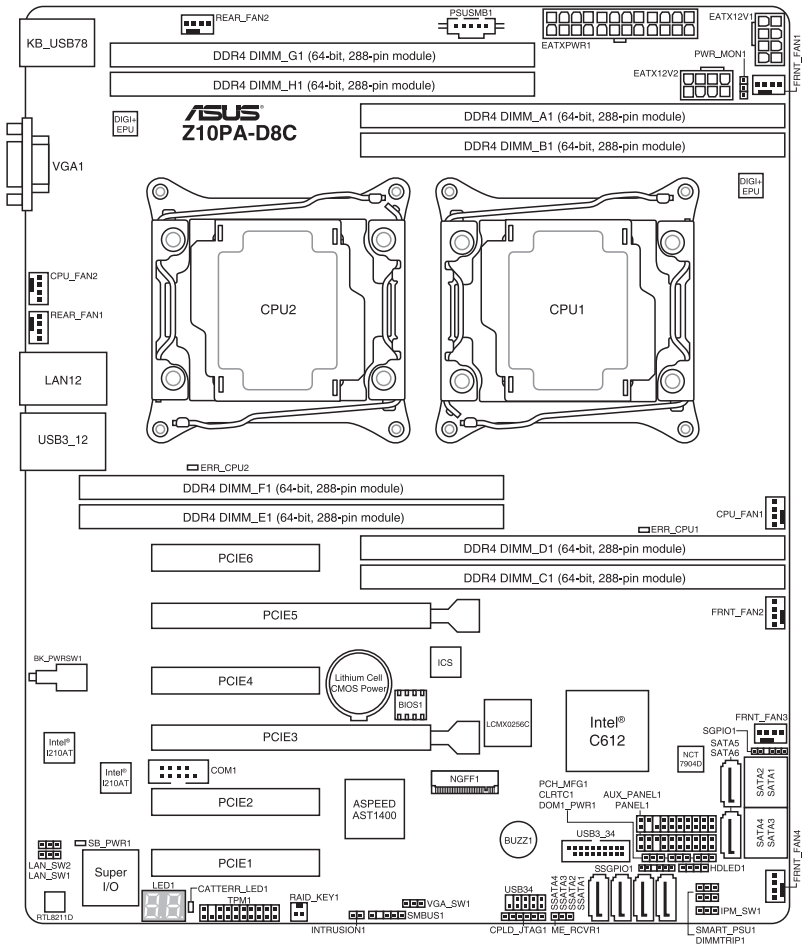

## 2.2.4 Layout contents

Slots/Sockets	Page
1. CPU sockets	2-7
2. DDR4 sockets	2-12
3. PCI Express x16 / PCI Express x8	2-17

Onboard LEDs	Page
1. Standby Power LED (SB_PWR1)	2-18
2. Baseboard Management Controller LED (BMC_LED1)	2-18
3. CPU Warning LED (ERR_CPU1, ERR_CPU2)	2-19
4. CATT LED (CATTERR_LED1)	2-19
5. Q-Code LEDs (LED1)	2-20

Jumpers	Page
1. Clear RTC RAM (CLRRTC1)	2-23
2. VGA controller setting (3-pin VGA_SW1)	2-24
3. LAN controller setting (3-pin LAN_SW1, LAN_SW2)	2-24
4. ME firmware force recovery setting (3-pin ME_RCVR1)	2-25
5. DDR4 thermal event setting (3-pin DIMMTRIP1)	2-25
6. RAID configuration utility selection (3-pin RAID_SEL1)	2-26
7. PMBus 1.2 PSU select jumper (3-pin SMART_PSU1)	2-26

Internal connectors	Page
1. Serial ATA 6.0 Gbps connectors (7-pin SATA1, SATA2, SATA3, SATA4, SATA5, SATA6 [Light Blue]); (7-pin SSATA1, SSATA2, SSATA3 [Gray], SSATA4 [Light Gray])	2-30
2. Power Supply SMBus connector (5-pin PSUSMB1)	2-31
3. USB 2.0 connector (10-1 pin USB34)	2-32
4. USB 3.0 connector (20-1 pin USB3_34)	2-32
5. CPU, front, and rear fan connectors (4-pin CPU_FAN1, CPU_FAN2, FRNT_FAN1, FRNT_FAN2, FRNT_FAN3, FRNT_FAN4, FRNT_FAN5, REAR_FAN1, REAR_FAN2)	2-33
6. Serial port connector (10-1 pin COM1)	2-33
7. Trusted Platform Module connector (20-1 pin TPM1)	2-34
8. ATX power connectors (24-pin EATXPWR1, 8-pin EATX12V1, 8-pin EATX12V2)	2-35
9. System panel connector (20-1 pin PANEL1)	2-36
10. Auxiliary panel connector (20-2 pin AUX_PANEL1)	2-37
11. Hard disk activity LED connector (4-pin HDLED1)	2-38
12. Chassis Intrusion connector (2-pin INTRUSION1)	2-38
13. M.2 (NGFF) connector (NGFF1)	2-31

## 2.3 Central Processing Unit (CPU)

The motherboard comes with a surface mount LGA 2011-3 Socket designed for the Intel® Xeon E5-2600 v3 processor family.



- Upon purchase of the motherboard, ensure that the PnP cap is on the socket and the socket contacts are not bent. Contact your retailer immediately if the PnP cap is missing, or if you see any damage to the PnP cap/socket contacts/motherboard components. ASUS will shoulder the cost of repair only if the damage is shipment/transit-related.
- Keep the cap after installing the motherboard. ASUS will process Return Merchandise Authorization (RMA) requests only if the motherboard comes with the cap on the LGA 2011-3 socket.
- The product warranty does not cover damage to the socket contacts resulting from incorrect CPU installation/removal, or misplacement/loss/incorrect removal of the PnP cap.

### 2.3.1 Installing the CPU

To install a CPU:

1. Locate the CPU socket on the motherboard.

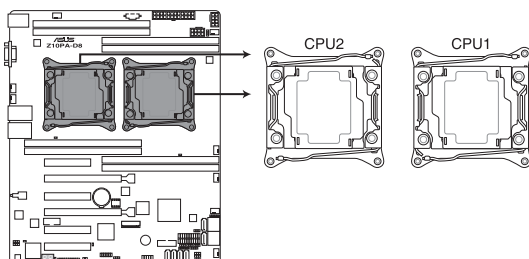

**Z10PA-D8 CPU LGA2011-3 Socket**



Before installing the CPU, ensure that the socket box is facing toward you and the triangle mark is on the top-right position.

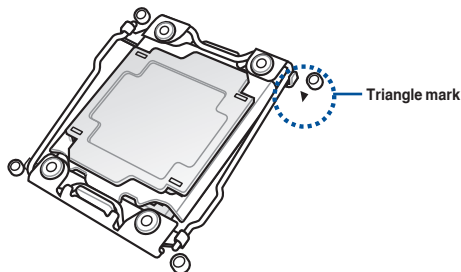

2. Press the left load lever down with your thumb (A), move it to the right until it is released from the retention tab (B) then gently lift the load lever (C).



To prevent damage to the socket pins, do not remove the PnP cap unless you are installing a CPU.

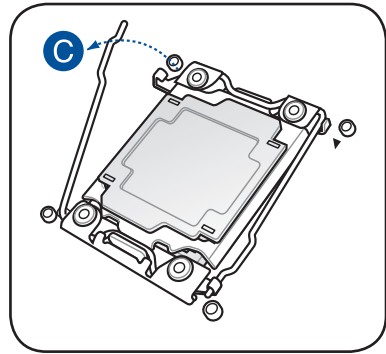
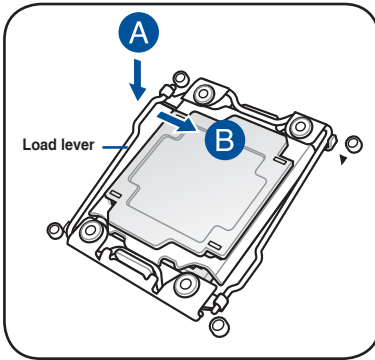

3. Press the right load lever with your thumb (D), move it to the left until it is released from the retention tab (E) then gently lift the load lever (F).

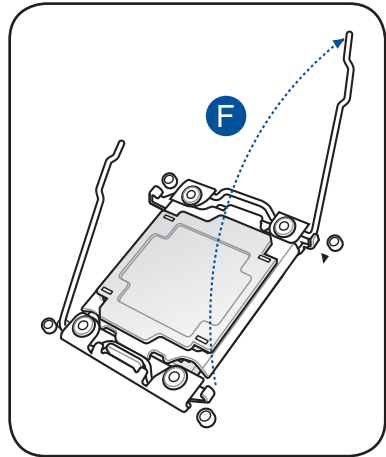
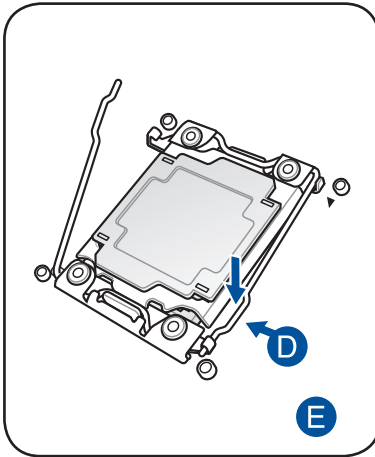

4. Push the left load lever to slightly lift the load plate (G).



Do not insert the load lever into the retention tab.

5. Hold the edge then gently lift the load plate (H).

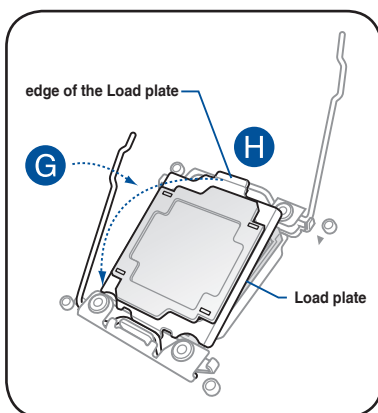

6. Get the CPU.
7. Align and position the CPU over the socket ensuring that the triangle mark on the CPU matches the triangle mark on the socket box.
8. Install the CPU into the slot.



The CPU fits in only one correct orientation. DO NOT force the CPU into the socket to prevent bending the CPU pins on the socket.

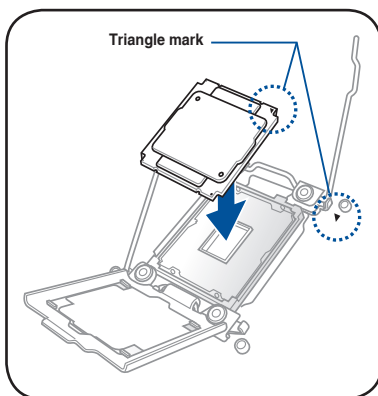

9. Gently push the load plate just enough to let it sit on top of the CPU.



Do not force to close the load plate as it may damage the CPU.

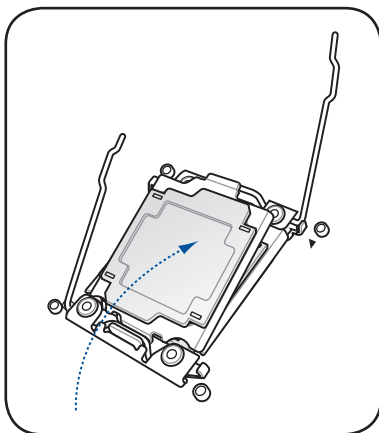



10. Push down the right load lever (I) ensuring that the edge of the load plate is fixed and tucked securely under the lever (J) then insert the right load lever under the retention tab (K).



The PnP cap pops out of the load plate when the right load lever is inserted into the retention tab.



Keep the PnP cap. ASUS will process Return Merchandise Authorization (RMA) requests only if the motherboard comes with the PnP cap on the LGA 2011 socket.

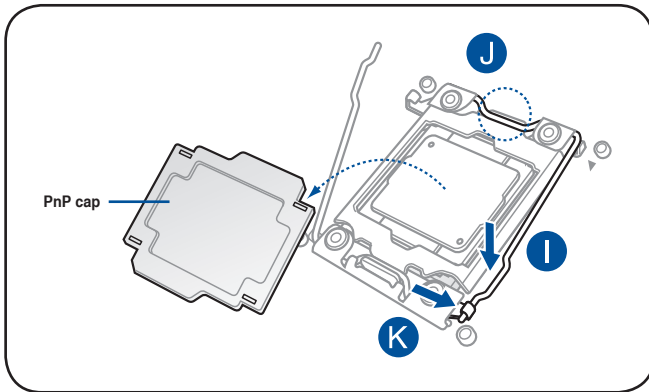

11. Push down the left load lever (L) then insert it under the retention tab (M).

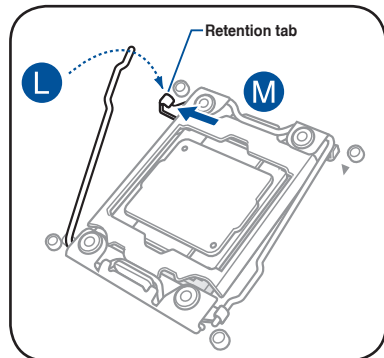

12. Apply some Thermal Interface Material to the exposed area of the CPU that the heatsink will be in contact with.



- Ensure that the Thermal Interface Material is spread in an even thin layer.
- Some heatsinks come with pre-applied Thermal Interface Material. If so, skip this step.

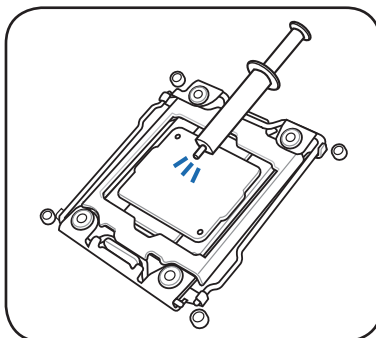

The Thermal Interface Material is toxic and inedible. DO NOT eat it. If it gets into your eyes or touches your skin, wash it off immediately, and seek professional medical help.

13. Connect the CPU fan cable to the connector on the motherboard labeled CPU\_FAN1 / CPU\_FAN2.

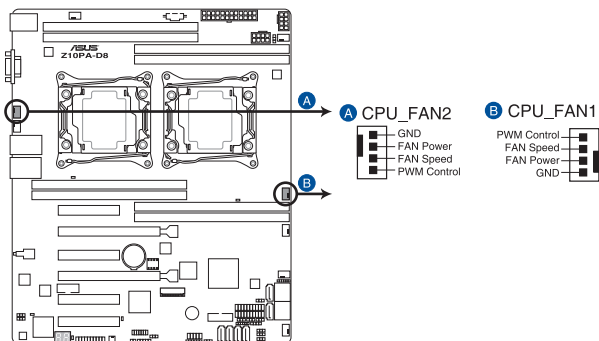

### Z10PA-D8 CPU FAN connectors



DO NOT forget to connect the CPU fan connector! Hardware monitoring errors can occur if you fail to plug this connector.

## 2.4 System memory

### 2.4.1 Overview

The motherboard comes with eight (8) Double Data Rate 4 (DDR4) Dual Inline Memory Modules (DIMM) sockets.

The figure illustrates the location of the DDR4 DIMM sockets:

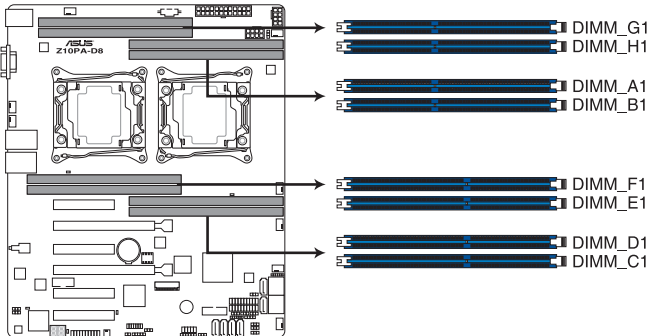

**Z10PA-D8 288-pin DDR4 DIMM sockets**

### 2.4.2 Memory Configurations

You may install 4 GB, 8 GB, 16 GB, and 32 GB RDIMMs or 32 GB and 64 GB LR-DIMMs into the DIMM sockets using the memory configurations in this section.



- Refer to ASUS Server AVL for the updated list of compatible DIMMs.
- When installing DIMMs, always start from slot A1 (CPU1) and E1 (CPU2).
- Always install DIMMs with the same CAS latency. For optimum compatibility, it is recommended that you obtain memory modules from the same vendor.

## Single CPU configuration

You can refer to the following recommended memory population for a single CPU configuration.

Single CPU configuration (must be installed on CPU1)				
	DIMM			
	A1	B1	C1	D1
1 DIMM	✓			
2 DIMMs	✓	✓		
4 DIMMs	✓	✓	✓	✓

## Dual CPU configuration

You can refer to the following recommended memory population for a dual CPU configuration.

Dual CPU configuration								
	DIMM							
	A1	B1	C1	D1	E1	F1	G1	H1
2 DIMMs	✓				✓			
4 DIMMs	✓	✓			✓	✓		
8 DIMMs	✓	✓	✓	✓	✓	✓	✓	✓

### 2.4.3 Installing a DIMM on a single clip DIMM socket

1. Press the retaining clip outward to unlock the DIMM socket.
2. Align a DIMM on the socket such that the notch on the DIMM matches the DIMM slot key on the socket.

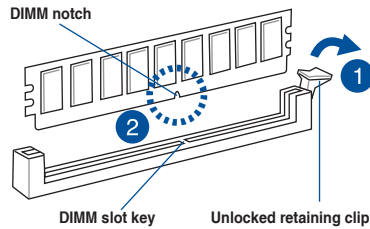

A DIMM is keyed with a notch so that it fits in only one direction. **DO NOT** force a DIMM into a socket in the wrong direction to avoid damaging the DIMM.

3. Hold the DIMM at both ends then insert the DIMM into the socket. Apply force to both ends of the DIMM simultaneously until the retaining clip clicks into place and the DIMM is seated securely in place.

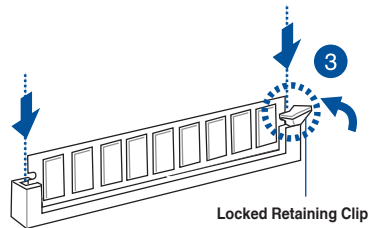

Always insert the DIMM into the socket **VERTICALLY** to prevent DIMM notch damage.



- To install two or more DIMMs, refer to the user guide bundled with the motherboard package.
- Refer to the user guide for qualified vendor lists of the memory modules.

### Removing a DIMM from a single clip DIMM socket

1. Press the retaining clip outward to unlock the DIMM.
2. Remove the DIMM from the socket.

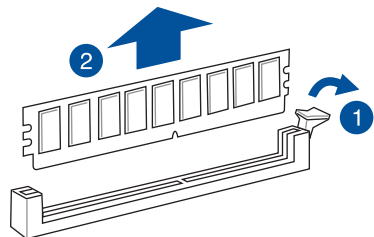

Support the DIMM lightly with your fingers when pressing the retaining clips. The DIMM might get damaged when it flips out with extra force.

## 2.5 Expansion slots

In the future, you may need to install expansion cards. The following subsections describe the slots and the expansion cards that they support.



---

Ensure to unplug the power cord before adding or removing expansion cards. Failure to do so may cause you physical injury and damage motherboard components.

---

### 2.5.1 Installing an expansion card

To install an expansion card:

1. Before installing the expansion card, read the documentation that came with it and make the necessary hardware settings for the card.
2. Remove the system unit cover (if your motherboard is already installed in a chassis).
3. Remove the bracket opposite the slot that you intend to use. Keep the screw for later use.
4. Align the card connector with the slot and press firmly until the card is completely seated on the slot.
5. Secure the card to the chassis with the screw you removed earlier.
6. Replace the system cover.

### 2.5.2 Configuring an expansion card

After installing the expansion card, configure it by adjusting the software settings.

1. Turn on the system and change the necessary BIOS settings, if any. See **Chapter 4** for information on BIOS setup.
2. Assign an IRQ to the card.



---

Refer to the table **Standard Interrupt assignments** in section **Interrupt assignments** for more information.

---

3. Install the software drivers for the expansion card.



---

When using PCI cards on shared slots, ensure that the drivers support "Share IRQ" or that the cards do not need IRQ assignments. Otherwise, conflicts may arise between the two PCI groups, making the system unstable and the card inoperable.

---

## 2.5.3 Interrupt assignments

### Standard Interrupt assignments

IRQ	Priority	Standard function
0	1	System Timer
1	2	Keyboard Controller
2	-	Programmable Interrupt
3*	11	Communications Port (COM2)
4*	12	Communications Port (COM1)
5*	13	--
6	14	Floppy Disk Controller
7*	15	--
8	3	System CMOS/Real Time Clock
9*	4	ACPI Mode when used
10*	5	IRQ Holder for PCI Steering
11*	6	IRQ Holder for PCI Steering
12*	7	PS/2 Compatible Mouse Port
13	8	Numeric Data Processor
14*	9	Primary IDE Channel
15*	10	Secondary IDE Channel

\* These IRQs are usually available for ISA or PCI devices.

## 2.5.4 PCI Express x16 slot (x16 link)

The onboard PCIE3 and PCIE5 slots provides one x16 Gen3 link to CPU1 and auto switches to x8 link if PCIE4/PCIE6 is occupied. This slot supports VGA cards and various server class high performance add-on cards.

## 2.5.5 PCI Express x8 slot (x8 link)

The onboard PCIE2 and PCIE4 slots provide one x8 Gen3 link to CPU1. These slots support VGA cards and various server class high performance add-on cards.

The onboard PCIE6 provide one x8 Gen3 link to CPU1 and supports MIO.

## 2.5.6 PCI Express x8 slot (x4 link)

The onboard PCIE1 slot provides one x4 Gen2 link to Intel C612 PCH chipset. This slot support various server class high performance add-on cards.

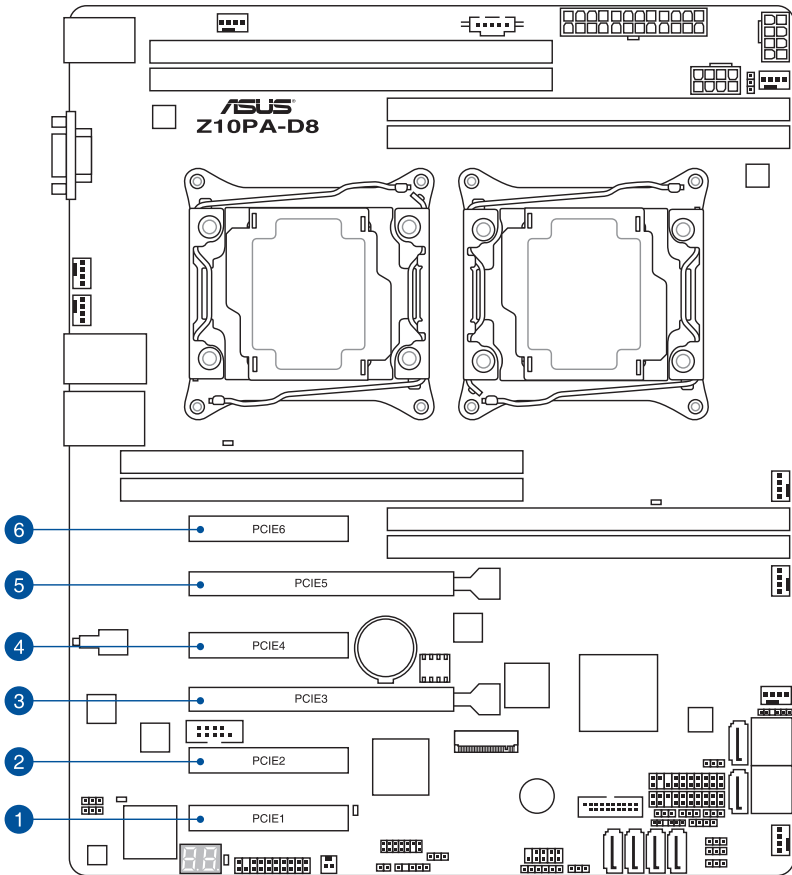

No. (Slot location)	Short description	
1	PCI E1	PCI-E x8 (x4 Gen2 link)
2	PCI E2	PCI-E x8 (x8 Gen3 link)
3	PCI E3	PCI-E x16 (x16 Gen3 link) (Auto switch to x8 Link if slot 4 is occupied.)
4	PCI E4	PCI-E x8 (x8 Gen3 link)
5	PCI E5	PCI-E x16 (x16 Gen3 link) (Auto switch to x8 Link if slot 6 is occupied.)
6	PCI E6	PCI-E x8 (x8 Gen3 link) ; MIO supported



The ASUS PIKE 3008, PIKE 3108, and PEM-FDR cards must be installed on PCIe slot 2/3/4/5.



## 2.5.7 Installing ASMB8 series management board

Follow the steps below to install an optional ASMB8 series management board on your motherboard.

1. Locate the Baseboard Management Card header on the motherboard.

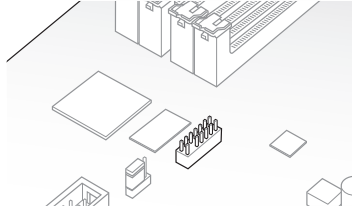

2. Orient and press the Management Card in place.

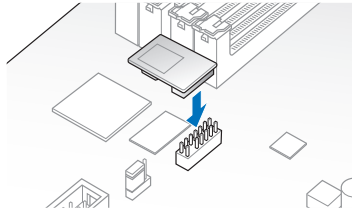

3. Insert the LAN cable plug to the LAN port 3 (dedicated LAN) or LAN port (shared LAN) for server management.

## 2.6 Onboard LEDs

### 1. Standby Power LED (SB\_PWR1)

The motherboard comes with a standby power LED. The green LED lights up to indicate that the system is ON, in sleep mode, or in soft-off mode. This is a reminder that you should shut down the system and unplug the power cable before removing or plugging in any motherboard component. The illustration below shows the location of the onboard LED.

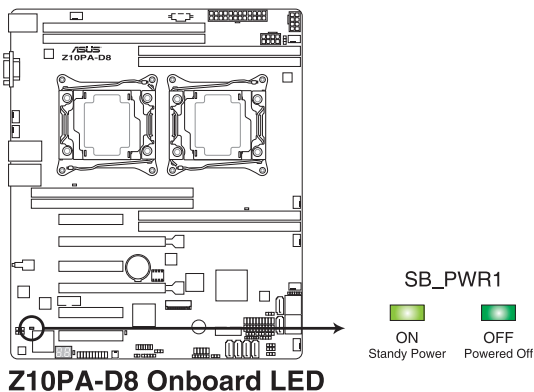

### 2. Baseboard Management Controller LED (BMC\_LED1)

The green heartbeat LED blinks per second to indicate that the ASMB8 is working normally.

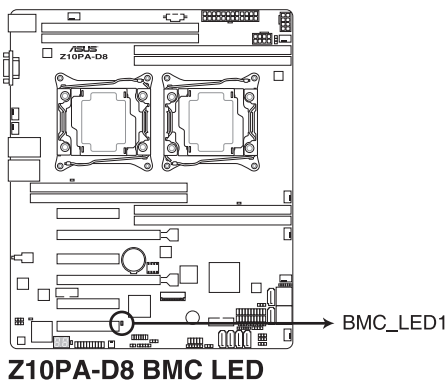

- The heartbeat LED functions only when you install the ASUS ASMB8.
- The Baseboard Management Controller is available to Z10PA-D8 SKU only.

### 3. CPU Warning LED (ERR\_CPU1, ERR\_CPU2)

The CPU warning LEDs light up to indicate failure on either CPU1, CPU2, or both.

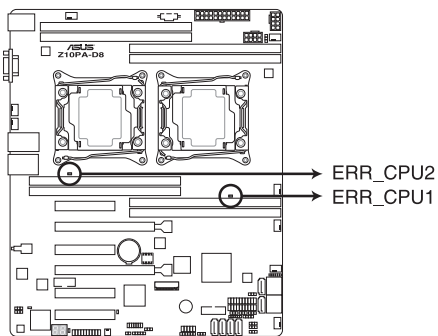

**Z10PA-D8 ERR CPU LED**

### 4. CATT LED (CATTERR\_LED1)

The CATT LED indicates that the system has experienced a fatal or catastrophic error and cannot continue to operate.

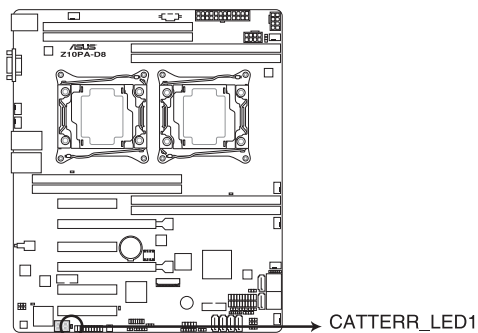

**Z10PA-D8 CATTERR LED**

## 5. Q-Code LEDs (LED1)

The Q-Code LED provides a 2-digit display that shows the status of your system. Refer to the Q-Code table of this user guide for more information about the 2-digit codes.

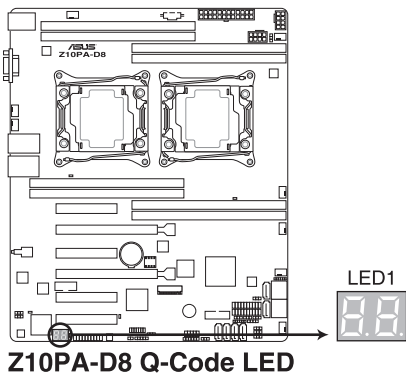

## Q-Code table

Action	PHASE	POST CODE	TYPE	DESCRIPTIONz
Normal boot	Security Phase	01	Progress	First post code(POWER_ON_POST_CODE)
		02	Progress	Load BSP microcode(MICROCODE_POST_CODE)
		03	Progress	Set cache as ram for PEI phase(CACHE_ENABLED_POST_CODE)
		06	Progress	CPU Early init.(CPU_EARLY_INIT_POST_CODE)
		04	Progress	initializes South bridge for PEI preparation
	PEI(Pre-EFI initialization) phase	10	Progress	PEI Core Entry
		15	Progress	NB initialize before installed memory
		19	Progress	SB initialize before installed memory
		78-00	Progress	Wait BMC ready(duration: 120 seconds).
		A1	MRC Progress	QPI initialization
		A3	MRC Progress	QPI initialization
		A7	MRC Progress	QPI initialization
		A8	MRC Progress	QPI initialization
		A9	MRC Progress	QPI initialization
		AA	MRC Progress	QPI initialization
		AB	MRC Progress	QPI initialization
		AC	MRC Progress	QPI initialization
		AD	MRC Progress	QPI initialization
		AE	MRC Progress	QPI initialization
		AF	MRC Progress	QPI initialization Complete
		2F	Progress	Memory Init.
		B0	MRC Progress	Memory Init.
		B1	MRC Progress	Memory Init.
		AF	MRC Progress	RC Reset if require
		B4	MRC Progress	Memory Init.
		B2	MRC Progress	Memory Init.
		B3	MRC Progress	Memory Init.
		B5	MRC Progress	Memory Init.
		B6	MRC Progress	Memory Init.
		B7	MRC Progress	Memory Init.
		B8	MRC Progress	Memory Init.
		B9	MRC Progress	Memory Init.
		BA	MRC Progress	Memory Init.
		BB	MRC Progress	Memory Init.
		BC	MRC Progress	Memory Init.
		BF	MRC Progress	Memory Init. Done
		5A	MRC Progress	Other config. After RC end
		31	Progress	Memory already installed.
		32	Progress	CPU Init.
		34	Progress	CPU Init.
		36	Progress	CPU Init.
		4F	Progress	DXE Initial Program Load(IPL)

(continued on the next page)

## Q-Code table

Action	PHASE	POST CODE	TYPE	DESCRIPTION	
Normal boot	DXE(Driver Execution Environment) phase	60	Progress	DXE Core Started	
		61	Progress	DXE NVRAM Init.	
		62	Progress	SB run-time init.	
		63	Progress	DXE CPU Init	
		68	Progress	NB Init.	
		69	Progress	NB Init.	
		6A	Progress	NB Init.	
		70	Progress	SB Init.	
		71	Progress	SB Init.	
		72	Progress	SB Init.	
		78	Progress	ACPI Init.	
		79	Progress	CSM Init.	
		BDS(Boot Device Selection) phase	90	Progress	BDS started
			91	Progress	Connect device event
			92	Progress	PCI Bus Enumeration.
			93	Progress	PCI Bus Enumeration.
			94	Progress	PCI Bus Enumeration.
			95	Progress	PCI Bus Enumeration.
	96		Progress	PCI Bus Enumeration.	
	97		Progress	Console outout connect event	
	98		Progress	Console input connect event	
	99		Progress	AMI Super IO start	
	9A		Progress	AMI USB Driver Init.	
	9B		Progress	AMI USB Driver Init.	
	9C		Progress	AMI USB Driver Init.	
	9D		Progress	AMI USB Driver Init.	
	b2		Progress	Legacy Option ROM Init.	
	b3		Progress	Reset system	
	b4		Progress	USB hotplug	
	b6		Progress	NVRAM clean up	
	b7		Progress	NVRAM configuration reset	
	A0		Progress	IDE, AHCI Init.	
	A1		Progress	IDE, AHCI Init.	
	A2		Progress	IDE, AHCI Init.	
	A3	Progress	IDE, AHCI Init.		
	A8	Progress	BIOS Setup Utility password verify		
	A9	Progress	BIOS Setup Utility start		
	AB	Progress	BIOS Setup Utility input wait		
	AD	Progress	Ready to boot event		
	AE	Progress	Legacy boot event		
Operating system phase	AA	Progress	APIC mode		
	AC	Progress	PIC mode		

## 2.7 Jumpers

### 1. Clear RTC RAM (3-pin CLRRTC1)

This jumper allows you to clear the Real Time Clock (RTC) RAM in CMOS. You can clear the CMOS memory of date, time, and system setup parameters by erasing the CMOS RTC RAM data. The onboard button cell battery powers the RAM data in CMOS which include system setup information such as system passwords.

To erase the RTC RAM:

1. Turn OFF the computer and unplug the power cord.
2. Move the jumper cap from the default pins 1–2 to pins 2–3. Keep the cap on pins 2–3 for about 5 to 10 seconds, then move the cap back to pins 1–2.
3. Plug the power cord and turn ON the computer.
4. Hold down the <Del> key during the boot process and enter BIOS setup to re-enter data.



DO NOT remove the cap on CLRRTC jumper default position except when clearing the RTC RAM. Removing the cap will cause system boot failure!



If the steps above do not help, remove the onboard battery and move the jumper again to clear the CMOS RTC RAM data. After the CMOS clearance, reinstall the battery.

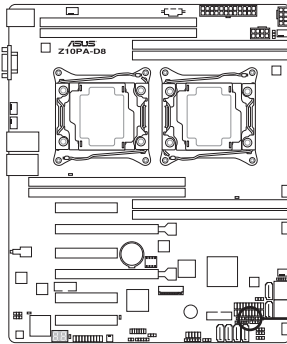

**Z10PA-D8 Clear RTC RAM**

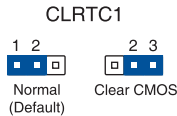

## 2. VGA controller setting (3-pin VGA\_SW1)

This jumper allows you to enable or disable the onboard VGA controller. Set to pins 1–2 to activate the VGA feature.

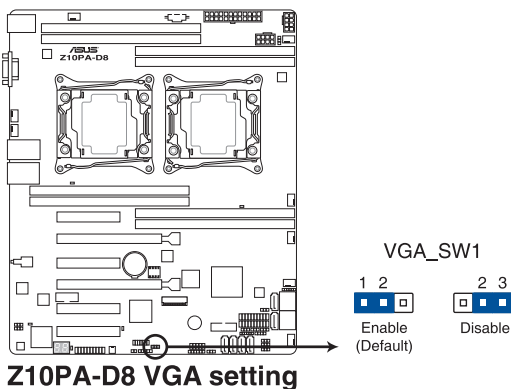

## 3. LAN controller setting (3-pin LAN\_SW1, LAN\_SW2)

These jumpers allow you to enable or disable the onboard LAN\_SW1 or LAN\_SW2. Set to pins 1–2 to activate the Gigabit LAN feature.

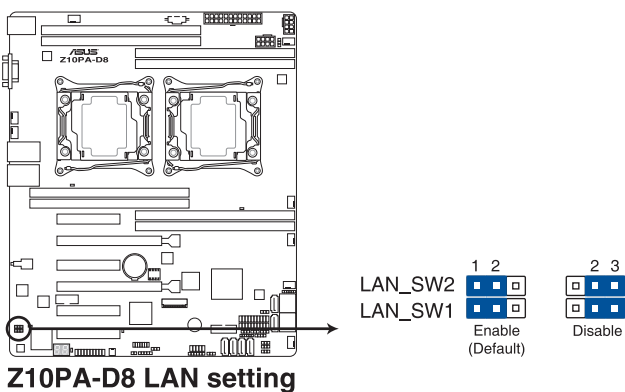



#### 4. ME firmware force recovery setting (3-pin ME\_RCVR1)

This jumper allows you to force Intel® Management Engine (ME) boot from recovery mode when ME becomes corrupted.

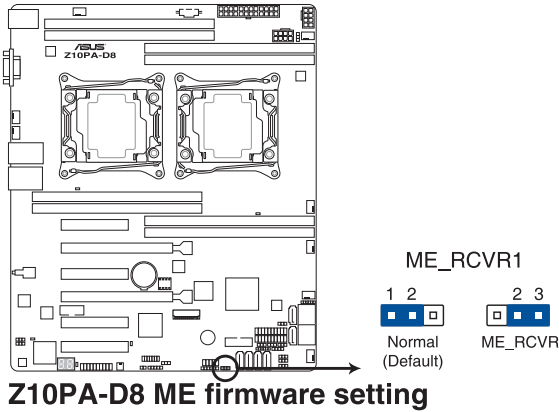

#### 5. DDR4 thermal event setting (3-pin DIMMTRIP1)

This jumper allows you to enable or disable DDR4 DIMM thermal sensing event pin.

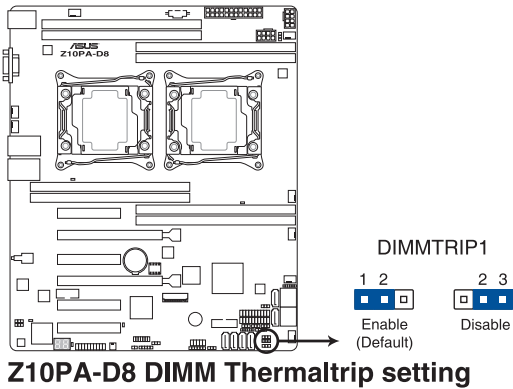

## 6. RAID configuration utility selection (3-pin RAID\_SEL1)

This jumper allows you to select the RAID configuration utility to use when you create disk arrays. Place the jumper caps over pins 1–2 to use the third party software LSI MegaRAID software RAID Configuration Utility; otherwise, place the jumper caps over pins 2–3 to use the Intel® Rapid Storage Technology enterprise SATA Option ROM Utility.

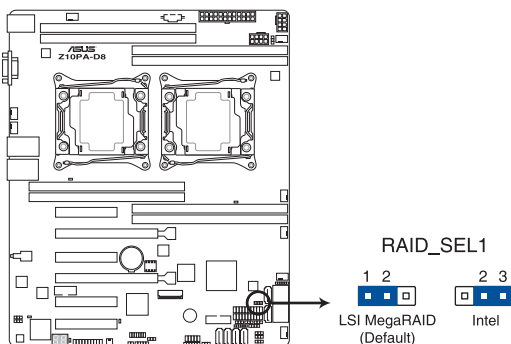

### Z10PA-D8 RAID setting



The RAID configuration utility selection is available to Z10PA-D8 SKU only.

## 7. PMBus 1.2 PSU select jumper (3-pin SMART\_PSU1)

This jumper allows you to select PSU PMBus version. Set to pins 1–2 for PMBus, set to pins 2–3 for others.

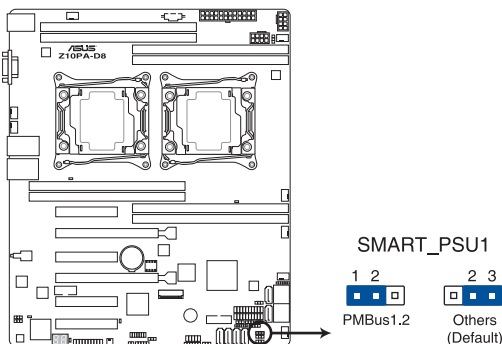

### Z10PA-D8 PMBus 1.2 PSU setting

## 2.8 Connectors

### 2.8.1 Rear panel connectors

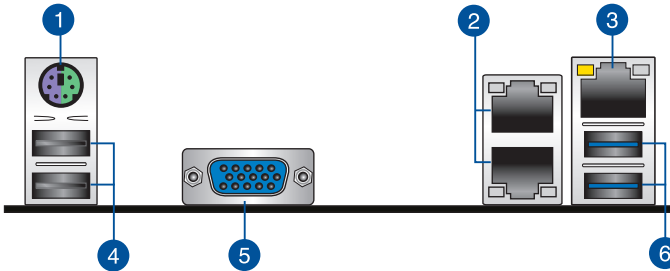

1. PS/2 keyboard/mouse port (purple/green). This port is for a PS/2 keyboard or mouse.
2. RJ-45 ports for LAN. These ports allow Gigabit connection to a LAN through a network hub. Refer to the **LAN port LED indications** table for more information.
3. RJ-45 port for iKVM. This RJ-45 port is available only on the Z10PA-D8 model and only functions when you enable the ASMB8 controller.
4. USB 2.0 ports 1 and 2. These two 4-pin Universal Serial Bus (USB) ports are available for connecting USB 2.0 devices.
5. Video Graphics Adapter (VGA) port. This port is for a VGA monitor or other VGA-compatible devices.
6. USB 3.0 ports 1 and 2. These two 4-pin Universal Serial Bus (USB) ports are available for connecting USB 3.0 devices.

#### LAN port LED indications

Activity/Link LED		Speed LED	
Status	Description	Status	Description
OFF	No link	OFF	10 Mbps connection
GREEN	Linked	ORANGE	100 Mbps connection
BLINKING	Data activity	GREEN	1 Gbps connection

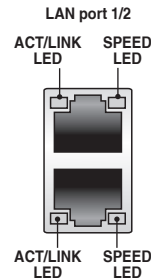

#### Management LAN port LED indications

Activity/Link LED		Speed LED	
Status	Description	Status	Description
OFF	No link	OFF	10 Mbps connection
ORANGE	Linked	ORANGE	100 Mbps connection
BLINKING	Data activity	GREEN	1 Gbps connection

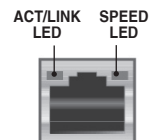

## 2.8.2 Internal connectors

### 1. Serial ATA 6.0 Gbps connectors (7-pin SATA1, SATA2, SATA3, SATA4, SATA5, SATA6 [Light Blue]) (7-pin SSATA1, SSATA2, SSATA3 [Gray], SSATA4 [Light Gray])

Supported by the Intel® 612 Series chipset, this connector is for the Serial ATA signal cables for Serial ATA hard disk drives that allows up to 6 Gbps of data transfer rate.

If you installed Serial ATA hard disk drives, you can create a RAID 0, RAID 1, RAID 10, or RAID 5 configuration.

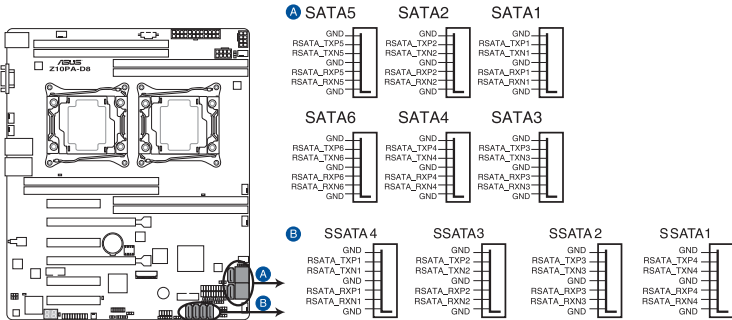

Z10PA-D8 SATA connectors

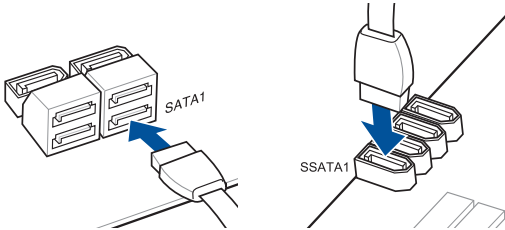

- The actual data transfer rate depends on the speed of Serial ATA hard disks installed.
- The SSATA4 [Light Gray] will be automatically turned off if the M.2 connector (NGFF) is occupied.

## 2. M.2 (NGFF) connector (NGFF1)

This connector allows you to install an M.2 device.

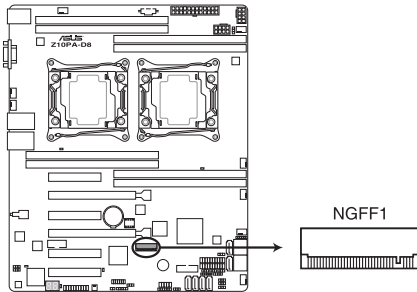

**Z10PA-D8 NGFF1 connector**



---

This connector supports type 2242 devices on both PCI-E and SATA interface.

---



---

The M.2 (NGFF) device is purchased separately

---

## 3. Power Supply SMBus connector (5-pin PSUSMB1)

This connector allows you to connect SMBus (System Management Bus) to the PSU (power supply unit) to read PSU information. Devices communicate with an SMBus host and/or other SMBus devices using the SMBus interface.

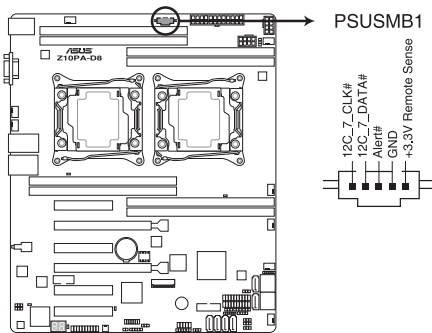

**Z10PA-D8 Power supply SMBus connector**



---

This connector functions only when you install the ASUS ASMB8.

---



---

Power supply is required to meet PMBus specification and customized BMC FW may be needed. Please contact ASUS if your need further support.

---

**4. USB 2.0 connector (10-1 pin USB34)**

These connectors are for USB 2.0 ports. Connect the USB module cables to connectors USB56. These USB connectors comply with USB 2.0 specification that supports up to 480 Mb/s connection speed.

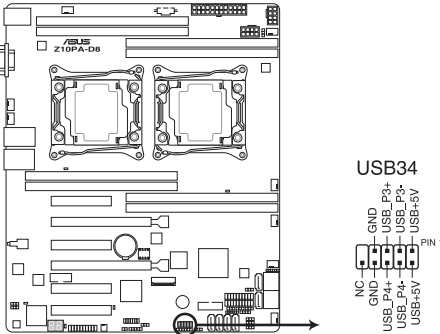

**Z10PA-D8 USB 2.0 connector**

**5. USB 3.0 connector (20-1 pin USB3\_34)**

This connector allows you to connect a USB 3.0 module for additional USB 3.0 front or rear panel ports. With an installed USB 3.0 module, you can enjoy all the benefits of USB 3.0 including faster data transfer speeds of up to 5Gbps, faster charging time for USB-chargeable devices, optimized power efficiency, and backward compatibility with USB 2.0.

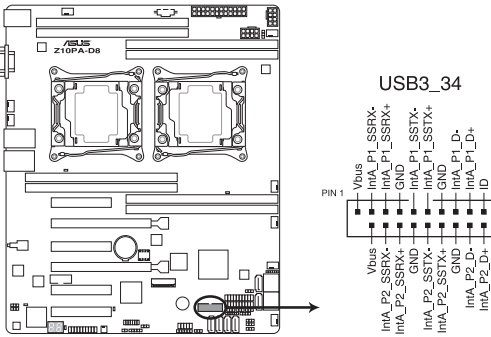

**Z10PA-D8 USB 3.0 connector**

**6. CPU, front, and rear fan connectors (4-pin CPU\_FAN1, CPU\_FAN2, FRNT\_FAN1, FRNT\_FAN2, FRNT\_FAN3, FRNT\_FAN4, FRNT\_FAN5, REAR\_FAN1, REAR\_FAN2)**

The fan connectors support cooling fans. Connect the fan cables to the fan connectors on the motherboard, ensuring that the black wire of each cable matches the ground pin of the connector.



- DO NOT forget to connect the fan cables to the fan connectors. Insufficient air flow inside the system may damage the motherboard components.
- These are not jumpers! DO NOT place jumper caps on the fan connectors!
- All fans feature the ASUS Smart Fan technology.

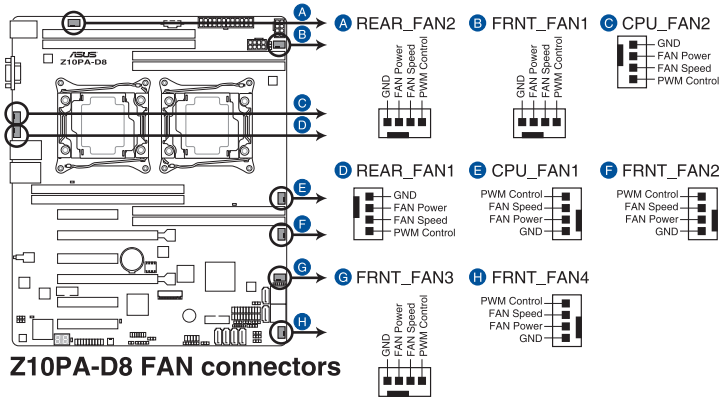

**7. Serial port connector (10-1 pin COM1)**

This connector is for the serial COM port. Connect the serial port module cable to one of these connectors, then install the module to a slot opening at the back of the system chassis.

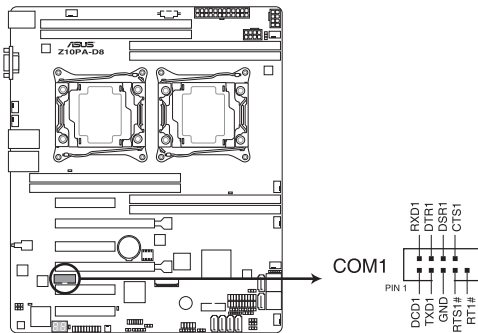

**8. Trusted Platform Module connector (20-pin TPM1)**

This connector supports a Trusted Platform Module (TPM) system, which can securely store keys, digital certificates, passwords, and data. A TPM system also helps enhance network security, protects digital identities, and ensures platform integrity.

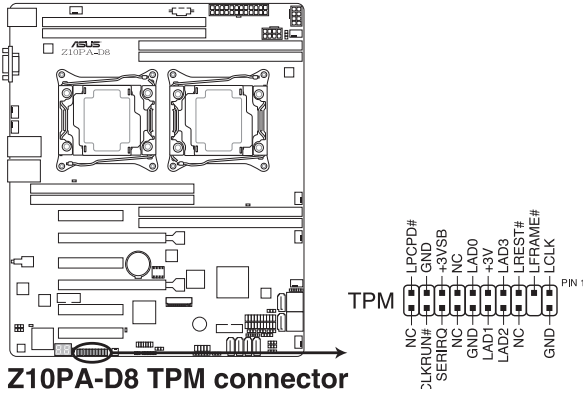





## 10. System panel connector (20-pin PANEL1)

This connector supports several chassis-mounted functions.

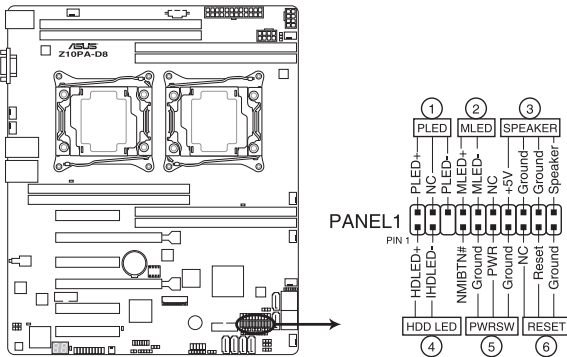

### 1. System power LED (3-pin PLED)

This 3-pin connector is for the system power LED. Connect the chassis power LED cable to this connector. The system power LED lights up when you turn on the system power, and blinks when the system is in sleep mode.

### 2. Message LED (2-pin MLED)

This 2-pin connector is for the message LED cable that connects to the front message LED. The message LED is controlled by Hardware monitor to indicate an abnormal event occurrence.

### 3. System warning speaker (4-pin SPEAKER)

This 4-pin connector is for the chassis-mounted system warning speaker. The speaker allows you to hear system beeps and warnings.

### 4. Hard disk drive activity LED (2-pin HDD LED)

This 2-pin connector is for the HDD Activity LED. Connect the HDD Activity LED cable to this connector. The HD LED lights up or flashes when data is read from or written to the HDD.

### 5. Power button/soft-off button (2-pin PWRSW)

This connector is for the system power button. Pressing the power button turns the system on or puts the system in sleep or soft-off mode depending on the BIOS settings. Pressing the power switch for more than four seconds while the system is ON turns the system OFF.

### 6. Reset button (2-pin RESET)

This 2-pin connector is for the chassis-mounted reset button for system reboot without turning off the system power.

## 11. Auxiliary panel connector (20-2 pin AUX\_PANEL1)

This connector is for additional front panel features including front panel SMB, locator LED and switch, and LAN LEDs.

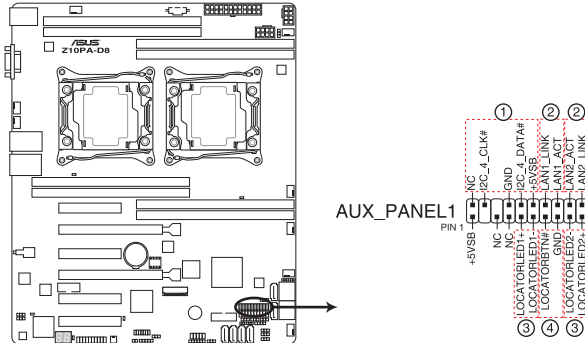

### Z10PA-D8 Auxiliary panel connector

#### 1. Front panel SMB (10-2 pin FPSMB)

These connectors are for the front panel SMBus cable.

#### 2. LAN activity LED (2-pin LAN1\_LINKACTLED, LAN2\_LINKACTLED)

These connectors are for Gigabit LAN activity LEDs on the front panel.

#### 3. Locator LED (2-pin LOCATORLED1, LOCATORLED2)

These connectors are for the locator LED1 and LED2 on the front panel. Connect the Locator LED cables to these 2-pin connector. The LEDs will light up when the Locator button is pressed.

#### 4. Locator Button/Switch (2-pin LOCATORBTN#)

These connectors are for the locator button on the front panel. This button queries the state of the system locator.

**12. Hard disk activity LED connector (4-pin HDLED1)**

This LED connector is for the storage add-on card cable connected to the SATA or SAS add-on card. The read or write activities of any device connected to the SATA or SAS add-on card causes the front panel LED to light up.

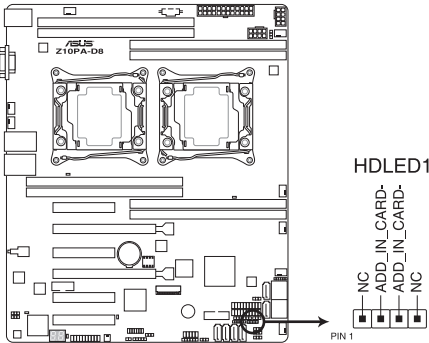

**Z10PA-D8 Storage card activity LED connector**

**13. Chassis Intrusion (2-pin INTRUSION1)**

These leads are for the intrusion detection feature for chassis with intrusion sensor or microswitch. When you remove any chassis component, the sensor triggers and sends a high level signal to these leads to record a chassis intrusion event. The default setting is short CHASSIS# and GND pin by jumper cap to disable the function.

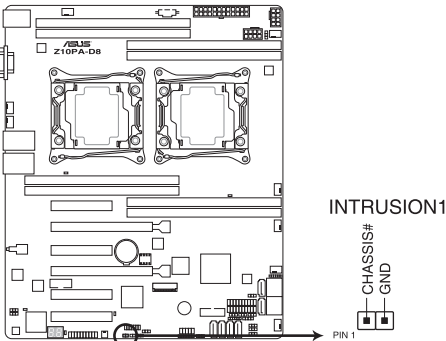

**Z10PA-D8 INTRUSION connector**

# Powering Up

# 3

This chapter describes the power up sequence, and ways of shutting down the system.

## 3.1 Starting up for the first time

1. After making all the connections, replace the system case cover.
2. Be sure that all switches are off.
3. Connect the power cord to the power connector at the back of the system chassis.
4. Connect the power cord to a power outlet that is equipped with a surge protector.
5. Turn on the devices in the following order:
  - a. Monitor
  - b. External storage devices (starting with the last device on the chain)
  - c. System power
6. After applying power, the system power LED on the system front panel case lights up. For systems with ATX power supplies, the system LED lights up when you press the ATX power button. If your monitor complies with “green” standards or if it has a “power standby” feature, the monitor LED may light up or switch between orange and green after the system LED turns on.

The system then runs the power-on self-test or POST. While the tests are running, the BIOS beeps or additional messages appear on the screen. If you do not see anything within 30 seconds from the time you turned on the power, the system may have failed a power-on test. Check the jumper settings and connections or call your retailer for assistance.

The following shows the possible beep codes and its corresponding error condition

BIOS Beep codes	
Beep	Error condition
1 short	Power supply surges detected during the previous power on.
1 short	No Keyboard Detected.
1 short, 2 short	No DIMM Detected.
1 short, 8 short	No VGA Detected.
2 long	Chassis Intrusion.
2 long	BIOS-image Crash Detected.

7. At power on, hold down the <Del> key to enter the BIOS Setup. Follow the instructions in Chapter 4.

## 3.2 Powering off the computer

### 3.2.1 Using the OS shut down function

#### Using Windows® Server 2008 R2:

1. Click the Start button, move the cursor to the triangle on the right of Log off, then click Shut Down.
2. From the Shutdown Event Tracker, select the option that best describes why you want to shut down the computer.
3. Ensure that the Planned check box is checked.
4. If necessary, key in comments.
5. Click **OK**.

#### Using Windows® Server 2012:

1. Press <Ctrl>+<Alt>+<Del>.
2. Click on the Power icon on the lower right side of the screen.
3. Select **Shut down**.
4. In the Shutdown Event Tracker, select the **Other (Planned)** option in the selection lists. Otherwise, select the option that best describes why you want to shut down the computer.
5. Click **Continue**.

### 3.2.2 Using the dual function power switch

While the system is ON, press the power switch for less than four seconds to put the system to sleep mode or to soft-off mode, depending on the BIOS setting.



---

Pressing the power switch for more than four seconds lets the system enter the soft-off mode regardless of the BIOS setting.

---





# **BIOS setup**

# 4

This chapter tells how to change the system settings through the BIOS Setup menus. Detailed descriptions of the BIOS parameters are also provided.

## 4.1 Managing and updating your BIOS

The following utilities allow you to manage and update the motherboard Basic Input/Output System (BIOS) setup:

### 1. **ASUS CrashFree BIOS 3**

To recover the BIOS using a bootable USB flash disk drive when the BIOS file fails or gets corrupted.

### 2. **ASUS EzFlash**

Updates the BIOS using a USB flash disk.

### 3. **BUPDATER**

Updates the BIOS in DOS mode using a bootable USB flash disk drive.

Refer to the corresponding sections for details on these utilities.



---

Save a copy of the original motherboard BIOS file to a bootable USB flash disk drive in case you need to restore the BIOS in the future. Copy the original motherboard BIOS using the BUPDATER utility.

---

### 4.1.1 **ASUS CrashFree BIOS 3 utility**

The ASUS CrashFree BIOS 3 is an auto recovery tool that allows you to restore the BIOS file when it fails or gets corrupted during the updating process. You can update a corrupted BIOS file using a USB flash drive that contains the updated BIOS file.



---

Prepare a USB flash drive containing the updated motherboard BIOS before using this utility.

---

### **Recovering the BIOS from a USB flash drive**

To recover the BIOS from a USB flash drive:

1. Insert the USB flash drive with the original or updated BIOS file to one USB port on the system.
2. The utility will automatically recover the BIOS. It resets the system when the BIOS recovery finished.



---

**DO NOT** shut down or reset the system while recovering the BIOS! Doing so would cause system boot failure!

---



---

The recovered BIOS may not be the latest BIOS version for this motherboard. Visit the ASUS website at [www.asus.com](http://www.asus.com) to download the latest BIOS file.

---

## 4.1.2 ASUS EZ Flash Utility

The ASUS EZ Flash Utility feature allows you to update the BIOS without having to use a DOS-based utility.



Before you start using this utility, download the latest BIOS from the ASUS website at [www.asus.com](http://www.asus.com).

To update the BIOS using EZ Flash Utility:

1. Insert the USB flash disk that contains the latest BIOS file into the USB port.
2. Enter the BIOS setup program. Go to the **Tool** menu then select **ASUS EZ Flash Utility**. Press <Enter>.

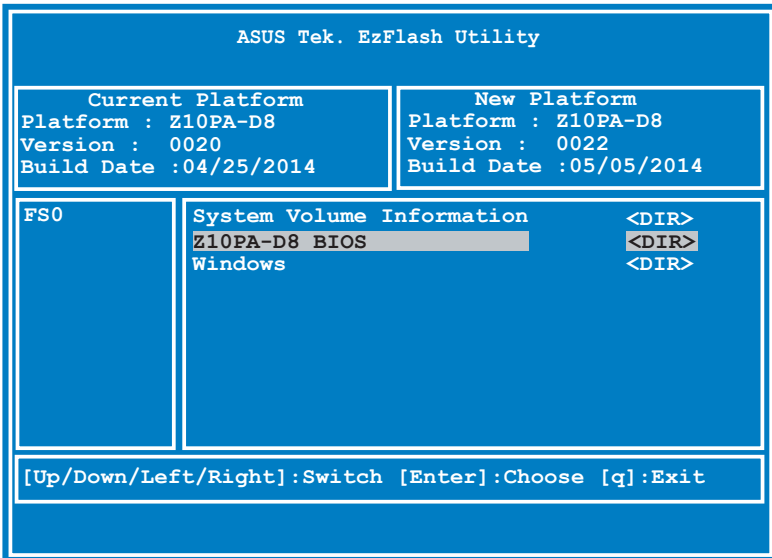

3. Press <Tab> to switch to the **Drive** field.
4. Press the Up/Down arrow keys to find the USB flash disk that contains the latest BIOS, then press <Enter>.
5. Press <Tab> to switch to the **Folder Info** field.
6. Press the Up/Down arrow keys to find the BIOS file, and then press <Enter> to perform the BIOS update process. Reboot the system when the update process is done.



- 
- This function can support devices such as a USB flash disk with FAT 32/16 format and single partition only.
  - DO NOT shut down or reset the system while updating the BIOS to prevent system boot failure!
- 



Ensure to load the BIOS default settings to ensure system compatibility and stability. Press <F5> and select **Yes** to load the BIOS default settings.

---

### 4.1.3 BUPDATER utility



The succeeding BIOS screens are for reference only. The actual BIOS screen displays may not be the same as shown.

---

The BUPDATER utility allows you to update the BIOS file in the DOS environment using a bootable USB flash disk drive with the updated BIOS file.

#### Updating the BIOS file

To update the BIOS file using the BUPDATER utility:

1. Visit the ASUS website at [www.asus.com](http://www.asus.com) and download the latest BIOS file for the motherboard. Save the BIOS file to a bootable USB flash disk drive.
2. Copy the BUPDATER utility (BUPDATER.exe) from the ASUS support website at [support.asus.com](http://support.asus.com) to the bootable USB flash disk drive you created earlier.
3. Boot the system in DOS mode, then at the prompt, type:

```
BUPDATER /i [filename] .CAP
```

where [filename] is the latest or the original BIOS file on the bootable USB flash disk drive, then press <Enter>.

```
A:\>BUPDATER /i[file name].CAP
```



## 4.2 BIOS setup program

This motherboard supports a programmable firmware chip that you can update using the provided utility described in section **5.1 Managing and updating your BIOS**.

Use the BIOS Setup program when you are installing a motherboard, reconfiguring your system, or prompted to "Run Setup." This section explains how to configure your system using this utility.

Even if you are not prompted to use the Setup program, you can change the configuration of your computer in the future. For example, you can enable the security password feature or change the power management settings. This requires you to reconfigure your system using the BIOS Setup program so that the computer can recognize these changes and record them in the CMOS RAM of the firmware chip.

The firmware chip on the motherboard stores the Setup utility. When you start up the computer, the system provides you with the opportunity to run this program. Press <Del> during the Power-On Self-Test (POST) to enter the Setup utility; otherwise, POST continues with its test routines.

If you wish to enter Setup after POST, restart the system by pressing <Ctrl+Alt+Delete>, or by pressing the reset button on the system chassis. You can also restart by turning the system off and then back on. Do this last option only if the first two failed.

The Setup program is designed to make it as easy to use as possible. Being a menu-driven program, it lets you scroll through the various sub-menus and make your selections from the available options using the navigation keys.



- 
- The default BIOS settings for this motherboard apply for most conditions to ensure optimum performance. If the system becomes unstable after changing any BIOS settings, load the default settings to ensure system compatibility and stability. Press <F5> and select **Yes** to load the BIOS default settings.
  - The BIOS setup screens shown in this section are for reference purposes only, and may not exactly match what you see on your screen.
  - Visit the ASUS website ([www.asus.com](http://www.asus.com)) to download the latest BIOS file for this motherboard.
-

## 4.2.1 BIOS menu screen

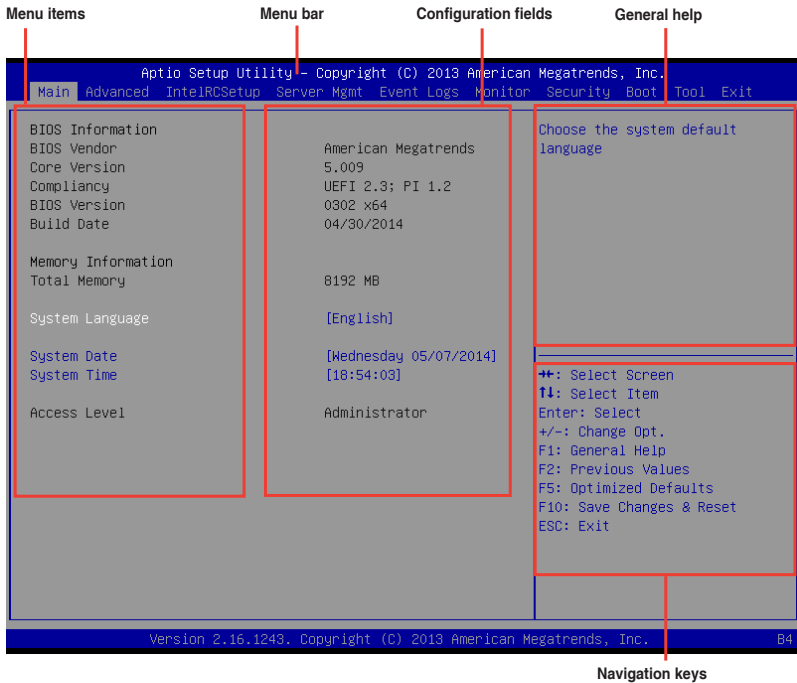

## 4.2.2 Menu bar

The menu bar on top of the screen has the following main items:

<b>Main</b>	For changing the basic system configuration
<b>Advanced</b>	For changing the advanced system settings
<b>IntelRCSetup</b>	For changing the Intel RC settings
<b>Server Mgmt</b>	For changing the Server Mgmt settings
<b>Event Logs</b>	For changing the event log settings
<b>Monitor</b>	For displaying the system temperature, power status, and changing the fan settings
<b>Security</b>	For changing the security settings
<b>Boot</b>	For changing the system boot configuration
<b>Tool</b>	For configuring options for special functions
<b>Exit</b>	For selecting the exit options

To select an item on the menu bar, press the right or left arrow key on the keyboard until the desired item is highlighted.

### **4.2.3 Menu items**

The highlighted item on the menu bar displays the specific items for that menu. For example, selecting **Main** shows the Main menu items.

The other items (Event Logs, Advanced, Monitor, Boot, Tool, and Exit) on the menu bar have their respective menu items.

### **4.2.4 Submenu items**

A solid triangle before each item on any menu screen means that the item has a submenu. To display the submenu, select the item then press <Enter>.

### **4.2.5 Navigation keys**

At the bottom right corner of a menu screen are the navigation keys for the BIOS setup program. Use the navigation keys to select items in the menu and change the settings.

### **4.2.6 General help**

At the top right corner of the menu screen is a brief description of the selected item.

### **4.2.7 Configuration fields**

These fields show the values for the menu items. If an item is user-configurable, you can change the value of the field opposite the item. You cannot select an item that is not user-configurable.

A configurable field is enclosed in brackets, and is highlighted when selected. To change the value of a field, select it and press <Enter> to display a list of options.

### **4.2.8 Pop-up window**

Select a menu item and press <Enter> to display a pop-up window with the configuration options for that item.

### **4.2.9 Scroll bar**

A scroll bar appears on the right side of a menu screen when there are items that do not fit on the screen. Press the Up/Down arrow keys or <Page Up> /<Page Down> keys to display the other items on the screen.



## 4.3 Main menu

When you enter the BIOS Setup program, the Main menu screen appears. The Main menu provides you an overview of the basic system information, and allows you to set the system date, time, language, and security settings.

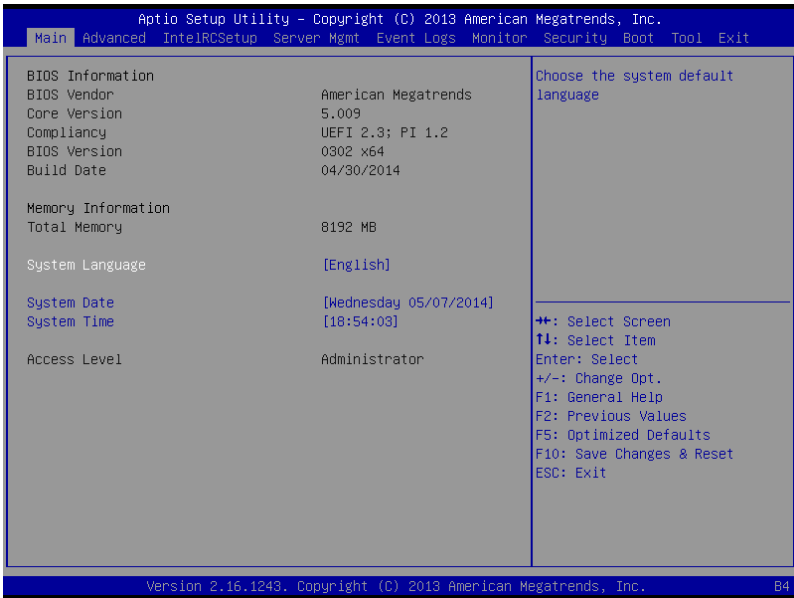

### 4.3.1 System Date [Day xx/xx/xxxx]

Allows you to set the system date.

### 4.3.2 System Time [xx:xx:xx]

Allows you to set the system time.

## 4.4 Advanced menu

The Advanced menu items allow you to change the settings for the CPU and other system devices.



Take caution when changing the settings of the Advanced menu items. Incorrect field values can cause the system to malfunction.

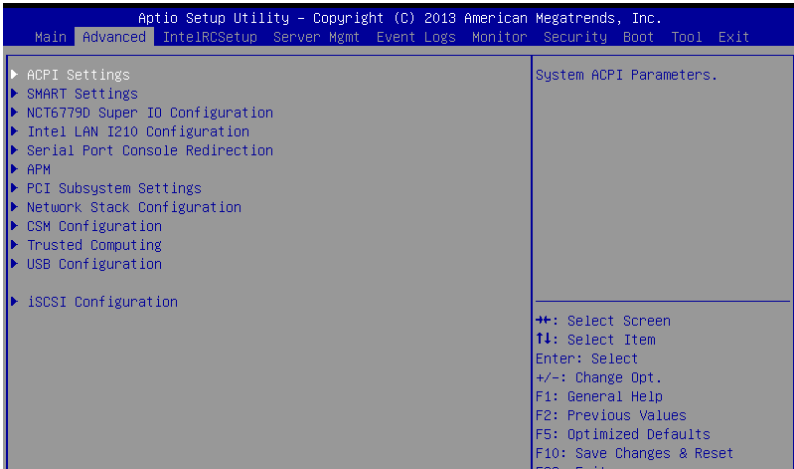

## 4.4.1 ACPI Settings

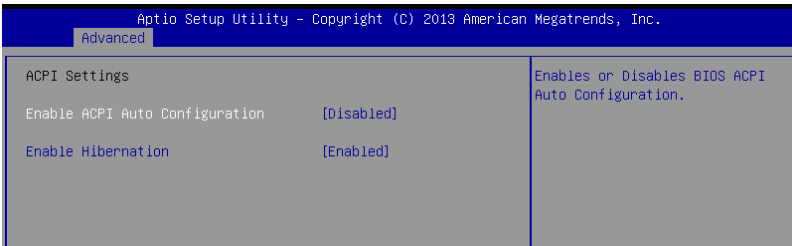

### Enable ACPI Auto Configuration [Disabled]

Allows you to enable or disable the BIOS ACPI Auto Configuration.

Configuration options: [Disabled] [Enabled]

### Enable Hibernation [Enabled]

Allows you to enable or disable the ability of the system to hibernate (OS/Sleep State).

Configuration options: [Disabled] [Enabled]



---

This option may be not effective with some OS.

---

## 4.4.2 Smart Settings

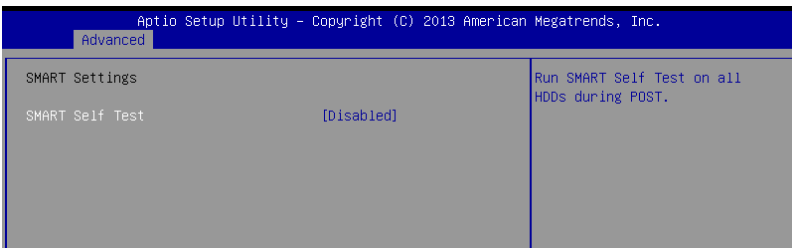

### SMART Self Test [Disabled]

Allows you to run SMART Self Test on all HDDs during POST.

Configuration options: [Disabled] [Enabled]

## 4.4.3 NCT6779D Super IO Configuration

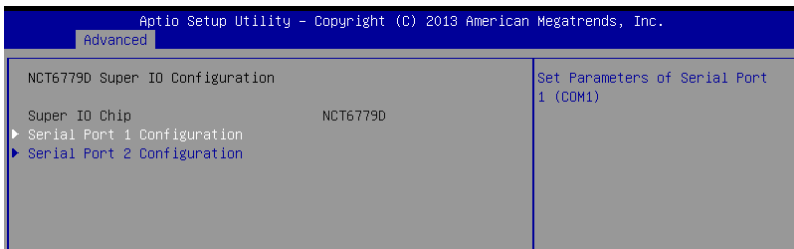

### Serial Port 1 / Serial Port 2 Configuration

Allows you to set the parameters of Serial Port 1/ Serial Port 2.

#### Serial Port [Enabled]

Allows you to enable or disable Serial Port.

Configuration options: [Disabled] [Enabled]

#### Change Settings [Auto]

Allows you to choose the setting for Super IO device.

Configuration options: [Auto] [IO=3F8h; IRQ=4;] [IO=3F8h; IRQ=3, 4, 5, 6, 7, 9, 10, 11, 12;]  
[IO=2F8h; IRQ=3, 4, 5, 6, 7, 9, 10, 11, 12;] [IO=3E8h; IRQ=3, 4, 5, 6, 7, 9, 10, 11, 12;]  
[IO=2E8h; IRQ=3, 4, 5, 6, 7, 9, 10, 11, 12;]

## 4.4.4 Intel LAN I210 IO Configuration

Aptio Setup Utility - Copyright (C) 2013 American Megatrends, Inc.	
Advanced	
Intel LAN I210 Configuration	Intel LAN Enable/Disable
INTEL I210 LAN1 MAC:	00:E0:18:02:21:16
INTEL I210 LAN2 MAC:	00:E0:18:02:21:17
Intel I210 Lan1 Enable	[Enabled]
Intel LAN ROM Type	[PXE]
Intel I210 Lan2 Enable	[Enabled]
Intel LAN ROM Type	[PXE]

### Intel LAN Support [Enabled]

Allows you to enable or disable the Intel LAN.

Configuration options: [Disabled] [Enabled]

### Intel LAN ROM Type [PXE]

Allows you to select the Intel LAN ROM type.

Configuration options: [PXE] [iSCSI]

### Intel LAN I210 LAN1 / LAN2 Enable [Enabled]

Allows you to enable or disable the Intel LAN.

Configuration options: [Disabled] [Enabled]



---

The following items appear only when Intel LAN I210 LAN1 / LAN2 Enable is set to [Enabled].

---

### LAN1/ LAN2 Option ROM Support [Enabled]

Allows you to load the Intel LAN ROM.

Configuration options: [Disabled] [Enabled]

## 4.4.5 Serial Port Console Redirection

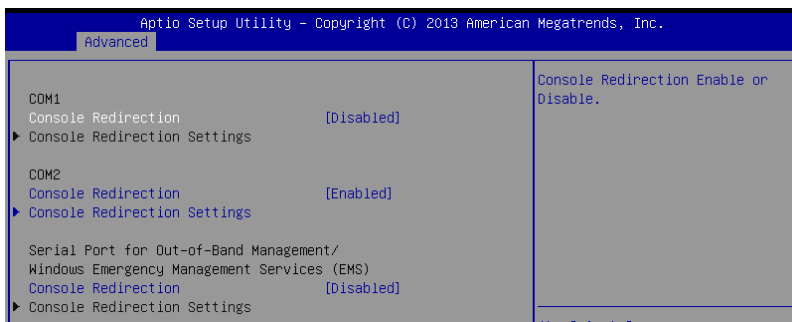

### COM1/COM2

#### Console Redirection [Enabled]

Allows you to enable or disable the console redirection feature.

Configuration options: [Disabled] [Enabled]



The following item appears only when you set **Console Redirection** to [Enabled].

#### Console Redirection Settings

This item becomes configurable only when you enable the **Console Redirection** item. The settings specify how the host computer and the remote computer (which the user is using) will exchange data. Both computers should have the same or compatible settings.

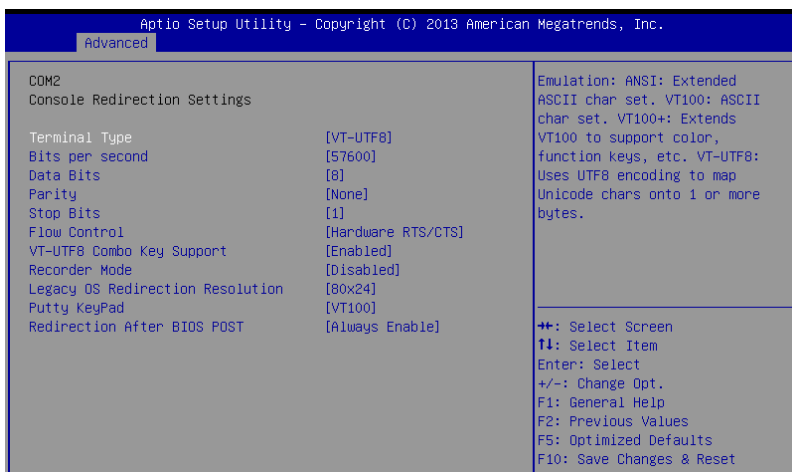

### **Terminal Type [VT-UTF8]**

Allows you to set the terminal type.

[VT100]	ASCII char set.
[VT100+]	Extends VT100 to support color, function keys, et.
[VT-UTF8]	Uses UTF8 encoding to map Unicode chars onto 1 or more bytes
[ANSI]	Extended ASCII char set

### **Bits per second [57600]**

Selects serial port transmission speed. The speed must be matched on the other side. Long or noisy lines may require lower speeds.

Configuration options: [9600] [19200] [38400] [57600] [115200]

### **Data Bits [8]**

Configuration options: [7] [8]

### **Parity [None]**

A parity bit can be sent with the data bits to detect some transmission errors. [Mark] and [Space] parity do not allow for error detection.

[None]	None
[Even]	parity bit is 0 if the num of 1's in the data bits is even
[Odd]	parity bit is 0 if num of 1's in the data bits is odd
[Mark]	parity bit is always 1
[Space]	parity bit is always 0

### **Stop Bits [1]**

Stop bits indicate the end of a serial data packet. (A start bit indicates the beginning.) The standard setting is 1 stop bit. Communication with slow devices may require more than 1 stop bit. Configuration options: [1] [2]

### **Flow Control [Hardware RTS/CTS]**

Flow control can prevent data loss from buffer overflow. When sending data, if the receiving buffers are full, a "stop" signal can be sent to stop the data flow. Once the buffers are empty, a "start" signal can be sent to re-start the flow. Hardware flow control uses two wires to send start/stop signals.

Configuration options: [None] [Hardware RTS/CTS]

### **VT -UTF8 Combo Key Support [Enabled]**

This allows you to enable the VT -UTF8 Combination Key Support for ANSI/VT100 terminals. Configuration options: [Disabled] [Enabled]

### **Recorder Mode [Disabled]**

With this mode enabled only text will be sent. This is to capture Terminal data.

Configuration options: [Disabled] [Enabled]

### **Legacy OS Redirection Resolution [80x24]**

This allows you to set the number of rows and columns supported on the Legacy OS.

Configuration options: [80x24] [80x25]

### **Putty Keypad [VT100]**

This allows you to select the FunctionKey and Keypad on Putty. Configuration options:

[VT100] [LINUX] [XTERMR6] [SCO] [ESCN] [VT400]

### **Redirection After BIOS POST [Bootloader]**

This setting allows you to specify if Bootloader is selected than Legacy console redirection. Configuration options: [Always Enable] [Bootloader]

## **Serial Port for Out-of-Band Management/**

### **Windows Emergency Management Services (EMS)**

#### **Console Redirection [Disabled]**

Allows you to enable or disable the console redirection feature.  
Configuration options: [Disabled] [Enabled]



---

The following item appears only when you set **Console Redirection** to [Enabled].

---

## **Console Redirection Settings**

### **Out-of-Band Mgmt Port [COM1]**

Microsoft Windows Emergency Management Services (EMS) allow for remote management of a Windows Server OS through a serial port.  
Configuration options: [COM1] [COM2]

### **Terminal Type [VT-UTF8]**

Microsoft Windows Emergency Management Services (EMS) allow for remote management of a Windows Server OS through a serial port.  
Configuration options: [VT100] [VT100+] [VT-UTF8] [ANSI]

### **Bits per second [115200]**

Microsoft Windows Emergency Management Services (EMS) allow for remote management of a Windows Server OS through a serial port.  
Configuration options: [9600] [19200] [57600] [115200]

### **Flow Control [None]**

Microsoft Windows Emergency Management Services (EMS) allow for remote management of a Windows Server OS through a serial port.  
Configuration options: [None] [Hardware RTS/CTS] [Software Xon/Xoff]



## 4.4.6 APM

Allows you to configure the Advance Power Management (APM) settings.

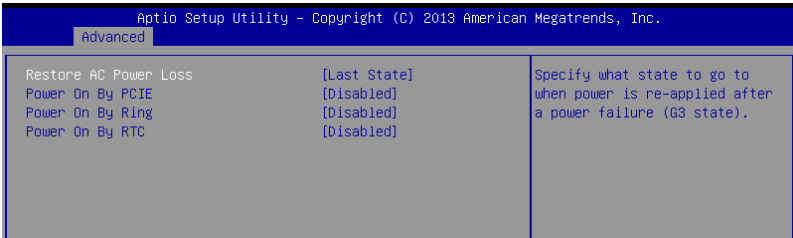

### Restore AC Power Loss [Last State]

When set to [Power Off], the system goes into off state after an AC power loss. When set to [Power On], the system will reboot after an AC power loss. When set to [Last State], the system goes into either off or on state, whatever the system state was before the AC power loss.

Configuration options: [Power Off] [Power On] [Last State]

### Power On By PCIE [Disabled]

[Disabled] Disables the PCIE devices to generate a wake event.

[Enabled] Enables the PCIE devices to generate a wake event.

### Power On By Ring [Disabled]

[Disabled] Disables the PCIE devices to generate a wake event.

[Enabled] Enables the PCIE devices to generate a wake event.

### Power On By RTC [Disabled]

[Disabled] Disables RTC to generate a wake event.

[Enabled] When set to [Enabled], the items **RTC Alarm Date (Days)** and **Hour/Minute/Second** will become user-configurable with set values.

## 4.4.7 PCI Subsystem Settings

Allows you to configure PCI, PCI-X, and PCI Express Settings.

Aptio Setup Utility - Copyright (C) 2013 American Megatrends, Inc.		
Advanced		
PCI Bus Driver Version	A5.01.05	Enables or Disables RT32 Image Loading.
PCI Devices Common Settings:		
Load RT32 Image	[Enabled]	
Above 4G Decoding	[Disabled]	
SR-IOV Support	[Disabled]	

### Load RT32 Image [Enabled]

Allows you to enable or disable RT32 Image Loading.

Configuration options: [Disabled] [Enabled]

### Above 4G Decoding [Disabled]

Allows you to enable or disable 64-bit capable devices to be decoded in above 4G address space. It only works if the system supports 64-bit PCI decoding.

Configuration options: [Disabled] [Enabled]

### SR-IOV Support [Disabled]

This option enables or disables Single Root IO Virtualization Support if the system has SR-IOV capable PCIe devices.

Configuration options: [Disabled] [Enabled]

## 4.4.8 Network Stack Configuration

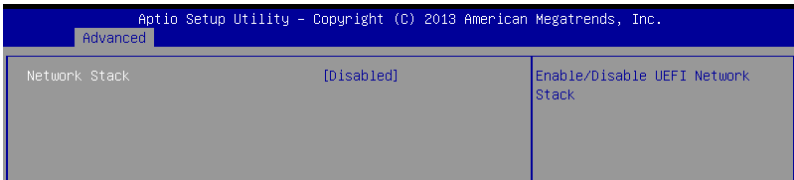

### Network stack [Disabled]

Enables or disables the network stack feature. Configuration options: [Disable] [Enable]



The following item appears only when **Network stack** is set to [Enabled].

#### Ipv4 PXE Support [Enabled]

Enables or disables the Ipv4 PXE Boot Support. If disabled, Ipv4 PXE boot option will not be created. Configuration options: [Disabled] [Enabled].

#### Ipv6 PXE Support [Enabled]

Enables or disables the Ipv6 PXE Boot Support. If disabled, Ipv6 PXE boot option will not be created. Configuration options: [Disabled] [Enabled].

#### PXE boot wait time [0]

Wait time to press ESC key to abort the PXE boot.

#### Media detect time [0]

Wait time (in seconds) to detect media.

## 4.4.9 CSM Configuration

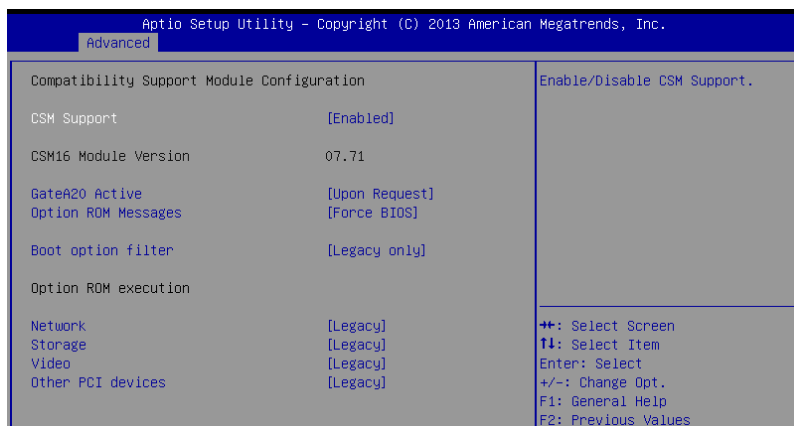

### CSM Support [Enabled]

This option allows you to enable or disable CSM Support.

Configuration options: [Disabled] [Enabled]

### GateA20 Active [Upon Request]

This allows you to set the GA20 option.

Configuration options: [Upon Request] [Always]

### Option ROM Messages [Force BIOS]

This allows you to set the display mode for option ROM.

Configuration options: [Force BIOS] [Keep Current]

### Boot Option filter [Legacy only]

This option allows you to control the Legacy/UEFI ROMs priority.

Configuration options: [UEFI and Legacy] [Legacy only] [UEFI only]

### Network / Storage / Video [Legacy]

This option allows you to control the execution of UEFI and Legacy PXE/ Storage/ Video OpROM.

Configuration options: [UEFI ] [Legacy]

### Other PCI devices [Legacy]

This item determines the OpROM execution policy for devices other than Network, Storage, or Video.

Configuration options: [UEFI ] [Legacy]

## 4.4.10 Trusted Computing

Aptio Setup Utility - Copyright (C) 2013 American Megatrends, Inc.		
Advanced		
Configuration		
Security Device Support	[Disabled]	Enables or Disables BIOS support for security device. O.S. will not show Security Device. TCG EFI protocol and INT1A interface will not be available.
Current Status Information		
NO Security Device Found		

### Configuration

#### Security Device Support [Disabled]

Allows you to enable or disable the BIOS support for security device.

Configuration options: [Disabled] [Enabled]

## 4.4.11 USB Configuration

Aptio Setup Utility - Copyright (C) 2013 American Megatrends, Inc.		
Advanced		
USB Configuration		Enables Legacy USB support. AUTO option disables legacy support if no USB devices are connected. DISABLE option will keep USB devices available only for EFI applications.
USB Module Version	8.11.01	
USB Devices: 1 Drive, 1 Keyboard, 1 Mouse, 2 Hubs		
Legacy USB Support	[Enabled]	
XHCI Hand-off	[Enabled]	
EHCI Hand-off	[Disabled]	
USB Mass Storage Driver Support	[Enabled]	
Port 60/64 Emulation	[Enabled]	
USB hardware delays and time-outs:		++: Select Screen
USB transfer time-out	[20 sec]	F1: Select Item
Device reset time-out	[20 sec]	Enter: Select
Device power-up delay	[Auto]	+/-: Change Opt.
Mass Storage Devices:		F1: General Help
Generic 8.07	[Auto]	F2: Previous Values
		F5: Optimized Defaults

### Legacy USB Support [Enabled]

Allows you to enable or disable Legacy USB device support.

Configuration options: [Enabled] [Disabled] [Auto]

### XHCI Hand-off [Enabled]

This is a workaround for OSes without XHCI hand-off support. The XHCI ownership change should be claimed by XHCI driver.

Configuration options: [Disabled] [Enabled]

### EHCI Hand-off [Disabled]

This is a workaround for OSes without EHCI hand-off support. The EHCI ownership change should be claimed by EHCI driver.

Configuration options: [Disabled] [Enabled]

### USB Mass Storage Driver Support [Enabled]

Allows you to enable or disable the USB Mass Storage driver support.

Configuration options: [Disabled] [Enabled]

### Port 60/64 Emulation [Enabled]

This allows you to enable the I/O port 60h/64h emulation support. This should be enabled for the complete USB keyboard legacy support for non-USB aware OSes.

Configuration options: [Disabled] [Enabled]

## USB hardware delays and time-outs

### USB transfer time-out [20 sec]

The time-out value for control, bulk, and interrupt transfer.

Configuration options: [1 sec] [5 sec] [10 sec] [20 sec]

### Device reset time-out [20 sec]

USB mass storage device start unit command time-out.

Configuration options: [10 sec] [20 sec] [30 sec] [40 sec]

### Device power-up delay [Auto]

This is the maximum time the device will take before it properly reports itself to the host controller.

Configuration options: [Auto] [Manual]

## Mass Storage Devices

### Generic 8.07 [Auto]

Allows you to select the mass storage device emulation type.

Configuration options: [Auto] [Floppy] [Forced FDD] [Hard Disk] [CD-ROM]

## 4.4.12 iSCSI Configuration

Allows you to configure the iSCSi parameters.

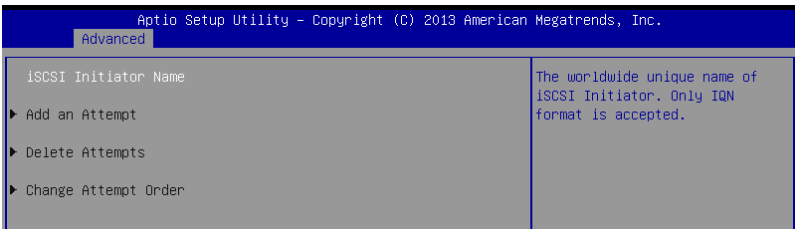

# 4.5 IntelRCSetup menu

The IntelRCSetup menu items allow you to change the processor and chipset settings.

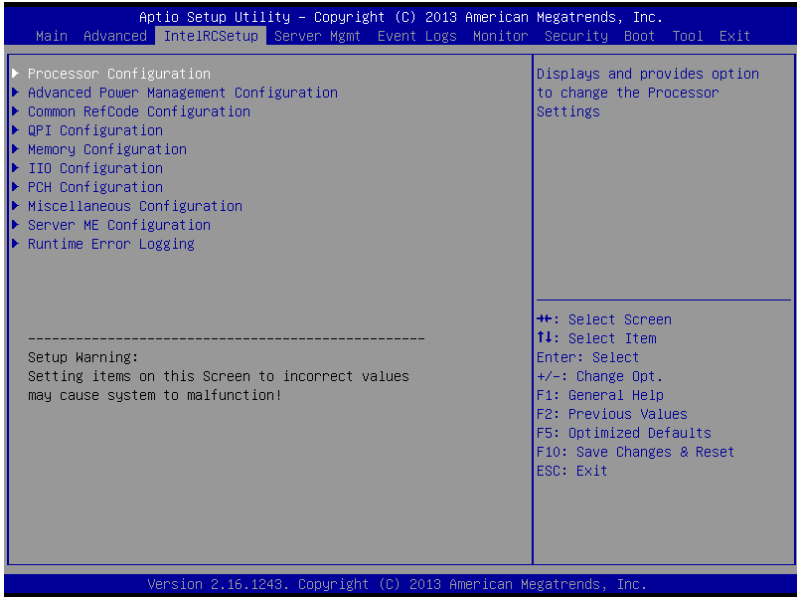



## 4.5.1 Processor Configuration

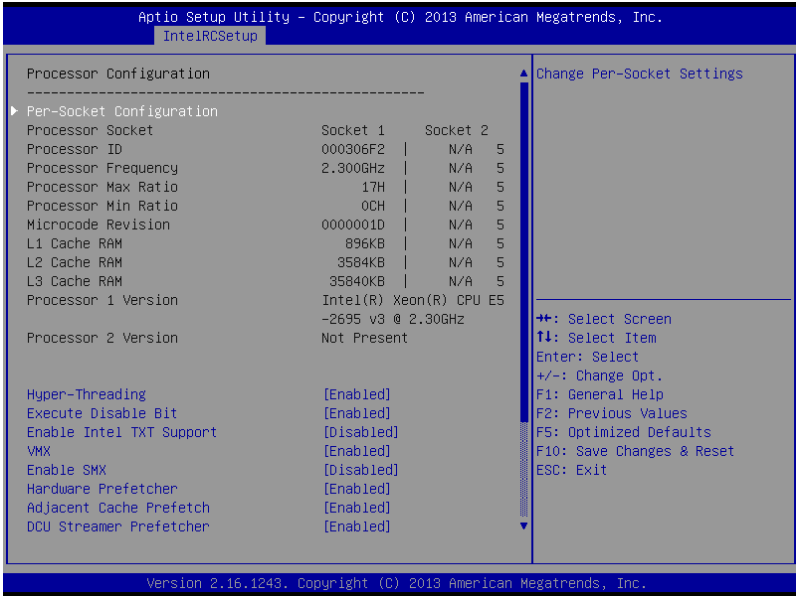

### Per Socket Configuration

Allows you to set the number of cores to enable. 0 means all cores. Total of 14 cores available.

### Hyper Threading [Enabled]

Allows you to enable or disable the Intel® Hyper-Threading Technology function. When disabled, only one thread per activated core is enabled.

Configuration options: [Disabled] [Enabled]

### Execute Disable Bit [Enabled]

XD can prevent certain classes of malicious buffer overflow attacks when combined with a supporting OS (Windows Server 2003 SP1, Windows XP SP2, SuSE Linux 9.2, Redhat Enterprise 3 Update 3).

Configuration options: [Disabled] [Enabled]

### Enable Intel TXT Support [Disabled]

Forces the XD feature log to always return 0 when disabled.

Configuration options: [Disabled] [Enabled]

### VMX [Enabled]

Enables the Vanderpool Technology. Takes effect after reboot.

Configuration options: [Disabled] [Enabled]

### **Enable SMX [Disabled]**

Enables the Safer Mode Extensions

Configuration options: [Disabled] [Enabled]

### **Hardware Prefetcher [Enabled]**

This Item allows you to turn on/off the mid level cache(L2) streamer prefetcher.

Configuration options: [Disabled] [Enabled]

### **Adjacent Cache Prefetch [Enabled]**

This Item allows you to turn on/off prefetching of adjacent cache lines.

Configuration options: [Disabled] [Enabled]

### **DCU Streamer Prefetcher [Enabled]**

This Item allows you to enable or disable prefetcher of next L1 data line.

Configuration options: [Disabled] [Enabled]

### **DCU IP Prefetcher [Enabled]**

This Item allows you to enable or disable prefetch of next L1 line based upon sequential load history.

Configuration options: [Disabled] [Enabled]

### **DCU Mode [32K 8Way Without ECC]**

Configuration options: [32K 8Way Without ECC] [16K 4Way With ECC]

### **Direct Cache Access (DCA) [Auto]**

This Item allows you to enable or disable Direct Cache Access.

Configuration options: [Auto] [Disabled] [Enabled]

### **DCA Prefetch Delay [32]**

This Item allows you to set the time for the DCA Prefetch delay Help.

Configuration options: [Disabled] [8] [16] [24] [32] [40] [48] [56] [64] [72] [80] [88] [96] [104] [112]

### **X2APIC [Disabled]**

This Item allows you to enable or disable the extended APIC support.

Configuration options: [Disabled] [Enabled]

### **AES-NI [Enabled]**

This Item allows you to enable or disable the AES-NI support.

Configuration options: [Disabled] [Enabled]

### **Down Stream PECl [Disabled]**

This Item allows you to enable the PCIe Down Stream PECl writer.

Configuration options: [Disabled] [Enabled]

## 4.5.2 Advanced Power Management Configuration

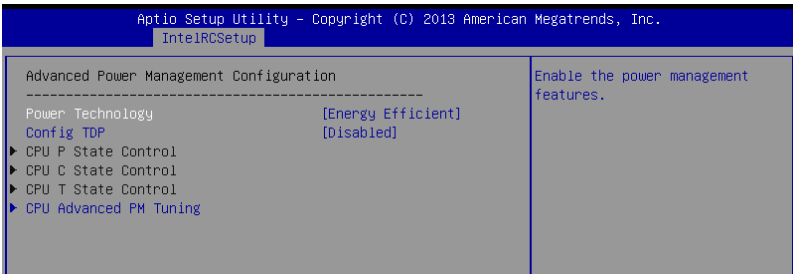

### Power Technology [Energy Efficient]

This item allows you to enable power management features.  
Configuration options: [Disabled] [Energy Efficient] [Custom]

### Config TDP [Disabled]

This item allows you to enable/disable the Config TDP.  
Configuration options: [Disabled] [Enabled]

### CPU Advanced PM Turning

This item allows you to set additional CPU Power Management settings.

## Energy Perf BIAS

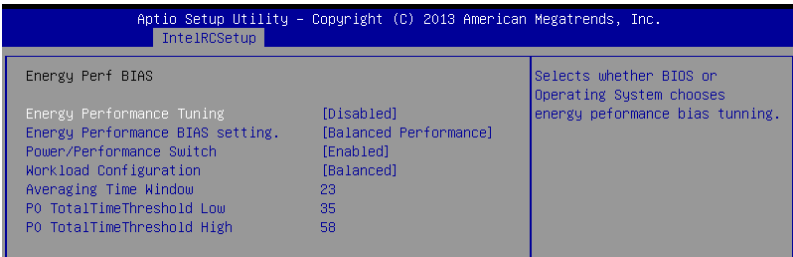

### Energy Performance Tuning [Disabled]

Allows your system to select from BIOS or operating system to choose enable energy performance bias tuning.  
Configuration options: [Disabled] [Enabled]

### Energy Performance Bias setting [Balanced Performance]

Allows you to set the Energy Performance Bias which overrides the OS setting.  
Configuration options: [Performance] [Balanced Performance] [Balanced Power] [Power]

**Power/Performance Switch [Enabled]**

Allows you to switch between Power or performance.

Configuration options: [Disabled] [Enabled]

**Workload Configuration [Balanced]**

Optimization for the workload characterization.

Configuration options: [Balanced] [I/O sensitive]

**Averaging Time Window [23]**

This is used to control the effective window of the average for CO and PO time.

**PO TotalTimeThreshold Low [35]**

The HW switching mechanism disables the performance setting (0) when the total PO time is less than this threshold.

**PO TotalTimeThreshold High [58]**

The HW switching mechanism enables the performance setting (0) when the total PO time is greater than this threshold.

### 4.5.3 Common RefCode Configuration

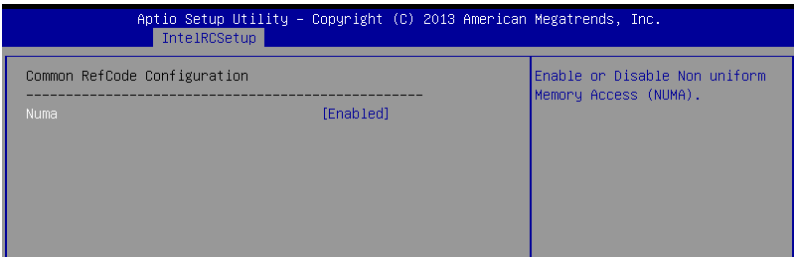

**Numa [Enabled]**

This item enables or disables the Non uniform Memory Access (NUMA).

Configuration options: [Disabled] [Enabled]

## 4.5.4 QPI Configuration

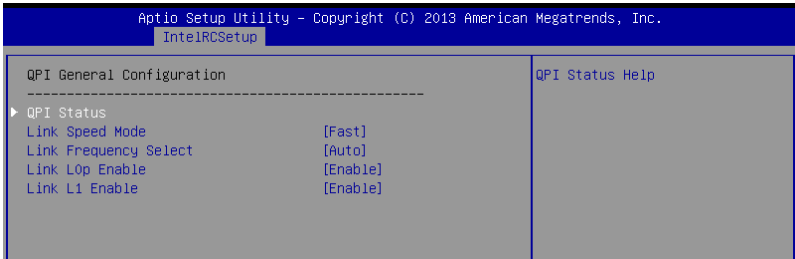

### QPI General Configuration

#### QPI Status

This item displays information about the QPI status.

#### Link Speed Mode [Fast]

This item allows you to select the QPI link speed as either the fast mode or slow mode.

Configuration options: [Slow] [Fast]

#### Link Frequency Select [Auto]

This item allows you for selecting the QPI link frequency

Configuration options: [Auto] [6.4 GT/s] [8.0 GT/s] [9.6 GT/s]

#### QPI Link0p Enable [Enable]

Configuration options: [Disable] [Enable]

#### QPI Link1 Enable [Enable]

Configuration options: [Disable] [Enable]

### QPI Status

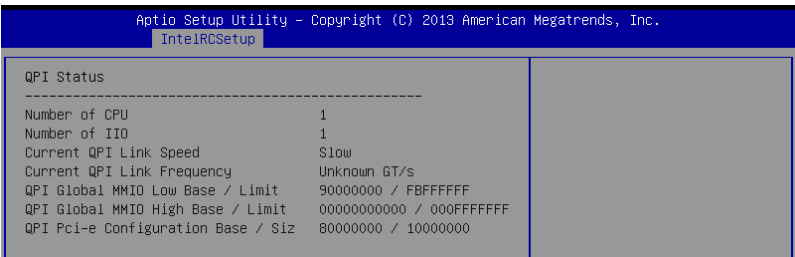

## 4.5.5 Memory Configuration

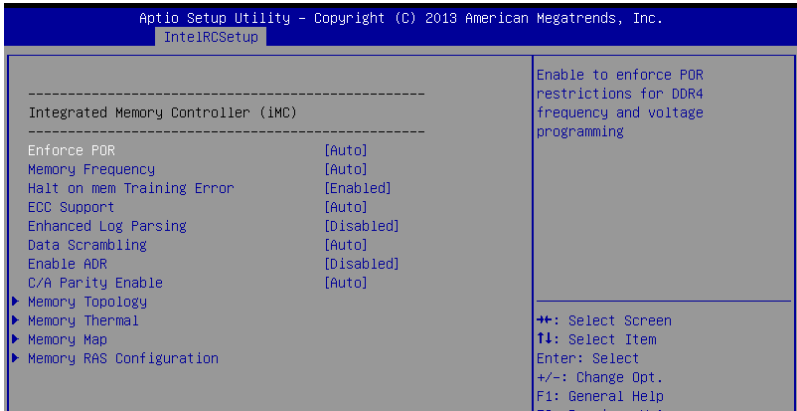

### Enforce POR [Auto]

Allows you to enforce POR restrictions for DDR4 frequency and voltage programming.  
Configuration options: [Auto] [Enforce POR] [Disabled] [Enforce Stretch Goals]

### Memory Frequency [Auto]

Allows you to select the memory frequency setting.  
Configuration options: [Auto] [1333] [1600] [1866] [2133]

### Halt on mem Training Error [Enabled]

Allows you to enable or disable halt on mem Training Error.  
Configuration options: [Disabled] [Enabled]

### ECC Support [Auto]

Allows you to enable or disable the ECC support.  
Configuration options: [Auto] [Disabled] [Enabled]

### Enhanced Log Parsing [Disabled]

Allows you to enable or disable the Enhanced Log Parsing.  
Configuration options: [Auto] [Disabled] [Enabled]

### Data Scrambling [Auto]

Allows you to enable/disable data scrambling.  
Configuration options: [Auto] [Disabled] [Enabled]

### Enable ADR [Disabled]

Allows you to set the detecting and enabling of ADR.  
Configuration options: [Disabled] [Enabled]

## C/A Parity Enable [Auto]

Allows you to enable or disable the DDR4's command address parity.

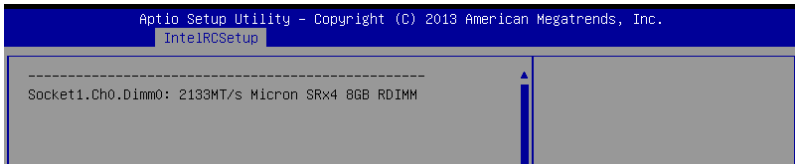

Configuration options: [Auto] [Disabled] [Enabled]

## Memory Topology

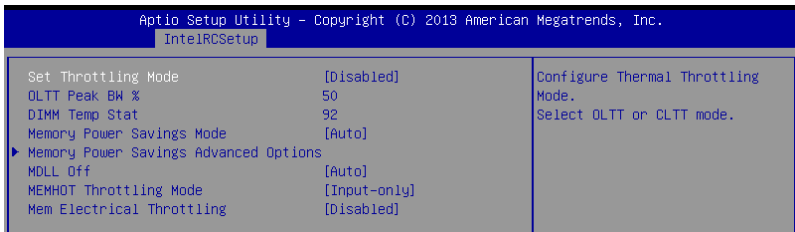

Displays memory topology with DIMM population information.

## Memory Thermal

Allows you to configure thermal settings.

### Set Throttling Mode [Disabled]

Configuration options: [Disabled] [OLTT] [CLTT]

### OLTT Peak BW [xxx]

Allows you to set the peak allowed bandwidth for OLTT. This is in percentage and valid offset values is from 25-100.

### DIMM Tem Stat [xx]

Allows you to select DIMMTEMPSTAT as temp\_mid or temp\_hi.

### Memory Power Savings Mode [Auto]

Allows you to configure the CKE and other related Memory Power Savings features.

Configuration options: [Auto] [Disabled] [APD On] [User Defined] [Reserve] [Reserved]

### Memory Power Savings Advanced Options

#### CK in SR [Auto]

Configuration options: [Auto] [Driven] [Tri-State] [Pulled Low] Pulled High]

### MDLL Off [Auto]

Allows you to shutdown MDLL during SR when enabled.

Configuration options: [Auto] [Disabled] [Enabled]

### MEMHOT Throttling Mode [Input-only]

Allows you to shutdown MDLL during SR when enabled.

Configuration options: [Disabled] [Input-only] [Output-only]

## Mem Electrical Throttling [Disabled]

Aptio Setup Utility - Copyright (C) 2013 American Megatrends, Inc.		
IntelRCSetup		
Channel Interleaving	[Auto]	Select Channel Interleaving setting
Rank Interleaving	[Auto]	

Allows you to configure Memory Electrical throttling.  
Configuration options: [Disabled] [Enabled] [Auto]

## Memory Map

### Channel Interleaving [Auto]

Select different channel interleaving setting.  
Configuration options: [Auto] [1-way Interleave] [2-way Interleave] [3-way Interleave] [4-way Interleave]

### Rank Interleaving [Auto]

Select different rank interleaving setting.  
Configuration options: [Auto] [1-way Interleave] [2-way Interleave] [4-way Interleave] [8-way Interleave]

## Memory RAS Configuration

Aptio Setup Utility - Copyright (C) 2013 American Megatrends, Inc.		
IntelRCSetup		
----- Memory RAS Configuration Setup -----		Enable/Disable RAS modes. Enabling Sparing and Mirroring is not supported. In case if enabled, Sparing will be selected.
RAS Mode	[Disabled]	
Memory Rank Sparing	[Disabled]	
Correctable Error Threshold	32767	
Patrol Scrub	[Enabled]	
Demand Scrub	[Enabled]	

### RAS Mode [Disabled]

Allows you to enable or disable RAS Modes. Enabling Sparing and Mirroring is not supported. In case enabled, Sparing will be selected.  
Configuration options: [Disabled] [Mirror] [Lockstep Mode]

### Memory Rank Sparing [Disabled]

Allows you to enable or disable Memory Rank Sparing.  
Configuration options: [Disabled] [Enabled]

### Correctable Error Threshold [32767]

Allows you to set the Correctable Error Threshold used for sparing, tagging, and leaky bucket. The range is from 1 to 32767.

### Patrol Scrub [Enabled]

Allows you to enable or disable Patrol Scrub.  
Configuration options: [Disabled] [Enabled]

### Demand Scrub [Enabled]

Allows you to enable or disable Demand Scrub.  
Configuration options: [Disabled] [Enabled]



## 4.5.6 IIO Configuration

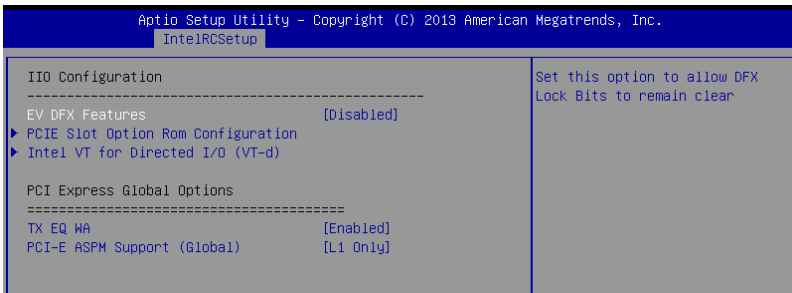

### EV DFX Features [Disabled]

Set this option to allow DFX Lock Bits to remain clear.

Configuration options: [Disabled] [Enabled]

### PCI Slot Option ROM Configuration

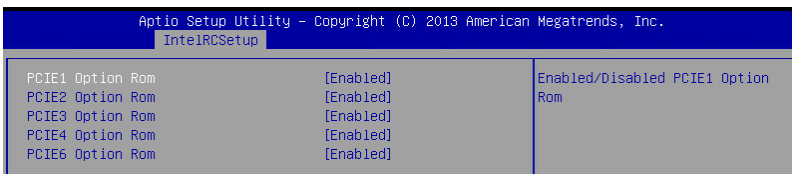

### PCI E1/ PCI E2/ PCI E3/ PCI E4/ PCI E6 Option ROM [Disabled]

Allows you to enable or disable the PCI E1/ PCI E2/ PCI E3/ PCI E4/ PCI E6 Option ROM.

Configuration options: [Disabled] [Enabled]

### Intel VT for Directed I/O (VT-d)

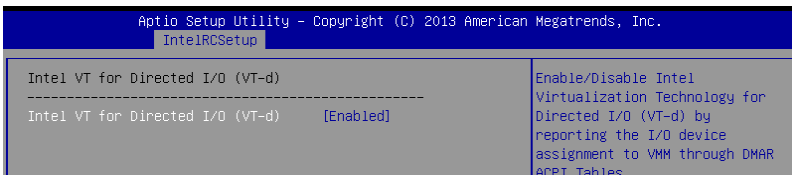

### Intel VT for Directed I/O (VT-d) [Enabled]

Allows you to enable or disable the Intel Virtualization Technology for Directed I/O.

Configuration options: [Disabled] [Enabled]

### PCI Express Global Options

#### TX EQ WA [Enabled]

Use special table for TX\_EQ and vendor specific cards.

Configuration options: [Disabled] [Enabled]

### PCI-E ASPM Support (Global) [L1 Only]

This option enables or disables the ASPM support for all downstream devices.  
Configuration options: [Disabled] [L1 Only]

## 4.5.7 PCH Configuration

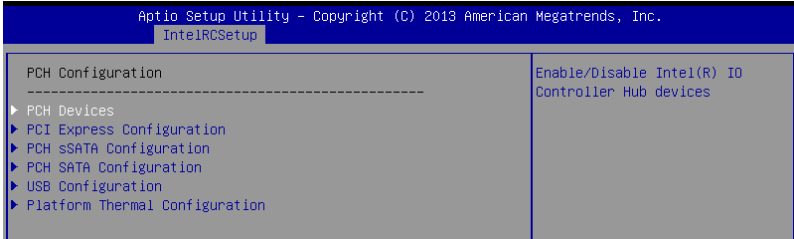

### PCH Devices

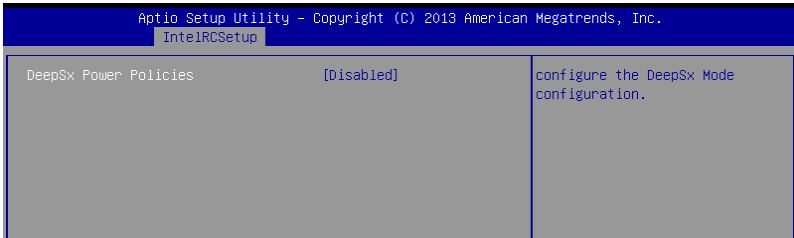

### DeepSx Power Policies [Disabled]

Allows you to configure the DeepSx Mode configuration.  
Configuration options: [Disabled] [Enabled in S5] [Enabled in S4 and S5]

### PCI Express Configuration

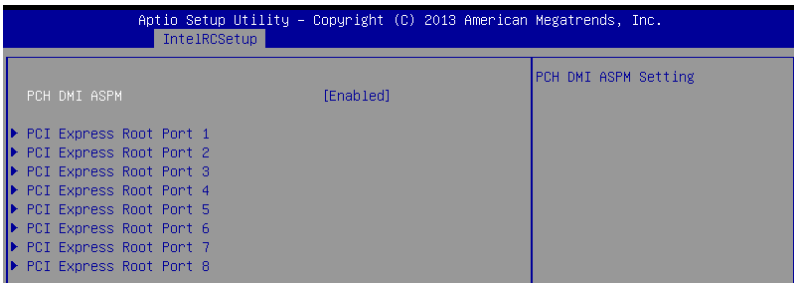

### **PCH DMI ASPM [Enabled]**

Allows you to configure the PCH DMI ASPM.

Configuration options: [Disabled] [Enabled]

### **PCI Express Root Port 1 to Port 8**

Allows you to configure the PCI Express Root port settings.

**PCIE ASMP** [Disable ASPM]

**Allows you to configure the PCH DMI ASPM.**

Configuration options: [Disable ASPM] [ASPM L0s] [ASPM L1] [ASPM L0sL1] [ASPM Auto]

## **PCH sSATA Configuration**

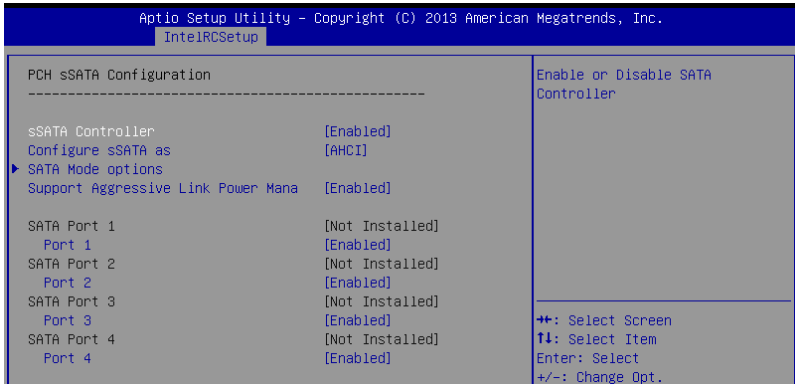

### **sSATA Controller [Enabled]**

Allows you to enable or disable the sSATA Controller.

Configuration options: [Disabled] [Enabled]

### **Configure sSATA as [AHCI]**

Allows you to identify the SATA port is connected to Solid State Drive or Hard Disk Drive.

Configuration options: [IDE] [AHCI] [RAID]

### **SATA Mode options**

#### **SATA LED locate [Enabled]**

If enabled, LED/SGPIO hardware is attached.

Configuration options: [Disabled] [Enabled]

### **Support Aggressive Link Power Management [Enabled]**

Allows you to enable or disable the Support Aggressive Link Power (SALP) Management.

Configuration options: [Disabled] [Enabled]

## SATA Port 1/ SATA Port 2/ SATA Port 3/ SATA Port 4

### Port 1/ Port 2/ Port 3/ Port 4

Allows you to enable or disable the SATA port

Configuration options: [Disabled] [Enabled]

## PCH SATA Configuration

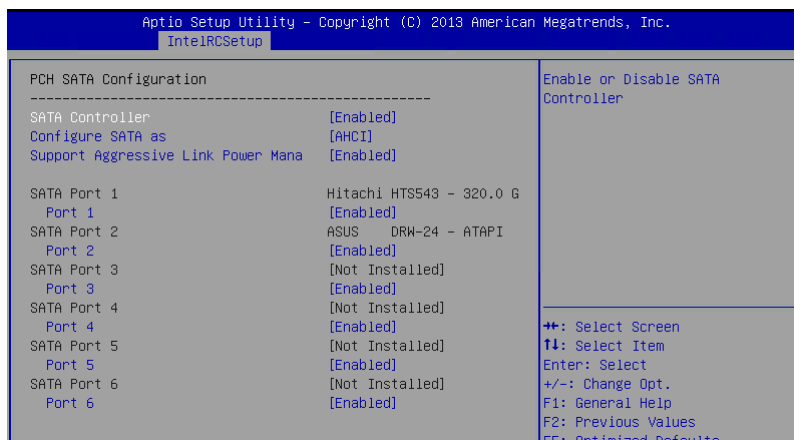

### SATA Controller [Enabled]

Allows you to enable or disable the SATA Controller.

Configuration options: [Disabled] [Enabled]

### Configure SATA as [AHCI]

Allows you to identify the SATA port is connected to Solid State Drive or Hard Disk Drive.

Configuration options: [IDE] [AHCI] [RAID]

### Support Aggressive Link Power Management [Enabled]

Allows you to enable or disable the Suport Aggressive Link Power (SALP) Management.

Configuration options: [Disabled] [Enabled]

## SATA Port 1~6

### Port 1/ Port 2/ Port 3/ Port 4/ Port 5/ Port 6 [Enabled]

Allows you to enable or disable the SATA port

Configuration options: [Disabled] [Enabled]

## USB Configuration

### xHCI Mode [Auto]

Allows you to enable or disable the mode of operation of xHCI controller.

Configuration options: [Auto] [Disabled] [Enabled]

## USB Ports Per-Port Disable Control [Disabled]

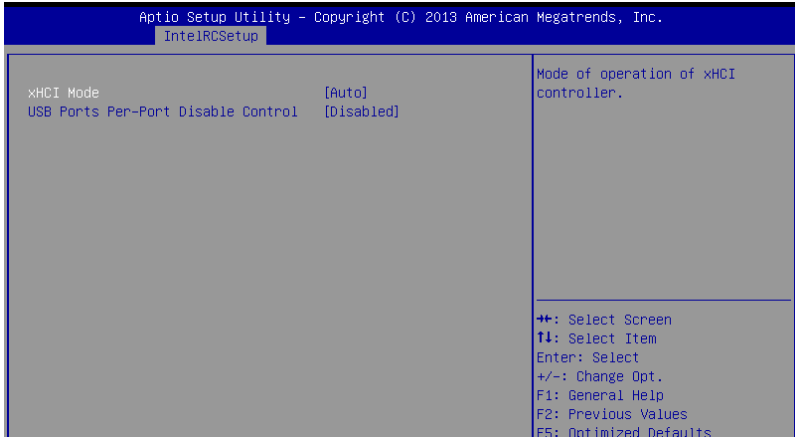

Allows you to control each of the USB ports 1 to 8 disabling.

Configuration options: [Disabled] [Enabled]



The following items appears only when the USB Ports Per-Port Disable Control is set to [Enabled].

### USB Port #1/ #2/ #3/ #4/ #5/ #6/ #7/ #8 [Enabled]

Configuration options: [Disabled] [Enabled]

### USB 3.0 Port #1/ #2/ #3/ #4 [Enabled]

Configuration options: [Disabled] [Enabled]

## Platform Thermal Configuration

### PCH Thermal Device [Auto]

Allows you to enable or disable the PCH Thermal Device (D31:F6).

Configuration options: [Auto] [Disabled] [Enabled]

### Alert Enable Lock [Disabled]

Allows you to lock all Alert Enable settings.

Configuration options: [Disabled] [Enabled]

Aptio Setup Utility - Copyright (C) 2013 American Megatrends, Inc.		
IntelRCSetup		
PCH Thermal Device	[Auto]	Enable/Disable PCH Thermal Device(D31:F6)
Alert Enable Lock	[Disabled]	

## 4.5.8 Miscellaneous Configuration

Aptio Setup Utility - Copyright (C) 2013 American Megatrends, Inc.	
IntelRCSetup	
Miscellaneous Configuration	Select active Video type
-----	
Active Video	[Offboard Device]

### Active Video [Offboard Device]

Allows you to select the video type.

Configuration options: [Onboard Device] [Offboard Device]

## 4.5.9 Server ME Configuration

Displays the Server ME Technology parameters on your system.

Aptio Setup Utility - Copyright (C) 2013 American Megatrends, Inc.	
IntelRCSetup	
General ME Configuration	
Operational Firmware Version	3.0.5.402
Recovery Firmware Version	3.0.5.402
ME Firmware Features	SiEn
ME Firmware Status #1	0x000F0382
ME Firmware Status #2	0x10408008
Current State	Recovery
Error Code	No Error

## 4.5.10 Runtime Error Logging Support



### Runtime Error Logging

#### Whea Support [Disabled]

This item allows you to enable or disable the WHEA support.

Configuration options: [Disabled] [Enabled]

## 4.6 Server Mgmt menu

The Server Management menu displays the server management status and allows you to change the settings.

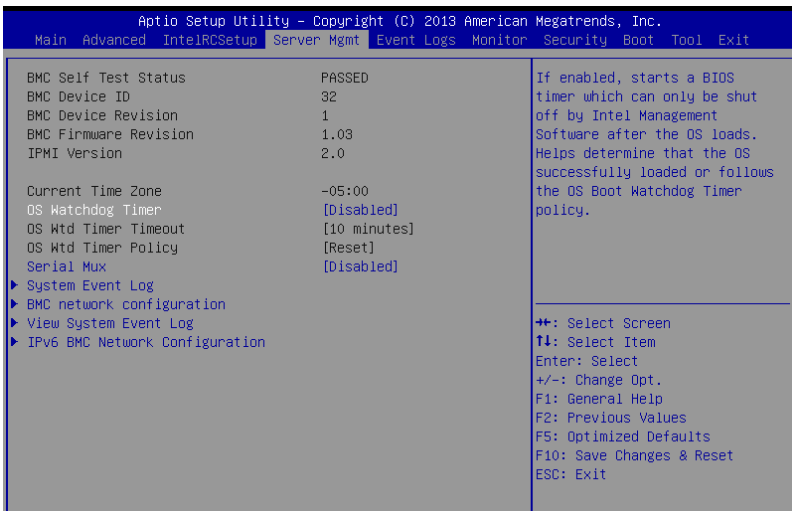

#### OS Watchdog Timer [Disabled]

This item allows you to start a BIOS timer which can only be shut off by Intel Management Software after the OS loads.

Configuration options: [Disabled] [Enabled]



The following items is configurable only when the OS Watchdog Timer is set to **[Enabled]**.

### OS Wtd Timer Timeout [10 minutes]

Allows you to configure the length fo the OS Boot Watchdog Timer.

Configuration options: [5 minutes] [10 minutes] [15 minutes] [20 minutes]

### OS Wtd Timer Policy [Reset]

This item allows you to configure the how the system should respond if the OS Boot Watch Timer expires.

Configuration options: [Do Nothing] [Reset] [Power Down]

### Serial Mux [Disabled]

This item allows you to enable or disable Serial Mux configuration.

Configuration options: [Disabled] [Enabled]

### System Event Log

Allows you to change the SEL event log configuration.

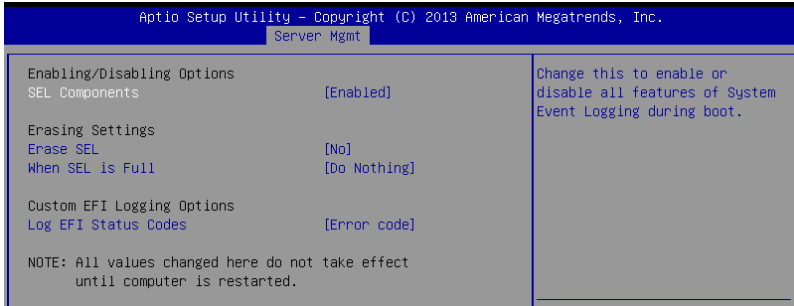

### SEL Components [Enabled]

Allows you to enable or disable all features of system Event Logging during boot.

Configuration options: [Disabled] [Enabled]



- The following items appears only when you set **SEL Components** to [Enabled].
- All values changed here do not take effect until computer is restarted.

### Erase SEL [No]

Allows you to choose options for erasing SEL.

Configuration options: [No] [Yes, On next reset] [Yes, On every reset]

### When SEL is Full [Do Nothing]

Allows you to choose options for reactions to a full SEL.

Configuration options: [Do Nothing] [Erase Immediately]

### Log EFI Status Codes [Error code]

Disable the logging of EFI Status Codes, or log only error code, or only progress code or, both.

Configuration options: [Disabled] [Both] [Error code] [Progress code]



## Bmc network configuration

The sub-items in this configuration allow you to configure the BMC network parameters.

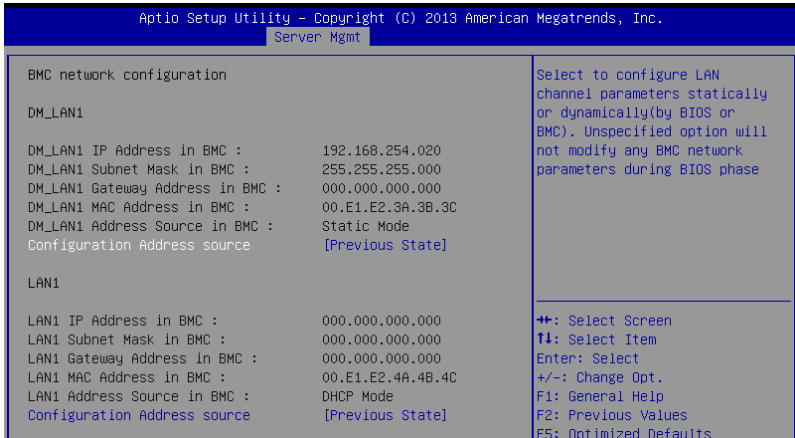

### Configuration Address source DM\_LAN1/LAN1 [Previous State]

This item allows you to configure LAN channel parameters statistically or dynamically (by BIOS or BMC). Unspecified option will not modify any BMC network parameters during BIOS phase.

Configuration options: [Previous State] [Static] [DynamicBmcDhcp]  
[DynamicBmcNonDhcp]

## View System Event Log

This item allows you to view the system event log records.

## IPv6 BMC Network Configuration

This item allows you to configure the parameter settings of IPv6 BMC network.

### IPv6 Display Full Field [Enable]

Displays the full or brief IPv6 Field.

Configuration options: [Disable] [Enable]

### IPv6 Display Full Formula [Enable]

Displays the full or brief IPv6 Formula.

Configuration options: [Disable] [Enable]

### IPv6 Display Letter Case [Upper Case]

Displays the uppercase or lowercase letters of the alphabet.

Configuration options: [Lower Case] [Upper Case]

### IPv6 BMC Lan Option [Enable]

This item allows you to enable or disable the IPv6 BMC LAN channel function. Disabling this item will not modify any BMC network during BIOS phase.

Configuration options: [Disable] [Enable]

### IPv6 BMC LAN IP Address source [Previous State]

Select to configure LAN channel parameters statically or dynamically (by BIOS or BMC).

Configuration options: [Previous State] [Static] [Dynamic-Obtained by BMC running DHCP]

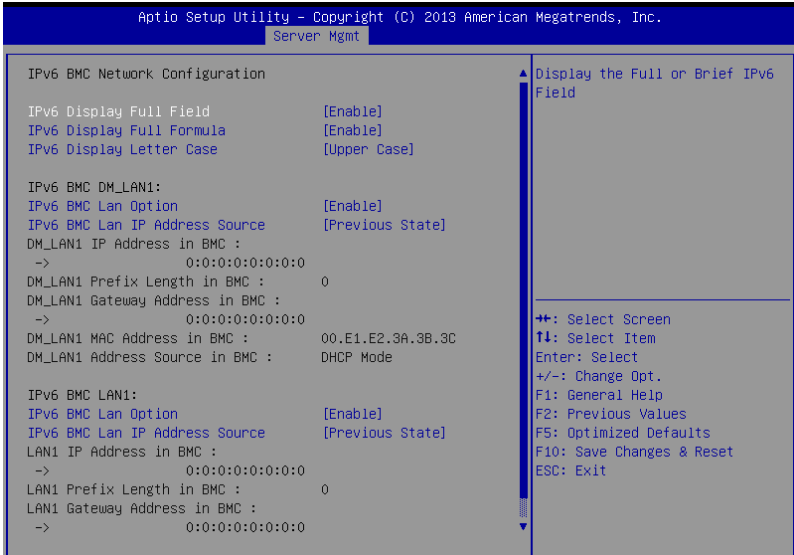

The following items appear only when you set **IP BMC Lan IP Address Source** to [Static].

#### IPv6 BMC LAN IP Address

Allows you to input IPv6 BMC Lan IP address.

#### IPv6 BMC LAN IP Prefix Length

Allows you to input IPv6 BMC Lan IP Prefix Length.

#### IPv6 BMC LAN Default Gateway

Allows you to input IPv6 BMC Lan Default Gateway.

#### IPv6 BMC LAN DNS Settings

Allows you to enter IPv6 BMC LAN DNS Settings.

#### IPv6 BMC LAN Link IP Address

Allows you to enter IPv6 BMC LAN Link IP address.

#### IPv6 BMC LAN Link IP Prefix Length

Allows you to input IPv6 BMC Lan Link IP Prefix Length.

### IPv6 BMC Lan Option [Enable]

This item allows you to enable IPv6 BMC LAN channel function. Disabling this option will not modify any BMC network during BIOS phase.



---

The following item appears only when you set **IP BMC Lan Option** to [Enable].

---

**IPv6 BMC LAN IP Address Source [Previous State]**

Select to configure LAN channel parameters statically or dynamically (by BIOS or BMC).

Configuration options: [Previous State] [Static] [Dynamic-Obtained by BMC running DHCP]



---

The following items appear only when you set **IP BMC Lan IP Address Source** to [Static].

---

**IPv6 BMC LAN IP Address**

Allows you to input IPv6 BMC Lan IP address.

**IPv6 BMC LAN IP Prefix Length**

Allows you to input IPv6 BMC Lan IP Prefix Length.

**IPv6 BMC LAN Default Gateway**

Allows you to input IPv6 BMC Lan Default Gateway.

**IPv6 BMC LAN DNS Settings**

Allows you to enter IPv6 BMC LAN DNS Settings.

**IPv6 BMC LAN Link IP Address**

Allows you to enter IPv6 BMC LAN Link IP address.

**IPv6 BMC LAN Link IP Prefix Length**

Allows you to input IPv6 BMC Lan Link IP Prefix Length.

## 4.7 Event Logs menu

The Event Logs menu items allow you to change the event log settings and view the system event logs.

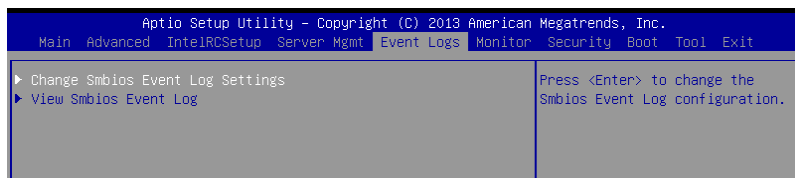

### 4.7.1 Change Smbios Event Log Settings

Press <Enter> to change the Smbios Event Log configuration.

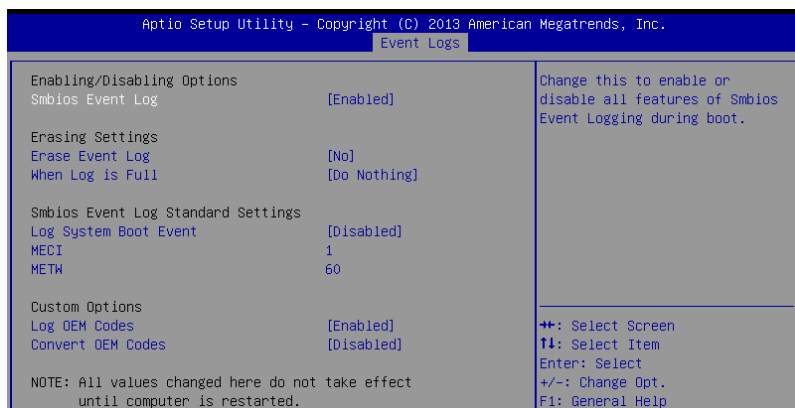

All values changed here do not take effect until computer is restarted.

#### Enabling/Disabling Options

##### Smbios Event Log [Enabled]

Change this to enable or disable all features of Smbios Event Logging during boot. Configuration options: [Disabled] [Enabled]

#### Erasing Settings

##### Erase Event Log [No]

Choose options for erasing Smbios Event Log. Erasing is done prior to any logging activation during reset. Configuration options: [No] [Yes, Next reset] [Yes, Every reset]

##### When Log is Full [Do Nothing]

Allows you to choose options for reactions to a full Smbios Event Log. Configuration options: [Do Nothing] [Erase Immediately]

## **Smbios Event Log Standard Settings**

### **Log System Boot Event [Disabled]**

Allows you to choose options to enable/disable logging of System boot event. Configuration options: [Enabled] [Disabled]

### **MECI [1]**

Multiple Event Count Increment (MECI). The number of occurrences of a duplicate event that must pass before the multiple-event counter associated with the log entry is updated, specified as a numeric value in the range 1 to 255.

### **METW [60]**

Multiple Event Time Windows (METW). The number of minutes which must pass between duplicate log entries which utilize a multiple-event counter. The value ranges from 0 to 99 minutes.

### **Custom Option**

### **Log OEM Codes [Enabled]**

Enable or disable the logging of EFI Status Codes as OEM Codes (if not already converted to legacy). Configuration options: [Disabled] [Enabled]

### **Convert OEM Codes [Disabled]**

Enable or disable the converting of EFI Status Codes to Standard Smbios Types (Not all may be translated).

Configuration options: [Disabled] [Enabled]

## **4.7.2 View Smbios Event Log**

Press <Enter> to view all smbios event logs.

## 4.8 Monitor menu

The Monitor menu displays the system temperature/power status, and allows you to change the fan settings.

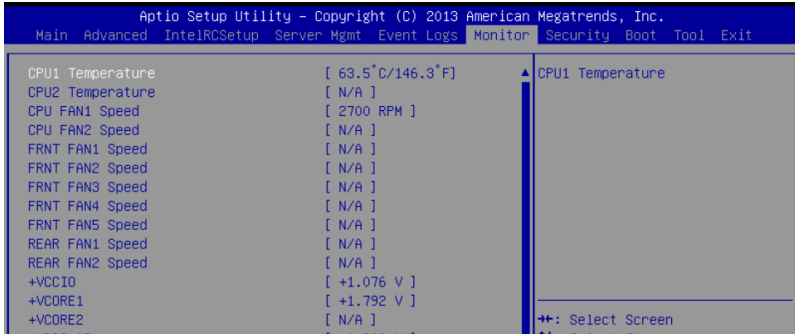

Scroll down to view the other items

### CPU1/2 Temperature [xxx°C/xxx°F]

The onboard hardware monitor automatically detects and displays the CPU temperatures.

### CPU FAN1/2 Speed; FRNT FAN1–5 Speed; REAR FAN1/2 Speed [xxxx RPM] or [N/A]

The onboard hardware monitor automatically detects and displays the speed of CPU fans, front fans, and rear fan in rotations per minute (RPM). If the fan is not connected to the motherboard, the field shows N/A.

### +VCCIO, V CORE1/2 Voltage, +VDDQ\_AB\_CPU1 Voltage, +VDDQ\_CD\_CPU1 Voltage, +VDDQ\_EF\_CPU2 Voltage, +VDDQ\_GH\_CPU2 Voltage, +5VSB Voltage, +5V Voltage, +12V Voltage, +3.3V Voltage, VBAT Voltage, +3.3VSB Voltage

The onboard hardware monitor automatically detects the voltage output through the onboard voltage regulators.

### CPU FAN1&2 FRNT FAN1 mode [Generic Mode]

Allows you to configure the ASUS Smart Fan feature that smartly adjusts the fan speeds for more efficient system operation.

Configuration options: [Generic Mode] [High Speed Mode] [Full Speed Mode] [Manual Mode]

#### Duty % [50]

This item appears only when CPU FAN1&2 FRNT FAN1 mode is set to [Manual Mode].

This item allows you to configure the fan duty setting from 10% to 100%.

### FRNT FAN2&3/4&5; REAR FAN1&2 mode [Generic Mode]

Allows you to configure the ASUS Smart Fan feature that smartly adjusts the fan speeds for more efficient system operation.

Configuration options: [Generic Mode] [High Speed Mode] [Full Speed Mode] [Manual Mode]

## 4.9 Security menu

This menu allows a new password to be created or a current password to be changed. The menu also enables or disables the Secure Boot state and lets the user configure the System Mode state.

Aptio Setup Utility - Copyright (C) 2013 American Megatrends, Inc.  
Main Advanced IntelRCSetup Server Mgmt Event Logs Monitor Security Boot Tool Exit

Password Description

If ONLY the Administrator's password is set, then this only limits access to Setup and is only asked for when entering Setup  
If ONLY the User's password is set, then this is a power on password and must be entered to boot or enter Setup. In Setup the User will have Administrator rights  
The password length must be in the following range:  
Minimum length 3  
Maximum length 20

Administrator Password  
User Password  
Clear User Password

► Secure Boot menu

To clear the administrator password, key in the current password in the Enter Current Password box, and then press <Enter> when prompted to create/confirm the password.

++: Select Screen  
!+: Select Item  
Enter: Select  
+/-: Change Opt.  
F1: General Help  
F2: Previous Values  
F5: Optimized Defaults  
F10: Save Changes & Reset  
ESC: Exit

### Administrator Password

To set an administrator password:

1. Select the Administrator Password item and press <Enter>.
2. From the Create New Password box, key in a password, then press <Enter>.
3. Confirm the password when prompted.

To change an administrator password:

1. Select the Administrator Password item and press <Enter>.
2. From the Enter Current Password box, key in the current password, then press <Enter>.
3. From the Create New Password box, key in a new password, then press <Enter>.
4. Confirm the password when prompted.



To clear the administrator password, follow the same steps as in changing an administrator password, but press <Enter> when prompted to create/confirm the password.

## User Password

To set a user password:

1. Select the User Password item and press <Enter>.
2. From the Create New Password box, key in a password, then press <Enter>.
3. Confirm the password when prompted.

To change a user password:

1. Select the User Password item and press <Enter>.
2. From the Enter Current Password box, key in the current password, then press <Enter>.
3. From the Create New Password box, key in a new password, then press <Enter>.
4. Confirm the password when prompted.

To clear a user password:

1. Select the Clear User Password item and press <Enter>.
2. Select **Yes** from the Warning message window then press <Enter>.

## Secure Boot Menu

This item allows you to customize the Secure Boot settings.



### Secure Boot [Disabled]

Secure Boot can be enabled if the system is running in User mode with enrolled platform Key (EPK) or if the CSM function is disabled.

Configuration options: [Disabled] [Enabled]

### Secure Boot Mode [Custom]

Allows you to set the Secure Boot selector.

Configuration options: [Custom] [Standard]



## Key Management

This item only appears when the item Secure Boot Mode is set to [Custom]. The Key Management item allows you to modify Secure Boot variables and set Key Management page.

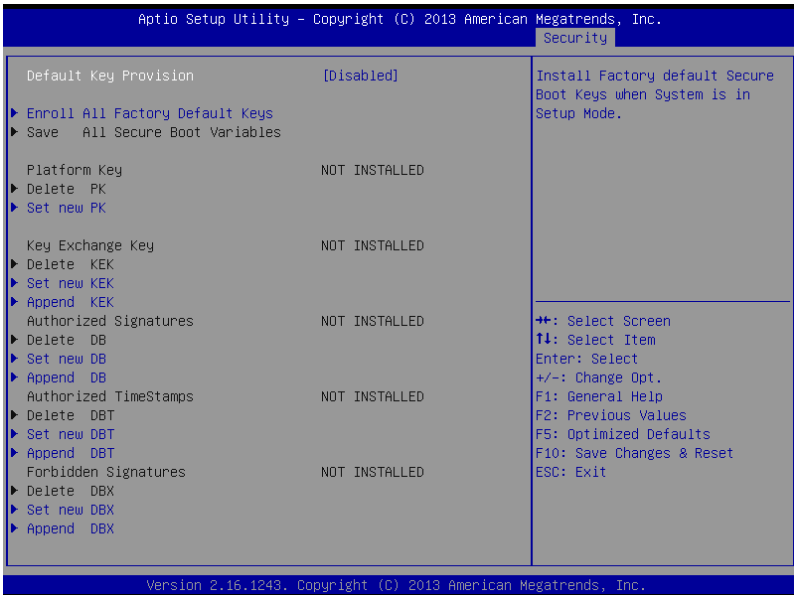

### Default Key Provision [Disabled]

Configuration options: [Disabled] [Enabled]

### Enroll All Factory Default Keys

This item will ask you if you want to Install Factory Default secure keys. Select Yes if you want to load the default secure keys, otherwise select No.

### Save All Secure Boot Variables

This item will ask you if you want to save all secure boot variables. Select Yes if you want to save all secure boot variables, otherwise select No.

### Platform Key (PK)/ Key Exchange Key (KEK)/ Authorized Signatures (DB)/ Authorized TimeStamps (DBT)/ Forbidden Signatures (DBX)

Configuration options: [Delete] [Set New] [Append]

## 4.10 Boot menu

The Boot menu items allow you to change the system boot options.

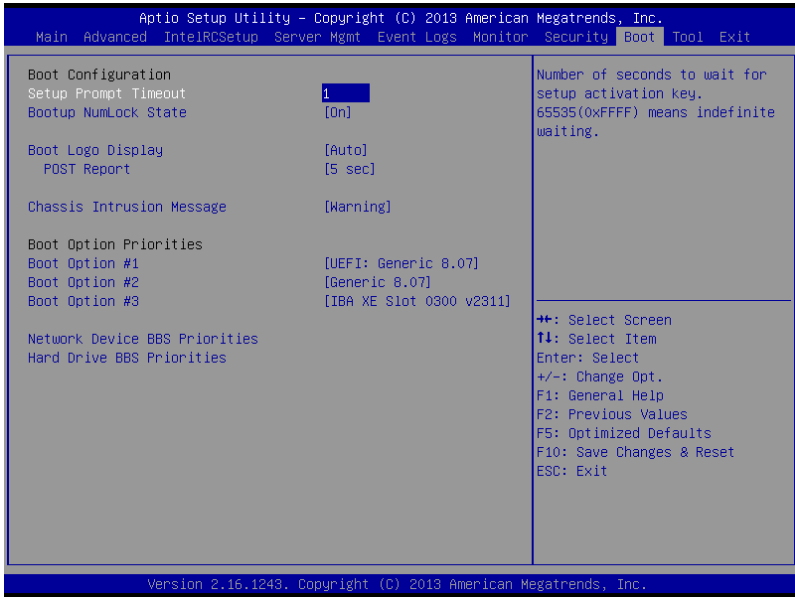

### Setup Prompt Timeout [xx]

Use the <+> and <-> keys to adjust the number of seconds to wait for setup activation key.

### Bootup NumLock State [On]

Allows you to select the power-on state for the NumLock.

Configuration options: [Off] [On]

### Boot Logo Display [Auto]

Allows you to enable or disable the full screen logo display feature.

Configuration options: [Auto] [Full Screen] [Disabled]

### POST Report [5 sec]

Allows you to set the desired POST Report waiting time from 1 to 10 seconds.

Configuration options: [1 sec] ~ [10 sec] [Until Press ESC]

### Chassis Intrusion [Warning]

Allows you to set an action when chassis intrusion has occurred.

Configuration options: [Warning] [Halt]

### Boot Option Priorities

These items specify the boot device priority sequence from the available devices. The number of device items that appears on the screen depends on the number of devices installed in the system.



- To select the boot device during system startup, press <F8> when ASUS Logo appears.
- To access Windows OS in Safe Mode, please press <F8> after POST.

### Set the booting order of network devices.

#### Boot Option #1/#2 [SATA P2: ASUS ...]

Configuration options: [SATA P2: ASUS ...] [SATA P3: WDC WD80...]  
[AMI Virtual Floppy...] [IBA GE Slot 0700 v...]

#### CD/DVD ROM Drive BBS Priorities

### Hard Drive BBS Priorities / Network Device BBS Priorities

These items appear only when you connect SATA ODD or hard drive to the SATA ports and allow you to set the booting order of the SATA devices.

## 4.11 Tool menu

The Tool menu items allow you to configure options for special functions. Select an item then press <Enter> to display the submenu.

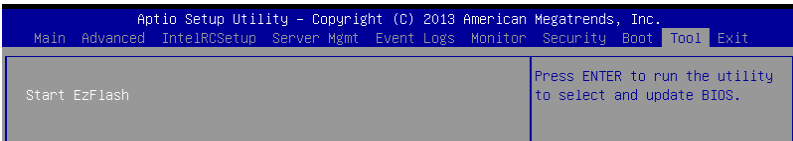

### ASUS EZ Flash

Allows you to run ASUS EZ Flash BIOS ROM Utility when you press <Enter>. Refer to the ASUS EZ Flash Utility section for details.

## 4.12 Exit menu

The Exit menu items allow you to save or discard your changes to the BIOS items.

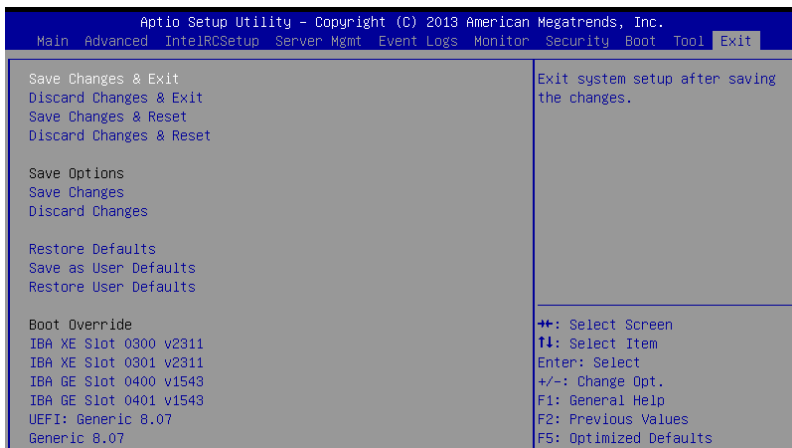

Pressing <Esc> does not immediately exit this menu. Select one of the options from this menu or <F10> from the legend bar to exit.

### Save Changes & Reset

Exit System setup after saving the changes.

### Discard Changes & Exit

Exit System setup without saving any changes.

### Save Changes & Reset

Reset the system setup after saving the changes.

### Discard Changes & Reset

Reset system setup without saving any changes.

### Save Options

### Save Changes

Save changes done so far to any of the setup options.

### Discard Changes

Discard changes done so far to any of the setup options.

### **Restore Defaults**

Restore/load default values for all the setup options.

### **Save as User Defaults**

Save the changes done so far as User Defaults.

### **Restore User Defaults**

Restore the User Defaults to all the setup options.

### **Boot Override**

These items displays the available devices. The device items that appears on the screen depends on the number of devices installed in the system. Click an item to start booting from the selected device.

### **Launch EFI Shell from filesystem device**

Attempts to launch EFI Shell application (shellx64.efi) from one of the available filesystem devices.



# RAID Configuration

# 5

This chapter provides instructions for setting up, creating, and configuring RAID sets using the available utilities.

## 5.1 Setting up RAID

The motherboard supports the following SATA RAID solutions:

- **LSI MegaRAID software RAID Configuration Utility** with RAID 0, RAID 1, and RAID 10 support (for both Linux and Windows OS).
- **Intel® Rapid Storage Technology enterprise Option ROM Utility** with RAID 0, RAID 1, RAID 10, and RAID 5 support (for Windows OS only).

### 5.1.1 RAID definitions

**RAID 0** (*Data striping*) optimizes two identical hard disk drives to read and write data in parallel, interleaved stacks. Two hard disks perform the same work as a single drive but at a sustained data transfer rate, double that of a single disk alone, thus improving data access and storage. Use of two new identical hard disk drives is required for this setup.

**RAID 1** (*Data mirroring*) copies and maintains an identical image of data from one drive to a second drive. If one drive fails, the disk array management software directs all applications to the surviving drive as it contains a complete copy of the data in the other drive. This RAID configuration provides data protection and increases fault tolerance to the entire system. Use two new drives or use an existing drive and a new drive for this setup. The new drive must be of the same size or larger than the existing drive.

**RAID 10** is data striping and data mirroring combined without parity (redundancy data) having to be calculated and written. With the RAID 10 configuration you get all the benefits of both RAID 0 and RAID 1 configurations. Use four new hard disk drives or use an existing drive and three new drives for this setup.

**RAID 5** stripes both data and parity information across three or more hard disk drives. Among the advantages of RAID 5 configuration include better HDD performance, fault tolerance, and higher storage capacity. The RAID 5 configuration is best suited for transaction processing, relational database applications, enterprise resource planning, and other business systems. Use a minimum of three identical hard disk drives for this setup.



- 
- If you want to boot the system from a hard disk drive included in a created RAID set, copy first the RAID driver from the support DVD to a floppy disk before you install an operating system to the selected hard disk drive.
  - Please refer to chapter 2 for how to select the RAID configuration utility. Move the jumper to choose between LSI MegaRAID and Intel® Rapid RAID.
-



## 5.1.2 Installing hard disk drives

The motherboard supports Serial ATA for RAID set configuration. For optimal performance, install identical drives of the same model and capacity when creating a disk array.

To install the SATA hard disks for RAID configuration:

1. Install the SATA hard disks into the drive bays following the instructions in the system user guide.
2. Connect a SATA signal cable to the signal connector at the back of each drive and to the SATA connector on the motherboard.
3. Connect a SATA power cable to the power connector on each drive.

## 5.1.3 Setting the RAID item in BIOS

You must set the RAID item in the BIOS Setup before you can create a RAID set from SATA hard disk drives attached to the SATA connectors supported by Intel® C612 chipset.

To do this:

1. Enter the BIOS Setup during POST.
2. Go to the **Advanced Menu > PCH SATA Configuration**, then press <Enter>.
3. Set **SATA Mode** to [RAID Mode]
4. Press <F10> to save your changes and exit the BIOS Setup.



---

Refer to Chapter 4 for details on entering and navigating through the BIOS Setup.

---

## 5.1.4 RAID configuration utilities

Depending on the RAID connectors that you use, you can create a RAID set using the utilities embedded in each RAID controller. For example, use the **LSI MegaRAID Software Configuration Utility** or the **Intel® Rapid Storage Technology** if you installed Serial ATA hard disk drives on the Serial ATA connectors supported by the Intel® C612 chipset.

Refer to the succeeding section for details on how to use the RAID configuration utility.

## 5.2 LSI Software RAID Configuration Utility (Z10PA-D8 only)

The LSI MegaRAID software RAID configuration utility allows you to create RAID 0, RAID 1, or RAID 10 set(s) from SATA hard disk drives connected to the SATA connectors supported by the motherboard southbridge chip.

To enter the LSI MegaRAID software RAID configuration utility:

1. Turn on the system after installing all the SATA hard disk drives.
2. During POST, the LSI MegaRAID software RAID configuration utility automatically detects the installed SATA hard disk drives and displays any existing RAID set(s). Press <Ctrl> + <M> to enter the utility.

```
LSI MegaRAID Software RAID BIOS Version A.10 09231523R
LSI SATA RAID Found at PCI Bus No:00 Dev No:1F
Device present at Port 0      ST3160812AS      152114MB
Device present at Port 1      ST3160812AS      152114MB
Device present at Port 2      ST3160812AS      152114MB
Device present at Port 3      ST3160812AS      152114MB
Press Ctrl-M or Enter to run LSI Software RAID Setup Utility.
```



- The LSI MegaRAID software RAID configuration utility automatically configures to RAID 1 when the SATA to RAID Mode is enabled.
- The RAID setup screens shown in this section are for reference only and may not exactly match the items on your screen due to the controller version difference.
- When you create RAID sets with the LSI MegaRAID software RAID configuration utility, the boot priority of the SATA optical drive has to be manually adjusted. Otherwise, the system will not boot from the connected SATA ODD.

3. The utility main window appears. Use the arrow keys to select an option from the **Management Menu** and then press <Enter>. Refer to the Management Menu descriptions on the next page.

At the bottom of the screen is the legend box. The keys on the legend box allow you to navigate through the setup menu options or execute commands. The keys on the legend box vary according to the menu level.

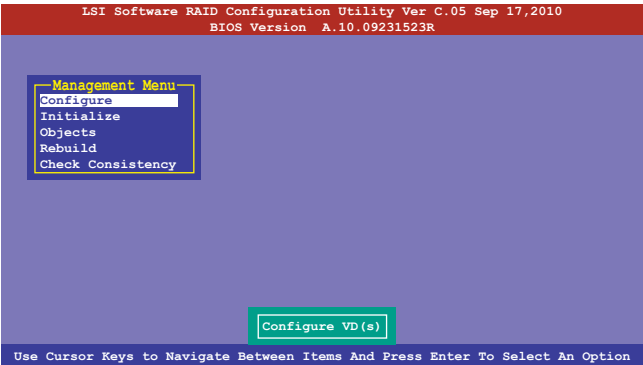

Menu	Description
<b>Configure</b>	Allows you to create RAID 0, RAID 1 or RAID 10 set using the Easy Configuration or the New Configuration command. This menu also allows you to view, add, or clear RAID configurations or select the boot drive
<b>Initialize</b>	Allows you to initialize the virtual drives of a created RAID set
<b>Objects</b>	Allows you to initialize virtual drives or change the virtual drive parameters
<b>Rebuild</b>	Allows you to rebuild failed drives
<b>Check Consistency</b>	Allows you to check the data consistency of the virtual drives of a created RAID set

## 5.2.1 Creating a RAID set

The LSI Software RAID Configuration Utility allows you to create a RAID 0, RAID 1, or RAID 10 set using two types of configurations: **Easy** and **New**.

In **Easy Configuration**, the virtual drive parameters are set automatically.

In **New Configuration**, you manually set the virtual drive parameters.

### Using Easy Configuration

To create a RAID set using the **Easy Configuration** option:

1. From the **Management Menu**, select **Configure > Easy Configuration**, and then press <Enter>.

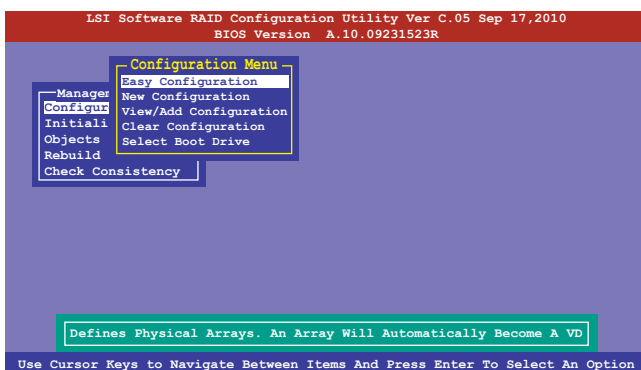

- The **ARRAY SELECTION MENU** displays the available drives connected to the SATA ports. Use the up/down arrow keys to select the drives you want to include in the RAID set, and then press <Space>. When selected, the drive indicator changes from **READY** to **ONLIN A[X]-[Y]**, where X is the array number, and Y is the drive number.

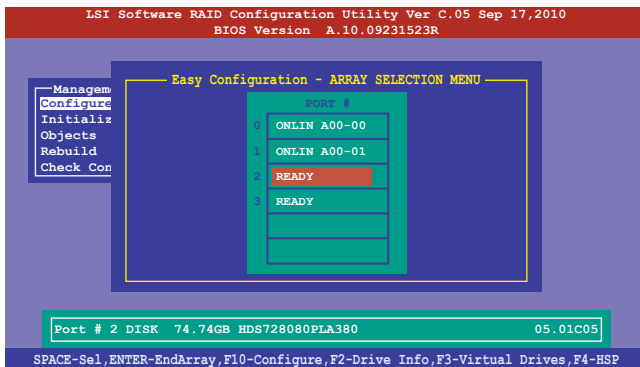

- The information of the selected hard disk drive displays at the bottom of the screen.
- You need at least two identical hard disk drives when creating a RAID 1 set.
- You need at least four identical hard disk drives when creating a RAID 10 set.

- Select all the drives required for the RAID set, and then press <F10> to configure array setting.
- Press <Space> to select the configurable array.

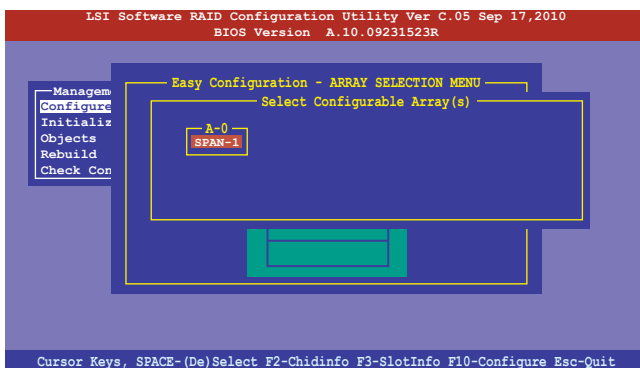

- Press <F10> again, the virtual drive information appears including a **Virtual Drive** menu that allows you to change the virtual drive parameters.

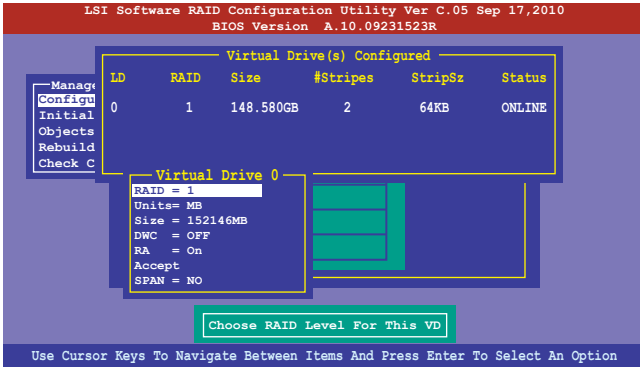

- Select **RAID** from the **Virtual Drive** sub-menu, and then press <Enter>.
- Select the **RAID level** from the menu, and then press <Enter>.

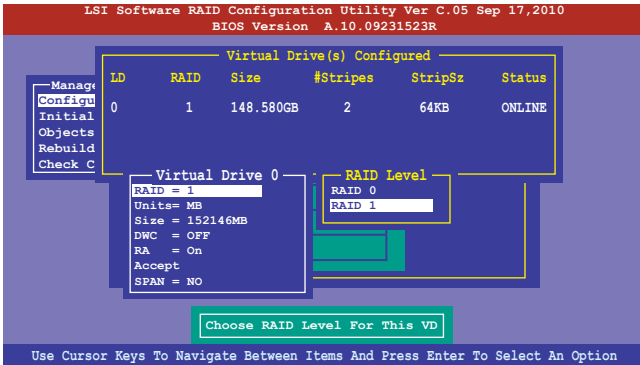

8. Select **Units** from the **Virtual Drive** sub-menu, and then press <Enter>.
9. Select the units for virtual drive size from the menu, and then press <Enter>.

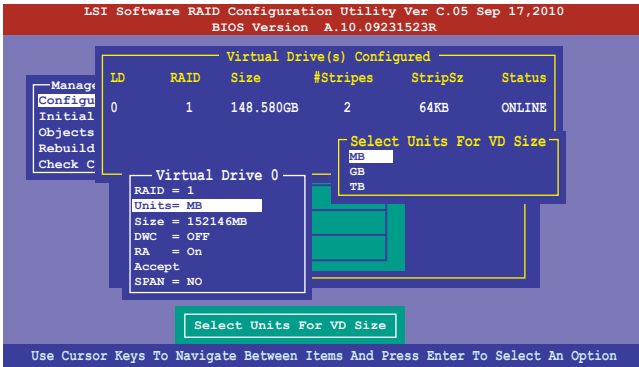

10. When creating a **RAID 1** or a **RAID 10** set, select **DWC** from the **Virtual Drive** menu, and then press <Enter>.

When creating a **RAID 0** set, proceed to step 12.

11. Select **On** to enable the **Disk Write Cache** setting, and then press <Enter>.

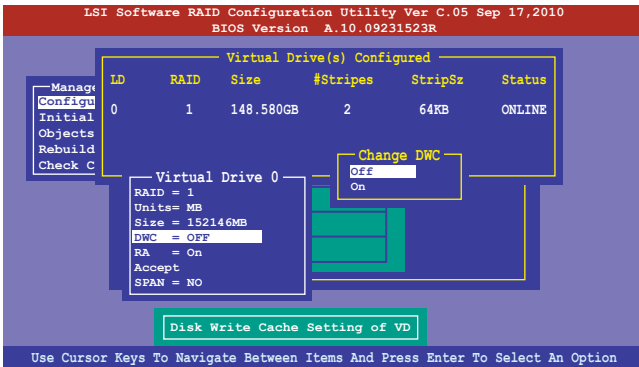

Enabling DWC can improve the performance, but with the risk of data loss.

12. When finished setting the selected virtual drive configuration, select **Accept** from the menu, and then press <Enter>.

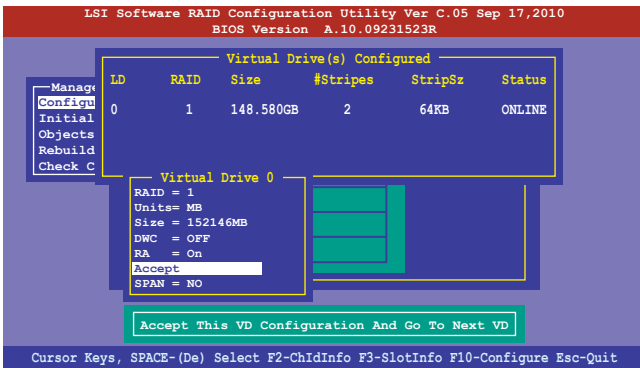

13. Follow step 2 to 12 to configure additional virtual drives.
14. Press <Esc> to finish RAID configuration. When prompted to save configuration, select **Yes** from the menu, and then press <Enter>.

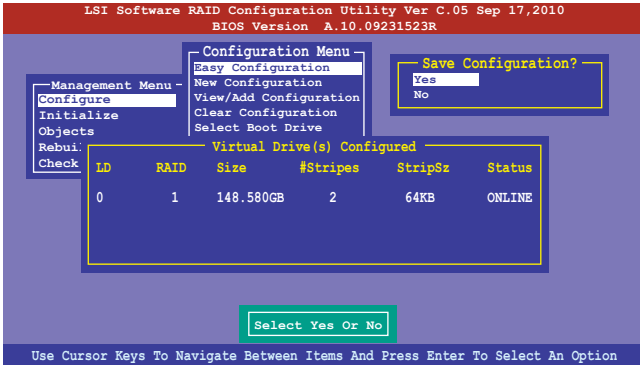

## Using New Configuration



When a RAID set already exists, using the **New Configuration** command erases the existing RAID configuration data. If you do not want to delete the existing RAID set, use the **View/Add Configuration** command to view or create another RAID configuration.

To create a RAID set using the **New Configuration** option

1. From the **Management Menu**, select **Configure > New Configuration**, and then press <Enter>.

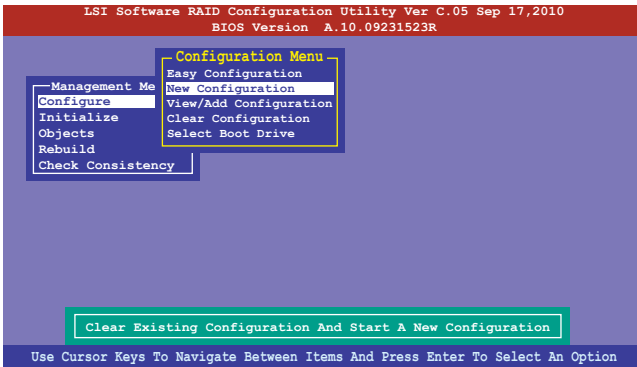

2. Follow step 2 to 9 of the previous section: **Using Easy Configuration**.
3. Select **Size** from the **Virtual Drive** menu, and then press <Enter>.
4. Key-in the desired virtual drive size, and then press <Enter>.

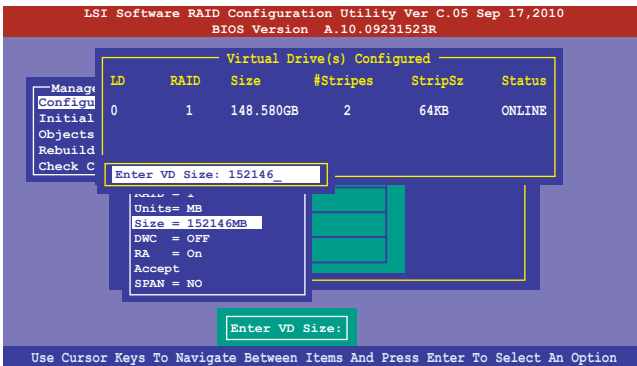

5. Follow step 10 to 14 of the previous section: **Using Easy Configuration** to create the RAID set.



## 5.2.2 Adding or viewing a RAID configuration

You can add a new RAID configuration or view an existing configuration using the **View/Add Configuration** command.

### Adding a new RAID configuration

To add a new RAID configuration:

1. From the **Management Menu**, select **Configure > View/Add Configuration**, and then press <Enter>.

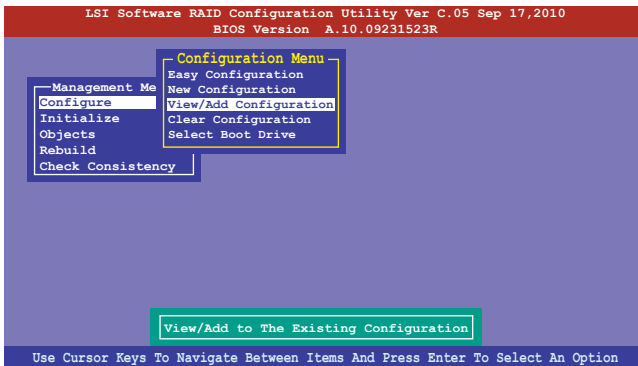

2. The **ARRAY SELECTION MENU** displays the available drives connected to the SATA ports. Select the drive(s) you want to include in the RAID set, then press <Space>. When selected, the drive indicator changes from **READY** to **ONLIN A[X]-[Y]**, where X is the array number, and Y is the drive number.

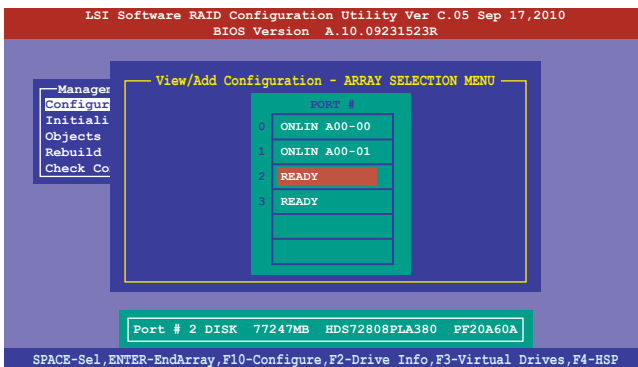

The information of the selected hard disk drive displays at the bottom of the screen.

3. Follow step 3 to 12 of section 6.2.1 **Creating a RAID set: Using Easy Configuration** to add a new RAID set.

## 5.2.3 Initializing the virtual drives

After creating the RAID set(s), you must initialize the virtual drives. You may initialize the virtual drives of a RAID set(s) using the **Initialize** or **Objects** command on the **Management Menu**.

### Using the Initialize command

To initialize the virtual drive using the Initialize command

1. From the **Management Menu**, select **Initialize**, and then press <Enter>.

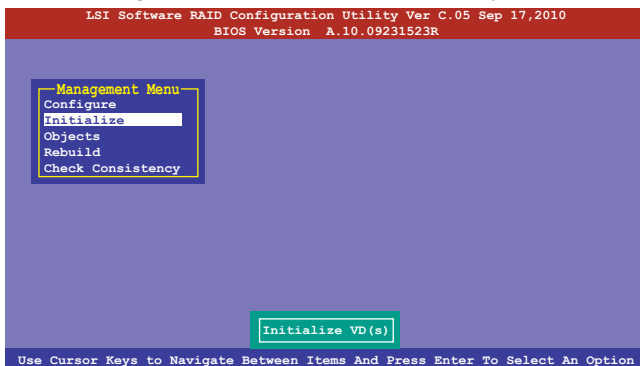

2. The screen displays the available RAID set(s) and prompts you to select the virtual drive to initialize. Use the arrow keys to select the virtual drive from the **Virtual Drive** selection, and then press <Space>.

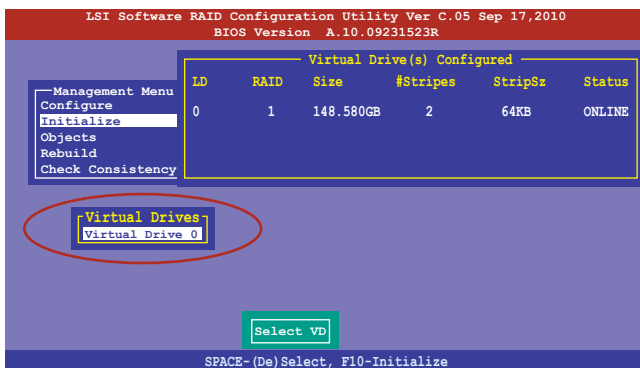

- Press <F10> to start initialization. When prompted, select **Yes** from the **Initialize?** dialog box, and then press <Enter>.

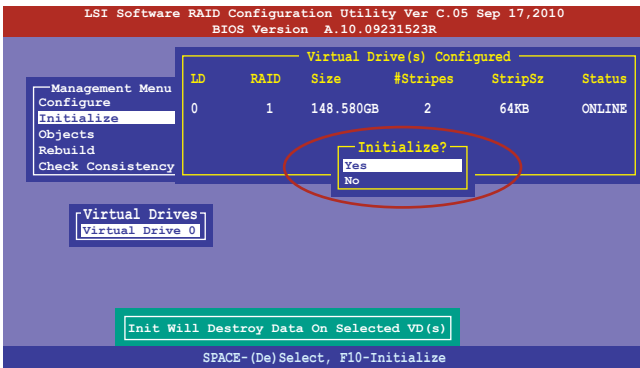

Initializing a virtual drive erases all data on the drive.

- A progress bar appears on screen. If desired, press <Esc> to abort initialization. When initialization is completed, press <Esc>.

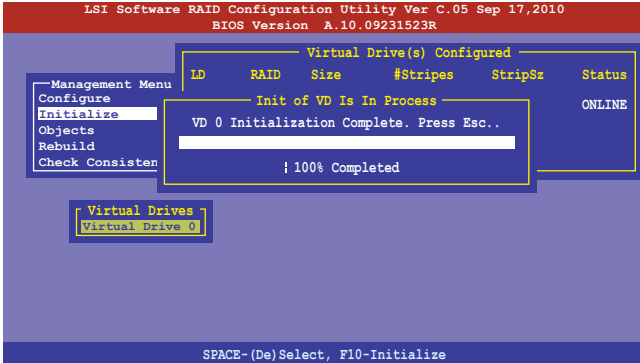

## Using the Objects command

To initialize the virtual drives using the **Objects** command

1. From the **Management Menu**, select **Objects > Virtual Drive**, and then press <Enter>.

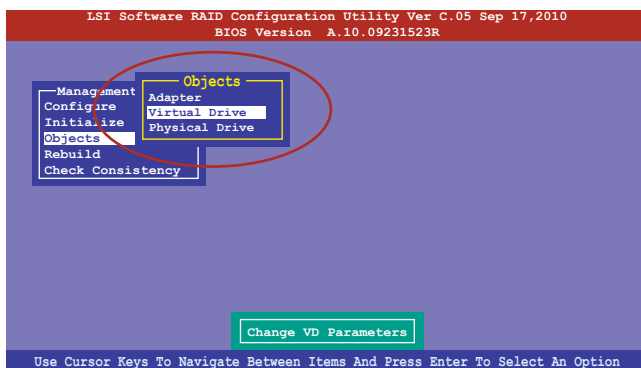

2. Select the virtual drive to initialize from the **Virtual Drives** sub-menu, and then press <Enter>.

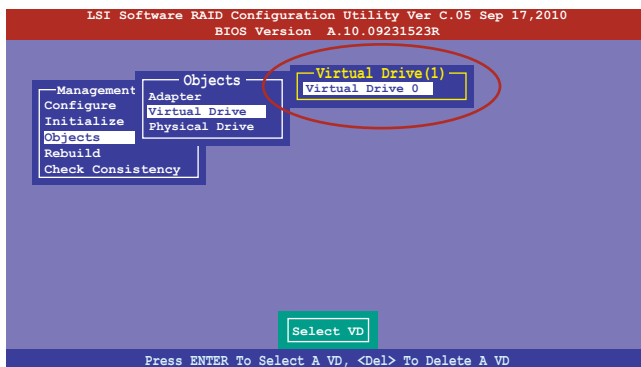

3. Select **Initialize** from the pop-up menu, and then press <Enter> to start initialization.

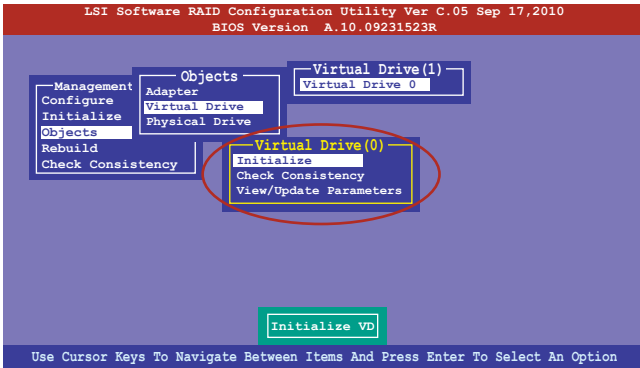

4. When prompted, press the <Space> to select **Yes** from the **Initialize?** dialog box, and then press <Enter>.

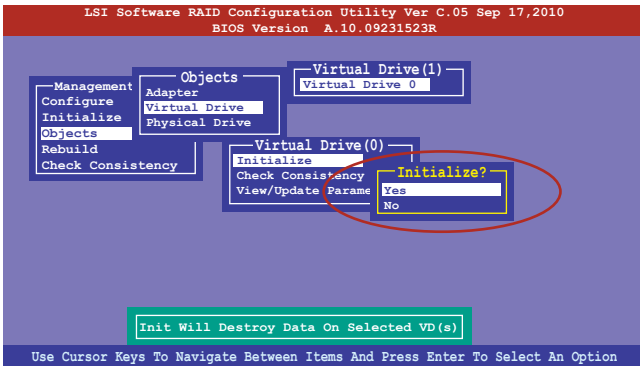

5. A progress bar appears on screen. If desired, press <Esc> to abort initialization. When initialization is completed, press <Esc>.

## 5.2.4 Rebuilding failed drives

You can manually rebuild failed hard disk drives using the **Rebuild** command in the **Management Menu**.

To rebuild a failed hard disk drive

1. From the **Management Menu**, select **Rebuild**, and then press <Enter>.

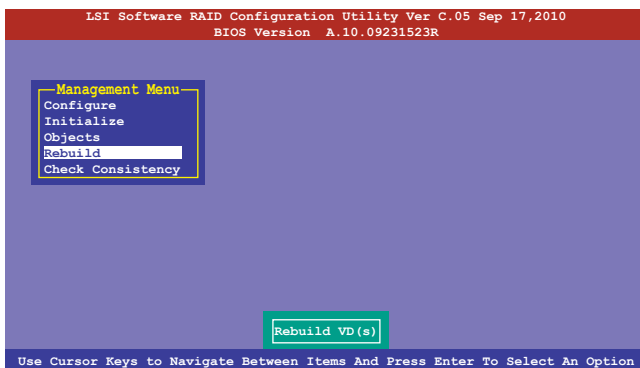

2. The **PHYSICAL DRIVES SELECTION MENU** displays the available drives connected to the SATA ports. Select the drive you want to rebuild, and then press <Space>.

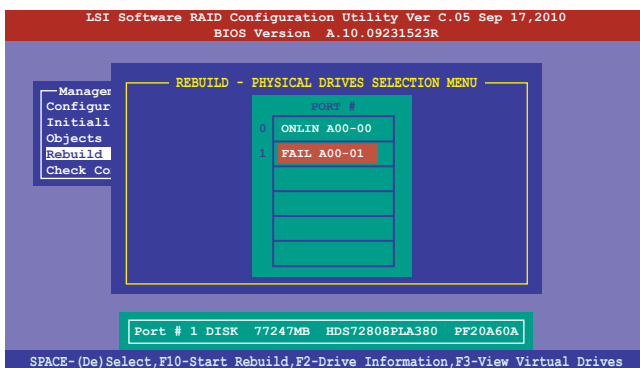

3. After selecting the drive to rebuild, press <F10>. When prompted, press <Y> to rebuild the drive.

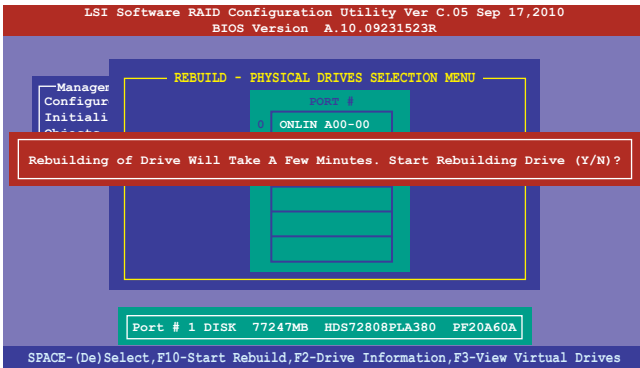

4. When rebuild is complete, press any key to continue.

## 5.2.5 Checking the drives for data consistency

You can check and verify the accuracy of data redundancy in the selected virtual drive. The utility can automatically detect and/or detect and correct any differences in data redundancy depending on the selected option in the **Objects > Adapter** menu.



The **Check Consistency** command is available only for virtual drives included in a RAID 1 or RAID 10 set.

### Using the Check Consistency Command

To check data consistency using the **Check Consistency** command

1. From the **Management Menu**, select **Check Consistency**, and then press <Enter>.

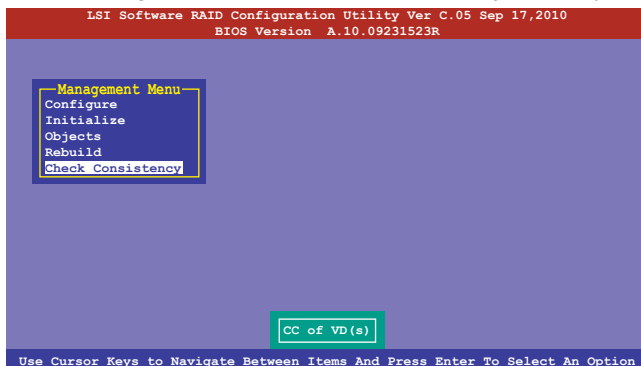

2. The screen displays the available RAID set(s) and prompts you to select the virtual drive to check. Press <Space> to select the virtual drive from the **Virtual Drive** sub-menu, and then press <F10>.

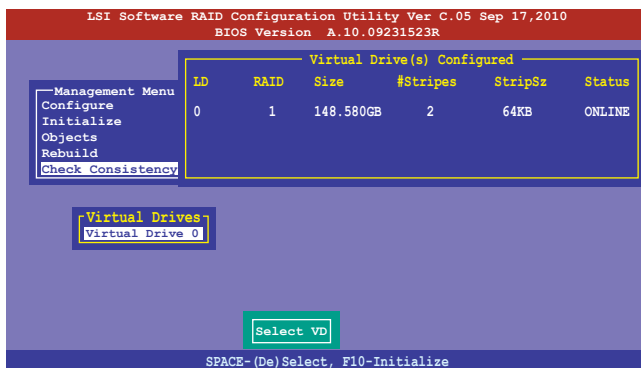



- When prompted, use the arrow keys to select **Yes** from the **Consistency Check?** dialog box, and then press <Enter>.

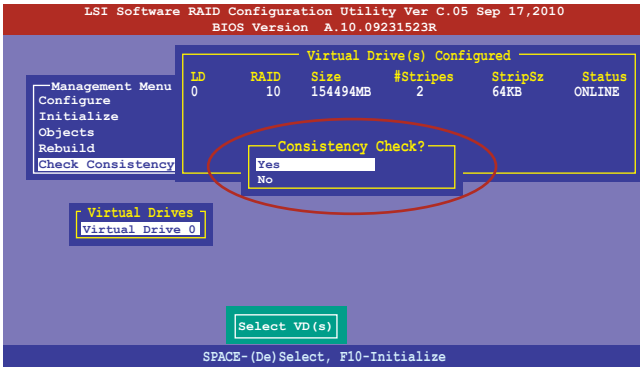

A progress bar appears on screen.

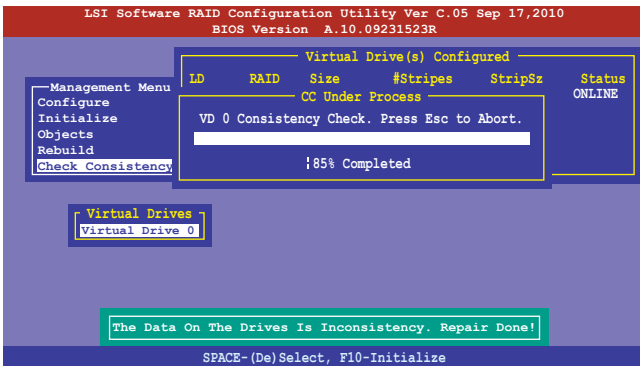

- While checking the disk consistency, press <Esc> to display the following options.
  - Stop** - Stops the consistency check. The utility stores the percentage of disk checked, and when you restart checking, it continues from the last percentage completed rather than from zero percent.
  - Continue** - Continues the consistency check.
  - Abort** - Aborts the consistency check. When you restart checking, it continues from zero percent.
- When checking is complete, press any key to continue.

## Using the Objects command

To check data consistency using the **Objects** command

1. From the **Management Menu**, select **Objects**, and then select **Virtual Drive** from the sub-menu.
2. Use the arrow keys to select the virtual drive you want to check, and then press <Enter>.
3. Select **Check Consistency** from the pop-up menu, and then press <Enter>.
4. When prompted, use the arrow keys to select **Yes** from the dialog box to check the drive.
5. When checking is complete, press any key to continue.

## 5.2.6 Deleting a RAID configuration

To delete a RAID configuration

1. From the **Management Menu**, select **Configure > Clear Configuration**, and then press <Enter>.

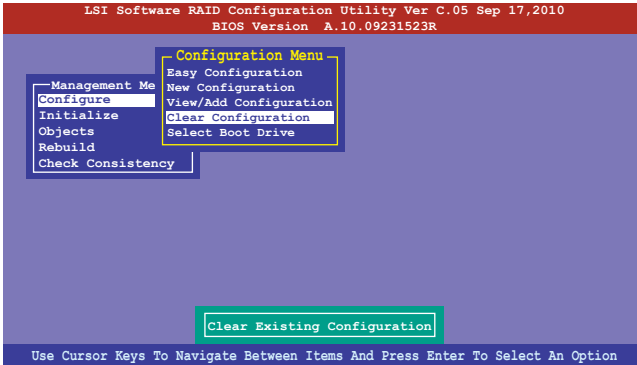

2. When prompted, use the arrow keys to select **Yes** from the **Clear Configuration?** dialog box, and then press <Enter>.

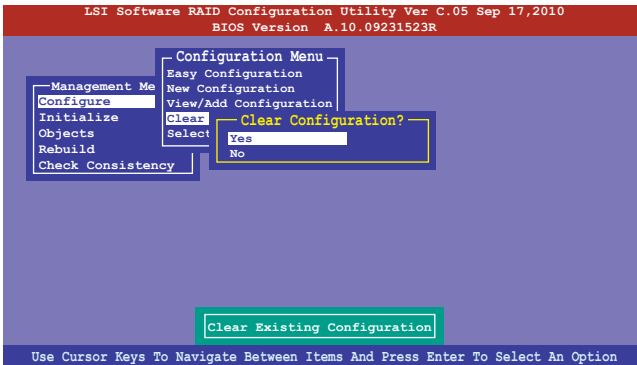

The utility clears all the current array(s).

3. Press any key to continue.

## 5.2.7 Selecting the boot drive from a RAID set

You must have created a new RAID configuration before you can select the boot drive from a RAID set. See section 6.2.1 **Creating a RAID set: Using New Configuration** for details.

To select the boot drive from a RAID set

1. From the **Management Menu**, select **Configure > Select Boot Drive**, and then press <Enter>.

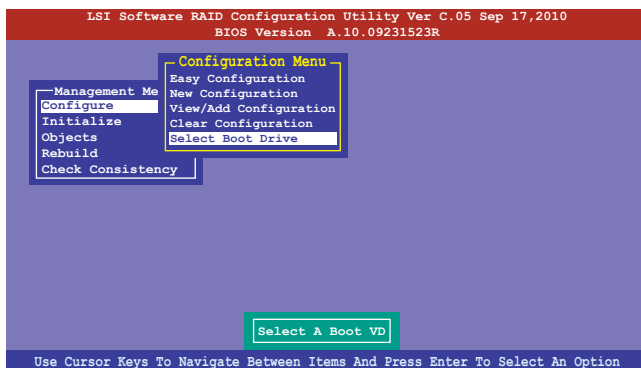

2. When prompted, use the arrow keys to select the bootable virtual drive from the list, then press <Enter>.

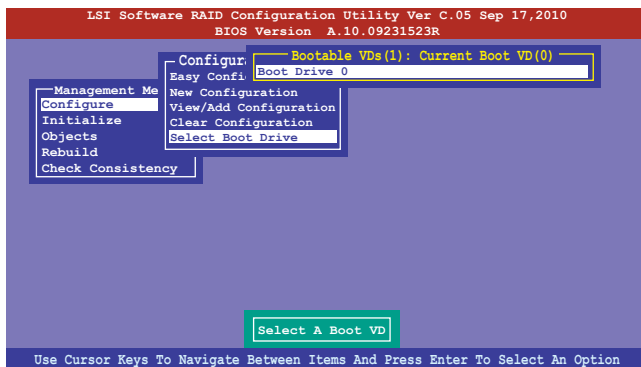

3. The virtual drive is selected as boot drive. Press any key to continue.

## 5.2.8 Enabling WriteCache

You may manually enable the RAID controller's WriteCache option after creating a RAID set to improve the data transmission performance.



When you enable WriteCache, you may lose data when a power interruption occurs while transmitting or exchanging data among the drives.

The WriteCache function is recommended for RAID 1 and RAID 10 sets.

To enable WriteCache

1. From the **Management Menu**, select **Objects > Adapter**, select an existing adapter, and then press <Enter> to display the adapter properties.

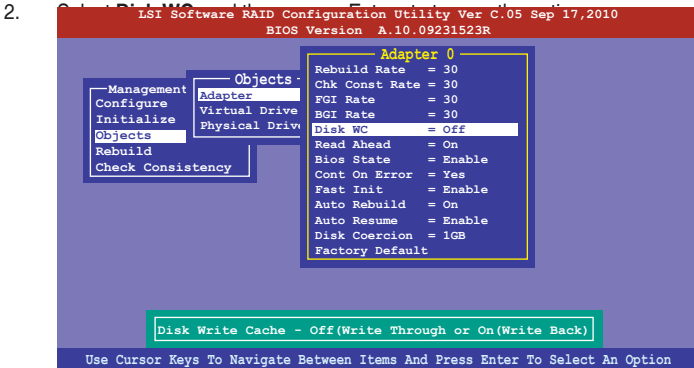

3. From the **Management Menu**, select **Objects > Virtual Drive**, select an existing adapter and press <Enter>. Select **View/Update Parameters** and press <Enter> to display the adapter properties.
4. Select **Disk WC**, and then press <Enter> to turn on the option.

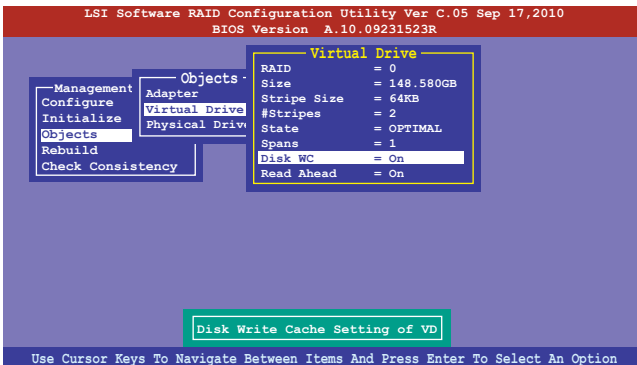

5. When finished, press any key to continue.

## 5.3 Intel® Rapid Storage Technology enterprise SATA/SSATA Option ROM Utility

The Intel® Rapid Storage Technology enterprise SATA/SSATA Option ROM utility allows you to create RAID 0, RAID 1, RAID 10 (RAID 1+0), and RAID 5 set from Serial ATA hard disk drives that are connected to the Serial ATA connectors supported by the Southbridge.



Before you proceed, ensure that you have installed the Serial ATA hard disk drives, have set the correct jumper settings of the motherboard, and have set the correct SATA mode in the BIOS setup. You can refer to the **Installing hard disk drives**, **Setting Jumpers**, and **Setting the RAID mode sections in BIOS** for more information.

To launch the Intel® Rapid Storage Technology enterprise SATA/SSATA Option ROM utility:

1. Turn on the system.
2. During POST, press <Ctrl>+<I> to display the utility main menu.

```
Intel(R) Rapid Storage Technology enterprise - SATA Option ROM - 3.6.0.1023
Copyright(C) 2003-12 Intel Corporation. All Rights Reserved.

----- [ MAIN MENU ] -----
  1. Create RAID Volume          3. Reset Disks to Non-RAID
  2. Delete RAID Volume        4. Exit

----- [ DISK/VOLUME INFORMATION ] -----

RAID Volumes:
None defined.

Physical Disks:
ID  Drive Model      Serial #              Size   Type/Status (Vol ID)
0   ST3300656SS      HWS0000991753TR     279.3GB Non-RAID Disk
1   ST3300656SS      37VN00009846RAJ1    279.3GB Non-RAID Disk
2   ST3300656SS      397600009846UEDY    279.3GB Non-RAID Disk
3   ST3300656SS      GWC50000991756G6    279.3GB Non-RAID Disk

[↑↓]-Select      [ESC]-Exit      [ENTER]-Select Menu
```

The navigation keys at the bottom of the screen allow you to move through the menus and select the menu options.



The RAID BIOS setup screens shown in this section are for reference only and may not exactly match the items on your screen.

### 5.3.1 Creating a RAID set

To create a RAID set:

1. From the utility main menu, select **1. Create RAID Volume** and press <Enter>.
2. Key in a name for the RAID set and press <Enter>.

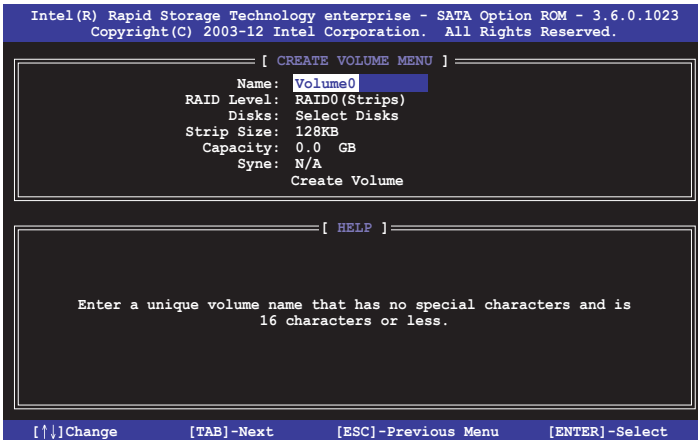

3. Press the up/down arrow keys to select a RAID Level that you wish to create then press <Enter>.
4. From the **Disks** item field, press <Enter> to select the hard disk drives that you want to include in the RAID set.

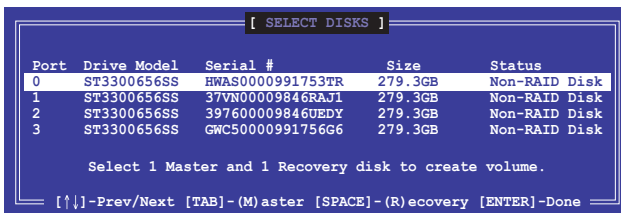

5. Use the up/down arrow keys to move the selection bar then press <Space> to select a disk. A small triangle before the Port number marks the selected drive. Press <Enter> when you are done.

- Use the up/down arrow keys to select the stripe size for the RAID array (for RAID 0, 10 and 5 only) then press <Enter>. The available stripe size values range from 4 KB to 128 KB. The following are typical values:  
RAID 0: 128KB  
RAID 10: 64KB  
RAID 5: 64KB



---

We recommend a lower stripe size for server systems, and a higher stripe size for multimedia computer systems used mainly for audio and video editing.

---

- In the **Capacity** field item, key in the RAID volume capacity that you want to use and press <Enter>. The default value field indicates the maximum allowed capacity.
- Press <Enter> to start creating the RAID volume.
- From the following warning message, press <Y> to create the RAID volume and return to the main menu, or press <N> to go back to the **CREATE VOLUME** menu.

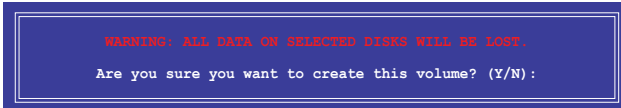



## 5.3.2 Deleting a RAID set



Take caution when deleting a RAID set. You will lose all data on the hard disk drives when you delete a RAID set.

To delete a RAID set:

1. From the utility main menu, select **2. Delete RAID Volume** and press <Enter>.
2. From the Delete Volume Menu, press the up/down arrow keys to select the RAID set you want to delete then press <Del>.

```
Intel(R) Rapid Storage Technology enterprise - SATA Option ROM - 3.6.0.1023
Copyright(C) 2003-12 Intel Corporation. All Rights Reserved.

[ DELETE VOLUME MENU ]

Name      Level      Drives  Capacity  Status  Bootable
Volume0   RAID0 (Stripe)  2       298.0GB  Normal  Yes

[ HELP ]

Deleting a volume will reset the disks to non-RAID

WARNING: ALL DISK DATA WILL BE DELETED.
(This does not apply to Recovery volumes)

[↑|↓]-Select      [ESC]-Previous Menu      [DEL]-Delete Volume
```

3. Press <Y> to confirm deletion of the selected RAID set and return to the utility main menu, or press <N> to return to the **DELETE VOLUME** menu.

```
[ DELETE VOLUME VERIFICATION ]

ALL DATA IN THE VOLUME WILL BE LOST!
(This does not apply to Recovery volumes)

Are you sure you want to delete volume "Volume0"? (Y/N):
```

## 5.3.3 Resetting disks to Non-RAID



Take caution before you reset a RAID volume hard disk drive to non-RAID. Resetting a RAID volume hard disk drive deletes all internal RAID structure on the drive.

To reset a RAID set:

1. From the utility main menu, select **3. Reset Disks to Non-RAID** and press <Enter>.
2. Press the up/down arrow keys to select the drive(s) or disks of the RAID set you want to reset, then press <Space>. A small triangle before the Port number marks the selected drive. Press <Enter> when you are done.

```
[ RESET RAID DATA ]
Resetting RAID disk will remove its RAID structures
and revert it to a non-RAID disk.

WARNING: Resetting a disk causes all data on the disk to be lost.
(This does not apply to Recovery volumes)

Port  Drive Model  Serial #      Size      Status
---  -
0     ST3300656SS   HWAS0000991753TR  279.3GB  Member Disk
1     ST3300656SS   37VN00009846RAJ1  279.3GB  Member Disk

Select the disks that should be reset.

[↑↓]-Previous/Next [SPACE]-Selects [ENTER]-Selection Complete
```

3. Press <Y> in the confirmation window to reset the drive(s) or press <N> to return to the utility main menu.

### 5.3.4 Exiting the Intel® Rapid Storage Technology enterprise SATA/SSATA Option ROM utility

To exit the utility:

1. From the utility main menu, select **4. Exit** then press <Enter>.
2. Press <Y> to exit or press <N> to return to the utility main menu.

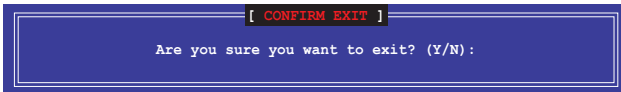

### 5.3.5 Rebuilding the RAID



This option is only for the RAID 1 set.

#### Rebuilding the RAID with other non-RAID disk

If any of the SATA hard disk drives included in the RAID 1 array failed, the system displays the status of the RAID volume as **"Degraded"** during POST. You can rebuild the RAID array with other installed non-RAID disks.

To rebuild the RAID with other non-RAID disk:

1. During POST, press <Ctrl>+<I> at the prompt to enter the Intel Rapid Storage Technology option ROM utility.
2. If there is a non-RAID SATA Hard Disk available, the utility will prompt you to rebuild the RAID. Press the up/down arrow keys to select the destination disk then Press <Enter> to start the rebuilding process, or press <ESC> to exit.

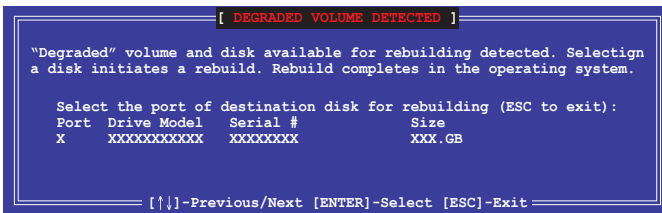

Select a destination disk with the same size as the original hard disk.

- The utility immediately starts rebuilding after the disk is selected. When done, the status of the degraded RAID volume is changed to **“Rebuild”**.

```

Intel(R) Rapid Storage Technology enterprise - SATA Option ROM - 3.6.0.1023
Copyright(C) 2003-12 Intel Corporation. All Rights Reserved.

[ MAIN MENU ]
1. Create RAID Volume
2. Delete RAID Volume
3. Reset Disks to Non-RAID
4. Exit

[ DISK/VOLUME INFORMATION ]

RAID Volumes:
ID Name Level1 Strip Size Status Bootable
1 Volume0 RAID1(Mirror) N/A 149.0GB Rebuild Yes
*=Data is Encrypted

Physical Devices:
Port Drive Model Serial # Size Type/Status (Vol ID)
1 ST3160812AS 9LS0F4HL 149.0GB Member Disk(0)
2 ST3160812AS 3LS0JYL8 149.0GB Member Disk(0)

Volumes with "Rebuild" status will be rebuilt within the operating system.

[↑↓]-Select [ESC]-Exit [ENTER]-Select Menu

```

- Press <Esc> to exit Intel Rapid Storage Technology and reboot the system.
- Select **Start > Programs > Intel Rapid Storage > Intel Rapid Storage Console** or click the **Intel Rapid Storage Technology** tray icon to load the Intel Rapid Storage Manager utility.
- From the **View** menu, select **Advanced Mode** to display the details of the Intel Rapid Storage Console.
- From the **Volumes view** option, select **RAID volume** to view the rebuilding status. When finished, the status is changed to **“Normal”**.

### Rebuilding the RAID with a new hard disk

If any of the SATA hard disk drives included in the RAID array failed, the system displays the status of the RAID volume as **“Degraded”** during POST. You may replace the disk drive and rebuild the RAID array.

To rebuild the RAID with a new hard disk:

- Remove the failed SATA hard disk and install a new SATA hard disk of the same specification into the same SATA Port.



---

Select a destination disk with the same size as the original hard disk.

---

- Reboot the system then follow the steps in section **Rebuilding the RAID with other non-RAID disk**.

### 5.3.6 Setting the Boot array in the BIOS Setup Utility

You can set the boot priority sequence in the BIOS for your RAID arrays when creating multi-RAID using the Intel® Rapid Storage Technology enterprise SATA Option ROM utility.

To set the boot array in the BIOS:



---

Set at least one of the arrays bootable to boot from the hard disk.

---

1. Reboot the system and press <Del> to enter the BIOS setup utility during POST.
2. Go to the **Boot** menu and select the boot option priority.
3. Use up/down arrow keys to select the boot priority and press <Enter>. See the **Boot menu** section of Chapter 4 for more details.
4. From the **Exit** menu, select **Save Changes & Exit**, then press <Enter>.
5. When the confirmation window appears, select **Yes**, then press <Enter>.

## 5.4 Intel® Rapid Storage Technology enterprise (Windows)

The Intel® Rapid Storage Technology enterprise allows you to create RAID 0, RAID 1, RAID 10 (RAID 1+0), and RAID 5 set(s) from Serial ATA hard disk drives that are connected to the Serial ATA connectors supported by the Southbridge.



You need to manually install the Intel® Rapid Storage Technology enterprise utility on a Windows® operating system. Please refer to the installation instructions in Chapter 6.

To enter the Intel® Rapid Storage Technology enterprise utility under Windows operating system:

1. Turn on the system and go to the windows desktop.
2. Click the **Intel® Rapid Storage Technology enterprise** icon to display the main menu.

Your storage system is configured for data protection, increased performance and optimal data storage capacity. You can create additional volumes to further optimize your storage system.

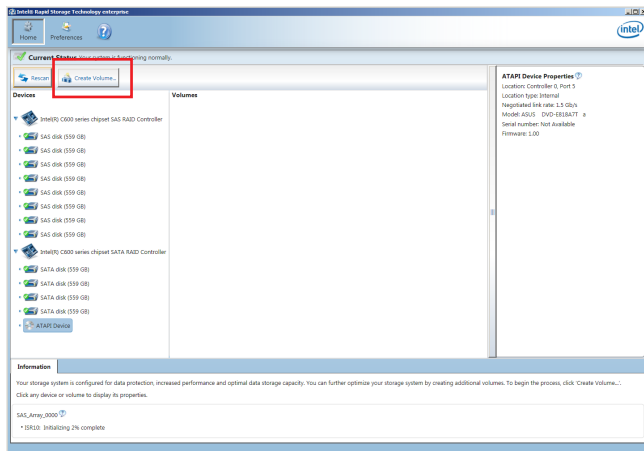

You can click **Rescan** to re-scan any attached hard disks.

## 5.4.1 Creating a RAID set

To create a RAID set:

1. From the utility main menu, select **Create Volume** and select volume type.
2. Click **Next**.

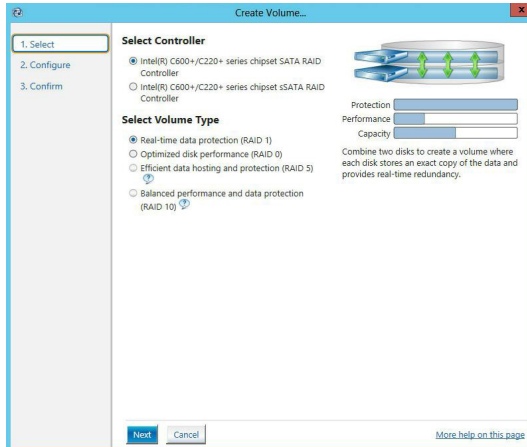

3. Enter a name for the RAID set, then select the array disks.
4. Select **Volume Size** tab, you can drag the bar to decide the volume size.
5. Click **Next**.

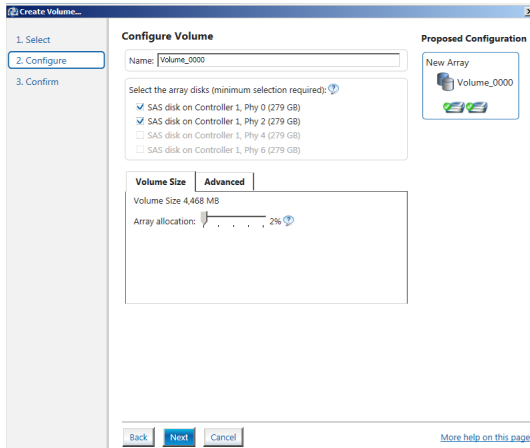

- If you do not want to keep the data on one of the selected disks, select **NO** when prompted.
- If you want to **Enable volume write-back cache** or **Initialize volume**, click **Advanced**.

6. Confirm the volume creation, then click **Create Volume** to continue.



This process could take a while depending on the number and size of the disks. You can continue using other applications during this time.

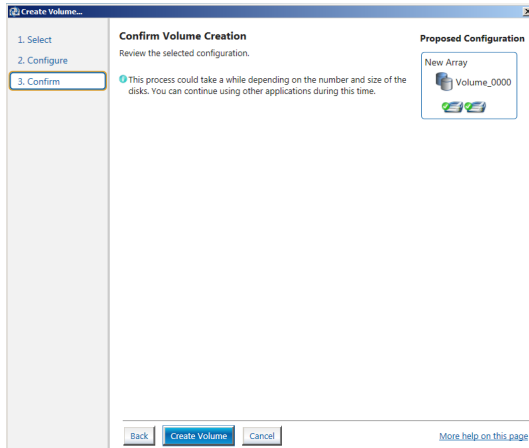

7. Wait until the process is completed, then click **OK** when prompted.

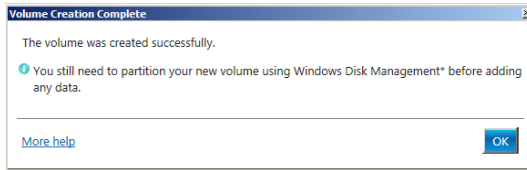

You still need to partition your new volume using Windows Disk Management before adding any data.

The RAID set is displayed in the **Volumes** list and you can change the settings in **Volume Properties**.

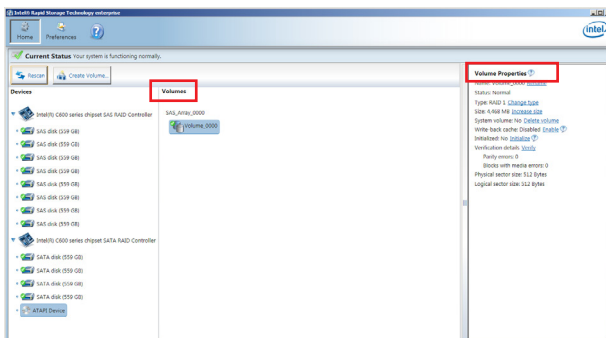



## 5.4.2 Changing a Volume Type

To change the volume type in **Volume Properties**:

1. Click the SATA array items you want to change in **Volumes** field.
2. From the **Volume Properties** field, select **Type:RAID 1 Change type**.

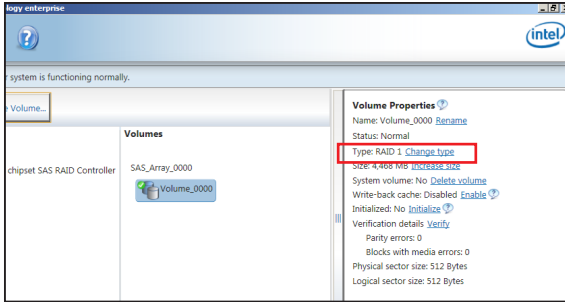

3. You can change the **Name**, **Select the new volume type**, and **Select additional disks to include in the new volume** if needed.
4. Select the **Data stripe size** for the RAID array (for RAID 0, 10 and 5 only), and click **OK**. The available stripe size values range from 4 KB to 128 KB. The following are typical values:  
RAID 0: 128KB  
RAID 10: 64KB  
RAID 5: 64KB

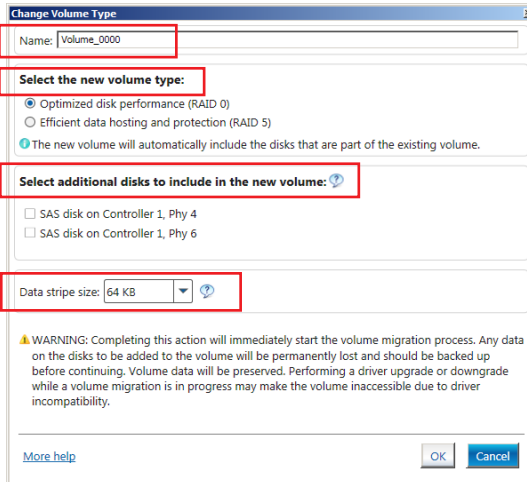

We recommend a lower stripe size for server systems, and a higher stripe size for multimedia computer systems used mainly for audio and video editing.

### 5.4.3 Deleting a volume



Be cautious when deleting a volume. You will lose all data on the hard disk drives. Before you proceed, ensure that you back up all your important data from your hard drives.

To delete a volume:

1. From the utility main menu, select the volume (exp. Volume\_0000) in **Volumes** field you want to delete.

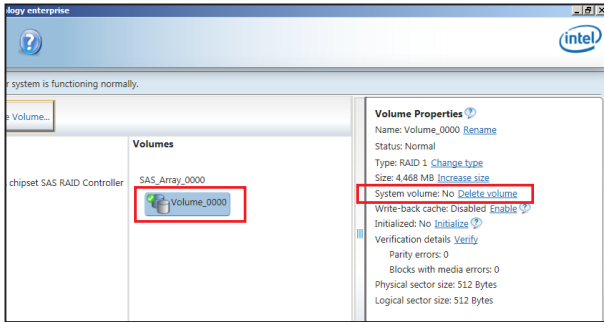

2. Select **Delete volume** in **Volume Properties** field. The following screen appears.

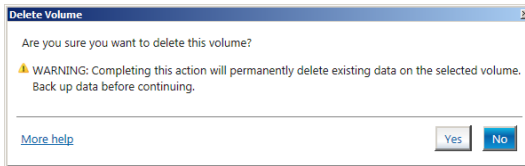

3. Click **Yes** to delete the volume and return to the utility main menu, or click **No** to return to the main menu.

## 5.4.4 Preferences

### System Preferences

Allow you to set to show the notification area icon and show system information, warning, or errors here.

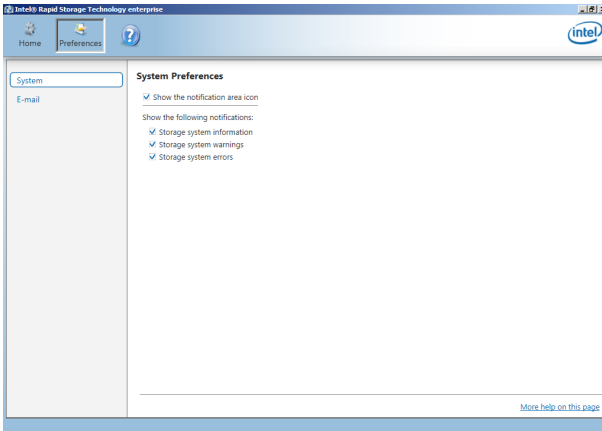

### E-Mail Preferences

Allow you to set to sent e-mail of the following events:

- Storage system information
- Storage system warnings
- Storage system errors

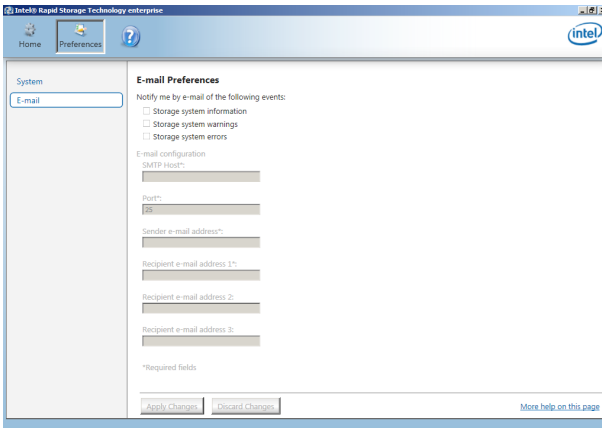



# 6

## **Driver installation**

This chapter provides the instructions for installing the necessary drivers for different system components in both Linux<sup>®</sup> and Windows<sup>®</sup> Operating Systems.

## 6.1 RAID driver installation

After creating the RAID sets for your server system, you are now ready to install an operating system to the independent hard disk drive or bootable array. This part provides the instructions on how to install the RAID controller drivers during OS installation.

### 6.1.1 Creating a RAID driver disk



---

The system does not include a floppy drive. You have to use a USB floppy drive when creating a SATA RAID driver disk.

---



---

If you have created RAID sets with the LSI Software RAID configuration utility, the boot priority of the SATA optical disk drive has to be manually adjusted. Otherwise, the system will not boot from the connected SATA ODD.

---

To create a RAID driver disk in Windows® environment

1. Start Windows®.
2. Place the motherboard support DVD into the optical drive.
3. Go to the **Make disk** menu, and then select the type of RAID driver disk you want to create.
4. Insert a floppy disk into the USB floppy disk drive.
5. Follow succeeding screen instructions to complete the process.



---

Write-protect the floppy disk to avoid computer virus infection.

---

To create a RAID driver disk in Red Hat® Enterprise Linux server environment

1. Insert a blank formatted high-density floppy disk to the USB floppy disk drive.
2. Type `dd if=xxx.img of=/dev/fd0` to decompress the file into the floppy disk from the following path in the support DVD:

For LSI MegaRAID Driver

`\Drivers\C610 LSI RAID\Driver\makediskLinux`

3. Eject the floppy disk.

## 6.1.2 Installing the RAID controller driver

### During Windows® Server 2008 R2 OS installation

To install the RAID controller driver when installing Windows® Server 2008 R2 OS

1. Boot the computer using the Windows® Server 2008 R2 OS installation disc. Follow the screen instructions to start installing Windows Server 2008 R2.
2. When prompted to choose a type of installation, click **Custom (advanced)**.

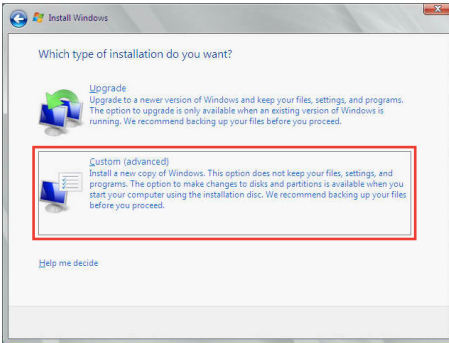

3. Click **Load Driver**.

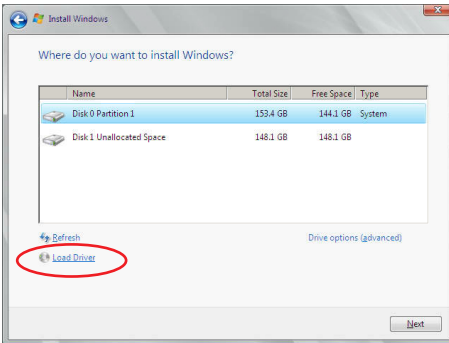

4. A message appears, reminding you to insert the installation media containing the driver of the RAID controller driver. If you have only one optical drive installed in your system, eject the Windows OS installation disc and replace with the motherboard Support DVD into the optical drive. Click **Browse** to continue.

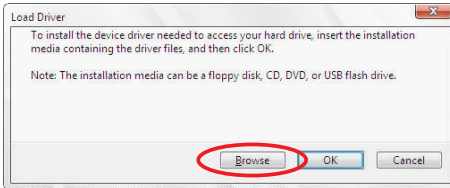

5. Locate the driver in the corresponding folder of the Support DVD then click **OK** to continue.
6. Select the RAID controller driver you need from the list and click **Next**.
7. When the system finishes loading the RAID driver, replace the motherboard Support DVD with the Windows Server installation disc. Select the drive to install Windows and click **Next**.

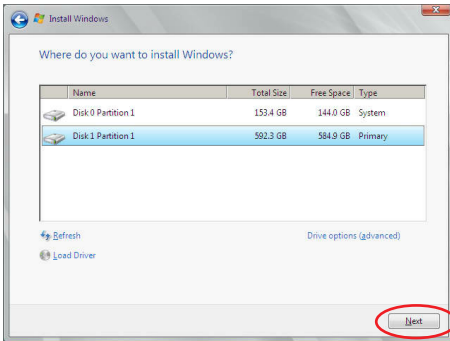

8. Setup then proceeds with the OS installation. Follow screen instructions to continue.



## Red Hat® Enterprise Linux OS 5.x

To load the LSI MegaRAID controller driver when installing Red Hat® Enterprise OS:

1. Boot the system from the Red Hat® OS installation CD.
2. At the `boot:`, type `linux dd` then press <Enter>.

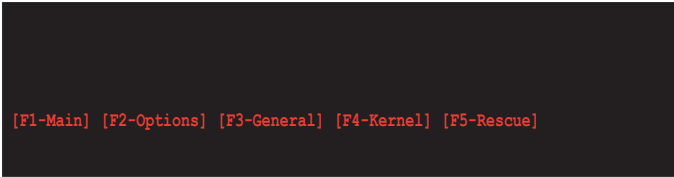

3. Select **Yes** using the <Tab> key when asked if you have the driver disk, then press <Enter>.

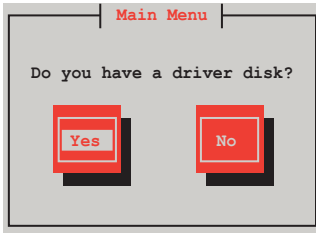

4. Insert the Red Hat® Enterprise RAID driver disk to the USB floppy disk drive, select **OK**, then press <Enter>.

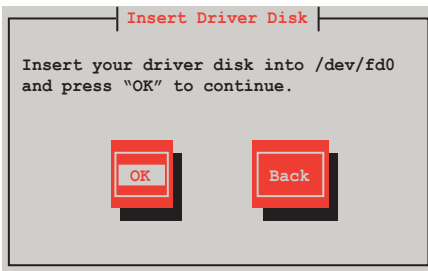

The drivers for the RAID card are installed to the system.

5. When asked if you will load additional RAID controller drivers, select **No**, then press <Enter>.

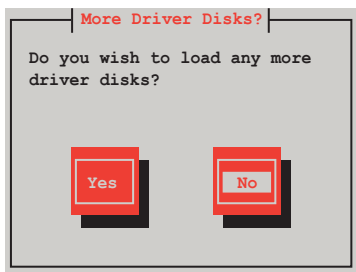

6. Follow the onscreen instructions to finish the OS installation.
7. When the installation is completed, DO NOT click **Reboot**. Press <Ctrl> + <Alt> + <F2> to switch to the command-line interface from graphic user interface.
8. Type the following commands when using a Legacy floppy.

```
mkdir /mnt/driver
mount /dev/fd0 /mnt/driver
cd /mnt/driver
sh replace_ahci.sh
reboot
```

## Red Hat® Enterprise Linux OS 6.x

To install the LSI MegaRAID controller driver when installing Red Hat® Enterprise OS:

1. Boot the system from the Red Hat® OS installation CD.
2. Press <Tab> to edit options.

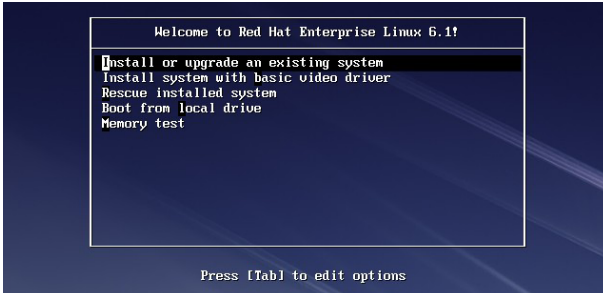

3. While booting from DVD, press <ESC> to give the third party driver. Enter the following command at the boot: `Linux dd blacklist=iscsi blacklist=ahci nodmraid`, then press <ENTER>.



4. Select Yes using the <Tab> key when asked if you have the driver disk, then press <Enter>.

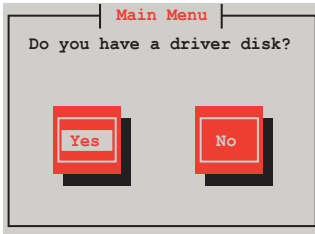

- 5 . You have multiple devices which could serve as source for a driver disk. Choose one you like to use and select **OK**, then press <Enter>.

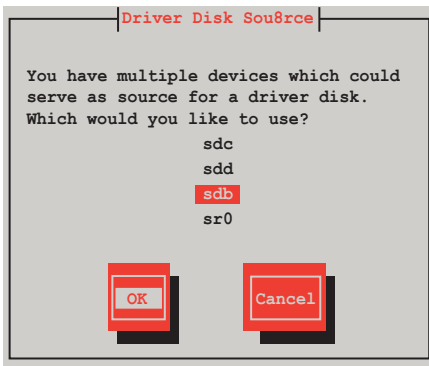

6. Insert the Red Hat® Enterprise RAID driver disk to the USB floppy disk drive, select **OK**, then press <Enter>.

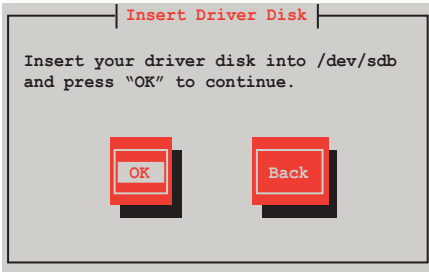

The drivers for the RAID card are installed to the system.

7. When asked if you will load additional RAID controller drivers, select **No**, then press <Enter>.

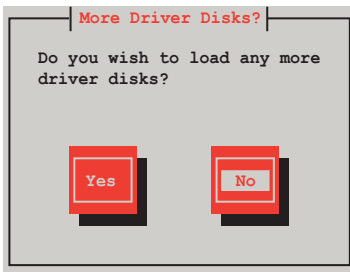

8. Follow the onscreen instructions to finish the OS installation.

## Preparing the Linux Driver

Ensure that there is another computer with a Linux-based OS to create the RAID driver. When creating the RAID driver, you may refer to the examples below which uses a 64bit SUSE Linux system to create a 64bit RAID driver for SUSE11 sp1.

1. Copy the image file into the Linux system.

Example: `megasr-15.00.0120.2012-1-sles11-ga-x86_64.img`

2. Create a folder.

Example: `image`

3. Mount the image file into the image folder using this command format:

`mount -o loop [image file name] image`

Example: `mount -o loop megasr-15-15.00.0120.2012-1-sles11-ga-x86_64.img image`

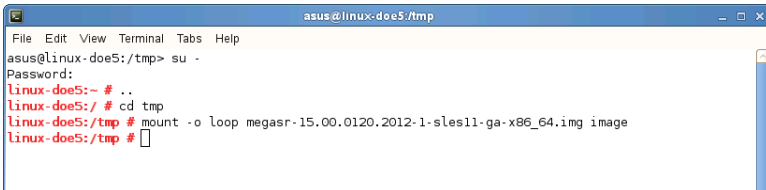

4. Copy the contents of the image directory, labeled as **01**, into a FAT32 USB drive.

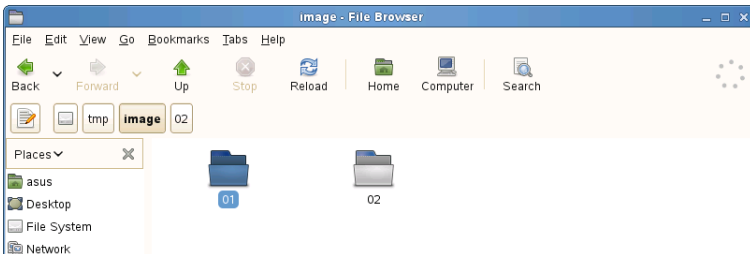

5. Rename the **01** folder to **CD Image**.



## Installing SUSE 11 Linux OS

To install the LSI MegaRAID controller driver when installing SUSE Linux Enterprise Server OS:

1. Boot the system from the SUSE OS installation CD.
2. Use the arrow keys to select **Installation** from the **Boot Options** menu.



3. Press <F6>, then select **Yes** from the menu. Press <Enter>.



- Use the USB drive to provide the third-party driver during the OS installation. Type the command **brokenmodules=ahci** in **Boot Options** field, and press <Enter>.

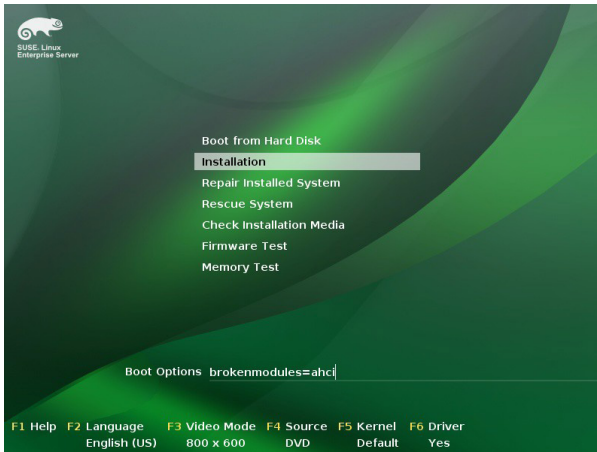

- When below screen appears, select the USB floppy disk drive (sda) as the driver update medium. Select **OK**, then press <Enter>.

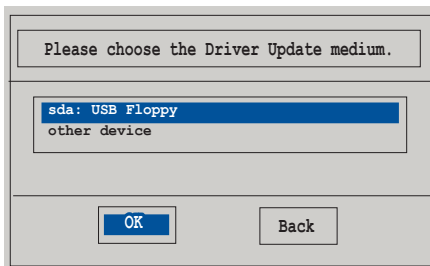

- Select **Back** and follow the onscreen instructions to finish the installation.



## 6.2 Management applications and utilities installation

The support DVD that is bundled with your motherboard contains drivers, management applications, and utilities that you can install to maximize the features of your motherboard.



1. The contents of the support DVD are subject to change at any time without notice. Visit the ASUS website ([www.asus.com](http://www.asus.com)) for the latest updates on software and utilities.
2. The support DVD is supported on Windows® Server 2008 R2 and Windows® Server 2012.

## 6.3 Running the Support DVD

When you place the support DVD into the optical drive, the DVD automatically displays the main screen if Autorun is enabled in your computer. By default, the Drivers tab is displayed.



If Autorun is NOT enabled in your computer, browse the contents of the support DVD to locate the file **ASSETUP.EXE** from the **BIN** folder. Double-click the **ASSETUP.EXE** to run the support DVD.

The main screen of the Support DVD contains the following tabs:

1. Drivers
2. Utilities
3. MakeDisk
4. Manual
5. Contact



The main screen of the Support DVD looks exactly the same on the Windows® Server 2008 R2 and on the Windows® Server 2012 Operating System (OS).

### 6.3.1 Drivers menu tab

The Drivers Menu shows the available device drivers if the system detects installed devices. Install the necessary drivers to activate the devices.



### 6.3.2 Utilities menu tab

The Utilities menu displays the software applications and utilities that the motherboard supports.

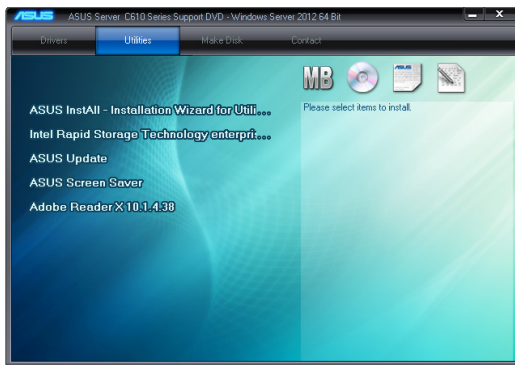

### 6.3.3 MakeDisk menu tab

The MakeDisk menu contains items to create the Intel RAID driver disks.



---

Press the arrow down button in the lower part of the menu to view more items.

---

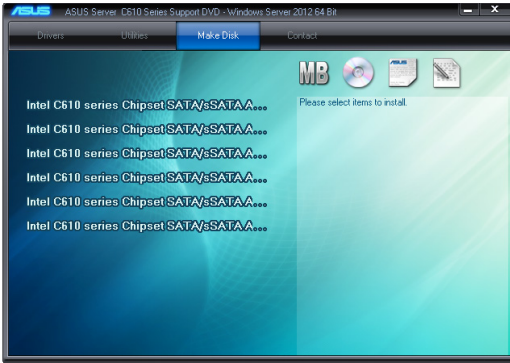

### 6.3.4 Manual menu

The Manual menu provides the link to the Broadcom NetXtreme II Network Adapter user guide.



---

You need an internet browser installed in your OS to view the User Guide.

---

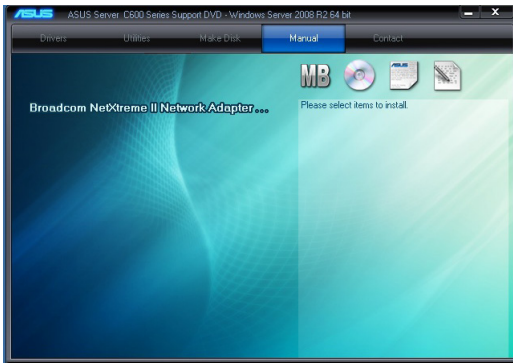

### 6.3.5 Contact information menu

The Contact menu displays the ASUS contact information, e-mail addresses, and useful links if you need more information or technical support for your motherboard.



## 6.4 Intel® chipset device software installation

This section provides the instructions on how to install the Intel® chipset device software on the system.

You need to manually install the Intel® chipset device software on a Windows operating system.

To install the Intel® chipset device software:

1. Restart the computer, and then log on with **Administrator** privileges.
2. Insert the motherboard/system support DVD to the optical drive. The support DVD automatically displays the **Drivers** menu if Autorun is enabled in your computer.



If Autorun is NOT enabled in your computer, browse the contents of the support DVD to locate the file **ASSETUP.EXE** from the **BIN** folder. Double-click the **ASSETUP.EXE** to run the support DVD.

3. Click the item **Intel Chipset Device Software** from the menu.

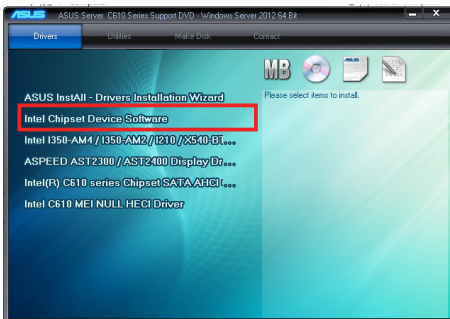

4. The **Intel(R) Chipset Device Software** window appears. Click **Next** to start installation.



5. Select **Yes** to accept the terms of the **License Agreement** and continue the process.

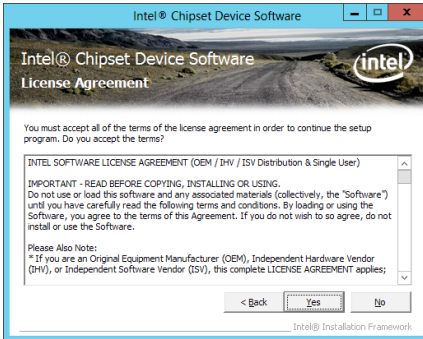

6. Read the **Readme File Information** and press **Next** to continue the installation.

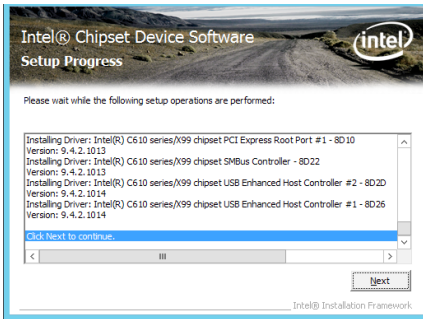

7. Toggle **Yes, I want to restart the computer now** and click **Finish** to complete the setup process.



## 6.5 Installing the Intel® I210 Gigabit Adapters driver

This section provides the instructions on how to install the **Intel® I210 Gigabits Adapter Driver** on the system.

To install the **Intel® I210 Gigabit Adapters Driver** on the Windows® operating system:

1. Restart the computer.
2. Log on with **Administrator** privileges.
3. Insert the motherboard/system support DVD to the optical drive.



If Autorun is NOT enabled in your computer, browse the contents of the support DVD to locate the file **ASSETUP.EXE** from the **BIN** folder. Double-click the **ASSETUP.EXE** to run the support DVD.

4. Click **Intel® I350-AM1/I350-AM2/I210/X540-BT2 Gigabit Adapters Drivers** in the **Drivers** menu of the main screen to start the installation.

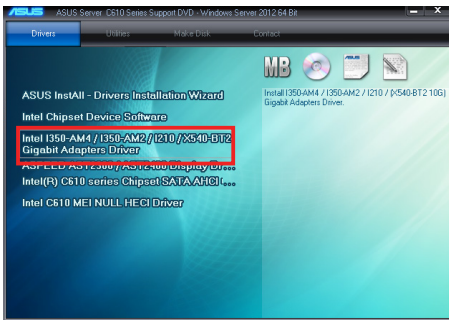

5. Click **Install Drivers and Software** option to begin installation.

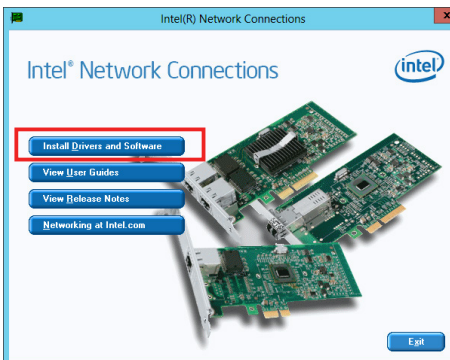

6. Click **Next** when the **Intel(R) Network Connections–InstallShield Wizard** window appears.

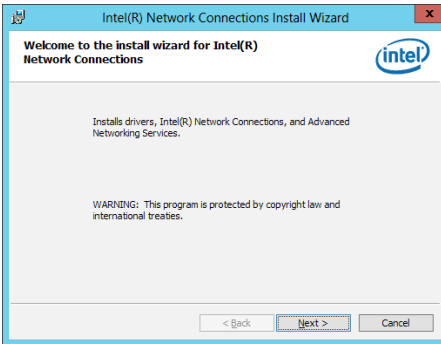

7. Tick **I accept the terms in the license agreement** and click **Next** to continue.

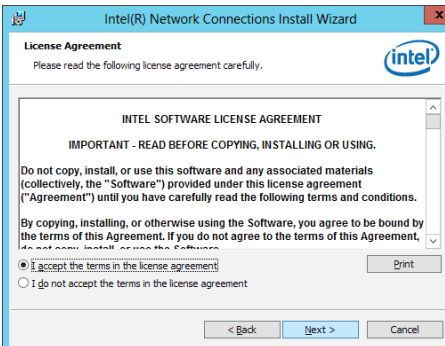

8. From the **Setup Options** window, click **Next** to start the installation.



By default, **Intel(R) PROSet for Windows Device Manager** and **Windows PowerShell Module** are ticked.

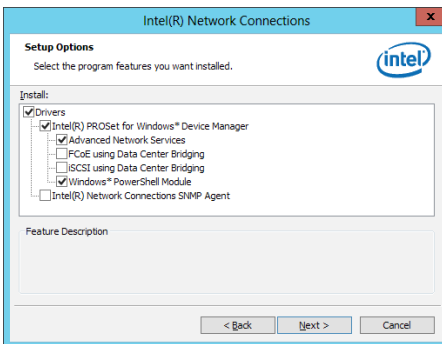



9. Click **Install** to start the installation.

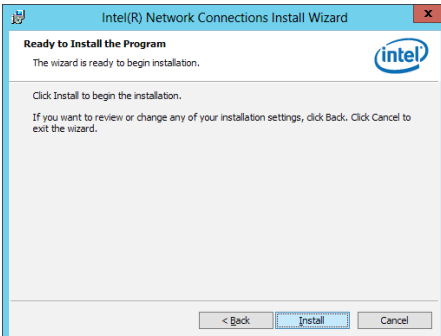

10. When the installation is done, press **Finish** to complete the installation.

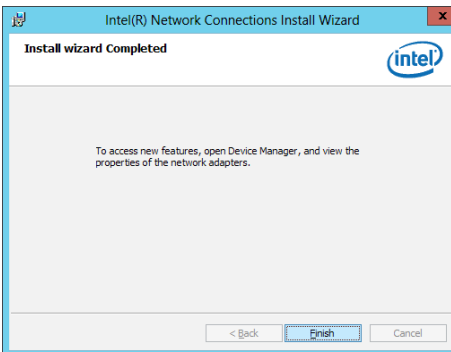

## 6.6 VGA driver installation

This section provides the instructions on how to install the ASPEED Video Graphics Adapter (VGA) driver.

You need to manually install the ASPEED VGA driver on a Windows® operating system.

To install the ASPEED VGA driver:

1. Restart the computer, and then log on with **Administrator** privileges.
2. Insert the motherboard/system support DVD to the optical drive. The support DVD automatically displays the **Drivers** menu if Autorun is enabled in your computer.



---

If Autorun is **NOT** enabled in your computer, browse the contents of the support DVD to locate the file **ASSETUP.EXE** from the **BIN** folder. Double-click the **ASSETUP.EXE** to run the support DVD.

---

3. Click the **ASPEED AST2300 / AST2400 Display Driver** to begin installation.

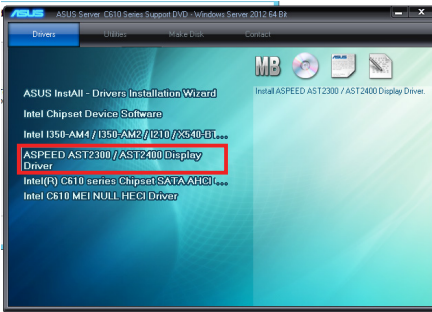

4. From the installation window, click **Next** to start the installation.



5. Click **Install** to proceed with the installation.

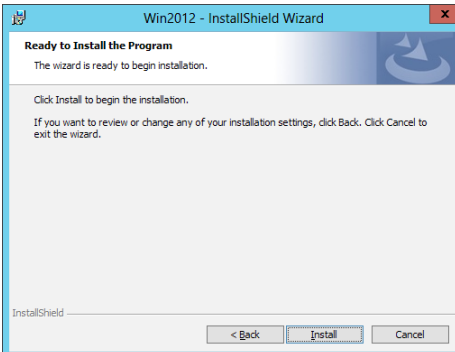

6. Click **Finish** to complete the installation.

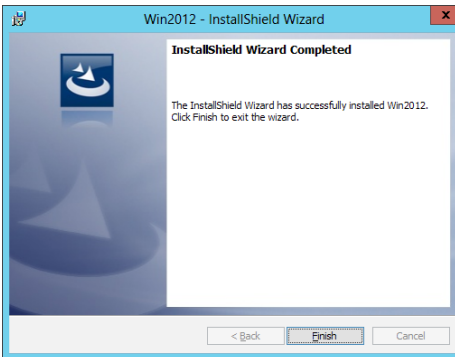

## 6.7 Intel® Rapid Storage Technology enterprise 4.0 installation

This section provides the instructions on how to install the Intel® Rapid Storage Technology enterprise 4.0 on the system.

You need to manually install the Intel® Rapid Storage Technology enterprise 4.0 utility on a Windows® operating system.

To install the Intel® Rapid Storage Technology enterprise 4.0 utility:

1. Restart the computer, and then log on with **Administrator** privileges.
2. Insert the motherboard/system support DVD to the optical drive, and find the utility menu.
3. Click the **Intel® Rapid Storage Technology enterprise 4.0** to begin installation.

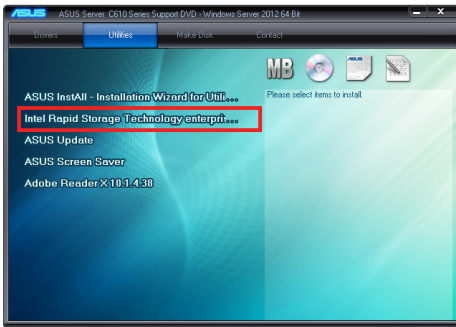

4. When the **Welcome to the Setup Program** appears, click **Next** to start the installation.

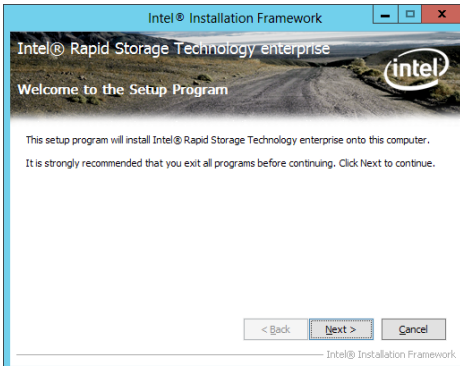

5. Read the **Warning** message and click **Next** to continue.



6. Read the **License Agreement** and click **Yes** to continue.

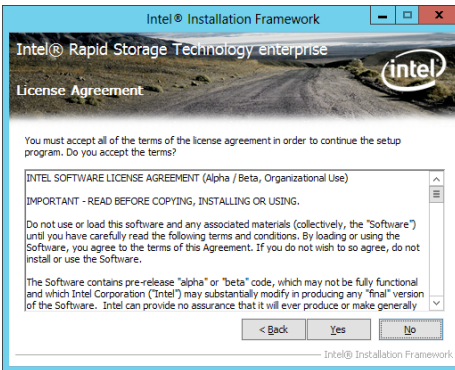

7. Read the **Readme File Information** and click **Next** to continue.

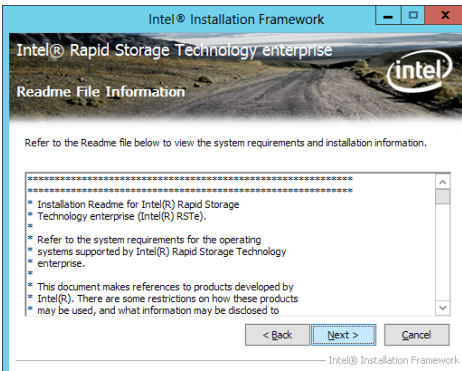

8. After completing the installation, click **Next** to complete the setup process.

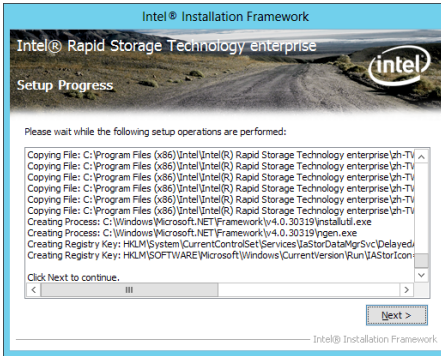

9. Select **Yes, I want to restart my computer now** and click **Finish** to restart your computer before using the program.

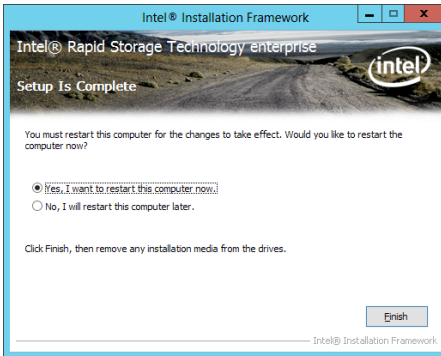

# Reference Information



This appendix includes additional information that you may refer to when configuring the motherboard.

# A.1 Z10PA-D8 Series block diagram

## Z10PA-D8

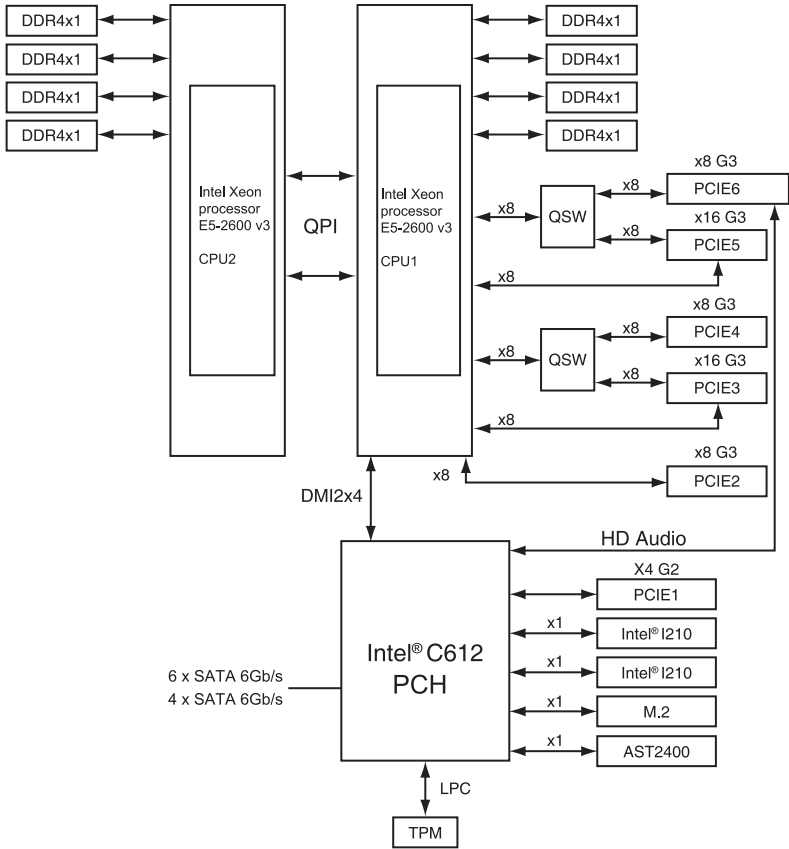



# Z10PA-D8C

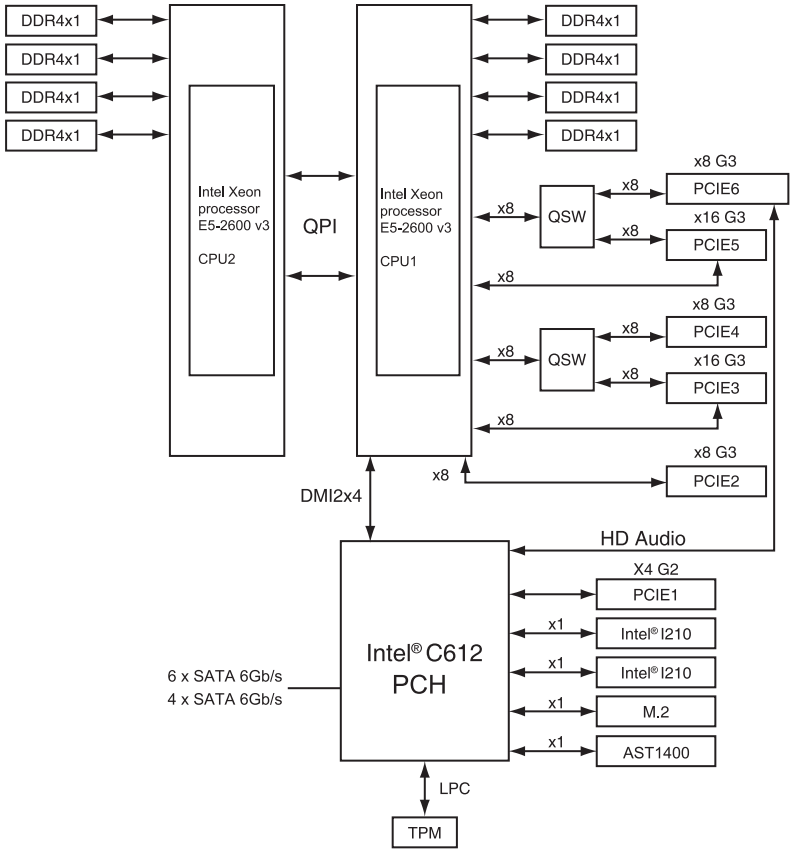



## ASUS contact information

### ASUSTeK COMPUTER INC.

Address 15 Li-Te Road, Peitou, Taipei, Taiwan 11259  
Telephone +886-2-2894-3447  
Fax +886-2-2890-7798  
E-mail info@asus.com.tw  
Web site <http://www.asus.com>

#### *Technical Support*

Telephone +86-21-38429911  
Fax +86-21-58668722 ext: 9101  
Online Support <http://support.asus.com/techserv/techserv.aspx>

### ASUSTeK COMPUTER INC. (Taiwan)

Address 15 Li-Te Road, Peitou, Taipei, Taiwan 11259  
Telephone +886-2-2894-3447  
Fax +886-2-2890-7798  
E-mail info@asus.com.tw  
Web site <http://www.asus.com.tw>

#### *Technical Support*

Telephone +886-2-2894-3447 (0800-093-456)  
Online Support <http://support.asus.com/techserv/techserv.aspx>

### ASUSTeK COMPUTER INC. (China)

Address No.508, Chundong Road, Xinzhuang Industrial Zone,  
Minhang District, Shanghai, China.  
Telephone +86-21-5442-1616  
Fax +86-21-5442-0099  
Web site <http://www.asus.com.cn>

#### *Technical Support*

Telephone 400-620-6655  
Online Support <http://support.asus.com/techserv/techserv.aspx>

## ASUS contact information

### ASUS COMPUTER INTERNATIONAL (America)

Address 800 Corporate Way, Fremont, CA 94539, USA  
Fax +1-510-608-4555  
Web site <http://usa.asus.com>

#### *Technical Support*

Support fax +1-812-284-0883  
General support +1-812-282-2787  
Online support <http://support.asus.com/techserv/techserv.aspx>

### ASUS COMPUTER GmbH (Germany and Austria)

Address Harkort Str. 21-23, D-40880 Ratingen, Germany  
Fax +49-2102-959911  
Web site <http://www.asus.de>  
Online contact <http://www.asus.de/sales>

#### *Technical Support*

Telephone +49-1805-010923  
Support Fax +49-2102-959911  
Online support <http://support.asus.com/techserv/techserv.aspx>

### ASUS Czech Service s.r.o. (Europe)

Address Na Rovince 887, 720 00 Ostrava – Hrabová, Czech  
Republic  
Telephone +420-596766888  
Web site <http://www.asus.cz>

#### *Technical Support*

Telephone +420-596-766-891  
Fax +420-596-766-329  
E-mail [advance.rma.eu@asus.com](mailto:advance.rma.eu@asus.com)  
Online Support <http://support.asus.com/techserv/techserv.aspx>

## ASUS contact information

### ASUS Holland BV (The Netherlands)

Address Marconistraat 2, 7825GD EMMEN, The Netherlands  
Web site <http://www.asus.com>

#### **Technical Support**

Telephone +31-(0)591-5-70292  
Fax +31-(0)591-666853  
E-mail [advance.rma.eu@asus.com](mailto:advance.rma.eu@asus.com)  
Online Support <http://support.asus.com/techserv/techserv.aspx>

### ASUS Polska Sp. z o.o. (Poland)

Address Ul. Postępu 6, 02-676 Warszawa, Poland  
Web site <http://pl.asus.com>

#### **Technical Support**

Telephone +48-225718033  
Online Support <http://support.asus.com/techserv/techserv.aspx>

### ASK-Service (Russia and CIS)

Address г.Москва, ул. Орджоникидзе, д.10, Россия  
Telephone (495) 640-32-75  
Web site <http://ru.asus.com>

#### **Technical Support**

Telephone 008-800-100-ASUS (008-800-100-2787)  
Online Support <http://vip.asus.com/eservice/techserv.aspx?SLanguage=ru>

# DECLARATION OF CONFORMITY

Per FCC Part 2, Section 2.1077(a)



Responsible Party Name: **Asus Computer International**

Address: **800 Corporate Way, Fremont, CA, 94539.**

Phone/Fax No: **(510)739-3777/(510)608-4555**

hereby declares that the product

**Product Name : Motherboard**

**Model Number : Z10PA-D8, Z10PA-D8C**

Conforms to the following specifications:

FCC Part 15, Subpart B, Unintentional Radiators

### Supplementary Information:

This device complies with part 15 of the FCC Rules. Operation is subject to the following two conditions: (1) This device may not cause harmful interference, and (2) this device must accept any interference received, including interference that may cause undesired operation.

Representative Person's Name : **Steve Chang / President**

*Steve Chang*

Signature :

Date : **May, 27, 2014**

Ver. 140331

# EC Declaration of Conformity



We, the undersigned,

Manufacturer: **ASUSTEK COMPUTER INC.**  
Address: **4F, No. 150, LITE Rd., PEITOU, TAIPEI 112, TAIWAN**  
Authorized representative in Europe: **ASUS COMPUTER GmbH**  
Address, City: **HARKORT STR. 21-23, 40880 RATINGEN**  
Country: **GERMANY**

declare the following apparatus:

Product name : **Motherboard**  
Model name : **Z10PA-D8, Z10PA-D8C**

conform with the essential requirements of the following directives:

- 2004/108/EC-EMC Directive**  
 EN 55022:2010-AC:2011  
 EN 55013:2001+A1:2003-A2:2006  
 EN 55020:2007-A11:2011
- 1999/5/EC-R&TTE Directive**  
 EN 300 328 V1.7.1 (2006-10)  
 EN 300 440 V1.6.1 (2010-08)  
 EN 300 441 V1.6.1 (2010-08)  
 EN 300 511 V0.2.0 (2003-03)  
 EN 300 489 V1.3.1 (2005-11)  
 EN 301 588-1 V5.2.1 (2011-05)  
 EN 301 588-2 V5.2.1 (2011-07)  
 EN 301 489-1 V2.2.1 (2012-09)  
 EN 301 489-1 V2.2.1 (2012-09)  
 EN 302 544-2 V1.1 (2009-01)  
 EN 302 523 V1.1 (2009-01)  
 EN 302 544-1 V1.1 (2009-01)  
 EN 62311:2008  
 EN 50385:2002  
 EN 62311:2008
- 2006/95/EC-LVD Directive**  
 EN 60950-1 / A12:2011
- 2009/125/EC-EP Directive**  
 Regulation (EC) No. 1275/2008  
 Regulation (EC) No. 642/2009
- 2011/65/EU-RoHS Directive**  
 Regulation (EC) No. 617/2013

Ver. 140331



(EC conformity marking)

Position : **CEO**  
Name : **Jerry Shei**

*Jerry Shei*

Signature :

Declaration Date: **27/05/2014**  
Year to begin affixing CE marking: **2014**

## Free Manuals Download Website

<http://myh66.com>

<http://usermanuals.us>

<http://www.somanuals.com>

<http://www.4manuals.cc>

<http://www.manual-lib.com>

<http://www.404manual.com>

<http://www.luxmanual.com>

<http://aubethermostatmanual.com>

Golf course search by state

<http://golfingnear.com>

Email search by domain

<http://emailbydomain.com>

Auto manuals search

<http://auto.somanuals.com>

TV manuals search

<http://tv.somanuals.com>