

Z87-PLUS

ASUS[®]

Motherboard

E7831
First Edition
May 2013

Copyright© 2013 ASUSTeK COMPUTER INC. All Rights Reserved.

No part of this manual, including the products and software described in it, may be reproduced, transmitted, transcribed, stored in a retrieval system, or translated into any language in any form or by any means, except documentation kept by the purchaser for backup purposes, without the express written permission of ASUSTeK COMPUTER INC. ("ASUS").

Product warranty or service will not be extended if: (1) the product is repaired, modified or altered, unless such repair, modification of alteration is authorized in writing by ASUS; or (2) the serial number of the product is defaced or missing.

ASUS PROVIDES THIS MANUAL "AS IS" WITHOUT WARRANTY OF ANY KIND, EITHER EXPRESS OR IMPLIED, INCLUDING BUT NOT LIMITED TO THE IMPLIED WARRANTIES OR CONDITIONS OF MERCHANTABILITY OR FITNESS FOR A PARTICULAR PURPOSE. IN NO EVENT SHALL ASUS, ITS DIRECTORS, OFFICERS, EMPLOYEES OR AGENTS BE LIABLE FOR ANY INDIRECT, SPECIAL, INCIDENTAL, OR CONSEQUENTIAL DAMAGES (INCLUDING DAMAGES FOR LOSS OF PROFITS, LOSS OF BUSINESS, LOSS OF USE OR DATA, INTERRUPTION OF BUSINESS AND THE LIKE), EVEN IF ASUS HAS BEEN ADVISED OF THE POSSIBILITY OF SUCH DAMAGES ARISING FROM ANY DEFECT OR ERROR IN THIS MANUAL OR PRODUCT.

SPECIFICATIONS AND INFORMATION CONTAINED IN THIS MANUAL ARE FURNISHED FOR INFORMATIONAL USE ONLY, AND ARE SUBJECT TO CHANGE AT ANY TIME WITHOUT NOTICE, AND SHOULD NOT BE CONSTRUED AS A COMMITMENT BY ASUS. ASUS ASSUMES NO RESPONSIBILITY OR LIABILITY FOR ANY ERRORS OR INACCURACIES THAT MAY APPEAR IN THIS MANUAL, INCLUDING THE PRODUCTS AND SOFTWARE DESCRIBED IN IT.

Products and corporate names appearing in this manual may or may not be registered trademarks or copyrights of their respective companies, and are used only for identification or explanation and to the owners' benefit, without intent to infringe.

Offer to Provide Source Code of Certain Software

This product contains copyrighted software that is licensed under the General Public License ("GPL"), under the Lesser General Public License Version ("LGPL") and/or other Free Open Source Software Licenses. Such software in this product is distributed without any warranty to the extent permitted by the applicable law. Copies of these licenses are included in this product.

Where the applicable license entitles you to the source code of such software and/or other additional data, you may obtain it for a period of three years after our last shipment of the product, either

(1) for free by downloading it from <http://support.asus.com/download>

or

(2) for the cost of reproduction and shipment, which is dependent on the preferred carrier and the location where you want to have it shipped to, by sending a request to:

ASUSTeK Computer Inc.
Legal Compliance Dept.
15 Li Te Rd.,
Beitou, Taipei 112
Taiwan

In your request please provide the name, model number and version, as stated in the About Box of the product for which you wish to obtain the corresponding source code and your contact details so that we can coordinate the terms and cost of shipment with you.

The source code will be distributed WITHOUT ANY WARRANTY and licensed under the same license as the corresponding binary/object code.

This offer is valid to anyone in receipt of this information.

ASUSTeK is eager to duly provide complete source code as required under various Free Open Source Software licenses. If however you encounter any problems in obtaining the full corresponding source code we would be much obliged if you give us a notification to the email address gpl@asus.com, stating the product and describing the problem (please DO NOT send large attachments such as source code archives, etc. to this email address).

Contents

Safety information.....	vi
About this guide.....	vii
Z87-PLUS specifications summary	ix
Package contents.....	xiv
Installation tools and components.....	xv

Chapter 1: Product Introduction

1.1 Special features.....	1-1
1.1.1 Product highlights.....	1-1
1.1.2 Dual Intelligent Processors 4 with 4-Way Optimization.....	1-2
1.1.3 ASUS Exclusive Features.....	1-3
1.1.4 ASUS Quiet Thermal Solution.....	1-4
1.1.5 ASUS EZ DIY.....	1-4
1.1.6 Other special features.....	1-5
1.2 Motherboard overview.....	1-6
1.2.1 Before you proceed.....	1-6
1.2.2 Motherboard layout.....	1-7
1.2.3 Central Processing Unit (CPU).....	1-9
1.2.4 System memory.....	1-10
1.2.5 Expansion slots.....	1-24
1.2.6 Onboard buttons and switches.....	1-26
1.2.7 Jumper.....	1-31
1.2.8 Onboard LEDs.....	1-32
1.2.9 Internal connectors.....	1-34

Chapter 2: Basic installation

2.1 Building your PC system.....	2-1
2.1.1 Motherboard installation.....	2-1
2.1.2 CPU installation.....	2-3
2.1.3 CPU heatsink and fan assembly installation.....	2-4
2.1.4 DIMM installation.....	2-6
2.1.5 ATX Power connection.....	2-7
2.1.6 SATA device connection.....	2-8
2.1.7 Front I/O Connectors.....	2-9
2.1.8 Expansion Card installation.....	2-10
2.2 BIOS update utility.....	2-11
2.3 Motherboard rear and audio connections.....	2-13
2.3.1 Rear I/O connection.....	2-13
2.3.2 Audio I/O connections.....	2-15

2.4	Starting up for the first time.....	2-17
2.5	Turning off the computer.....	2-18

Chapter 3: BIOS setup

3.1	Knowing BIOS.....	3-1
3.2	BIOS setup program.....	3-2
	3.2.1 EZ Mode.....	3-3
	3.2.2 Advanced Mode.....	3-4
3.3	My Favorites.....	3-6
3.4	Main menu.....	3-7
3.5	Ai Tweaker menu.....	3-9
3.6	Advanced menu.....	3-24
	3.6.1 CPU Configuration.....	3-25
	3.6.2 PCH Configuration.....	3-28
	3.6.3 SATA Configuration.....	3-29
	3.6.4 System Agent Configuration.....	3-31
	3.6.5 USB Configuration.....	3-33
	3.6.6 Platform Misc Configuration.....	3-34
	3.6.7 Onboard Devices Configuration.....	3-35
	3.6.8 APM.....	3-37
	3.6.9 Network Stack.....	3-38
3.7	Monitor menu.....	3-39
3.8	Boot menu.....	3-42
3.9	Tools menu.....	3-48
	3.9.1 ASUS EZ Flash 2 Utility.....	3-48
	3.9.2 ASUS O.C. Profile.....	3-48
	3.9.3 ASUS SPD Information.....	3-49
3.10	Exit menu.....	3-50
3.11	Updating BIOS.....	3-51
	3.11.1 EZ Update.....	3-51
	3.11.2 ASUS EZ Flash 2.....	3-52
	3.11.3 ASUS CrashFree BIOS 3.....	3-53
	3.11.4 ASUS BIOS Updater.....	3-54

Chapter 4: Software support

4.1	Installing an operating system.....	4-1
4.2	Support DVD information.....	4-1
	4.2.1 Running the support DVD.....	4-1
	4.2.2 Obtaining the software manuals.....	4-2

4.3	Software information	4-3
4.3.1	AI Suite 3.....	4-3
4.3.2	Dual Intelligent Processors 4	4-4
4.3.3	Remote GO!.....	4-10
4.3.4	USB 3.0 Boost.....	4-16
4.3.5	USB BIOS Flashback Wizard.....	4-17
4.3.6	Ai Charger+.....	4-19
4.3.7	EZ Update	4-20
4.3.8	Network iControl.....	4-21
4.3.9	USB Charger+.....	4-22
4.3.10	System Information	4-23
4.3.11	Audio configurations.....	4-24

Chapter 5: RAID support

5.1	RAID configurations	5-1
5.1.1	RAID definitions	5-1
5.1.2	Installing Serial ATA hard disks	5-2
5.1.3	Setting the RAID item in BIOS	5-2
5.1.4	Intel® Rapid Storage Technology Option ROM utility	5-3
5.2	Creating a RAID driver disk	5-7
5.2.1	Creating a RAID driver disk without entering the OS.....	5-7
5.2.2	Creating a RAID driver disk in Windows®.....	5-8
5.2.3	Installing the RAID driver during Windows® OS installation	5-8

Appendices

Notices	A-1
ASUS contact information	A-4

Safety information

Electrical safety

- To prevent electrical shock hazard, disconnect the power cable from the electrical outlet before relocating the system.
- When adding or removing devices to or from the system, ensure that the power cables for the devices are unplugged before the signal cables are connected. If possible, disconnect all power cables from the existing system before you add a device.
- Before connecting or removing signal cables from the motherboard, ensure that all power cables are unplugged.
- Seek professional assistance before using an adapter or extension cord. These devices could interrupt the grounding circuit.
- Ensure that your power supply is set to the correct voltage in your area. If you are not sure about the voltage of the electrical outlet you are using, contact your local power company.
- If the power supply is broken, do not try to fix it by yourself. Contact a qualified service technician or your retailer.

Operation safety

- Before installing the motherboard and adding devices on it, carefully read all the manuals that came with the package.
- Before using the product, ensure all cables are correctly connected and the power cables are not damaged. If you detect any damage, contact your dealer immediately.
- To avoid short circuits, keep paper clips, screws, and staples away from connectors, slots, sockets and circuitry.
- Avoid dust, humidity, and temperature extremes. Do not place the product in any area where it may become wet.
- Place the product on a stable surface.
- If you encounter technical problems with the product, contact a qualified service technician or your retailer.

About this guide

This user guide contains the information you need when installing and configuring the motherboard.

How this guide is organized

This guide contains the following parts:

- **Chapter 1: Product introduction**
This chapter describes the features of the motherboard and the new technology it supports. It includes description of the switches, jumpers, and connectors on the motherboard.
- **Chapter 2: Basic installation**
This chapter lists the hardware setup procedures that you have to perform when installing system components.
- **Chapter 3: BIOS setup**
This chapter tells how to change system settings through the BIOS Setup menus. Detailed descriptions of the BIOS parameters are also provided.
- **Chapter 4: Software support**
This chapter describes the contents of the support DVD that comes with the motherboard package and the software.
- **Chapter 5: RAID support**
This chapter describes the RAID configurations.

Where to find more information

Refer to the following sources for additional information and for product and software updates.

1. **ASUS websites**
The ASUS website provides updated information on ASUS hardware and software products. Refer to the ASUS contact information.
2. **Optional documentation**
Your product package may include optional documentation, such as warranty flyers, that may have been added by your dealer. These documents are not part of the standard package.

Conventions used in this guide

To ensure that you perform certain tasks properly, take note of the following symbols used throughout this manual.



DANGER/WARNING: Information to prevent injury to yourself when trying to complete a task.



CAUTION: Information to prevent damage to the components when trying to complete a task.



IMPORTANT: Instructions that you **MUST** follow to complete a task.



NOTE: Tips and additional information to help you complete a task.

Typography

Bold text

Indicates a menu or an item to select.

Italics

Used to emphasize a word or a phrase.

<Key>

Keys enclosed in the less-than and greater-than sign means that you must press the enclosed key.

Example: <Enter> means that you must press the Enter or Return key.

<Key1> + <Key2> + <Key3>

If you must press two or more keys simultaneously, the key names are linked with a plus sign (+).

Z87-PLUS specifications summary

CPU	<p>LGA1150 socket for the 4th Generation Intel® Core™ i7/Intel® Core™ i5/ Intel® Core™ i3, Pentium® and Celeron® processors</p> <p>Supports 22nm CPU</p> <p>Supports Intel® Turbo Boost Technology 2.0*</p> <p>* The Intel® Turbo Boost Technology 2.0 support depends on the CPU types.</p>
Chipset	Intel® Z87 Express Chipset
Memory	<p>4 x DIMM, max. 32GB, DDR3 2800 (O.C.)* / 2666 (O.C.)* 2600 (O.C.)* / 2500 (O.C.)* / 2400 (O.C.)* / 2200(O.C.)* / 2133(O.C.)* / 2000 (O.C.)* / 1866(O.C.)* / 1800(O.C.)* /1600 / 1333 MHz, non-ECC, un-buffered memory</p> <p>Dual channel memory architecture</p> <p>Supports Intel® Extreme Memory Profile (XMP)</p> <p>* Hyper DIMM support is subject to the physical characteristics of individual CPUs. Please refer to Memory QVL (Qualified Vendors List) for details.</p>
Expansion slots	<p>2 x PCI Express 3.0/2.0 x16 slots (single at x16 or dual at x8/x8 mode)</p> <p>1 x PCI Express 2.0 x16 slot (max. at x2 mode, compatible with PCIe x1 and x2 devices)</p> <p>2 x PCI Express 2.0 x1 slots</p> <p>2 x PCI slots</p>
VGA	<p>Integrated Graphics Processor - Intel® HD Graphics support</p> <p>Multi-VGA output support: Mini DisplayPort/HDMI/DVI-D/VGA port</p> <p>Supports DisplayPort 1.2* with max. resolution 4096 x 2160 @24Hz and 3840 x 2160 @60Hz</p> <p>Supports HDMI with max. resolution of 4096 x 2160 @24Hz and 2560 x 1600 @60Hz</p> <p>Supports DVI with max. resolution of 1920 x 1200 @60Hz</p> <p>Supports RGB with max. resolution of 1920 x 1200 @60Hz</p> <p>Supports Intel® InTru™ 3D, Intel® Quick Sync Video, Intel® Clear Video HD Technology, and Intel® Insider™</p> <p>Supports up to three displays simultaneously</p> <p>Maximum shared memory 1024MB</p> <p>* DisplayPort 1.2 Multi-Stream Transport compliant, supports DisplayPort 1.2 monitor daisy chain up to 3 displays.</p>
Multi-GPU support	<p>Supports NVIDIA® Quad-GPU SLI™ Technology (with 2 PCIe x16 graphics cards)</p> <p>Supports AMD® Quad-GPU CrossFireX™ Technology</p>
LAN	Intel® I217-V Gigabit LAN - Dual interconnect between the integrated LAN controller and physical layer (PHY)

(continued on the next page)

Z87-PLUS specifications summary

Storage	<p>Intel® Z87 Express Chipset with RAID 0, 1, 5, 10</p> <ul style="list-style-type: none"> - 6 x SATA 6.0 Gb/s ports (yellow) - Supports Intel® Dynamic Storage Accelerator, Intel® Smart Response Technology, Intel® Rapid Start Technology, Intel® Smart Connect Technology* <p>ASMedia® SATA 6Gb/s controller**</p> <ul style="list-style-type: none"> - 2 x SATA 6Gb/s ports (dark brown) <p>* Supports on Intel® Core™ processor family.</p> <p>** These SATA ports are for data hard drives only. ATAPI devices are not supported.</p>
Audio	<p>Realtek® ALC892 8-channel high definition audio CODEC</p> <ul style="list-style-type: none"> - Absolute Pitch 192khz/24bit True BD Lossless Sound - BD audio layer content protection - DTS UltraPC II - DTS Connect - Supports jack-detection, multi-streaming and front panel jack-retasking - Optical S/PDIF out ports at rear I/O
USB	<p>Intel® Z87 Express Chipset - supports ASUS USB 3.0 Boost</p> <ul style="list-style-type: none"> - 2 x USB 3.0/2.0 ports at mid-board for front panel support - 2 x USB 3.0/2.0 ports at rear panel (blue) - 8 x USB 2.0/1.1 ports at mid-board <p>ASMedia® USB 3.0 controller - supports ASUS USB 3.0 Boost</p> <ul style="list-style-type: none"> - 4 x USB 3.0/2.0 ports at rear panel (blue)
ASUS Exclusive features	<p>ASUS Dual Intelligent Processors 4 with 4-Way Optimization</p> <ul style="list-style-type: none"> - 4-Way Optimization tuning key perfectly consolidates ASUS-exclusive DIGI+Power Control, TPU, EPU, and Fan Xpert 2 that quickly optimize the digital power setting, system performance, power saving and whole system cooling configuration with just a click. <p>CPU Power</p> <ul style="list-style-type: none"> - Industry leading digital 8-phase power design - ASUS CPU power utility <p>DRAM Power</p> <ul style="list-style-type: none"> - Industry leading digital 2-phase DRAM power design - ASUS DRAM power utility <p>ASUS EPU</p> <ul style="list-style-type: none"> - EPU, EPU switch

(continued on the next page)

Z87-PLUS specifications summary

ASUS Exclusive features

ASUS TPU

- Auto Tuning, TurboV, GPU Boost, TPU switch

ASUS Fan Xpert 2

- Featuring Fan Auto Tuning function for optimized speed control.

ASUS Remote GO!

- Remote GO! functions: Cloud GO!, DLNA Media Hub, Remote Desktop, **File Transfer**
- "Wi-Fi GO! & NFC Remote" for portable Smartphone/Tablet, supporting iOS and Android systems.

ASUS Exclusive Features:

- Network iControl featuring instant network bandwidth domination for top network program in use
- USB 3.0 Boost featuring speedy USB 3.0 transmission
- USB Charger+ featuring quick-charging function for all smart devices
- Ai Charger+
- Disk Unlocker
- AI Suite 3
- Anti Surge
- MemOK!

ASUS Quiet Thermal Solution:

- ASUS Fan Xpert 2
- ASUS Fanless Design: Heat-sink solution

ASUS EZ DIY

- ASUS USB BIOS Flashback with USB BIOS Flashback Wizard for EZ BIOS download scheduling
- ASUS UEFI BIOS EZ Mode featuring friendly graphics user interface
- ASUS O.C. Tuner
- ASUS CrashFree BIOS 3
- ASUS EZ Flash 2

ASUS Q-Design

- ASUS Q-LED (CPU, DRAM, VGA, Boot Device LED)
- ASUS Q-Slot
- ASUS Q-DIMM
- ASUS Q-Connector

(continued on the next page)

Z87-PLUS specifications summary

ASUS exclusive overlocking features	Precision Tweaker 2 <ul style="list-style-type: none">- vCore: Adjustable CPU Core voltage at 0.001V increment- iGPU: Adjustable CPU Graphics voltage at 0.001V increment- vCCIO: Adjustable Analog and Digital I/O voltage at 0.001V increment- vCCIN: Adjustable CPU Input voltage at 0.01V increment- vCCSA: Adjustable CPU System Agent voltage at 0.001V increment- vDRAM Bus: Adjustable DRAM voltage control at 0.005V increment- vPCH: Adjustable PCH voltage control at 0.0125 increment SFS (Stepless Frequency Selection) <ul style="list-style-type: none">- BCLK/PCIE frequency tuning from 80MHz up to 300MHz at 0.1MHz increment Overclocking Protection <ul style="list-style-type: none">- ASUS C.P.R.(CPU Parameter Recall)
Rear Panel I/O Ports	1 x PS/2 Keyboard/mouse combo port 1 x Mini DisplayPort 1 x HDMI port 1 x DVI 1 x RGB 1 x Optical S/PDIF Out port 1 x LAN (RJ-45) port 6 x USB 3.0/2.0 ports (blue, 1 supports USB BIOS Flashback) 8-channel Audio I/O ports
Internal I/O connectors	1 x 19-pin USB 3.0/2.0 connector supports additional 2 USB ports 4 x USB 2.0/1.1 connectors support additional 8 USB ports 8 x SATA 6.0 Gb/s connectors (6 x yellow; 2 x dark brown) 1 x 4-pin CPU Fan connector supports both 3-pin (DC mode) and 4-pin (PWM mode) CPU coolers control 1 x 4-pin CPU Optional Fan connector (CPU_OPT) 4 x 4-pin Chassis Fan connectors 1 x Front panel audio connector (AAFP) 1 x S/PDIF out header 1 x Serial (COM) port connector 1 x TPM connector 1 x 24-pin EATX Power connector 1 x 8-pin EATX 12V Power connector System Panel (Q-Connector) 1 x MemOK! button 1 x Clear CMOS jumper

(continued on the next page)

Z87-PLUS specifications summary



Internal I/O connectors	1 x DirectKey button 1 x DRCT (DirectKey) connector 1 x BIOS Flashback button 1 x EPU switch 1 x TPU switch (advanced two-stage adjustments) 1 x Power-on switch
BIOS features	64 Mb Flash ROM, UEFI AMI BIOS, PnP, DMI2.7, WfM2.0, SM BIOS 2.7, ACPI 5.0, Multi-language BIOS, ASUS EZ Flash 2, ASUS CrashFree BIOS 3, My Favorites, Quick Note, Last Modified log, F12 PrintScreen, F3 Shortcut functions, and ASUS DRAM SPD (Serial Presence Detect) memory information
Manageability	WfM 2.0, DMI 2.7, WOL by PME, PXE
Support DVD contents	Drivers ASUS Utilities EZ Update Anti-virus software (OEM version)
Form factor	ATX form factor: 12 in. x 9.2 in. (30.5 cm x 23.37 cm)



Specifications are subject to change without notice.

Package contents

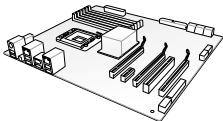
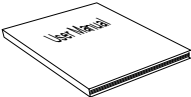
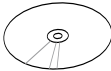
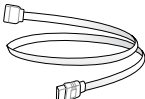

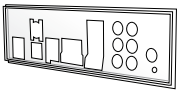
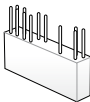
Check your motherboard package for the following items

		
ASUS Z87-PLUS motherboard	User manual	Support DVD
		
3 x Serial ATA 6.0 Gb/s cables	1 x ASUS SLI™ bridge connector	1 x ASUS I/O Shield
		
1 x 2-in-1 ASUS Q-Connector kit		

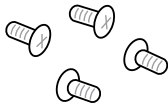

- If any of the above items is damaged or missing, contact your retailer.
- The illustrated items above are for reference only. Actual product specifications may vary with different models.
- The 1 x 2-in-1 ASUS Q-Connector kit is for retailer version only.

Installation tools and components

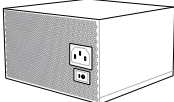
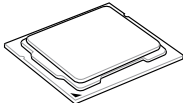
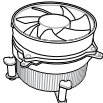
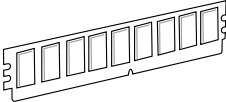
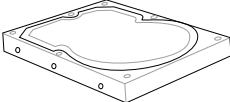
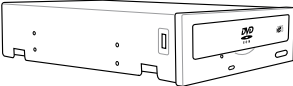
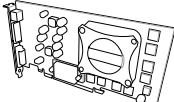
	
<p>1 bag of screws</p>	<p>Phillips (cross) screwdriver</p>
	
<p>PC chassis</p>	<p>Power supply unit</p>
	
<p>Intel® LGA1150 CPU</p>	<p>Intel® LGA1150 compatible CPU Fan</p>
	
<p>DIMM</p>	<p>SATA hard disk drive</p>
	
<p>SATA optical disc drive (optional)</p>	<p>Graphics card (optional)</p>



The tools and components in the table above are not included in the motherboard package.

Product introduction

1

1.1 Special features

1.1.1 Product highlights

LGA1150 socket for 4th generation Intel® Core™ i7/Intel® Core™ i5/Intel® Core™ i3, Pentium® and Celeron® processors

This motherboard supports 4th generation Intel® Core™ i7/Intel® Core™ i5/Intel® Core™ i3, Pentium®, and Celeron® processors in the LGA1150 package. It provides great graphics and system performance with its GPU, dual-channel DDR3 memory slots and PCI Express 2.0/3.0 expansion slots.

Intel® Z87 Express Chipset

Intel® Z87 Express Chipset is a single chipset that supports the LGA1150 socket for 4th generation Intel® Core™ i7/Intel® Core™ i5/Intel® Core™ i3, Pentium® and Celeron® processors. It utilizes the serial point-to-point links, which increases bandwidth and enhances the system's performance. It natively supports up to six USB 3.0 ports for up to ten times faster transfer rate than USB 2.0 and enables the iGPU function for Intel® integrated graphics performance.

PCI Express® 3.0

PCI Express® 3.0 (PCIe 3.0) is the PCI Express bus standard that provides twice the performance and speed of PCIe 2.0. It provides an optimal graphics performance, unprecedented data speed and seamless transition with its complete backward compatibility to PCIe 1.0/2.0 devices.

Dual-Channel DDR3 2800 (O.C.) / 2666 (O.C.) / 2600 (O.C.) / 2500 (O.C.) / 2400 (O.C.) / 2200 (O.C.) / 2133 (OC.) / 2000 (O.C.) / 1866 (O.C.) / 1800 (O.C.) / 1600 (O.C.) / 1333 MHz Support

The motherboard supports the dual-channel DDR3 memory that features data transfer rates of DDR3 2800 (O.C.) / 2666 (O.C.) / 2600 (O.C.) / 2500 (O.C.) / 2400 (O.C.) / 2200 (O.C.) / 2133 (OC.) / 2000 (O.C.) / 1866 (O.C.) / 1800 (O.C.) / 1600 / 1333 MHz to boost the system's performance, and to meet the higher bandwidth requirements of 3D graphics, multimedia and Internet applications.

Quad-GPU SLI and CrossFireX™ Support

This motherboard features the most powerful Intel® Z87 platform that optimizes PCIe allocation in multi-GPU SLI and CrossFireX™ solution, giving you a brand-new gaming enjoyment.

Intel® Smart Response Technology

Intel® Smart Response Technology, an important part of Green ASUS eco-friendly computing, reduces load and wait time, eliminates unnecessary hard drive spin thus lowering power usage, and uses an installed SSD (requires 18.6 GB available space) as a cache for frequently accessed data or applications. It combines SSD performance and hard drive capacity, operating up to six times faster than a hard-drive-only system to boost the system's overall performance.

* 4th Generation Intel® Core™ processors family support Intel® Smart Response Technology.

** An operating system must be installed on the HDD to launch Intel® Smart Response Technology.

*** The SSD is reserved for caching function.

Intel® Smart Connect Technology

Your computer can receive fresh updates for selected applications, even when the system is in sleep mode. This means less time waiting for applications to update and sync with the cloud, leading to a more efficient computing experience.

Intel® Rapid Start Technology

Allows your computer to quickly resume from a low-power hibernate state in seconds. Saving your system memory to the designated SSDs, it provides your computer a faster wake-up response time, while still keeping the energy use low.

1.1.2 Dual Intelligent Processors 4 with 4-Way Optimization

ASUS Dual Intelligent Processors 4 brings system control solution to a totally whole new level, combining TPU, EPU, DIGI+ Power Control and Fan Xpert 2 functions to push the system's performance to its optimal potential. It automatically pushes or reasonably balances the system's performance, power saving levels and fan settings via the user-friendly AI Suite 3 utility.

DIGI+ Power Control

ASUS DIGI+ Power Control features the revolutionary and innovative digital VRM, DRAM, and CPU Voltage controllers. These controllers offers ultra-precise memory and voltage tuning for optimal system efficiency, stability and performance.

TPU

TPU (Turbo Processing Unit), offers precise voltage control and advanced monitoring mechanisms through the Auto Tuning and TurboV functions in your ASUS AI Suite 3 utility.

EPU

EPU (Energy Processing Unit), the world's first real-time system power-saving chip, automatically detects the current system load and intelligently moderates power usage. It offers a total system-wide energy optimization, reduces fan noise and extends the component's lifespan.

ASUS Fan Xpert 2

ASUS Fan Xpert 2 provides customizable settings for a cooler and quieter computing environment. With its Fan Auto Tuning feature, ASUS Fan Xpert 2 automatically detects and tweaks all fan speeds, and provides you with optimized fan settings based on the fans' specifications and positions.

1.1.3 ASUS Exclusive Features

Remote GO!

ASUS Remote GO! leads the way to a more enjoyable home entertainment. With ASUS Remote GO!, you can stream media files to DLNA devices, remotely control and access your computer using your smart device.

Conveniently use and enjoy these ASUS Remote GO! functions:

- **Cloud GO!:** Allows you to control files and sync them all across cloud services in a few clicks.
- **DLNA Media Hub:** Provides support to the latest DLNA standard and allows you to stream media files to a DLNA-supported device.
- **Remote Desktop:** Allows you to view your computer's desktop and remotely operate your computer in real-time from your smart device.
- **File Transfer:** Allows you to transfer files between your computer and smart device.



Download APP "Wi-Fi GO! & NFC Remote" from app store and Google Market.

GPU Boost

GPU Boost accelerates the integrated GPU for extreme graphics performance, facilitates flexible frequency adjustments and easily delivers stable system-level upgrades for every use.

USB 3.0 Boost

ASUS USB 3.0 Boost, which supports USB 3.0 standard UASP (USB Attached SCSI Protocol), significantly increases a USB device's transfer speed up to 170% faster than the already impressive USB 3.0 transfer speed. It automatically accelerates data speeds for compatible USB 3.0 peripherals without the need for any user interaction.

USB Charger+

With a dedicated onboard controller, quick-charge all your smart devices such as smartphones, tablets and more, all up to three times faster, even when the system is powered off, in sleep or hibernation mode.

USB BIOS Flashback

USB BIOS Flashback offers a hassle-free updating solution for your ultimate convenience. Install a USB storage device containing the BIOS file, press the BIOS Flashback button for about three seconds, and the UEFI BIOS is automatically updated even without entering the existing BIOS or operating system. It also allows you to regularly check for UEFI BIOS updates, and download the latest BIOS automatically.

Network iControl

Network iControl is an intuitive one-step network control center that makes it easier for you to manage your bandwidth and allows you to set, monitor and schedule the bandwidth priorities for your network programs.

AI Suite 3

With its user-friendly interface, ASUS AI Suite 3 consolidates all the exclusive ASUS features into one simple-to-use software package. It allows you to supervise overclocking, energy management, fan speed control, voltage and sensor readings, and even interact with smart devices via Wi-Fi. This all-in-one software offers diverse and ease to use functions, with no need to switch back and forth between different utilities.

MemOK!

MemOK!, the remarkable memory rescue tool, allows you to simply press a button to patch memory issues, ensure memory boot compatibility, determine fail-safe settings, and dramatically improve the system's bootup.

1.1.4 ASUS Quiet Thermal Solution

ASUS Fanless Design - Heat-sink solution

The stylish heatsink features a 0-dB thermal solution that offers you a noiseless PC environment. The heatsink design also lowers the temperature of the chipset and power phase area through high efficient heat-exchange. Combined with usability and aesthetics, the ASUS stylish heatsink will give you an extremely silent and cooling experience with its elegant appearance.

1.1.5 ASUS EZ DIY

ASUS UEFI BIOS (EZ Mode)

ASUS UEFI BIOS, a UEFI compliant architecture, offers the first mouse-controlled intuitive graphical BIOS interface that goes beyond the traditional keyboard-only BIOS controls, providing you with more flexibility, convenience, and easy to navigate UEFI BIOS than the traditional BIOS versions. It offers you with dual selectable modes and native support for hard drives larger than 2.2 TB.

ASUS UEFI BIOS includes the following new features:

- New My Favorite function allows you to quickly access the frequently used items
- New Quick Note function allows you to take notes in the BIOS environment
- New log reminder allows you to view all your modified settings
- F12 BIOS snapshot hotkey
- F3 Shortcut for most accessed information
- ASUS DRAM SPD (Serial Presence Detect) information detecting faulty DIMMs, and helping with difficult POST situations.

ASUS Q-connector

ASUS Q-Connector is a unique adapter that allows you to easily connect or disconnect the chassis front panel cables to one module, eliminating the hassle of plugging one cable at a time and making the connection quick and accurate.

1.1.6 Other special features

Mini DisplayPort Support

Mini DisplayPort is a digital display interface standard that delivers up to 10.8 Gbps of bandwidth over standard cables, providing billions of colors and bi-directional communications, thus enabling the fastest refresh rates, and the highest resolution digital display through a single cable. Also, it supports HDCP copy protection for Blu-ray discs. Simply output 3D signals through the connected DisplayPort cable with your 3D display, then you can sit back and enjoy a perfect 3D animation experience.

HDMI Support

High Definition Multimedia Surface (HDMI) is a set of digital video standards that delivers multi-channel audio and uncompressed digital video up to 4K/2K resolution visuals through a single cable. Supporting HDCP copy protection such as HD DVD and blu-ray discs, HDMI provides you with the highest quality home theater experience.

DTS Connect

To get the most out of your audio entertainment across all formats and quality levels, DTS Connect combines two enabling technologies, DTS Neo:PC™ upmixes stereo sources (CDs, MP3s, WMAs, internet radio) into as many as 7.1 channels of incredible surround sound. Consumers can connect their PC to a home theater system. DTS Interactive is capable of performing multi-channel encoding of DTS bitstreams on personal computers, and sending encoded bitstreams out of a digital audio connection (such as S/PDIF or HDMI) designed to deliver audio to an external decoder.

DTS UltraPC II

DTS UltraPC II delivers a superior surround sound experience through your system's speakers and headphones while monitoring and balancing the loudness level difference between digital audio formats. It also enhances the audio settings through augmenting low and high frequencies of musical tones, restores compressed or re-mastered sounds, improves bass performance even without a subwoofer, and improves dialogues derived from DVD or Blu-ray Disc™.

ErP Ready

The motherboard is European Union's Energy-related Products (ErP) ready, and ErP requires products to meet certain energy efficiency requirement in regards to energy consumptions. This is in line with ASUS vision of creating environment-friendly and energy-efficient products through product design and innovation to reduce carbon footprint of the product and thus mitigate environmental impacts.

1.2 Motherboard overview

1.2.1 Before you proceed

Take note of the following precautions before you install motherboard components or change any motherboard settings.



-
- Unplug the power cord from the wall socket before touching any component.
 - Before handling components, use a grounded wrist strap or touch a safely grounded object or a metal object, such as the power supply case, to avoid damaging them due to static electricity.
 - Hold components by the edges to avoid touching the ICs on them.
 - Whenever you uninstall any component, place it on a grounded antistatic pad or in the bag that came with the component.
 - Before you install or remove any component, ensure that the ATX power supply is switched off or the power cord is detached from the power supply. Failure to do so may cause severe damage to the motherboard, peripherals, or components.
-

1.2.2 Motherboard layout

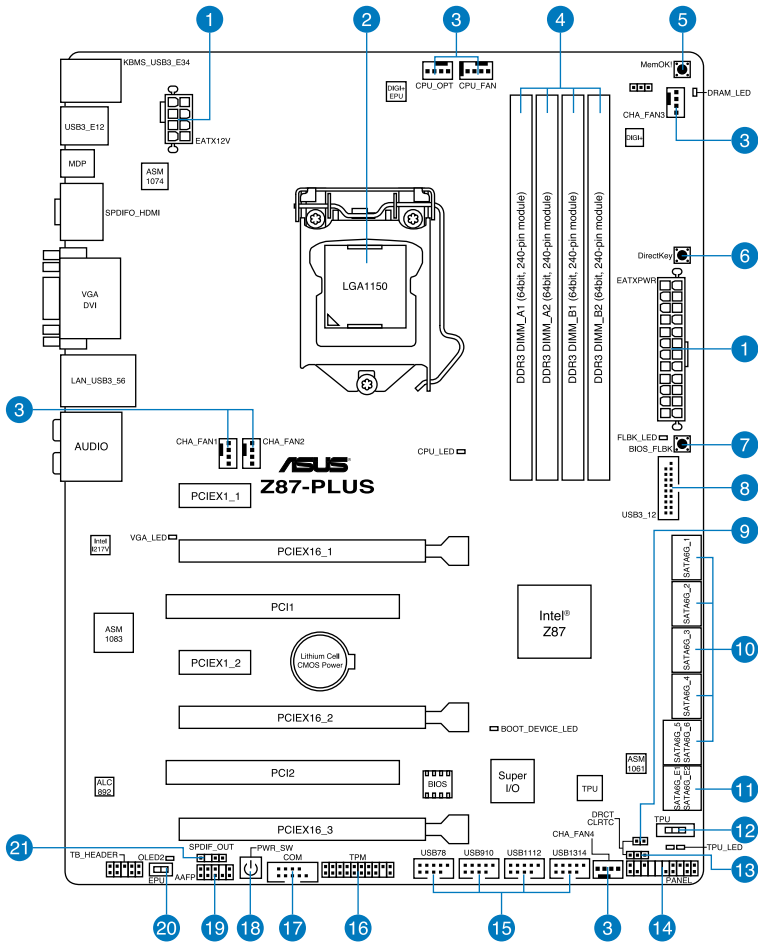

Refer to **1.2.8 Internal connectors** and **2.3.1 Rear I/O connection** for more information about rear panel connectors and internal connectors.

Layout contents

Connectors/Jumpers/Slots	Page
1. ATX power connectors (24-pin EATXPWR, 8-pin EATX12V)	1-40
2. LGA1150 CPU socket	1-9
3. CPU, chassis, and power fan connectors (4-pin CPU_FAN, 4-pin CPU_OPT, 4-pin CHA_FAN1-4)	1-38
4. DDR3 DIMM slots	1-10
5. MemOK! button	1-27
6. DirectKey button	1-28
7. BIOS_FLBK button	2-11
8. USB 3.0 connector (20-1 pin USB3_12)	1-35
9. Direct connector (2-pin DRCT)	1-43
10. Intel® Z87 Serial ATA 6.0 Gb/s connectors (7-pin SATA6G_1-6 [yellow])	1-34
11. ASMedia® Serial ATA 6.0 Gb/s connectors (7-pin SATA6G_E12 [dark brown])	1-35
12. TPU switch	1-29
13. Clear CMOS jumper	1-31
14. System panel connector (20-8 pin PANEL)	1-42
15. USB 2.0 connectors (10-1 pin USB78, USB910, USB1112, USB1314)	1-37
16. TPM connector (20-1 pin TPM)	1-43
17. Serial port connector (10-1 pin COM)	1-39
18. Power-on button	1-26
19. Front panel audio connector (10-1 pin AAFP)	1-39
20. EPU switch	1-30
21. Digital audio connector (4-1 pin SPDIF_OUT)	1-36

1.2.3 Central Processing Unit (CPU)

The motherboard comes with a surface mount LGA1150 socket designed for the 4th Generation Intel® Core™ i7 / Intel® Core™ i5 / Intel® Core™ i3, Pentium® and Celeron® processors.

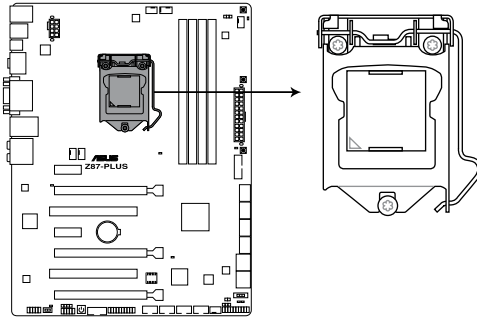

Z87-PLUS CPU LGA1150



- Ensure that all power cables are unplugged before installing the CPU.
- Ensure that you install the correct CPU designed for LGA1150 only. DO NOT install a CPU designed for LGA1155 and LGA1156 sockets on the LGA1150 socket.
- Upon purchase of the motherboard, ensure that the PnP cap is on the socket and the socket contacts are not bent. Contact your retailer immediately if the PnP cap is missing, or if you see any damage to the PnP cap/socket contacts/motherboard components. ASUS will shoulder the cost of repair only if the damage is shipment/transit-related.
- Keep the cap after installing the motherboard. ASUS will process Return Merchandise Authorization (RMA) requests only if the motherboard comes with the cap on the LGA1150 socket.
- The product warranty does not cover damage to the socket contacts resulting from incorrect CPU installation/removal, or misplacement/loss/incorrect removal of the PnP cap.

1.2.4 System memory

The motherboard comes with four Double Data Rate 3 (DDR3) Dual Inline Memory Modules (DIMM) slots.



A DDR3 module is notched differently from a DDR or DDR2 module. DO NOT install a DDR or DDR2 memory module to the DDR3 slot.

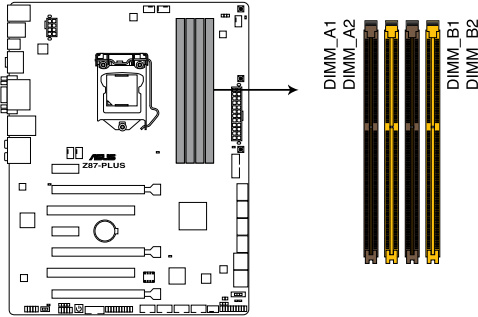

Z87-PLUS 240-pin DDR3 DIMM socket

Recommended memory configurations

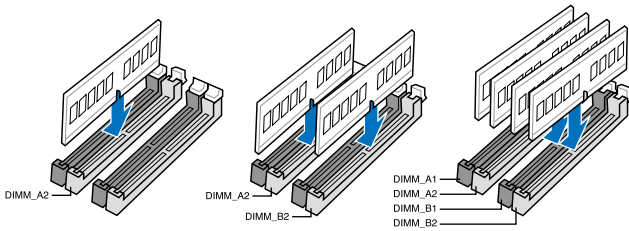

Memory configurations

You may install 2GB, 4GB and 8GB unbuffered and non-ECC DDR3 DIMMs into the DIMM sockets.



-
- You may install varying memory sizes in Channel A and Channel B. The system maps the total size of the lower-sized channel for the dual-channel configuration. Any excess memory from the higher-sized channel is then mapped for single-channel operation.
 - According to Intel® CPU spec, DIMM voltage below 1.65V is recommended to protect the CPU.
 - Always install DIMMs with the same CAS latency. For optimum compatibility, we recommend that you obtain memory modules from the same vendor.
 - Due to the memory address limitation on 32-bit Windows® OS, when you install 4GB or more memory on the motherboard, the actual usable memory for the OS can be about 3GB or less. For effective use of memory, we recommend that you do any of the following:
 - a) Use a maximum of 3GB system memory if you are using a 32-bit Windows® OS.
 - b) Install a 64-bit Windows® OS when you want to install 4GB or more on the motherboard.
 - c) For more details, refer to the Microsoft® support site at <http://support.microsoft.com/kb/929605/en-us>.
 - This motherboard does not support DIMMs made up of 512Mb (64MB) chips or less (Memory chip capacity counts in Megabit, 8 Megabit/Mb = 1 Megabyte/MB).
-



-
- The default memory operation frequency is dependent on its Serial Presence Detect (SPD), which is the standard way of accessing information from a memory module. Under the default state, some memory modules for overclocking may operate at a lower frequency than the vendor-marked value. To operate at the vendor-marked or at a higher frequency, refer to section **3.5 Ai Tweaker menu** for manual memory frequency adjustment.
 - For system stability, use a more efficient memory cooling system to support a full memory load (4 DIMMs) or overclocking condition.
 - Memory modules with memory frequency higher than 2133MHz and their corresponding timing or the loaded XMP profile is not the JEDEC memory standard. The stability and compatibility of the memory modules depend on the CPU's capabilities and other installed devices.
 - Always install the DIMMS with the same CAS Latency. For an optimum compatibility, we recommend that you install memory modules of the same version or data code (D/C) from the same vendor. Check with the vendor to get the correct memory modules.
-

Z87-PLUS Motherboard Qualified Vendors Lists (QVL)

DDR3 2800(O.C.) MHz capability

Vendors	Part No.	Size	SS/DS	Chip Brand	Chip NO.	Timing	Voltage	DIMM socket support (Optional)		
								1	2	4
G.SKILL	F3-2800C11Q-16GTXD(XMP)	16GB (4x4GB)	DS	-	-	11-13-13-35	1.65	*	*	*
G.SKILL	F3-2800C12Q-32GTXD(XMP)	32GB (4x8GB)	DS	-	-	12-13-13-35	1.65	*	*	*
G.SKILL	F3-2800C12Q-32GTXDG(XMP)	32GB (4x8GB)	DS	-	-	12-14-14-35	1.65	*	*	*
APACER	78.BAGH5.AFD0C	8GB (2x4GB)	DS	-	-	12-14-14-35	1.65	*	*	*
APACER	78.CAGH6.AFD0C	16GB (2x8GB)	DS	-	-	12-14-14-35	1.65	*	*	*
CORSAIR	CMD16GX3M4A2800C11	16GB (4x4GB)	DS	-	-	11-14-14-35	1.65	*	*	*
CORSAIR	CMD16GX3M4A2800C12	16GB (4x4GB)	DS	-	-	12-14-14-36	1.65	*	*	*

DDR3 2666(O.C.) MHz capability

Vendors	Part No.	Size	SS/DS	Chip Brand	Chip NO.	Timing	Voltage	DIMM socket support (Optional)		
								1	2	4
APACER	78.BAGFF.AFC0C	16GB (4x4GB)	SS	-	-	12-13-13-35	1.65	*	*	*
APACER	78.CAGFF.AFD0C	32GB (4x8GB)	DS	-	-	12-13-13-35	1.65	*	*	*
CORSAIR	CMD16GX3M4A2666C11	16GB (4x4GB)	DS	-	-	11-13-13-35	1.65	*	*	*
G.SKILL	F3-2666C11Q-16GTXD(XMP)	16GB (4x4GB)	DS	-	-	11-13-13-35	1.65	*	*	*
G.SKILL	F3-2666C10Q-16GTXD(XMP)	16GB (4x4GB)	DS	-	-	10-12-12-31	1.65	*	*	*
GEIL	GOC332GB2666C11QC(XMP)	32GB (4x8GB)	DS	-	-	11-13-13-35	1.65	*	*	*
TEAM	TXD34G2666HC11CBK	8GB (2x4GB)	SS	-	-	11-13-13-35	1.65	*	*	*
TEAM	TXD38G2666HC11CBK	16GB (2x8GB)	DS	-	-	11-13-13-35	1.65	*	*	*
G.SKILL	F3-2666CL10Q-16GBZHD(XMP)	16GB (4x4GB)	DS	-	-	9-11-9-27	1.65	*	*	*

DDR3 2600(O.C.) MHz capability

Vendors	Part No.	Size	SS/DS	Chip Brand	Chip NO.	Timing	Voltage	DIMM socket support (Optional)		
								1	2	4
ADATA	AX3U2600GW8G11-DG2	16GB (2x4GB)	DS	-	-	11-13-13-35	1.65V	*	*	*

DDR3 2500(O.C.) MHz capability

Vendors	Part No.	Size	SS/DS	Chip Brand	Chip NO.	Timing	Voltage	DIMM socket support (Optional)		
								1	2	4
G.SKILL	F3-2000CL10Q-16GBZHD(XMP)	16GB (4x4GB)	DS	-	-	10-11-11-31	1.65	*	*	*

DDR3 2400(O.C.) MHz capability

Vendors	Part No.	Size	SS/DS	Chip Brand	Chip NO.	Timing	Voltage	DIMM socket support (Optional)		
								1	2	4
A-DATA	AX3U2400GC4G10(XMP)	4GB	DS	-	-	10-12-12-31	1.65	*	*	*
Apacer	78.BAGFL.AFD0C(XMP)	8GB (2x4GB)	DS	-	-	11-12-12-30	-	*	*	*
Apacer	783BAGF3.AFD0C(XMP)	8GB (2x4GB)	DS	-	-	11-11-11-30	-	*	*	*
CORSAIR	CMGTX8(XMP)	8GB (4x2GB)	SS	-	-	10-12-10-30	1.65	*	*	*
CORSAIR	CMZ16GX3M2A2400C10 (Ver4.21)	16GB (2x8GB)	DS	-	-	10-12-12-31	1.65	*	*	*
CORSAIR	CMZ16GX3M4A2400C9R (Ver4.13)(XMP)	16GB (4x4GB)	DS	-	-	2400 9-11-11-31	1.65	*	*	*
G.SKILL	F3-1920CL10Q-32GBZHD(XMP)	32GB (4x8GB)	DS	-	-	10-12-12-31	1.65	*	*	*
G.SKILL	F3-1920CL11Q-16GBZHD(XMP)	16GB (4x4GB)	DS	-	-	11-11-11-31	1.65	*	*	*
G.SKILL	F3-1920CL11Q-16GBZHD(XMP)	16GB (4x4GB)	DS	-	-	11-11-11-31	1.65	*	*	*
G.SKILL	F3-1920CL9D-4GBPIS(XMP)	4G (2x2GB)	DS	-	-	9-11-9-28	1.65	*	*	*
G.SKILL	F3-1920CL9Q-16GBZMD(XMP)	16GB (4x4GB)	DS	-	-	9-11-11-31	1.65	*	*	*
GEIL	GOC316GB2400 C10QC(XMP)	16GB (4x4GB)	DS	-	-	10-11-11-30	1.65	*	*	*
GEIL	GOC316GB2400 C11QC(XMP)	16GB (4x4GB)	DS	-	-	11-11-11-30	1.65	*	*	*
Kingston	KHX2400C11D3 K4/8GX(XMP)	8GB (4x2GB)	SS	-	-	11-13-11-30	1.65	*	*	*
KINGSTON	KHX24C11K4/16X(XMP)	16GB (4x4GB)	DS	-	-	11-13-13-30	1.65	*	*	*
KINGSTON	KHX24C11T2K2/8X(XMP)	8GB (2x4GB)	DS	-	-	-	1.65	*	*	*
KINGSTON	KHX24C11T3K4/32X(XMP)	32GB (4x8GB)	DS	-	-	9-9-9-24	1.65	*	*	*
Patriot	PVV34G2400C 9K(XMP)	4GB (2x2GB)	DS	-	-	9-11-9-27	1.66	*	*	*
Patriot	PXD38G2400C 11K(XMP)	8GB (2x4GB)	DS	-	-	11-11-11-30	1.65	*	*	*
Patriot	PXD38G2400C 11K(XMP)	8GB (2x4GB)	DS	-	-	2400 11-11-11-30	1.65	*	*	*
Team	TXD38G2400HC 10QBK(XMP)	8GB	DS	-	-	10-12-12-31	1.65	*	*	*

DDR3 2200(O.C.) MHz capability

Vendors	Part No.	Size	SS/DS	Chip Brand	Chip NO.	Timing	Voltage	DIMM socket support (Optional)		
								1	2	4
G.SKILL	F3-17600CL7D-4GBFLS(XMP)	4GB (2x2GB)	DS	-	-	7-10-10-28	1.65	*	*	*
GEIL	GET34GB2200C9DC(XMP)	4GB (2x2GB)	DS	-	-	9-10-9-28	1.65	*	*	*
GEIL	GET38GB2200C9ADC(XMP)	8GB (2x4GB)	DS	-	-	9-11-9-28	1.65	*	*	*

DDR3 2133(O.C.) MHz capability

Vendors	Part No.	Size	SS/ DS	Chip Brand	Chip NO.	Timing	Voltage	DIMM socket support (Optional)			
								1	2	4	
A-DATA	AX3U2133XC4G10(XMP)	4GB	DS	-	-	10-11-11-30	1.65	*	*	*	
A-DATA	AX3U2133XW8G10(XMP)	8GB	DS	-	-	10-11-11-30	1.65	*	*	*	
Apacer	78.BAGE4.AFD0C(XMP)	8GB (2x4GB)	DS	-	-	9-9-9-24	-	*	*	*	
Apacer	AHU04GFB33CAQ3R(XMP)	4GB	DS	-	-	11-13-13-31	-	*	*	*	
CORSAIR	CMD8GX3M2A2133C9 (Ver1.5)(XMP)	8GB (2x4GB)	DS	-	-	9-11-10-27	1.5	*	*	*	
CORSAIR	CMT4GX3M2B2133C9(Ver 7.1)(XMP)	4GB (2x2GB)	DS	-	-	9-10-9-27	1.5	*	*	*	
CORSAIR	CMT4GX3M2B2133C9(XMP)	4GB (2x2GB)	DS	-	-	9-10-9-27	1.5	*	*	*	
G.SKILL	F3-17000CL11Q2- 64GBZLD(XMP)	64GB (8x8GB)	DS	-	-	11-11-11-30	1.5	*	*	*	
G.SKILL	F3-17000CL9Q- 16GBXLD(XMP)	16GB (4x4GB)	DS	-	-	9-11-9-28	1.65	*	*	*	
G.SKILL	F3-17000CL9Q- 16GBZH(XMP)	16GB (4x4GB)	DS	-	-	9-11-10-28	1.65	*	*	*	
G.SKILL	F3-17066CL9D- 8GBPID(XMP)	8GB (2x4GB)	DS	-	-	9-9-9-24	1.65	*	*	*	
G.SKILL	F3-17066CL9Q- 16GBTDD(XMP)	16GB (4x4GB)	DS	-	-	9-9-9-24	1.65	*	*	*	
G.SKILL	F3-2133C11Q-32GZL(XMP)	32GB (4x8GB)	DS	-	-	11-11-11-31	1.5	*	*	*	
KINGSTON	KHX2133C11D3K4/ 16GX(XMP)	16GB (4x4GB)	DS	-	-	11-12-11-30	1.65	*	*	*	
KINGSTON	KHX2133C11D3T1K2/ 16GX(XMP)	16GB (2x8GB)	DS	-	-	9-9-9-24	1.6	*	*	*	
KINGSTON	KHX21C11T3FK8/64X(XMP)	64GB (8x8GB)	DS	-	-	9-9-9-24	1.5	*	*	*	
OCZ	OCZ3XTEP2133C 9LV4GK	2GB	DS	-	-	7-7-7-20	1.65	*	*	*	
Patriot	PV316G213C1K (XMP)	16GB (2x8GB)	DS	-	-	11-11-11-30	1.5	*	*	*	
Patriot	PVV34G2133C9 K(XMP)	4GB (2x2GB)	DS	-	-	9-11-9-27	1.66	*	*	*	
Patriot	PXD38G2133C1 1K(XMP)	8GB (2x4GB)	DS	-	-	9-9-9-24	1.65	*	*	*	
Patriot	PXD38G2133C11 K(XMP)	8GB (2x4GB)	DS	-	-	2133 11-11-11-27	1.5	*	*	*	
Team	TLD38G2133HC11A BK(XMP)	8GB	DS	-	-	11-11-11-31	1.65	*	*	*	
Team	TXD34096M2133HC11A- V(XMP)	4GB	DS	-	-	11-11-11-31	1.65	*	*	*	

DDR3 2000(O.C.) MHz capability

Vendors	Part No.	Size	SS/DS	Chip Brand	Chip NO.	Timing	Voltage	DIMM socket support (Optional)		
								1	2	4
AEXEA	AXA3E32G2000LG28V(XMP)	2GB	DS	-	-	-	1.65	*	*	*
AEXEA	AXA3E34GK2000LG28V(XMP)	4GB (2x2GB)	DS	-	-	-	1.65	*	*	*
Apacer	78.AAGD5.9KD(XMP)	6GB (3x2GB)	DS	-	-	9-9-9-27	-	*	*	*
Asint	SLA302G08-ML2HB(XMP)	4GB	DS	Hynix	H5TQ2G83BF RH9C	9-9-9-27	-	*	*	*
G.SKILL	F3-16000CL9D-4GBRH(XMP)	4GB (2x2GB)	DS	-	-	9-9-9-24	1.65	*	*	
G.SKILL	F3-16000CL9D-4GBTD(XMP)	4GB (2x2GB)	DS	-	-	9-9-9-24	1.65	*	*	
GEIL	GUP34GB2000C9DC(XMP)	4GB (2x2GB)	DS	-	-	9-9-9-28	1.65	*	*	*
Patriot	PV736G2000ELK(XMP)	6GB (3x2GB)	DS	-	-	7-7-7-20	1.65	*	*	*
Patriot	PX7312G2000ELK(XMP)	12GB (3x4GB)	DS	-	-	9-11-9-27	1.65	*	*	*
Silicon Power	SP002GBLYU200S02(XMP)	2GB	DS	-	-	-	-	*	*	*
Team	TXD32048M2000C9(XMP)	2GB	DS	Team	T3D1288RT-20	9-9-9-24	1.5	*	*	
Team	TXD32048M2000C9-L(XMP)	2GB	DS	Team	T3D1288LT-20	9-9-9-24	1.5	*	*	*
Team	TXD32048M2000C9-L(XMP)	2GB	DS	Team	T3D1288RT-20	9-9-9-24	1.6	*	*	

DDR3 1866(O.C.) MHz capability

Vendors	Part No.	Size	SS/DS	Chip Brand	Chip NO.	Timing	Voltage	DIMM socket support (Optional)		
								1	2	4
CORSAIR	CMD16GX3M2A1866C9 (Ver5.29)(XMP)	16GB (2x8GB)	DS	-	-	1866 9-9-9-27	1.5	*	*	
CORSAIR	CMD16GX3M4A1866C9 (Ver4.13)(XMP)	16GB (4x4GB)	DS	-	-	9-10-9-27	1.5	*	*	*
CORSAIR	CMD16GX3M4A1866C9 (Ver8.16)(XMP)	16GB (4x4GB)	DS	-	-	9-10-9-27	1.5	*	*	*
CORSAIR	CMD8GX3M2A1866C9 (Ver4.13)(XMP)	8GB (2x4GB)	DS	-	-	-	1.5	*	*	*
CORSAIR	CMD8GX3M2A1866C9 (Ver5.12)(XMP)	8GB (2x4GB)	DS	-	-	9-10-9-27	1.5	*	*	
CORSAIR	CMD8GX3M2A1866C9 (Ver8.16)(XMP)	8GB (2x4GB)	DS	-	-	9-10-9-27	1.5	*	*	
CORSAIR	CMT32GX3M4X1866C9(Ver3.23)(XMP)	32GB (4x8GB)	DS	-	-	9-10-9-27	1.5	*	*	*
CORSAIR	CMZ16GX3M4X1866C9R (Ver8.16)(XMP)	16GB (4x4GB)	DS	-	-	9-10-9-27	1.5	*	*	*
CORSAIR	CMZ16GX3M4X1866C9R(Ver 8.16)(XMP)	16GB (4x4GB)	DS	-	-	9-10-9-27	1.5	*	*	*
CORSAIR	CMZ32GX3M4X1866C10 (Ver3.23)(XMP)	32GB (4x8GB)	DS	-	-	10-11-10-27	1.5	*	*	*
CORSAIR	CMZ32GX3M4X1866C10(Ver 3.23)(XMP)	32GB (4x8GB)	DS	-	-	10-11-10-27	1.5	*	*	*
CORSAIR	CMZ8GX3M2A1866C9 (Ver8.16)(XMP)	8GB (2x4GB)	DS	-	-	9-10-9-27	1.5	*	*	*

(continued on the next page)

DDR3 1866(O.C.) MHz capability

Vendors	Part No.	Size	SS/DS	Chip Brand	Chip NO.	Timing	Voltage	DIMM socket support (Optional)		
								1	2	4
CORSAIR	CMZ8GX3M2A1866C9(XMP)	8GB (2x4GB)	DS	-	-	9-10-9-27	1.5	*	*	*
CORSAIR	CMZ8GX3M2A1866C9G (Ver5.12)(XMP)	8GB (2x4GB)	DS	-	-	1866 9-10-9-27	1.5	*	*	*
Crucial	BLE4G3D1869DE1XT0.16F MD(XMP)	4GB	DS	-	-	9-9-9-27	1.5	*	*	*
G.SKILL	F3-14900CL10Q2-64GBZLD(XMP)	64GB (8x8GB)	DS	-	-	10-11-10-30	1.5	*	*	*
G.SKILL	F3-14900CL9D-8GBSR(XMP)	8GB (2x4GB)	DS	-	-	9-10-9-28	1.5	*	*	*
G.SKILL	F3-14900CL9Q-16GBXL(XMP)	16GB (4x4GB)	DS	-	-	9-10-9-28	1.5	*	*	*
G.SKILL	F3-14900CL9Q-16GBZL(XMP)	16GB (4x4GB)	DS	-	-	9-10-9-28	1.5	*	*	*
G.SKILL	F3-14900CL9Q-8GBFLD(XMP)	8GB (2x4GB)	DS	-	-	9-9-9-24	1.6	*	*	*
G.SKILL	F3-1866C9Q-32GX(XMP)	32GB (4x8GB)	DS	-	-	9-10-9-28	1.5	*	*	*
KINGSTON	KHX1866C9D3K2@GX(XMP)	8GB (2x4GB)	DS	-	-	-	1.65	*	*	*
Patriot	PXD34G1866ELK(XMP)	4GB (2x2GB)	SS	-	-	9-9-9-24	1.65	*	*	*
Patriot	PXD38G1866ELK(XMP)	8GB (2x4GB)	DS	-	-	9-11-9-27	1.65	*	*	*
Patriot	PXD38G1866ELK(XMP)	8GB (2x4GB)	DS	-	-	9-11-9-27	1.65	*	*	*
Patriot	PXD38G1866ELK(XMP)	8GB (2x4GB)	DS	-	-	1866 9-10-9-27	1.5	*	*	*
Team	TLD34G1866HC9KBK(XMP)	4GB	DS	-	-	9-11-9-27	1.5	*	*	*
Team	TLD38G1866HC10SBK(XMP)	8GB	DS	-	-	10-11-10-30	1.5	*	*	*

DDR3 1800(O.C.) MHz capability

Vendors	Part No.	Size	SS/DS	Chip Brand	Chip NO.	Timing	Voltage	DIMM socket support (Optional)		
								1	2	4
G. SKILL	F3-14400CL9D-4GBRL(XMP)	4GB (2x2GB)	DS	-	-	9-9-9-24	1.6	*	*	*

DDR3 1600 MHz capability

Vendors	Part No.	Size	SS/DS	Chip Brand	Chip NO.	Timing	Voltage	DIMM socket support (Optional)		
								1	2	4
A-DATA	AD3U1600C2G11	2GB	SS	MICRON	D9PFJ	11-11-11-28	-	*	*	*
A-DATA	AD3U1600C4G11	4GB	DS	MICRON	D9PFJ	11-11-11-28	-	*	*	*
A-DATA	AD3U1600W4G11	4GB	SS	A-DATA	3WCD-1211A	11-11-11-28	-	*	*	*
A-DATA	AD3U1600W8G11	8GB	DS	A-DATA	3WCD-1211A	11-11-11-28	-	*	*	*
AMD	AE32G1609U1-U	2GB	SS	AMD	23EY4587MB6H	-	1.5	*	*	*
AMD	AE34G1609U2-U	4GB	DS	AMD	23EY4587MB6H	-	1.5	*	*	*
AMD	AP38G1608U2K(XMP)	8GB (2x4GB)	DS	-	-	9-9-9-28	1.65	*	*	*
Apacer	78.B1GET.9L10C	4GB	DS	Apacer	AM5D5908DEQSKC	-	1.65	*	*	*
Apacer	78.B1GET.9K00C	4GB	SS	Apacer	AM5D6008BQSKC	11-11-11-28	-	*	*	*

(continued on the next page)

DDR3 1600 MHz capability

Vendors	Part No.	Size	SS/DS	Chip Brand	Chip NO.	Timing	Voltage	DIMM socket support (Optional)		
								1	2	4
Apacer	78.C1GET.9K10C	8GB	DS	Apacer	AM5D6008 BQOQSK	11-11-11-31	-	*	*	*
Apacer	AHU04GFA60C9Q1D(XMP)	4GB	DS	-	-	9-9-9-27	1.65	*	*	*
Apacer	AHU04GFA60C9Q3R(XMP)	4GB	DS	-	-	11-11-11-28	-	*	*	*
Apacer	AHU08GFA60CBT3R(XMP)	8GB	DS	-	-	9-9-9-24	-	*	*	*
Asint	SLA302G08-EGG1C(XMP)	4GB	DS	Asint	302G08- GG1C	9-9-9-27	-	*	*	*
Asint	SLA302G08-EGJ1C(XMP)	4GB	DS	Asint	302G08- GJ1C	9-9-9-27	-	*	*	*
Asint	SLA302G08-EGN1C	4GB	DS	ASint	302G08- GN1C	-	-	*	*	*
Asint	SLB304G08-EGN1B	8GB	DS	ASint	304G08- GN1B	-	-	*	*	*
Asint	SLZ302G08-EGN1C	2GB	SS	ASint	302G08- GN1C	-	-	*	*	*
Asint	SLZ312M8-EGJ1D(XMP)	2GB	DS	Asint	312M8- GJ1D	-	-	*	*	*
ATP	AQ12M64B8BK0S	4GB	DS	SAMSUNG	K4B2G 08460	-	NO	*	*	*
CORSAIR	CMD16GX3M2A1600C9 (Ver.8.21)(XMP)	16GB (2x8GB)	DS	-	-	9-9-9-24	1.5	*	*	*
CORSAIR	CMD8GX3M2A1600C8 (Ver.5.12)(XMP)	8GB (2x4GB)	DS	-	-	1600 8-8-8-24	1.5	*	*	*
CORSAIR	CMD8GX3M2A1600C9 (Ver.2.12)(XMP)	8GB (2x4GB)	DS	-	-	9-9-9-24	1.5	*	*	*
CORSAIR	CMG4GX3M2A1600C6	4GB (2x2GB)	DS	-	-	6-6-6-18	1.65	*	*	*
CORSAIR	CML16GX3M4X1600C8(Ver 2.12)(XMP)	16GB (4x4GB)	DS	-	-	Heat-Sink Package	1.5	*	*	*
CORSAIR	CMP6GX3M3A1600C8(XMP)	6GB (3x2GB)	DS	-	-	8-8-8-24	1.65	*	*	*
CORSAIR	CMP6GX3M3A1600C8(XMP)	6GB (3x2GB)	DS	-	-	8-8-8-24	1.65	*	*	*
CORSAIR	CMX6GX3M3C1600C7(XMP)	6GB (3x2GB)	DS	-	-	7-8-7-20	1.65	*	*	*
CORSAIR	CMX8GX3M2A1600C9 (Ver.3.19)(XMP)	8GB (2x4GB)	SS	-	-	9-9-9-24	1.65	*	*	*
CORSAIR	CMZ16GX3M2A1600C10 (Ver.3.24)(XMP)	16GB (2x8GB)	DS	-	-	10-10-10-27	1.5	*	*	*
CORSAIR	CMZ16GX3M4A1600C9(XMP)	16GB (4x4GB)	DS	-	-	9-9-9-24	1.5	*	*	*
CORSAIR	CMZ32GX3M4X1600C10 (Ver.2.2)(XMP)	32GB (4x8GB)	DS	-	-	10-10-10-27	1.5	*	*	*
CORSAIR	CMZ8GX3M2A1600C8(XMP)	8GB (2x4GB)	DS	-	-	8-8-8-24	1.5	*	*	*
CORSAIR	CMZ8GX3M2A1600C9(XMP)	8GB (2x4GB)	DS	-	-	9-9-9-24	1.5	*	*	*
CORSAIR	CMZ8GX3M4X1600C9(Ver 2.12)(XMP)	8GB (4x2GB)	SS	-	-	9-9-9-24	1.5	*	*	*
CORSAIR	HX3X12G1600C9(XMP)	12GB (6x2GB)	DS	-	-	9-9-9-24	1.6	*	*	*
Crucial	BL12864BN1608.8FF(XMP)	2GB (2x1GB)	SS	-	-	8-8-8-24	1.65	*	*	*
Crucial	BLT4G3D1608DT1TX0.16F M(XMP)	4GB	DS	-	-	8-8-8-24	1.5	*	*	*

(continued on the next page)

DDR3 1600 MHz capability

Vendors	Part No.	Size	SS/DS	Chip Brand	Chip NO.	Timing	Voltage	DIMM socket support (Optional)		
								1	2	4
EK Memory	EKM324L28BP8-I16(XMP)	4GB (2x2GB)	DS	-	-	9	-	*	*	*
EK Memory	EKM324L28BP8-I16(XMP)	4GB (2x2GB)	DS	-	-	9	-	*	*	*
Elixir	M2X2G64CB88 G7N-DG(XMP)	2GB	SS	Elixir	N2CB2G80GN-DG	9-9-9-28	-	*	*	*
Elixir	M2X4G64CB8HG 5N-DG(XMP)	4GB	DS	Elixir	N2CB2G80GN-DG	9-9-9-28	-	*	*	*
Elixir	M2X8G64CB8HB 5N-DG(XMP)	8GB	DS	Elixir	N2CB4G80BN-DG	9-9-9-28	1.5	*	*	*
G.SKILL	F3-12800CL7D-8GBRH(XMP)	8GB (2x4GB)	DS	-	-	7-8-7-24	1.6	*	*	*
G.SKILL	F3-12800CL7Q-16GBXH(XMP)	16GB (4x4GB)	DS	-	-	7-8-7-24	1.6	*	*	*
G.SKILL	F3-12800CL8D-8GBECO(XMP)	8GB (2x4GB)	DS	-	-	8-8-8-24	1.35	*	*	*
G.SKILL	F3-12800CL9D-8GBRL(XMP)	8GB (2x4GB)	DS	-	-	9-9-9-24	1.5	*	*	*
G.SKILL	F3-12800CL9D-8GBSR2(XMP)	8GB (2x4GB)	DS	-	-	9-9-9-24	1.25	*	*	*
G.SKILL	F3-12800CL9Q-16GBXL(XMP)	16GB (4x4GB)	DS	-	-	9-9-9-24	1.5	*	*	*
G.Skill	F3-12800CL9Q-16GBZL(XMP)	16GB (4x4GB)	DS	-	-	9-9-9-24	1.5	*	*	*
G.SKILL	F3-1600C9Q-32GXM(XMP)	32GB (4x8GB)	DS	-	-	-	1.5	*	*	*
GEIL	GET316GB1600C9QC(XMP)	16GB (4x4GB)	DS	-	-	9-9-9-28	1.6	*	*	*
GEIL	GUP34GB1600C7DC(XMP)	4GB (2x2GB)	DS	-	-	7-7-7-24	1.6	*	*	*
GoodRam	GR1600D364L9/2G	2GB	DS	GoodRam	GF1008KC-JN	-	-	*	*	*
KINGMAX	FLGE85F-C8KL9A(XMP)	2GB	SS	KINGMAX	N/A	9-9-9-28	-	*	*	*
KINGMAX	FLGF65F-C8KL9A(XMP)	4GB	DS	KINGMAX	N/A	9-9-9-28	-	*	*	*
KINGSTON	KHX1600C9D3K3/12GX(XMP)	12GB (3x4GB)	DS	-	-	-	1.65	*	*	*
KINGSTON	KHX1600C9D3K3/12GX(XMP)	12GB (3x4GB)	DS	-	-	9	1.65	*	*	*
KINGSTON	KHX1600C9D3K3/6GX(XMP)	6GB (3x2GB)	DS	-	-	9	1.65	*	*	*
KINGSTON	KHX1600C9D3K3/6GX(XMP)	6GB (3x2GB)	DS	-	-	9	1.65	*	*	*
KINGSTON	KHX1600C9D3K4/16GX(XMP)	16GB (4x4GB)	DS	-	-	9-9-9-24	1.65	*	*	*
KINGSTON	KHX1600C9D3K6/24GX(XMP)	24GB (6x4GB)	DS	-	-	9	1.65	*	*	*
KINGSTON	KHX1600C9D3K8/32GX(XMP)	32GB (8x4GB)	DS	-	-	9-9-9-27	1.65	*	*	*
KINGSTON	KHX1600C9D3LK2/8GX(XMP)	8GB (2x4GB)	DS	-	-	9-9-9-24	1.35	*	*	*
KINGSTON	KHX1600C9D3P1K2/8G	8GB (2x4GB)	DS	-	-	9	1.5	*	*	*
KINGSTON	KHX1600C9D3T1BK3/12GX(XMP)	12GB (3x4GB)	DS	-	-	9	1.65	*	*	*
KINGSTON	KHX1600C9D3T1K3/6GX(XMP)	6GB (3x2GB)	DS	-	-	9	1.65	*	*	*

(continued on the next page)

DDR3 1600 MHz capability

Vendors	Part No.	Size	SS/ DS	Chip Brand	Chip NO.	Timing	Voltage	DIMM socket support (Optional)		
								1	2	4
KINGSTON	KHX16C10B1K2/ 16X(XMP)	16GB (2x8GB)	DS	-	-	-	1.5	*	*	*
KINGSTON	KHX16C9K2/16	16GB (2x8GB)	DS	-	-	1333-9- 9-9-24	1.5	*	*	*
KINGSTON	KHX16C9P1K2/16	16GB (2x8GB)	DS	-	-	-	1.5	*	*	*
KINGSTON	KVR16N11/4	4G	DS	Hynix	H5TQ2G83CFRPEC	-	1.5	*	*	*
KINGTIGER	KTG2G1600PG3(XMP)	2GB	DS	-	-	-	-	*	*	*
MICRON	MT16JTF1G64AZ- 1G6D1	8GB	DS	MICRON	D9PBC	-	1.5	*	*	*
MICRON	MT16KTF51264AZ- 1G6M1	4GB	DS	MICRON	D9PFJ	-	-	*	*	*
MICRON	MT8KTF25664AZ- 1G6M1	2GB	SS	MICRON	D9PFJ	-	-	*	*	*
Mushkin	998805(XMP)	4GB (2x2GB)	DS	-	-	6-8-6- 24	1.65	*	*	*
Mushkin	998805(XMP)	6GB (3x2GB)	DS	-	-	6-8-6- 24	1.65	*	*	*
OCZ	OCZ3BE1600C8LV4GK	4GB (2x2GB)	DS	-	-	8-8-8	1.65	*	*	*
Patriot	PGD316G1600E LK(XMP)	16GB (2x8GB)	DS	-	-	-	1.65	*	*	*
Patriot	PGD316G1600E LK(XMP)	16GB (2x8GB)	DS	-	-	9-9- 9-24	1.5	*	*	*
Patriot	PGD38G1600EL K(XMP)	8GB (2x4GB)	DS	-	-	9-9-9- 24	1.65	*	*	*
Patriot	PGD38G1600E LK(XMP)	8GB (2x4GB)	DS	-	-	9-9-9- 24	1.5	*	*	*
Patriot	PGS34G1600LLKA	4GB (2x2GB)	DS	-	-	7-7-7- 20	1.7	*	*	*
Patriot	PGS34G1600LL KA2	4GB (2x2GB)	DS	-	-	8-8-8- 24	1.7	*	*	*
Patriot	PV316G160C9Q KRD(XMP)	16GB (4x4GB)	DS	-	-	9-9-9- 24	1.5	*	*	*
Patriot	PV38G160C9KR D(XMP)	8GB (2x4GB)	DS	-	-	9-9-9- 24	1.5	*	*	*
Patriot	PVV38G1600L LK(XMP)	8GB (2x4GB)	DS	-	-	8-9-8- 24	1.65	*	*	*
Patriot	PX7312G1600L LK(XMP)	12GB (3x4GB)	DS	-	-	8-9-8- 24	1.65	*	*	*
Patriot	PXD38G1600LL K(XMP)	8GB (2x4GB)	DS	-	-	1600 8- 9-8-24	1.65	*	*	*
PSC	AL9F8L93B-GN2E	4GB	SS	PSC	A3P4GF3BLF	-	-	*	*	*
PSC	ALAF8L93B-GN2E	8GB	DS	PSC	A3P4GF3BLF	-	-	*	*	*
SanMax	SMD-4G68HP-16KZ	4GB	DS	Hynix	H5TQ2G83BFRPBC	-	1.5	*	*	*
SanMax	SMD-4G68NG-16KK	4GB	DS	ELPIDA	J2108BDBG-GN-F	-	-	*	*	*
Silicon Power	SP002GBLTU16 0V02(XMP)	2GB	SS	S-POWER	20YT5NG	9-11- 11-28	1.5	*	*	*
Silicon Power	SP004GBLTU16 0V02(XMP)	4GB	DS	S-POWER	20YT5NG	9-9-9- 24	1.5	*	*	*
Team	TXD34096M1600HC9- D(XMP)	4GB	DS	Hynix	H5TC2G83BFRH9A	9-9-9- 24	1.5	*	*	*
Transcend	JM1600LKH- 8G(626633)	8GB	DS	Transcend	TK963EBF3	-	-	*	*	*
Transcend	TS1GLK64V 6H(620945)	8GB	DS	SAMSUNG	K4B4G0846B	-	-	*	*	*

DDR3 1333 MHz capability

Vendors	Part No.	Size	SS/DS	Chip Brand	Chip NO.	Timing	Voltage	DIMM socket support (Optional)		
								1	2	4
ACTICA	ACT1GHU64B8F1333S	1GB	SS	SAMSUNG	K4B1G0846F	-	-	*	*	*
ACTICA	ACT1GHU72C8G1333S	1GB	SS	SAMSUNG	K4B1G0846F(ECC)	-	-	*	*	*
ACTICA	ACT2GHU64B8G1333M	2GB	DS	Micron	D9KPT	-	-	*	*	*
ACTICA	ACT2GHU64B8G1333S	2GB	DS	SAMSUNG	K4B1G0846F	-	-	*	*	*
ACTICA	ACT2GHU72D8G1333M	2GB	DS	Micron	D9KPT(ECC)	-	-	*	*	*
ACTICA	ACT2GHU72D8G1333S	2GB	DS	SAMSUNG	K4B1G0846F(ECC)	-	-	*	*	*
ACTICA	ACT4GHU64B8H1333H	4GB	DS	Hynix	H5TQ2G83AFR	-	-	*	*	*
ACTICA	ACT4GHU72D8H1333H	4GB	DS	Hynix	H5TQ2G83AFR(ECC)	-	-	*	*	*
AMD	AE32G1339U1-U	2GB	SS	AMD	23EY4587MB3H	-	1.5	*	*	*
AMD	AE34G1339U2-U	4GB	DS	AMD	23EY4587MB3H	-	1.5	*	*	*
Apacer	78.A1GC6.9L1	2GB	DS	Apacer	AM5D5908FEQSBG	9	-	*	*	*
Apacer	78.B1GDE.9L10C	4GB	DS	Apacer	AM5D5908CEHSBG	9	-	*	*	*
Asint	SLA302G08-EDJ1C	2GB	SS	ASint	302G08-DJ1C	-	-	*	*	*
Asint	SLZ302G08-EDJ1C	4GB	DS	ASint	302G08-DJ1C	-	-	*	*	*
ATP	AQ12M72E8BKH9S	4GB	DS	SAMSUNG	K4B2G0846C(ECC)	-	-	*	*	*
BUFFALO	D3U1333-1G	1GB	SS	Elpida	J1108BFBG-DJ-F	-	-	*	*	*
BUFFALO	D3U1333-2G	2GB	DS	Elpida	J1108BFBG-DJ-F	-	-	*	*	*
BUFFALO	D3U1333-4G	4GB	DS	NANYA	NT5CB256M8BN-CG	-	-	*	*	*
CORSAIR	CMV4GX3M2A1333C9	4GB (2x2GB)	SS	-	N/A	9-9-9-24	-	*	*	*
CORSAIR	CMV8GX3M2A1333C9	8GB (2x4GB)	DS	-	N/A	9-9-9-24	-	*	*	*
CORSAIR	CMX8GX3M1A1333C9 (Ver2.2)	8GB	DS	-	-	9-9-9-24	1.5	*	*	
CORSAIR	CMX8GX3M1A1333C9 (Ver3.23)	8GB	DS	-	-	9-9-9-24	1.5	*	*	
CORSAIR	CMX8GX3M2A1333C9(XMP)	8GB (2x4GB)	DS	-	-	9-9-9-24	1.5	*	*	*
CORSAIR	TW3X4G1333C9A	4GB (2x2GB)	DS	-	-	9-9-9-24	1.5	*	*	
EK Memory	EKM324L28B F8-113	4GB (2x2GB)	DS	-	-	9	-	*	*	*
G.SKILL	F3-10600CL9D-4GBNT	4GB (2x2GB)	DS	G.SKILL	D3 128M8CE9 2GB	9-9-9-24	1.5	*	*	*
G.SKILL	F3-10666CL9D-8GBRL	8GB (2x4GB)	DS	-	-	9-9-9-24	1.5	*	*	*

(continued on the next page)

DDR3 1333 MHz capability

Vendors	Part No.	Size	SS/ DS	Chip Brand	Chip NO.	Timing	Voltage	DIMM socket support (Optional)		
								1	2	4
G.SKILL	F3-10666CL9D-8GBRL	8GB (2x4GB)	DS	-	-	9-9-9-24	1.5	*	*	*
G.SKILL	F3-10666CL9D-8GBXL	8GB (2x4GB)	DS	-	-	9-9-9-24	1.5	*	*	*
GEIL	GB34GB1333C7DC	4GB (2x2GB)	DS	GEIL	GL1L128M8 8BA15FW	7-7-7-24	1.5	*	*	*
GEIL	GET316GB1333 C9QC	16GB (4x4GB)	DS	-	-	9-9-9-24	1.5	*	*	*
GEIL	GG34GB1333C 9DC	4GB (2x2GB)	DS	GEIL	GL1L128M8 8BA15FW	9-9-9-24	1.3	*	*	*
GEIL	GG34GB1333C 9DC	4GB (2x2GB)	DS	GEIL	GL1L128M 88BA15B	9-9-9-24	1.3	*	*	*
GEIL	GVP34GB1333 C9DC	4GB (2x2GB)	DS	-	-	9-9-9-24	1.5	*	*	*
GEIL	GVP38GB1333 C9DC	8GB (2x4GB)	DS	-	-	9-9-9-24	1.5	*	*	*
GoodRam	GR1333D364L9/ 2G	2GB	DS	Qimonda	IDSH1G-03A 1F1C-13H	-	-	*	*	*
Hynix	HMT125U6TFR8A- H9	2GB	DS	Hynix	H5TC1G83T FR	-	-	*	*	*
INNODISK	M3UN-2GHJB C09	2GB	SS	Hynix	H5TQ2G83C FRH9C	9-9-9-24	-	*	*	*
INNODISK	M3UN-4GHJA C09	4GB	DS	Hynix	H5TQ2G83C FRH9C	9-9-9-24	-	*	*	*
KINGMAX	FLFE85F-B8KL9	2GB	DS	KINGMAX	KFB8FNXL- BNF-15A	-	-	*	*	*
KINGMAX	FLFE85F-C8KL9	2GB	SS	KINGMAX	KFC8FNLBF- GXX-12A	-	-	*	*	*
KINGMAX	FLFE85F-C8KL9	2GB	SS	KINGMAX	KFC8FNLXF- DXX-15A	-	-	*	*	*
KINGMAX	FLFE85F-C8KM9	2GB	SS	Kingmax	KFC8FNMXF- BXX-15A	-	-	*	*	*
KINGMAX	FLFF65F-C8KL9	4GB	DS	KINGMAX	KFC8FNLBF- GXX-12A	-	-	*	*	*
KINGMAX	FLFF65F-C8KL9	4GB	DS	KINGMAX	KFC8FNLXF- DXX-15A	-	-	*	*	*
KINGMAX	FLFF65F-C8KM9	4GB	DS	Kingmax	KFC8FNMXF- BXX-15A	-	-	*	*	*
KINGSTON	KVR1333D3 E9S/4G	4GB	DS	Elpida	J2108ECESE- DJ-F	9	1.5	*	*	*
KINGSTON	KVR1333D3 N9H/4G	4GB	DS	ELPIDA	J2108BDBG- GN-F	-	1.5	*	*	*
KINGSTON	KVR1333D3N 9H/8G	8GB	DS	ELPIDA	J4208EASE- DJ-F	9-9-9-24	1.5	*	*	*
KINGSTON	KVR13N9S8H/4	4GB	SS	ELPIDA	J4208BBBG- GN-F	-	1.5	*	*	*
KINGTIGER	F10DA2T1680	2GB	DS	KINGTIGER	KTG1333P S1208NST- C9	-	-	*	*	*
KINGTIGER	KTG2G1333 PG3	2GB	DS	-	-	-	-	*	*	*
Mach Xtreme	MXD3U1333 16GQ	16GB (4x4GB)	DS	-	-	-	-	*	*	*
Mach Xtreme	MXD3V1333 2GS	2GB	SS	Mach Xtreme	C2S46D30- D313	-	-	*	*	*
MICRON	MT8JTF25664AZ- 1G4M1	2GB	SS	MICRON	D9PFJ	-	-	*	*	*

(continued on the next page)

DDR3 1333 MHz capability

Vendors	Part No.	Size	SS/ DS	Chip Brand	Chip NO.	Timing	Voltage	DIMM socket support (Optional)		
								1	2	4
OCZ	OCZ3G1333L V4GK	4GB (2x2GB)	DS	-	-	9-9-9	1.65	*	*	
OCZ	OCZ3G1333L V8GK	8GB (2x4GB)	DS	-	-	9-9-9	1.65	*	*	
OCZ	OCZ3G1333L V8GK	8GB (2x4GB)	DS	-	-	9-9-9	1.65	*	*	
OCZ	OCZ3RPR1333 C9LV8GK	8GB (2x4GB)	DS	-	-	9-9-9	1.65	*	*	
Patriot	PG38G1333EL (XMP)	8GB	DS	-	-	-	1.5	*	*	*
Patriot	PGD316G1333 ELK(XMP)	16GB (2x8GB)	DS	-	-	9-9-9-24	1.5	*	*	*
Patriot	PGS34G1333L LKA	4GB (2x2GB)	DS	-	-	7-7-7-20	1.7	*	*	*
Patriot	PSD32G13332	2GB	DS	Patriot	PM128M8D3BU-15	9	-	*	*	*
RiDATA	C304627CB1A G22Fe	2GB	DS	RiDATA	C304627CB1AG22Fe	9	-	*	*	*
RiDATA	E304459CB1A G32Cf	4GB	DS	RiDATA	E304459CB1AG32Cf	9	-	*	*	*
SAMSUNG	M378B5273CH 0-CH9	4GB	DS	SAMSUNG	K4B2G0846C	-	-	*	*	*
Silicon Power	SP001GBLTE 133S01	1GB	SS	NANYA	NT5CB128M8AN-CG	-	-	*	*	*
Silicon Power	SP001GBLTU1 33S02	1GB	SS	S-POWER	10YT3E5	9	-	*	*	*
Silicon Power	SP002GBLTE1 33S01	2GB	DS	NANYA	NT5CB128M8AN-CG	-	-	*	*	*
Silicon Power	SP002GBLTU1 33V02	2GB	SS	S-POWER	20YT3NG	9-9-9-24	-	*	*	*
Silicon Power	SP004GBLTU1 33V02	4GB	DS	S-POWER	20YT3NG	9-9-9-24	-	*	*	*
Team	TED34096M1 333HC9	4GB	DS	Team	T3D2568LT-13	-	-	*	*	*
Transcend	JM1333KHLH-8 G(623654)	8GB	DS	Transcend	TK963EBF3	-	-	*	*	*
Transcend	TS1GLK64V3 H(620053)	8GB	DS	MICRON	D9QBJ	-	-	*	*	*



Side(s): SS - Single-sided DS - Double-sided DIMM support:

- (1) Supports one (1) module inserted into any slot as Single-channel memory configuration. We suggest that you install the module into A2 slot.
 - (2) Supports two (2) modules inserted into either the yellow slots or the dark brown slots as one pair of Dual-channel memory configuration. We suggest that you install the modules into slots A2 and B2 for better compatibility.
 - (4) Supports four (4) modules inserted into both the yellow slots and dark brown slots as two pairs of Dual-channel memory configuration.
-



- ASUS exclusively provides hyper DIMM support function.
 - Hyper DIMM support is subject to the physical characteristics of individual CPUs. Load the X.M.P. or D.O.C.P. settings in the BIOS for the hyper DIMM support.
 - Visit the ASUS website for the latest QVL.
-

1.2.5 Expansion slots



Unplug the power cord before adding or removing expansion cards. Failure to do so may cause you physical injury and damage motherboard components.

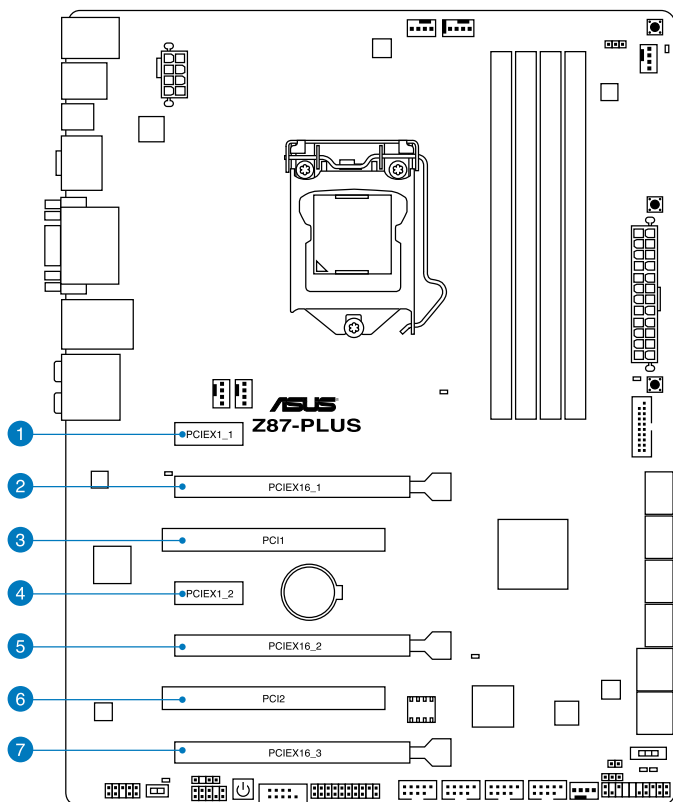

Slot No.	Slot Description
1	PCIe 2.0 x1_1 slot
2	PCIe 3.0 x16_1 slot
3	PCI_1
4	PCIe 2.0 x1_2 slot
5	PCIe 3.0 x16_2 slot
6	PCI_2
7	PCIe 2.0 x16_3 slot

VGA configuration	PCIe Express 3.0 operating mode	
	PCIe 3.0/2.0 x16_1	PCIe 3.0/2.0 x16_2
Single VGA/PCIe card	x16 (single VGA recommended)	N/A
Dual VGA/PCIe card	x8	x8



- We recommend that you provide sufficient power when running CrossFire™ or SLI™ mode.
- Connect a chassis fan to the motherboard connector labeled CHA_FAN1-4 when using multiple graphics cards for better thermal environment.

IRQ assignments for this motherboard

	A	B	C	D	E	F	G	H
PCIe x16_1	shared	-	-	-	-	-	-	-
PCIe x16_2	-	shared	-	-	-	-	-	-
PCIe x16_3	shared	-	-	-	-	-	-	-
PCIe x1_1	-	-	-	shared	-	-	-	-
PCIe x1_2	-	-	-	shared	-	-	-	-
PCI1	-	-	shared	-	-	-	-	-
PCI2	-	-	-	shared	-	-	-	-
Intel® SATA	-	-	-	shared	-	-	-	-
EHCI #0	-	-	-	-	-	-	-	shared
EHCI #1	shared	-	-	-	-	-	-	-
XHCI	-	-	-	-	-	shared	-	-
HD Audio	-	-	-	-	-	-	shared	-
Intel® LAN	-	-	-	-	shared	-	-	-
ASM1061	-	shared	-	-	-	-	-	-
SMBUS	-	-	shared	-	-	-	-	-

1.2.6 Onboard buttons and switches

Onboard switches and buttons allow you to fine-tune performance when working on a bare or open-case system. This is ideal for overclockers and gamers who continually change settings to enhance system performance.

1. Power-on button

The motherboard comes with a power-on button that allows you to power up or wake up the system. The button also lights up when the system is plugged to a power source indicating that you should shut down the system and unplug the power cable before removing or installing any motherboard component.

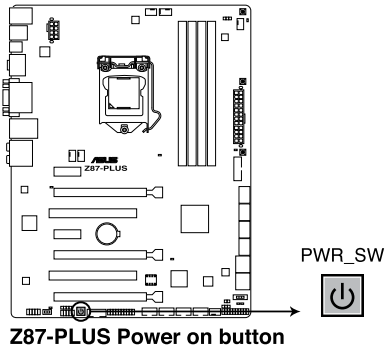

2. MemOK! button

Installing DIMMs that are not compatible with the motherboard may cause system boot failure, and the DRAM_LED near the MemOK! switch lights continuously. Press and hold the MemOK! button until the DRAM_LED starts blinking to begin automatic memory compatibility tuning for successful boot.

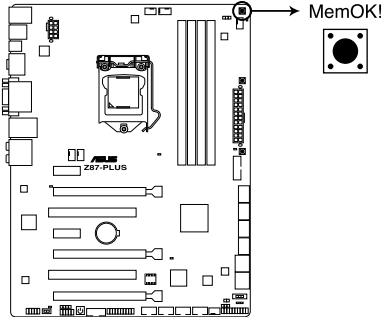

Z87-PLUS MemOK! button



- Refer to section **1.2.8 Onboard LEDs** for the exact location of the DRAM_LED.
- The DRAM_LED also lights up when the DIMM is not properly installed. Turn off the system and reinstall the DIMM before using the MemOK! function.
- The MemOK! switch does not function under Windows® OS environment.
- During the tuning process, the system loads and tests failsafe memory settings. It takes about 30 seconds for the system to test one set of failsafe settings. If the test fails, the system reboots and test the next set of failsafe settings. The blinking speed of the DRAM_LED increases, indicating different test processes.
- Due to memory tuning requirement, the system automatically reboots when each timing set is tested. If the installed DIMMs still fail to boot after the whole tuning process, the DRAM_LED lights continuously. Replace the DIMMs with ones recommended in the Memory QVL (Qualified Vendors Lists) in this user manual or on the ASUS website at www.asus.com.
- If you turn off the computer and replace DIMMs during the tuning process, the system continues memory tuning after turning on the computer. To stop memory tuning, turn off the computer and unplug the power cord for about 5–10 seconds.
- If your system fails to boot up due to BIOS overlocking, press the MemOK! switch to boot and load the BIOS default settings. A message will appear during POST reminding you that the BIOS has been restored to its default settings.
- We recommend that you download and update to the latest BIOS version from the ASUS website at www.asus.com after using the MemOK! function.

3. DirectKey button

This feature allows your system to go to the BIOS Setup program with the press of a button. With DirectKey, you can enter the BIOS anytime without having to press the key during POST. It also allows you to turn on or turn off your system and conveniently enter the BIOS during boot-up.

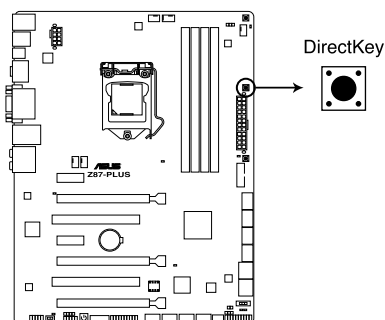

Z87-PLUS DirectKey button



Ensure to save your data before using the DirectKey button.



- When the system is on and you press the DirectKey button, your system will shut down. Press the DirectKey button again or the Power-on button to reboot and enter the BIOS directly.
 - Turn off your system using the power-on button to allow your system to go through POST (without entering the BIOS) when you reboot your system.
 - Refer to section **3.8 Boot Menu** for details about setting the DirectKey default function.
-

4. TPU switch

With its two-level adjustment functions, the TPU allows you to automatically adjust the CPU ratio and clock speed for an optimal system performance.



- Enable this switch when the system is powered off.
- When the TPU switch is set to Enabled (TPU_I: CPU Ratio Boost), the system automatically adjusts the CPU ratio for an enhanced performance.
- When the TPU switch is set to Enabled (TPU_II: CPU BCLK and Ratio Boost), the system automatically adjusts the base clock rate (BCLK) and the CPU ratio for enhanced performance.

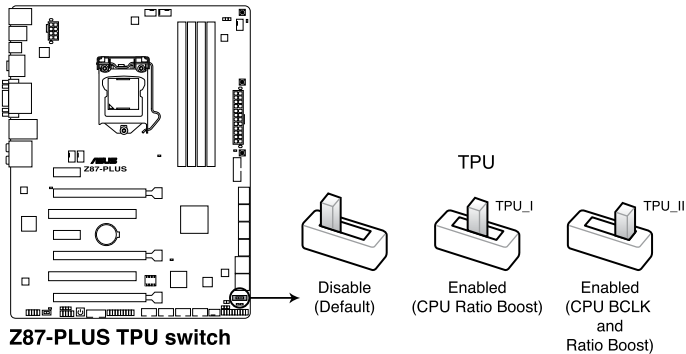

- The TPU LED (TPU_LED) near the TPU switch lights up when the TPU switch is enabled. Refer to section **1.2.8 Onboard LEDs** for the exact location of the TPU LED.
- If you enable this switch under Windows® OS environment, the TPU function will be activated after the next system bootup.
- You may use the 4-Way Optimization and TPU feature in the AI Suite 3 application, adjust the BIOS setup program or enable the TPU switch at the same time. However, the system will use the last setting you have made.

5. EPU switch

Enable this switch to automatically detect the current PC loadings and intelligently moderate the power consumption.



Enable this switch when the system is powered off.

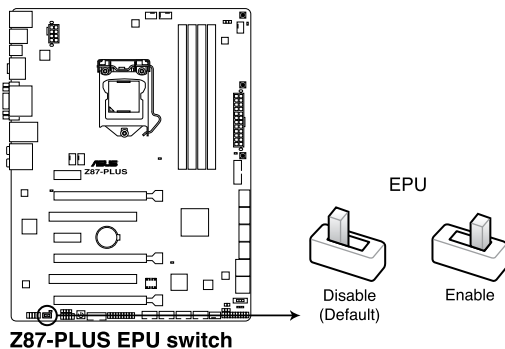

- The EPU LED (OLED2) near the EPU switch lights up when the EPU switch is enabled. Refer to section **1.2.8 Onboard LEDs** for the exact location of the EPU LED.
 - If you enable this switch under Windows® OS environment, the EPU function will be activated after the next system bootup.
 - You may change the EPU settings in the software application or BIOS setup program and enable the EPU function at the same time. However, the system will use the last setting you have made.
-

1.2.7 Jumper

Clear RTC RAM (3-pin CLRTC)

This jumper allows you to clear the Real Time Clock (RTC) RAM in CMOS. You can clear the CMOS memory of date, time, and system setup parameters by erasing the CMOS RTC RAM data. The onboard button cell battery powers the RAM data in CMOS, which include system setup information such as system passwords.

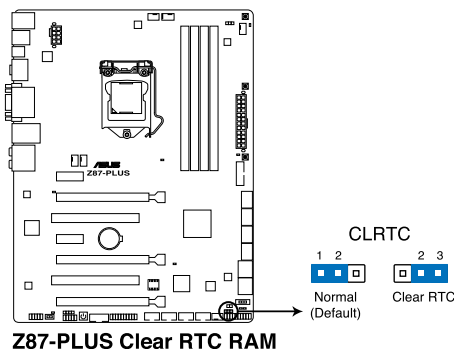

To erase the RTC RAM:

1. Turn OFF the computer and unplug the power cord.
2. Move the jumper cap from pins 1-2 (default) to pins 2-3. Keep the cap on pins 2-3 for about 5-10 seconds, then move the cap back to pins 1-2.
3. Plug the power cord and turn ON the computer.
4. Hold down the **** key during the boot process and enter BIOS setup to re-enter data.



Except when clearing the RTC RAM, never remove the cap on CLRTC jumper default position. Removing the cap will cause system boot failure!



- If the steps above do not help, remove the onboard battery and move the jumper again to clear the CMOS RTC RAM data. After the CMOS clearance, reinstall the battery.
- You do not need to clear the RTC when the system hangs due to overclocking. For system failure due to overclocking, use the C.P.R. (CPU Parameter Recall) feature. Shut down and reboot the system so the BIOS can automatically reset parameter settings to default values.
- Due to the chipset behavior, AC power off is required to enable C.P.R. function. You must turn off and on the power supply or unplug and plug the power cord before rebooting the system.

1.2.8 Onboard LEDs

1. POST State LEDs

The POST State LEDs provide the status of these key components during POST (Power-On-Self Test): CPU, memory modules, VGA card, and hard disk drive.s If an error is found, the critical component's LED stays lit up until the problem is solved.

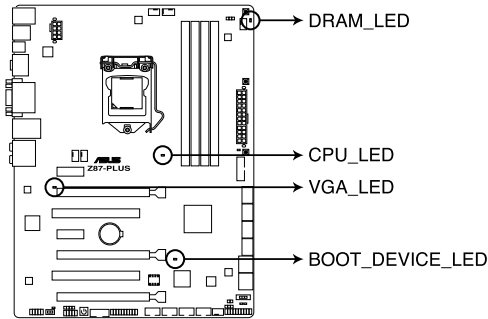

**Z87-PLUS CPU/ DRAM/
BOOT_DEVICE/ VGA LED**

2. TPU LED

The TPU LED lights up when the TPU switch is enabled.

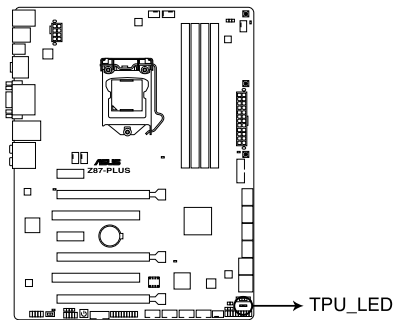

Z87-PLUS TPU LEDs

3. EPU LED

The EPU LED lights up when the EPU switch is enabled.

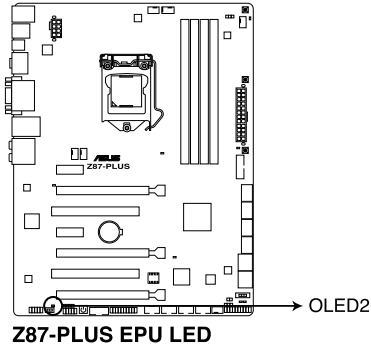

1.2.9 Internal connectors

1. Intel® Z87 Serial ATA 6.0 Gb/s connectors (7-pin SATA6G_1-6 [yellow])

These connectors connect to Serial ATA 6.0 Gb/s hard disk drives via Serial ATA 6.0 Gb/s signal cables.

If you installed Serial ATA hard disk drives, you can create a RAID 0, 1, 5, and 10 configuration with the Intel® Rapid Storage Technology through the onboard Intel® Z87 chipset.

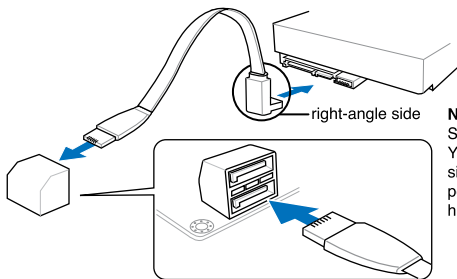
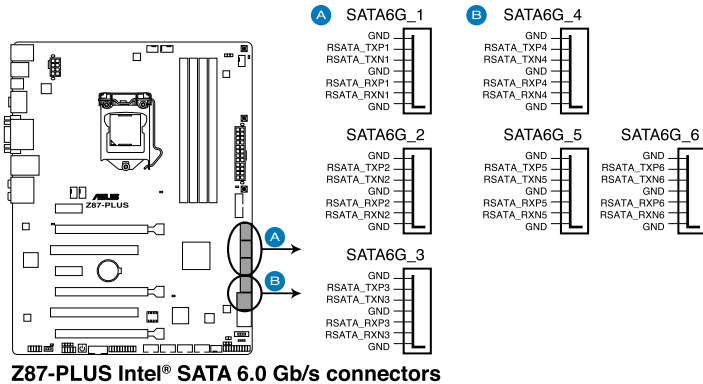

NOTE: Connect the right-angle side of SATA signal cable to SATA device. You may also connect the right-angle side of SATA cable to the onboard SATA port to avoid mechanical conflict with huge graphics cards.



- These connectors are set to **[AHCI Mode]** by default. If you intend to create a Serial ATA RAID set using these connectors, set the SATA Mode item in the BIOS to **[RAID Mode]**. Refer to section **3.6.3 SATA Configuration** for details.
- Before creating a RAID set, refer to section **5.1 RAID configurations** or the manual bundled in the motherboard support DVD.

2. ASMedia® Serial ATA 6.0 Gb/s connectors (7-pin SATA6G_E12 [dark brown])

These connectors connect to Serial ATA 6.0 Gb/s hard disk drives via Serial ATA 6.0 Gb/s signal cables.

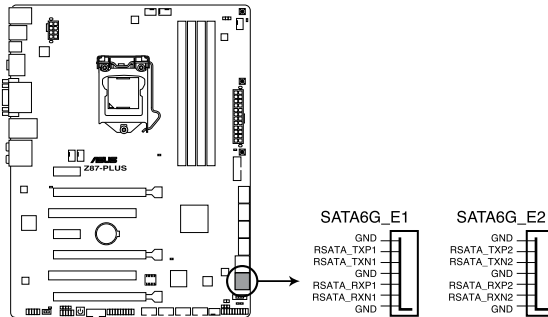

Z87-PLUS ASMedia® SATA 6.0 Gb/s connectors



- ASMedia storage controller can only support AHCI mode.
- These SATA ports are for data drives only.

3. USB 3.0 connector (20-1 pin USB3_12)

This connector allows you to connect a USB 3.0 module for additional USB 3.0 front or rear panel ports. With an installed USB 3.0 module, you can enjoy all the benefits of USB 3.0 including faster data transfer speeds of up to 5Gbps, faster charging time for USB-chargable devices, optimized power efficiency, and backward compatibility with USB 2.0.

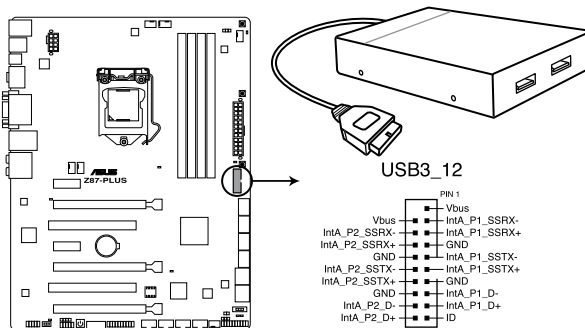

Z87-PLUS USB3.0 connector



- The USB 3.0 module is purchased separately.
- These connectors are based on xHCI specification. We recommend you to install the related driver to fully use the USB 3.0 ports under Windows® 7.
- The plugged USB 3.0 device may run on xHCI or EHCI mode depending on the operating system's setting.

4. Digital audio connector (4-1 pin SPDIF_OUT)

This connector is for an additional Sony/Philips Digital Interface (S/PDIF) port. Connect the S/PDIF Out module cable to this connector, then install the module to a slot opening at the back of the system chassis.

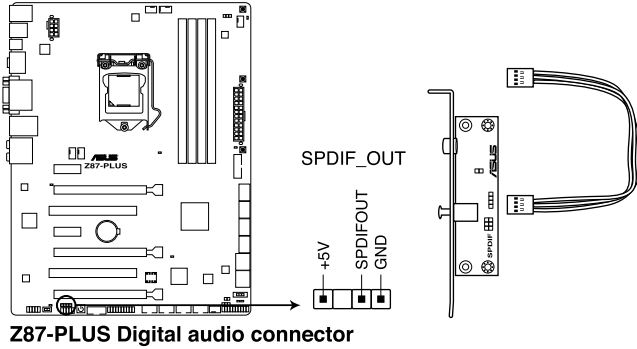

Z87-PLUS Digital audio connector



The S/PDIF module is purchased separately.

5. USB 2.0 connectors (10-1 pin USB78; USB910; USB1112; USB1314)

These connectors are for USB 2.0 ports. Connect the USB module cable to any of these connectors, then install the module to a slot opening at the back of the system chassis. These USB connectors comply with USB 2.0 specification that supports up to 48 MBps connection speed.

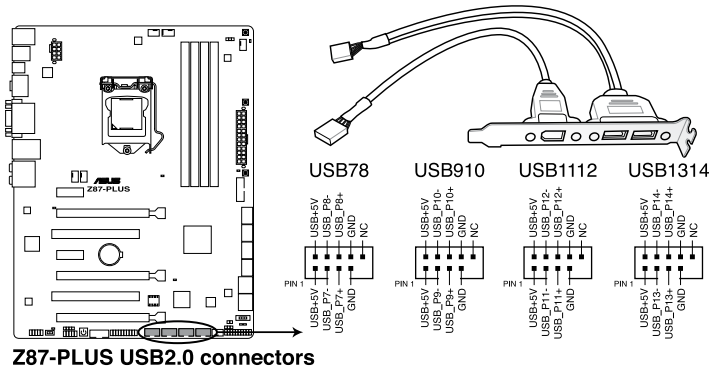

Z87-PLUS USB2.0 connectors



DO NOT connect a 1394 cable to the USB connectors. Doing so will damage the motherboard!



You can connect the front panel USB cable to the ASUS Q-Connector (USB, dark brown) first, and then install the Q-Connector (USB) to the USB connector onboard if your chassis supports front panel USB ports.



- The USB 2.0 module is purchased separately.
- These connectors are based on xHCI specification. We recommend you to install the related driver to fully use the USB 2.0 ports under Windows® 7.
- The plugged USB 2.0 device may run on xHCI or EHCI mode depending on the operating system's setting.

6. CPU, chassis, and optional fan connectors (4-pin CPU_FAN; 4-pin CPU_OPT; 4-pin CHA_FAN1-4)

Connect the fan cables to the fan connectors on the motherboard, ensuring that the black wire of each cable matches the ground pin of the connector.



- DO NOT forget to connect the fan cables to the fan connectors. Insufficient air flow inside the system may damage the motherboard components. These are not jumpers! Do not place jumper caps on the fan connectors!
- Ensure that the CPU fan is securely installed to the CPU fan connector.

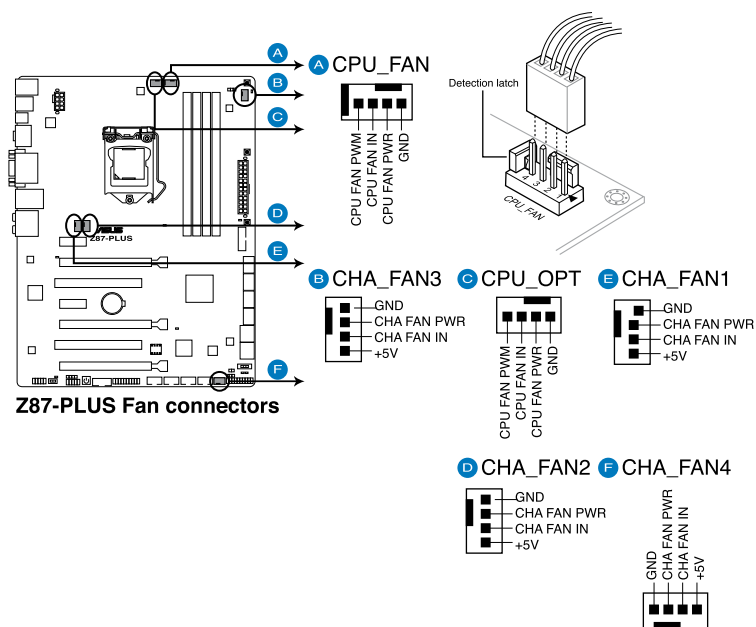

- The CPU_FAN connector supports the CPU fan of maximum 1A (12 W) fan power.
- The CPU_FAN connector and CHA_FAN connectors support the ASUS FAN Xpert 2 feature.

7. Front panel audio connector (10-1 pin AAFP)

This connector is for a chassis-mounted front panel audio I/O module that supports either HD Audio or legacy AC'97 audio standard. Connect one end of the front panel audio I/O module cable to this connector.

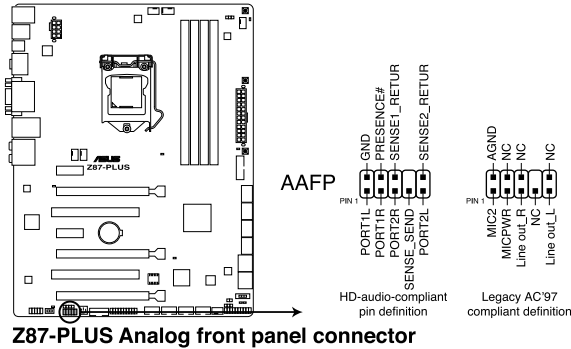

- We recommend that you connect a high-definition front panel audio module to this connector to avail of the motherboard's high-definition audio capability.
- If you want to connect a high-definition or an AC'97 front panel audio module to this connector, set the Front Panel Type item in the BIOS setup to **[HD]** or **[AC97]**.

8. Serial port connector (10-1 pin COM)

This connector is for a serial (COM) port. Connect the serial port module cable to this connector, then install the module to a slot opening at the back of the system chassis.

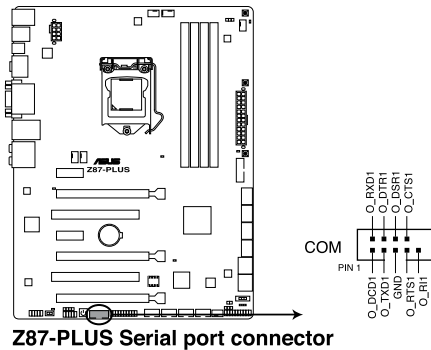

9. ATX power connectors (24-pin EATXPWR; 8-pin EATX12V)

These connectors are for ATX power supply plugs. The power supply plugs are designed to fit these connectors in only one orientation. Find the proper orientation and push down firmly until the connectors completely fit.

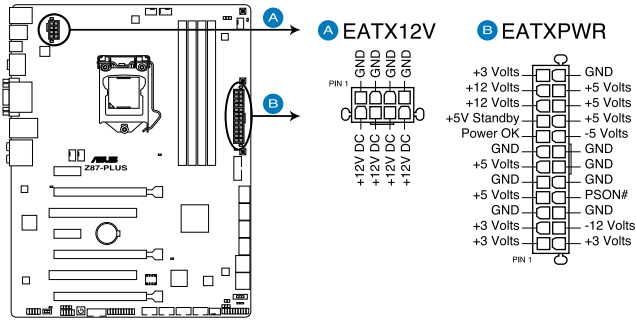

Z87-PLUS ATX power connectors



- For a fully configured system, we recommend that you use a power supply unit (PSU) that complies with ATX 12 V Specification 2.0 (or later version) and provides a minimum power of 350 W.
- DO NOT forget to connect the 4-pin/8-pin EATX12 V power plug. Otherwise, the system will not boot.
- We recommend that you use a PSU with a higher power output when configuring a system with more power-consuming devices. The system may become unstable or may not boot up if the power is inadequate.
- If you want to use two or more high-end PCI Express x16 cards, use a PSU with 1000W power or above to ensure the system stability.
- If you are uncertain about the minimum power supply requirement for your system, refer to the Recommended Power Supply Wattage Calculator at <http://support.asus.com/PowerSupplyCalculator/PSCalculator.aspx?SLanguage=en-us> for details.

PSU Suggested List

Model	Wattage	Model	Wattage
Great Wall BTX-500GT	400	SUPER FLOWER SF-350P14XE	350
ANTEC CP-1000	1000	AcBel IP-500 HB9024	400
Seasonic SS-1250XM	1250	CORSAIR CMPSU-1000HX	1000
Seasonic SS-1000XP	1000	THERMALTAKE TR2-RX-1200AH3CH	1200
ROSEWILL RBR1000-M	1000	Be quiet BQT LT-530W	530
LEPA G1600-MA	1600	CoolerMaster-RS-C50-EMBA-D2	1250
THERMALTAKE TOUGHPOWER1500A	1500	Power box PB450W	450
Antec EA-650 EarthWatts Green	650	Huntkey HK400-55AP	300
SeaSonic S12 II SS-330GB 330W	330	EnerMAX EPM850EWT	850
Thermaltake toughpower TPX775	775	Antec EA-430D	430
ZEST-ZE-850EZ	850	Antec EA-750	750
GoldenField ATX-S395	350	ENERMAX ERV1050EWT	1050
OCZ-OCZ550FTY	550	THERMALTAKE TR2 RX-750AH3CH	750
Delta GPS-300AB	300	THERMALTAKE TR2 RX-850AH3CH	850
ENERTRONIX-EN-300	300		
Seventeam ST-550P-AD	550		
SHARKOON SHA-R600M	600		
Corsair CMPSU-850AX	850		
Silverstone SST-ST1500	1500		
Geil TTB800G	800		
DELUX-DLP-650PG	450		
HAMER MIT750	750		
ENERMAX MAXREVO	1300		
Segotep SG-400PYJ	400		
Centurystar ST-330	320		

10 System panel connector (20-8 pin PANEL)

This connector supports several chassis-mounted functions.

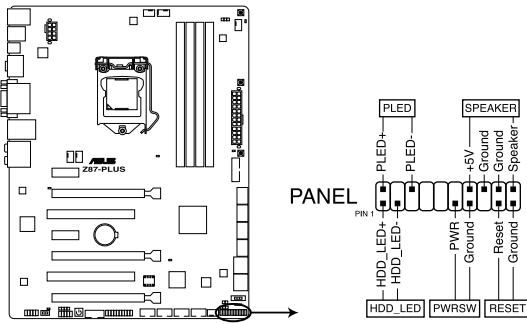

Z87-PLUS System panel connector

- **System power LED (2-pin PLED)**

This 2-pin connector is for the system power LED. Connect the chassis power LED cable to this connector. The system power LED lights up when you turn on the system power, and blinks when the system is in sleep mode.

- **Hard disk drive activity LED (2-pin HDD_LED)**

This 2-pin connector is for the HDD Activity LED. Connect the HDD Activity LED cable to this connector. The HDD LED lights up or flashes when data is read from or written to the HDD.

- **System warning speaker (4-pin SPEAKER)**

This 4-pin connector is for the chassis-mounted system warning speaker. The speaker allows you to hear system beeps and warnings.

- **ATX power button/soft-off button (2-pin PWRSW)**

This connector is for the system power button. Pressing the power button turns the system on or puts the system in sleep or soft-off mode depending on the operating system settings. Pressing the power switch for more than four seconds while the system is ON turns the system OFF.

- **Reset button (2-pin RESET)**

This 2-pin connector is for the chassis-mounted reset button for system reboot without turning off the system power.

11. TPM connector (20-pin TPM)

This connector supports a Trusted Platform Module (TPM) system, which securely store keys, digital certificates, passwords and data. A TPM system also helps enhance network security, protect digital identities, and ensures platform integrity.

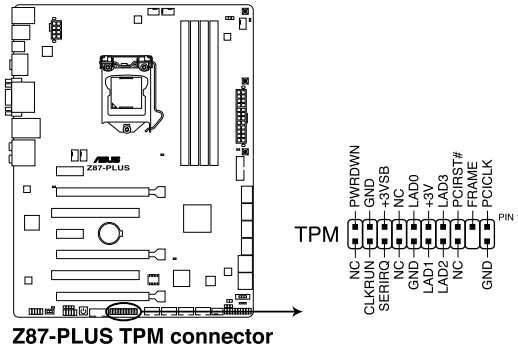

12. Direct Connector (2-pin DRCT)

This connector is for the chassis-mounted button that supports the DirectKey function. Connect the button cable that supports DirectKey, from the chassis to this connector on the motherboard.

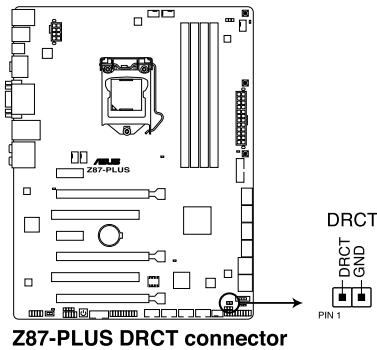

Ensure that your chassis comes with the extra button cable that supports the DirectKey feature. Refer to the technical documentation that came with the chassis for details.

Basic installation

2

2.1 Building your PC system

2.1.1 Motherboard installation



The diagrams in this section are for reference only. The motherboard layout may vary with models, but the installation steps are the same for all models.

1. Install the ASUS Q-Shield to the chassis rear I/O panel.

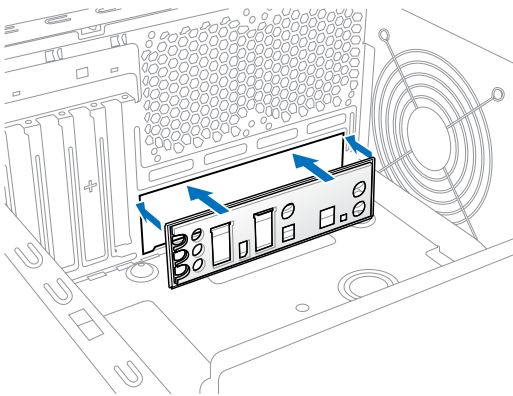

2. Place the motherboard into the chassis, ensuring that its rear I/O ports are aligned to the chassis' rear I/O panel.

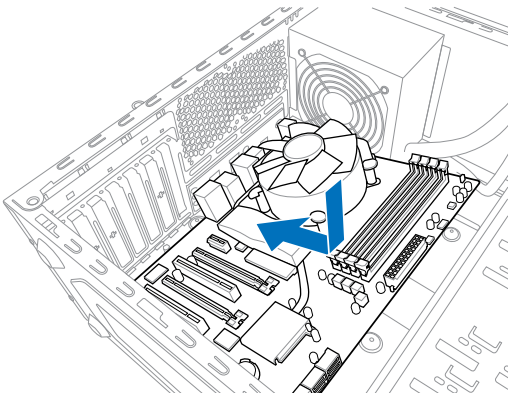

3. Place nine screws into the holes indicated by circles to secure the motherboard to the chassis.

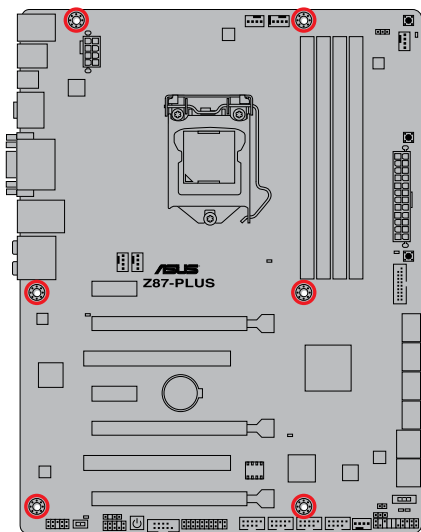
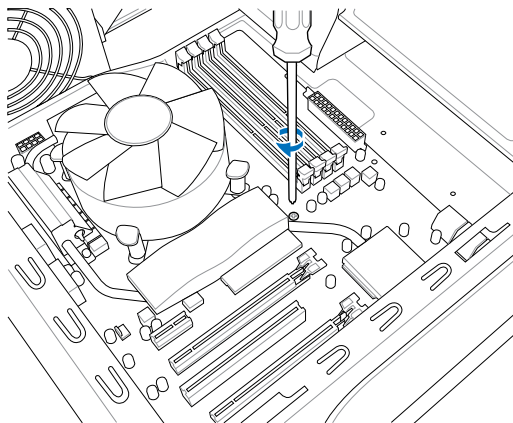

DO NOT overtighten the screws! Doing so can damage the motherboard.

2.1.2 CPU installation



Ensure that you install the correct CPU designed for LGA1150 socket only. DO NOT install a CPU designed for LGA1155 and LGA1156 socket on the LGA1150 socket.

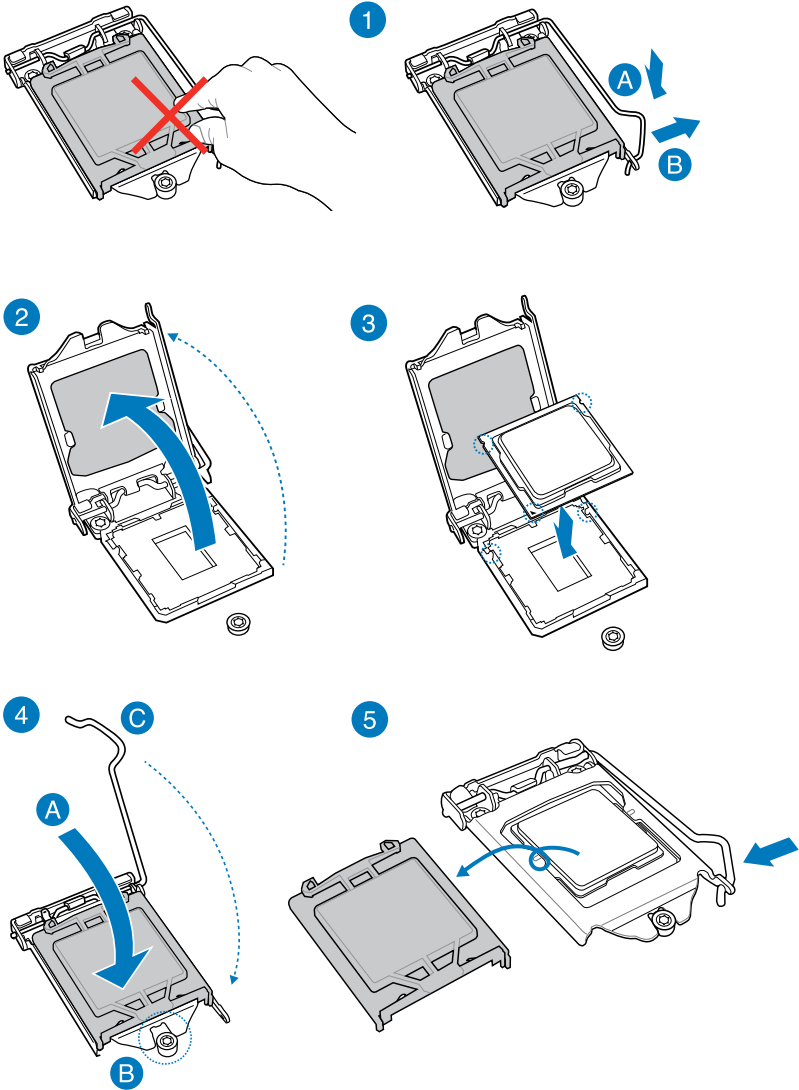

2.1.3 CPU heatsink and fan assembly installation

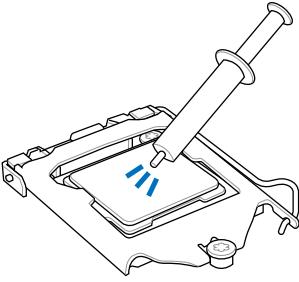

Apply the Thermal Interface Material to the CPU heatsink and CPU before you install the heatsink and fan, if necessary.

To install the CPU heatsink and fan assembly

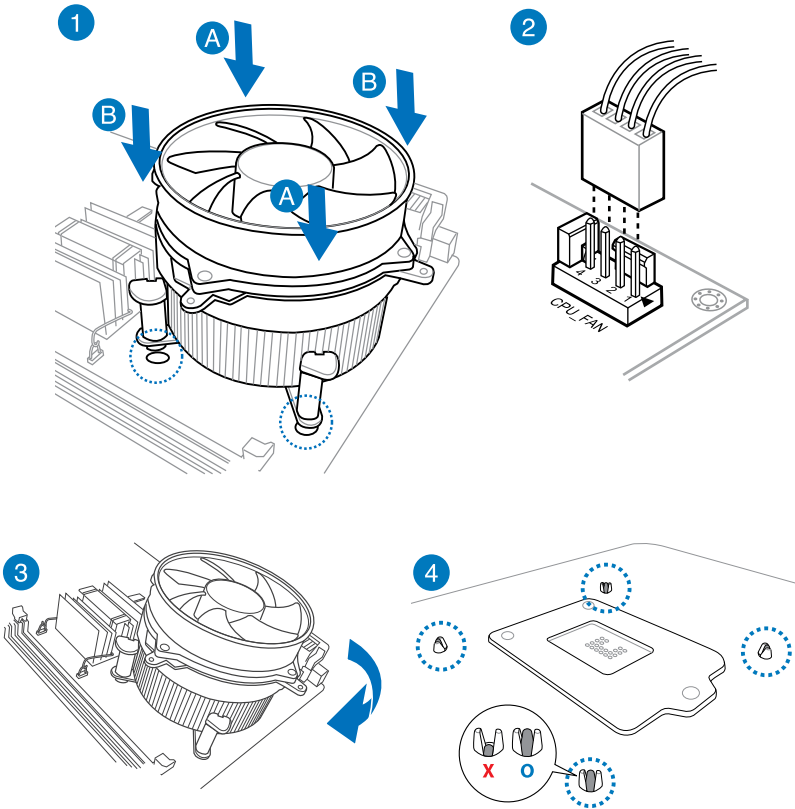

To uninstall the CPU heatsink and fan assembly

1

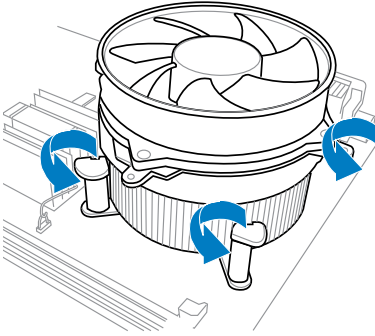

2

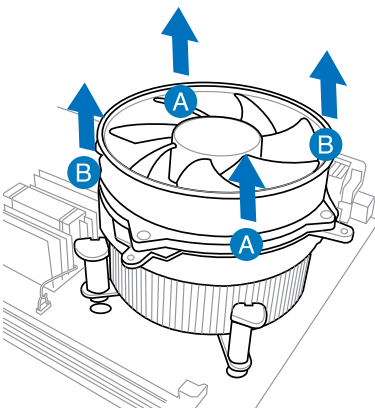

2.1.4 DIMM installation

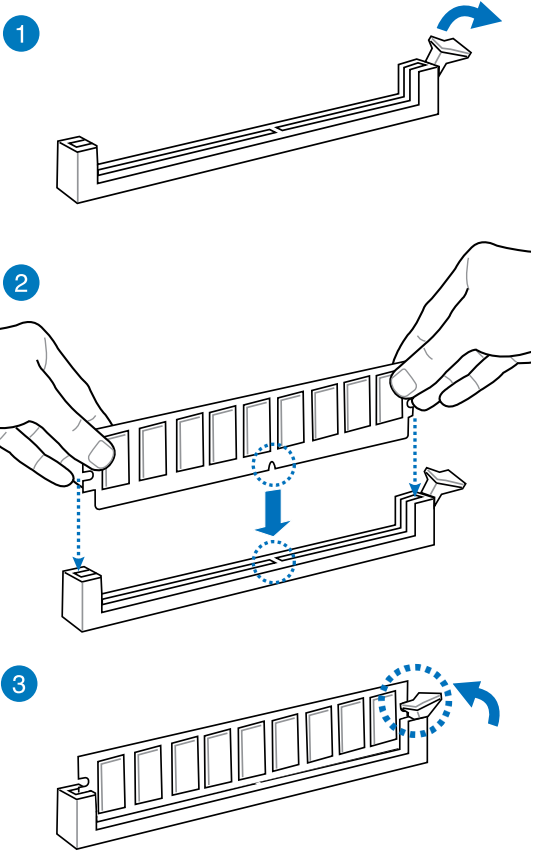

To remove a DIMM

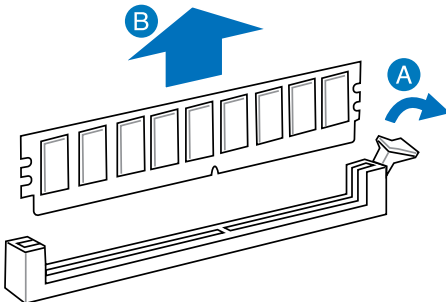

2.1.5 ATX Power connection

1

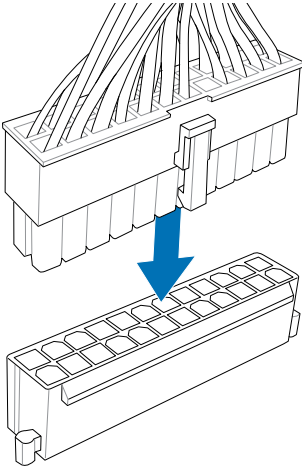

2

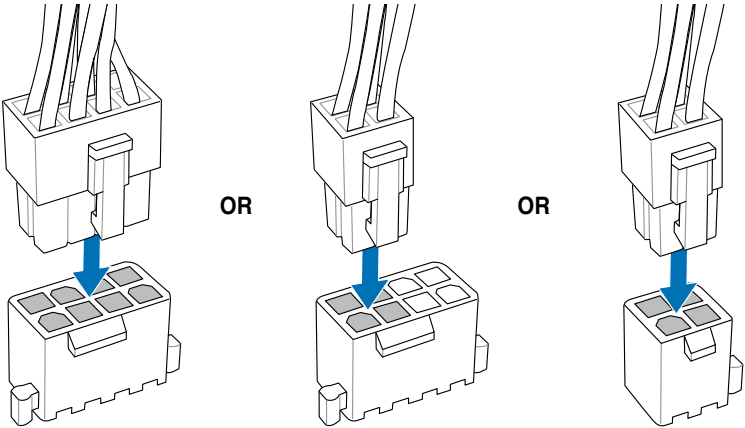

2.1.6 SATA device connection

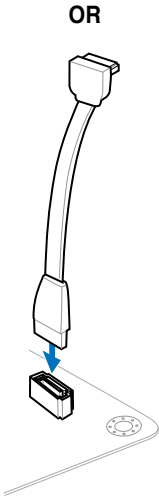
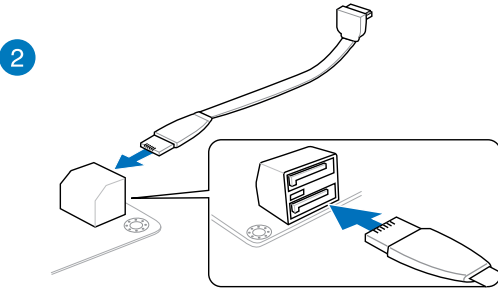
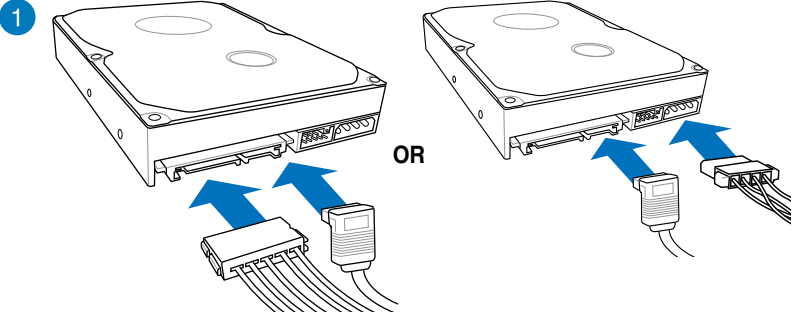

2.1.7 Front I/O Connectors

To install ASUS Q-Connector

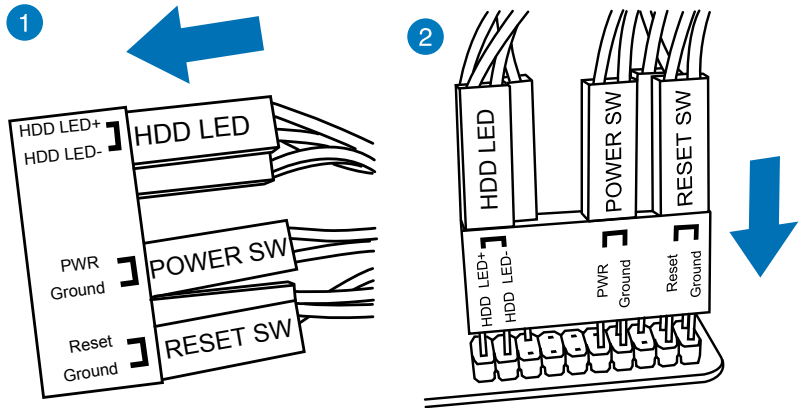

To install USB 2.0 connector

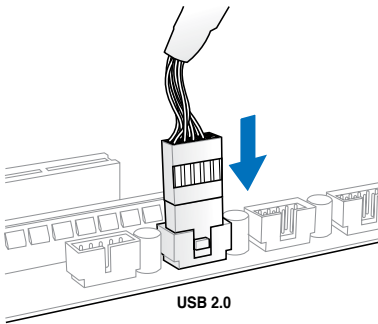

To install front panel audio connector

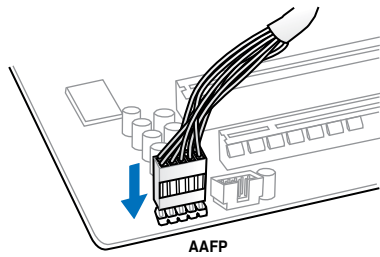

To install USB 3.0 connector

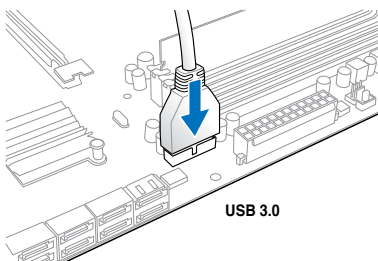

2.1.8 Expansion Card installation

To install PCIe x16 cards

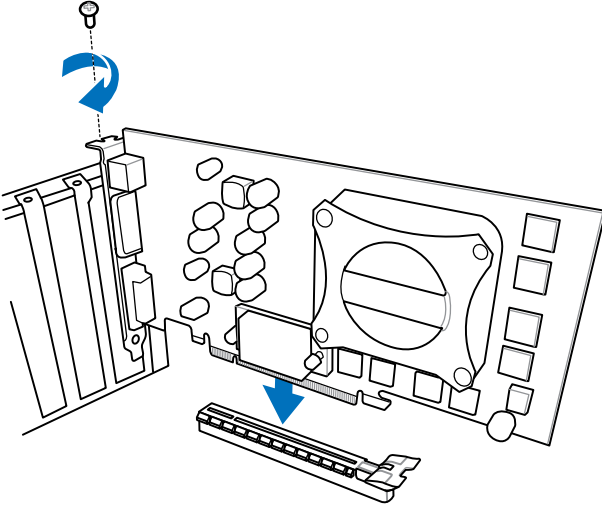

To install PCIe x1 cards

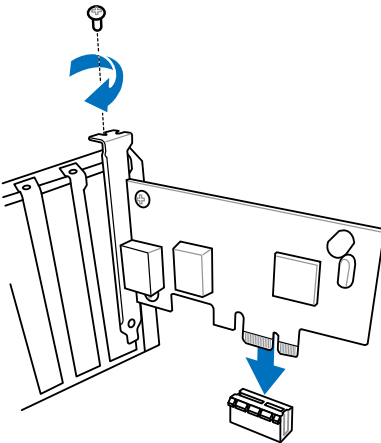

To install PCI cards

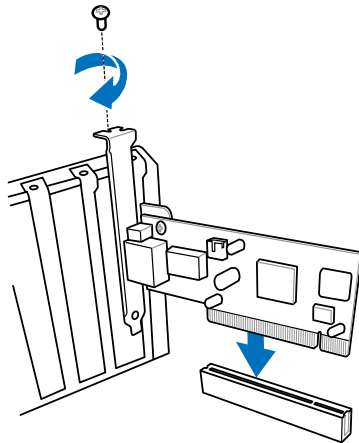

2.2 BIOS update utility

USB BIOS Flashback

USB BIOS Flashback allows you to easily update the BIOS without entering the existing BIOS or operating system. Simply insert a USB storage device to the USB port, press the USB BIOS Flashback button for three seconds, and the BIOS is updated automatically.

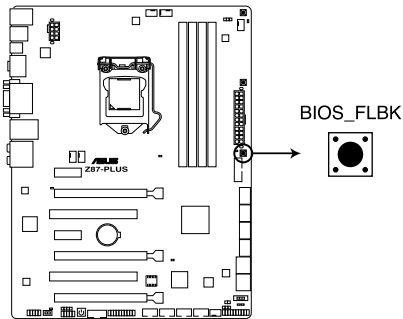

Z87-PLUS BIOS_FLBK button

To use USB BIOS Flashback:

1. Place the bundled support DVD to the optical drive and install the USB BIOS Flashback Wizard. Follow the onscreen instructions to complete the installation.
2. Insert the USB storage device to the USB Flashback port.



We recommend you to use a USB 2.0 storage device to save the latest BIOS version for better compatibility and stability.

3. Launch the USB BIOS Flashback Wizard to automatically download the latest BIOS version.
4. Press the BIOS Flashback button for three seconds until a flashing light appears, which indicates that the BIOS Flashback function is enabled.
5. Wait until the light goes out, indicating that the BIOS updating process is completed.



For more BIOS update utilities in BIOS setup, refer to the section **3.11 Updating BIOS** in Chapter 3.

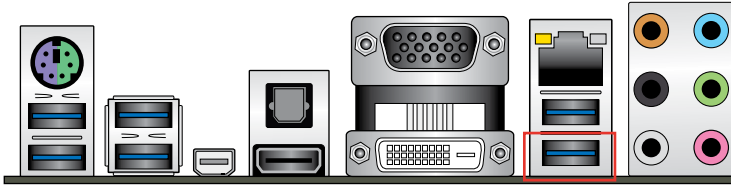

1. Do not disconnect the USB flash drive or power system, or move the CLRTC jumper during the BIOS updating process. Doing so will interrupt the BIOS updating process. In case of interruption, follow the steps again to update the BIOS.
 2. If FLBK_LED flashes for five seconds and turns into a stable light, this indicates that USB BIOS Flashback is not working properly due to improper USB flash drive connection, BIOS file name error, or incompatible BIOS file format. If this happens, restart the system.
 3. BIOS updating poses some risks. If the BIOS program is damaged during the updating process and the system fails to reboot, please contact your local ASUS Service Center for assistance
-

2.3 Motherboard rear and audio connections

2.3.1 Rear I/O connection

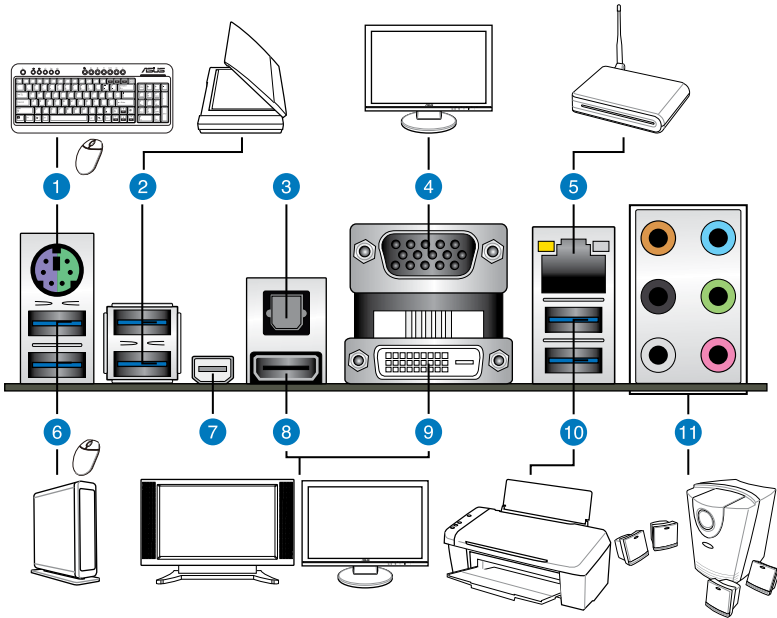

Rear panel connectors

1. PS/2 keyboard/mouse combo port	7. Mini DisplayPort
2. ASMedia® USB 3.0 ports, support ASUS USB 3.0 Boost.	8. HDMI port
3. Optical S/PDIF Out port	9. DVI port
4. VGA port	10. Intel® USB 3.0 ports, support ASUS USB 3.0 Boost Turbo Mode. (Bottom port supports USB BIOS Flashback and USB Charger+)
5. Intel® LAN (RJ-45) port*	11. Audio I/O ports**
6. ASMedia® USB 3.0 ports support ASUS USB 3.0 Boost	

* and **: Refer to the tables on the next page for LAN port LEDs, and audio port definitions.



- The plugged USB 3.0 device may run on xHCI or EHCI mode, depending on the operating system's setting.
- USB 3.0 devices can only be used as data storage only.
- We strongly recommend that you connect USB 3.0 devices to USB 3.0 ports for faster and better performance for your USB 3.0 devices.
- Due to the design of the Intel® 8 series chipset, all USB devices connected to the USB 2.0 and USB 3.0 ports are controlled by the xHCI controller. Some legacy USB devices must update their firmware for better compatibility.
- Multi-VGA output supports up to three displays under Windows® OS environment, two displays under BIOS, and one display under DOS.
- Intel display architecture design supports the following maximum supported pixel clocks (Pixel Clock = H total x V Total x Frame Rate (Screen refresh rate)):
 - DisplayPort/mini DisplayPort: 533 MHz
 - DVI-D: 165 MHz
 - RGB: 180 MHz
 - HDMI port: 300 MHz

** LAN ports LED indications

Activity Link LED		Speed LED	
Status	Description	Status	Description
Off	No link	Off	10 Mbps connection
Orange	Linked	Orange	100 Mbps connection
Orange (Blinking)	Data activity	Green	1 Gbps connection
Orange (Blinking then steady)	Ready to wake up from S5 mode		

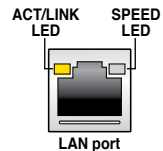

***** Audio 2, 4, 6, or 8-channel configuration**

Port	Headset 2-channel	4-channel	6-channel	8-channel
Light Blue	Line In	Line In	Line In	Line In
Lime	Line Out	Front Speaker Out	Front Speaker Out	Front Speaker Out
Pink	Mic In	Mic In	Mic In	Mic In
Orange	–	–	Center/Subwoofer	Center/Subwoofer
Black	–	Rear Speaker Out	Rear Speaker Out	Rear Speaker Out
Gray	–	–	–	Side Speaker Out

2.3.2 Audio I/O connections

Audio I/O ports

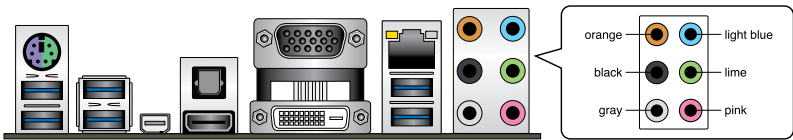

Connect to Headphone and Mic



Connect to Stereo Speakers

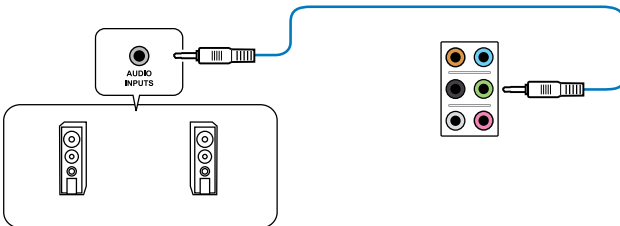

Connect to 2.1 channel Speakers

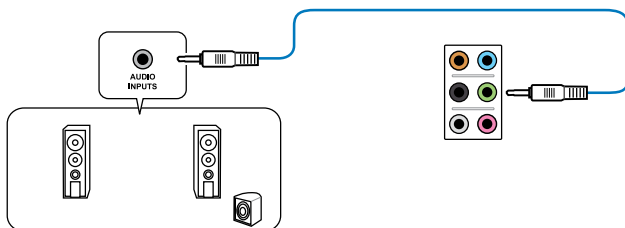

Connect to 4.1 channel Speakers

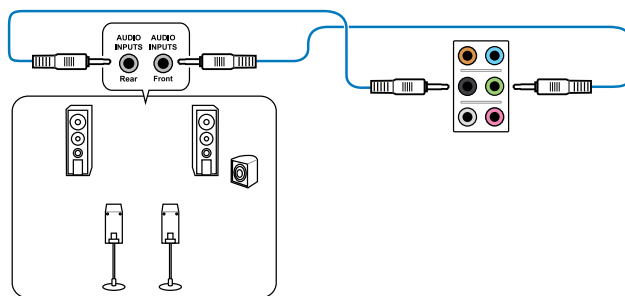

Connect to 5.1 channel Speakers

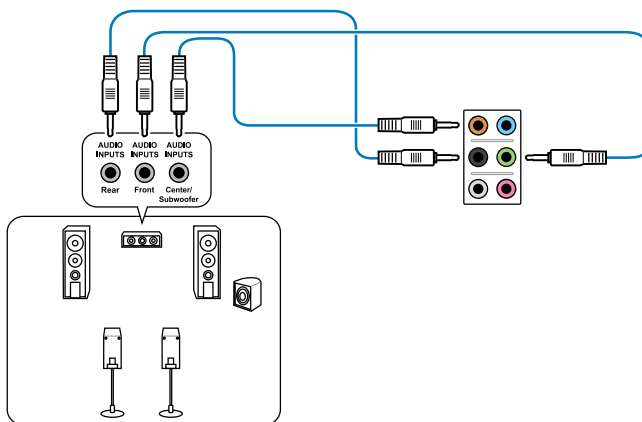

Connect to 7.1 channel Speakers

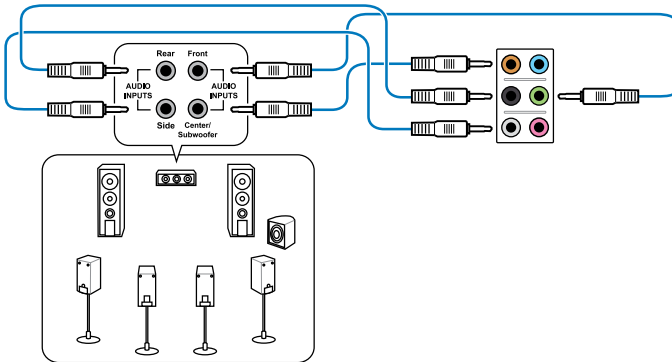

When the DTS UltraPC II function is enabled, ensure to connect the rear speaker to the gray port.

2.4 Starting up for the first time

1. After making all the connections, replace the system case cover.
2. Ensure that all switches are off.
3. Connect the power cord to the power connector at the back of the system chassis.
4. Connect the power cord to a power outlet that is equipped with a surge protector.
5. Turn on the devices in the following order:
 - a. Monitor
 - b. External SCSI devices (starting with the last device on the chain)
 - c. System power
6. After applying power, the system power LED on the system front panel case lights up. For systems with ATX power supplies, the system LED lights up when you press the ATX power button. If your monitor complies with the “green” standards or if it has a “power standby” feature, the monitor LED may light up or change from orange to green after the system LED turns on.

The system then runs the power-on self tests (POST). While the tests are running, the BIOS beeps (refer to the BIOS beep codes table) or additional messages appear on the screen. If you do not see anything within 30 seconds from the time you turned on the power, the system may have failed a power-on test. Check the jumper settings and connections or call your retailer for assistance.

BIOS Beep	Description
One short beep	VGA detected Quick boot set to disabled No keyboard detected
One continuous beep followed by two short beeps then a pause (repeated)	No memory detected
One continuous beep followed by three short beeps	No VGA detected
One continuous beep followed by four short beeps	Hardware component failure

- At power on, hold down the <Delete> key to enter the BIOS Setup. Follow the instructions in Chapter 3.

2.5 Turning off the computer

While the system is ON, press the power button for less than four seconds to put the system on sleep mode or soft-off mode, depending on the BIOS setting. Press the power switch for more than four seconds to let the system enter the soft-off mode regardless of the BIOS setting.

BIOS setup

3

3.1 Knowing BIOS



The new ASUS UEFI BIOS is a Unified Extensible Interface that complies with UEFI architecture, offering a user-friendly interface that goes beyond the traditional keyboard-only BIOS controls to enable a more flexible and convenient mouse input. You can easily navigate the new UEFI BIOS with the same smoothness as your operating system. The term "BIOS" in this user manual refers to "UEFI BIOS" unless otherwise specified.

BIOS (Basic Input and Output System) stores system hardware settings such as storage device configuration, overclocking settings, advanced power management, and boot device configuration that are needed for system startup in the motherboard CMOS. In normal circumstances, the default BIOS settings apply to most conditions to ensure optimal performance. **DO NOT change the default BIOS settings** except in the following circumstances:

- An error message appears on the screen during the system bootup and requests you to run the BIOS Setup.
- You have installed a new system component that requires further BIOS settings or update.



Inappropriate BIOS settings may result to instability or boot failure. **We strongly recommend that you change the BIOS settings only with the help of a trained service personnel.**



When downloading or updating the BIOS file, rename it as **Z87PL.CAP** for this motherboard.

3.2 BIOS setup program

Use the BIOS Setup to update the BIOS or configure its parameters. The BIOS screen include navigation keys and brief onscreen help to guide you in using the BIOS Setup program.

Entering BIOS at startup

To enter BIOS Setup at startup:

- Press <Delete> during the Power-On Self Test (POST). If you do not press <Delete>, POST continues with its routines.

Entering BIOS Setup after POST

To enter BIOS Setup after POST:

- Press <Ctrl>+<Alt>+<Delete> simultaneously.
- Press the reset button on the system chassis.
- Press the power button to turn the system off then back on. Do this option only if you failed to enter BIOS Setup using the first two options.



-
- The BIOS setup screens shown in this section are for reference purposes only, and may not exactly match what you see on your screen.
 - Ensure that a USB mouse is connected to your motherboard if you want to use the mouse to control the BIOS setup program.
 - If the system becomes unstable after changing any BIOS setting, load the default settings to ensure system compatibility and stability. Select the **Load Optimized Defaults** item under the **Exit** menu or press hotkey <F5>. See section 3.9 **Exit Menu** for details.
 - If the system fails to boot after changing any BIOS setting, try to clear the CMOS and reset the motherboard to the default value. See section 1.2.6 **Onboard buttons and switches** for information on how to erase the RTC RAM via the Clear CMOS button.
 - The BIOS setup program does not support the bluetooth devices.
-

BIOS menu screen

The BIOS Setup program can be used under two modes: **EZ Mode** and **Advanced Mode**. You can change modes from the **Exit** menu or from the **Exit/Advanced Mode** screen.

3.2.1 EZ Mode

By default, the EZ Mode screen appears when you enter the BIOS setup program. The EZ Mode provides you an overview of the basic system information, and allows you to select the display language, system performance mode and boot device priority. To access the Advanced Mode, click **Exit/Advanced Mode**, then select **Advanced Mode** or press <F7> hot key for the advanced BIOS settings.



The default screen for entering the BIOS setup program can be changed. Refer to the **Setup Mode** item in section 3.8 **Boot menu** for details.

Displays the CPU/motherboard temperature, CPU/5V/3.3V/12V voltage output, CPU/chassis/power fan speed

Selects the display language of the BIOS setup program

Exits the BIOS setup program without saving the changes, saves the changes and resets the system, or enters the Advanced Mode

Displays the selected shortcut items

Displays the Advanced mode menus

Selects the boot device priority

Displays the system properties of the selected mode on the right hand side

Loads optimized default settings



- The boot device options vary depending on the devices you installed to the system.
- **The Boot Menu(F8)** button is available only when the boot device is installed to the system.

3.2.2 Advanced Mode

The Advanced Mode provides advanced options for experienced end-users to configure the BIOS settings. The figure below shows an example of the Advanced Mode. Refer to the following sections for the detailed configurations.



To access the Advanced Mode, click **Exit**, then select **Advanced Mode** or press **F7** hotkey.

The screenshot shows the ASUS UEFI BIOS Utility in Advanced Mode. The interface includes a menu bar at the top with options like 'My Favorites', 'Main', 'Ai Tweaker', 'Advanced', 'Monitor', 'Boot', and 'Tool'. The main area displays various configuration options such as 'Advanced CPU Configuration', 'Intel Adaptive Thermal Monitor', 'Hyper-Threading', 'Active Processor Cores', 'Limit OPED Maxima', 'Decode Disable Bit', 'Intel Virtualization Technology', 'Hardware Prefetcher', 'Adjacent Cache Line Prefetch', 'Boot performance mode', and 'Basic Storage Accelerator'. A 'Quick Note' window is open on the right, listing navigation keys like F4 for 'Select Screen' and F12 for 'Print Screen'. Red boxes and lines label various parts of the interface: 'Back button' (top left), 'Menu bar' (top), 'General help' (top right), 'Menu items' (left side), 'Submenu item' (left side), 'Pop-up window' (Quick Note), 'Configuration fields' (various settings), 'Scroll bar' (right side), 'Navigation keys' (bottom right), 'Last modified settings' (bottom right), and 'Quick note' (bottom right).

Menu bar

The menu bar on top of the screen has the following main items:

My Favorites	For saving the frequently-used system settings and configuration.
Main	For changing the basic system configuration
Ai Tweaker	For changing the overclocking settings
Advanced	For changing the advanced system settings
Monitor	For displaying the system temperature, power status, and changing the fan settings.
Boot	For changing the system boot configuration
Tool	For configuring options for special functions
Exit	For selecting the exit options and loading default settings

Menu items

The highlighted item on the menu bar displays the specific items for that menu. For example, selecting **Main** shows the Main menu items.

The other items (Ai Tweaker, Advanced, Monitor, Boot, Tool, and Exit) on the menu bar have their respective menu items.

Back button

This button appears when entering a submenu. Press <Esc> or use the USB mouse to click this button to return to the previous menu screen.

Submenu items

A greater than sign (>) before each item on any menu screen means that the item has a submenu. To display the submenu, select the item and press <Enter>.

Pop-up window

Select a menu item and press <Enter> to display a pop-up window with the configuration options for that item.

Scroll bar

A scroll bar appears on the right side of a menu screen when there are items that do not fit on the screen. Press the Up/Down arrow keys or <Page Up> / <Page Down> keys to display the other items on the screen.

Navigation keys

At the bottom right corner of the menu screen are the navigation keys for the BIOS setup program. Use the navigation keys to select items in the menu and change the settings.



If you delete all shortcut items from the F3: Shortcut list, the default shortcut items will reappear after your next startup.

General help

At the top right corner of the menu screen is a brief description of the selected item. Use <F12> key to capture the BIOS screen and save it to the removable storage device.

Configuration fields

These fields show the values for the menu items. If an item is user-configurable, you can change the value of the field opposite the item. You cannot select an item that is not user-configurable.

A configurable field is highlighted when selected. To change the value of a field, select it and press <Enter> to display a list of options.

Quick Note button

This button allows you to enter notes of the activities that you have done in BIOS.



-
- The Quick Note function does not support the following keyboard functions: delete, cut, copy and paste.
 - You can only use the alphanumeric characters to enter your notes.
-

Last Modified button

This button shows the items that you last modified and saved in BIOS Setup.

3.3 My Favorites

MyFavorites is your personal space where you can easily save and access your favorite BIOS items.



Adding items to My Favorites

To add frequently-used BIOS items to My Favorites:

1. Use the arrow keys to select an item that you want to add. When using a mouse, hover the pointer to the item.
2. Press <F4> on your keyboard or right-click on your mouse to add the item to My Favorites page.



You cannot add the following items to My Favorites:

- Items with submenu options
- User-configurable items such as language and boot device order
- Configuration items such as Memory SPD Information, system time and date

3.4 Main menu

The Main menu screen appears when you enter the Advanced Mode of the BIOS Setup program. The Main menu provides you an overview of the basic system information, and allows you to set the system date, time, language, and security settings.

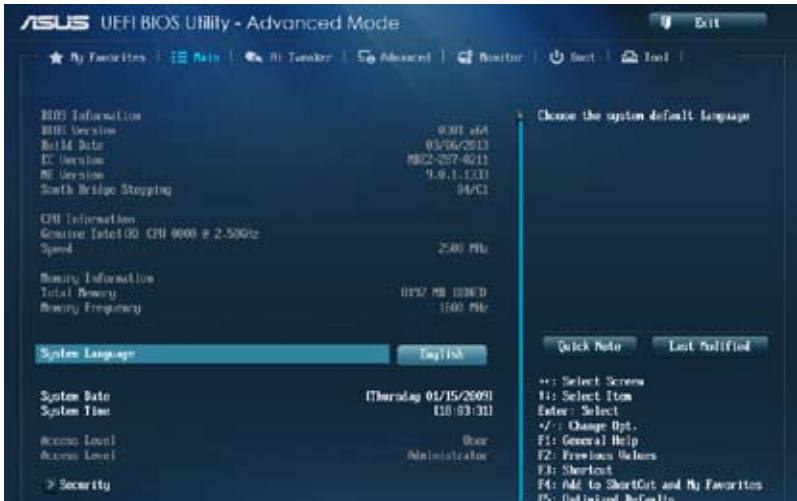

Security

The Security menu items allow you to change the system security settings.

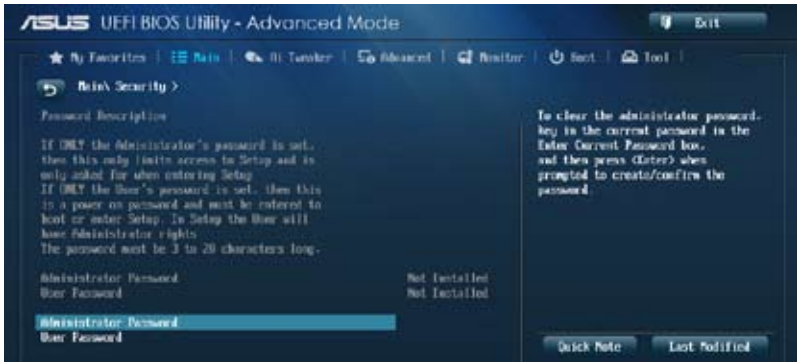

- If you have forgotten your BIOS password, erase the CMOS Real Time Clock (RTC) RAM to clear the BIOS password. See section 1.2.6 Onboard buttons and switches for information on how to erase the RTC RAM via the Clear CMOS button.
- The Administrator or User Password items on top of the screen show the default [Not Installed]. After you set a password, these items show [Installed].

Administrator Password

If you have set an administrator password, we recommend that you enter the administrator password for accessing the system. Otherwise, you might be able to see or change only selected fields in the BIOS setup program.

To set an administrator password:

1. Select the **Administrator Password** item and press <Enter>.
2. From the **Create New Password** box, key in a password, then press <Enter>.
3. Confirm the password when prompted.

To change an administrator password:

1. Select the **Administrator Password** item and press <Enter>.
2. From the **Enter Current Password** box, key in the current password, then press <Enter>.
3. From the **Create New Password** box, key in a new password, then press <Enter>.
4. Confirm the password when prompted.

To clear the administrator password, follow the same steps as in changing an administrator password, but press <Enter> when prompted to create/confirm the password. After you clear the password, the **Administrator Password** item on top of the screen shows **Not Installed**.

User Password

If you have set a user password, you must enter the user password for accessing the system. The User Password item on top of the screen shows the default Not Installed. After you set a password, this item shows Installed.

To set a user password:

1. Select the **User Password** item and press <Enter>.
2. From the **Create New Password** box, key in a password, then press <Enter>.
3. Confirm the password when prompted.

To change a user password:

1. Select the **User Password** item and press <Enter>.
2. From the **Enter Current Password** box, key in the current password, then press <Enter>.
3. From the **Create New Password** box, key in a new password, then press <Enter>.
4. Confirm the password when prompted.

To clear the user password, follow the same steps as in changing a user password, but press <Enter> when prompted to create/confirm the password. After you clear the password, the **User Password** item on top of the screen shows **Not Installed**.

3.5 Ai Tweaker menu

The Ai Tweaker menu items allow you to configure overclocking-related items.



Be cautious when changing the settings of the Ai Tweaker menu items. Incorrect field values can cause the system to malfunction.



The configuration options for this section vary depending on the CPU and DIMM model you installed on the motherboard.

Scroll down to display other BIOS items.



Ai Overclock Tuner [Auto]

Allows you to select the CPU overclocking options to achieve the desired CPU internal frequency. Select any of these preset overclocking configuration options:

- [Auto] Loads the optimal settings for the system.
- [Manual] Allows you to automatically optimize the CPU ratio and BCLK frequency.
- [X.M.P.] Allows your system to automatically optimize the CPU ratio, BCLK frequency, and memory parameters. If you install memory modules supporting the eXtreme Memory Profile (X.M.P.) Technology, select this item to set the profiles supported by your memory modules for optimizing the system performance.



The following item appears only when you set the Ai Overclocking Tuner to **[Manual]**.

Filter PLL [Auto]

Allows you to select a BCLK (base clock) mode when running in a high or low BCLK. Configuration options: [Auto] [Low BCLK Mode] [High BCLK Mode]

BCLK/PEG Frequency [100.0]

Allows you to set the BCLK/PEG frequency to enhance the system performance. Use the <+> or <-> keys to adjust the value. The values range from 80.0MHz to 300.0MHz.



The following item appears only when you set the Ai Overclocking Tuner to **[X.M.P.]**.

eXtreme Memory Profile

Allows you to select the X.M.P. mode supported by your memory module. Configuration options: [Profile #1] [Profile #2]

ASUS MultiCore Enhancement [Enabled]

- [Enabled] Default set to **[Enabled]** for maximum performance under XMP/Manual/ User-defined memory frequency mode.
- [Disabled] Allows you to set to default core ratio settings.

CPU Core Ratio [Sync All Cores]

Allows you to set the CPU ratio and synchronize automatically either per core or all cores. Configuration options: [Auto] [Sync All Cores] [Per Core]



When the CPU Core Ratio is set to **[Per Core]**, the following item appears:

1-Core Ratio Limit [Auto]

Select **[Auto]** to apply the CPU default Turbo Ratio setting or manually assign a 1-Core Limit value that must be higher than or equal to the 2-Core Ratio Limit.

2-Core Ratio Limit [Auto]

Select **[Auto]** to apply the CPU default Turbo Ratio setting or manually assign a 2-Core Limit value that must be higher than or equal to the 3-Core Ratio Limit.



If you assign a value for 2-Core Ratio Limit, do not set the 1-Core Ratio Limit to **[Auto]**.

3-Core Ratio Limit [Auto]

Select **[Auto]** to apply the CPU default Turbo Ratio setting or manually assign a 3-Core Limit value that must be higher than or equal to the 4-Core Ratio Limit.



If you assign a value for 3-Core Ratio Limit, do not set the 1-Core Ratio Limit and 2-Core Ratio Limit to **[Auto]**.

4-Core Ratio Limit [Auto]

Select **[Auto]** to apply the CPU default Turbo Ratio setting or manually assign a 4-Core Limit value that must be higher than or equal to the 3-Core Ratio Limit.



If you assign a value for 4-Core Ratio Limit, do not set the 1-Core Ratio Limit, 2-Core Ratio Limit, and 3-Core Ratio to **[Auto]**.

Min CPU Cache Ratio [Auto]

Allows you to set the minimum possible ratio on the Uncore part of the processor. Use the <+> or <-> keys to adjust the value. The values depend on the CPU installed.

Max CPU Cache Ratio [Auto]

Allows you to set the maximum possible ratio on the Uncore part of the processor. Use the <+> or <-> keys to adjust the value. The values depend on the CPU installed.

Internal PLL Overvoltage [Auto]

Allows you to enable the internal PLL Overvoltage for K-SKU CPUs to get the extreme overclocking capability.

Configuration options: [Auto] [Enabled] [Disabled]

CPU bus speed : DRAM speed ratio mode [Auto]

Allows you to set the CPU bus speed to DRAM speed ratio mode.

[Auto] DRAM speed is set to the optimized settings.

[100:133] The CPU bus speed to DRAM speed ratio is set to 100:133.

[100:100] The CPU bus speed to DRAM speed ratio is set to 100:100.

Memory Frequency [Auto]

Allows you to set the memory operating frequency. The configuration options vary with the BCLK/PCIE Frequency item settings.

CPU Graphics Max. Ratio [Auto]

[Auto] Allows you to automatically optimize the CPU Graphics Ratio depending on the system loading.

[Manual] Allows you to set a value for an optimal CPU Graphics Ratio. Use the <+> or <-> keys to adjust the CPU graphics ratio. The minimum value depends on the installed CPU.

OC Tuner [As Is]

OC Tuner automatically overclocks the frequency and voltage of CPU and DRAM for enhancing the system performance and accelerates the iGPU performance to the extreme according to the integrated graphics loading.

Configuration options: [As Is] [Ratio only] [BCLK First]

EPU Power Saving Mode [Disabled]

Allows you to enable or disable the EPU power saving function.

Configuration options: [Disabled] [Enabled]

DRAM Timing Control

The subitems in this menu allow you to set the DRAM timing control features. Use the <+> or <-> keys to adjust the value. To restore the default setting, type [auto] using the keyboard and press the <Enter> key.



Changing the values in this menu may cause the system to become unstable! If this happens, revert to the default settings.

Primary Timings

DRAM CAS# Latency [Auto]

Configuration options: [Auto] [1] – [31]

DRAM RAS# to CAS# Delay [Auto]

Configuration options: [Auto] [1] – [31]

DRAM RAS# PRE Time [Auto]

Configuration options: [Auto] [1] – [31]

DRAM RAS# ACT Time [Auto]

Configuration options: [Auto] [1] – [63]

DRAM COMMAND Mode [Auto]

Configuration options: [Auto] [1] – [3]

Secondary Timings

DRAM RAS# to RAS# Delay [Auto]

Configuration options: [Auto] [1] – [15]

DRAM REF Cycle Time [Auto]

Configuration options: [Auto] [1] – [511]

DRAM Refresh Interval [Auto]

Configuration options: [Auto] [1] – [65535]

DRAM WRITE Recovery Time [Auto]

Configuration options: [Auto] [1] – [16]

DRAM READ to PRE Time [Auto]

Configuration options: [Auto] [1] – [15]

DRAM FOUR ACT WIN Time [Auto]

Configuration options: [Auto] [1] – [255]

DRAM WRITE to READ Delay [Auto]

Configuration options: [Auto] [1] – [15]

DRAM CKE Minimum pulse width [Auto]

Configuration options: [Auto] [1] – [15]

DRAM CAS# Write Latency [Auto]

Configuration options: [Auto] [1] – [31]

RTL IOL control

DRAM RTL (CHA_R0D0) [Auto]

Configuration options: [Auto] [1] - [63]

DRAM RTL (CHA_R0D1) [Auto]

Configuration options: [Auto] [1] - [63]

DRAM RTL (CHA_R1D0) [Auto]

Configuration options: [Auto] [1] - [63]

DRAM RTL (CHA_R1D1) [Auto]

Configuration options: [Auto] [1] - [63]

DRAM RTL (CHB_R0D0) [Auto]

Configuration options: [Auto] [1] - [63]

DRAM RTL (CHB_R0D1) [Auto]

Configuration options: [Auto] [1] - [63]

DRAM RTL (CHB_R1D0) [Auto]

Configuration options: [Auto] [1] - [63]

DRAM RTL (CHB_R1D1) [Auto]

Configuration options: [Auto] [1] - [63]

DRAM IO-L (CHA_R0D0) [Auto]

Configuration options: [Auto] [1] - [15]

DRAM IO-L (CHA_R0D1) [Auto]

Configuration options: [Auto] [1] - [15]

DRAM IO-L (CHA_R1D0) [Auto]

Configuration options: [Auto] [1] - [15]

DRAM IO-L (CHA_R1D1) [Auto]

Configuration options: [Auto] [1] - [15]

DRAM IO-L (CHB_R0D0) [Auto]

Configuration options: [Auto] [1] - [15]

DRAM IO-L (CHB_R0D1) [Auto]

Configuration options: [Auto] [1] - [15]

DRAM IO-L (CHB_R1D0) [Auto]

Configuration options: [Auto] [1] - [15]

DRAM IO-L (CHB_R1D1) [Auto]

Configuration options: [Auto] [1] - [15]

Third Timings

tRDRD [Auto]

Configuration options: [Auto] [1] - [7]

tRDRD_dr [Auto]

Configuration options: [Auto] [1] - [15]

tRDRD_dd [Auto]

Configuration options: [Auto] [1] - [15]

tWRRD [Auto]

Configuration options: [Auto] [1] - [63]

tWRRD_dr [Auto]

Configuration options: [Auto] [1] - [15]

tWRRD_dd [Auto]

Configuration options: [Auto] [1] - [15]

tWRWR [Auto]

Configuration options: [Auto] [1] - [7]

tWRWR_dr [Auto]

Configuration options: [Auto] [1] - [15]

tWRWR_dd [Auto]

Configuration options: [Auto] [1] - [15]

Dec_WRD

Configuration options: [Auto] [0] - [1]

tRDWR [Auto]

Configuration options: [Auto] [1] - [31]

tRDWR_dr [Auto]

Configuration options: [Auto] [1] - [31]

tRDWR_dd [Auto]

Configuration options: [Auto] [1] - [31]

MISC

MRC Fast Boot [Auto]

Allows you to enable, disable or automatically set the MRC fast boot.

Configuration options: [Auto] [Enable] [Disable]

DRAM CLK Period [Auto]

Configuration options: [Auto] [1] – [14]

Channel A/B DIMM Control [Enable Bot...]

Configuration options: [Enable Both DIMMS] [Disable DIMM0] [Disable DIMM1] [Disable Both DIMMS]

Scrambler Setting [Optimized ...]

Allows you to set the optimized scrambler setting for stability.

Configuration options: [Optimized (ASUS)] [Default (MRC)]

DIGI+ Power Control

CPU Load-Line Calibration [Auto]

Load-line is defined by Intel® VRM specification and affects CPU power voltage. The CPU working voltage will decrease proportionally to CPU loading. Higher load-line calibration could get higher voltage and good overclocking performance, but increases the CPU and VRM thermal conditions.

Select from Level 1 to Level 8 to adjust CPU power voltage from 0% to 100%.



The actual performance boost may vary depending on your CPU specification.



DO NOT remove the thermal module. The thermal conditions should be monitored.

CPU Voltage Frequency [Auto]

Frequency switching affects the VRM transient response and the thermal component conditions. Higher frequency gets quicker transient response.

Configuration options: [Auto] [Manual]



DO NOT remove the thermal module when setting this item to **[Manual Mode]**. The thermal conditions should be monitored.



The following item appears only when you set the CPU Voltage Frequency to **[Manual]**.

CPU Fixed Frequency [300]

This item allows you to set a fixed CPU Voltage frequency. Use the <+> or <-> keys to adjust the value. The values range from 300kHz to 500kHz with a 50kHz interval.



The following items appear only when you set the CPU Voltage Frequency to **[Auto]**.

VRM Spread Spectrum [Disabled]

Enable the VRM Spread Spectrum to enhance system stability.

Configuration options: [Disabled] [Enabled]

Active Frequency Mode [Disabled]

Enable the Active Frequency Mode for an enhanced power saving condition.

Configuration options: [Disabled] [Enabled]

CPU Power Phase Control [Standard]

Allows you to set the power phase control of the CPU.

Configuration options: [Standard] [Optimized] [Extreme] [Manual Adjustment]



DO NOT remove the thermal module when setting this item to **[Extreme]** and **[Manual Adjustment]**. The thermal conditions should be monitored.



The following item appears only when you set the CPU Power Phase Control to **[Manual Adjustment]**.

Manual Adjustment [Fast]

Allows you to set a faster phase response for the CPU to increase system performance or to slower phase response to decrease DRAM power efficiency.

Configuration options: [Ultra Fast] [Fast] [Medium] [Regular]

CPU Power Duty Control [T.Probe]

DIGI + VRM Duty Control adjusts the current of every VRM phase and the thermal conditions of every phase component.

[T. Probe] Select to maintain the VRM thermal balance.

[Extreme] Select to maintain the current VRM balance.



DO NOT remove the thermal module. The thermal conditions should be monitored.

CPU Current Capability [Auto]

DIGI+ VRM CPU Current Capability provides wider total power range for overclocking. A higher value setting gets higher VRM power consumption delivery and extends the overclocking frequency range simultaneously.

Configuration options: [Auto] [100%] [110%] [120%] [130%] [140%]



Choose a higher value when overclocking, or under a high CPU loading for extra power support.

CPU Power Thermal Control [130]

A higher temperature brings a wider CPU power thermal range and extends the overclocking tolerance to enlarge the O.C. potential. Use the <+> or <-> keys to adjust the value. The values depend on the CPU installed.



DO NOT remove the thermal module. The thermal conditions should be monitored.

DRAM Current Capability [100%]

A higher value brings a wider total power range, and extends the overclocking range simultaneously.

Configuration options: [100%] [110%] [120%] [130%]

DRAM Voltage Frequency [Auto]

Allows you to adjust the DRAM switching frequency. Assign a fixed high DRAM frequency to increase the O.C. range, or a low DRAM frequency for a better system stability.

Configuration options: [Auto] [Manual]



The following item appears only when you set the DRAM Frequency Mode item to [Manual].

DRAM Fixed Frequency Mode [300]

Allows you to set a fixed DRAM frequency to increase the overclocking range or a low DRAM frequency for better system stability. Use the <+> or <-> keys to adjust the value. The values range from 300kHz to 500kHz with a 50kHz interval.

DRAM Power Phase Control [Auto]

- | | |
|-------------|--|
| [Auto] | Allows you to set the Auto mode. |
| [Optimized] | Allows you to set the ASUS optimized phase tuning profile. |
| [Extreme] | Allows you to set the full phase mode. |

CPU Power Management

The subitems in this menu allow you to set the CPU ratio and their features.

Enhanced Intel SpeedStep Technology [Enabled]

Allows the operating system to dynamically adjust the processor voltage and cores frequency, resulting to a decreased average power consumption and decreased average heat production.

Configuration options: [Disabled] [Enabled]

Turbo Mode [Enabled]

Allows you to enable your core processor's speed to run faster than the base operating frequency when it is below operating power, current and temperature specification limit.

Configuration options: [Disabled] [Enabled]



The following items appear only when you set the Turbo Mode to [Enabled].

Turbo Mode Parameters

Long Duration Package Power Limit [Auto]

Allows you to limit the Turbo Ratio's time duration that exceeds the TDP (Thermal Design Power) for maximum performance. Use the <+> or <-> keys to adjust the value. The values range from 1W to 4096W.

Package Power Time Window [Auto]

Also known as Power Limit 1, and allows you to maintain the time window for Turbo Ratio over TDP (Thermal Design Power). Use the <+> or <-> keys to adjust the value. The values range from 1 to 127 in seconds.

Short Duration Package Power Limit [Auto]

Also known as Power Limit 2, and allows you to provide rapid protection when the package power exceeds the Power Limit 1. Use the <+> or <-> keys to adjust the value. The values range from 1W to 4096W.

CPU Integrated VR Current Limit [Auto]

Allows you to set a higher current limit to prevent frequency and power throttling when overclocking. Use the <+> or <-> keys to adjust the value. The values range from 0.125 to 1023.875 with a 0.125 interval.

CPU Internal Power Switching Frequency

Frequency Tuning Mode [Auto]

Allows you to increase or decrease the switching frequency of the internal regulator. Decrease to help consume less power or increase to help voltage stability. When this item is set to [+] or [-], the Frequency Tuning Offset appears and allows you to set its value from 0% to 6%.

CPU Internal Power Fault Control

Thermal Feedback [Auto]

Allows your system to take precautionary actions to be taken by the CPU when the thermal conditions of the external regulator exceeds the threshold.

Configuration options: [Auto] [Disabled] [Enabled]

CPU Integrated VR Fault Management [Auto]

Disable this item to prevent tripping the Fully Integrated Voltage Regulator when doing over-voltage. We recommend you to disable this item when overclocking.

Configuration options: [Auto] [Disabled] [Enabled]

CPU Internal Power Configuration

CPU Integrated VR Efficiency Management [Auto]

Allows you to improve power saving when the processor is in low power state. Disable to make the Fully Integrated Voltage Regulator work in high performance at all times.

Configuration options: [Auto] [High Performance] [Balanced]

Power Decay Mode [Auto]

Allows your system to improve the power saving mode on the Fully Integrated Voltage Regulator as the processor goes into low current state.

Configuration options: [Auto] [Disabled] [Enabled]

Idle Power-in Response [Auto]

Allows you to set the slew rate for the Fully Integrated Voltage Regulator as it enters manual override mode.

Configuration options: [Auto] [Regular] [Fast]

Idle Power-out Response [Auto]

Allows you to set the slew rate for the Fully Integrated Voltage Regulator as it exits manual override mode.

Configuration options: [Auto] [Regular] [Fast]

Power Current Slope [Auto]

Allows you to set the gradient of the high-speed active phase current balance during load transients to eliminate current imbalance that can result from a load current oscillating near the switching frequency.

Configuration options: [Auto] [LEVEL -4] - [LEVEL 4]

Power Current Offset [Auto]

Allows you to increase or decrease the output current sensed by the CPU. It finds the balance between optimal regulating while staying below the current threshold.

Configuration options: [Auto] [100%] [87.5%] [75.0%] [62.5%] [50.0%] [37.5%] [25.0%] [12.5%] [0%] [-12.5%] [-25.0%] [-37.5%] [-50.0%] [-62.5%] [-75.0%] [-87.5%] [-100%]

Power Fast Ramp Response [Auto]

Allows you to increase to enhance the response of the voltage regulator during the load transient.

Configuration options: [Auto] [0.00] - [1.50]

CPU Internal Power Saving Control**Power Saving Level 1 Threshold [Auto]**

Lower value provides sufficient overclocking tolerance to enlarge the overclocking potential. Higher value provides better power-saving condition. Use <+> or <-> key to adjust the value. The values range from 0A to 80A at 1Amp increment.

Power Saving Level 2 Threshold [Auto]

Lower value provides sufficient overclocking tolerance to enlarge the overclocking potential. Higher value provides better power-saving condition. Use <+> or <-> key to adjust the value. The values range from 0A to 50A at 1Amp increment.

Power Saving Level 3 Threshold [Auto]

Lower value provides sufficient overclocking tolerance to enlarge the overclocking potential. Higher value provides better power-saving condition. Use <+> or <-> key to adjust the value. The values range from 0A to 30A at 1Amp increment.

Extreme OV [Disabled]

Default set to Disabled and help to protect CPU not been burned by Over Voltage. When set to Enabled, you might choose high level voltage to overclock, but not guaranteed CPU life.

Configuration options: [Disabled] [Enabled]

CPU Core Voltage [Auto]

Allows you to configure the amount of voltage fed to the cores of the processor. Increase the amount of voltage when increasing core frequency.

Configuration options: [Auto] [Manual Mode] [Offset Mode] [Adaptive Mode]



The following item appears only when you set the CPU Core Voltage to **[Manual]**.

CPU Core Voltage Override [Auto]

Allows you to set the CPU Core Voltage override. Use the <+> or <-> keys to adjust the value, The values range from 0.001V to 1.920V with a 0.001V interval.



The following items appear only when you set the CPU Core Voltage to **[Offset Mode]** or **[Adaptive Mode]**.

Offset Mode Sign [+]

[+] To offset the voltage by a positive value.

[-] To offset the voltage by a negative value.

CPU Core Voltage Offset

Use the <+> or <-> keys to adjust the value. The values range from 0.001V to 0.999V with a 0.001V interval.



The following item appears only when you set the CPU Core Voltage to **[Adaptive Mode]**.

Additional Turbo Mode CPU Core Voltage [Auto]

Allows you to add voltage for Turbo Mode CPU core. Use the <+> or <-> keys to adjust the value. The values range from 0.001V to 1.920V with a 0.001V interval.

CPU Graphics Voltage [Auto]

Allows you to configure the amount of voltage fed to the onboard graphics unit on the processor. Increase the amount of voltage when increasing iGPU frequency.

Configuration options: [Auto] [Manual Mode] [Offset Mode] [Adaptive Mode]



The following item appears only when you set the CPU Core Voltage to **[Manual]**.

CPU Graphics Voltage Override [Auto]

Allows you to set the CPU Graphics Voltage override. Use the <+> or <-> keys to adjust the value, The values range from 0.001V to 1.920V with a 0.001V interval.



The following items appear only when you set the CPU Core Voltage to **[Offset Mode]** or **[Adaptive Mode]**.

Offset Mode Sign [+]

- [+] To offset the voltage by a positive value.
- [-] To offset the voltage by a negative value.

CPU Graphics Voltage Offset

Use the <+> or <-> keys to adjust the value. The values range from 0.001V to 0.999V with a 0.001V interval.



The following item appears only when you set the CPU Core Voltage to **[Adaptive Mode]**.

Additional Turbo Mode CPU Graphics Voltage [Auto]

This item allows you to add voltage for Turbo Mode CPU Graphics. Use the <+> or <-> keys to adjust the value. The values range from 0.001V to 1.920V with a 0.001V interval.

CPU Cache Voltage [Auto]

Allows you to configure the amount of voltage fed to the uncore of the processor including its cache. Increase the voltage when increasing Ring frequency.

Configuration options: [Auto] [Manual Mode] [Offset Mode]



The following item appears only when you set the CPU Cache Voltage to **[Manual Mode]**.

CPU Cache Voltage Override [Auto]

Allows you to set the CPU Cache Voltage override. Use the <+> or <-> keys to adjust the value. The values range from 0.001V to 1.920V with a 0.001V interval.



The following items appear only when you set the CPU Core Voltage to **[Offset Mode]**.

Offset Mode Sign [+]

- [+] To offset the voltage by a positive value.
- [-] To offset the voltage by a negative value.

CPU Cache Voltage Offset

Allows you to set the CPU cache voltage offset. Use the <+> or <-> keys to adjust the value. The values range from 0.001V to 0.999V with a 0.001V interval.

CPU System Agent Voltage Offset Mode Sign [+]

- [+] To offset the voltage by a positive value.
- [-] To offset the voltage by a negative value.

CPU System Agent Voltage Offset [Auto]

Allows you to configure the amount of voltage fed to the system agent of the processor including its PCIe controller and power control unit. Increase the amount of voltage when increasing DRAM frequency. Use the <+> or <-> keys to adjust the value. The values range from 0.001V to 0.999V with a 0.001V interval.

CPU Analog I/O Voltage Offset Mode Sign [+]

- [+] To offset the voltage by a positive value.
- [-] To offset the voltage by a negative value.

CPU Analog I/O Voltage Offset [Auto]

Allows you to configure the amount of voltage fed to the analog portion of the I/O on the processor. Increase the amount of voltage when increasing DRAM frequency. Use the <+> or <-> keys to adjust the value. The values range from 0.001V to 0.999V with a 0.001V interval.

CPU Digital I/O Voltage Offset Mode Sign [+]

- [+] To offset the voltage by a positive value.
- [-] To offset the voltage by a negative value.

CPU Digital I/O Voltage Offset [Auto]

Allows you to configure the amount of voltage fed to the digital portion of the I/O on the processor. Increase the amount of voltage when increasing DRAM frequency. Use the <+> or <-> keys to adjust the value. The values range from 0.001V to 0.999V with a 0.001V interval.

SVID Support [Auto]

When overclocking, set this item to **[Enabled]**. Disabling this item would stop the processor from communicating with the external voltage regulator.

Configuration options: [Auto] [Disabled] [Enabled]



The following item appears only when you set SVID Support to **[Enabled]**.

SVID Voltage Override [Auto]

Allows you to set the SVID Voltage override. By default, this item takes the standard value of the installed CPU. You can use the <+> or <-> keys to adjust the value. The values range from 0.001V to 2.440V with a 0.001V interval.

CPU Input Voltage [Auto]

Allows you to set an input voltage for the processor by the external voltage regulator. By default, this item takes the standard value of the installed CPU. You can use the <+> or <-> keys to adjust the value. The values range from 0.800V to 3.040V with a 0.010V interval.

DRAM Voltage [Auto]

Allows you to set the DRAM voltage. You can use the <+> or <-> keys to adjust the value. The values range from 1.20V to 1.92V with a 0.005V interval.



According to Intel® CPU specifications, DIMMs with voltage requirement over 1.65V may damage the CPU permanently. We recommend that you install the DIMMs with the voltage requirement below 1.65V.

PCH VLX Voltage [Auto]

Allows you to set the voltage for the I/O on the PCH. Use the <+> or <-> keys to adjust the value. The values range from 1.2000V to 2.0000V with a 0.0125V interval.

PCH Voltage [Auto]

Allows you to set the Core voltage for the PCH (Platform Controller Hub). You can use the <+> or <-> keys to adjust the value. The values range from 0.70V to the maximum voltage of installed DRAM with a 0.0125V interval.



- The values of the CPU PLL Voltage, CPU Manual Voltage, CPU Offset Voltage, iGPU Manual Voltage, iGPU Offset Voltage, DRAM Voltage, VCCSA Voltage, VCCIO Voltage, and PCH Voltage items are labeled in different color, indicating the risk levels of high voltage settings.
- The system may need better cooling system for a more stable performance under high voltage settings.

VTTDDR Voltage [Auto]

Allows you to set the termination voltage for the system memory. You can use the <+> or <-> keys to adjust the value. The values range from 0.6000V to 1.0000V with a 0.0125V interval.

DRAM CTRL REF Voltage [Auto]

This item is the DRAM reference voltage for the control lines from the memory bus. You can use the <+> or <-> keys to adjust the value. The values range from 0.3950x to 0.6300x with a 0.0050x interval.

DRAM DATA REF Voltage on CHA/CHB [Auto]

This item is the DRAM reference voltage for the data lines on Channels A and B. You can use the <+> or <-> keys to adjust the value. The values range from 0.395x to 0.630x with a 0.005x interval.

Clock Crossing VBoot [Auto]

Allows you to increase the value of the clock crossing voltage boot when the rising edge of the BCLK DN is equal to the falling edge of the BCLK DP. You can use the <+> or <-> keys to adjust the value. The values range from 0.1V to 1.9V with a 0.00625V interval.

Clock Crossing Reset Voltage [Auto]

Allows you to increase the value of the clock crossing reset voltage when the rising edge of the BCLK DN is equal to the falling edge of the BCLK DP. You can use the <+> or <-> keys to adjust the value. The values range from 0.1V to 1.9V with a 0.10625V interval.

Clock Crossing Voltage [Auto]

Allows you to increase the value of the clock crossing voltage when the rising edge of the BCLK DN is equal to the falling edge of the BCLK DP. You can use the <+> or <-> keys to adjust the value. The values range from 0.1V to 1.9V with a 0.10625V interval.

CPU Spread Spectrum [Auto]

- | | |
|------------|---|
| [Auto] | Automatic configuration. |
| [Disabled] | Enhances the BCLK overclocking ability. |
| [Enabled] | Sets to [Enabled] for EMI control. |

3.6 Advanced menu

The Advanced menu items allow you to change the settings for the CPU and other system devices.



Be cautious when changing the settings of the Advanced menu items. Incorrect field values can cause the system to malfunction.



3.6.1 CPU Configuration

The items in this menu show the CPU-related information that the BIOS automatically detects.



The items in this menu may vary based on the CPU installed.



Intel Adaptive Thermal Monitor [Enabled]

[Enabled] Enables the overheated CPU to throttle its clock speed to cool down.

[Disabled] Disables the CPU thermal monitor function.

Hyper-threading [Enabled]

The Intel Hyper-Threading Technology allows a hyper-threading processor to appear as two logical processors to the operating system, allowing the operating system to schedule two threads or processes simultaneously.

[Enabled] Two threads per activated core are enabled.

[Disabled] Only one thread per activated core is enabled.



This Item appears only if you installed a CPU that supports the Intel Hyper-threading technology.

Active Processor Cores [All]

Allows you to choose the number of CPU cores to activate in each processor package.

Configuration options: [All] [1] [2] [3]

Limit CPUID Maximum [Disabled]

[Enabled] Allows legacy operating systems to boot even without support for CPUs with extended CPUID functions.

[Disabled] Disables this function.

Execute Disable Bit [Enabled]

[Enabled] Enables the No-Execution Page Protection Technology.

[Disabled] Forces the XD feature flag to always return to zero (0).

Intel Virtualization Technology [Disabled]

[Enabled] Allows a hardware platform to run multiple operating systems separately and simultaneously, enabling one system to virtually function as several systems.

[Disabled] Disables this function.

Hardware Prefetcher [Enabled]

[Enabled] Allows a hardware platform to automatically analyze the requirements and prefetch data and codes for the CPU.

[Disabled] Disables this function.

Adjacent Cache Line Prefetch [Enabled]

[Enabled] Allows a hardware platform to perform adjacent cache line prefetching.

[Disabled] Disables this function.

Boot performance mode [Max Non-Turbo Performance]

Allows you to select the boot performance before entering the OS.

Configuration options: [Max Non-Turbo Performance] [Max Battery] [Turbo Performance]

Dynamic Storage Accelerator [Disabled]

Allows you to enable or disable Dynamic Storage Accelerator for C state configuration.

Configuration options: [Enabled] [Disabled]

CPU Power Management Configuration

This item allows you to manage and configure the CPU's power.

Enhanced Intel SpeedStep Technology [Enabled]

Allows your system to adjust the processor's voltage and cores frequency, resulting in decreased power consumption and heat production.

[Disabled] The CPU runs at its default speed.

[Enabled] The system controls the CPU speed.

Turbo Mode [Enabled]

Allows you to set the processor cores to run faster than the base frequency when operating below power, current and temperature specification limit.

Configuration options: [Enabled] [Disabled]

CPU C States [Auto]

Allows you to enable or disable the CPU C states.

Configuration options: [Auto] [Enabled] [Disabled]



The following items appear only when you set the CPU C States to **[Enabled]**.

Enhanced C1 state [Enabled]

Allows your processor to reduce power when the system is in idle mode.

Configuration options: [Enabled] [Disabled]

CPU C3 Report [Enabled]

Allows you to disable or enable the CPU C3 report to the operating system.

Configuration options: [Enabled] [Disabled]

CPU C6 Report [Enabled]

Allows you to disable or enable the CPU C6 report to the operating system.

Configuration options: [Enabled] [Disabled]

C6 Latency [Short]

Allows you to set the duration of C6 latency for C6 state.

Configuration options: [Short] [Long]

CPU C7 Report [CPU C7s]

Allows you to disable or enable the CPU C7 report to the operating system.

Configuration options: [Disabled] [CPU C7] [CPU C7s]

C7 Latency [Long]

Allows you to set the duration of C7 latency for C7 state.

Configuration options: [Short] [Long]

Package C State Support [Auto]

Allows you to set the a C-state according to the following configuration options: [Auto] [Enabled] [C0/C1] [C2] [C3] [C6] [CPU C7] [CPU C7s]

3.6.2 PCH Configuration

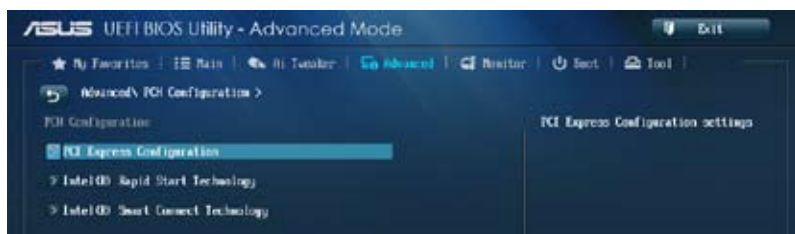

PCI Express Configuration

Allows you to configure the PCI Express slots.

DMI Link ASPM Control [Auto]

Allows you to control the ASPM (Active State Power Management) on both Northbridge side and Southbridge side of the DMI Link.

Configuration options: [Disabled] [Enabled] [Auto]

ASPM Support [Disabled]

Allows you to set the ASPM level.

Configuration options: [Disabled] [Auto] [L0s] [L1] [L0sL1]

PCIe Speed [Auto]

Allows you to select the PCI Express port speed.

Configuration options: [Auto] [Gen1] [Gen2]

Intel Rapid Start Technology [Disabled]

Allows you to enable or disable Intel® Rapid Start Technology.

Configuration options: [Enabled] [Disabled]



The following items appear only when you set the Intel® Rapid Start Technology to **[Enabled]**.

Entry on S3 RTC Wake [Enabled]

The system automatically wakes up and set to Rapid Start Technology S3 mode.

Configuration options: [Enabled] [Disabled]

Entry After [0]

Allows you to set the RTC wake-up timer at S3 entry. The time ranges from 0 minute (immediately) to 120 minutes.

Active Page Threshold Support [Enabled]

The system automatically goes into sleep mode when the partition size is not enough for the Intel® Rapid Start Technology to work.

Configuration options: [Enabled] [Disabled]

Active Memory Threshold [0]

Key in the value for the additional partition size for Rapid Start Technology to work.



Ensure that the caching partition size is larger than the total memory size.

Hybrid Hard Disk Support [Disabled]

Allows you to enable or disable the hybrid hard disk support.

Configuration options: [Enabled] [Disabled]

Intel Smart Connect Technology [Disabled]

Allow you to enable or disable the Intel® Smart Connect Technology.

Configuration options: [Enabled] [Disabled]

3.6.3 SATA Configuration

While entering Setup, the BIOS automatically detects the presence of SATA devices. The SATA Port items show **Not Present** if no SATA device is installed to the corresponding SATA port.

Scroll down to display the other BIOS items.



SATA Mode Selection [AHCI]

Allows you to set the SATA configuration.

- [Disabled] Disables the SATA function.
- [IDE] Set to [IDE Mode] when you want to use the Serial ATA hard disk drives as Parallel ATA physical storage devices.
- [AHCI] Set to [AHCI Mode] when you want the SATA hard disk drives to use the AHCI (Advanced Host Controller Interface). The AHCI allows the onboard storage driver to enable advanced Serial ATA features that increases storage performance on random workloads by allowing the drive to internally optimize the order of commands.
- [RAID] Set to [RAID Mode] when you want to create a RAID configuration from the SATA hard disk drives.

Aggressive LPM Support [Auto]

Allows you to enable the PCH to aggressively enter link power state.

Configuration options: [Disabled] [Enabled] **[Auto]**

S.M.A.R.T. Status Check [Enabled]

S.M.A.R.T. (Self-Monitoring, Analysis and Reporting Technology) is a monitor system. When read/write of your hard disk errors occur, this feature allows the hard disk to report warning messages during the POST. Configuration options: [Enabled] [Disabled]

Hot Plug [Disabled] (SATA6G_1 - SATA6G_6 [Yellow])

These items appear only when you set the SATA Mode Selection item to [AHCI] or [RAID], and allow you to enable/disable SATA Hot Plug Support.

Configuration options: [Disabled] [Enabled]

3.6.4 System Agent Configuration

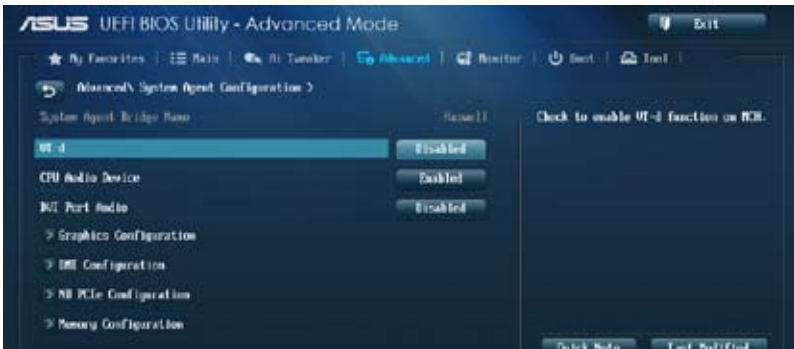

VT-d [Disabled]

Allows you to enable virtualization technology function on memory control hub.

[Enabled] Enables the function.

[Disabled] Disables this function.

CPU Audio Devices [Enabled]

Allows you to enable or disable CPU SA Audio devices.

Configuration options: [Enabled] [Disabled]

DVI Port Audio [Disabled]

Allows you to enable or disable DVI port Audio.

Configuration options: [Enabled] [Disabled]

Graphics Configuration

Allows you to select a primary display from iGPU, and PCIe graphical devices.

Primary Display [Auto]

Allows you to select which of the iGPU/PCIe Graphics device for Primary Display.

Configuration options: [Auto] [iGPU] [PCIe] [PCI]

iGPU Memory [Auto]

Allows you to select the amount of system memory allocated to DVMT 5.0 used by the iGPU.

Configuration options: [Auto] [32M] [64M] [96M] [128M] [160M] [192M] [224M] [256M] [288M] [320M] [352M] [384M] [416M] [448M] [480M] [512M] [1024M]

Render Standby [Auto]

Allows you to enable the Intel Graphics Render Standby support to reduce the iGPU power use when idle.

Configuration options: [Auto] [Disabled] [Enabled]

iGPU Multi-Monitor [Disabled]

Allows you to enable the iGPU Multi-Monitor. The iGPU shared system memory size will be fixed at 64MB.

Configuration options: [Disabled] [Enabled]

DMI Configuration

Allows you to control various DMI (Desktop Management Interface) functions.

DMI Gen 2 [Auto]

Allows you to enable or disable DMI Gen 2.

Configuration options: [Auto] [Enabled] [Disabled]

NB PCIe Configuration

Allows you to configure the NB PCI Express settings.

PCIEx16_1/2 Link Speed [Auto]

Allows you to configure the PCIEx16 speed.

Configuration options: [Auto] [Gen1] [Gen2] [Gen3]

DMI Link ASPM Control [Auto]

Allows you to enable or disable the control of Active State Power Management on SA side of the DMI Link.

Configuration options: [Auto] [Disabled] [L0s] [L1] [L0sL1]

PEG - ASPM [Disabled]

Allows you to control ASPM support for the PEG device.

Configuration options: [Disabled] [Auto] [ASPM L0s] [ASPM L1] [ASPM L0sL1]

Memory Configuration

Allows you to configure the memory configuration parameters.

Memory Scrambler [Enabled]

Allows you to enable or disable the Memory Scrambler support.

Configuration options: [Enabled] [Disabled]

Memory Remap [Enabled]

Allows you to enable remapping the memory above 4GB.

Configuration options: [Enabled] [Disabled]

3.6.5 USB Configuration

The items in this menu allow you to change the USB-related features.

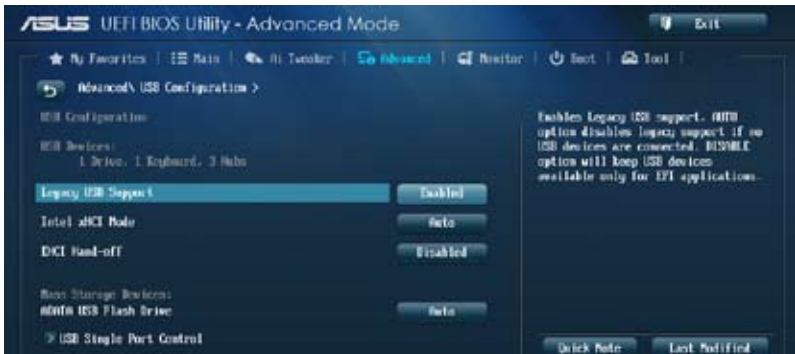

The **USB Devices** item shows the auto-detected values. If no USB device is detected, the item shows **None**.

Legacy USB Support [Enabled]

- [Enabled] Enables the support for USB devices on legacy operating systems (OS).
- [Disabled] The USB devices can be used only for the BIOS setup program. It cannot be recognized in boot devices list.
- [Auto] Allows the system to detect the presence of USB devices at startup. If detected, the USB controller legacy mode is enabled. If no USB device is detected, the legacy USB support is disabled.

Intel xHCI Mode [Smart Auto]

- [Auto] Keeps the last operation of xHCI controller in OS during bootup.
- [Smart Auto] Enables the operation of xHCI controller.
- [Enabled] Enables the xHCI controller.
- [Disabled] Disables the xHCI controller.

EHCI Hand-off [Disabled]

- [Enabled] Enables the support for operating systems without an EHCI hand-off feature.
- [Disabled] Disables the EHCI Hand-off support.

Mass Storage Devices [Auto]

Allows you to set the type of emulation for your USB storage devices.
Configuration options: [Auto] [Floppy] [Forced FDD] [Hard-disk] [CD-ROM]

USB Single Port Control

Allows you to enable or disable the individual USB port.



Refer to section **1.2.2 Motherboard layout** for the location of the USB ports.

3.6.6 Platform Misc Configuration

The items in this menu allow you to configure the platform-related features.



PCI Express Native Power Management [Disabled]

Allows you to enhance the power saving feature of PCI Express and perform ASPM operations in the operating system.

Configuration options: [Disabled] [Enabled]



The following item appears only when you set the PCI Express Native Power Management to **[Enabled]**.

Native ASPM [Disabled]

[Enabled] Vista controls the ASPM support for the device.

[Disabled] BIOS controls the ASPM support for the device.

3.6.7 Onboard Devices Configuration

Scroll down to view the other BIOS items.



HD Audio Controller [Enabled]

[Enabled] Enables the High Definition Audio Controller.

[Disabled] Disables the controller.



The following items appear only when you set the HD Audio Controller to **[Enabled]**.

Front Panel Type [HD]

Allows you to set the front panel audio connector (AAFP) mode to legacy AC'97 or high-definition audio depending on the audio standard that the front panel audio module supports.

[HD] Sets the front panel audio connector (AAFP) mode to high definition audio.

[AC97] Sets the front panel audio connector (AAFP) mode to legacy AC'97

SPDIF Out Type [SPDIF]

[SPDIF] Sets to an SPDIF audio output.

[HDMI] Sets to an HDMI audio output.

ASM1061 Storage Controller (SATA6G_E12) [Enabled]

Allows you to select the ASM1061 storage controller operating mode.

[Disabled] Disables the ASM1061 storage controller.

[Enabled] Enables the ASM1061 storage controller.

Hot-plug [Enabled]

Allows you to set the Hot Plug support.

Configuration options: [Disabled] [Enabled]

Intel LAN Controller [Enabled]

[Enabled] Enables the Intel® LAN controller.

[Disabled] Disables the Intel® LAN controller.

Intel PXE OPROM [Disabled]

This item appears only when you set the previous item to **[Enabled]** and allows you to enable or disable the PXE OptionRom of the Intel® LAN controller.

Configuration options: [Enabled] [Disabled]

Serial Port Configuration

The sub-items in this menu allow you to set the serial port configuration.



This item only functions if there is a serial port (COM1) connector on the motherboard.

Serial Port [Enabled]

Allows you to enable or disable the serial port (COM).

Configuration options: [Enabled] [Disabled]

Change Settings [IO=3F8h; IRQ=4]

Allows you to select an optimal setting for super I/O device.

Configuration options: [IO=3F8h; IRQ=4] [IO=2F8h; IRQ=3] [IO=3E8h; IRQ=4]
[IO=2E8h; IRQ=3]

3.6.8 APM



ErP Ready [Disabled]

Allows you to switch off some power at S4+S5 or S5 to get the system ready for ErP requirement. When set to **[Enabled]**, all other PME options will be switched off.

Configuration options: [Disabled] [Enabled (S4+S5)] [Enabled (S5)]

Restore AC Power Loss [Power Off]

[Power On] The system goes into ON state after an AC power loss.

[Power Off] The system goes into OFF state after an AC power loss.

[Last State] The system goes into either OFF or ON state, whatever the system state was before the AC power loss.

Power On By PS/2 Keyboard [Disabled]

[Disabled] Disables the Power On by a PS/2 keyboard.

[Space Bar] Sets the Space Bar on the PS/2 keyboard to turn on the system.

[Ctrl-Esc] Sets the Ctrl+Esc key on the PS/2 keyboard to turn on the system.

[Power Key] Sets Power key on the PS/2 keyboard to turn on the system. This feature requires an ATX power supply that provides at least 1A on the +5VSB lead.

Power On By PCIE/PCI [Disabled]

[Disabled] Disables the PCIE/PCI devices to generate a wake-on-LAN feature of the Intel®/LAN device or other installed PCIE LAN devices.

[Enabled] Enables the PCIE/PCI devices to generate a wake-on-LAN feature of the Intel®/LAN device or other installed PCIE LAN devices.

Power On By Ring [Disabled]

[Disabled] Disables Wake-On-Ring from generating a wake event.

[Enabled] Enables Wake-On-Ring to generate a wake event.

Power On By RTC [Disabled]

[Disabled] Disables RTC to generate a wake event.

[Enabled] When set to **[Enabled]**, the items **RTC Alarm Date (Days)** and **Hour/Minute/Second** will become user-configurable with set values.

3.6.9 Network Stack



Network Stack [Disable]

This item allows user to disable or enable the UEFI network stack.

Configuration options: [Disable] [Enable]



The following item appears only when you set the Network Stack to **[Enabled]**.

Ipv4/Ipv6 PXE Support [Enabled]

Allows you to enable or disable the Ipv4/Ipv6 PXE boot option.

Configuration options: [Disabled] [Enabled]

3.7 Monitor menu

The Monitor menu displays the system temperature/power status, and allows you to change the fan settings.

Scroll down to display the other BIOS items.



CPU Temperature / MB Temperature [xxx°C/xxx°F]

The onboard hardware monitor automatically detects and displays the CPU and motherboard temperatures. Select **[Ignore]** if you do not wish to display the detected temperatures.

CPU Fan Speed [xxxx RPM] or **[Ignore]** / **[N/A]**, CPU OPT Speed [xxxx RPM] or **[Ignore]** / **[N/A]**, Chassis Fan 1/4 Speed [xxxx RPM] or **[Ignore]** / **[N/A]**

The onboard hardware monitor automatically detects and displays the CPU, chassis, and power fan speed in rotations per minute (RPM). If the fan is not connected to the motherboard, the field shows N/A. Select **[Ignore]** if you do not wish to display the detected speed.

CPU core 0-3 Voltage, 3.3V Voltage, 5V Voltage, 12V Voltage

The onboard hardware monitor automatically detects the voltage output through the onboard voltage regulators. Select **[Ignore]** if you do not want to detect this item.

CPU Q-Fan Control [Auto]

Allows you to set the CPU Q-Fan operating mode.

- [Auto] Enables the CPU Q-Fan control feature in PWM mode for 4-pin CPU fan.
- [Advance Mode] Detects the type of CPU fan installed and automatically switches the mode control. When a 3-pin CPU fan is installed, select this mode for the DC mode Q-Fan control.
- [Disabled] Disables the Q-Fan control.



The following items appear only when you set the CPU Q-Fan Control to **[Advance Mode]** and **[Auto]**.

CPU Fan Speed Low Limit [600 RPM]

Allows you to set the low limit warning for CPU Fan speed.

Configuration options: [Ignore] [200 RPM] [300 RPM] [400 RPM] [500 RPM] [600 RPM]

CPU Fan Profile [Standard]

Allows you to set the appropriate performance level of the CPU fan.

- [Standard] Set to make the CPU fan adjust automatically depending on the CPU temperature.
- [Silent] Set to minimize the fan speed for quiet CPU fan operation.
- [Turbo] Set to achieve maximum CPU fan speed.
- [Manual] Set to assign the detailed fan speed control parameters.



The following items appear only when you set the CPU Fan Profile to **[Manual]**.

CPU Upper Temperature [70]

Use the <+> or <-> keys to adjust the upper limit of the CPU temperature. The values range from 20°C to 75°C.

CPU Fan Max. Duty Cycle(%) [100]

Use the <+> or <-> keys to adjust the maximum CPU fan duty cycle. The values range from 20% to 100%. When the CPU temperature reaches the upper limit, the CPU fan will operate at the maximum duty cycle.

CPU Lower Temperature [20]

Displays the lower limit of the CPU temperature. The values range from 20°C to 75°C.

CPU Fan Min. Duty Cycle(%) [20]

Use the <+> or <-> keys to adjust the minimum CPU fan duty cycle. The values range from 20% to 100%. When the CPU temperature is under 40°C, the CPU fan will operate at the minimum duty cycle.

Chassis Q-Fan Control 1/4 [Enabled]

- [Disabled] Disables the Chassis Q-Fan control feature.
- [Enabled] Enables the Chassis Q-Fan control feature.

Chassis Fan Speed Low Limit 1/4 [600 RPM]

This item appears only when you enable the Chassis Q-Fan Control feature and allows you to disable or set the chassis fan warning speed.

Configuration options: [Ignore] [200 RPM] [300 RPM] [400 RPM] [500 RPM] [600 RPM]

Chassis Fan 1/4 Profile [Standard]

This item appears only when you enable the Chassis Q-Fan Control feature. It allows you to set the appropriate performance level of the chassis fan.

- [Standard] Set to make the chassis fan adjust automatically depending on the chassis temperature.
- [Silent] Set to minimize the fan speed for quiet chassis fan operation.
- [Turbo] Set to achieve maximum chassis fan speed.
- [Manual] Set to assign detailed fan speed control parameters.



The following items appear only when you set the Chassis Fan Profile to **[Manual]**.

Chassis Upper Temperature 1/4 [70]

Use the <+> or <-> keys to adjust the upper limit of the CPU temperature. The values range from 40°C to 75°C.

Chassis Fan Max. Duty Cycle(%) 1/4 [100]

Use the <+> or <-> keys to adjust the maximum chassis fan duty cycle. The values range from 60% to 100%. When the chassis temperature reaches the upper limit, the chassis fan will operate at the maximum duty cycle.

Chassis Lower Temperature 1/4 [40]

Displays the lower limit of the chassis temperature.

CPU Fan Min. Duty Cycle(%) 1/4 [60]

Use the <+> or <-> keys to adjust the minimum chassis fan duty cycle. The values range from 60% to 100%. When the chassis temperature is under 40°C, the chassis fan will operate at the minimum duty cycle.

Anti Surge Support [Enabled]

This item allows you to enable or disable the Anti Surge function.

Configuration options: [Disabled] [Enabled]

3.8 Boot menu

The Boot menu items allow you to change the system boot options.

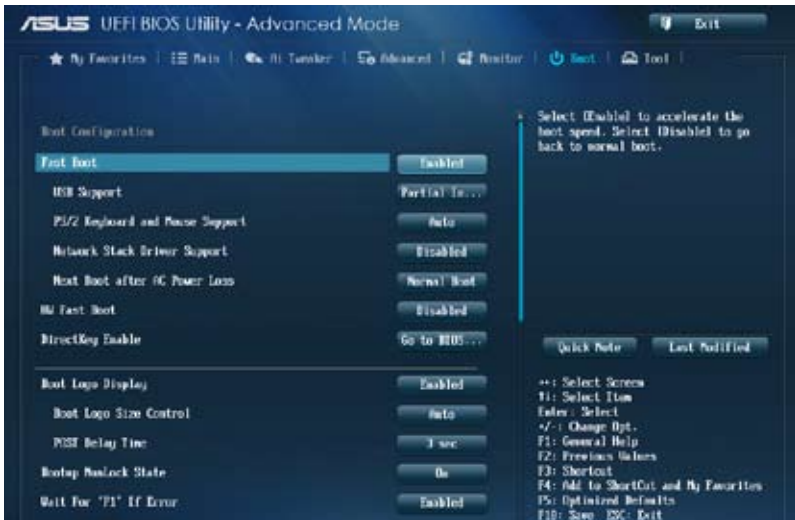

Boot Configuration

Fast Boot [Disabled]

[Disabled] Allows your system to go back to its normal boot speed.

[Enabled] Allows your system to accelerate the boot speed.



The following items appear only when you set the Fast Boot to **[Enabled]**.

USB Support [Partial In...]

[Disabled] All USB devices will not be available until OS boot up for a fastest POST time.

[Full Initialization] All USB devices will be available during POST. This process will extend the POST time.

[Partial Initialization] For a faster POST time, only USB ports with keyboard and mouse connections will be detected.

PS/2 Keyboard and Mouse Support [Auto]

Select any of these settings when PS/2 keyboard and mouse are installed. These settings only apply when Fast Boot is enabled.

- [Auto] For a faster POST time, PS/2 devices will only be available when the system boots up or rebooted when the PS/2 devices have not been reconnected or changed. If you disconnect or change PS/2 devices before restarting the system, PS/2 devices will not be available and BIOS setup program will not be accessible via PS/2 devices.
- [Full Initialization] For full system control, PS/2 devices will be available during POST at any circumstances. This process will extend POST time.
- [Disabled] For the fastest POST time, all PS/2 devices will not be available until your computer enters the operating system.

Network Stack Driver Support [Disabled]

- [Disabled] Select to skip the network stack driver from loading during POST.
- [Enabled] Select to load the network stack driver during POST.

Next Boot after AC Power Loss [Normal Boot]

- [Normal Boot] Returns to normal boot on the next boot after an AC power loss.
- [Fast Boot] Accelerates the boot speed on the next boot after an AC power loss.

HW Fast Boot [Disabled]

Allows the system to enable or disable the HW Fast Boot.

Configuration options: [Disabled] [Enabled]

DirectKey Enable [Go to BIOS...]

- [Disabled] Disables the DirectKey button. The system will only power on or off when you press the DirectKey button.
- [Go to BIOS Setup] Allows the system to power on and go to the BIOS Setup directly when you press the DirectKey button.

Boot Logo Display [Enabled]

[Enabled] Enables the full screen boot logo display during POST.

[Disabled] Disables the full screen boot logo display during POST.

Boot Logo Size Control [Auto]

[Auto] Automatically adjusts for Windows® requirements.

[Full Screen] Maximizes the boot logo size.

Post Delay Time [3 sec]

This item appears only when you set the Full Screen Logo item to **[Enabled]**. This item allows you to select a desired additional POST waiting time to easily enter the BIOS Setup. You can only execute the POST delay time during normal boot. The values range from 0 to 10 seconds.



This feature will only work when set under normal boot.

Bootup NumLock State [On]

[On] Set the power-on state of the NumLock to **[On]**.

[Off] Set the power-on state of the NumLock to **[Off]**.

Wait For 'F1' If Error [Enabled]

[Disabled] Disables the function.

[Enabled] The system waits for the <F1> key to be pressed when error occurs.

Option ROM Messages [Force BIOS]

[Force BIOS] The third-party ROM messages will be displayed during the boot sequence.

[Keep Current] The third-party ROM messages will be displayed only if the third-party manufacturer had set the add-on device to do so.

Interrupt 19 Capture [Disabled]

Allows you to trap Interrupt 19 by the option ROMs.

Configuration options: [Disabled] [Enabled]

Setup Mode [EZ Mode]

[Advanced Mode] Allows you to go to Advanced Mode of the BIOS after POST.

[EZ Mode] Allows you to go to EZ Mode of the BIOS after POST.

CSM (Compatibility Support Module)

Allows you to configure the CSM (Compatibility Support Module) items to fully support the various VGA, bootable devices and add-on devices for better compatibility.

Launch CSM [Auto]

- [Auto] The system automatically detects the bootable devices and the add-on devices.
- [Enabled] For better compatibility, enable the CSM to fully support the non-UEFI driver add-on devices or the Windows® UEFI mode.
- [Disabled] Disable the CSM to fully support the non-UEFI driver add-on devices or the Windows® UEFI mode.



The following items appear only when you set the Launch CSM to **[Enabled]**.

Boot Devices Control [UEFI and Legacy OpROM]

Allows you to select the type of devices that you want to boot.

Configuration options: [UEFI and Legacy OpROM] [Legacy OpROM only] [UEFI only]

Boot from Network Devices [Legacy OpROM first]

Allows you to select the type of network devices that you want to launch.

Configuration options: [Legacy OpROM first] [UEFI driver first] [Ignore]

Boot from Storage Devices [Legacy OpROM first]

Allows you to select the type of storage devices that you want to launch.

Configuration options: [Both, Legacy OpROM first] [Both, UEFI first] [Legacy OpROM first] [UEFI driver first] [Ignore]

Boot from PCIe/PCI Expansion Devices [Legacy OpROM first]

Allows you to select the type of PCIe/PCI expansion devices that you want to launch.

Configuration options: [Legacy OpROM first] [UEFI driver first]

Secure Boot

Allows you to configure the Windows® Secure Boot settings and manage its keys to protect the system from unauthorized access and malwares during POST.

OS Type [Windows UEFI mode]

- [Windows UEFI Mode] Allows you to select your installed operating system. Execute the Microsoft® Secure Boot check. Only select this option when booting on Windows® UEFI mode or other Microsoft® Secure Boot compliant OS.
- [Other OS] Get the optimized function when booting on Windows® non-UEFI mode, Windows® Vista/ Windows® XP, or other Microsoft® Secure Boot non compliant OS. Microsoft® Secure Boot only supports Windows® UEFI mode.



The following item appears only when you set the OS Type to **[Windows UEFI mode]**.

Key Management

This item appears only when you set OS Type to **[Windows UEFI Mode]**. It allows you to manage the Secure Boot keys.

Clear Secure Boot keys

This item appears only when you load the default Secure Boot keys. This item allows you to clear all default Secure Boot keys.

Save Secure Boot Keys

Allows you to save the PK (Platform Keys) to a USB storage device.

PK Management

The Platform Key (PK) locks and secures the firmware from any permissible changes. The system verifies the PK before your system enters the OS.

Delete PK

Allows you to delete the PK from your system. Once the PK is deleted, all the system's Secure Boot keys will not be active.

Configuration options: [Yes] [No]

Load PK from File

Allows you to load the downloaded PK from a USB storage device.



The PK file must be formatted as a UEFI variable structure with time-based authenticated variable.

KEK Management

The KEK (Key-exchange Key or Key Enrollment Key) manages the Signature database (db) and Revoked Signature database (dbx).



Key-exchange Key (KEK) refers to Microsoft® Secure Boot Key-Enrollment Key (KEK).

Delete the KEK

Allows you to delete the KEK from your system.

Configuration options: [Yes] [No]

Load KEK from File

Allows you to load the downloaded KEK from a USB storage device.

Append KEK from File

Allows you to load the additional KEK from a storage device for an additional db and dbx loaded management.



The KEK file must be formatted as a UEFI variable structure with time-based authenticated variable.

DB Management

The db (Authorized Signature database) lists the signers or images of UEFI applications, operating system loaders, and UEFI drivers that you can load on the single computer.

Delete the db

Allows you to delete the db file from your system.

Configuration options: [Yes] [No]

Load db from File

Allows you to load the downloaded db from a USB storage device.

Append db from File

Allows you to load the additional db from a storage device so that more images can be loaded securely.



The db file must be formatted as a UEFI variable structure with time-based authenticated variable.

DBX Management

The dbx (Revoked Signature database) lists the forbidden images of db items that are no longer trusted and cannot be loaded.

Delete the dbx

Allows you to delete the dbx file from your system.

Load dbx from File

Allows you to load the downloaded dbx from a USB storage device.

Configuration options: [Yes] [No]

Append dbx from File

Allows you to load the additional dbx from a storage device so that more db's images cannot be loaded.



The dbx file must be formatted as a UEFI variable structure with time-based authenticated variable.

3.9 Tools menu

The Tools menu items allow you to configure options for special functions. Select an item then press <Enter> to display the submenu.

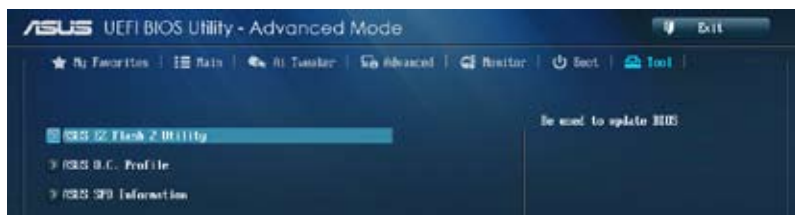

3.9.1 ASUS EZ Flash 2 Utility

Allows you to run ASUS EZ Flash 2. When you press <Enter>, a confirmation message appears. Use the left/right arrow key to select between [Yes] or [No], then press <Enter> to confirm your choice.



For more details, refer to section 3.11.2 ASUS EZ Flash 2.

3.9.2 ASUS O.C. Profile

This item allows you to store or load multiple BIOS settings.

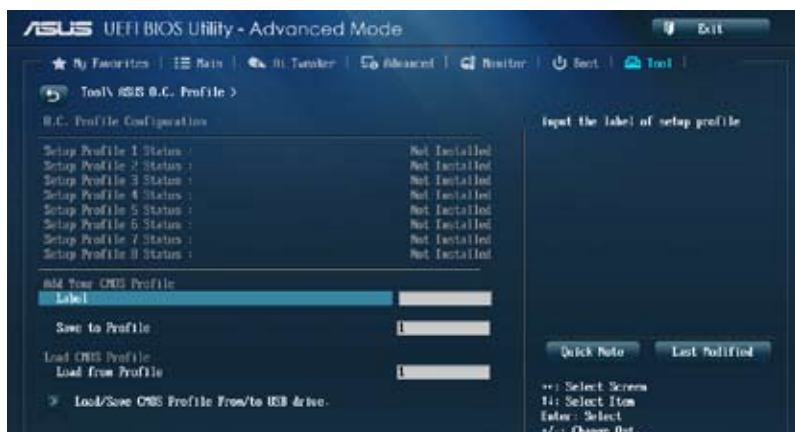

The Setup Profile Status items show **Not Installed** if no profile is created.

Label

Allows you to key in a label of the setup profile.

Save to Profile

Allows you to save the current BIOS settings to the BIOS Flash, and create a profile. Key in a profile number from one to eight, press <Enter>, and then select **Yes**.

Load from Profile

Allows you to load the previous BIOS settings saved in the BIOS Flash. Key in the profile number that saved your BIOS settings, press <Enter>, and then select **Yes**.



- DO NOT shut down or reset the system while updating the BIOS to prevent the system boot failure!
- We recommend that you update the BIOS file only coming from the same memory/ CPU configuration and BIOS version.

3.9.3 ASUS SPD Information

Allows you to view the DRAM SPD information.

The screenshot displays the 'Tool \ ASUS SPD Information >' menu in the BIOS. The 'SPD Slot 2' is selected, showing the following details:

JEDEC ID		JEDEC	
Frequency (MHz)	1600		
Voltage (V)	1.500		
CSH Latency (ns)	11		
RSH to CS# (ns)	11		
RSH Precharge (ns)	11		
LR#	20		
trC	39		
LR#	12		
LR#	5		
tRRC	200		
tRTP	6		
tRTP	6		
tRTP	6		
tRTP	24		

Additional information shown includes: Manufacturer: Hynex, Module Size: 8192 Mbytes, Maximum Bandwidth: 1400 MHz, Part Number: 78.C1021.CP10C, Serial Number: 03012404, Product Week/Year: 48/2012. A 'Quick Guide' button is also visible.

3.10 Exit menu

The Exit menu items allow you to load the optimal default values for the BIOS items, and save or discard your changes to the BIOS items. You can access the EZ Mode from the Exit menu.



Load Optimized Defaults

This option allows you to load the default values for each of the parameters on the Setup menus. When you select this option or if you press <F5>, a confirmation window appears. Select Yes to load the default values.

Save Changes & Reset

Once you are finished making your selections, choose this option from the Exit menu to ensure the values you selected are saved. When you select this option or if you press <F10>, a confirmation window appears. Select **Yes** to save changes and exit.

Discard Changes & Exit

This option allows you to exit the Setup program without saving your changes. When you select this option or if you press <Esc>, a confirmation window appears. Select **Yes** to discard changes and exit.

ASUS EZ Mode

This option allows you to enter the EZ Mode screen.

Launch EFI Shell from filesystem device

This option allows you to attempt to launch the EFI Shell application (shellx64.efi) from one of the available filesystem devices.

3.11 Updating BIOS

The ASUS website publishes the latest BIOS versions to provide enhancements on system stability, compatibility, or performance. However, BIOS updating is potentially risky. If there is no problem using the current version of BIOS, DO NOT manually update the BIOS. Inappropriate BIOS updating may result in the system's failure to boot. Carefully follow the instructions of this chapter to update your BIOS if necessary.



Visit the ASUS website at www.asus.com to download the latest BIOS file for this motherboard.

The following utilities allow you to manage and update the motherboard BIOS setup program.

1. EZ Update: Updates the BIOS in Windows® environment.
2. ASUS EZ Flash 2: Updates the BIOS using a USB flash drive.
3. ASUS CrashFree BIOS 3: Restores the BIOS using the motherboard support DVD or a USB flash drive when the BIOS file fails or gets corrupted.
4. ASUS BIOS Updater: Updates and back ups the BIOS in DOS environment using the motherboard support DVD and a USB flash disk drive.

3.11.1 EZ Update

The EZ Update is a utility that allows you to update the motherboard BIOS in Windows® environment.



-
- EZ Update requires an Internet connection either through a network or an ISP (Internet Service Provider).
 - This utility is available in the support DVD that comes with the motherboard package.
-

3.11.2 ASUS EZ Flash 2

ASUS EZ Flash 2 allows you to update the BIOS without having to use a bootable floppy disk or an OS-based utility.



Before you start using this utility, download the latest BIOS from the ASUS website at www.asus.com.

To update the BIOS using EZ Flash 2:

1. Insert the USB flash disk that contains the latest BIOS file to the USB port.
2. Enter the Advanced Mode of the BIOS setup program. Go to the Tool menu to select ASUS EZ Flash Utility and press <Enter> to enable it.

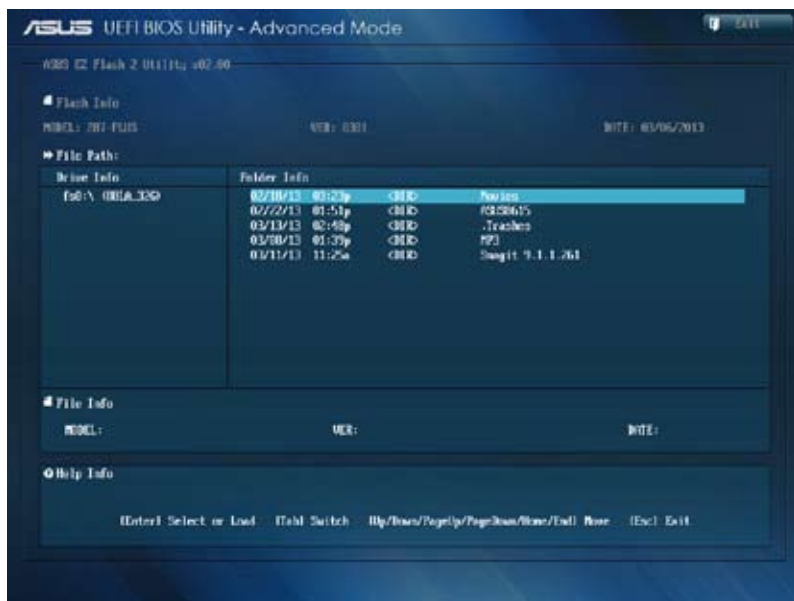

3. Press <Tab> to switch to the Drive field.
4. Press the Up/Down arrow keys to find the USB flash disk that contains the latest BIOS, and then press <Enter>.
5. Press <Tab> to switch to the Folder Info field.
6. Press the Up/Down arrow keys to find the BIOS file, and then press <Enter> to perform the BIOS update process. Reboot the system when the update process is done.



-
- This function can support devices such as a USB flash disk with FAT 32/16 format and single partition only.
 - DO NOT shut down or reset the system while updating the BIOS to prevent system boot failure!
-



Ensure to load the BIOS default settings to ensure system compatibility and stability. Select the Load Optimized Defaults item under the Exit menu. See section 3.9 **Exit Menu** for details.

3.11.3 ASUS CrashFree BIOS 3

The ASUS CrashFree BIOS 3 utility is an auto recovery tool that allows you to restore the BIOS file when it fails or gets corrupted during the updating process. You can restore a corrupted BIOS file using the motherboard support DVD or a USB flash drive that contains the BIOS file.



The BIOS file in the motherboard support DVD may be older than the BIOS file published on the ASUS official website. If you want to use the newer BIOS file, download the file at <http://support.asus.com> and save it to a USB flash drive.

Recovering the BIOS

To recover the BIOS:

1. Turn on the system.
2. Insert the motherboard support DVD to the optical drive, or the USB flash drive containing the BIOS file to the USB port.
3. The utility automatically checks the devices for the BIOS file. When found, the utility reads the BIOS file and enters ASUS EZ Flash 2 automatically.
4. The system requires you to enter BIOS Setup to recover the BIOS setting. To ensure system compatibility and stability, we recommend that you press <F5> to load default BIOS values.



DO NOT shut down or reset the system while updating the BIOS! Doing so can cause system boot failure!

3.11.4 ASUS BIOS Updater

The ASUS BIOS Updater allows you to update the BIOS in DOS environment. This utility also allows you to copy the current BIOS file that you can use as a backup when the BIOS fails or gets corrupted during the updating process.



The succeeding utility screens are for reference only. The actual utility screen displays may not be same as shown.

Before updating BIOS

1. Prepare the motherboard support DVD and a USB flash drive in FAT32/16 format and single partition.
2. Download the latest BIOS file and BIOS Updater from the ASUS website at <http://support.asus.com> and save them on the USB flash drive.



- NTFS is not supported under DOS environment. Do not save the BIOS file and BIOS Updater to a hard disk drive or USB flash drive in NTFS format.
- Do not save the BIOS file to a floppy disk due to low disk capacity.

3. Turn off the computer and disconnect all SATA hard disk drives (optional).

Booting the system in DOS environment

1. Insert the USB flash drive with the latest BIOS file and BIOS Updater to the USB port.
2. Boot your computer. When the ASUS Logo appears, press <F8> to show the BIOS Boot Device Select Menu. Insert the support DVD into the optical drive and select the optical drive as the boot device.

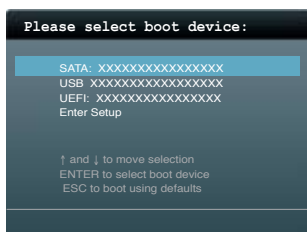

- When the Make Disk menu appears, select the FreeDOS command prompt item by pressing the item number.
- At the FreeDOS prompt, type d: and press <Enter> to switch the disk from Drive C (optical drive) to Drive D (USB flash drive).

```

Welcome to FreeDOS (http://www.freedos.org) !
C:\>d:
D:\>

```

Updating the BIOS file

To update the BIOS file using BIOS Updater:

- At the FreeDOS prompt, type bupdater /pc /g and press <Enter>.

```
D:\>bupdater /pc /g
```

- The BIOS Updater screen appears as below.

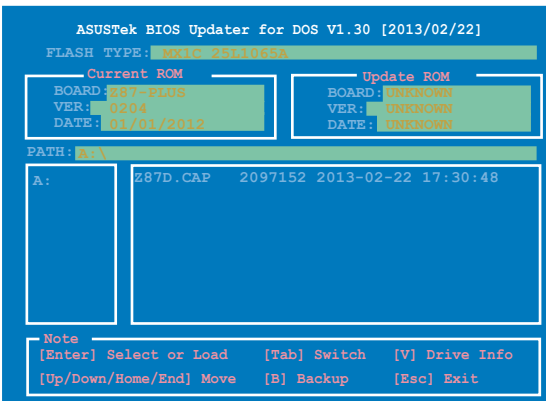

- Press <Tab> to switch between screen fields and use the <Up/Down/Home/End> keys to select the BIOS file and press <Enter>. BIOS Updater checks the selected BIOS file and prompts you to confirm BIOS update.



4. Select Yes and press <Enter>. When BIOS update is done, press <ESC> to exit BIOS Updater. Restart your computer.



DO NOT shut down or reset the system while updating the BIOS to prevent system boot failure!



- For BIOS Updater version 1.04 or later, the utility automatically exits to the DOS prompt after updating BIOS.
 - Ensure to load the BIOS default settings to ensure system compatibility and stability. Select the **Load Optimized Defaults** item under the **Exit** BIOS menu. See Chapter 3 of your motherboard user manual for details.
 - Ensure to connect all SATA hard disk drives after updating the BIOS file if you have disconnected them.
-

Software support

4

4.1 Installing an operating system



- This motherboard supports 32-bit/64-bit Windows® 7 and 32-bit/64-bit Windows® 8 operating systems (OS).
- **Motherboard settings and hardware options vary. The setup procedures presented in this chapter are for reference only. Refer to Windows® operating system documentation for detailed information.**

4.2 Support DVD information



The contents of the support DVD are subject to change at any time without notice. Visit the ASUS website at www.asus.com for updates.

4.2.1 Running the support DVD

Place the support DVD into the optical drive. The DVD automatically displays the Drivers menu if Autorun is enabled in your computer. Click each menu tab and select the items you want to install.

The Drivers menu shows the available device drivers if the system detects installed devices. Install the necessary drivers to use the devices.

The AHCI/RAID Driver menu contains the RAID/AHCI driver disk.

The Manual menu contains the list of supplementary user manuals. Click an item to open the folder of the user manual.

The Utilities menu shows the applications and other software that the motherboard supports.

Click an item to install



Click the Contact tab to display the ASUS contact information.

Click an icon to display DVD/motherboard information



If Autorun is NOT enabled in your computer, browse the contents of the support DVD to locate the file ASSETUP.EXE from the BIN folder. Double-click the **ASSETUP.EXE** to run the DVD.

4.2.2 Obtaining the software manuals

The software manuals are included in the support DVD. Follow the instructions below to get the necessary software manuals.



The software manual files are in Portable Document Format (PDF). Install the Adobe® Acrobat® Reader from the **Utilities** tab before opening the files.

To read about your motherboard's utility guide:

1. Click **Manual** tab > **ASUS Motherboard Utility Guide**.



2. From the **Manual** folder, open the folder of the software manual that you wish to read.

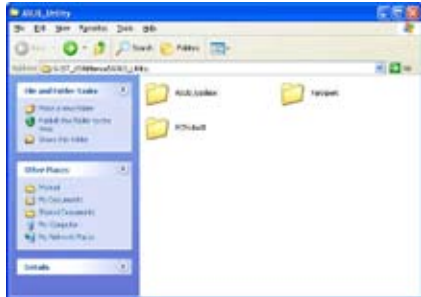

3. Some software manuals are provided in different languages. Open the language's folder to view the software manual.

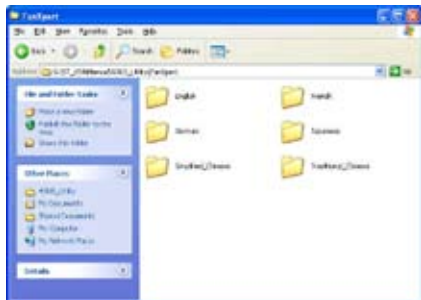

The screenshots in this section are for reference only. The actual software manuals containing in the support DVD vary by models.

4.3 Software information

Most of the applications in the support DVD have wizards that will conveniently guide you through the installation. View the online help or readme file that came with the software application for more information.

4.3.1 AI Suite 3

AI Suite 3 is an all-in-one interface that integrates several ASUS utilities and allows you to launch and operate these utilities simultaneously.

Installing AI Suite 3

To install AI Suite 3 on your computer:

1. Place the support DVD to the optical drive. The **Special** tab appears if your computer has enabled the Autorun feature.
2. Click **Utilities** tab > **AI Suite 3**.
3. Follow the onscreen instructions to complete the installation.
4. After the AI Suite 3 is installed, restart your computer.

Using AI Suite 3

You can launch the AI Suite 3 for the following Windows® operating systems:

- For Windows® 7, click  on the notification area.
- For Windows® 8, click the AI Suite 3 app from the Start Screen.

When launched, the main screen of the AI Suite 3 appears. To go to the AI Suite 3 main menu bar, click  on the top edge of the screen.



The main screen of the AI Suite 3 is for reference only and vary with models.

Main screen

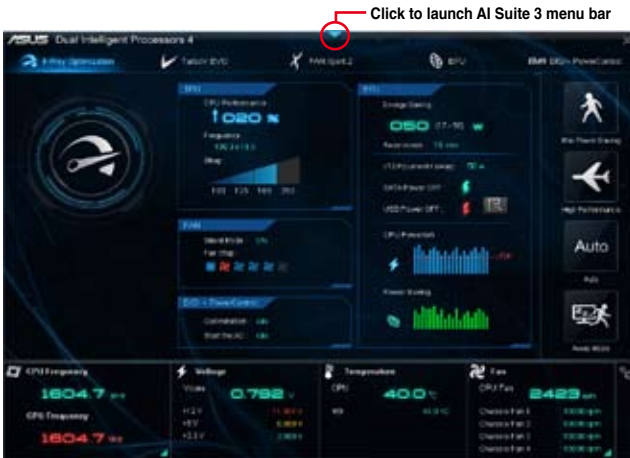

AI Suite 3 main menu bar

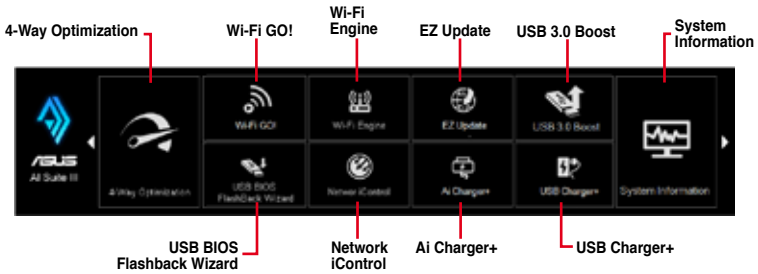

- The screenshots of AI Suite 3 in this user manual are for reference only. The actual screenshots vary with models.
- Refer to the software manual in the support DVD or visit the ASUS website at www.asus.com for detailed software configuration.

4.3.2 Dual Intelligent Processors 4

Dual Intelligent Processors 4 comes with these five utilities in one interface: 4-Way Optimization, TPU, EPU, DIGI+ Power Control, and Fan Xpert 2.

On some motherboard models, Dual Intelligent Processors 4 appear at AI Suite 3's launch.

4-Way Optimization

The 4-Way Optimization utility allows you automatically tweak the TPU, EPU, DIGI + Power Control and Fan Xpert 2 to their optimal settings.



Click to auto-detect the best settings based on actual usage

Select an advanced power saving mode



DO NOT remove your fan during the tuning process.

TPU

ASUS TPU allows you to manually adjust the CPU frequency, CPU Cache and Core frequencies, DRAM frequency, and related voltages for an enhanced system stability and boost performance.



Refer to the CPU documentation before adjusting CPU voltage settings. Setting a high voltage may damage the CPU permanently, and setting a low voltage may lead to an unstable system.



For system stability, all changes made in TurboV will not be saved to BIOS settings and will not be kept on the next system boot. Use the Save Profile function to save your customized overclocking settings and manually load the profile after Windows starts.

Using TPU

CPU Frequency

Click to load the saved profile

Click to save the adjustment into a profile

Tick to enable Group Tuning

Click to enable the default settings

Click to undo the adjustments

Click ◀ or ▶ to adjust the Base Clock Frequency, CPU Ratio, and CPU Ring Ratio

Click ▶ or ◀ to select the number of cores to adjust

Click to apply the adjustments



- Set the CPU Ratio Setting item in BIOS to **[Auto]** before using the CPU Frequency in TPU. Refer to the BIOS chapter of your motherboard user manual for details.
- The CPU Frequency bars show the status of the CPU cores, which vary with your CPU model.

Voltage

Drag ▲ to adjust CPU Core Voltage offset

Drag ▲ to adjust CPU Cache Voltage offset

Click to load the saved profile

Click to save the adjustment into a profile

Drag the slider to adjust DRAM, CPU Analog I/O, PCH, and CPU Input voltages

Click to apply the adjustments

Click to undo the adjustments

Drag the slider to adjust CPU System Agent, CPU Digital I/O, VTTDDR, and PCHVFX voltages

GPU Boost

Drag ▲ to adjust the iGPU Max Voltage

Click ◀ or ▶ to adjust the CPU VCCSA voltage

Click to apply the adjustments

Click to load the saved profile

Click to save the adjustment into a profile

Click to enable the default settings

Click to undo the adjustments



- The overclocking result varies with the CPU model and the system configuration.
- We recommend that you set up a better thermal environment to prevent overheating from damaging the motherboard.

EPU

EPU is an energy-processing utility that allows you to adjust the CPU, GPU, and Fan Control settings to their power-saving conditions.

Using EPU

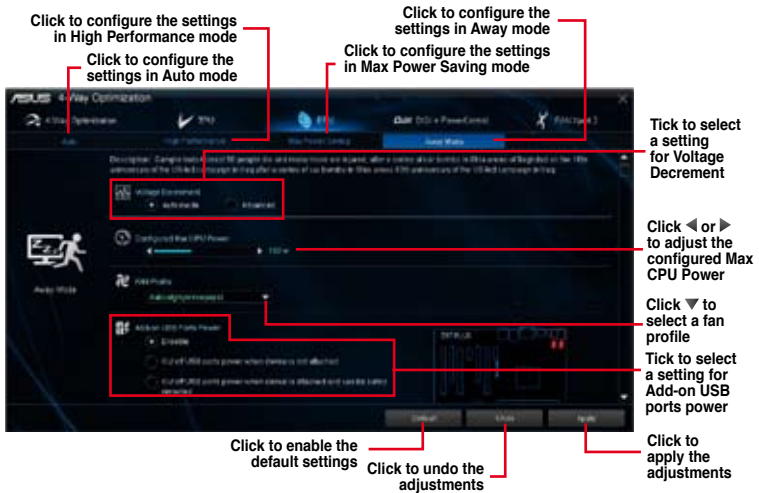

- When you enable Configured Max CPU Power for advanced energy saving condition, the CPU frequency may display 800 MHz in the Windows® OS information of your computer. However, the true CPU frequency varies depending on the wattage that you manually set. You can adjust the CPU wattage from the lowest base to your preferred default value.
- Configured Max CPU Power may decrease the total power delivery to the CPU and affects the CPU performance under system heavy load. To restore your system to its default settings, reboot your computer.

DIGI+ Power Control

DIGI+ Power Control allows you to adjust the VRM voltage and frequency for optimal system efficiency, overall system stability and performance.

CPU Power

You can configure the following CPU Power items:

- **CPU Power Duty Control**

CPU Power Duty Control adjusts the current of every VRM phase and the thermal conditions of every phase component.
- **CPU Load-line Calibration**

CPU Load-line Calibration adjusts the voltage range and controls the system temperature. Higher load-line calibration could get higher voltage and good overclocking performance but increases the CPU and VRM thermal conditions.
- **CPU Current Capability**

CPU Current Capability provides wider total power range for overclocking. A higher value setting gets higher VRM power consumption delivery.
- **CPU Power Thermal Control**

A higher temperature brings a wider CPU power thermal range, and extends the overclocking tolerance to enlarge overclocking potential.
- **CPU Power Phase Control**

CPU Power Phase Control allows you to get more transient and better thermal performance by increasing the phase number under heavy system loading. To increase VRM efficiency, reduce the phase number under light system loading.
* The system automatically sets the default to [Extreme] when using the Intel® iGPU.
- **CPU Voltage Frequency**

CPU Voltage Frequency affects the VRM transient response and thermal components. Higher VRM frequency gets quicker transient response.

DRAM Power

You can configure the following DRAM items:

- **DRAM Power Phase Control**

Select Extreme for full phase mode to increase system performance or select Optimized for ASUS optimized phase tuning profile to increase DRAM power efficiency.
- **DRAM Current Capability**

A higher value brings a wider total power range and extends the overclocking frequency range simultaneously.
- **DRAM Voltage Frequency**

Allows you to adjust the DRAM switching frequency for system stability or to increase OC Range.

Fan Xpert 2

Fan Xpert 2 automatically detects and tweaks the fan speeds, and provides you with optimized fan settings based on the fans' specifications and positions.

Using Fan Xpert 2

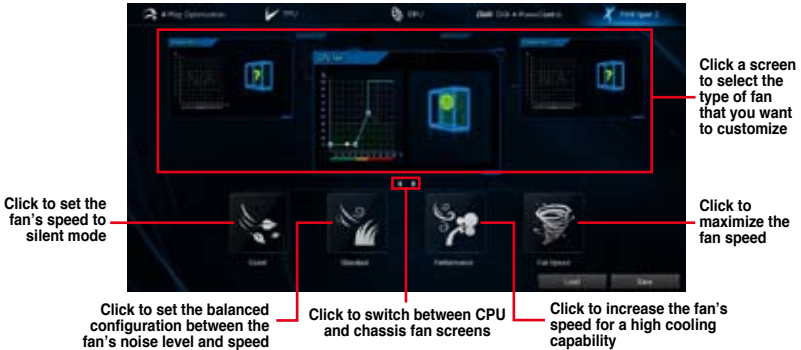

Customizing the fan settings

Smart Mode

Smart Mode allows you to customize the fans' rotation speeds and responsiveness based on your system's temperature.

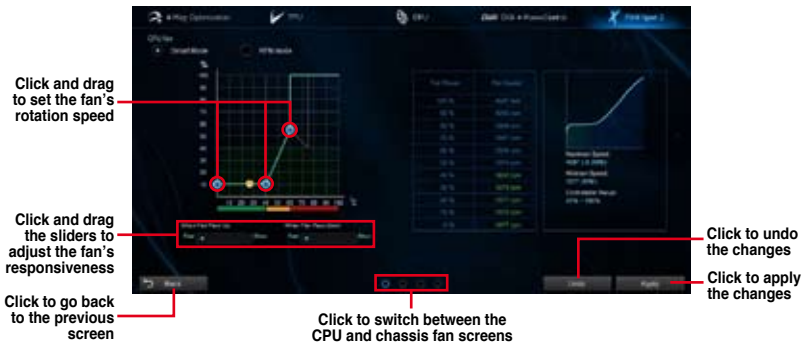

RPM Mode

RPM Mode allows you to set the fan speed when the CPU temperature is below 75°C.

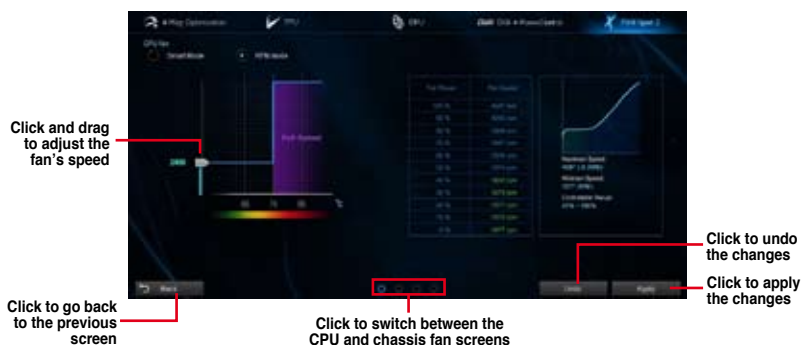

- When the CPU temperature reaches 75° C, the fan will automatically run at full speed to protect the CPU.
- For motherboard models without the CPU fan detection latch, only 4-pin CPU fans are controllable in Fan Xpert 2.
- The Fan Xpert 2 may not be able to detect the fan speed if your fan is installed with an external control kit for rotation speed.
- Fan Xpert 2 does not support 2-pin fans. If you install a 2-pin fan, it can only run at its full speed.
- If the CPU or chassis fans have been changed, the Fan Auto Tuning process should be repeated.



DO NOT remove your fan during the Fan Auto Tuning process.

4.3.3 Remote GO!

Remote GO! is an ASUS-exclusive Wi-Fi utility that allows you to wirelessly stream your media files to DLNA devices, control your computer using your smart device, transfer files to your smart device, and provides access to your files stored in your cloud storage.

System requirements

System requirements	PC	Smart device
OS	Windows® 7/Windows® 8	Android 2.3 or later versions iOS5 or later versions
Utilities	ASUS AI Suite 3	ASUS Wi-Fi GO! & NFC Remote



- Install the AI Suite 3 utility from your ASUS motherboard's bundled support DVD.
- For your Android smart device, download the ASUS Wi-Fi GO! & NFC Remote from Google Play. For your iOS smart device, download the ASUS Wi-Fi GO! & NFC Remote from App store.



- Ensure that all Wi-Fi smart devices using the Remote GO! utility must be in the same local area network (LAN).
- The user interface of your smart device may vary with the operating system and the screen resolution.

Smart device supported screen resolutions

Wi-Fi GO! & NFC Remote supports the following screen resolutions of your smart devices:

Screen type	Low Density (120, ldpi)	Medium Density (160, mdpi)	High Density (240, hdpi)	Extra high density (320, xhdpi)
Screen Resolution	1024 x 600	WXGA (1280x800)	1536 x 1152	2048 x 1536
		1024 x 768	1920 x 1152	2560 x 1536
		1280 x 768	1920 x 1200	2560 x 1600

Using Remote GO!

To use Remote GO!, click  on the top edge of the screen, then click **Remote GO!** on the AI Suite 3 main menu bar.



- Launch Wi-Fi GO! & NFC Remote on your smart device to use the Wi-Fi GO! & NFC remote control functions. For more details, refer to section **Wi-Fi GO! & NFC Remote** of this user manual for more details.
- To protect your Wi-Fi utility from unauthorized remote access, click  then set a password.
- Ensure that the ASUS AI Suite 3 utility is active when using the Remote GO! functions.

Using Wi-Fi GO! & NFC Remote

Wi-Fi GO! & NFC Remote allows you to remotely control your computer using your smart device.

Launching Wi-Fi GO! & NFC Remote

1. On your smart device, turn on the Wi-Fi connection. Ensure that your smart device is within the same network as your computer.
2. Tap  > **Enter**, then tap the computer you want to connect with your smart device.
3. Tap **OK** on the confirmation message.

Remote GO functions

- **Cloud GO!:** Allows you to remotely control and sync your files across multiple cloud services such as ASUS WebStorage, GoogleDrive™, and DropBox®.
- **Remote Desktop:** Allows you to remotely control your desktop in real time using your smart device.
- **DLNA Media Hub:** Allows you to stream media files to a DLNA-supported device and remotely control playback using your smart device.
- **File Transfer:** Allows you to transfer files between your computer and your smart device.

Using the Wake-on-LAN

If you want to wake up your computer using the smart device, ensure that you enable the computer's Wake-on-LAN settings. To configure your computer's Wake-on-LAN settings:

1. From BIOS Setup, go to **Advanced > APM** then set Power On By PCIE/PCI item to **[Enabled]**.
2. From Windows® OS, do the following:
 - a. On your desktop, click **Start**, right-click **Computer > Manage** to launch the Computer Management screen.
 - b. Click **Device Manager** to view all the installed devices.
 - c. Click **Network Adapters**, right-click Intel® Ethernet connection I217-V then click **Properties > Power Management** tab.
 - d. Tick these items **Wake on Magic Packet from power off state**.

Using Cloud GO!

1. On your computer, click **Cloud GO!** on the Wi-Fi GO! screen.
2. Click **Enter** to access your cloud storage accounts.
3. Log into your Asus WebStorage, Google Drive™ or Dropbox® cloud account then click **Sign In**.

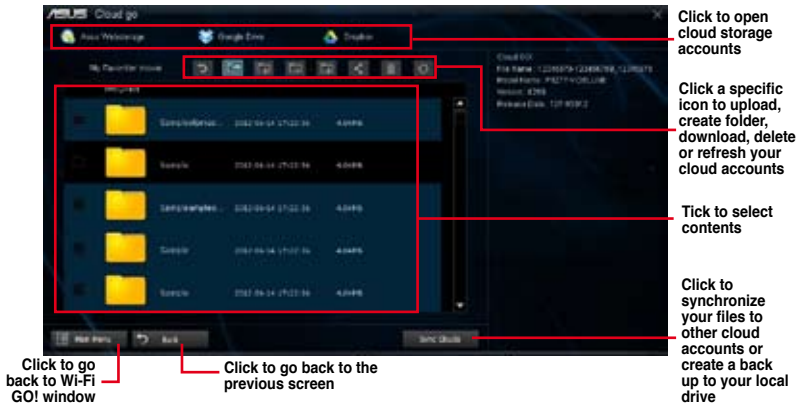

- To access your cloud files from your smart device, ensure that you log into your cloud accounts on your computer.
- Due to the cloud storage limitation, you can only upload or synchronize files with a maximum size of 100 MB.
- Ensure to set the correct system time of your computer for the Cloud GO! to work properly.
- When you synchronize the files, they will automatically synchronize under the Remote GO! folder of each cloud storage. For the backed up files, you can find them in Favorites folder of your local drive.

Using Remote Desktop

1. On your smart device, tap **Remote Desktop > Enter**.
2. Select **Extended Mode** or **Main Screen Mode** to control your computer.



The Extended Mode support varies with the VGA driver installed in your computer.

Using DLNA Media Hub



To stream media files to a DLNA display, enable the remote control functions in your Windows Media Player. To do this, launch **Windows Media Player**, click **Stream** then tick **Allow remote control of my Player** and **Automatically allow devices to play my media**.

Using DLNA Media Hub on the computer

On your computer, click **DLNA Media Hub** then click **Enter**.

The screenshot shows the DLNA Media Hub interface within Windows Media Player. Red callout boxes point to various elements:

- Click to select media file type**: Points to the 'Media Hub' tab.
- Click to edit the playlist**: Points to the 'Edit Playlist' button.
- Click to select receiver**: Points to the 'DLNA Media Hub' window title bar.
- Tick to select source location**: Points to the 'Libraries' dropdown menu.
- Media files pane**: Points to the list of media files.
- Displays the target receiver's name and the media file currently playing**: Points to the 'Connected' window showing 'ASUS (ASUS-PC: WINDOWS MEDIA PLAYER)' and 'Now Playing: 74 (0%)'.
- Click to go back to Wi-Fi GO! window**: Points to the 'Wi-Fi GO!' button.
- Click to go back to previous screen**: Points to the 'Back' button.

Using DLNA Media Hub on the smart device

1. On your smart device, tap **DLNA Media Hub**.
2. Select and tap the receiver name.
3. Tap **Enter** to remotely control your computer.



Using File Transfer



Transferring files from your computer to your smart device

To transfer files from your computer to your smart device, right-click the file then click **Send** to > [Device name]. After the file transfer is complete, click **OK**.



Ensure to enable File Transfer in your smart device to receive files from your computer.

Transferring files from your smart device to your computer

To transfer files from your smart device to your computer, tap **File Transfer** then tap **Enter**. Tick the file that you want to transfer then click **Send**.



- When transferring files from your computer to your iOS device, you can only receive files in PNG, BMP, JPG, GIF, and TIFF formats.
- To receive files on your iOS devices, go to **Settings > Privacy > Photos** then turn the Wi-Fi GO! & NFC Remote on.

4.3.4 USB 3.0 Boost

USB 3.0 Boost technology supports UASP (USB Attached SCSI Protocol) that automatically speeds up the transfer rates of your USB storage devices.

Launching USB 3.0 Boost

To launch USB 3.0 Boost, click  on the top edge of the screen, then click **USB 3.0 Boost** on the AI Suite 3 main menu bar.

Using the USB 3.0 Boost

1. Connect your USB 3.0 device to the USB 3.0 port.
2. From the USB 3.0 Boost screen, select a USB device.
3. To enable UASP on your USB device, click **UASP**. To revert to its normal transfer rate, click **Normal**.

USB 3.0 Boost screen



- Refer to the software manual in the support DVD or visit the ASUS website at www.asus.com for detailed software configuration.
- Use the USB 3.0 devices for high performance. The data transfer speed varies with USB devices.

4.3.5 USB BIOS Flashback Wizard

USB BIOS Flashback Wizard allows you to check and save the latest BIOS version to a USB storage device. Use this utility to quickly check for the latest available BIOS and set the BIOS download schedule.

USB BIOS Flashback Wizard screen



Scheduling the BIOS download

1. In the Download Setting field, tick **Schedule (days)** then select the number of days for the BIOS download schedule.
2. Click **Apply** to save the BIOS download schedule. Click **Cancel** to cancel the download schedule.

Downloading the updated BIOS





Before you start downloading, ensure that you have installed the USB storage device to your computer's USB port that supports USB BIOS Flashback. Refer to section **2.3.1 Rear I/O connection** of your user manual for more details.

To download the updated BIOS:

1. From the USB BIOS Flashback screen, click **Check for New BIOS Update**.

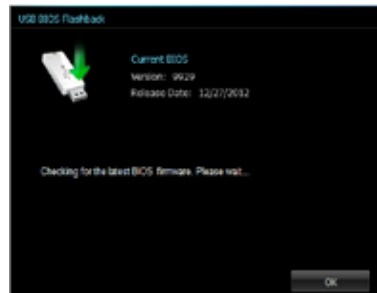
Wait for the system to check the latest BIOS version.



2. After the utility detects a new BIOS, click  from the Save to: field, select the USB flash drive, then click **Download**.

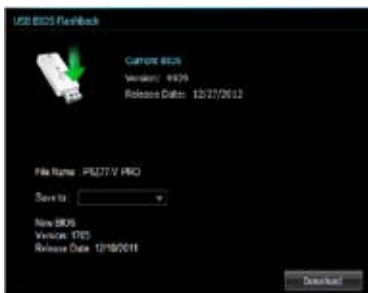

3. After the download is complete, click **OK**.



4.3.6 Ai Charger+

Ai Charger+ allows you to fast-charge your portable BC 1.1* mobile devices on your computer's USB port three times faster than the standard USB devices**.

Launching Ai Charger+

To launch Ai Charger+, click  on the top edge of the screen, then click **Ai Charger+** on the AI Suite 3 main menu bar.

Ai Charger+ screen



Tick to enable or
disable Ai Charger+

Tick to apply the
selection



- * Check the manufacturer if your USB device is a Battery Charging Specification 1.1 (BC 1.1) compliant or compatible device.
- ** Actual charging speeds may vary depending on the charging rate and specifications of your USB device.
- To ensure normal charging function, disconnect and reconnect your USB device every time you enable or disable Ai Charger+.

4.3.7 EZ Update

EZ Update is a utility that allows you to automatically update your motherboard's softwares, drivers and the BIOS version easily.

With this utility, you can also manually update the BIOS and select the boot logo that will display during POST.

Launching EZ Update

To launch EZ Update, click  on the top edge of the screen, then click **EZ Update** on the AI Suite 3 main menu bar.

EZ Update screen

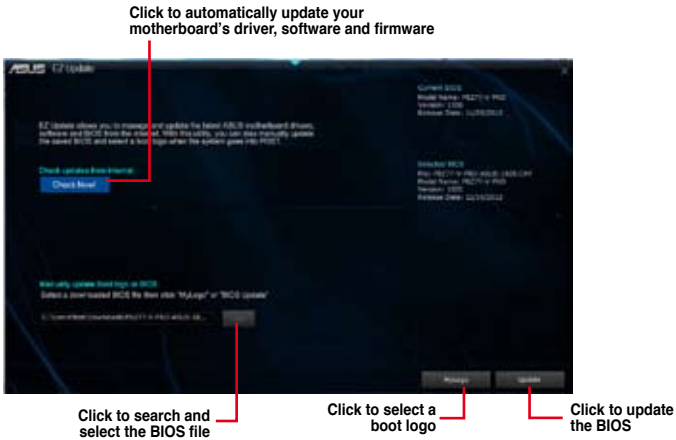

4.3.8 Network iControl

Network iControl is a one-stop setup network control center that allows you to manage your network bandwidth and set the bandwidth priority for your running programs.

Launching Network iControl

To launch Network iControl, click  on the top edge of the screen, then click **Network iControl** on the AI Suite 3 main menu bar.



- Ensure to install the LAN drivers before using this utility.
- Network iControl can only support the onboard LAN.

EZ Start screen



EZ Profile screen

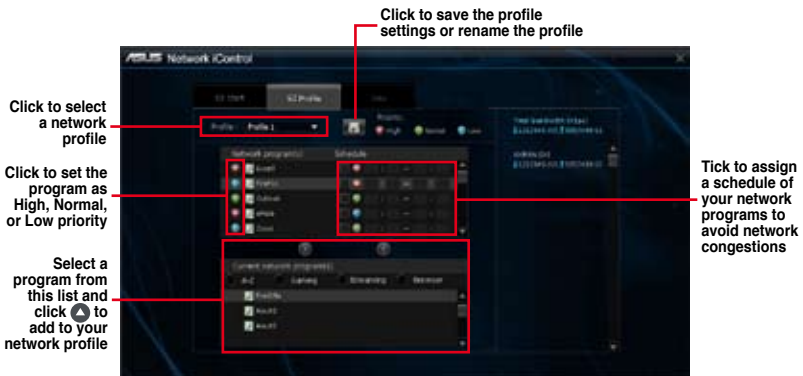

4.3.9 USB Charger+

USB Charger+ allows you to quick-charge your portable USB devices even if your computer is off, in sleep mode or hibernate mode.



Before using USB Charger+, ensure to disable the ErP Ready item from the **Advanced > APM > ErP Ready** in the Advanced mode of the BIOS Setup program.

Launching USB Charger+

To launch USB Charger+, click  on the top edge of the screen, then click **USB Charger+** on the AI Suite 3 main menu bar.

USB Charger+ screen



Click to detect the connected USB device

Indicates that the connected USB device is in charging mode

Click to fast-charge your USB device

Click to stop charging your USB device

Click to apply the settings

Click to discard the settings

Click to select the type of USB device that you wish to charge when the system is off



Ensure to connect your USB device into the USB port that supports this utility. Refer to section 2.3.1 **Rear I/O connection** of your user manual for more details.



- The USB Charger+ does not support USB hubs and USB extension cables, and generic USB cables.
- The USB Charger+ may not recognize some ASUS devices due to a special design.

4.3.10 System Information

This utility allows you get the detailed information of the motherboard, CPU, and memory settings.

Launching the System Information

To launch System Information, click  on the top edge of the screen, then click **System Information** on the AI Suite 3 main menu bar.

Viewing the motherboard information

From the System Information screen, click **MB** tab to view the motherboard's information.



Viewing the CPU information

From the System Information screen, click **CPU** tab to view the processor's information.



Viewing the SPD information

From the System Information screen, click **SPD** tab to view the memory's information.

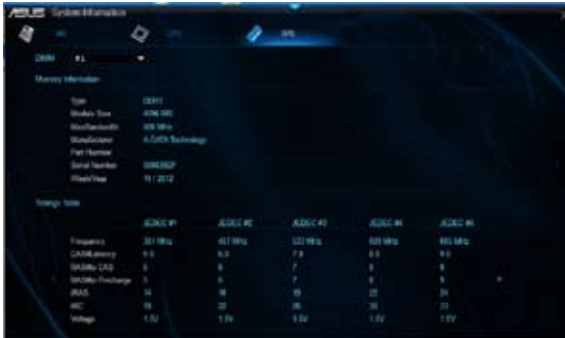

4.3.11 Audio configurations

The Realtek® audio CODEC provides 8-channel audio capability to deliver the ultimate audio experience on your computer. The software provides Jack-Sensing function, S/PDIF Out support, and interrupt capability. The CODEC also includes the Realtek® proprietary UAJ® (Universal Audio Jack) technology for all audio ports, eliminating cable connection errors, and giving users plug and play convenience.

Follow the installation wizard to install the Realtek® Audio Driver from the support DVD that came with the motherboard package.

If the Realtek® audio software is correctly installed, you will find the Realtek® HD Audio Manager icon on the taskbar. Double-click on the icon to display the Realtek® HD Audio Manager.





Realtek® HD Audio Manager

A. **Realtek® HD Audio Manager with DTS UltraPC II for Windows® 8 / Windows® 7**



This version of Realtek HD Audio Manager supports Intel® 8 Series motherboards and other selected models.

B. Realtek® HD Audio Manager with DTS UltraPC II for Windows® 8 / Windows® 7

To display Quick Volume Adjustment Bar, click  from the taskbar then click .

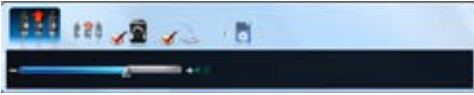

To launch Realtek® HD Audio Manager, click  from the taskbar then double-click .



- Refer to the software manual in the support DVD or visit the ASUS website at www.asus.com for detailed software configuration.
- To play Blu-Ray™ disc, make sure to use an HDCP compliant monitor.

RAID support

5

5.1 RAID configurations

The motherboard supports the following SATA RAID solutions:

- Intel® Rapid Storage Technology with RAID 0, RAID 1, RAID 10 and RAID 5 support.



If you want to install a Windows® operating system to a hard disk drive included in a RAID set, you have to create a RAID driver disk and load the RAID driver during OS installation. Refer to section 5.2 **Creating a RAID driver disk** for details.

5.1.1 RAID definitions

RAID 0 (Data striping) optimizes two identical hard disk drives to read and write data in parallel, interleaved stacks. Two hard disks perform the same work as a single drive but at a sustained data transfer rate, double that of a single disk alone, thus improving data access and storage. Use of two new identical hard disk drives is required for this setup.

RAID 1 (Data mirroring) copies and maintains an identical image of data from one drive to a second drive. If one drive fails, the disk array management software directs all applications to the surviving drive as it contains a complete copy of the data in the other drive. This RAID configuration provides data protection and increases fault tolerance to the entire system. Use two new drives or use an existing drive and a new drive for this setup. The new drive must be of the same size or larger than the existing drive.

RAID 5 stripes both data and parity information across three or more hard disk drives. Among the advantages of RAID 5 configuration include better HDD performance, fault tolerance, and higher storage capacity. The RAID 5 configuration is best suited for transaction processing, relational database applications, enterprise resource planning, and other business systems. Use a minimum of three identical hard disk drives for this setup.

RAID 10 is data striping and data mirroring combined without parity (redundancy data) having to be calculated and written. With the RAID 10 configuration you get all the benefits of both RAID 0 and RAID 1 configurations. Use four new hard disk drives or use an existing drive and three new drives for this setup.

5.1.2 Installing Serial ATA hard disks

The motherboard supports Serial ATA hard disk drives. For optimal performance, install identical drives of the same model and capacity when creating a disk array.

To install the SATA hard disks for a RAID configuration:

1. Install the SATA hard disks into the drive bays.
2. Connect the SATA signal cables.
3. Connect a SATA power cable to the power connector on each drive.

5.1.3 Setting the RAID item in BIOS

You must enable the RAID function in the BIOS Setup before creating RAID sets using SATA HDDs. To do this:

1. Enter the BIOS Setup during POST.
2. Go to the **Advanced** menu > **SATA Configuration**, and then press <Enter>.
3. Set the SATA Mode item to [RAID Mode].
4. Save your changes, and then exit the BIOS Setup.



Refer to Chapter 3 for details on entering and navigating through the BIOS Setup



Due to chipset limitation, when SATA ports are set to RAID mode, all SATA ports run at RAID mode together.

5.1.4 Intel® Rapid Storage Technology Option ROM utility

To enter the Intel® Rapid Storage Technology Option ROM utility:

1. Turn on the system.
2. During POST, press <Ctrl> + <I> to display the utility main menu.

```
Intel(R) Rapid Storage Technology - Option ROM - v10.5.1.1070
Copyright(C) 2003-10 Intel Corporation. All Rights Reserved.

[ MAIN MENU ]
1. Create RAID Volume      4. Recovery Volume Options
2. Delete RAID Volume     5. Acceleration Options
3. Reset Disks to Non-RAID 6. Exit

[ DISK/VOLUME INFORMATION ]

RAID Volumes:
None defined.

Physical Devices:
Port Device Model      Serial #      Size  Type/Status (Vol ID)
0  ST3160812AS         9LS0HJA4     149.0GB Non-RAID Disk
1  ST3160812AS         9LS0F4HL     149.0GB Non-RAID Disk
2  ST3160812AS         3LS0JYL8     149.0GB Non-RAID Disk
3  ST3160812AS         9LS0B75H     149.0GB Non-RAID Disk

[↑↓]-Select      [ESC]-Exit      [ENTER]-Select Menu
```

The navigation keys at the bottom of the screen allow you to move through the menus and select the menu options.



The RAID BIOS setup screens shown in this section are for reference only and may not exactly match the items on your screen.



The utility supports maximum four hard disk drives for RAID configuration.

Creating a RAID set

To create a RAID set:

1. From the utility main menu, select **1. Create RAID Volume** and press <Enter>. The following screen appears:

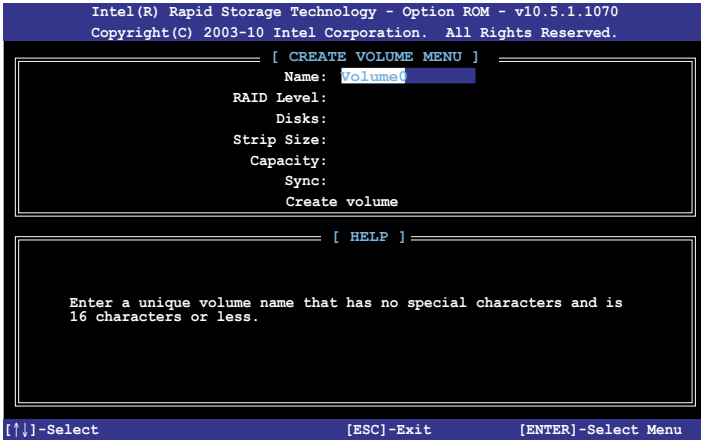

2. Enter a name for the RAID set and press <Enter>.
3. When the RAID Level item is selected, press the up/down arrow key to select a RAID level to create, and then press <Enter>.
4. When the Disks item is selected, press <Enter> to select the hard disk drives you want to include in the RAID set. The SELECT DISKS screen appears:

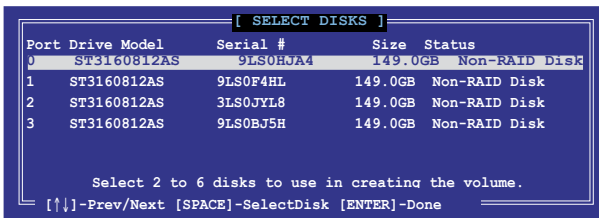

5. Use the up/down arrow key to select a drive, and then press <Space> to select. A small triangle marks the selected drive. Press <Enter> after completing your selection.
6. Use the up/down arrow key to select the stripe size for the RAID array (for RAID 0, 10 and 5 only), and then press <Enter>. The available stripe size values range from 4KB to 128KB. The following are typical values:
 - RAID 0: 128KB
 - RAID 10: 64KB
 - RAID 5: 64KB



We recommend a lower stripe size for server systems, and a higher stripe size for multimedia computer systems used mainly for audio and video editing.

7. When the **Capacity** item is selected, enter the RAID volume capacity that you want and press <Enter>. The default value indicates the maximum allowed capacity.
8. When the **Create Volume** item is selected, press <Enter>. The following warning message appears:

WARNING: ALL DATA ON SELECTED DISKS WILL BE LOST
Are you sure you want to create this volume? (Y/N) :

9. Press <Y> to create the RAID volume and return to the main menu, or <N> to go back to the CREATE VOLUME menu.

Deleting a RAID set



Be cautious when deleting a RAID set. You will lose all data on the hard disk drives when you delete a RAID set.

To delete a RAID set:

1. From the utility main menu, select **2. Delete RAID Volume** and press <Enter>. The following screen appears:

```
[ DELETE VOLUME MENU ]
Name      Level      Drives  Capacity  Status  Bootable
Volume0   RAID0 (Stripe)  2       298.0GB  Normal  Yes

[ HELP ]

Deleting a volume will reset the disks to non-RAID.

WARNING: ALL DISK DATA WILL BE DELETED.
        (This does not apply to Recovery volumes)

[↑]-Select      [ESC]-Previous Menu  [DEL]-Delete Volume
```

2. Use the up/down arrow key to select the RAID set you want to delete, and then press <delete>. The following warning message appears:

```
[ DELETE VOLUME VERIFICATION ]

ALL DATA IN THE VOLUME WILL BE LOST!
(This does not apply to Recovery volumes)

Are you sure you want to delete volume "Volume0"? (Y/N):
```

3. Press <Y> to delete the RAID set and return to the utility main menu, or press <N> to return to the DELETE VOLUME menu.

Exiting the Intel® Rapid Storage Technology Option ROM utility

To exit the utility:

1. From the utility main menu, select **5. Exit**, and then press <Enter>. The following warning message appears:

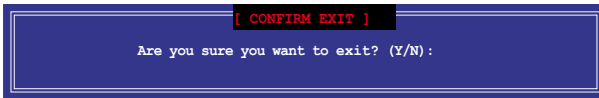

2. Press <Y> to exit or press <N> to return to the utility main menu.

5.2 Creating a RAID driver disk

A floppy disk with the RAID driver is required when installing a Windows® operating system on a hard disk drive that is included in a RAID set.



The motherboard does not provide a floppy drive connector. You have to use a USB floppy disk drive when creating a SATA RAID driver disk.

5.2.1 Creating a RAID driver disk without entering the OS

To create a RAID driver disk without entering the OS:

1. Boot your computer.
2. Press <delete> during POST to enter the BIOS setup utility.
3. Set the optical drive as the primary boot device.
4. Insert the support DVD into the optical drive.
5. Save changes and exit BIOS.
6. When the Make Disk menu appears, press <1> to create a RAID driver disk.
7. Insert a formatted floppy disk into the USB floppy disk drive, then press <Enter>.
8. Follow the succeeding screen instructions to complete the process.

5.2.2 Creating a RAID driver disk in Windows®

To create a RAID driver disk in Windows®:

1. Start Windows®.
2. Plug the USB floppy disk drive and insert a floppy disk.
3. Place the motherboard support DVD into the optical drive.
4. Go to the **Intel AHCI/RAID Driver** menu then click **Intel AHCI/RAID Driver path** to open the RAID driver folder.
5. Select **32bit** or **64bit** folder depending on your operating system. Copy the files of the selected folder to the root path of your USB floppy disk drive.



Write-protect the floppy disk to avoid a computer virus infection.

5.2.3 Installing the RAID driver during Windows® OS installation

To install the RAID driver for Windows® 7:

1. During the OS installation, click **Load Driver** to allow you to select the installation media containing the RAID driver.
2. Insert the USB flash drive with RAID driver into the USB port or the support DVD into the optical drive, and then click **Browse**.
3. Click the name of the device you've inserted, go to **Drivers > RAID**, and then select the RAID driver for the corresponding OS version. Click **OK**.
4. Follow the succeeding screen instructions to complete the installation.



Before loading the RAID driver from a USB flash drive, you have to use another computer to copy the RAID driver from the support DVD to the USB flash drive.



To set up a Windows® UEFI operating system under RAID mode, ensure to load the UEFI driver for your optical drive.

Appendices

Notices

Federal Communications Commission Statement

This device complies with Part 15 of the FCC Rules. Operation is subject to the following two conditions:

- This device may not cause harmful interference.
- This device must accept any interference received including interference that may cause undesired operation.

This equipment has been tested and found to comply with the limits for a Class B digital device, pursuant to Part 15 of the FCC Rules. These limits are designed to provide reasonable protection against harmful interference in a residential installation. This equipment generates, uses and can radiate radio frequency energy and, if not installed and used in accordance with manufacturer's instructions, may cause harmful interference to radio communications. However, there is no guarantee that interference will not occur in a particular installation. If this equipment does cause harmful interference to radio or television reception, which can be determined by turning the equipment off and on, the user is encouraged to try to correct the interference by one or more of the following measures:

- Reorient or relocate the receiving antenna.
- Increase the separation between the equipment and receiver.
- Connect the equipment to an outlet on a circuit different from that to which the receiver is connected.
- Consult the dealer or an experienced radio/TV technician for help.



The use of shielded cables for connection of the monitor to the graphics card is required to assure compliance with FCC regulations. Changes or modifications to this unit not expressly approved by the party responsible for compliance could void the user's authority to operate this equipment.

IC: Canadian Compliance Statement

Complies with the Canadian ICES-003 Class B specifications. This device complies with RSS 210 of Industry Canada. This Class B device meets all the requirements of the Canadian interference-causing equipment regulations.

This device complies with Industry Canada license exempt RSS standard(s). Operation is subject to the following two conditions: (1) this device may not cause interference, and (2) this device must accept any interference, including interference that may cause undesired operation of the device.

Cet appareil numérique de la Classe B est conforme à la norme NMB-003 du Canada. Cet appareil numérique de la Classe B respecte toutes les exigences du Règlement sur le matériel brouilleur du Canada.

Cet appareil est conforme aux normes CNR exemptes de licence d'Industrie Canada. Le fonctionnement est soumis aux deux conditions suivantes :

- (1) cet appareil ne doit pas provoquer d'interférences et
- (2) cet appareil doit accepter toute interférence, y compris celles susceptibles de provoquer un fonctionnement non souhaité de l'appareil.

Canadian Department of Communications Statement

This digital apparatus does not exceed the Class B limits for radio noise emissions from digital apparatus set out in the Radio Interference Regulations of the Canadian Department of Communications.

This class B digital apparatus complies with Canadian ICES-003.

VCCI: Japan Compliance Statement

VCCI Class B Statement

情報処理装置等電波障害自主規制について

この装置は、情報処理装置等電波障害自主規制協議会（VCCI）の基準に基づくクラスB情報技術装置です。この装置は家庭環境で使用することを目的としていますが、この装置がラジオやテレビジョン受信機に近接して使用されると、受信障害を引き起こすことがあります。

取扱説明書に従って正しい取り扱いをして下さい。

KC: Korea Warning Statement

B급 기기 (가정용 방송통신기자재)

이 기기는 가정용(B급) 전자파적합기기로서 주로 가정에서 사용하는 것을 목적으로 하며, 모든 지역에서 사용할 수 있습니다.

*당해 무선설비는 전파혼신 가능성이 있으므로 인명안전과 관련된 서비스는 할 수 없습니다.

REACH

Complying with the REACH (Registration, Evaluation, Authorisation, and Restriction of Chemicals) regulatory framework, we published the chemical substances in our products at ASUS REACH website at <http://csr.asus.com/english/REACH.htm>.



DO NOT throw the motherboard in municipal waste. This product has been designed to enable proper reuse of parts and recycling. This symbol of the crossed out wheeled bin indicates that the product (electrical and electronic equipment) should not be placed in municipal waste. Check local regulations for disposal of electronic products.



DO NOT throw the mercury-containing button cell battery in municipal waste. This symbol of the crossed out wheeled bin indicates that the battery should not be placed in municipal waste.

ASUS Recycling/Takeback Services

ASUS recycling and takeback programs come from our commitment to the highest standards for protecting our environment. We believe in providing solutions for you to be able to responsibly recycle our products, batteries, other components as well as the packaging materials. Please go to <http://csr.asus.com/english/Takeback.htm> for detailed recycling information in different regions.

ASUS contact information

ASUSTeK COMPUTER INC.

Address	15 Li-Te Road, Peitou, Taipei, Taiwan 11259
Telephone	+886-2-2894-3447
Fax	+886-2-2890-7798
E-mail	info@asus.com.tw
Web site	www.asus.com.tw

Technical Support

Telephone	+86-21-38429911
Online support	support.asus.com

ASUS COMPUTER INTERNATIONAL (America)

Address	800 Corporate Way, Fremont, CA 94539, USA
Telephone	+1-812-282-3777
Fax	+1-510-608-4555
Web site	usa.asus.com

Technical Support

Telephone	+1-812-282-2787
Support fax	+1-812-284-0883
Online support	support.asus.com

ASUS COMPUTER GmbH (Germany and Austria)

Address	Harkort Str. 21-23, D-40880 Ratingen, Germany
Fax	+49-2102-959911
Web site	www.asus.de
Online contact	www.asus.de/sales

Technical Support

Telephone	+49-1805-010923*
Support Fax	+49-2102-9599-11
Online support	support.asus.com

* EUR 0.14/minute from a German fixed landline; EUR 0.42/minute from a mobile phone.

DECLARATION OF CONFORMITY

Per FCC Part 2 Section 2.1077(a)



Responsible Party Name: **Asus Computer International**

Address: **800 Corporate Way, Fremont, CA 94539.**

Phone/Fax No: **(510)739-3777/(510)608-4555**

hereby declares that the product

Product Name : Motherboard

Model Number : Z87-PLUS

Conforms to the following specifications:

- FCC Part 15, Subpart B, Unintentional Radiators

Supplementary Information:

This device complies with part 15 of the FCC Rules. Operation is subject to the following two conditions: (1) This device may not cause harmful interference, and (2) this device must accept any interference received, including interference that may cause undesired operation.

Representative Person's Name : Steve Chang / President

Signature :

Date : Mar. 28, 2013

Ver. 12/001

EC Declaration of Conformity



We, the undersigned,

ASUS/ASUS COMPUTER INC.
Authorized signatory:
Address: 4F, No. 199, LITE-ELC, REITOU, TAIPEI 112, TAIWAN
Country: TAIWAN
Authorized representative in Europe:
ASUS COMPUTER GmbH
Address: HARKORT STR. 21-23, 40880 RATINGEN
Country: GERMANY

declare the following apparatus:

Product name : Motherboard
Model name : Z87-PLUS

conform with the essential requirements of the following directives:

2004/108/EC EMC Directive
 EN 55024:2010
 EN 55022:2010
 EN 61000-3-2:2006+A2:2009
 EN 61000-3-3:2004
 EN 55025:2010/EN 55011:2011

1989/EC B-ATTE Directive
 EN 300 333 V1.7 (2006-10)
 EN 300 440 V1.6 (2001-08)
 EN 300 440 V2 V1.4 (2001-08)
 EN 300 440 V3 V1.4 (2001-08)
 EN 301 885 V1 V2 (2001-05)
 EN 301 885 V2 V2.1 (2009-05)
 EN 301 885 V3 V2.1 (2009-05)
 EN 302 328 V1.1 (2009-01)
 EN 302 328 V2 V1.1 (2009-01)
 EN 302 328 V3 V1.3 (2007-09)
 EN 302 328 V4 V1.3 (2007-09)
 EN 302 291 V1.1 (2006-07)
 EN 302 291 V2 V1.1 (2006-07)

2006/95/EC LVD Directive
 EN 60950-1: A12:2011
 EN 60950-2: A12:2011

2009/125/EC EUP Directive
 Regulation (EC) No. 1275/2008
 Regulation (EC) No. 642/2009

CE marking
 2011/65/EU RoHS Directive



(EC conformity marking)

Position : CEO
Name : Jerry Shen

Signature : _____

Declaration Date: 28/03/2013
Year to begin affixing CE marking: 2013

Ver.: 100208

Free Manuals Download Website

<http://myh66.com>

<http://usermanuals.us>

<http://www.somanuals.com>

<http://www.4manuals.cc>

<http://www.manual-lib.com>

<http://www.404manual.com>

<http://www.luxmanual.com>

<http://aubethermostatmanual.com>

Golf course search by state

<http://golfingnear.com>

Email search by domain

<http://emailbydomain.com>

Auto manuals search

<http://auto.somanuals.com>

TV manuals search

<http://tv.somanuals.com>