

M5A97 R2.0



Motherboard

Copyright © 2013 ASUSTeK COMPUTER INC. All Rights Reserved.

No part of this manual, including the products and software described in it, may be reproduced, transmitted, transcribed, stored in a retrieval system, or translated into any language in any form or by any means, except documentation kept by the purchaser for backup purposes, without the express written permission of ASUSTeK COMPUTER INC. ("ASUS").

Product warranty or service will not be extended if: (1) the product is repaired, modified or altered, unless such repair, modification of alteration is authorized in writing by ASUS; or (2) the serial number of the product is defaced or missing.

ASUS PROVIDES THIS MANUAL "AS IS" WITHOUT WARRANTY OF ANY KIND, EITHER EXPRESS OR IMPLIED, INCLUDING BUT NOT LIMITED TO THE IMPLIED WARRANTIES OR CONDITIONS OF MERCHANTABILITY OR FITNESS FOR A PARTICULAR PURPOSE. IN NO EVENT SHALL ASUS, ITS DIRECTORS, OFFICERS, EMPLOYEES OR AGENTS BE LIABLE FOR ANY INDIRECT, SPECIAL, INCIDENTAL, OR CONSEQUENTIAL DAMAGES (INCLUDING DAMAGES FOR LOSS OF PROFITS, LOSS OF BUSINESS, LOSS OF USE OR DATA, INTERRUPTION OF BUSINESS AND THE LIKE), EVEN IF ASUS HAS BEEN ADVISED OF THE POSSIBILITY OF SUCH DAMAGES ARISING FROM ANY DEFECT OR ERROR IN THIS MANUAL OR PRODUCT.

SPECIFICATIONS AND INFORMATION CONTAINED IN THIS MANUAL ARE FURNISHED FOR INFORMATIONAL USE ONLY, AND ARE SUBJECT TO CHANGE AT ANY TIME WITHOUT NOTICE, AND SHOULD NOT BE CONSTRUED AS A COMMITMENT BY ASUS. ASUS ASSUMES NO RESPONSIBILITY OR LIABILITY FOR ANY ERRORS OR INACCURACIES THAT MAY APPEAR IN THIS MANUAL, INCLUDING THE PRODUCTS AND SOFTWARE DESCRIBED IN IT.

Products and corporate names appearing in this manual may or may not be registered trademarks or copyrights of their respective companies, and are used only for identification or explanation and to the owners' benefit, without intent to infringe.

Offer to Provide Source Code of Certain Software

This product contains copyrighted software that is licensed under the General Public License ("GPL"), under the Lesser General Public License Version ("LGPL") and/or other Free Open Source Software Licenses. Such software in this product is distributed without any warranty to the extent permitted by the applicable law. Copies of these licenses are included in this product.

Where the applicable license entitles you to the source code of such software and/or other additional data, you may obtain it for a period of three years after our last shipment of the product, either

(1) for free by downloading it from <http://support.asus.com/download>

or

(2) for the cost of reproduction and shipment, which is dependent on the preferred carrier and the location where you want to have it shipped to, by sending a request to:

ASUSTeK Computer Inc.
Legal Compliance Dept.
15 Li Te Rd.,
Beitou, Taipei 112
Taiwan

In your request please provide the name, model number and version, as stated in the About Box of the product for which you wish to obtain the corresponding source code and your contact details so that we can coordinate the terms and cost of shipment with you.

The source code will be distributed WITHOUT ANY WARRANTY and licensed under the same license as the corresponding binary/object code.

This offer is valid to anyone in receipt of this information.

ASUSTeK is eager to duly provide complete source code as required under various Free Open Source Software licenses. If however you encounter any problems in obtaining the full corresponding source code we would be much obliged if you give us a notification to the email address gpl@asus.com, stating the product and describing the problem (please DO NOT send large attachments such as source code archives, etc. to this email address).

Contents

Safety information.....	vi
About this guide.....	vii
M5A97 R2.0 specifications summary	ix
Package contents.....	xii
Installation tools and components.....	xiii
Chapter 1: Product introduction	
1.1 Special features.....	1-1
1.1.1 Product highlights.....	1-1
1.1.2 DIP (Dual Intelligent Processors) - TPU (TurboV Processing Unit) & EPU (Energy Processing Unit)	1-2
1.1.3 ASUS Exclusive Features.....	1-2
1.1.4 ASUS Quiet Thermal Solution.....	1-3
1.1.5 ASUS EZ DIY.....	1-3
1.1.6 Other Features	1-4
1.2 Motherboard overview.....	1-5
1.2.1 Before you proceed.....	1-5
1.2.2 Motherboard layout.....	1-6
1.2.3 Central Processing Unit (CPU)	1-8
1.2.4 System memory	1-8
1.2.5 Expansion slots.....	1-14
1.2.6 Onboard switches and buttons.....	1-16
1.2.7 Jumpers	1-19
1.2.8 Onboard LEDs	1-20
1.2.9 Internal connectors.....	1-21
Chapter 2: Basic Installation	
2.1 Building your PC system.....	2-1
2.1.1 Motherboard installation.....	2-1
2.1.2 CPU installation.....	2-4
2.1.3 CPU heatsink and fan assembly installation	2-5
2.1.4 DIMM installation.....	2-8
2.1.5 ATX Power connection.....	2-9
2.1.6 SATA device connection.....	2-10
2.1.7 Expansion Card installation.....	2-11
2.2 BIOS update utility.....	2-12
2.2.1 USB BIOS Flashback.....	2-12
2.3 Motherboard rear and audio connections	2-13

2.3.1	Rear I/O connection	2-13
2.3.2	Audio I/O connections	2-15
2.4	Starting up for the first time	2-17
2.5	Turning off the computer	2-17

Chapter 3: BIOS setup

3.1	Knowing BIOS	3-1
3.2	BIOS setup program	3-2
3.2.1	EZ Mode	3-3
3.2.2	Advanced Mode	3-4
3.3	Main menu	3-6
3.4	Ai Tweaker menu	3-8
3.5	Advanced menu	3-14
3.5.1	CPU Configuration	3-14
3.5.2	North Bridge	3-15
3.5.3	South Bridge	3-16
3.5.4	SATA Configuration	3-16
3.5.5	USB Configuration	3-17
3.5.6	CPU Core On/Off Function	3-18
3.5.7	Onboard Devices Configuration	3-18
3.5.8	APM	3-19
3.5.9	Network Stack	3-20
3.6	Monitor menu	3-21
3.7	Boot menu	3-24
3.8	Tools menu	3-26
3.8.1	ASUS EZ Flash 2 Utility	3-26
3.8.2	ASUS SPD Information	3-26
3.8.3	ASUS O.C. Profile	3-26
3.9	Exit menu	3-27
3.10	Updating BIOS	3-28
3.10.1	ASUS Update	3-28
3.10.2	ASUS EZ Flash 2	3-31
3.10.3	ASUS BIOS Updater	3-33

Chapter 4: Software support

4.1	Installing an operating system	4-1
4.2	Support DVD information	4-1
4.2.1	Running the support DVD	4-1
4.2.2	Obtaining the software manuals	4-2

4.3	Software information	4-3
4.3.1	AI Suite II.....	4-3
4.3.2	TurboV EVO.....	4-4
4.3.3	EPU.....	4-8
4.3.4	Remote GO!.....	4-9
4.3.5	USB 3.0 Boost.....	4-20
4.3.6	Network iControl.....	4-21
4.3.7	USB BIOS Flashback Wizard.....	4-25
4.3.8	FAN Xpert.....	4-27
4.3.9	Ai Charger+.....	4-28
4.3.10	Probe II.....	4-29
4.3.11	Sensor Recorder.....	4-30
4.3.12	ASUS Update.....	4-32
4.3.13	MyLogo2.....	4-33
4.3.14	Audio configurations.....	4-35

Chapter 5: RAID support

5.1	RAID configurations	5-1
5.1.1	RAID definitions	5-1
5.1.2	Installing Serial ATA hard disks	5-2
5.1.3	Setting the RAID item in BIOS	5-2
5.1.4	AMD® Option ROM utility	5-3
5.2	Creating a RAID driver disk.....	5-6
5.2.1	Creating a RAID driver disk without entering the OS.....	5-6
5.2.2	Creating a RAID driver disk in Windows®.....	5-6
5.2.3	Installing the RAID driver during Windows® OS installation.....	5-7
5.2.4	Using a USB floppy disk drive.....	5-8

Chapter 6: Multiple GPU support

6.1	AMD® CrossFireX™ technology	6-1
6.1.1	Requirements.....	6-1
6.1.2	Before you begin.....	6-1
6.1.3	Installing two CrossFireX™ graphics cards	6-2
6.1.4	Installing the device drivers.....	6-3
6.1.5	Enabling the AMD® CrossFireX™ technology.....	6-3

Appendices

Notices	A-1
ASUS contact information.....	A-4

Safety information

Electrical safety

- To prevent electrical shock hazard, disconnect the power cable from the electrical outlet before relocating the system.
- When adding or removing devices to or from the system, ensure that the power cables for the devices are unplugged before the signal cables are connected. If possible, disconnect all power cables from the existing system before you add a device.
- Before connecting or removing signal cables from the motherboard, ensure that all power cables are unplugged.
- Seek professional assistance before using an adapter or extension cord. These devices could interrupt the grounding circuit.
- Ensure that your power supply is set to the correct voltage in your area. If you are not sure about the voltage of the electrical outlet you are using, contact your local power company.
- If the power supply is broken, do not try to fix it by yourself. Contact a qualified service technician or your retailer.

Operation safety

- Before installing the motherboard and adding devices on it, carefully read all the manuals that came with the package.
- Before using the product, ensure all cables are correctly connected and the power cables are not damaged. If you detect any damage, contact your dealer immediately.
- To avoid short circuits, keep paper clips, screws, and staples away from connectors, slots, sockets and circuitry.
- Avoid dust, humidity, and temperature extremes. Do not place the product in any area where it may become wet.
- Place the product on a stable surface.
- If you encounter technical problems with the product, contact a qualified service technician or your retailer.

About this guide

This user guide contains the information you need when installing and configuring the motherboard.

How this guide is organized

This guide contains the following parts:

- **Chapter 1: Product introduction**
This chapter describes the features of the motherboard and the new technology it supports. It includes description of the switches, jumpers, and connectors on the motherboard.
- **Chapter 2: Basic Installation**
This chapter lists the hardware setup procedures that you have to perform when installing system components.
- **Chapter 3: BIOS setup**
This chapter tells how to change system settings through the BIOS Setup menus. Detailed descriptions of the BIOS parameters are also provided.
- **Chapter 4: Software support**
This chapter describes the contents of the support DVD that comes with the motherboard package and the software.
- **Chapter 5: RAID support**
This chapter describes the RAID configurations.
- **Chapter 6: Multiple GPU technology support**
This chapter describes how to install and configure multiple AMD® CrossFireX™ graphics cards.

Where to find more information

Refer to the following sources for additional information and for product and software updates.

1. **ASUS websites**
The ASUS website provides updated information on ASUS hardware and software products. Refer to the ASUS contact information.
2. **Optional documentation**
Your product package may include optional documentation, such as warranty flyers, that may have been added by your dealer. These documents are not part of the standard package.

Conventions used in this guide

To ensure that you perform certain tasks properly, take note of the following symbols used throughout this manual.



DANGER/WARNING: Information to prevent injury to yourself when trying to complete a task.



CAUTION: Information to prevent damage to the components when trying to complete a task



IMPORTANT: Instructions that you **MUST** follow to complete a task.



NOTE: Tips and additional information to help you complete a task.

Typography

Bold text

Indicates a menu or an item to select.

Italics

Used to emphasize a word or a phrase.

<Key>

Keys enclosed in the less-than and greater-than sign means that you must press the enclosed key.

Example: <Enter> means that you must press the Enter or Return key.

<Key1> + <Key2> + <Key3>

If you must press two or more keys simultaneously, the key names are linked with a plus sign (+).

M5A97 R2.0 specifications summary

CPU	<p>AMD® Socket AM3+ for AMD® FX Series CPU up to 8-core, compatible with AMD® Socket AM3 for AMD® Phenom™ II / Athlon™ II / Sempron™ 100 Series processors</p> <p>AMD® 140W CPU Support</p> <p>AMD® Cool 'n' Quiet™ support</p> <p>Support AM3+ 32nm CPU</p> <ul style="list-style-type: none"> Refer to www.asus.com for the AMD® CPU support list
Chipset	AMD® 970 / SB950
System Bus	Up to 4800MT/s; HyperTransport™ 3.0
Memory	<p>4 x DIMMs, Max. 32GB, DDR3 2133 (O.C.)/1866/1600/1333/1066 MHz, ECC, Non-ECC, unbuffered memory</p> <ul style="list-style-type: none"> The maximum 32GB memory capacity can be supported with 8GB or above DIMMs. ASUS will update the memory QVL once the DIMMs are available in the market. Due to CPU spec, AMD 100 Series CPUs support up to DDR3 1066MHz. With ASUS design, this motherboard can support up to DDR3 1333MHz. Refer to www.asus.com for the latest Memory QVL (Qualified Vendors List). When you install a total memory of 4GB capacity or more, Windows® 32-bit operating system may only recognize less than 3GB. We recommend a maximum of 3GB system memory if you are using a Windows® 32-bit operating system.
Expansion slots	<p>2 x PCIe 2.0 x16 slots (Blue @x16 speed, Black @x4 speed)</p> <p>2 x PCIe 2.0 x1 slots</p> <p>2 x PCI slots</p>
Multi-GPU support	Supports AMD® Quad-GPU CrossFireX™ Technology
Storage	<p>AMD® SB950 Chipset:</p> <ul style="list-style-type: none"> 6 x Serial ATA 6.0Gb/s ports with RAID 0, 1, 5, 10
LAN	Realtek® 8111F Gigabit LAN controller
Audio	<p>Realtek 887 8-channel High Definition Audio CODEC</p> <ul style="list-style-type: none"> Supports Jack-Detection, Multi-Streaming, Front Panel Jack-Retasking Supports optical S/PDIF out interface at the back I/O ASUS Noise Filter
USB	<p>AMD® SB950 Chipset:</p> <ul style="list-style-type: none"> 12 x USB 2.0/1.1 ports (6 ports at the mid-board, 6 ports at the back panel) <p>2 x Asmedia® USB3.0 controller:</p> <ul style="list-style-type: none"> 2 x USB 3.0/2.0 ports at back panel (blue)* 2 x USB 3.0/2.0 ports at mid-board for front panel support <p>* Supports ASUS USB 3.0 Boost UASP Mode.</p>

(continued on the next page)

M5A97 R2.0 specifications summary

ASUS unique features	<p>ASUS Dual Intelligent Processors</p> <ul style="list-style-type: none">ASUS EPU- EPUASUS TPU- Auto Tuning, TurboV <p>ASUS Power Design</p> <ul style="list-style-type: none">- 4+2 Phase Power Design <p>ASUS Exclusive Features</p> <ul style="list-style-type: none">- ASUS UEFI BIOS EZ Mode featuring friendly graphics user interface- ASUS Remote GO!- ASUS USB 3.0 Boost- ASUS Network iControl- Front Panel USB 3.0 Support- ASUS MemOK!- ASUS AI Suite II- ASUS Ai Charger+ <p>ASUS Quiet Thermal Solution</p> <ul style="list-style-type: none">- ASUS Fanless Design: heatsink solution- ASUS Fan Xpert <p>ASUS EZ DIY</p> <ul style="list-style-type: none">- ASUS DirectKey- USB BIOS Flashback with USB BIOS Flashback Wizard for EZ BIOS download scheduling- ASUS O.C. Profile- Precision Tweaker 2- Multi-language BIOS- ASUS EZ Flash 2- ASUS My Logo 2 <p>ASUS Q Design</p> <ul style="list-style-type: none">- ASUS Q-Slot
ASUS exclusive overclocking features	<p>Precision Tweaker 2</p> <ul style="list-style-type: none">- vCore: Adjustable CPU voltage at 0.00625V increment- vDDNB: Adjustable CPU/NB voltage at 0.00625V increment- vNB: Adjustable NB voltage at 0.00625V increment- vNB HT Bus: Adjustable HT voltage at 0.00625V increment- vDRAM Bus: Adjustable DRAM voltage at 0.00625V increment- vSB: Adjustable SB voltage at 0.00500V increment <p>SFS (Stepless Frequency Selection):</p> <ul style="list-style-type: none">- Internal Base Clock tuning from 100MHz up to 600MHz at 1MHz increment- PCI Express frequency tuning from 100MHz up to 150MHz at 1MHz increment <p>Overclocking Protection:</p> <ul style="list-style-type: none">- ASUS C.P.R (CPU Parameter Recall)

(continued on the next page)

M5A97 R2.0 specifications summary



Back Panel I/O ports	<ul style="list-style-type: none"> 1 x PS/2 Keyboard (Purple) 1 x PS/2 Mouse (Green) 1 x Optical S/PDIF output port 1 x LAN (RJ-45) port 6 x USB 2.0/1.1 ports (1 port supports USB BIOS Flashback) 2 x USB 3.0/2.0 ports (blue) 6 audio jacks for 8-channel audio
Internal I/O connectors / buttons / switches	<ul style="list-style-type: none"> 3 x USB 2.0/1.1 connectors support additional 6 USB ports 1 x USB 3.0/2.0 connector supports additional 2 USB ports (19 pin) 6 x SATA 6.0Gb/s connectors 1 x S/PDIF Out header 1 x Front panel audio connector 1 x COM connector 1 x TPM header 1 x USB BIOS Flashback Button 1 x Clear CMOS jumper 1 x MemOK! button 1 x DirectKey button 1 x DRCT header 1 x System panel connector 1 x CPU fan connector (4-pin) 3 x Chassis fan connectors (3 x 4-pin) 1 x 24-pin EATX power connector 1 x 8-pin EATX 12V power connector
BIOS	64Mb Flash ROM, UEFI BIOS, PnP, DMI 2.0, WiF 2.0, SM BIOS V2.7, ACPI 2.0a Multi-language BIOS, ASUS EZ Flash 2, F12 PrintScreen, F3 Shortcut Function and ASUS DRAM SPD (Serial Presence Detect) memory information
Manageability	WiF 2.0, DMI 2.0, WOL by PME, WOR by PME, PXE
Accessories	<ul style="list-style-type: none"> 2 x Serial ATA 6.0Gb/s cables 1 x I/O Shield 1 x User Manual 1 x Support DVD
Support DVD	<ul style="list-style-type: none"> Drivers ASUS Update ASUS utilities Anti-Virus software (OEM version)
Form factor	ATX form factor: 12 in x 9 in (30.5 cm x 22.9 cm)



Specifications are subject to change without notice.

Package contents

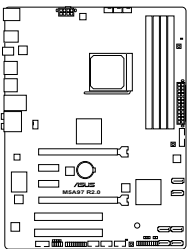

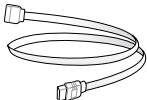
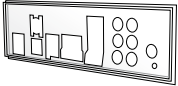
Check your motherboard package for the following items.

		
ASUS M5A97 R2.0 motherboard		User Guide
		
Support DVD	2 x Serial ATA 6.0 Gb/s cables	1 x ASUS I/O Shield

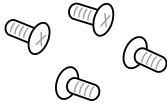

- If any of the above items is damaged or missing, contact your retailer.
- The illustrated items above are for reference only. Actual product specifications may vary with different models.

Installation tools and components

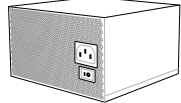
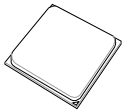
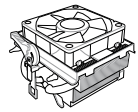
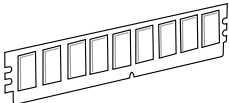
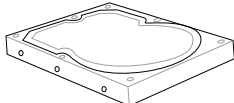
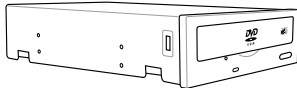
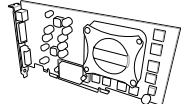
	
1 bag of screws	Phillips (cross) screwdriver
	
PC chassis	Power supply unit
	
AMD AM3+ CPU	AMD AM3+ compatible CPU Fan
	
DIMM	SATA hard disk drive
	
SATA optical disc drive (optional)	Graphics card (optional)



The tools and components in the table above are not included in the motherboard package.

Product introduction

1

1.1 Special features

1.1.1 Product highlights

AMD® FX™ / Phenom™ II / Athlon™ II / Sempron™ 100 series CPU support

This motherboard supports AMD® Socket AM3+ multi-core processors with unique L3 cache and delivers better overclocking capabilities with less power consumption. It features dual-channel DDR3 memory support and accelerates data transfer rate up to 4800MT/s via HyperTransport™ 3.0-based system bus. This motherboard also supports AMD® CPUs in the new 32nm manufacturing process.

AMD® 970 Chipset

AMD® 970 Chipset is designed to support up to 4800MT/s HyperTransport™ 3.0 (HT 3.0) interface speed and PCI Express™ 2.0 x16 graphics. It is optimized with AMD®'s latest AM3+ and multi-core CPUs to provide excellent system performance and overclocking capabilities.

DDR3 2133(O.C.)/1866/1600/1333/1066 support

This motherboard supports DDR3 memory that features data transfer rates of 2133(O.C.)/1866/1600/1333/1066 MHz to meet the higher bandwidth requirements of the latest 3D graphics, multimedia, and Internet applications. The dual-channel DDR3 architecture enlarges the bandwidth of your system memory to boost system performance.

AMD® SB950 Chipset

The AMD® SB950 Southbridge natively supports the next generation SATA 6.0 Gb/s data transfer rate and PCI Express 2.0 interface.

AMD Cool 'n' Quiet™ Technology

This motherboard supports the AMD Cool 'n' Quiet technology which monitors system operation and automatically adjusts CPU voltage and frequency for a cool and quiet operating environment.

Complete USB 3.0 integration

This motherboard offers you the strategic USB 3.0 accessibility for both the front and rear panels, allowing you to experience the convenience of the latest plug and play connectivity solution at speed up to ten times faster than USB 2.0.

Front Panel USB 3.0 Support

ASUS provides standardized USB 3.0 front panel support which is compatible with any chassis. Enjoy faster throughput of USB 3.0 without relegating cables or hard-to-reach rear I/O.

AMD® CrossFireX™ Technology

AMD's CrossFireX™ boosts image quality along with rendering speed, eliminating the need to scale down screen resolution to get high quality images. CrossFireX™ allows higher antialiasing, anisotropic filtering, shading, and texture settings. Adjust your display configurations, experiment with the advanced 3D settings, and check the effects with a real-time 3D-rendered previews within AMD Vision Engine Control Center.

1.1.2 DIP (Dual Intelligent Processors) - TPU (TurboV Processing Unit) & EPU (Energy Processing Unit)

TPU

Unleash your performance with AI Suite II utility. ASUS Auto tuning feature can intelligently optimize the system for fast, yet stable clock speeds, and the TurboV gives you the freedom to adjust CPU frequencies and ratios to optimize performance under varied system conditions.

EPU

The ASUS EPU (Energy Processing Unit) provides total system power management by detecting current PC loadings and intelligently moderating power usage for critical PC components in real-time—helping save power and money!

1.1.3 ASUS Exclusive Features

MemOK!

MemOK!, the remarkable memory rescue tool, allows you to simply press a button to patch memory issues, ensure memory boot compatibility, determine fail-safe settings, and dramatically improve the system's bootup.

AI Suite II

With its user interface, ASUS AI Suite II integrates several ASUS utilities and allows you to launch and operate these utilities simultaneously. It allows you to configure the overclocking settings, adjust the frequencies and related voltages, remotely control the system via a mobile device, and other easy-to-use helpful utilities.

USB 3.0 Boost

ASUS USB 3.0 Boost technology supports UASP (USB Attached SCSI Protocol), the latest USB 3.0 standard. With USB 3.0 Boost technology, a USB device's transmission speed is significantly increased up to 170%, adding to an already impressive fast USB 3.0 transfer speed. ASUS software automatically accelerates data speeds for compatible USB 3.0 peripherals without the need for any user interaction.

Network iControl

Network iControl is an intuitive one-step network control center that makes it easier for you to manage your bandwidth and allows you to set, monitor, and schedule the bandwidth priorities for your network programs. It allows you to automatically connect to a PPPoE network for a more convenient online experience.

Ai Charger+

ASUS Ai Charger+, the latest Ai Charger* version, brings you to a new level of USB3.0 fast charging experience. With its easy and user-friendly interface, you can easily charge iPod, iPhone, iPad, but also BC 1.1** standard mobile devices three times*** as fast as before.



-
- * Ai Charger is ASUS unique fast-charging software that supports iPod, iPhone and iPad.
 - ** Check your USB mobile device manufacturer if it fully supports the BC 1.1 function.
 - *** The actual charging speed may vary with your USB device's conditions.
-

1.1.4 ASUS Quiet Thermal Solution

Fanless Design: heatsink solution

The heatsink features a 0-dB thermal solution that offers you a noiseless PC environment. The heatsink design also lowers the temperature of the chipset and power phase area through high efficient heat-exchange. Combined with usability and aesthetics, the ASUS stylish heatsink will give you an extremely silent and cooling experience with the elegant appearance!

ASUS Fan Xpert

ASUS Fan Xpert intelligently allows you to adjust the CPU fan and chassis fan speeds according to different ambient temperatures caused by different climate conditions in different geographic regions and your PC's loading. The built-in variety of useful profiles offer flexible controls of fan speed to achieve a quiet and cool environment.

1.1.5 ASUS EZ DIY

ASUS UEFI BIOS (EZ Mode)

ASUS UEFI BIOS, a UEFI compliant architecture, offers the first mouse-controlled intuitive graphical BIOS interface that goes beyond the traditional keyboard-only BIOS controls, providing you with more flexibility, convenience, and easy to navigate EFI BIOS than the traditional BIOS versions. It offers you with dual selectable modes and native support for hard drives larger than 2.2 TB.

ASUS UEFI BIOS includes the following new features:

- F12 BIOS snapshot hotkey
- F3 Shortcut for most accessed information
- ASUS DRAM SPD (Serial Presence Detect) information detecting faulty DIMMs, and helping with difficult POST situations.

ASUS DirectKey

This feature allows your system to go to the BIOS Setup program with the press of a button. With DirectKey, you can enter the BIOS anytime without having to press the key during POST. It also allows you to turn on and turn off your system and conveniently enter the BIOS during bootup.

USB BIOS Flashback

USB BIOS Flashback offers a hassle-free updating solution for your ultimate convenience. Install a USB storage device containing the BIOS file, press the BIOS Flashback button for about three seconds, and the UEFI BIOS is automatically updated even without entering the existing BIOS or operating system. It also allows you to regularly check for UEFI BIOS updates, and download the latest BIOS automatically.

ASUS Q-Design

ASUS Q-Design enhances your DIY experience. The Q-Slot design speeds up and simplify the DIY process.

ASUS EZ Flash 2

ASUS EZ Flash 2 is a user-friendly utility that allows you to update the BIOS without using a bootable floppy disk or an OS-based utility.

ASUS MyLogo 2™

Turn your favorite photos into 256-color boot logos to personalize your system.

ASUS O.C. Profile

The motherboard features the ASUS O.C. Profile that allows you to conveniently store or load multiple BIOS settings. The BIOS settings can be stored in the CMOS or a separate file, giving you the freedom to share and distribute your favorite settings.

Precision Tweaker 2

Allows you to fine-tune the VCore / VDDNB voltage in 0.00625V steps and DRAM voltage in 0.00625V steps to achieve the most precise setting for the ultimate overclocking configuration.

1.1.6 Other Features

ErP ready

The motherboard is European Union's Energy-related Products (ErP) ready, and ErP requires products to meet certain energy efficiency requirements in regards to energy consumptions. This is in line with ASUS vision of creating environment-friendly and energy-efficient products through product design and innovation to reduce carbon footprint of the product and thus mitigate environmental impacts.

1.2 Motherboard overview

1.2.1 Before you proceed

Take note of the following precautions before you install motherboard components or change any motherboard settings.



-
- Unplug the power cord from the wall socket before touching any component.
 - Before handling components, use a grounded wrist strap or touch a safely grounded object or a metal object, such as the power supply case, to avoid damaging them due to static electricity.
 - Hold components by the edges to avoid touching the ICs on them.
 - Whenever you uninstall any component, place it on a grounded antistatic pad or in the bag that came with the component.
 - Before you install or remove any component, switch off the ATX power supply and detach its power cord. Failure to do so may cause severe damage to the motherboard, peripherals, or components.
-

1.2.2 Motherboard layout

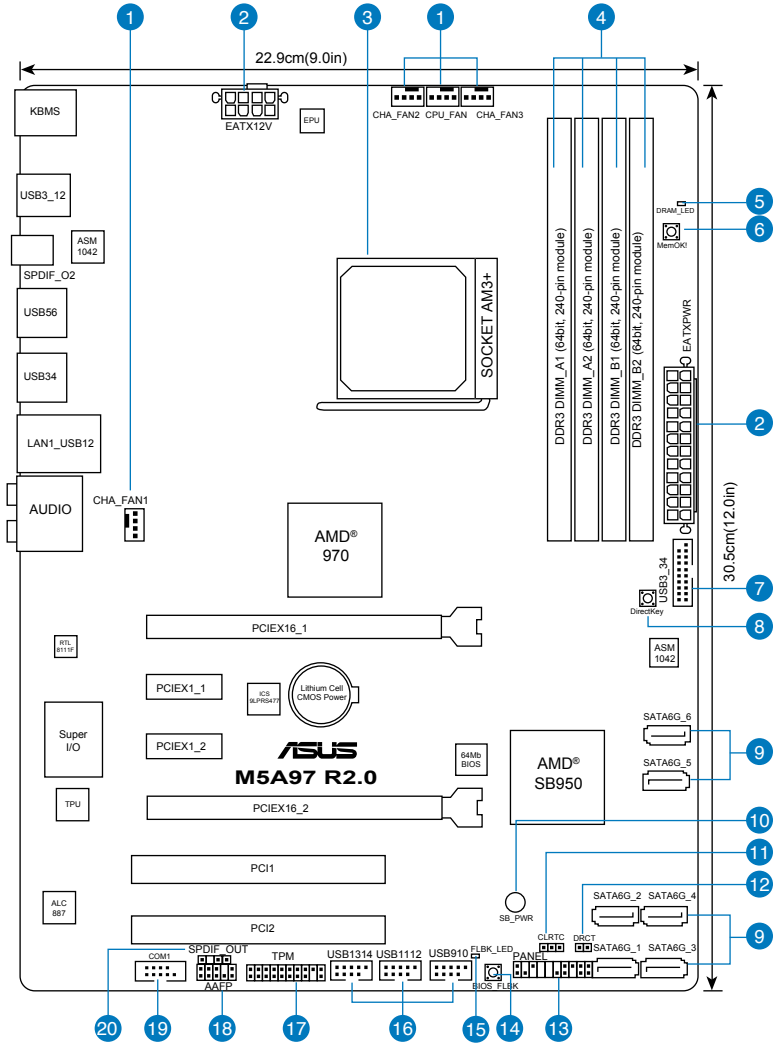

Refer to [1.2.9 Internal connectors](#) and [2.3.1 Rear I/O connection](#) for more information about rear panel connectors and internal connectors.

Layout contents

Connectors/Jumpers/Slots/LED	Page
1. CPU and chassis fan connectors (4-pin CPU_FAN and 4-pin CHA_FAN1/2/3)	1-21
2. ATX power connectors (24-pin EATXPWR, 8-pin EATX12V)	1-22
3. AMD AM3+ CPU socket	1-8
4. DDR3 DIMM slots	1-8
5. DRAM LED (DRAM_LED)	1-20
6. MemOK! switch	1-17
7. USB 3.0 connector (20-1 pin USB3_34)	1-26
8. DirectKey button	1-16
9. SATA 6.0Gb/s connectors (7-pin SATA6G_1~6)	1-23
10. Standby power LED (SB_PWR)	1-20
11. Clear RTC RAM (3-pin CLRTC)	1-19
12. DRCT header (2-pin DRCT)	1-27
13. System panel connector (20-8 pin PANEL)	1-25
14. BIOS Flashback button	1-18
15. BIOS Flashback LED (FLBK_LED)	1-20
16. USB 2.0 connectors (10-1 pin USB910, USB1112, USB1314)	1-27
17. TPM header (20-1 pin TPM)	1-21
18. Front panel audio connector (10-1 pin AAFP)	1-26
19. Serial port connector (10-1 pin COM1)	1-24
20. Digital audio connector (4-1 pin SPDIF_OUT)	1-24

1.2.3 Central Processing Unit (CPU)

The motherboard comes with an AM3+/AM3 socket designed for AMD® FX™ Series / Phenom™ II / Athlon™ II / Sempron™ 100 Series Processors.

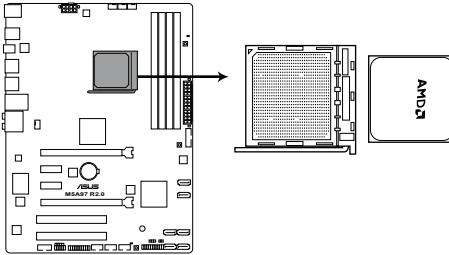

M5A97 R2.0 CPU socket AM3+



Ensure that all power cables are unplugged before installing the CPU.



The AM3+ socket has a different pinout from the 940-pin socket designed for the AMD Opteron processor. Ensure that you use a CPU designed for the AM3+ socket. The CPU fits in only one correct orientation. **DO NOT** force the CPU into the socket to prevent bending the connectors on the socket and damaging the CPU!

1.2.4 System memory

This motherboard comes with four Double Data Rate 3 (DDR3) Dual Inline Memory Modules (DIMM) sockets. A DDR3 module has the same physical dimensions as a DDR2 DIMM but is notched differently to prevent installation on a DDR2 DIMM socket. DDR3 modules are developed for better performance with less power consumption. The figure illustrates the location of the DDR3 DIMM sockets:

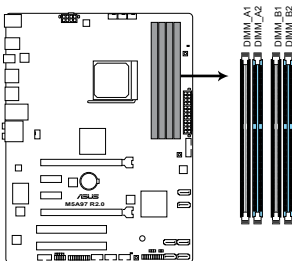

M5A97 R2.0 240-pin DDR3 DIMM sockets

Recommended memory configurations

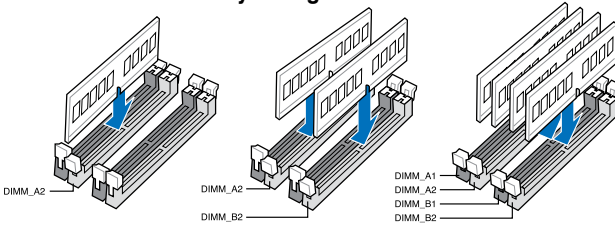

Memory configurations

You may install 1GB, 2GB, 4GB, and 8GB unbuffered ECC, non-ECC DDR3 DIMMs into the DIMM sockets.



- Memory module with memory frequency higher than 2133 MHz and its corresponding timing or the loaded DRAM OC Profile is not the JEDEC memory standard. The stability and compatibility of these memory modules depend on the CPU's capabilities and other installed devices.
- You may install varying memory sizes in Channel A and Channel B. The system maps the total size of the lower-sized channel for the dual-channel configuration. Any excess memory from the higher-sized channel is then mapped for single-channel operation.
- We recommend that you install the memory modules from the blue slots for better overclocking capability.
- Always install DIMMs with the same CAS latency. For optimal compatibility, we recommend that you install memory modules of the same version or date code (D/C) from the same vendor. Check with the retailer to get the correct memory modules.
- Due to the memory address limitation on 32-bit Windows® OS, when you install 4GB or more memory on the motherboard, the actual usable memory for the OS can be about 3GB or less. For effective use of memory, we recommend that you do any of the following:
 - Install a maximum of 3GB system memory if you are using a 32-bit Windows® OS.
 - Use a 64-bit Windows® OS if you want to install 4GB or more memory on the motherboard.
- This motherboard does not support DIMMs made up of 512Mb (64MB) chips or less (Memory chip capacity counts in Megabit, 8 Megabit/Mb = 1 Megabyte/MB).
- The maximum 64GB memory capacity can be supported with 8GB or above DIMMs. ASUS will update the memory QVL once the DIMMs are available in the market.



- The default memory operation frequency is dependent on its Serial Presence Detect (SPD), which is the standard way of accessing information from a memory module. Under the default state, some memory modules for overclocking may operate at a lower frequency than the vendor-marked value. To operate at the vendor-marked or at a higher frequency, refer to section 3.4 **Ai Tweaker menu** for manual memory frequency adjustment.
- For system stability, use a more efficient memory cooling system to support a full memory load (4 DIMMs) or overclocking condition.
- Visit the ASUS website at www.asus.com for the latest QVL.

M5A97 R2.0 Motherboard Qualified Vendors Lists (QVL)

DDR3-2133 (O.C.) MHz capability

Vendors	Part No.	Size	SS/DS	Chip Brand	Chip NO.	Timing	Voltage	DIMM socket support (Optional)	
								1 DIMM	2 DIMMs
CORSAIR	CMT4GX3M2A2133C9(XMP)	4GB (2x 2GB)	DS	-	-	9-10-9-24	1.65	*	*
CORSAIR	CMT4GX3M2B2133C9(Ver7.1)(XMP)	4GB (2x 2GB)	DS	-	-	9-9-9-24	1.5	*	*
CORSAIR	CMT4GX3M2B2133C9(XMP)	4GB (2x 2GB)	DS	-	-	9-10-9-27	1.5	*	*
G.SKILL	F3-17066CL9D-8GBPID(XMP)	8GB (2x 4GB)	DS	-	-	9-9-9-24	1.65	*	*

DDR3-2000 (O.C.) MHz capability

Vendors	Part No.	Size	SS/DS	Chip Brand	Chip NO.	Timing	Voltage	DIMM socket support (Optional)	
								2 DIMMs	4 DIMMs
A-DATA	AX3U2000GB2G9B(XMP)	2GB	DS	-	-	9-11-9-27	1.55-1.75	*	*
A-DATA	AX3U2000GC4G9B(XMP)	4GB	DS	-	-	9-11-9-27	1.55-1.75	*	*
AEXEA	AXA3ES2G2000L28V(XMP)	2GB	DS	-	-	-	1.65	*	*
AEXEA	AXA3ES4GK2000L28V(XMP)	4GB(2x 2GB)	DS	-	-	-	1.65	*	*
Apacer	78.AAGD5.9KDI(XMP)	6GB(3 x 2GB)	DS	-	-	9-9-9-27	-	*	*
Asint	SLA302G08-ML2HB(XMP)	4GB	DS	Hynix	H5TQ2G83BFRH9C	9-9-9-27	-	*	*
CORSAIR	CMT6GX3M3A2000C8(XMP)	6GB(3x 2GB)	DS	-	-	8-9-8-24	1.65	*	*
CORSAIR	CM24GX3M2A2000C10(Ver 5.12)(XMP)	4GB(2x 2GB)	SS	-	-	10-10-10-27	1.5	*	*
G.SKILL	F3-16000CL9D-4GBTD(XMP)	4GB(2 x 2GB)	DS	-	-	9-9-9-24	1.65	*	*
GEIL	GUP34GB2000C9DC(XMP)	4GB(2x 2GB)	DS	-	-	9-9-9-28	1.65	*	*
Patriot	PV736G2000ELK(XMP)	6GB(3x 2GB)	DS	-	-	7-7-7-20	1.65	*	*
Silicon Power	SP002GBLYU2000S02(XMP)	2GB	DS	-	-	-	-	*	*
Team	TXD32048M2000C9(XMP)	2GB	DS	Team	T3D1288RT-20	9-9-9-24	1.5	*	*
Team	TXD32048M2000C9-L(XMP)	2GB	DS	Team	T3D1288LT-20	9-9-9-24	1.5	*	*
Transcend	TX2000KLN-8GK (388375)(XMP)	4GB	DS	-	-	-	1.6	*	*

DDR3-1866 MHz capability

Vendors	Part No.	Size	SS/DS	Chip Brand	Chip NO.	Timing	Voltage	DIMM socket support (Optional)	
								2 DIMMs	4 DIMMs
A-DATA	AX3U1866GC4G9B(XMP)	4GB	DS	-	-	9-11-9-27	1.55-1.75	*	*
CORSAIR	CMD16GX3M4A1866C9 (Ver4.13)(XMP)	16GB(4x 4GB)	DS	-	-	9-10-9-27	1.5	*	*
CORSAIR	CMD8GX3M2A1866C9 (Ver4.13)(XMP)	8GB(2x 4GB)	DS	-	-	-	1.5	*	*
CORSAIR	CMT32GX3M4X1866C9(Ver 3.23)(XMP)	32GB(4x 8GB)	DS	-	-	9-10-9-27	1.5	*	*
CORSAIR	CMZ16GX3M4X1866C9R(Ver 8.16)(XMP)	16GB(4x 4GB)	DS	-	-	9-10-9-27	1.5	*	*
CORSAIR	CMZ32GX3M4X1866C10(V er3.23)(XMP)	32GB(4x 8GB)	DS	-	-	10-11-10-27	1.5	*	*
CORSAIR	CMZ8GX3M2A1866C9(XMP)	8GB(2x 4GB)	DS	-	-	9-10-9-27	1.5	*	*
Crucial	BLE4G3D1869DE1XT0.16 FMD(XMP)	4GB	DS	-	-	9-9-9-27	1.5	*	*
G.SKILL	F3-14900CL10Q2-64GBZLD(XMP)	64GB(8x 8GB)	DS	-	-	10-11-10-30	1.5	*	*
G.SKILL	F3-14900CL9D-8GBSR(XMP)	8GB(2x 4GB)	DS	-	-	9-10-9-28	1.5	*	*
G.SKILL	F3-14900CL9Q-16GBXL(XMP)	16GB(4x 4GB)	DS	-	-	9-10-9-28	1.5	*	*
G.SKILL	F3-14900CL9Q-16GBZL(XMP)	16GB(4x 4GB)	DS	-	-	9-10-9-28	1.5	*	*
G.SKILL	F3-14900CL9Q-8GBFLD(XMP)	8GB(2x 4GB)	DS	-	-	9-9-9-24	1.6	*	*
Kingston	KHX1866C9D3K2/8GX(XMP)	8GB(2x 4GB)	DS	-	-	-	1.65	*	*
Patriot	PXD34G1866ELK(XMP)	4GB(2x 2GB)	SS	-	-	9-9-9-24	1.65	*	*
Patriot	PXD38G1866ELK(XMP)	8GB(2x 4GB)	DS	-	-	9-11-9-27	1.65	*	*
Patriot	PXD38G1866ELK(XMP)	8GB(2x 4GB)	DS	-	-	9-11-9-27	1.65	*	*
Team	TXD34096M1866HC9K-L(XMP)	4GB	DS	Hynix	H5TC2G83BFRH9A	9-11-9-27	1.65	*	*

DDR3-1800 MHz capability

Vendors	Part No.	Size	SS/DS	Chip Brand	Chip NO.	Timing	Voltage	DIMM socket support (Optional)		
								1 DIMM	2 DIMMs	4 DIMMs
G.SKILL	F3-14400CL9D-4GBI(XMP)	4GB (2x 2GB)	DS	-	-	9-9-9-24	1.6	*	*	*

DDR3-1600 MHz capability

Vendors	Part No.	Size	SS/ DS	Chip Brand	Chip NO.	Timing	Voltage	DIMM socket support (Optional)			
								1 DIMM	2 DIMMs	4 DIMMs	
A-DATA	AM2U16BC2P1	2GB	SS	A-DATA	3CCD-1509A	-	-	*	*	*	
A-DATA	AM2U16BC4P2	4GB	DS	A-DATA	3CCD-1509A	-	-	*	*	*	
A-DATA	AX3U1600GC4G9(XMP)	4GB	DS	-	-	-	1.55-1.75	*	*	*	
A-DATA	AX3U1600PC4G8(XMP)	4GB	DS	-	-	8-8-8-24	1.55-1.75	*	*	*	
AMD	AP38G1608U2K(XMP)	8GB(2x 4GB)	DS	-	-	-	9-9-9-28	1.65	*	*	
Asint	SLA302G08-EGG1C(XMP)	4GB	DS	Asint	302G08-GG1C	9-9-9-27	-	*	*	*	
Asint	SLA302G08-EGJ1C(XMP)	4GB	DS	Asint	302G08-GJ1C	9-9-9-27	-	*	*	*	
Asint	SLZ3128M8-EGJ1D(XMP)	2GB	DS	Asint	3128M8-GJ1D	-	-	*	*	*	
ATP	AQ12M64B8BK0S	4GB	DS	SAMSUNG	K4B2G08460	-	NO	*	*	*	
CORSAIR	CMG4GX3M2A1600C6	4GB(2x 2GB)	DS	-	-	6-6-6-18	1.65	*	*	*	
CORSAIR	CML16GX3M4X1600C8(Ver 2.12)(XMP)	16GB(4x 4GB)	DS	-	-	-	-	Heat-Sink Package	1.5	*	*
CORSAIR	CMP6GX3M3A1600C8(XMP)	6GB(3x 2GB)	DS	-	-	8-8-8-24	1.65	*	*	*	
CORSAIR	CMP6GX3M3A1600C8(XMP)	6GB(3x 2GB)	DS	-	-	8-8-8-24	1.65	*	*	*	
CORSAIR	CMX6GX3M3C1600C7(XMP)	6GB(3x 2GB)	DS	-	-	7-8-7-20	1.65	*	*	*	
CORSAIR	CMZ16GX3M4A1600C9(XMP)	16GB(4x 4GB)	DS	-	-	9-9-9-24	1.5	*	*	*	
CORSAIR	CMZ32GX3M4X1600C10(Ver2.2)(XMP)	32GB(4x 8GB)	DS	-	-	10-10-10-27	1.5	*	*	*	
CORSAIR	CMZ8GX3M2A1600C8(XMP)	8GB(2x 4GB)	DS	-	-	8-8-8-24	1.5	*	*	*	
CORSAIR	CMZ8GX3M2A1600C9(XMP)	8GB(2x 4GB)	DS	-	-	9-9-9-24	1.5	*	*	*	
CORSAIR	CMZ8GX3M4X1600C9(Ver 2.12)(XMP)	8GB(4x 2GB)	SS	-	-	9-9-9-24	1.5	*	*	*	
CORSAIR	HX3X12G1600C9(XMP)	12GB(6x 2GB)	DS	-	-	9-9-9-24	1.6	*	*	*	
Crucial	BL12864N1608.8FF(XMP)	2GB(2x 1GB)	SS	-	-	8-8-8-24	1.65	*	*	*	
Crucial	BLT4G3D1608DT11TX0.16FM(XMP)	4GB	DS	-	-	8-8-8-24	1.5	*	*	*	
EK Memory	EKM324L28BP8-116(XMP)	4GB(2x 2GB)	DS	-	-	9	-	*	*	*	
EK Memory	EKM324L28BP8-116(XMP)	4GB(2 x 2GB)	DS	-	-	9	-	*	*	*	
Elixir	M2X2G64C8B8G7N-DG(XMP)	2GB	SS	Elixir	N2CB2G80GN-DG	9-9-9-28	-	*	*	*	
Elixir	M2X4G64C8B8G5N-DG(XMP)	4GB	DS	Elixir	N2CB2G80GN-DG	9-9-9-28	-	*	*	*	
G.SKILL	F3-12800CL7D-8GBRH(XMP)	8GB (2x 4GB)	DS	-	-	7-8-7-24	1.6	*	*	*	
G.SKILL	F3-12800CL8D-8GBECO(XMP)	8GB(2x4GB)	DS	-	-	8-8-8-24	1.35	*	*	*	
G.SKILL	F3-12800CL9D-8GBRLL(XMP)	8GB(2x 4GB)	DS	-	-	9-9-9-24	1.5	*	*	*	
G.SKILL	F3-12800CL9D-8GBSR2(XMP)	8GB(2x 4GB)	DS	-	-	9-9-9-24	1.25	*	*	*	
G.SKILL	F3-12800CL9Q-16GBXL(XMP)	16GB(4x 4GB)	DS	-	-	9-9-9-24	1.5	*	*	*	
G.Skill	F3-12800CL9Q-16GBZL(XMP)	16GB(4x 4GB)	DS	-	-	9-9-9-24	1.5	*	*	*	
GEIL	GET316GB1600C9QC(XMP)	16GB(4x 4GB)	DS	-	-	9-9-9-28	1.6	*	*	*	
GEIL	GUP34GB1600C7DC(XMP)	4GB(2x 2GB)	DS	-	-	7-7-7-24	1.6	*	*	*	
KINGMAX	FLGE85F-C8KL9A(XMP)	2GB	SS	KINGMAX	N/A	9-9-9-28	-	*	*	*	
KINGMAX	FLGF65F-C8KL9A(XMP)	4GB	DS	KINGMAX	N/A	9-9-9-28	-	*	*	*	
KINGSTON	KHX1600C9D3K3/12GX(XMP)	12GB(3x 4GB)	DS	-	-	-	1.65	*	*	*	
Kingston	KHX1600C9D3K4/16GX(XMP)	16GB(4x 4GB)	DS	-	-	9-9-9-24	1.65	*	*	*	
KINGTIGER	KTG2G1600PG3(XMP)	2GB	DS	-	-	-	-	*	*	*	
Kingkin	996805(XMP)	4GB(2x 2GB)	DS	-	-	6-8-6-24	1.65	*	*	*	
Mushkin	OCZ3BE1600C8L4VGK	4GB(2x 2GB)	DS	-	-	8-8-8	1.65	*	*	*	
Patriot	AE32G1609U1-U	2GB	SS	AMD	23EY4587MB6H	-	1.5	*	*	*	
Patriot	PGD38G1600ELK(XMP)	8GB(2x 4GB)	DS	-	-	9-9-9-24	1.65	*	*	*	
SanMax	SMD-4G68HP-16KZ	4GB	DS	Hynix	H5TQ2G83BFRPBC	-	1.5	*	*	*	
SanMax	SMD-4G68NG-16KK	4GB	DS	ELPIDA	J2108BD BG-GN-F	-	-	*	*	*	
Silicon Power	SP002GBLTU160V02(XMP)	2GB	SS	S-POWER	20YT5NG	9-11-11-28	1.5	*	*	*	
Silicon Power	SP004GBLTU160V02(XMP)	4GB	DS	S-POWER	20YT5NG	9-9-9-24	1.5	*	*	*	
Team	TXD34096M1600HC9-D(XMP)	4GB	DS	Hynix	H5TC2G83BFRH9A	9-9-9-24	1.5	*	*	*	
Transcend	TS512MLK64V6N	4GB	DS	MICRON	D9PFJ	-	-	*	*	*	

DDR3-1333 MHz capability

Vendors	Part No.	Size	SS/DS	Chip Brand	Chip NO.	Timing	Voltage	DIMM socket support (Optional)		
								1 DIMM	2 DIMMs	4 DIMMs
ACTICA	ACT1GHU64B8F1333S	1GB	SS	SAMSUNG	K4B1G0846F	-	-	*	*	*
ACTICA	ACT1GHU72C8G1333S	1GB	SS	SAMSUNG	K4B1G0846F(ECC)	-	-	*	*	*
ACTICA	ACT2GHU64B8G1333M	2GB	DS	Micron	D9KPT	-	-	*	*	*
ACTICA	ACT2GHU64B8G1333S	2GB	DS	SAMSUNG	K4B1G0846F	-	-	*	*	*
ACTICA	ACT2GHU72D8G1333M	2GB	DS	Micron	D9KPT(ECC)	-	-	*	*	*
ACTICA	ACT2GHU72D8G1333S	2GB	DS	SAMSUNG	K4B1G0846F(ECC)	-	-	*	*	*
ACTICA	ACT4GHU64B8H1333H	4GB	DS	Hynix	H5TQ2G83AFR	-	-	*	*	*
ACTICA	ACT4GHU72D8H1333H	4GB	DS	Hynix	H5TQ2G83AFR(ECC)	-	-	*	*	*
A-DATA	AD6311C1624EV	4GB	DS	A-DATA	3CCA-1509A	-	-	*	*	*
A-DATA	AXDU1333GC2G9(XMP)	2GB	SS	-	-	9-9-9-24	1.25~1.35	*	*	*
A-DATA	SU9U1333W8G9(XMP)	8GB	DS	ELPIDA	J4208BASE-DJ-F	-	-	*	*	*
Apacer	78.A1GC6.9L1	2GB	DS	Apacer	AM5D5808FEQSBG	9	-	*	*	*
Apacer	78.B1GDE.9L10C	4GB	DS	Apacer	AM5D5908CEHSBG	9	-	*	*	*
Asint	SLA302G08-EDJ1C	2GB	SS	ASint	302G08-DJ1C	-	-	*	*	*
ATP	AQ12M72E8BKH9S	4GB	DS	SAMSUNG	K4B2G0846C(ECC)	-	-	*	*	*
BUFFALO	D3U1333-1G	1GB	SS	Elpida	J1108BFBG-DJ-F	-	-	*	*	*
BUFFALO	D3U1333-2G	2GB	DS	Elpida	J1108BFBG-DJ-F	-	-	*	*	*
BUFFALO	D3U1333-4G	4GB	DS	NANYA	NT5CB256M8BN-CG	-	-	*	*	*
CORSAIR	CMX8GX3M2A1333C9(XMP)	8GB(2x 4GB)	DS	-	-	9-9-9-24	1.5	*	*	*
CORSAIR	TW3X4G1333C9A	4GB(2x 2GB)	DS	-	-	9-9-9-24	1.5	*	*	*
EK Memory	EKM324L28BP8-113	4GB(2 x 2GB)	DS	-	-	9	-	*	*	*
Elixir	M2F2G64C888D7N-CG	2GB	SS	Elixir	M2CB2G80DN-CG	-	-	*	*	*
G.SKILL	F3-10600CL9D-4GBNT	4GB(2x 2GB)	DS	G.SKILL	D3 128M8CE9 2GB	9-9-9-24	1.5	*	*	*
G.SKILL	F3-10666CL9D-8GBRL	8GB(2x 4GB)	DS	-	-	9-9-9-24	1.5	*	*	*
G.SKILL	F3-10666CL9D-8GBXL	8GB(2x 4GB)	DS	-	-	9-9-9-24	1.5	*	*	*
GEIL	GB34GB1333C7DC	4GB(2 x 2GB)	DS	GEIL	GL1L128M88BA15FW	7-7-7-24	1.5	*	*	*
GEIL	GG34GB1333C9DC	4GB(2x 2GB)	DS	GEIL	GL1L128M88BA115FW	9-9-9-24	1.3	*	*	*
GEIL	GVP34GB1333C9DC	4GB(2x 2GB)	DS	-	-	9-9-9-24	1.5	*	*	*
GEIL	GVP38GB1333C7QC	8GB(4x 2GB)	DS	-	-	7-7-7-24	1.5	*	*	*
GEIL	GVP38GB1333C9DC	8GB(2x 4GB)	DS	-	-	9-9-9-24	1.5	*	*	*
GoodRam	GR1333D364L9/2G	2GB	DS	Qimonda	IDSH1G-03A1F1C-13H	-	-	*	*	*
Hynix	HMT125U6TFR8A-H9	2GB	DS	Hynix	H5TC1G83TFR	-	-	*	*	*
INNOVATION	M3UN-2GHJBC09	2GB	SS	Hynix	H5TQ2G83CFRH9C	9-9-9-24	-	*	*	*
INNOVATION	M3UN-4GHJAC09	4GB	DS	Hynix	H5TQ2G83CFRH9C	9-9-9-24	-	*	*	*
KINGMAX	FLFE85F-C8KL9	2GB	SS	KINGMAX	KFC8FNLF-BXX-12A	-	-	*	*	*
KINGMAX	FLFE85F-C8KL9	2GB	SS	KINGMAX	KFC8FNLF-DXX-15A	-	-	*	*	*
KINGMAX	FLFE85F-C8KM9	2GB	SS	Kingmax	KFC8FNLMF-BXX-15A	-	-	*	*	*
KINGMAX	FLFF65F-C8KL9	4GB	DS	KINGMAX	KFC8FNLF-BXX-12A	-	-	*	*	*
KINGMAX	FLFF65F-C8KL9	4GB	DS	KINGMAX	KFC8FNLF-DXX-15A	-	-	*	*	*
KINGSTON	KVR1333D3E9S/4G	4GB	DS	Elpida	J2108ECSE-DJ-F	9	1.5	*	*	*
KINGSTON	KVR1333D3N9/2G	2GB	DS	Kingston	D128BJPNDPLD9U	9	1.5	*	*	*
KINGSTON	KVR1333D3N9H/8G	8GB	DS	ELPIDA	J4208EASE-DJ-F	9-9-9-24	1.5	*	*	*
KINGSTON	KVR1333D3N9K2/4G	4GB(2x 2GB)	DS	KINGSTON	D128BJEMPPGD9U	-	1.5	*	*	*
KINGSTON	KVR1333D3S8N9/2G	2GB	SS	Micron	IFD77 D9L6K	-	1.5	*	*	*
KINGTIGER	F10DA2T1680	2GB	DS	KINGTIGER	KTG1333PS1208NST-C9	-	-	*	*	*
KINGTIGER	KTG2G1333PG3	2GB	DS	-	-	-	-	*	*	*
Mach Xtreme	MXD3U133316GQ	16GB(4x 4GB)	DS	-	-	-	-	*	*	*
Mach Xtreme	MXD3U13332GS	2GB	SS	Mach Xtreme	C2S46D30-D313	-	-	*	*	*
MICRON	MT8JTF25664AZ-1G4M1	2GB	SS	MICRON	D9PFJ	-	-	*	*	*
OCZ	OCZ3G1333LV4GK	4GB(2x 2GB)	DS	-	-	9-9-9	1.65	*	*	*
OCZ	OCZ3G1333LV8GK	8GB(2x 4GB)	DS	-	-	9-9-9	1.65	*	*	*
OCZ	OCZ3G1333LV8GK	8GB(2x 4GB)	DS	-	-	9-9-9	1.65	*	*	*
Patriot	AE32G1339U1-U	2GB	SS	AMD	23EY4587MB3H	-	1.5	*	*	*
Patriot	AE34G1339U2-U	4GB	DS	AMD	23EY4587MB3H	-	1.5	*	*	*

(continued on the next page)

DDR3-1333 MHz capability

Vendors	Part No.	Size	SS/ DS	Chip Brand	Chip NO.	Timing	Voltage	DIMM socket support (optional)		
								1 DIMM	2 DIMMs	4 DIMMs
Patriot	PG38G1333EL(XMP)	8GB	DS	-	-	-	1.5	*	*	*
Patriot	PGD316G1333ELK(XMP)	16GB(2x 8GB)	DS	-	-	9-9-9-24	1.5	*	*	*
Patriot	PGS34G1333LLKA	4GB(2 x 2GB)	DS	-	-	7-7-7-20	1.7	*	*	*
Patriot	PSD32G13332	2GB	DS	Patriot	PM128M8D3BU-15	9	-	*	*	*
RIDATA	C304627CB1AG22Fe	2GB	DS	RIDATA	C304627CB1AG22Fe	9	-	*	*	*
RIDATA	E304459CB1AG32Cf	4GB	DS	RIDATA	E304459CB1AG32Cf	9	-	*	*	*
SAMSUNG	M378B1G73AH0-CH9	8GB	DS	SAMSUNG	K4B4G0846A-HCH9	-	-	*	*	*
SAMSUNG	M378B5273CH0-CH9	4GB	DS	SAMSUNG	K4B2G0846C	K4B2G0846C	-	*	*	*
SAMSUNG	M378B5673FH0-CH9	2GB	DS	SAMSUNG	K4B1G0846F	-	-	*	*	*
Silicon Power	SP001GBLTU133S01	1GB	SS	NANYA	NT5CB128M8AN-CG	-	-	*	*	*
Silicon Power	SP001GBLTU133S02	1GB	SS	S-POWER	10YT3E5	9	-	*	*	*
Silicon Power	SP002GBLTU133S01	2GB	DS	NANYA	NT5CB128M8AN-CG	-	-	*	*	*
Team	TE34096M1333HC9	4GB	DS	Team	T3D256BLT-13	-	-	*	*	*
Team	TXD31024M1333C7(XMP)	1GB	SS	Team	T3D128BLT-13	7-7-7-21	1.75	*	*	*
Team	TXD31048M1333C7-D(XMP)	1GB	SS	Team	T3D128BLT-13	7-7-7-21	1.75	*	*	*
Team	TXD32048M1333C7-D(XMP)	2GB	DS	Team	T3D128BLT-13	7-7-7-21	1.5-1.6	*	*	*
Transcend	JM1333KLN-2G	2GB	SS	Transcend	TK483PCW3	-	-	*	*	*
Transcend	JM1333KLN-2G (582670)	2GB	SS	Micron	ICD77 C9LGK	-	-	*	*	*
Transcend	JM1333KLN-4G	4GB	DS	Transcend	TK483PCW3	-	-	*	*	*
Transcend	JM1333KLN-4G (583782)	4GB	DS	Transcend	TK483PCW3	9	-	*	*	*
Transcend	TS1GLK64V3H	8GB	DS	MICRON	D9PBC	-	-	*	*	*
Transcend	TS256MLK64V3N (585541)	2GB	SS	Micron	ICD77 D9LGK	9	-	*	*	*
Transcend	TS256MLK64V3N (566577)	2GB	SS	Hynix	H5TQ2G83BFR	9	-	*	*	*
Transcend	TS256MLK64V3N (574206)	2GB	SS	Micron	D9LGK	9	-	*	*	*
Transcend	TS256MLK64V3NL	2GB	SS	Hynix	H5TQ2G83CFRH9C	-	-	*	*	*
Transcend	TS512MLK64V3N (585538)	4GB	DS	Micron	IED27 D9LGK	9	-	*	*	*
Transcend	TS512MLK64V3N (574831)	4GB	DS	Micron	D9LGK	9	-	*	*	*
Transcend	TS512MLK64V3NL	4GB	DS	Hynix	H5TQ2G83CFRH9C	-	-	*	*	*



Side(s): SS - Single-sided DS - Double-sided
DIMM support:

- **1 DIMM:** Supports one (1) module inserted into any slot as Single-channel memory configuration. **We suggest that you install the module into A2 slot.**
- **2 DIMMs:** Supports two (2) modules inserted into either the blue slots or the black slots as one pair of Dual-channel memory configuration. **We suggest that you install the modules into slots A2 and B2 for better compatibility.**
- **4 DIMMs:** Supports four (4) modules inserted into both the blue and black slots as two pairs of Dual-channel memory configuration.



- When overclocking, some AMD CPU models may not support DDR3 1600 or higher frequency DIMMs.
- Visit the ASUS website for the latest QVL.

1.2.5 Expansion slots



Unplug the power cord before adding or removing expansion cards. Failure to do so may cause you physical injury and damage motherboard components.

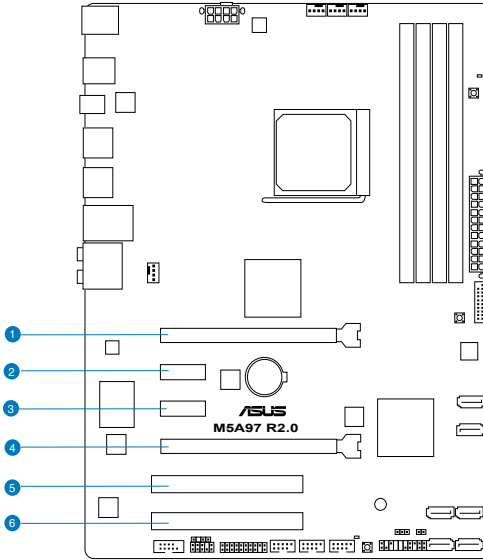

Slot No.	Slot Description
1	PCIe 2.0 x16_1 slot [blue] (at x16 mode)
2	PCIe 2.0 x1_1 slot
3	PCIe 2.0 x1_2 slot
4	PCIe 2.0 x16_2 slot [black] (at x4 mode)
5	PCI 1
6	PCI 2

VGA configuration	PCI Express operating mode	
	PCIe 2.0 x16_1	PCIe 2.0 x16_2
Single VGA/PCIe card	x16 (Recommend for single VGA)	N/A
Dual VGA/PCIe card	x16	x4



- In single VGA card mode, use the PCIe 2.0 x16_1 slot (navy blue) for a PCI Express x16 graphics card to get better performance.
- We recommend that you provide sufficient power when running CrossFireX™ mode.
- Connect a chassis fan to the motherboard connector labeled CHA_FAN1/2/3 when using multiple graphics cards for better thermal environment.

IRQ assignments for this motherboard

	A	B	C	D	E	F	G	H
PCIe x16_1	-	-	-	-	shared	-	-	-
PCIe x16_2	-	-	-	-	shared	-	-	-
PCIe x1_1	-	-	-	-	-	-	shared	-
PCIe x1_2	-	-	-	-	-	shared	-	-
PCI 1	-	-	-	-	shared	-	-	-
PCI 2	-	-	-	-	-	shared	-	-
Realtek 8111F (LAN)	-	-	-	-	shared	-	-	-
ASMedia USB 3.0 (port 1 & port 2)	-	-	-	-	shared	-	-	-
ASMedia USB 3.0 (port 3 & port 4)	-	-	-	-	-	-	shared	-
On Chip SATA	-	-	-	shared	-	-	-	-
On Chip USB 1	-	-	shared	-	-	-	-	-
On Chip USB 2	-	-	shared	-	-	-	-	-
On Chip USB 3	-	-	shared	-	-	-	-	-
HD Audio	shared	-	-	-	-	-	-	-

1.2.6 Onboard switches and buttons

Onboard switches and buttons allow you to fine-tune performance when working on a bare or open-case system. This is ideal for overclockers and gamers who continually change settings to enhance system performance.

1. DirectKey button

This feature allows your system to go to the BIOS Setup program with the press of a button. With DirectKey, you can enter the BIOS anytime without having to press the <Delete> key during POST. It allows you to turn on or turn off the system and conveniently enter the BIOS during bootup.

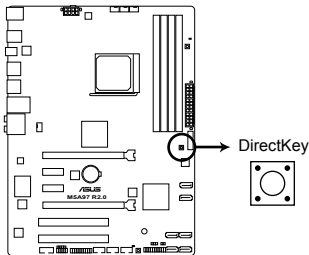

M5A97 R2.0 DirectKey switch



Ensure to save your data before using the DirectKey button.



- When the system is on and you press the DirectKey button, your system will shut down. Press the DirectKey button again or the Power-on button to reboot and enter the BIOS directly.
 - Turn on your system using the power-on button to allow your system to go through POST (without entering the BIOS) when you reboot your system.
 - Refer to **Chapter 3.7 Boot Menu** for details about setting the DirectKey default function.
-

2. MemOK! switch

Installing DIMMs that are incompatible with the motherboard may cause system boot failure, and the DRAM_LED near the MemOK! switch lights continuously. Press and hold the MemOK! switch until the DRAM_LED starts blinking to begin automatic memory compatibility tuning for successful boot.

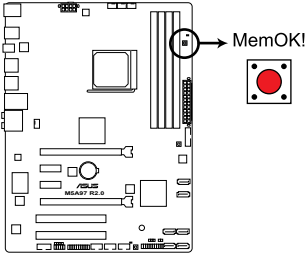

M5A97 R2.0 MemOK! switch



- Refer to section **1.2.8 Onboard LEDs** for the exact location of the DRAM_LED.
- The DRAM_LED also lights when the DIMM is not properly installed. Turn off the system and reinstall the DIMM before using the MemOK! function.
- The MemOK! switch does not function under Windows® OS environment.
- During the tuning process, the system loads and tests failsafe memory settings. It takes about 30 seconds for the system to test one set of failsafe settings. If the test fails, the system reboots and test the next set of failsafe settings. The blinking speed of the DRAM_LED increases, indicating different test processes.
- Due to memory tuning requirement, the system automatically reboots when each timing set is tested. If the installed DIMMs still fail to boot after the whole tuning process, the DRAM_LED lights continuously. Replace the DIMMs with ones recommended in the Memory QVL (Qualified Vendors Lists) in this user manual or on the ASUS website at www.asus.com.
- If you turn off the computer and replace DIMMs during the tuning process, the system continues memory tuning after turning on the computer. To stop memory tuning, turn off the computer and unplug the power cord for about 5–10 seconds.
- If your system fail to boot due to BIOS overlocking, press the MemOK! switch to boot and load BIOS default settings. A message will appear during POST reminding you that the BIOS has been restored to its default settings.
- We recommend that you download and update to the latest BIOS version from the ASUS website at www.asus.com after using the MemOK! function.

3. BIOS Flashback button

USB BIOS Flashback allows you to easily update the BIOS without entering the BIOS or operating system. Just connect the USB storage device containing the BIOS file to the USB port, press the BIOS Flashback button, and the BIOS is updated automatically.

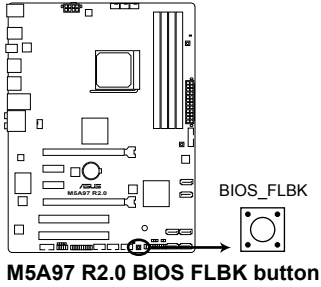

For more details about using the USB BIOS Flashback button, refer to section **2.2.1 USB BIOS Flashback**.

1.2.7 Jumpers

Clear RTC RAM (CLRRTC)

This jumper allows you to clear the Real Time Clock (RTC) RAM in CMOS. You can clear the CMOS memory of date, time, and system setup parameters by erasing the CMOS RTC RAM data. The onboard button cell battery powers the RAM data in CMOS, which include system setup information such as system passwords.

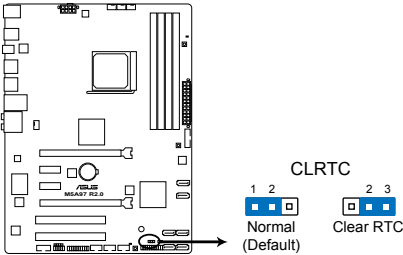

M5A97 R2.0 Clear RTC RAM

To erase the RTC RAM:

1. Turn OFF the computer and unplug the power cord.
2. Move the jumper cap from pins 1-2 (default) to pins 2-3. Keep the cap on pins 2-3 for about 5~10 seconds, then move the cap back to pins 1-2.
3. Plug the power cord and turn ON the computer.
4. Hold down the key during the boot process and enter BIOS setup to reenter data.



Except when clearing the RTC RAM, never remove the cap on CLRRTC jumper default position. Removing the cap will cause system boot failure!



- If the steps above do not help, remove the onboard battery and move the jumper again to clear the CMOS RTC RAM data. After clearing the CMOS, reinstall the battery.
- You do not need to clear the RTC when the system hangs due to overclocking. For system failure due to overclocking, use the CPU Parameter Recall (C.P.R) feature. Shut down and reboot the system so the BIOS can automatically reset parameter settings to default values.

1.2.8 Onboard LEDs

1. Standby Power LED

The motherboard comes with a standby power LED that lights up to indicate that the system is ON, in sleep mode, or in soft-off mode. This is a reminder that you should shut down the system and unplug the power cable before removing or plugging in any motherboard component. The illustration below shows the location of the onboard LED.

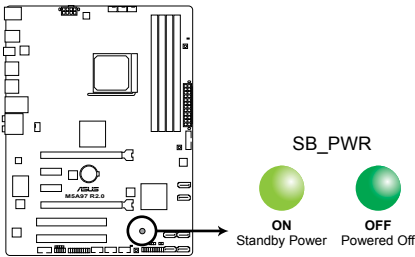

M5A97 R2.0 Onboard LED

2. DRAM LED

DRAM LED checks the DRAM in sequence during motherboard booting process. If an error is found, the LED next to the error device will continue lighting until the problem is solved. This user-friendly design provides an intuitive way to locate the root problem within a second.

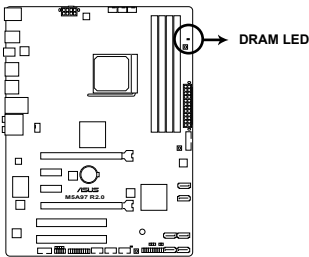

M5A97 R2.0 DRAM LED

3. BIOS Flashback LED (FLBK_LED)

The FLBK LED lights when the USB Flashback button is pressed for three seconds.

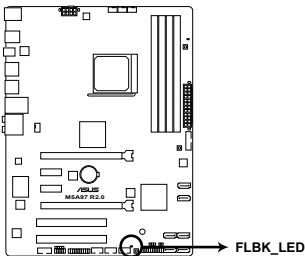

M5A97 R2.0 FLBK LED

1.2.9 Internal connectors

1. CPU and chassis fan connectors (4-pin CPU_FAN, and 4-pin CHA_FAN1/2/3)

Connect the fan cables to the fan connectors on the motherboard, ensuring that the black wire of each cable matches the ground pin of the connector.

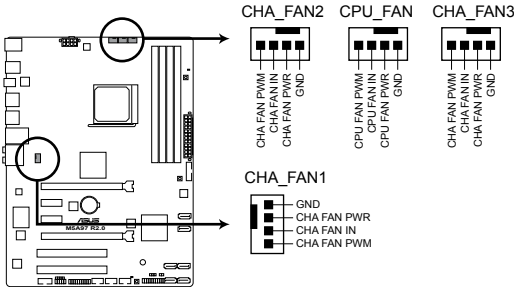

M5A97 R2.0 Fan connectors



DO NOT forget to connect the fan cables to the fan connectors. Insufficient air flow inside the system may damage the motherboard components. These are not jumpers! DO NOT place jumper caps on the fan connectors.



- The CPU_FAN connector supports a CPU fan of maximum 1A (12 W) fan power.
- Only the CPU_FAN and CHA_FAN1/2/3 connectors support the ASUS Fan Xpert feature.
- If you install two VGA cards, we recommend that you plug the rear chassis fan cable to the motherboard connector labeled CHA_FAN1/2/3 for better thermal environment.

2. TPM connector (20-pin TPM)

This connector supports a Trusted Platform Module (TPM) system, which can securely store keys, digital certificates, passwords, and data. A TPM system also helps enhance network security, protects digital identities, and ensures platform integrity.

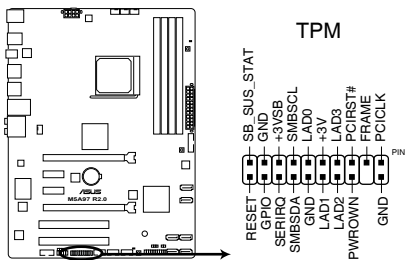

M5A97 R2.0 TPM Connector



The TPM module is purchased separately!

3. ATX power connectors (24-pin EATXPWR, 8-pin EATX12V)

These connectors are for an ATX power supply. The plugs from the power supply are designed to fit these connectors in only one orientation. Find the proper orientation and push down firmly until the connectors completely fit.

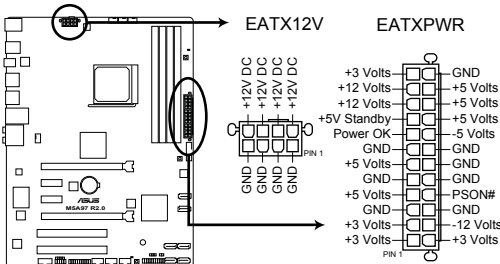

M5A97 R2.0 ATX power connectors



- We recommend that you use an ATX 12V Specification 2.0-compliant power supply unit (PSU) with a minimum of 300W power rating.
- If you intend to use a PSU with 20-pin and 4-pin power plugs, ensure that the 20-pin power plug can provide at least 15 A on +12 V and that the PSU has a minimum power rating of 300W. The system may become unstable or may not boot up if the power is inadequate.
- DO NOT forget to connect the 4-pin / 8-pin ATX +12V power plug. Otherwise, the system will not boot up.
- We recommend that you use a PSU with higher power output when configuring a system with more power-consuming devices or when you intend to install additional devices. The system may become unstable or may not boot up if the power is inadequate.
- If you are uncertain about the minimum power supply requirement for your system, refer to the Recommended Power Supply Wattage Calculator at <http://support.asus.com/PowerSupplyCalculator/PSCalculator.aspx?SLanguage=en-us> for details.

4. Serial ATA 6.0 Gb/s connectors (7-pin SATA6G 1~6)

These connectors are for the Serial ATA 6.0 Gb/s signal cables for Serial ATA hard disk drives and optical disc drives. If you installed Serial ATA hard disk drives, you can create a RAID 0, RAID 1, RAID 5, RAID 10, or JBOD configuration through the onboard controller.

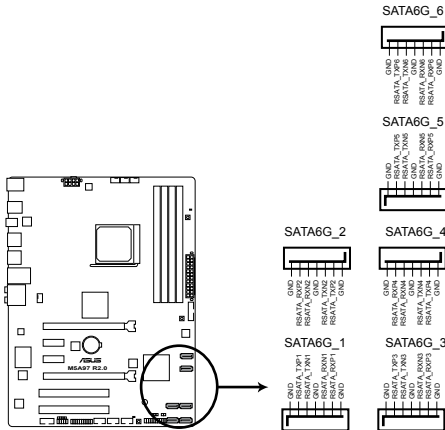

M5A97 R2.0 SATA 6.0Gb/s connectors



- These connectors are set to [AHCI Mode] by default. If you intend to create a Serial ATA RAID set using these connectors, set the SATA Mode item in the BIOS to [RAID Mode]. Refer to section **3.5.4 SATA Configuration** for details.
- Before creating a RAID set, refer to section **5.1 RAID configurations** or the manual bundled in the motherboard support DVD.
- When using NCQ, set the SATA Mode in the BIOS to [AHCI Mode]. Refer to section **3.5.4 SATA Configuration** for details.
- You must install Windows® XP Service Pack 3 or later versions before using Serial ATA hard disk drives. The Serial ATA RAID feature is available only if you are using Windows® XP SP3 or later versions.
- When creating a RAID set, set the SATA_5-6 connectors to [IDE Mode] to ensure that the system recognizes your ODD device.

5. **Serial port connector (10-1 pin COM1)**

This connector is for a serial (COM) port. Connect the serial port module cable to this connector, then install the module to a slot opening at the back of the system chassis.

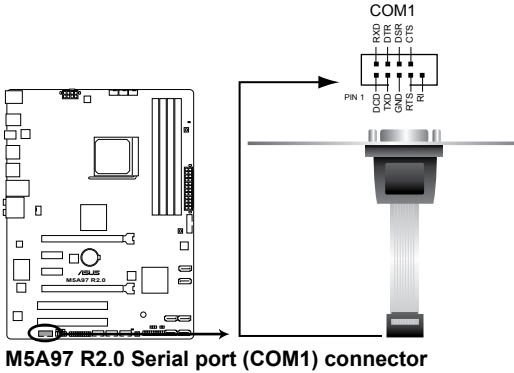

The COM module is purchased separately.

6. **Digital audio connector (4-1 pin SPDIF_OUT)**

This connector is for an additional Sony/Philips Digital Interface (S/PDIF) port.

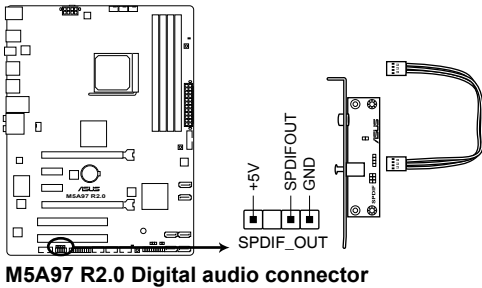

Ensure that the audio device of Sound playback is **Realtek High Definition Audio** (the name may be different based on the OS). Go to **Start > Control Panel > Sounds and Audio Devices > Sound Playback** to configure the setting.



The S/PDIF module is purchased separately.

7. System panel connector (20-8 pin PANEL)

This connector supports several chassis-mounted functions.

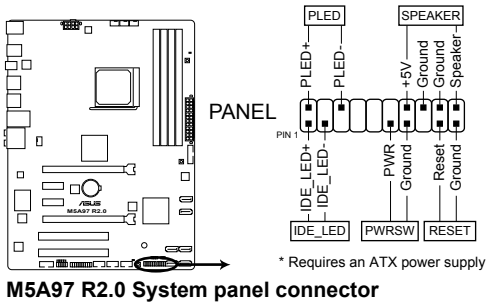

- **System power LED (2-pin PLED)**

This 2-pin connector is for the system power LED. Connect the chassis power LED cable to this connector. The system power LED lights up when you turn on the system power, and blinks when the system is in sleep mode.

- **Hard disk drive activity LED (2-pin IDE_LED)**

This 2-pin connector is for the HDD Activity LED. Connect the HDD Activity LED cable to this connector. The IDE LED lights up or flashes when data is read from or written to the HDD.

- **System warning speaker (4-pin SPEAKER)**

This 4-pin connector is for the chassis-mounted system warning speaker. The speaker allows you to hear system beeps and warnings.

- **ATX power button/soft-off button (2-pin PWRSW)**

This connector is for the system power button. Pressing the power button turns the system on or puts the system in sleep or soft-off mode depending on the BIOS settings. Pressing the power switch for more than four seconds while the system is ON turns the system OFF.

- **Reset button (2-pin RESET)**

This 2-pin connector is for the chassis-mounted reset button for system reboot without turning off the system power.

8. Front panel audio connector (10-1 pin AAFP)

This connector is for a chassis-mounted front panel audio I/O module that supports either High Definition Audio or AC '97 audio standard. Connect one end of the front panel audio I/O module cable to this connector.

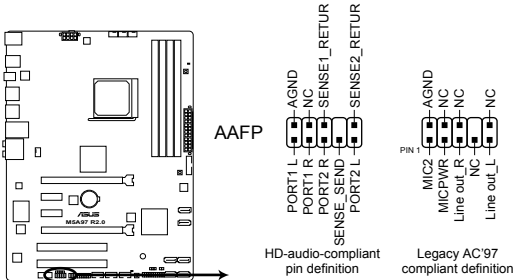

M5A97 R2.0 Front panel audio connector



- We recommend that you connect a high-definition front panel audio module to this connector to avail of the motherboard high-definition audio capability.
- If you want to connect a high definition front panel audio module to this connector, set the **Front Panel Type** item in the BIOS to **[HD]**. See section **3.5.7 Onboard Devices Configuration** for details.
- The front panel audio I/O module is purchased separately.

9. USB 3.0 connector (20-1 pin USB3_34)

This connector is for the additional USB 3.0 ports. Connect the USB 3.0 bracket cable to this connector, then install the USB 3.0 bracket to the rear side of the chassis. If your chassis support customized front panel installation, with ASUS USB 3.0 header, you can have a front panel USB 3.0 solution.

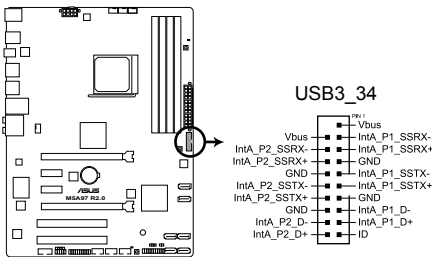

M5A97 R2.0 USB3.0 Front panel connector



The USB 3.0 module is purchased separately.

10. USB 2.0 connectors (10-1 pin USB910, USB1112, USB1314)

These connectors are for USB 2.0 ports. Connect the USB module cable to any of these connectors, then install the module to a slot opening at the back of the system chassis. These USB connectors comply with USB 2.0 specification that supports up to 480Mbps connection speed.

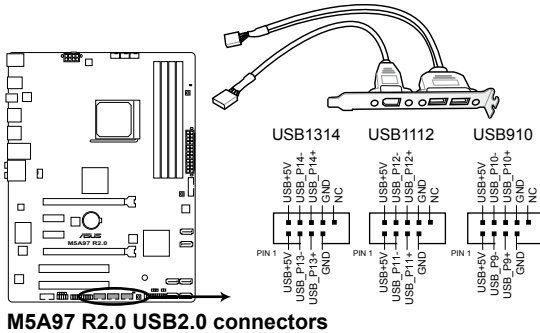

Never connect a 1394 cable to the USB connectors. Doing so will damage the motherboard!



The USB 2.0 module is purchased separately.

11. DRCT header (2-pin DRCT)

This connector is for the chassis-mounted button that supports the DirectKey function. Connect the button cable that supports DirectKey, from the chassis to this connector on the motherboard.

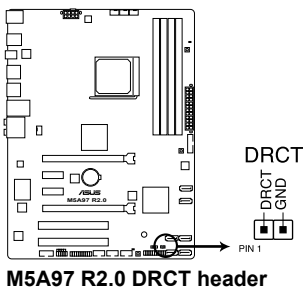

Ensure that your chassis comes with the button cable that supports the DirectKey feature. Refer to the technical documentation that came with the chassis for details.

Basic Installation

2

2.1 Building your PC system

2.1.1 Motherboard installation



The diagrams in this section are for reference only. The motherboard layout may vary with models, but the installation steps are the same for all models.

1. Install the ASUS I/O Shield to the chassis rear I/O panel.

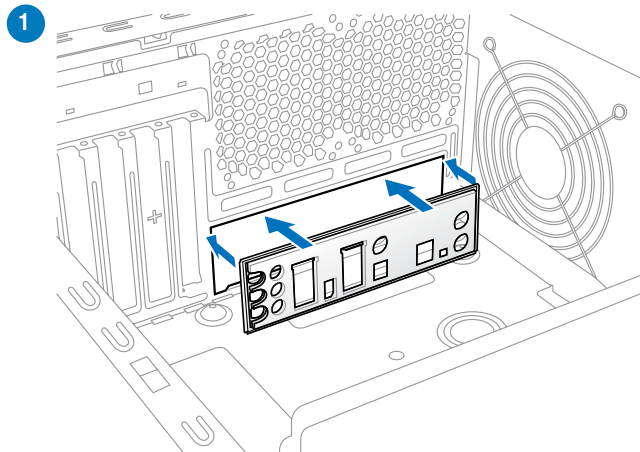

2. Place the motherboard into the chassis, ensuring that its rear I/O ports are aligned to the chassis' rear I/O panel.

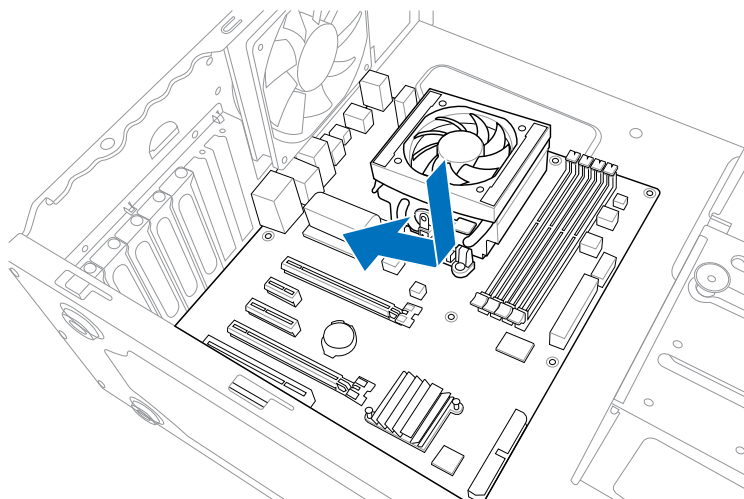

- Place six screws into the holes indicated by circles to secure the motherboard to the chassis.

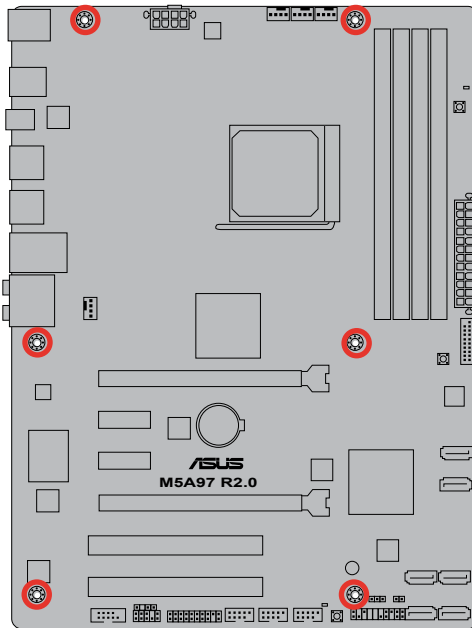
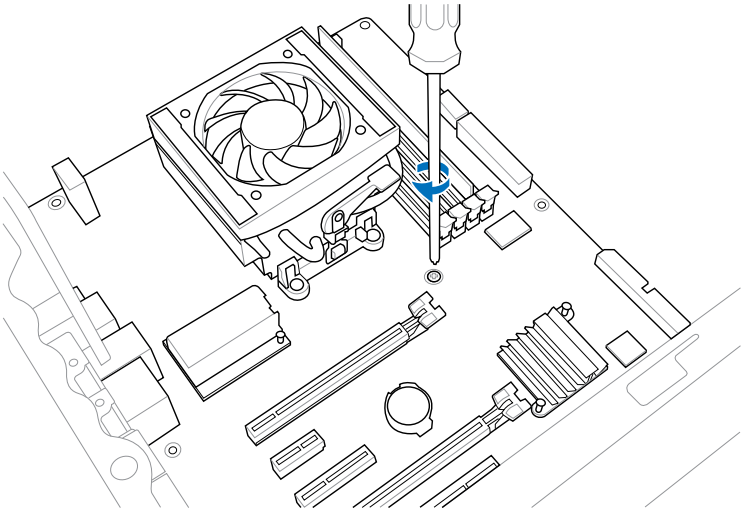

DO NOT overtighten the screws! Doing so can damage the motherboard.

2.1.2 CPU installation



The AMD AM3+ socket is compatible with AMD AM3+ and AM3 processors. Ensure you use a CPU designed for the AM3+ socket. The CPU fits in only one correct orientation. **DO NOT** force the CPU into the socket to prevent bending the connectors on the socket and damaging the CPU!

1

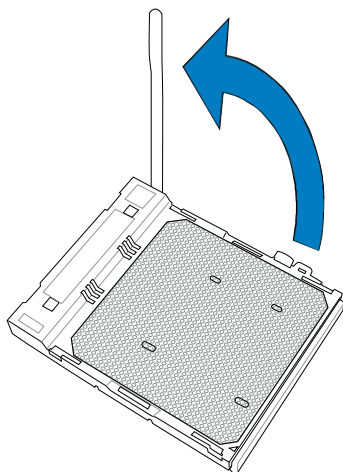

2

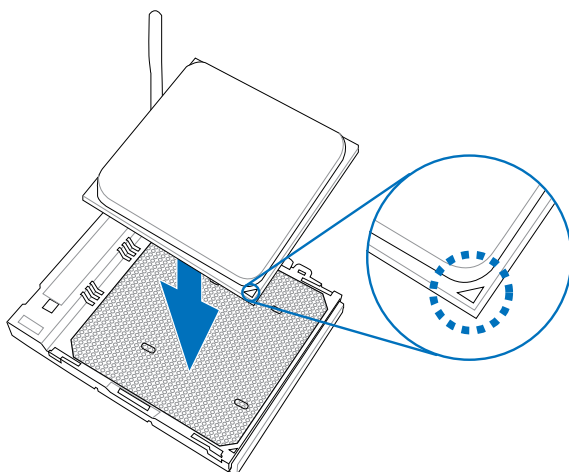

3

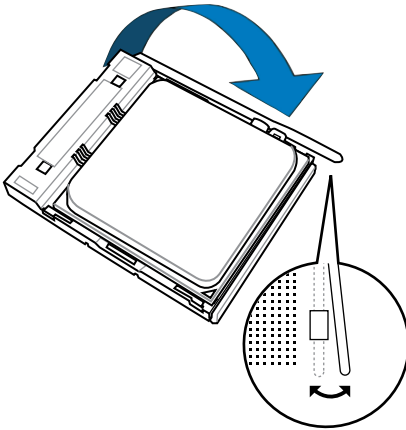

2.1.3 CPU heatsink and fan assembly installation

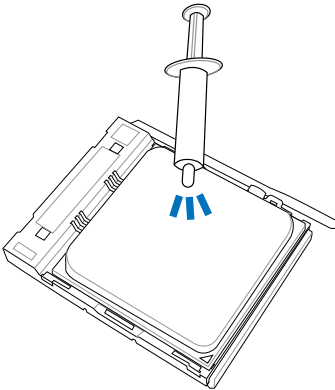

Apply the Thermal Interface Material to the CPU heatsink and CPU before you install the heatsink and fan if necessary.

To install the CPU heatsink and fan assembly

1

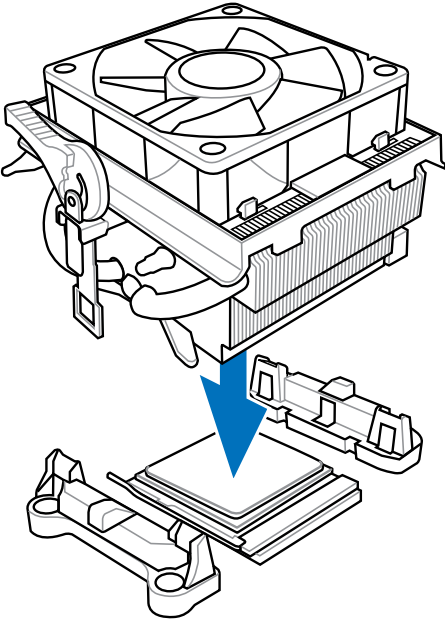

2

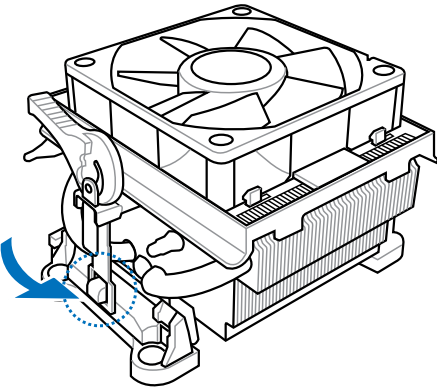

3

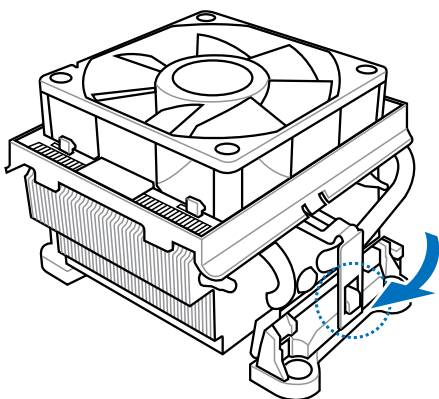

4

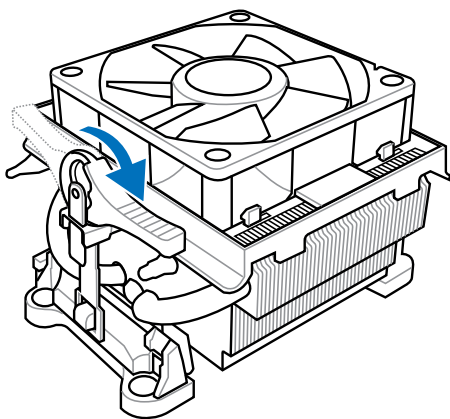

5

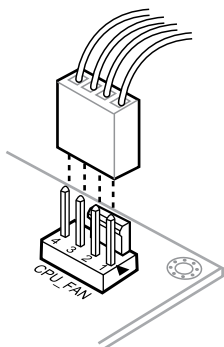

2.1.4 DIMM installation

1

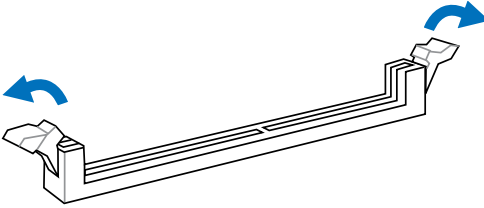

2

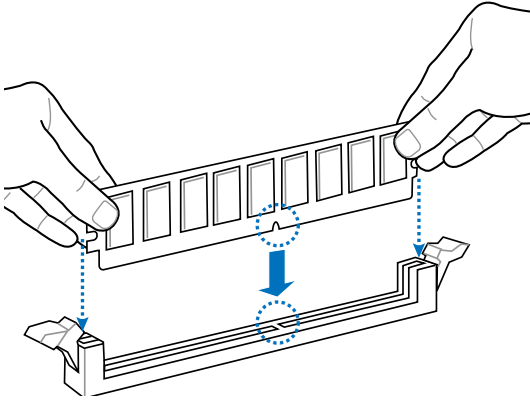

3

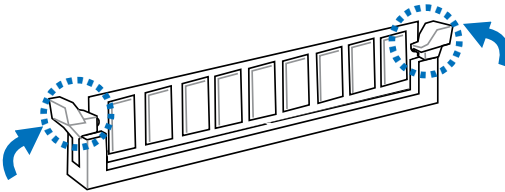

To remove a DIMM

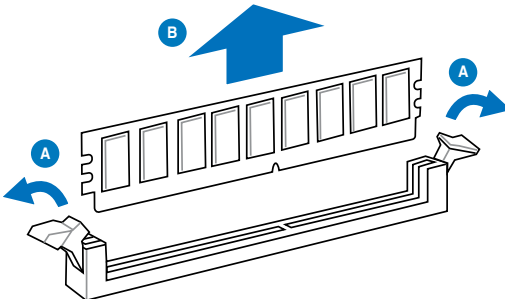

2.1.5 ATX Power connection

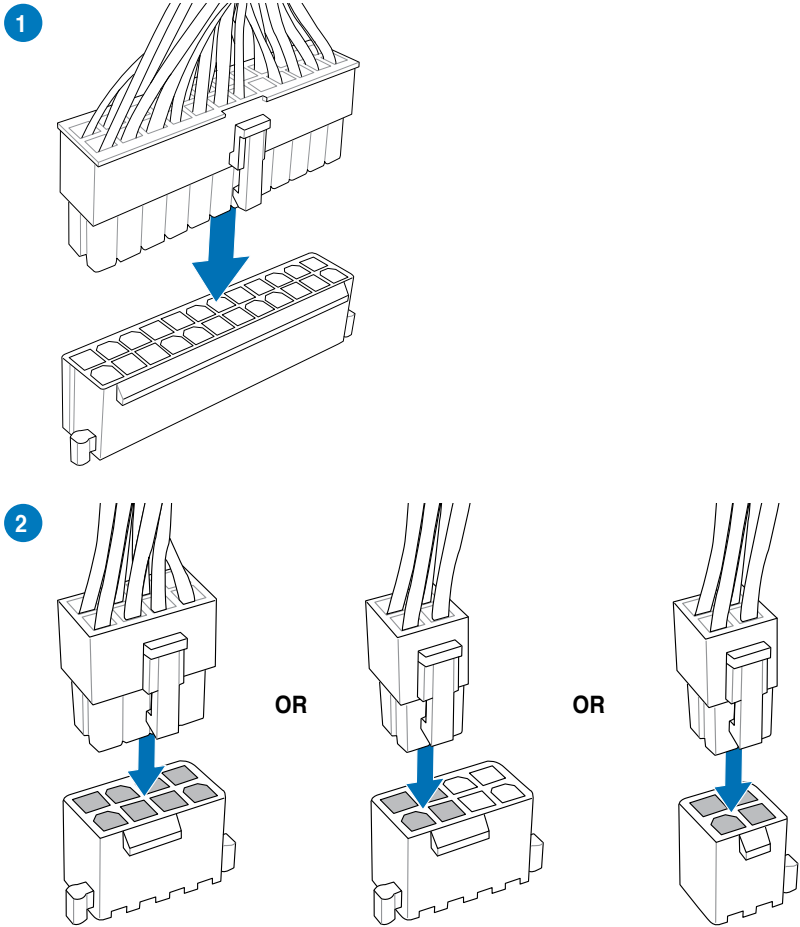

2.1.6 SATA device connection

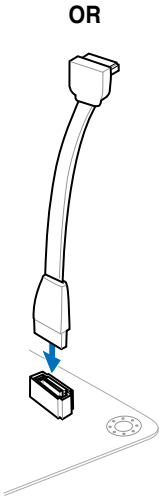
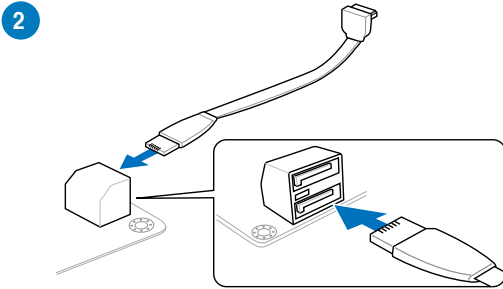
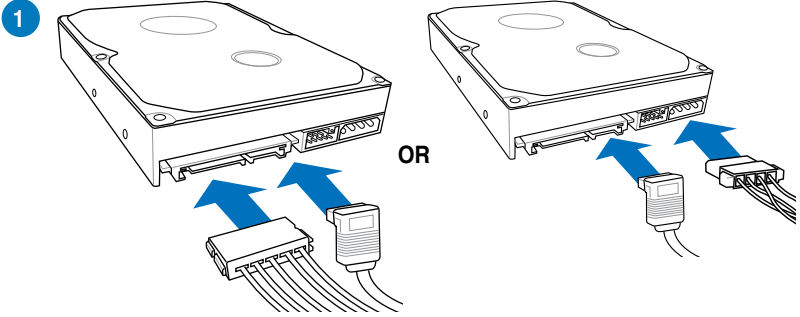

2.1.7 Expansion Card installation

To install PCIe x16 cards

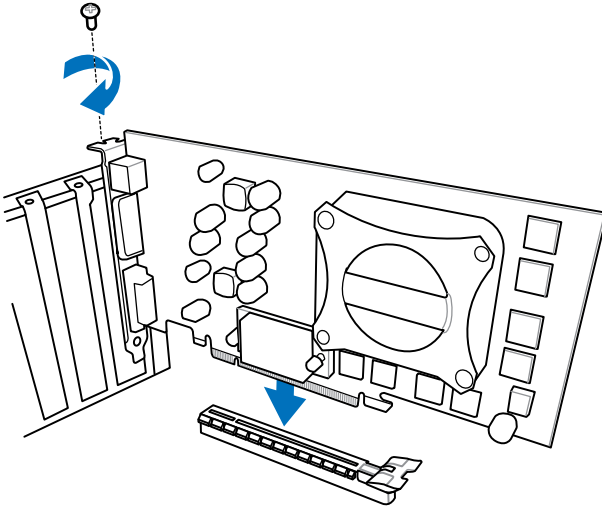

To install PCIe x1 cards

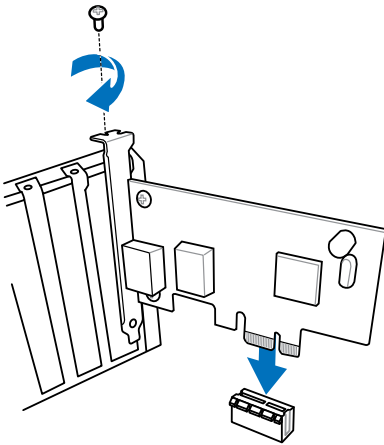

To install PCI cards

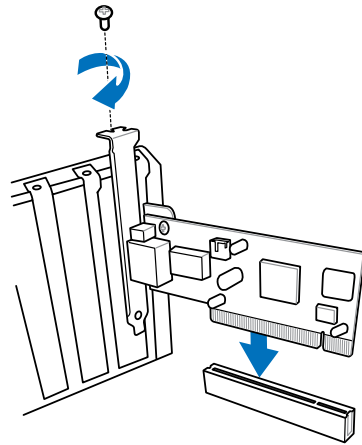

2.2 BIOS update utility

2.2.1 USB BIOS Flashback

USB BIOS Flashback allows you to easily update the BIOS without entering the existing BIOS or operating system. Simply insert a USB storage device to the USB port, press the USB BIOS Flashback button for three seconds, and the BIOS is updated automatically.

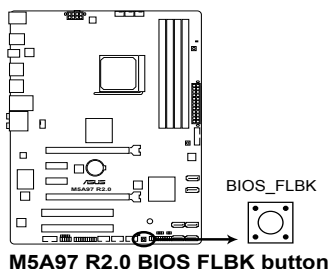

To use USB BIOS Flashback:

1. Place the bundled support DVD to the optical drive and install the USB BIOS Flashback Wizard. Follow the onscreen instructions to complete the installation.



You can also download the BIOS from ASUS website (www.asus.com). Rename the file as **M5A97R20.CAP** and save it to a USB portable device's root directory.

2. Insert the USB storage device to the USB Flashback port.
3. Launch the USB BIOS Flashback Wizard to automatically download the latest BIOS version.
4. Press the BIOS Flashback button for three seconds until a flashing light appears, which indicates that the BIOS Flashback function is enabled.
5. Wait until the light goes out, indicating that the BIOS updating process is completed.

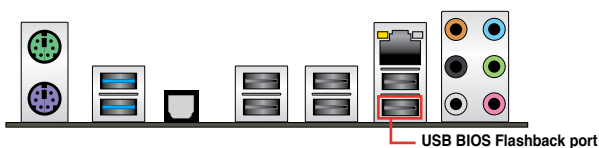

For more BIOS update utilities in BIOS setup, refer to the section Updating BIOS in Chapter 3.



- Do not unplug portable disk, power system, or press the CLR_CMOS button while BIOS update is ongoing, otherwise update will be interrupted. In case of interruption, please follow the steps again.
- If the light flashes for five seconds and turns into a solid light, this means that the BIOS Flashback is not operating properly. This may be caused by improper installation of the USB storage device and filename/file format error. If this scenario happens, please restart the system to turn off the light.
- Updating BIOS may have risks. If the BIOS program is damaged during the process and results to the system's failure to boot up, please contact your local ASUS Service Center.

2.3 Motherboard rear and audio connections

2.3.1 Rear I/O connection

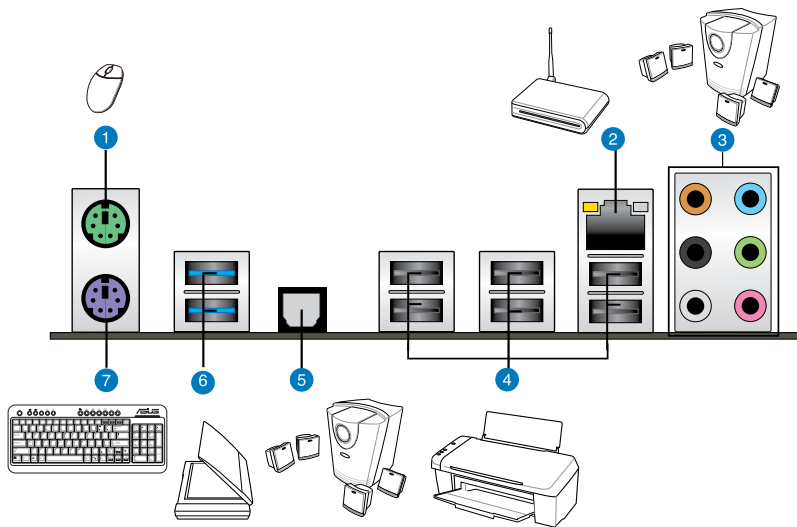

Rear panel connectors

1.	PS/2 mouse port (green)	5.	Optical S/PDIF Out port
2.	LAN (RJ-45) port*	6.	USB 3.0 ports 1 and 2 support ASUS USB 3.0 Boost UASP Mode.
3.	Audio I/O ports**	7.	PS/2 keyboard port (purple)
4.	USB 2.0 ports (USB 2.0 port1 supports USB BIOS Flashback)		

* and **: Refer to the tables on the next page for LAN port LEDs, and audio port definitions.



- Due to USB 3.0 controller limitation, USB 3.0 devices can only be used under Windows® OS environment and after the USB 3.0 driver installation.
- USB 3.0 devices can only be used as data storage only.
- We strongly recommend that you connect USB 3.0 devices to USB 3.0 ports for faster and better performance for your USB 3.0 devices.
- USB 2.0_1 port supports USB BIOS Flashback.

*** LAN ports LED indications**

Activity Link LED		Speed LED	
Status	Description	Status	Description
OFF	No link	OFF	10 Mbps connection
ORANGE	Linked	ORANGE	100 Mbps connection
BLINKING	Data activity	GREEN	1 Gbps connection

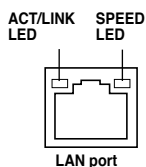

**** Audio 2, 4, 6, or 8-channel configuration**

Port	Headset 2-channel	4-channel	6-channel	8-channel
Light Blue	Line In	Line In	Line In	Line In
Lime	Line Out	Front Speaker Out	Front Speaker Out	Front Speaker Out
Pink	Mic In	Mic In	Mic In	Mic In
Orange	–	–	Center/Subwoofer	Center/Subwoofer
Black	–	Rear Speaker Out	Rear Speaker Out	Rear Speaker Out
Gray	–	–	–	Side Speaker Out

2.3.2 Audio I/O connections

Audio I/O ports

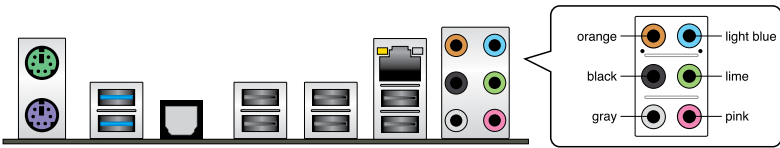

Connect to Headphone and Mic

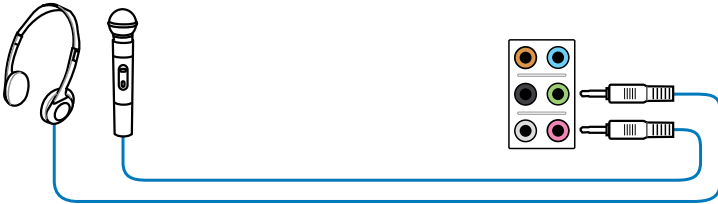

Connect to Stereo Speakers

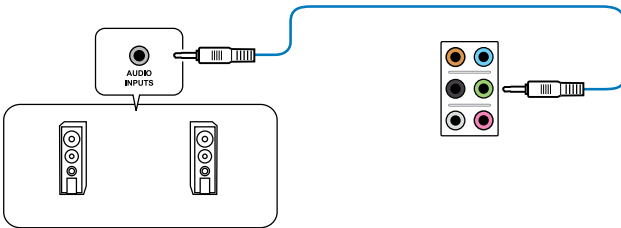

Connect to 2.1 channel Speakers

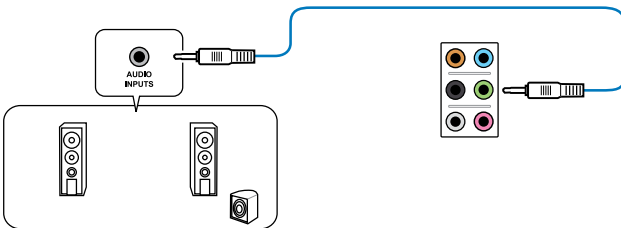

Connect to 4.1 channel Speakers

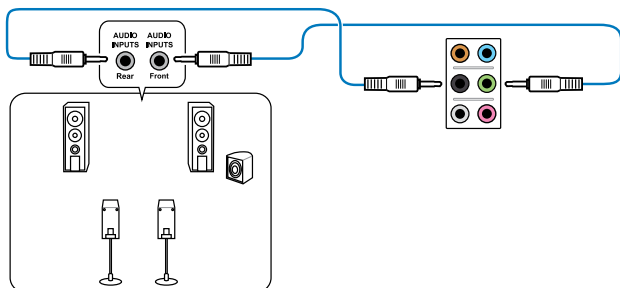

Connect to 5.1 channel Speakers

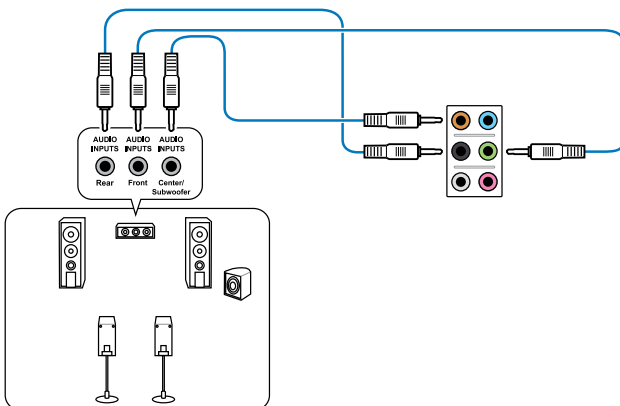

Connect to 7.1 channel Speakers

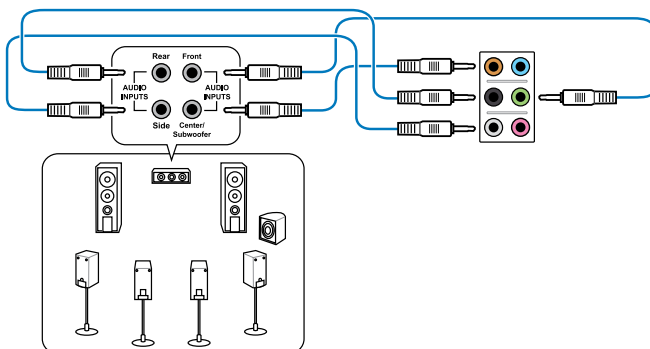

2.4 Starting up for the first time

1. After making all the connections, replace the system case cover.
2. Ensure that all switches are off.
3. Connect the power cord to the power connector at the back of the system chassis.
4. Connect the power cord to a power outlet that is equipped with a surge protector.
5. Turn on the devices in the following order:
 - a. Monitor
 - b. External SCSI devices (starting with the last device on the chain)
 - c. System power
6. After applying power, the system power LED on the system front panel case lights up. For systems with ATX power supplies, the system LED lights up when you press the ATX power button. If your monitor complies with the “green” standards or if it has a “power standby” feature, the monitor LED may light up or change from orange to green after the system LED turns on.

The system then runs the power-on self tests (POST). While the tests are running, the BIOS beeps (refer to the BIOS beep codes table) or additional messages appear on the screen. If you do not see anything within 30 seconds from the time you turned on the power, the system may have failed a power-on test. Check the jumper settings and connections or call your retailer for assistance.

BIOS Beep	Description
One short beep	VGA detected Quick boot set to disabled No keyboard detected
One continuous beep followed by two short beeps then a pause (repeated)	No memory detected
One continuous beep followed by three short beeps	No VGA detected
One continuous beep followed by four short beeps	Hardware component failure

7. At power on, hold down the <Delete> key to enter the BIOS Setup. Follow the instructions in Chapter 3.

2.5 Turning off the computer

While the system is ON, press the power button for less than four seconds to put the system on sleep mode or soft-off mode, depending on the BIOS setting. Press the power switch for more than four seconds to let the system enter the soft-off mode regardless of the BIOS setting.

BIOS setup

3

3.1 Knowing BIOS



The new ASUS UEFI BIOS is a Unified Extensible Interface that complies with UEFI architecture, offering a user-friendly interface that goes beyond the traditional keyboard-only BIOS controls to enable a more flexible and convenient mouse input. You can easily navigate the new UEFI BIOS with the same smoothness as your operating system. The term "BIOS" in this user manual refers to "UEFI BIOS" unless otherwise specified.

BIOS (Basic Input and Output System) stores system hardware settings such as storage device configuration, overclocking settings, advanced power management, and boot device configuration that are needed for system startup in the motherboard CMOS. In normal circumstances, the default BIOS settings apply to most conditions to ensure optimal performance. **DO NOT change the default BIOS settings** except in the following circumstances:

- An error message appears on the screen during the system bootup and requests you to run the BIOS Setup.
- You have installed a new system component that requires further BIOS settings or update.



Inappropriate BIOS settings may result to instability or boot failure. **We strongly recommend that you change the BIOS settings only with the help of a trained service personnel.**



When downloading or updating the BIOS file, rename it as **M5A97R20.CAP** for this motherboard.

3.2 BIOS setup program

Use the BIOS Setup to update the BIOS or configure its parameters. The BIOS screen include navigation keys and brief onscreen help to guide you in using the BIOS Setup program.

Entering BIOS at startup

To enter BIOS Setup at startup:

- Press <Delete> during the Power-On Self Test (POST). If you do not press <Delete>, POST continues with its routines.

Entering BIOS Setup after POST

To enter BIOS Setup after POST:

- Press <Ctrl>+<Alt>+<Delete> simultaneously.
- Press the reset button on the system chassis.
- Press the power button to turn the system off then back on. Do this option only if you failed to enter BIOS Setup using the first two options.



-
- The BIOS setup screens shown in this section are for reference purposes only, and may not exactly match what you see on your screen.
 - Ensure that a USB mouse is connected to your motherboard if you want to use the mouse to control the BIOS setup program.
 - If the system becomes unstable after changing any BIOS setting, load the default settings to ensure system compatibility and stability. Select the **Load Optimized Defaults** item under the **Exit** menu or press hotkey <F5>. See section 3.9 **Exit Menu** for details.
 - If the system fails to boot after changing any BIOS setting, try to clear the CMOS and reset the motherboard to the default value. See section 1.2.6 **Onboard switches and buttons** for information on how to erase the RTC RAM via the Clear CMOS button.
 - The BIOS setup program does not support the bluetooth devices.
-

BIOS menu screen

The BIOS Setup program can be used under two modes: **EZ Mode** and **Advanced Mode**. You can change modes from the **Exit** menu or from the **Exit/Advanced Mode** screen.

3.2.1 EZ Mode

By default, the EZ Mode screen appears when you enter the BIOS setup program. The EZ Mode provides you an overview of the basic system information, and allows you to select the display language, system performance mode and boot device priority. To access the Advanced Mode, click **Exit/Advanced Mode**, then select **Advanced Mode** or press <F7> hot key for the advanced BIOS settings.



The default screen for entering the BIOS setup program can be changed. Refer to the **Setup Mode** item in section 3.7 **Boot menu** for details.

Displays the CPU/motherboard temperature, CPU/5V/3.3V/12V voltage output, CPU/chassis fan speed

Selects the display language of the BIOS setup program

Clicks to display all fan speeds if available

Exits the BIOS setup program without saving the changes, saves the changes and resets the system, or enters the Advanced Mode

Displays the Advanced mode functions

Displays the Advanced mode menus

Power Saving mode

Normal mode

ASUS Optimal mode

Loads optimized default

Displays the system properties of the selected mode on the right hand side



- The boot device options vary depending on the devices you installed to the system.
- The **Boot Menu (F8)** button is available only when the boot device is installed to the system.

3.2.2 Advanced Mode

The Advanced Mode provides advanced options for experienced end-users to configure the BIOS settings. The figure below shows an example of the Advanced Mode. Refer to the following sections for the detailed configurations.



To access the Advanced Mode, click **Exit**, then select **Advanced Mode** or press **F7** hotkey.

The screenshot shows the ASUS UEFI BIOS Utility in Advanced Mode. The interface is dark-themed with a menu bar at the top containing icons for Main, AI Tweaker, Advanced, Monitor, Boot, and Tool. A red box highlights the 'EPU Power Saving Mode' setting, which is currently set to 'Disabled'. A pop-up window for 'EPU Power Saving Mode' is open, showing 'Disabled' selected. A scroll bar is visible on the right side of the main configuration area. A navigation key legend is shown in the bottom right corner, listing keys like ++, F1, Enter, +/-, F1, F2, F3, F5, F10, and F12 with their respective functions. Labels with red lines point to various parts of the interface: 'Menu items' points to the top icons; 'Menu bar' points to the top navigation bar; 'Configuration fields' points to the main settings area; 'General help' points to the help legend; 'Submenu item' points to 'DRAM Timing Control'; 'Pop-up window' points to the 'EPU Power Saving Mode' dialog; 'Scroll bar' points to the vertical scrollbar; and 'Navigation keys' points to the legend.

Menu bar

The menu bar on top of the screen has the following main items:

Main	For changing the basic system configuration
AI Tweaker	For changing the overclocking settings
Advanced	For changing the advanced system settings
Monitor	For displaying the system temperature, power status, and changing the fan settings.
Boot	For changing the system boot configuration
Tool	For configuring options for special functions
Exit	For selecting the exit options and loading default settings

Menu items

The highlighted item on the menu bar displays the specific items for that menu. For example, selecting **Main** shows the Main menu items.

The other items (Ai Tweaker, Advanced, Monitor, Boot, Tool, and Exit) on the menu bar have their respective menu items.

Back button

This button appears when entering a submenu. Press <Esc> or use the USB mouse to click this button to return to the previous menu screen.

Submenu items

A greater than sign (>) before each item on any menu screen means that the item has a submenu. To display the submenu, select the item and press <Enter>.

Pop-up window

Select a menu item and press <Enter> to display a pop-up window with the configuration options for that item.

Scroll bar

A scroll bar appears on the right side of a menu screen when there are items that do not fit on the screen. Press the Up/Down arrow keys or <Page Up> / <Page Down> keys to display the other items on the screen.

Navigation keys

At the bottom right corner of the menu screen are the navigation keys for the BIOS setup program. Use the navigation keys to select items in the menu and change the settings.

General help

At the top right corner of the menu screen is a brief description of the selected item. Use <F12> key to capture the BIOS screen and save it to the removable storage device.

Configuration fields

These fields show the values for the menu items. If an item is user-configurable, you can change the value of the field opposite the item. You cannot select an item that is not user-configurable.

A configurable field is highlighted when selected. To change the value of a field, select it and press <Enter> to display a list of options.

3.3 Main menu

The Main menu appears when you enter the Advanced Mode of the BIOS Setup program. The Main menu provides you an overview of the basic system information, and allows you to set the system date, time, language, and security settings.

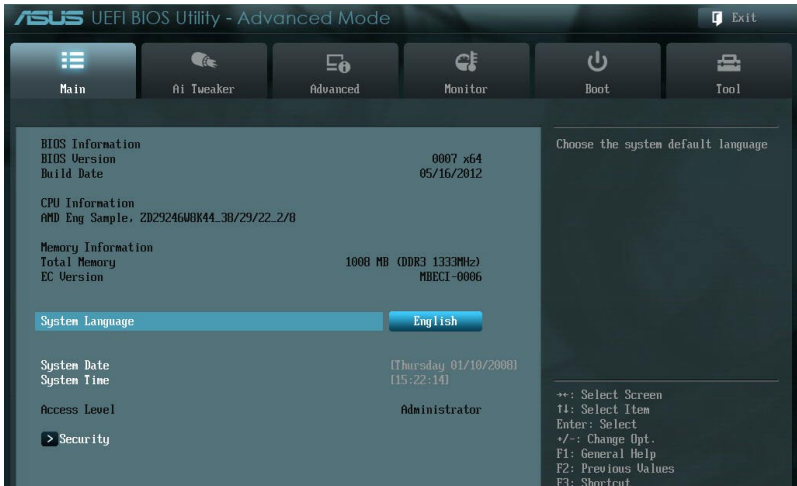

Security

The Security menu items allow you to change the system security settings.

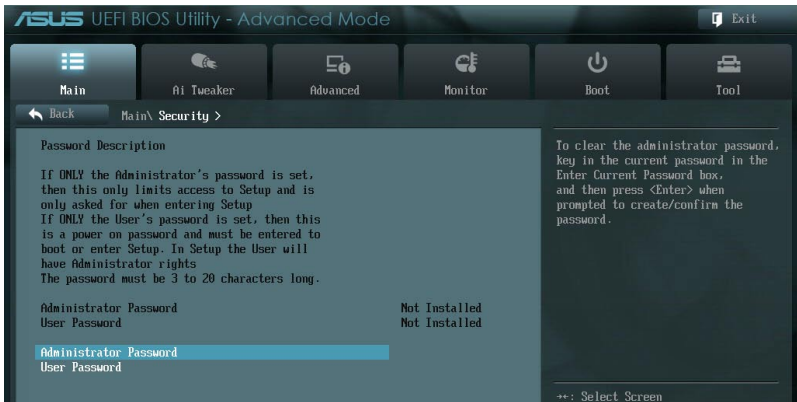

- If you have forgotten your BIOS password, erase the CMOS Real Time Clock (RTC) RAM to clear the BIOS password. See section 1.2.6 Onboard switches and buttons for information on how to erase the RTC RAM via the Clear CMOS button.
- The Administrator or User Password items on top of the screen show the default [Not Installed]. After you set a password, these items show [Installed].

Administrator Password

If you have set an administrator password, we recommend that you enter the administrator password for accessing the system. Otherwise, you might be able to see or change only selected fields in the BIOS setup program.

To set an administrator password:

1. Select the **Administrator Password** item and press <Enter>.
2. From the **Create New Password** box, key in a password, then press <Enter>.
3. Confirm the password when prompted.

To change an administrator password:

1. Select the **Administrator Password** item and press <Enter>.
2. From the **Enter Current Password** box, key in the current password, then press <Enter>.
3. From the **Create New Password** box, key in a new password, then press <Enter>.
4. Confirm the password when prompted.

To clear the administrator password, follow the same steps as in changing an administrator password, but press <Enter> when prompted to create/confirm the password. After you clear the password, the **Administrator Password** item on top of the screen shows **Not Installed**.

User Password

If you have set a user password, you must enter the user password for accessing the system. The User Password item on top of the screen shows the default Not Installed. After you set a password, this item shows Installed.

To set a user password:

1. Select the **User Password** item and press <Enter>.
2. From the **Create New Password** box, key in a password, then press <Enter>.
3. Confirm the password when prompted.

To change a user password:

1. Select the **User Password** item and press <Enter>.
2. From the **Enter Current Password** box, key in the current password, then press <Enter>.
3. From the **Create New Password** box, key in a new password, then press <Enter>.
4. Confirm the password when prompted.

To clear the user password, follow the same steps as in changing a user password, but press <Enter> when prompted to create/confirm the password. After you clear the password, the **User Password** item on top of the screen shows **Not Installed**.

3.4 Ai Tweaker menu

The Ai Tweaker menu items allow you to configure overclocking-related items.



Be cautious when changing the settings of the Ai Tweaker menu items. Incorrect field values can cause the system to malfunction.



The configuration options for this section vary depending on the CPU and DIMM model you installed on the motherboard.



Scroll down to display the following items.



Scroll down to display the following items.



Current CPU Speed: xxxxMHz

Displays the current CPU speed.

Target CPU Speed: xxxxMHz

Displays the target CPU speed.

Current Memory Frequency: xxxxMHz

Displays the current memory frequency.

Current NB Frequency: xxxxMHz

Displays the current NB frequency.

Current HT Link Speed: xxxxMHz

Displays the current HT Link speed.

3.4.1 Ai Overclock Tuner [Auto]

Allows you to select the CPU overclocking options to achieve the desired CPU internal frequency. Select any of these preset overclocking configuration options:

- [Auto] Loads the optimal settings for the system.
- [Manual] Allows you to individually set overclocking parameters.
- [D.O.C.P.] Allows you to select a DRAM O.C. profile, and the related parameters will be adjusted automatically.

CPU Bus Frequency [XXX]

This item appears only when you set the **Ai Overclock Tuner** item to [Manual] or [D.O.C.P.] and allows you to adjust the CPU and VGA frequency to enhance the system performance. Use the <+> and <-> keys to adjust the value. You can also key in the desired value using the numeric keypad. The values range from 100.0MHz to 600.0MHz.

PCIe Frequency [Auto]

This item appears only when you set the **Ai Overclock Tuner** item to [Manual] or [D.O.C.P.] and allows you to adjust PCIe frequency to enhance the system performance. Use the <+> and <-> keys to adjust the value. You can also key in the desired value using the numeric keypad. The values range from 100.0MHz to 150.0MHz.

DRAM O.C. Profile [DDR3-1600MHz]

This item appears only when you set the **Ai Overclock Tuner** item to [D.O.C.P.] and allows you to select a DRAM O.C. profile, which applies different settings to DRAM frequency, DRAM timing and DRAM voltage. Configuration options: [DDR3-1600MHz] [DDR3-1800MHz] [DDR3-1866MHz] [DDR3-2000MHz] [DDR3-2133MHz] [DDR3-2200MHz] [DDR3-2400MHz]

3.4.2 OC Tuner [CANCEL]

OC Tuner utility automatically overclocks the frequency and voltage of the CPU and DRAM. Press <Enter> to start auto tuning. It takes around five minutes, and the system will reboot for several times until auto tuning is completed. Configuration options: [CANCEL] [OK]



The configuration options for the following sub-items vary depending on the CPU/DIMMs you install on the motherboard.

3.4.3 CPU Ratio [Auto]

Allows user can manually adjust the maximum non-CPB mode CPU ratio. The value will be limit to CPU base or factory setting. Use the <+> and <-> keys to adjust the ratio. The valid value ranges vary according to your CPU model.

3.4.4 AMD Turbo CORE technology [Auto]

Allows you to enable or disable AMD Turbo CORE technology. Configuration options: [Auto] [Disabled] [Enabled]

3.4.5 Memory Frequency [Auto]

Allows you to set the memory operating frequency.

Configuration options: [Auto] [DDR3-800MHz] [DDR3-1066MHz] [DDR3-1333MHz] [DDR3-1600MHz] [DDR3-1866MHz] [DDR3-2133MHz] [DDR3-2400MHz]



Selecting a very high memory frequency may cause the system to become unstable! If this happens, revert to the default setting.

3.4.6 CPU/NB Frequency [Auto]

Allows you to set the ratio between the NB (in CPU) Clock and the CPU Bus Frequency.
Configuration options: [Auto] [1400MHz] [1600MHz] [1800MHz] [2000MHz]

3.4.7 HT Link Speed [Auto]

Allows you to select the HyperTransport link speed. Configuration options: [Auto] [800MHz] [1000MHz] [1200MHz] [1400MHz] [1600MHz] [1800MHz] [2000MHz] [2200MHz] [2400MHz]

3.4.8 CPU Spread Spectrum [Auto]

[Auto] Automatic configuration.
[Disabled] Enhances the BCLK overclocking ability.
[Enabled] Sets to [Enabled] for EMI control.

3.4.9 PCIe Spread Spectrum [Auto]

[Auto] Automatic configuration.
[Disabled] Enhances the PCIE overclocking ability.
[Enabled] Sets to [Enabled] for EMI control.

3.4.10 EPU Power Saving Mode [Disabled]

Allows you to enable or disable the EPU power saving function.
Configuration options: [Disabled] [Enabled]

EPU Setting [Auto]

This item appears only when The EPU Power Saving Mode is set to [Enabled] and allows you to set power saving mode. Configuration options: [Auto] [Light Power Saving Mode] [Medium Power Saving Mode] [Max Power Saving Mode]

3.4.11 DRAM Timing Control

The sub-items in this menu allow you to set the DRAM timing control features. Use the <+> and <-> keys to adjust the value. To restore the default setting, type [auto] using the keyboard and press <Enter>.



Changing the values in this menu may cause the system to become unstable! If this happens, revert to the default settings.

3.4.12 DRAM Driving Control

The sub-items in this menu allow you to set the DRAM driving control features. Use the <+> and <-> keys to adjust the value. To restore the default setting, type [auto] using the keyboard and press <Enter>.



Changing the values in this menu may cause the system to become unstable! If this happens, revert to the default settings.

3.4.13 DIGI+ Power Control

CPU Load-Line Calibration [Auto]

Load-line is defined by AMD VRM spec and affects CPU voltage. The CPU working voltage will decrease proportionally to CPU loading. Higher value gets a higher voltage and better overclocking performance, but increases the CPU and VRM thermal. This item allows you to enable or disable the CPU Load-Line Calibration function. Configuration options: [Auto] [Disabled] [Enabled]

CPU/NB Load-Line Calibration [Auto]

This item allows you to enable or disable the CPU/NB Load-Line Calibration function. Configuration options: [Auto] [Disabled] [Enabled]

3.4.14 CPU & NB Voltage [Offset Mode]

Allows you to set the CPU & NB Voltage Mode. Different sub-items appear according to the **CPU & NB Voltage Mode** item setting. Configuration options: [Offset Mode] [Manual Mode]

Offset Mode Sign [+]

This item appears only when you set the **CPU & NB Voltage** item to [Offset Mode] and allows you to set the offset mode sign. Configuration options: [+] [-]

CPU Offset Voltage [Auto]

This item appears only when you set the **CPU & NB Voltage** item to [Offset Mode] and allows you to set the CPU Offset voltage. The values vary with your CPU type with a 0.006250V interval.

CPU/NB Offset Mode Sign [+]

This item appears only when you set the **CPU & NB Voltage** item to [Offset Mode] and allows you to set the offset mode sign. Configuration options: [+] [-]

CPU/NB Offset Voltage [Auto]

This item appears only when you set the **CPU & NB Voltage Mode** item to [Offset Mode] and allows you to set the CPU/NB Offset voltage. The values vary with your CPU type with a 0.00625V interval.

CPU Manual Voltage [Auto]

This item appears only when you set the **CPU & NB Voltage** item to [Manual Mode] and allows you to set a fixed CPU voltage.

CPU/NB Manual Voltage [Auto]

This item appears only when you set the **CPU & NB Voltage** item to [Manual Mode] and allows you to set a fixed CPU/NB voltage.

3.4.15 CPU VDDA Voltage [Auto]

Allows you to set the CPU VDDA voltage. The values range from 2.200000V to 2.800000V with a 0.006250V interval.

3.4.16 DRAM Voltage [Auto]

Allows you to set the DRAM voltage. The values range from 1.200000V to 2.500000V with a 0.006250V interval.

3.4.17 NB Voltage [Auto]

Allows you to set the Northbridge voltage. The values range from 1.100000V to 1.250000V with a 0.006250V interval.

3.4.18 NB HT Voltage [Auto]

Allows you to set the Northbridge HyperTransport voltage. The values range from 1.200000V to 1.400000V with a 0.006250V interval.

3.4.19 NB 1.8V Voltage [Auto]

Allows you to set the Northbridge 1.8V voltage. The values range from 1.800000V to 2.100000V with a 0.005000V interval.

3.4.20 SB Voltage [Auto]

Allows you to set the Southbridge voltage. The values range from 1.1000000V to 1.8000000V with a 0.005000V interval.

3.5 Advanced menu

The Advanced menu items allow you to change the settings for the CPU and other system devices.



Be cautious when changing the settings of the Advanced menu items. Incorrect field values can cause the system to malfunction.



3.5.1 CPU Configuration

The items in this menu show the CPU-related information that the BIOS automatically detects.



The items shown in submenu may be different due to the CPU you installed.

Cool'n'Quiet [Disabled]

[Enabled] Enables the AMD Cool'n'Quiet function.

[Disabled] Disables this function.

C1E Support [Disabled]

[Auto] Allows automatic selection of C1E support function.

[Disabled] Disables this function.

SVM [Enabled]

[Enabled] Enables the AMD Secure Virtual Machine mode.
[Disabled] Disables this function.

Core C6 State [Enabled]

Enables or disables Core C6 state function. Configuration options: [Disabled] [Enabled]

HPC Mode [Enabled]

Allows you to disable or enable High Performance Computing Mode. Configuration options: [Enabled] [Disabled]

Apm Master Mode [Auto]

Enables or disables Application Power Management. Configuration options: [Disabled] [Enabled]

3.5.2 North Bridge

IOMMU [Disabled]

Allows you to disable or enable the IOMMU. IOMMU is supported on Linux based systems to convert 32bit I/O to 64bit MMIO. Configuration options: [Disabled] [Enabled]

Memory Configuration

Allows you to set the related memory configurations.

Bank Interleaving [Auto]

Allows you to enable the bank memory interleaving. Configuration options: [Auto] [Disabled]

Channel Interleaving [Auto]

Allows you to enable the channel memory interleaving. Configuration options: [Disabled] [Auto]

ECC Mode [Enabled]

Allows you to enable or disable the ECC mode. Configuration options: [Disabled] [Enabled]

Power Down Enable [Disabled]

Allows you to enable or disable the DDR power down mode. Configuration options: [Disabled] [Enabled]

Memory Hole Remapping [Enabled]

Allows you to enable or disable memory remapping around memory hole. Configuration options: [Disabled] [Enabled]

DCT Unganged Mode [Enabled]

Allows you to select unganged mode or ganged mode. Configuration options: [Disabled] [Enabled]

Initiate Graphic Adapter [PEG/PCI]

Allows you to select the primary boot graphic controller. Configuration options: [PEG/PCI] [PCI/PEG]

3.5.3 South Bridge

HPET [Enabled]

Allows you to disable or enable the HPET timer. Configuration options: [Disabled] [Enabled]

3.5.4 SATA Configuration

While entering Setup, the BIOS automatically detects the presence of SATA devices. The SATA Port items show **Not Present** if no SATA device is installed to the corresponding SATA port.

SB SATA Configuration

Allows you to set SATA options.

OnChip SATA Channel [Enabled]

Allows you to enable or disable serial ATA. Configuration options: [Enabled] [Disabled]



The following items appear only when the above item is set to [Enabled].

SATA Port1 - Port4 [AHCI]

[IDE] Set to [IDE] when you want to use the Serial ATA hard disk drives as Parallel ATA physical storage devices.

[AHCI] Set to [AHCI] when you want the SATA hard disk drives to use the AHCI (Advanced Host Controller Interface). The AHCI allows the onboard storage driver to enable advanced Serial ATA features that increases storage performance on random workloads by allowing the drive to internally optimize the order of commands.

[RAID] Set to [RAID] when you want to create a RAID configuration from the SATA hard disk drives.

SATA Port5 - Port6 [AHCI]

Allows you to set the SATA port 5~6 mode. This item can only be configured as [IDE] when **SATA Port1 - Port4** is set to [IDE]. Configuration options: [AHCI] [IDE]



- When the **SATA Port1–Port 4** and the **SATA Port5–Port 6** items are set to [AHCI], the information of the SATA connectors 1–6 can be seen only under the OS environment or during POST.
 - For Windows® XP OS, you have to install the AHCI driver, so that you could use the SATA connectors 1–6 in AHCI mode under the OS environment.
-



If you use a SATA optical drive to run the Windows XP OS installation disk, we strongly recommend that you install the optical drive to the SATA connectors 5/6 and set them to [IDE] mode.

Board SATA RAID ROM [Legacy ROM]

This item appears only when you set **SATA Port1 - Port4** to [RAID] and allows you to select Board SATA RAID ROM. Configuration options: [Disabled] [Legacy ROM] [UEFI DRIVER]

S.M.A.R.T. Status Check [Enabled]

- [Enabled] Enables the S.M.A.R.T. feature.
[Disabled] Disables the S.M.A.R.T. feature.

SATA ESP on PORT1 ~ 6 [Disabled]

Configuration options: [Enabled] [Disabled]

3.5.5 USB Configuration

The items in this menu allow you to change the USB-related features.



The **USB Devices** item shows the auto-detected values. If no USB device is detected, the item shows None.

Legacy USB Support [Enabled]

- [Enabled] Enables the support for USB devices on legacy operating systems (OS).
[Disabled] The USB devices can be used only for the BIOS setup program.
[Auto] Allows the system to detect the presence of USB devices at startup. If detected, the USB controller legacy mode is enabled. If no USB device is detected, the legacy USB support is disabled.

Legacy USB3.0 Support [Enabled]

This item appears only when you set the previous item to [Enabled].

- [Enabled] Enables the support for USB 3.0 devices on legacy operating systems (OS).
[Disabled] Disables the function.

EHCI Hand-off [Disabled]

- [Enabled] Enables the support for operating systems without an EHCI hand-off feature.
[Disabled] Disables the function.

SB USB Configuration

Options for SB USB Configuration.

OHCI HC (Bus 0 Dev 18 Fn 0) [Enabled]

Configuration options: [Enabled] [Disabled]

OHCI HC (Bus 0 Dev 19 Fn 0) [Enabled]

Configuration options: [Enabled] [Disabled]

OHCI HC (Bus 0 Dev 22Fn 0) [Enabled]

Configuration options: [Enabled] [Disabled]

OHCI HC (Bus 0 Dev 20 Fn 5) [Enabled]

Configuration options: [Enabled] [Disabled]

USB PORT 1 ~ 14 [Enabled]

Configuration options: [Enabled] [Disabled]

3.5.6 CPU Core On/Off Function

CPU Core Activation [Auto]

This item lets user turn off cores except core 1, user can turn off 2nd, 3rd, 4th, 5th, etc core manually. Configuration options: [Auto] [Manual]



The following items appear only when you set the previous item to [Manual]

3rd & 4th Core [Enabled]

Configuration options: [Enabled] [Disabled]

3.5.7 Onboard Devices Configuration

Asmedia USB 3.0 Controller (Rear) [Enabled]

[Enabled] Enables the rear USB 3.0 controller.

[Disabled] Disables the controller.

Asmedia USB 3.0 Controller (Front) [Enabled]

[Enabled] Enables the front USB 3.0 controller.

[Disabled] Disables the controller.

Asmedia USB 3.0 Battery Charging Support [Disabled]

This item appears only when the **Asmedia USB 3.0 Controller (Rear)** or **Asmedia USB 3.0 Controller (Front)** is set to [Enabled].

[Enabled] Enables the Asmedia USB 3.0 battery charging function.

[Disabled] Disables this function

Realtek LAN Controller [Enabled]

[Enabled] Enables the Realtek LAN controller.

[Disabled] Disables the controller.

Realtek PXE OPROM [Disabled]

This item appears only when you set the Realtek LAN Controller item to [Enabled] and allows you to enable or disable the Rom Help of the Realtek LAN controller.

Configuration options: [Enabled] [Disabled]

Serial Port Configuration

The sub-items in this menu allow you to set the serial port configuration.

Serial Port [Enabled]

Allows you to enable or disable the serial port (COM).

Configuration options: [Enabled] [Disabled]

Change Settings [IO=3F8h; IRQ=4]

This item appears only when you set the previous item to [Enabled] and allows you to select the Serial Port base address.

Configuration options: [IO=3F8h; IRQ=4] [IO=2F8h; IRQ=3] [IO=3E8h; IRQ=4]
[IO=2E8h; IRQ=3]

SB HD Azalia Configuration

Allows you to change the HD Azalia configuration.

[Enabled] Enables the High Definition Audio Azalia device.

[Disabled] Disables the device.



The following two items appear only when you set the **HD Audio Azalia Device** item to [Enabled].

Azalia Front Panel [HD]

Allows you to set the Azalia front panel audio connector (AAFP) type to legacy AC'97 or high-definition audio depending on the audio standard that the front panel audio module supports.

[HD] Sets the front panel audio connector (AAFP) mode to high definition audio.

[AC97] Sets the front panel audio connector (AAFP) mode to legacy AC'97

SPDIF Out Type [SPDIF]

[SPDIF] Sets to [SPDIF] for SPDIF audio output.

[HDMI] Sets to [HDMI] for HDMI audio output.

3.5.8 APM

ErP Ready [Enabled]

Allows the BIOS to switch off some power at S5 to get the system ready for ErP requirement. When this item is set to [Enabled], all other PME options will be switched off. Configuration options: [Enabled] [Disabled]



The following items appear only when you set the **ErP Ready** to [Disabled].

Restore AC Power Loss [Power Off]

[Power On] The system goes into on state after an AC power loss.

[Power Off] The system goes into off state after an AC power loss.

[Last State] The system goes into either off or on state, whatever the system state was before the AC power loss.

Power On By PS/2 Device [Disabled]

Allows you to use PS/2 device to turn on the system. This feature requires an ATX power supply that provides at least 1A on the +5VSB lead. Configuration options: [Disabled] [Enabled]

Power On By PME [Disabled]

[Disabled] Disables the PME to wake up by PCI/PCIE devices.

[Enabled] Allows you to turn on the system through a PCI/PCIE LAN or modem card. This feature requires an ATX power supply that provides at least 1A on the +5VSB lead.

Power On By Ring [Disabled]

[Disabled] Disables Ring to generate a wake event.

[Enabled] Enables Ring to generate a wake event.

Power On By RTC [Disabled]

[Disabled] Disables RTC to generate a wake event.

[Enabled] When set to [Enabled], the items RTC Alarm Date (Days) and Hour/Minute/Second will become user-configurable with set values.

3.5.9 Network Stack

Network Stack [Disable Link]

This item allows user to disable or enable the UEFI network stack.

Configuration options: [Disable Link] [Enabled]

Ipv4 PXE Support [Enabled]

This item appears only when you set the Network Stack item to [Enabled]. When this item is disabled, the IPV4 PXE boot option will not be created.

Configuration options: [Disabled] [Enabled]

Ipv6 PXE Support [Enabled]

This item appears only when you set the Network Stack item to [Enabled]. When this item is disabled, the IPV6 PXE boot option will not be created.

Configuration options: [Disabled] [Enabled]

3.6 Monitor menu

The Monitor menu displays the system temperature/power status, and allows you to change the fan settings.



Scroll down to display the other BIOS items.

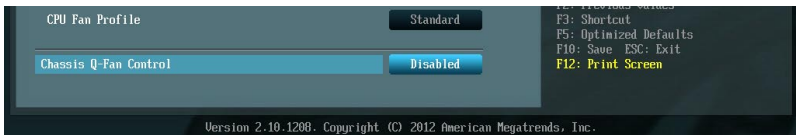

3.6.1 CPU Temperature / MB Temperature [xxx°C/xxx°F]

The onboard hardware monitor automatically detects and displays the CPU and motherboard temperatures. Select **Ignore** if you do not wish to display the detected temperatures.

3.6.2 VCORE Voltage, 3.3V Voltage, 5V Voltage, 12V Voltage, VDDA2.5V Voltage

The onboard hardware monitor automatically detects the voltage output through the onboard voltage regulators. Select **Ignore** if you do not want to detect this item.

3.6.3 CPU_FAN Speed [xxxx RPM] or [Ignore] / [N/A]

CHA_FAN1/2/3 Speed [xxxx RPM] or [Ignore] / [N/A]

The onboard hardware monitor automatically detects and displays the CPU and chassis fan speeds in rotations per minute (RPM). If the fan is not connected to the motherboard, the field shows **N/A**. Select **Ignore** if you do not wish to display the detected speed.

3.6.4 CPU Q-Fan Control [Enabled]

[Disabled] Disables the CPU Q-Fan control feature.

[Enabled] Enables the CPU Q-Fan control feature.

CPU_FAN Speed Low Limit [600 RPM]

This item appears only when you enable the **CPU Q-Fan Control** feature and allows you to disable or set the CPU fan warning speed. Configuration options: [Ignore] [100 RPM] [200 RPM] [300 RPM] [400 RPM] [500 RPM] [600 RPM]

CPU Fan Profile [Standard]

This item appears only when you enable the CPU Q-Fan Control feature and allows you to set the appropriate performance level of the CPU fan.

[Standard] Sets to [Standard] to make the CPU fan automatically adjust depending on the CPU temperature.

[Silent] Sets to [Silent] to minimize the fan speed for quiet CPU fan operation.

[Turbo] Sets to [Turbo] to achieve maximum CPU fan speed.

[Manual] Sets to [Manual] to assign detailed fan speed control parameters.



The following four items appear only when you set CPU Fan Profile to [Manual].

CPU Upper Temperature [70]

Use the <+> and <-> keys to adjust the upper limit of the CPU temperature. The values range from 20°C to 75°C.

CPU Lower Temperature [20]

Displays the lower limit of the CPU temperature.

CPU Fan Max. Duty Cycle(%) [100]

Use the <+> and <-> keys to adjust the maximum CPU fan duty cycle. The values range from 20% to 100%. When the CPU temperature reaches the upper limit, the CPU fan will operate at the maximum duty cycle.

CPU Fan Min. Duty Cycle(%) [30]

Use the <+> and <-> keys to adjust the minimum CPU fan duty cycle. The values range from 0% to 100%. When the CPU temperature is under 40°C, the CPU fan will operate at the minimum duty cycle.

3.6.5 Chassis Q-Fan Control [Disabled]

[Disabled] Disables the Chassis Q-Fan control feature.

[Enabled] Enables the Chassis Q-Fan control feature.

Chassis Fan Speed Low Limit [600 RPM]

This item appears only when you enable the **Chassis Q-Fan Control** feature and allows you to disable or set the chassis fan warning speed. Configuration options: [Ignore] [100 RPM] [200 RPM] [300 RPM] [400 RPM] [500 RPM] [600 RPM]

Chassis Fan Profile [Standard]

This item appears only when you enable the **Chassis Q-Fan Control** feature and allows you to set the appropriate performance level of the chassis fan.

[Standard] Sets to [Standard] to make the chassis fan automatically adjust depending on the chassis temperature.

[Silent] Sets to [Silent] to minimize the fan speed for quiet chassis fan operation.

[Turbo] Sets to [Turbo] to achieve maximum chassis fan speed.

[Manual] Sets to [Manual] to assign detailed fan speed control parameters.



The following four items appear only when you set **Chassis Fan Profile** to [Manual].

Chassis Upper Temperature [70]

Use the <+> and <-> keys to adjust the upper limit of the chassis temperature. The values range from 40°C to 90°C.

Chassis Lower Temperature [40]

Displays the lower limit of the chassis temperature.

Chassis Fan Max. Duty Cycle(%) [60]

Use the <+> and <-> keys to adjust the maximum chassis fan duty cycle. The values range from 60% to 100%. When the chassis temperature reaches the upper limit, the chassis fan will operate at the maximum duty cycle.

Chassis Fan Min. Duty Cycle(%) [60]

Use the <+> and <-> keys to adjust the minimum chassis fan duty cycle. The values range from 60% to 100%. When the chassis temperature is under 40°C, the chassis fan will operate at the minimum duty cycle.

3.7 Boot menu

The Boot menu items allow you to change the system boot options.



3.7.1 Bootup NumLock State [On]

[On] Sets the power-on state of the NumLock to [On].

[Off] Sets the power-on state of the NumLock to [Off].

3.7.2 Full Screen Logo [Enabled]

[Enabled] Enables the full screen logo display feature.

[Disabled] Disables the full screen logo display feature.



Set this item to [Enabled] to use the ASUS MyLogo 2™ feature.

Post Report [5 sec]

This item appears only when the Full Screen Logo item is set to [Disabled] and allows you to set the waiting time for the system to display the post report. Configuration options: [1 sec] [2 sec] [3 sec] [4 sec] [5 sec] [6 sec] [7 sec] [8 sec] [9 sec] [10 sec] [Until Press ESC]

3.7.3 Wait for 'F1' If Error [Enabled]

When this item is set to [Enabled], the system waits for the F1 key to be pressed when error occurs. Configuration options: [Disabled] [Enabled]

3.7.4 DirectKey Enabled [Go to BIOS...]

[Go to BIOS Setup] Allows the system to power on and go to BIOS setup directly when you press the DirectKey button.

[Disabled] Disables the DirectKey function.

3.7.5 Option ROM Messages [Force BIOS]

[Force BIOS] The third-party ROM messages will be forced to display during the boot sequence.

[Keep Current] The third-party ROM messages will be displayed only if the third-party manufacturer had set the add-on device to do so.

3.7.6 INT19 Trap Response [Immediate]

[Immediate] Allows Option ROMs to trap interrupt 19 right away.

[Postponed] Allows Option ROMs to trap interrupt 19 during legacy boot.

3.7.7 Setup Mode [EZ Mode]

[Advanced Mode] Sets Advanced Mode as the default screen for entering the BIOS setup program.

[EZ Mode] Sets EZ Mode as the default screen for entering the BIOS setup program.

3.7.8 Boot Option Priorities

These items specify the boot device priority sequence from the available devices. The number of device items that appears on the screen depends on the number of devices installed in the system.



- To select the boot device during system startup, press <F8> when ASUS Logo appears.
- To access Windows OS in Safe Mode, press <F8> after POST.

3.7.9 Boot Override

These items displays the available devices. The number of device items that appears on the screen depends on the number of devices installed in the system. Click an item to start booting from the selected device.

3.8 Tools menu

The Tools menu items allow you to configure options for special functions. Select an item then press <Enter> to display the submenu.

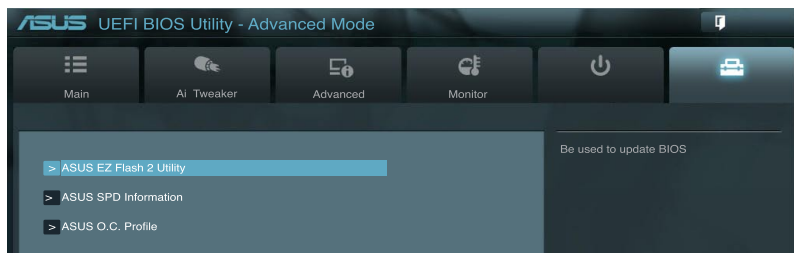

3.8.1 ASUS EZ Flash 2 Utility

Allows you to run ASUS EZ Flash 2. Press [Enter] to launch the ASUS EZ Flash 2 screen.



For more details, see section 3.10.2 **ASUS EZ Flash 2**.

3.8.2 ASUS SPD Information

DIMM Slot # [Slot 1]

Displays the Serial Presence Detect (SPD) information of the DIMM module installed on the selected slot. Configuration options: [Slot 1] [Slot 2] [Slot 3] [Slot 4]

3.8.3 ASUS O.C. Profile

This item allows you to store or load multiple BIOS settings.



The **Setup Profile Status** items show **Not Installed** if no profile is created.

Save to Profile

Allows you to save the current BIOS settings to the BIOS Flash, and create a profile. Key in a profile number from one to eight, press <Enter>, and then select **Yes**.

Load from Profile

Allows you to load the previous BIOS settings saved in the BIOS Flash. Key in the profile number that saved your CMOS settings, press <Enter>, and then select **Yes**.



-
- DO NOT shut down or reset the system while updating the BIOS to prevent the system boot failure!
 - We recommend that you update the BIOS file only coming from the same memory/CPU configuration and BIOS version.
-

3.9 Exit menu

The Exit menu items allow you to load the optimal default values for the BIOS items, and save or discard your changes to the BIOS items. You can access the **EZ Mode** from the Exit menu.

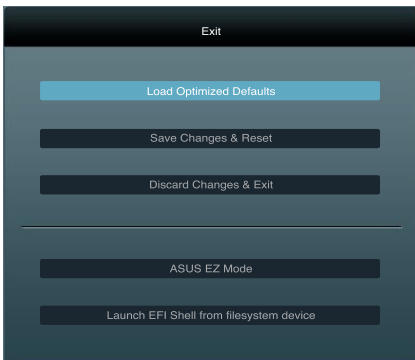

Load Optimized Defaults

This option allows you to load the default values for each of the parameters on the Setup menus. When you select this option or if you press <F5>, a confirmation window appears. Select Yes to load the default values.

Save Changes & Reset

Once you are finished making your selections, choose this option from the Exit menu to ensure the values you selected are saved. When you select this option or if you press <F10>, a confirmation window appears. Select Yes to save changes and exit.

Discard Changes & Exit

This option allows you to exit the Setup program without saving your changes. When you select this option or if you press <Esc>, a confirmation window appears. Select Yes to discard changes and exit.

ASUS EZ Mode

This option allows you to enter the EZ Mode screen.

Launch EFI Shell from filesystem device

This option allows you to attempt to launch the UEFI Shell application (shellx64.efi) from one of the available devices that have a filesystem.

3.10 Updating BIOS

The ASUS website publishes the latest BIOS versions to provide enhancements on system stability, compatibility, or performance. However, BIOS updating is potentially risky. If there is no problem using the current version of BIOS, DO NOT manually update the BIOS. Inappropriate BIOS updating may result in the system's failure to boot. Carefully follow the instructions of this chapter to update your BIOS if necessary.



Visit the ASUS website (www.asus.com) to download the latest BIOS file for this motherboard.

The following utilities allow you to manage and update the motherboard BIOS setup program.

1. **ASUS Update:** Updates the BIOS in Windows® environment.
2. **ASUS EZ Flash 2:** Updates the BIOS using a USB flash drive.
3. **ASUS BIOS Updater:** Updates and back ups the BIOS in DOS environment using the motherboard support DVD and a USB flash disk drive.



Save a copy of the original motherboard BIOS file to a USB flash disk in case you need to restore the BIOS in the future. Copy the original motherboard BIOS using the ASUS Update or BIOS Updater utilities.

3.10.1 ASUS Update

The ASUS Update is a utility that allows you to manage, save, and update the motherboard BIOS in Windows® environment.



-
- **ASUS Update requires an Internet connection either through a network or an Internet Service Provider (ISP).**
 - **This utility is available in the support DVD that comes with the motherboard package.**
-

Launching ASUS Update

To launch ASUS Update, click **Update > ASUS Update** on the AI Suite II main menu bar.



Quit all Windows® applications before you update the BIOS using this utility.

Updating the BIOS through the Internet

To update the BIOS through the Internet:

1. From the ASUS Update screen, select **Update BIOS from Internet**, and then click **Next**.



2. Select the ASUS FTP site nearest you to avoid network traffic.

If you want to enable the BIOS downgrade and auto backup functions, tick **Enable BIOS downgrade** and click **Next**.

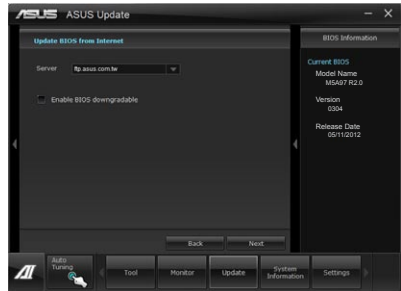

3. Select the BIOS version that you want to download. Click **Next**.

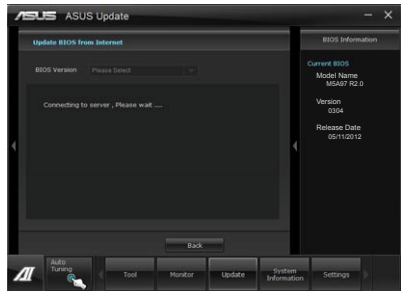

Updating the BIOS through a BIOS file

To update the BIOS through a BIOS file:

1. From the ASUS Update screen, select **Update BIOS from file**, and then click **Next**.

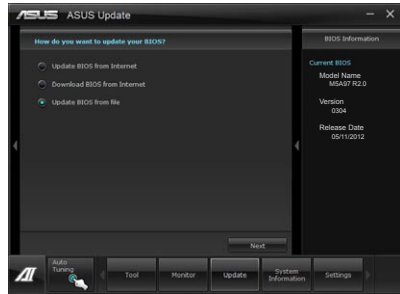

2. Locate the BIOS file and click **Next**.

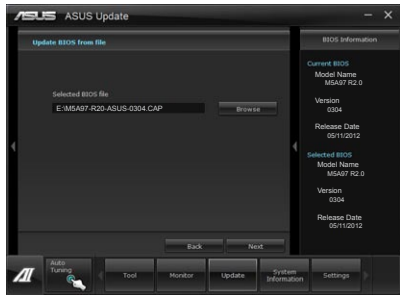

3. You can decide whether to change the BIOS boot logo. Click **Yes** if you want to change the boot logo or **No** to continue.
4. Follow the onscreen instructions to complete the update process.



- The screenshots in this section are for reference only. The actual BIOS information vary by models.
- Refer to the software manual in the support DVD or visit the ASUS website at www.asus.com for detailed software configuration.

3.10.2 ASUS EZ Flash 2

ASUS EZ Flash 2 allows you to update the BIOS without having to use a bootable floppy disk or an OS-based utility.



Before you start using this utility, download the latest BIOS from the ASUS website at www.asus.com.

To update the BIOS using EZ Flash 2:

1. Insert the USB flash disk that contains the latest BIOS file to the USB port.
2. Enter the Advanced Mode of the BIOS setup program. Go to the Tool menu to select ASUS EZ Flash Utility and press <Enter> to enable it.

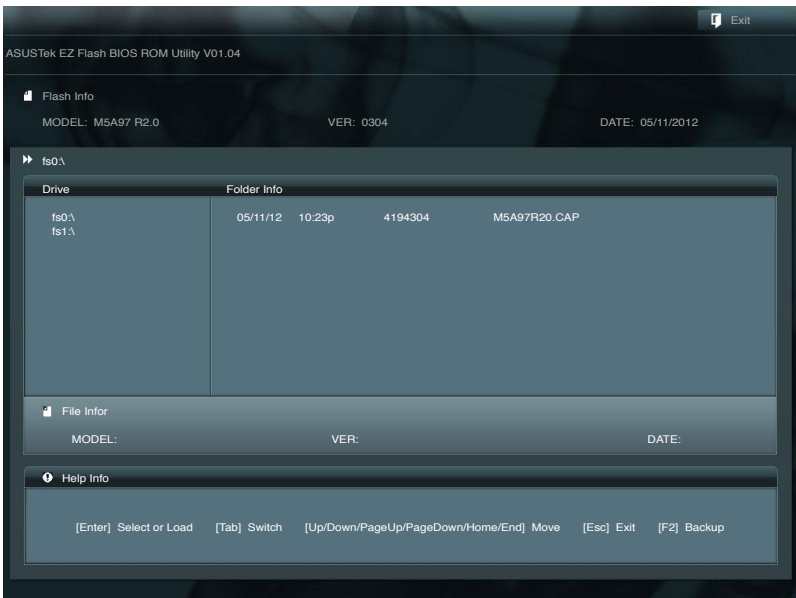

3. Press <Tab> to switch to the Drive field.
4. Press the Up/Down arrow keys to find the USB flash disk that contains the latest BIOS, and then press <Enter>.
5. Press <Tab> to switch to the Folder Info field.
6. Press the Up/Down arrow keys to find the BIOS file, and then press <Enter> to perform the BIOS update process. Reboot the system when the update process is done.



-
- This function can support devices such as a USB flash disk with FAT 32/16 format and single partition only.
 - DO NOT shut down or reset the system while updating the BIOS to prevent system boot failure!
-



Ensure to load the BIOS default settings to ensure system compatibility and stability. Select the Load Optimized Defaults item under the Exit menu. See section **3.9 Exit Menu** for details.

3.10.3 ASUS BIOS Updater

The ASUS BIOS Updater allows you to update the BIOS in DOS environment. This utility also allows you to copy the current BIOS file that you can use as a backup when the BIOS fails or gets corrupted during the updating process.



The succeeding utility screens are for reference only. The actual utility screen displays may not be same as shown.

Before updating BIOS

1. Prepare the motherboard support DVD and a USB flash drive in FAT32/16 format and single partition.
2. Download the latest BIOS file and BIOS Updater from the ASUS website at <http://support.asus.com> and save them on the USB flash drive.



- NTFS is not supported under DOS environment. DO NOT save the BIOS file and BIOS Updater to a hard disk drive or USB flash drive in NTFS format.
 - DO NOT save the BIOS file to a floppy disk due to low disk capacity.
-

3. Turn off the computer and disconnect all SATA hard disk drives (optional).

Booting the system in DOS environment

1. Insert the USB flash drive with the latest BIOS file and BIOS Updater to the USB port.
2. Boot your computer. When the ASUS Logo appears, press <F8> to show the BIOS Boot Device Select Menu. Insert the support DVD into the optical drive and select the optical drive as the boot device.

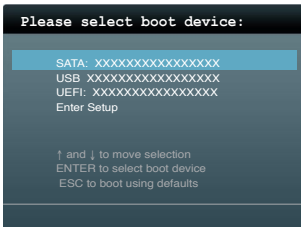

- When the Make Disk menu appears, select the FreeDOS command prompt item by pressing the item number.
- At the FreeDOS prompt, type `d:` and press `<Enter>` to switch the disk from Drive C (optical drive) to Drive D (USB flash drive).

```

Welcome to FreeDOS (http://www.freedos.org) !
C: \>d:
D: \>

```

Backing up the current BIOS

To backup the current BIOS file using the BIOS Updater



Ensure that the USB flash drive is not write-protected and has enough free space to save the file.

- At the FreeDOS prompt, type `bupdater /o[filename]` and press `<Enter>`.

```

D: \>bupdater /oOLDBIOS1.rom

```

Filename
Extension

The [filename] is any user-assigned filename with no more than eight alphanumeric characters for the filename and three alphanumeric characters for the extension.

- The BIOS Updater backup screen appears indicating the BIOS backup process. When BIOS backup is done, press any key to return to the DOS prompt.

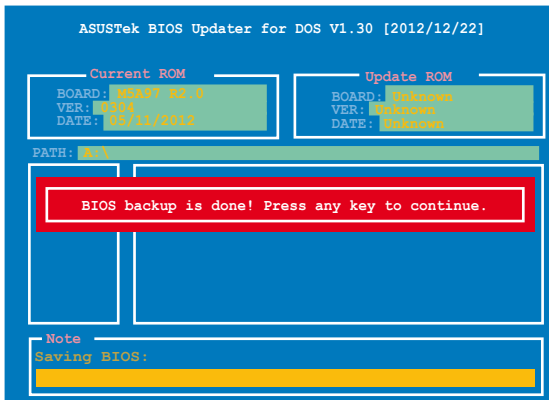

Updating the BIOS file

To update the BIOS file using BIOS Updater:

1. At the FreeDOS prompt, type `bupdater /pc /g` and press <Enter>.

```
D:\>bupdater /pc /g
```

2. The BIOS Updater screen appears as below.

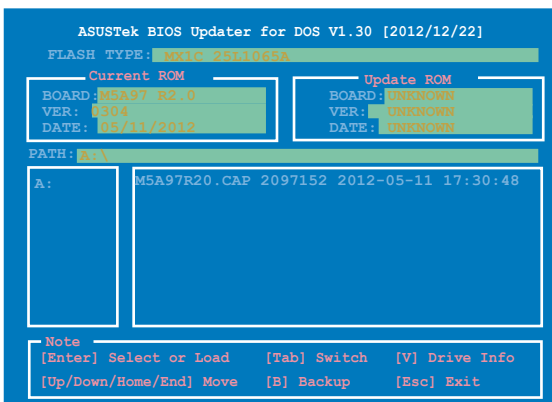

3. Press <Tab> to switch between screen fields and use the <Up/Down/Home/End> keys to select the BIOS file and press <Enter>. BIOS Updater checks the selected BIOS file and prompts you to confirm BIOS update.



4. Select Yes and press <Enter>. When BIOS update is done, press <ESC> to exit BIOS Updater. Restart your computer.



DO NOT shut down or reset the system while updating the BIOS to prevent system boot failure!



- For BIOS Updater version 1.04 or later, the utility automatically exits to the DOS prompt after updating BIOS.
- Ensure to load the BIOS default settings to ensure system compatibility and stability. Select the **Load Optimized Defaults** item under the **Exit BIOS** menu. See Chapter 3 of your motherboard user manual for details.
- Ensure to connect all SATA hard disk drives after updating the BIOS file if you have disconnected them.

Software support

4

4.1 Installing an operating system

This motherboard supports Windows® XP/ 64-bit XP/ Vista / 64-bit Vista / 7 / 64-bit 7 operating systems (OS). Always install the latest OS version and corresponding updates to maximize the features of your hardware.



- Motherboard settings and hardware options vary. Use the setup procedures presented in this chapter for reference only. Refer to your OS documentation for detailed information.
- Ensure that you install the Windows® XP Service Pack 3 or later versions before installing the drivers for better compatibility and system stability.

4.2 Support DVD information



The contents of the support DVD are subject to change at any time without notice. Visit the ASUS website at www.asus.com for updates.

4.2.1 Running the support DVD

Place the support DVD into the optical drive. The DVD automatically displays the Drivers menu if Autorun is enabled in your computer. Click each menu tab and select the items you want to install.

The Drivers menu shows the available device drivers if the system detects installed devices. Install the necessary drivers to use the devices.

The Utilities menu shows the applications and other software that the motherboard supports.

The Make Disk menu contains items to create the RAID/AHCI driver disk.

The Manual menu contains the list of supplementary user manuals. Click an item to open the folder of the user manual.

Click the Contact tab to display the ASUS contact information.

Click an icon to display DVD/motherboard information

Click an item to install



If Autorun is NOT enabled in your computer, browse the contents of the support DVD to locate the file ASSETUP.EXE from the BIN folder. Double-click the ASSETUP.EXE to run the DVD.

4.2.2 Obtaining the software manuals

The software manuals are included in the support DVD. Follow the instructions below to get the necessary software manuals.



The software manual files are in Portable Document Format (PDF). Install the Adobe® Acrobat® Reader from the Utilities menu before opening the files.

1. Click the **Manual** tab. Click **ASUS Motherboard Utility Guide** from the manual list on the left.



2. The **Manual** folder of the support DVD appears. Double-click the folder of your selected software.

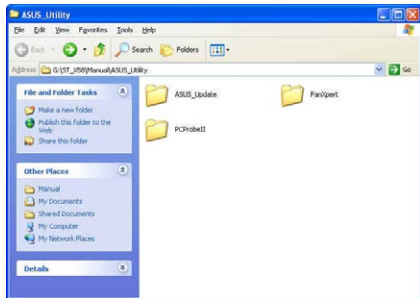

3. Some software manuals are provided in different languages. Double-click the language to show the software manual.

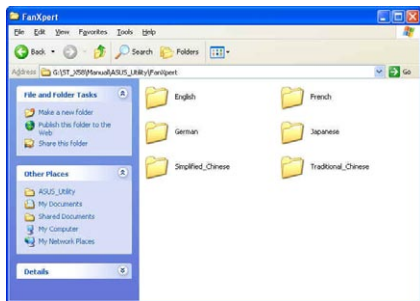

The screenshots in this section are for reference only. The actual software manuals containing in the support DVD vary by models.

4.3 Software information

Most of the applications in the support DVD have wizards that will conveniently guide you through the installation. View the online help or readme file that came with the software application for more information.

4.3.1 AI Suite II

AI Suite II is an all-in-one interface that integrates several ASUS utilities and allows users to launch and operate these utilities simultaneously.

Installing AI Suite II

To install AI Suite II on your computer:

1. Place the support DVD to the optical drive. The Drivers installation tab appears if your computer has enabled the Autorun feature.
2. Click **Utilities** tab > **AI Suite II**.
3. Follow the onscreen instructions to complete the installation.

Using AI Suite II

AI Suite II automatically starts when you enter the Windows® operating system (OS). The AI Suite II icon appears in the Windows® notification area. Click the icon to open the AI Suite II main menu bar.

Click each button to select and launch a utility, to monitor the system, to update the motherboard BIOS, to display the system information, and to customize the settings of AI Suite II.

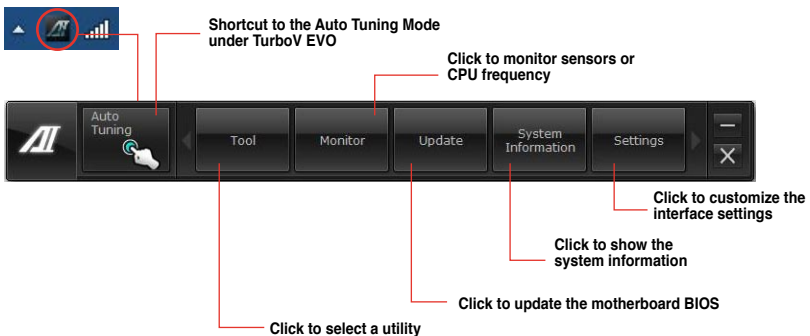

- The **Auto Tuning** button appears only on models with the TurboV EVO function.
- The applications in the **Tool** menu vary with motherboard models and CPUs installed.
- The screenshots of AI Suite II in this user manual are for reference only. The actual screenshots vary with models.
- Refer to the software manual in the support DVD or visit the ASUS website at www.asus.com for detailed software configuration.

4.3.2 TurboV EVO

ASUS TurboV EVO includes **TurboV** that allows you to manually adjust the CPU frequency and related voltages such as **CPU Level Up** that offers automatic and easy overclocking and system level up.

To launch AI Suite II, click **Tool > TurboV EVO** on the AI Suite II main menu bar.



Refer to the software manual in the support DVD or visit the ASUS website at www.asus.com for detailed software configuration.

TurboV

TurboV allows you to overclock the CPU Bus/PEG frequency, CPU voltage, CPU/NB voltage and DRAM voltage in Windows® environment and takes effect in real-time without exiting and rebooting the OS.



Refer to the CPU documentation before adjusting CPU voltage settings. Setting a high voltage may damage the CPU permanently, and setting a low voltage may lead to an unstable system.



For system stability, all changes made in TurboV will not be saved to BIOS settings and will not be kept on the next system boot. Use the **Save Profile** function to save your customized overclocking settings and manually load the profile after Windows starts.

The screenshot shows the ASUS TurboV EVO interface with the following annotations:

- Click to select mode:** Points to the 'Manual Mode' and 'Auto Tuning' tabs.
- Load profile:** Points to the 'Profile' dropdown menu.
- Target values:** Points to the numerical input fields for CPU Bus/PEG Freq, CPU Voltage, CPU/NB Voltage, and DRAM Voltage.
- Current values:** Points to the numerical output fields for the same parameters.
- Click to show settings:** Points to the 'Advanced Mode' and 'CPU Ratio' sections.
- Save the current settings as a new profile:** Points to the 'Save Profile' button.
- Voltage Adjustment bars:** Points to the horizontal sliders for voltage adjustment.
- Undoes all the changes:** Points to the 'Undo' button.
- Applies all the changes immediately:** Points to the 'Apply' button.
- Click to restore all startup settings:** Points to the 'OS Default Settings' button.

Using Advanced Mode

Click on the **Advanced Mode** tab to adjust the advanced voltage settings.

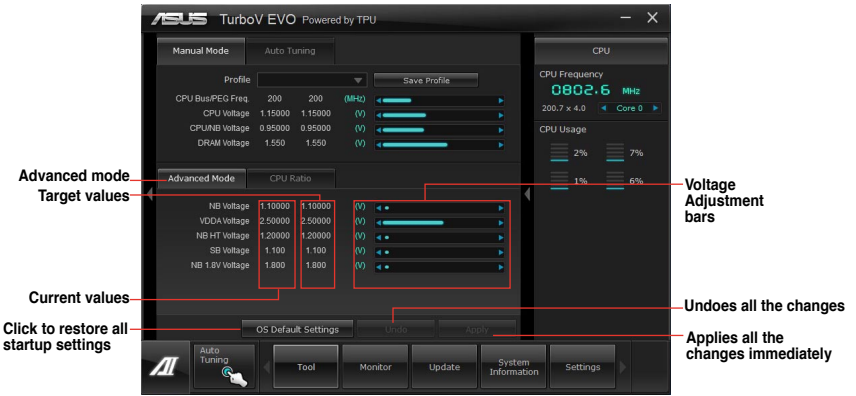

CPU Ratio

Allows you to manually adjust the CPU ratio.

1. Click on the **CPU Ratio** tab.
2. Drag the adjustment bar upwards or downwards to the desired value.
3. Click **Apply** to save the changes made.



- Set the **CPU Ratio Setting** item in BIOS to [Auto] before using the CPU Ratio function in TurboV. Refer to the BIOS chapter of your motherboard user manual for details.
- The CPU Ratio bars show the status of the CPU cores, which vary with your CPU model.

Auto Tuning

ASUS TurboV EVO provides you with these two auto-tuning modes for the most flexible auto-tuning options.



- The overclocking result varies with the CPU model and the system configuration.
- We recommend that you set up a better thermal environment to prevent overheating from damaging the motherboard.

- **Fast Tuning:** fast overclocking for the system
- **Extreme Tuning:** extreme overclocking for the system

Using Fast Tuning

1. Click **Auto Tuning** tab > **Fast**.
2. Read the warning messages and click **Start** to start the auto-overclocking process.

TurboV automatically overclocks the CPU, saves the BIOS settings, and restarts the system.



3. After the system restarts, a message appears indicating that auto-tuning is successful. Click **OK** to exit.

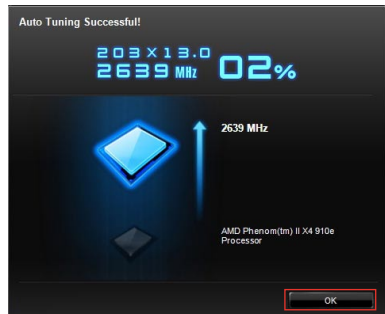

Using Extreme Tuning

1. Click **Auto Tuning** tab > **Extreme**.
2. Read the warning messages and click **Start** to start the auto-overclocking process.

TurboV automatically overclocks the CPU and memory, and restarts the system.



3. After the system has restarted, a message appears indicating the current overclocking result. To keep the result, click **Stop**.

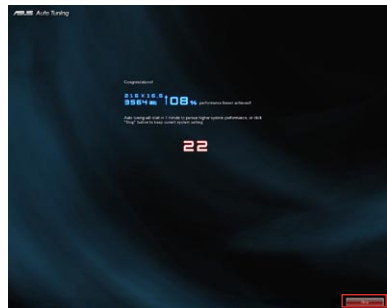

4. If you did not click **Stop** in the previous step, TurboV automatically starts further system overclocking and stability test. Click **Stop** if you want to cancel the overclocking process.

TurboV automatically adjusts and saves the BIOS settings and restarts the system.



5. After the system has restarted, a message appears indicating that the auto-tuning process is successful. Click **OK** to exit.

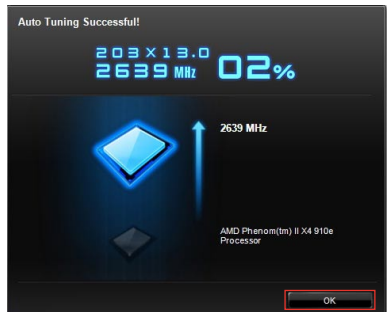

4.3.3 EPU

EPU is an energy-processing utility that provides several power-saving modes. When set to the Auto Mode, the system automatically changes its power-saving mode based on the current system condition.

You can also configure the system settings such as CPU frequency, GPU frequency, vCore Voltage, and Fan Control to customize a power-saving mode.

Launching EPU

To launch EPU, click **Tool > EPU** on the AI Suite II main menu bar.

Multiple system operating modes

Displays the following message if no VGA power saving engine is detected.

The items lighting up means power saving engine is activated

Displays the amount of CO2 reduced

***Shifts between the display of Total and Current CO2 reduced**

Displays the current CPU power

Advanced settings for each mode

Displays the system properties of each mode



- *Select **From EPU Installation** to show the CO2 that has been reduced since you installed EPU.
- *Select **From the Last Reset** to show the total CO2 that has been reduced since you click the Clear button **Clear**.
- Refer to the software manual in the support DVD or visit the ASUS website at www.asus.com for detailed software configuration.

4.3.4 Remote GO!

Connect your computer to a wireless network and use Remote GO! to wirelessly stream media files to DLNA devices. It allows you to remotely control and access your computer using your mobile device, and easily transfer files between your computer and mobile device.



- Remote GO! is supported only on Windows® 7.
- All devices using the Remote GO! functions must be in the same network.

Using Remote GO!

To launch Remote GO!, click **Tool > Remote GO!** on the AI Suite II menu bar.



Remote GO! functions

- **DLNA Media Hub:** Provides support to the latest DLNA standard, and allows you to stream media files to a DLNA-supported device.
- **Remote Desktop:** Allows you to view your computer's desktop and remotely operate your computer in real-time from your mobile device.
- **File Transfer:** Allows you to transfer files between your computer and mobile device.



Launch W-Fi GO! Remote on your mobile device to use W-Fi GO! Remote control functions. For more details, refer to next section **W-Fi GO! Remote**.

W-Fi GO! Remote

Install the W-Fi GO! Remote application on your mobile device to use Remote GO!'s remote control functions.



- W-Fi GO! Remote supports iOS 4.0/Android 2.3 mobile devices or later versions.
- For iOS devices, download the W-Fi GO! Remote from iTunes store. For Android devices, download the W-Fi GO! Remote from Google Play Store or from ASUS support DVD.

Launching W-Fi GO! Remote

1. Turn on your mobile device's wireless connection. Ensure that your mobile device is within the same network as your computer.
2. On your mobile device, tap  and tap **Enter** on the W-Fi GO! Remote page.
3. Tap the computer you want to connect to your mobile device.
4. Tap the computer you want to connect to your mobile device.

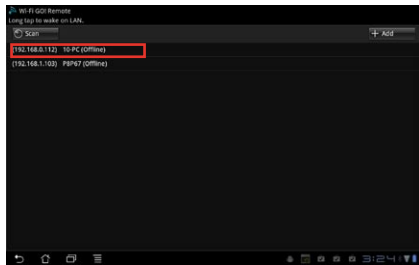

W-Fi GO! Remote menu

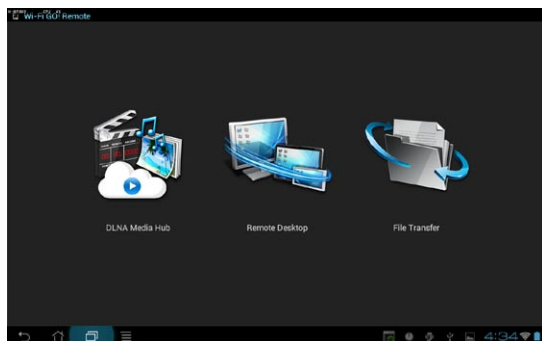

The W-Fi GO! Remote's user interface shown above is for reference only and may vary with the mobile device's operating system.

Below are the supported screen resolution of your mobile devices:

Screen type	Low Density (120, ldpi)	Medium Density (160, mdpi)	High Density (240, hdpi)	Extra high density (320, xhdpi)
Small creen	QVGA (240 x 320)		480 x 640	
Normal screen	WQVGA400 (240 x 400)	HVGA (320 x 480)	WVGA800 (480 x 800)	640 x 960
	WQVGA432 (240 x 432)		WVGA854 (480 x 854) 600 x 1024	
Large screen	WVGA800 (480 x 800)	WVGA800 (480 x 800)	600 x 1024	
	WVGA854 (480 x 854)	WVGA854 (480 x 854)		
Extra large screen	1024 x 600	WXGA (1280 x 800)	1536 x 1152	2048 x 1536
		1024 x 768	1920 x 1152	2560 x 1536
		1280 x 768	1920 x 1200	2560 x 1600

DLNA Media Hub

DLNA Media Hub allows you to stream your multimedia files to your DLNA-supported device and remotely control playback using your mobile device or your computer.

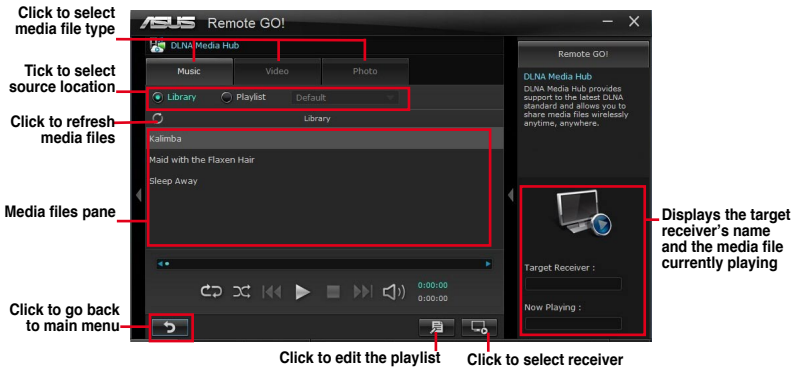

Using the DLNA Media Hub

- From the main screen, click **DLNA Media Hub**.
- Click  to select a device as your receiver.
 - When using your DLNA display (such as DLNA TV) as the receiver, ensure that DLNA function is enabled.
 - When using another computer as the receiver, launch **Windows Media Player**, click **Stream > Allow remote control of my Player** to remotely control media playback.

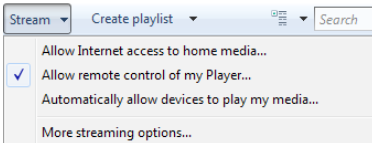

- When using the computer as sender and receiver, launch **Windows Media Player**, click **Stream > Allow remote control of my Player** and **Automatically allow devices to play my media**.

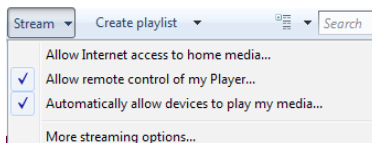

- Only computers under Windows® 7 support the DLNA Media Hub function.
- Keep the Windows Media Player open. Ensure that your media file formats supported on Windows Media Player and DLNA playback devices.

- Click any of the tabs to select your preferred media file type.

To play music:

1. Click **Music** tab.
2. Tick **Library** to view or play files.

Tick **Playlist** and select an existing playlist from the dropdown list.

3. Click a music file, and click .

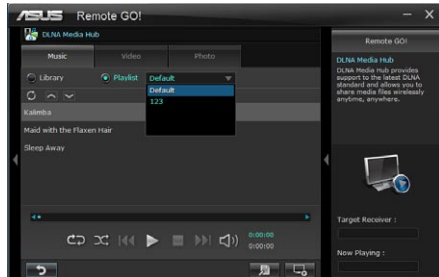

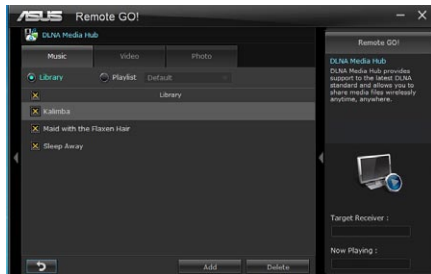

To edit the library:

1. Tick **Library**.
2. Click  to add or delete music files.
3. Click **Add** and locate the file from the directory. To delete, tick the selected file and click **Delete**.
4. Click **OK**.



To edit the music playlist:

1. Tick **Playlist**.
2. Click .
3. Tick to select or deselect the music file and click **Save Profile**.
4. Select the profile name and click **Save**. To add as a new playlist, key in your profile name and click **Save**.
5. To delete playlist, select the profile and click .

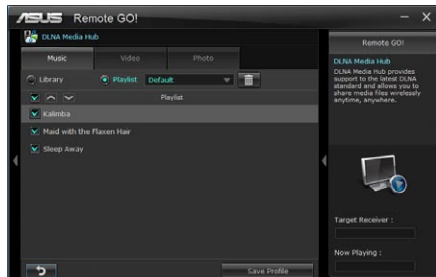

To play a video file:

1. Click **Video** tab.
2. Tick **Library** to view the video files from your local computer. Tick **Playlist** to view the video files saved in your profile.
3. Click the video file you want to watch, and click 

Change the resolution from the **Quality** dropdown list.

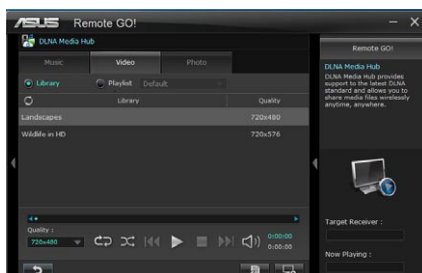

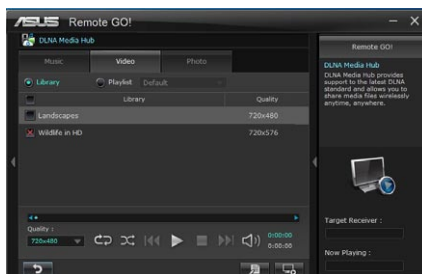

To edit the video library:

1. Tick **Library**.
2. Click  to add or delete video files.
3. Click **Add** and locate the file from the directory. To delete, tick the selected file and click **Delete**.
4. Click **OK**.



To edit the video playlist:

1. Tick **Playlist**.
2. Click .
3. Tick to select or deselect the video file and click **Save Profile**.
4. Select the profile name and click **Save**. To add as a new playlist, key in your profile name and click **Save**.
5. To delete playlist, select the profile and click .



To view images:

1. Click **Photo** tab.
2. Tick **Library** to view the image files from your local computer. Tick **Playlist** to view the image files saved in your profile.

An image slideshow plays when pressing .

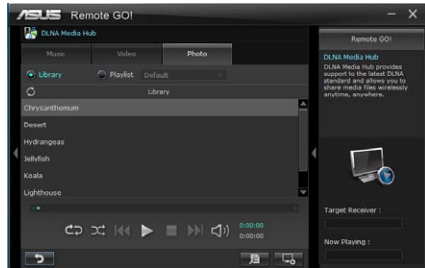

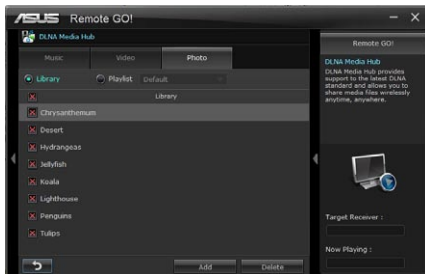

To edit the image library:

1. Tick **Library**.
2. Click  to add or delete image files.
3. Click **Add** and locate the file from the directory. To delete, tick the selected file and click **Delete**.
4. Click **OK**.



To edit the image playlist:

1. Tick **Playlist**.
2. Click .
3. Tick to select or deselect the image file and click **Save Profile**.
4. Select the profile name and click **Save**. To add as a new playlist, key in your profile name and click **Save**.
5. To delete playlist, select the profile and click .

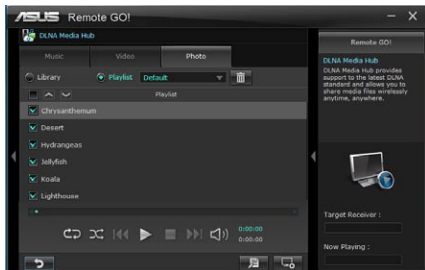

Using the DLNA Media Hub via W-Fi GO! Remote

You can access the DLNA Media Hub on your mobile device via W-Fi GO! Remote.

1. Tap **DLNA Media Hub**.
2. Select and tap the receiver name.



3. The mobile device shows the information of the DLNA Media Hub function. Tap **Enter** to proceed to the Remote GO! function.
4. Tap **Music**, **Video** or **Photo**, to play.



Your mobile device's Wi-Fi GO! Remote interface may vary with the mobile device's operating system.

Remote Desktop

Remote Desktop allows you to view your computer's desktop and remotely operate your computer in real-time from your mobile device.

Using the Remote Desktop

1. From the main screen, click **Remote Desktop**.
2. Click **Setting**.



3. Select a suitable codec **Auto**, **Speed optimization**, or **Image optimization** for your mobile device.
4. Click **Apply**.



Using the Remote Desktop via W-Fi GO! Remote

When the **Remote Desktop** is enabled, the mobile device shows the contents of your desktop.



The W-Fi GO! Remote's user interface shown above is for reference only and may vary with the mobile device's operating system.

File Transfer

Allows you to transfer files wirelessly between your computer and mobile device.



Before using File Transfer, ensure that your computer is connected to your mobile device. For more details, refer to the section **Wi-Fi GO! Remote**.

The screenshot shows the ASUS Remote GO! File Transfer application window. It is divided into three main sections: 'Mobile Device to Desktop', 'Desktop to Mobile Device', and 'Remote GO!'. The 'Mobile Device to Desktop' section shows a path: 'C:\Users\X790LX\Documents\ASUS'. The 'Desktop to Mobile Device' section shows a path: 'Path: iSD Card:\Remote GO!'. A red box highlights the 'Remote GO!' section, which contains the text: 'File Transfer File Transfer provides you with the easiest wireless file transfer option between your computer and mobile device.' A red box highlights the 'Mobile Device to Desktop' section, which contains the text: 'Destination path for the files transferred from mobile device to desktop'. A red box highlights the 'Desktop to Mobile Device' section, which contains the text: 'Destination path for the files transferred from desktop to mobile device'. A red box highlights the 'Back' button in the bottom left corner, with the text: 'Click to go back to main menu'. A red box highlights the 'Browse' button in the bottom center, with the text: 'Click to select a destination path for your file transfer'.

Application help

Destination path for the files transferred from mobile device to desktop

Destination path for the files transferred from desktop to mobile device

Click to go back to main menu

Click to select a destination path for your file transfer



- Android mobile devices can send and receive files.
- iOS mobile devices can only send files.

Using File Transfer

1. Right-click the file and click **Send to > [Device name]**.
2. After the transfer is complete, click **OK**.

Using File Transfer via W-Fi GO! Remote

1. On your mobile device, tap **File Transfer**.
2. Tap **Enable** to receive files from PC.
3. Tap **Enter** to send files to PC.



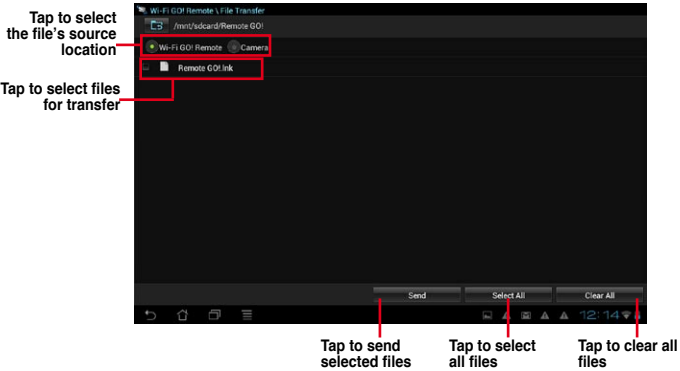

The Wi-Fi GO! Remote's user interface shown above is for reference only and may vary with the mobile device's operating system.

Securing your computer for Wi-Fi GO! Remote functions

Remote GO! Settings allows you to create a password for your computer.

To create a password:

1. Click  in the main menu.
2. Tick **Use Password** and key in your password.
3. Click **Apply**.



- When you launch the Wi-Fi GO! Remote, the application prompts you to key in the computer's password.
- Your password must contain 6-12 letters or numbers.

4.3.5 USB 3.0 Boost

ASUS USB 3.0 Boost technology supports UASP (USB Attached SCSI Protocol) and automatically increases a USB 3.0 device's transfer speed up to 170%.

Launching USB 3.0 Boost

To launch USB 3.0 Boost, click **Tool > USB 3.0 Boost** on the AI Suite II main menu bar.

Configuring USB 3.0 Boost

1. Connect a USB 3.0 device to the USB 3.0 port.

USB 3.0 Boost automatically detects the property of the USB 3.0 device and switches to **Turbo** mode or **UASP** mode (if UASP is supported by the USB 3.0 device).

2. You can manually switch the USB 3.0 mode back to **Normal** mode at any time.



- Refer to the software manual in the support DVD or visit the ASUS website at www.asus.com for detailed software configuration.
- Use the USB 3.0 devices for high performance. The data transfer speed varies with USB devices.

4.3.6 Network iControl

ASUS Network iControl is an intuitive one-stop network control center that makes it easier for you to manage your network bandwidth and allows you to set, monitor, and schedule the bandwidth priorities for your network programs. It also allows you to automatically connect to a PPPoE for a more convenient online experience.

To launch Network iControl, click **Tool > Network iControl** from AI Suite II main menu bar.



- Ensure to install the LAN drivers before using this function.
- Network iControl is only supported under Windows® 7 and can only support the onboard LAN.

Using EZ Start

EZ Start allows you to quickly activate Network iControl, and set the highest bandwidth priority for your top currently running program.

To use EZ Start:

1. Click the EZ Start tab.
2. Click **ON/OFF** to enable/disable Network iControl.



- By default, Network iControl is set to **ON**.
- When switched off, the **Quick Connection**, **EZ Profile**, and **Info** are disabled.
- You may monitor the bandwidth priority from your desktop's taskbar.

3. Select a profile and click **Apply**.



Tick **Set current network program as the highest priority** to set the top network program as the highest priority.

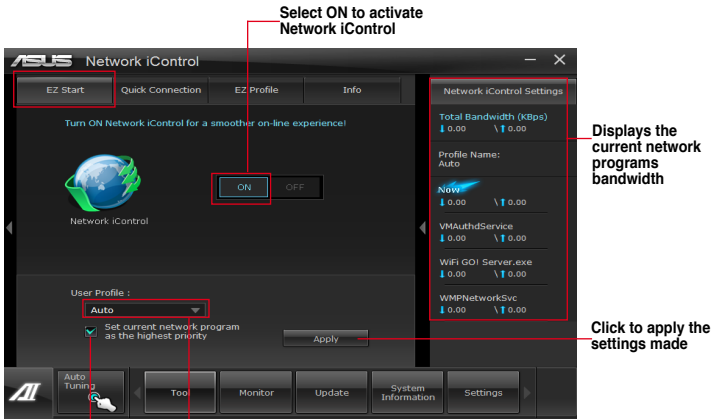

Tick to enable the current network program in use as the highest priority

Click to select a profile

Select ON to activate Network iControl

Displays the current network programs bandwidth

Click to apply the settings made

Using Quick Connection

Configuring the PPPoE connection settings

Before enabling the Network iControl's **Quick Connection** functions, you must configure the PPPoE connection settings

To configure the PPPoE settings:

1. Right-click  in the taskbar, and select **Open Network and Sharing Center**.

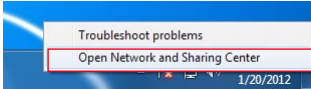

2. Right-click the PPPoE Connection, and select **Properties**.

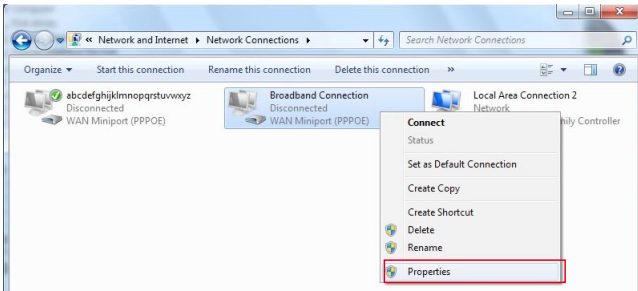

3. Click the **Options** tab, and deselect **Prompt for name and password, certificate, etc.** Click **OK** to complete the auto PPPoE connection settings.

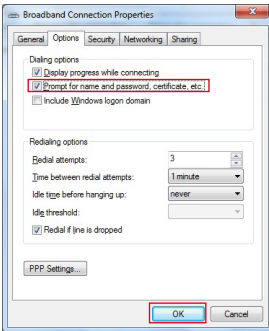

- You only need to configure the PPPoE connection settings once.
- Obtain the necessary information about your PPPoE connection from your network provider.

Configuring the Quick Connection

To configure the auto-PPPoE connection:

1. Click the **Quick Connection** tab.
2. Tick **Automatically connect online anytime** option, then select the connection name in the **Connection Name** dropdown box.
3. Click **Apply** to enable the PPPoE automatic network connection.



Click to select Connection Name

Click to set the auto PPPoE connection

Click to apply settings

Click ON to improve network performance

ASUS Network iControl

EZ Start **Quick Connection** EZ Profile Info

PPPoE(Auto Connection)

Connection Name: **Broadband**

Automatically connect online anytime

Select "Options" and uncheck "Prompt for name and password, certificate, etc. for auto PPPoE connection"

Apply

No Delay TCP

ON OFF

Network setting

Network iControl Settings

Total Bandwidth (KBps)

0.00 \ 0.00

Profile Name: Auto

Now

0.00 \ 0.00

VMAuthdService

0.00 \ 0.00

WiFi GO! Server.exe

0.00 \ 0.00

WMPNetworkSvc





0.00 \ 0.00

Auto Tuning Tool Monitor Update System Information Settings

Using EZ Profile

To use the EZ Profile:

EZ Profile allows you to load, edit, and save your own network program priority profile.

1. Click the **EZ Profile** tab. The programs are shown in the network program column.
2. Select the network program, and click  to create your profile.
3. Click  to save the changes and/or rename your profile.
4. Click , , or  to set the program priority as High, Normal, or Low.

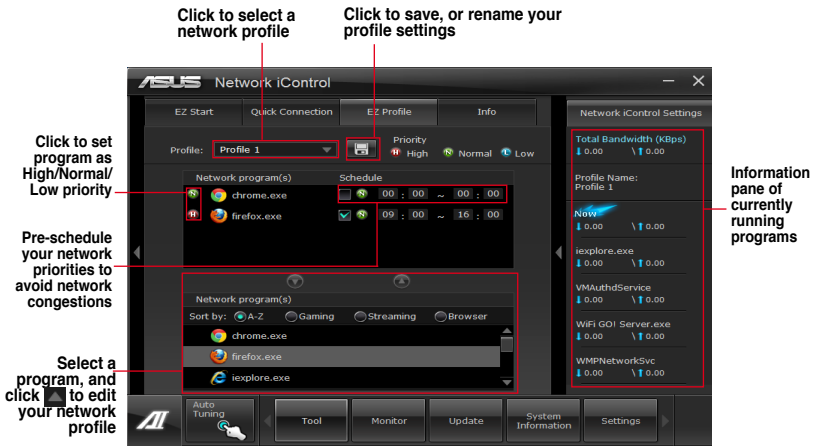

4.3.7 USB BIOS Flashback Wizard

USB BIOS Flashback allows you to easily update the BIOS without entering the BIOS or operating system. Just connect the USB storage device containing the BIOS file to the USB port, press the BIOS Flashback button, and the BIOS is updated automatically.

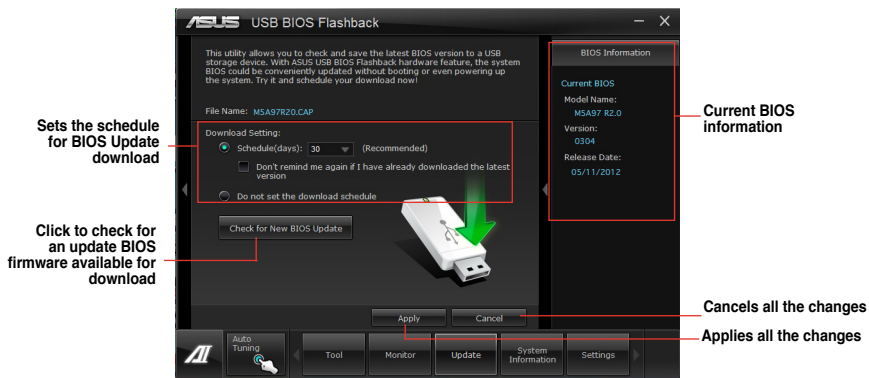

Scheduling the latest BIOS download

1. In the **Download Setting** field, tick **Schedule (days)** and select the number of days for your download schedule.
2. Click **Apply** to save the BIOS download schedule. Click **Cancel** to cancel the changes made.

Downloading the updated BIOS



Before you start downloading, ensure that you have installed the USB storage device to your computer's USB port.

1. Click **Check for New BIOS Update** to check for the latest BIOS version.

Wait for the system to check the latest BIOS firmware.

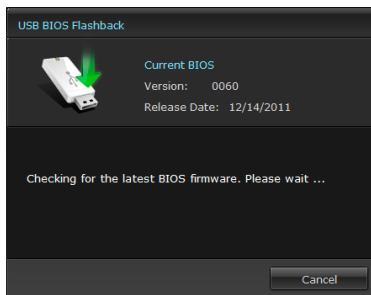

- From the **Save to** dropdown list, select the USB storage device that you want to save the BIOS file to, then click **Download**.

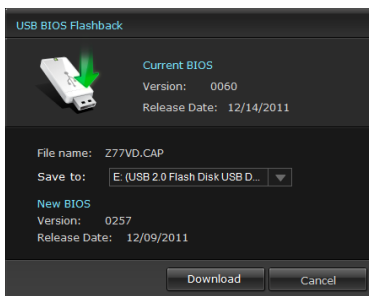

- When the download process is completed, click **OK** to exit.



4.3.8 FAN Xpert

Fan Xpert intelligently allows you to adjust both the CPU and chassis fan speeds according to different ambient temperatures caused by different climate conditions in different geographic regions and your PC's system loading. The built-in variety of useful profiles offer flexible controls of fan speed to achieve a quiet and cool environment.

Launching FAN Xpert

After installing AI Suite II from the motherboard support DVD, launch FAN Xpert by clicking **Tool > Fan Xpert** on the AI Suite II main menu bar.

Using FAN Xpert

Click **Fan Name** to select a fan and then click **Setting** to select a preset mode for your selected fan.

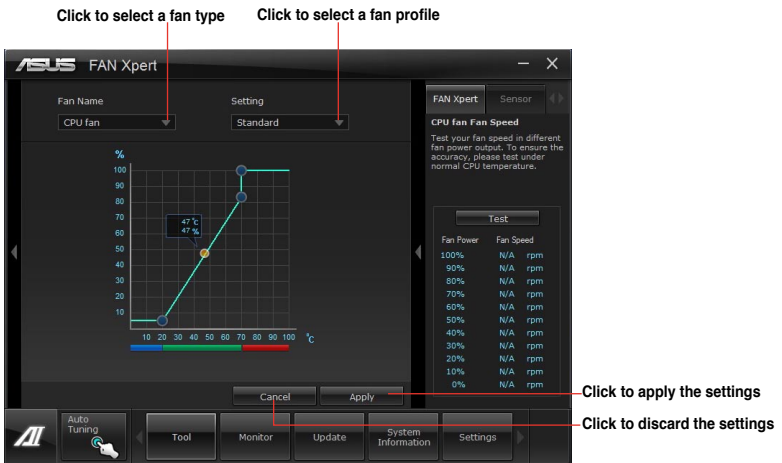

Fan setting

- **Disable:** disables the **Fan Xpert** function.
- **Standard:** adjusts fan speed in a moderate pattern.
- **Silent:** minimizes fan speed for quiet fan operation.
- **Turbo:** maximizes the fan speed for the best cooling effect.
- **User:** Allows you to configure the CPU fan profile under certain limitations.

4.3.9 Ai Charger+

This utility allows you to fast-charge your portable BC 1.1* mobile devices on your computer's USB port three times faster than the standard USB devices**.



- * Check your manufacturer if your USB device is a Battery Charging Specification 1.1 (BC 1.1) compliant or compatible device.
- ** Actual charging speeds may vary depending on the charging rate and specifications of your USB device.
- To ensure normal charging function, disconnect and reconnect your USB device every time you enable or disable Ai Charger+.



4.3.10 Probe II

Probe II is a utility that monitors the computer's vital components, and detects and alerts you of any problem with these components. Probe II senses fan rotations, CPU temperature, and system voltages, among others. With this utility, you are assured that your computer is always at a healthy operating condition.

Launching Probe II

To launch Probe II, click **Tool > Probe II** on the AI Suite II main menu bar.

Configuring Probe II

Click the Voltage/Temperature/Fan Speed tabs to activate the sensors or to adjust the sensor threshold values. The Preference tab allows you to customize the time interval of sensor alerts, or change the temperature unit.

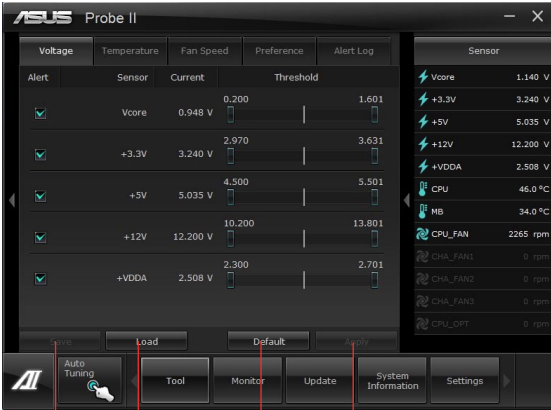

The screenshot shows the ASUS Probe II application window. It features several tabs: Voltage, Temperature, Fan Speed, Preference, and Alert Log. The main area displays a table of sensor configurations with columns for Alert, Sensor, Current, and Threshold. A right-hand panel shows real-time sensor data for Voltage (Vcore, +3.3V, +5V, +12V, +VDDA) and Temperature (CPU, MB, CPU_FAN). At the bottom, there are buttons for Auto Tuning, Tool, Monitor, Update, System Information, and Settings. Three red lines with text annotations point to the 'Auto Tuning' button, the 'Tool' button, and the 'Monitor' button.

Alert	Sensor	Current	Threshold
<input checked="" type="checkbox"/>	Vcore	0.948 V	0.200
<input checked="" type="checkbox"/>	+3.3V	3.240 V	2.970
<input checked="" type="checkbox"/>	+5V	5.035 V	4.500
<input checked="" type="checkbox"/>	+12V	12.200 V	10.200
<input checked="" type="checkbox"/>	+VDDA	2.508 V	2.300

Sensor	Value
Vcore	1.140 V
+3.3V	3.240 V
+5V	5.035 V
+12V	12.200 V
+VDDA	2.508 V
CPU	46.0 °C
MB	34.0 °C
CPU_FAN	2265 rpm
CHL_FAN1	0 rpm
CHL_FAN2	0 rpm
CHL_FAN3	0 rpm
CPU_OPT	0 rpm

Saves your configuration (points to Auto Tuning)

Loads your saved configuration (points to Tool)

Loads the default threshold values for each sensor (points to Monitor)

Applies your changes (points to Monitor)



- Click Monitor > Sensor on the AI Suite II main menu bar and the system status will appear on the right panel.
- Refer to the software manual in the support DVD or visit the ASUS website at www.asus.com for detailed software configuration.

4.3.11 Sensor Recorder

Sensor Recorder monitors the changes in the system voltage, temperature, and fan speed on a timeline. The History Record function allows you to designate specific time spans on record to keep track of the three system statuses for certain purposes.

Launching Sensor Recorder

To launch Sensor Recorder, click **Tool > Sensor Recorder** on the AI Suite II main menu bar.

Using Sensor Recorder

Click on Voltage/ Temperature/ Fan Speed tabs for the status you want to monitor. Colored lines will automatically appear on the diagram to indicate the immediate changes in the system status.

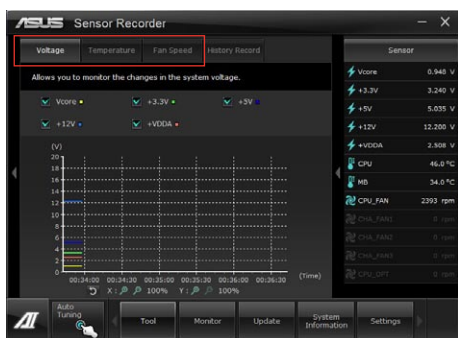

Using History Record

1. Click the **History Record** tab and adjust the settings on the left for **Record Interval** and **Record Duration** according to need.
2. Click **Start Recording** to start measuring and recording each sensor.
3. To stop recording, click **Recording** again.
4. To track the recorded contents, set **Type/ Date/ Select display items** to display the history details.

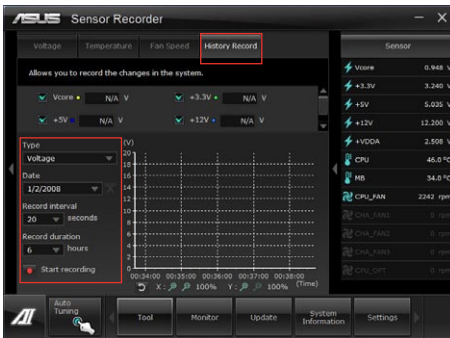

Click **Monitor > Sensor** on the AI Suite II main menu bar and the system status will appear on the right panel.

4.3.12 ASUS Update

ASUS Update is a utility that allows you to manage, save, and update the motherboard BIOS in Windows® environment.

Launching ASUS Update

To launch ASUS Update, click **Update > ASUS Update** on the AI Suite II main menu bar.

Using ASUS Update

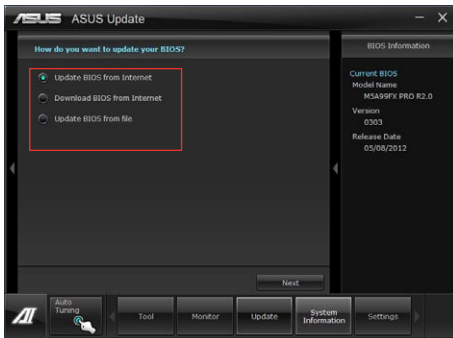

Select any of these options to update the BIOS:

- **Update BIOS from Internet**

Allows you to download the latest BIOS version from the ASUS website at www.asus.com and follow the onscreen instructions to update the BIOS.

- **Download BIOS from Internet**

Download the latest BIOS version from the ASUS website at www.asus.com and save it for later use.

- **Update BIOS from file**

Use the BIOS file that you had downloaded and saved to update the system BIOS.

- **Save BIOS to file**

Save the BIOS file to another file or a USB storage device for later use.



Updating the BIOS poses some risks such as system instability or failure to boot. Before updating the BIOS, ensure that you back up the original BIOS file.

4.3.13 MyLogo2

MyLogo2 allows you to customize the boot logo, which is the image that appears on the screen during the Power On Self Tests (POST).

Launching MyLogo2

To launch MyLogo2, click **Update > MyLogo** on the AI Suite II main menu bar.

Using MyLogo

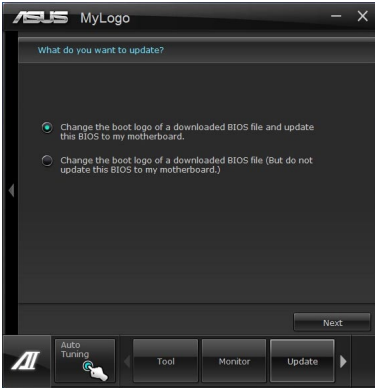

Select the option that you want to use to update your boot logo, click **Next** and follow the instructions below.

Change the boot logo of a downloaded BIOS file and update (or do not update) this BIOS to the motherboard

1. From the **BIOS file** field, click **Browse** to locate the BIOS file.
2. From the **Picture File** field, click **Browse the image for your boot logo**, then click **Next**.

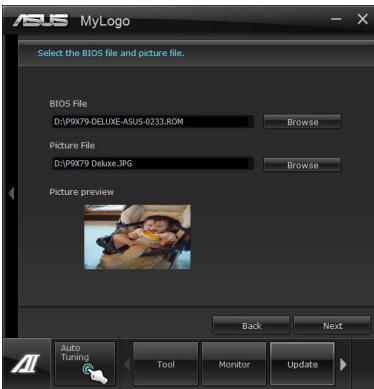

3. Do any of the following:
 - Click **Auto Tune** to adjust the image size or the image resolution.
 - Click **Booting Preview** to preview the boot image.
4. Click **Next**.

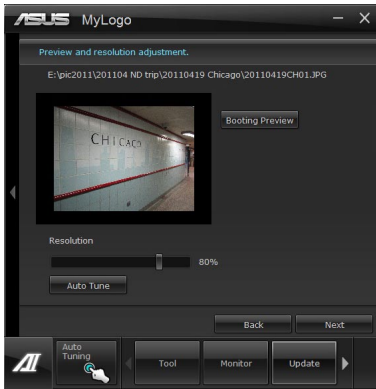

5. Click **Flash** to update the boot logo.
6. When prompted, click **Yes** to reboot the system. You will see the new boot logo the next time you start up the system.



Ensure to enable the **Full Screen Logo** in BIOS to use this feature.

4.3.14 Audio configurations

The Realtek® audio CODEC provides 8-channel audio capability to deliver the ultimate audio experience on your computer. The software provides Jack-Sensing function, S/PDIF Out support, and interrupt capability. The CODEC also includes the Realtek® proprietary UAj® (Universal Audio Jack) technology for all audio ports, eliminating cable connection errors and giving users plug and play convenience.

Follow the installation wizard to install the Realtek® Audio Driver from the support DVD that came with the motherboard package.

If the Realtek audio software is correctly installed, you will find the **Realtek HD Audio Manager** icon on the taskbar. Double-click on the icon to display the Realtek HD Audio Manager.

A. Realtek HD Audio Manager for Windows® 7™ / Vista™



B. Realtek HD Audio Manager for Windows XP



Refer to the software manual in the support DVD or visit the ASUS website at www.asus.com for detailed software configuration.

RAID support

5

5.1 RAID configurations

The motherboard comes with the AMD® SB950 chipset that allows you to configure Serial ATA hard disk drives as RAID sets. The motherboard supports the following RAID configurations: RAID 0, RAID 1, RAID 5 and RAID 10.



- You must install Windows® XP Service Pack 3 or later versions before using Serial ATA hard disk drives. The Serial ATA RAID feature is available only if you are using Windows® XP SP3 or later versions.
- Due to Windows® XP limitation, a RAID array with the total capacity over 2TB cannot be set as a boot disk. A RAID array over 2TB can only be set as a data disk only.
- If you want to install a Windows® operating system to a hard disk drive included in a RAID set, you have to create a RAID driver disk and load the RAID driver during OS installation. Refer to section 5.2 **Creating a RAID driver disk** for details.

5.1.1 RAID definitions

RAID 0 (Data striping) optimizes two identical hard disk drives to read and write data in parallel, interleaved stacks. Two hard disks perform the same work as a single drive but at a sustained data transfer rate, double that of a single disk alone, thus improving data access and storage. Use of two new identical hard disk drives is required for this setup.

RAID 1 (Data mirroring) copies and maintains an identical image of data from one drive to a second drive. If one drive fails, the disk array management software directs all applications to the surviving drive as it contains a complete copy of the data in the other drive. This RAID configuration provides data protection and increases fault tolerance to the entire system. Use two new drives or use an existing drive and a new drive for this setup. The new drive must be of the same size or larger than the existing drive.

RAID 5 stripes both data and parity information across three or more hard disk drives. Among the advantages of RAID 5 configuration include better HDD performance, fault tolerance, and higher storage capacity. The RAID 5 configuration is best suited for transaction processing, relational database applications, enterprise resource planning, and other business systems. Use a minimum of three identical hard disk drives for this setup.

RAID 10 is data striping and data mirroring combined without parity (redundancy data) having to be calculated and written. With the RAID 10 configuration you get all the benefits of both RAID 0 and RAID 1 configurations. Use four new hard disk drives or use an existing drive and three new drives for this setup.

5.1.2 Installing Serial ATA hard disks

The motherboard supports Serial ATA hard disk drives. For optimal performance, install identical drives of the same model and capacity when creating a disk array.

To install the SATA hard disks for a RAID configuration:

1. Install the SATA hard disks into the drive bays.
2. Connect the SATA signal cables.
3. Connect a SATA power cable to the power connector on each drive.

5.1.3 Setting the RAID item in BIOS

You must enable the RAID function in the BIOS Setup before creating RAID sets using SATA HDDs. To do this:

1. Enter the BIOS Setup during POST.
2. Go to the **Advanced** menu > **SATA Configuration**, and then press <Enter>.
3. Set the SATA Mode item to [RAID Mode].
4. Save your changes, and then exit the BIOS Setup.



Refer to Chapter 3 for details on entering and navigating through the BIOS Setup



Due to chipset limitation, when SATA ports are set to RAID mode, all SATA ports run at RAID mode together.

5.1.4 AMD® Option ROM utility

To enter the AMD® Option ROM utility:

1. Turn on the system.
2. During POST, press <Ctrl> + <F> to display the utility main menu.

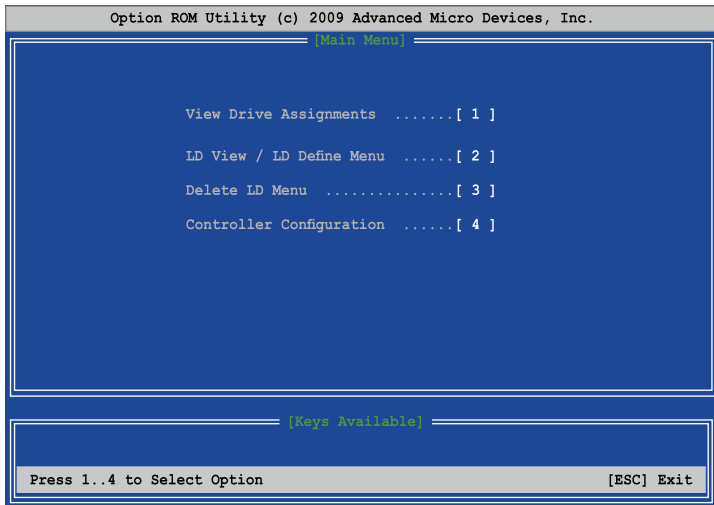

The Main Menu allows you to select an operation to perform. The Main Menu options include:

- **View Drive Assignments:** shows the status of the hard disk drives.
- **LD View / LD Define Menu:** displays the existing RAID set information / creates a RAID 0, RAID 1, RAID 5 or RAID 10 configuration.
- **Delete LD Menu:** deletes a selected RAID set and partition.
- **Controller Configuration:** shows the system resources configuration.

Press <1>, <2>, <3>, or <4> to enter the option you need; press <ESC> to exit the utility.



The RAID BIOS setup screens shown in this section are for reference only and may not exactly match the items on your screen.



The utility supports maximum four hard disk drives for RAID configuration.

Creating a RAID volume

To create a RAID volume:

1. In the Main Menu, press <2> to enter the **LD View / LD Define Menu** function.
2. Press <Ctrl> + <C>, and the following screen appears.

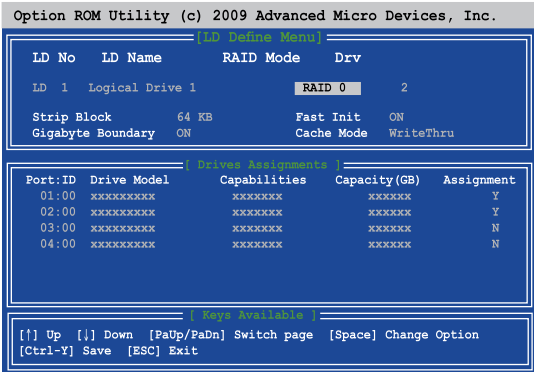

3. Move to the **RAID Mode** item and press <Space> to select a RAID mode to create.
4. Move to the **Assignment** item by using the down arrow key and set **Y** to select the hard disk drives you want to include in the RAID set.
5. Press <Ctrl> + <Y> to save the setting.
6. The utility prompts the following message. Press <Ctrl> + <Y> to input the LD name.

```
Please press Ctrl-Y key to input the LD Name
or press any key to exit.
If you do not input any LD name, the default LD
name will be used.
```

7. Enter an LD name, and then press any key to continue.

```
Enter the LD name here:
```

8. Press <Ctrl> + <Y> to erase the MBR, or you may press any key to abort the settings.

```
Fast Initialization Option has been selected
It will erase the MBR data of the disks.
<Press Ctrl-Y Key if you are sure to erase it>
<Press any other key to ignore this option>
```

9. Press <Ctrl> + <Y> to enter the screen to modify the array capacity, or press any key to use the maximum capacity.

Deleting a RAID configuration



Be cautious when deleting a RAID volume. You will lose all data on the hard disk drives when you delete a RAID volume.

To delete a RAID volume:

1. In the Main Menu, press <3> to enter the **Delete LD** function.
2. Select the RAID item you want to delete and press or <Alt> + <D>.

```
Option ROM Utility (c) 2009 Advanced Micro Devices, Inc.
[ Delete LD Menu ]
+-----+
| LD No   RAID Mode   Drv   Capacity (GB)   Status |
+-----+
| LD 1    RAID 0     2     xxxxxx         Functional |
+-----+
|                                     |
|                                     |
|                                     |
|                                     |
+-----+
[ Keys Available ]
[↑] Up [↓] Down [PaUp/PaDn] Switch page [Del/Alt+D] Delete LD
```

3. The utility prompts the following messages:

```
Press Ctrl-Y to delte the dats in the disk!
or press any other key to abort...
```

Press <Ctrl> + <Y> to delete the RAID volume.

Displaying a RAID set information

To display a RAID set information:

1. In the Main Menu, press <2> to enter the **LD View / LD Define Menu** function.
2. Select a RAID item and press <Enter> to display its information.

```
Option ROM Utility (c) 2009 Advanced Micro Devices, Inc.
[ View LD Defination Menu ]
+-----+
| LD No   LD Name           RAID Mode   Drv   Capacity (GB) |
+-----+
| LD 1    xxxxxx           RAID 0     2     157.99         |
+-----+
| Strip Block           64 KB           Cache Mode   WriteThru      |
+-----+
|                                     |
| [ Drives Assignments ] |
| Port:ID  Drive Model    Capabilities  Capacity (GB) |
| 01:00   xxxxxxxxxx     xxxxxxxx     xxxxxx        |
| 02:00   xxxxxxxxxx     xxxxxxxx     xxxxxx        |
|                                     |
+-----+
|                                     |
| Any Key To Continue..... |
+-----+
```

5.2 Creating a RAID driver disk

A floppy disk with the RAID driver is required when installing a Windows® operating system on a hard disk drive that is included in a RAID set.



-
- The motherboard does not provide a floppy drive connector. You have to use a USB floppy disk drive when creating a SATA RAID driver disk.
 - Windows® XP may not recognize the USB floppy disk drive due to Windows® XP limitation. To work around this OS limitation, refer to section 5.2.4 Using a USB floppy disk drive.
-

5.2.1 Creating a RAID driver disk without entering the OS

To create a RAID driver disk without entering the OS:

1. Boot your computer.
2. Press during POST to enter the BIOS setup utility.
3. Set the optical drive as the primary boot device.
4. Insert the support DVD into the optical drive.
5. Save changes and exit BIOS.
6. When the Make Disk menu appears, press <1> to create a RAID driver disk.
7. Insert a formatted floppy disk into the USB floppy disk drive, then press <Enter>.
8. Follow the succeeding screen instructions to complete the process.

5.2.2 Creating a RAID driver disk in Windows®

To create a RAID driver disk in Windows®:

1. Start Windows®.
2. Plug the USB floppy disk drive and insert a floppy disk.
3. Place the motherboard support DVD into the optical drive.
4. Go to the **Make Disk** menu, and then click **AMD AHCI/RAID 32/64bit xxxx Driver** to create a RAID driver disk.
5. Select **USB floppy disk drive** as the destination disk.
6. Follow the succeeding screen instructions to complete the process.



Write-protect the floppy disk to avoid a computer virus infection.

5.2.3 Installing the RAID driver during Windows® OS installation

To install the RAID driver in Windows® XP:

1. During the OS installation, the system prompts you to press the <F6> key to install third-party SCSI or RAID driver.
2. Press <F6>, and then insert the floppy disk with RAID driver into the USB floppy disk drive.
3. When prompted to select the SCSI adapter to install, select the RAID driver for the corresponding OS version.
4. Follow the succeeding screen instructions to complete the installation.

To install the RAID driver for Windows® 7 or later OS:

1. During the OS installation, click **Load Driver** to allow you to select the installation media containing the RAID driver.
2. Insert the USB flash drive with RAID driver into the USB port or the support DVD into the optical drive, and then click **Browse**.
3. Click the name of the device you've inserted, go to **Drivers > RAID**, and then select the RAID driver for the corresponding OS version. Click **OK**.
4. Follow the succeeding screen instructions to complete the installation.



Before loading the RAID driver from a USB flash drive, you have to use another computer to copy the RAID driver from the support DVD to the USB flash drive.

5.2.4 Using a USB floppy disk drive

Due to OS limitation, Windows® XP may not recognize the USB floppy disk drive when you install the RAID driver from a floppy disk during the OS installation.

To solve this issue, add the USB floppy disk drive's Vendor ID (VID) and Product ID (PID) to the floppy disk containing the RAID driver. Refer to the steps below:

1. Using another computer, plug the USB floppy disk drive, and insert the floppy disk containing the RAID driver.

2. Right-click **My Computer** on the Windows® desktop or start menu, and then select **Manage** from the pop-up window.



3. Select **Device Manager**. From the **Universal Serial Bus controllers**, right-click **xxxxxx USB Floppy**, and then select **Properties** from the pop-up window.



The name of the USB floppy disk drive varies with different vendors.

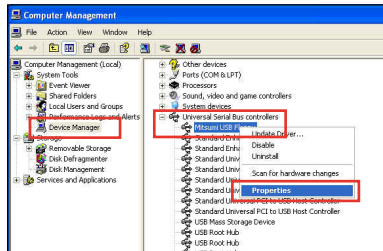

4. Click **Details** tab. The Vendor ID (VID) and Product ID (PID) are displayed.

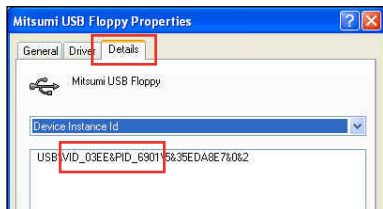

5. Browse the contents of the RAID driver disk to locate the file **txtsetup.oem**.

6. Double-click the file. A window appears, allowing you to select the program for opening the oem file.

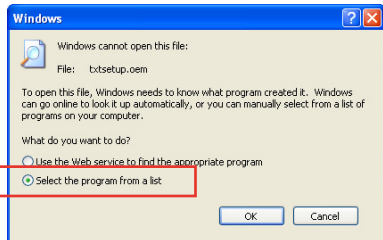

7. Use Notepad to open the file.

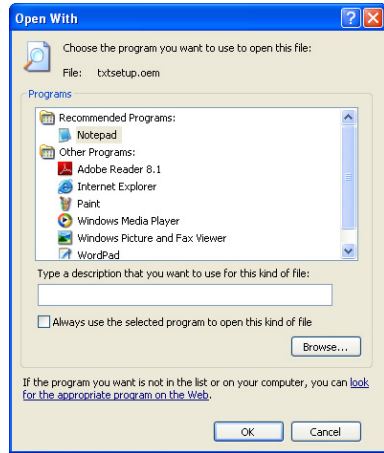

8. Find the **[HardwareIds.scsi.iaAHCI_DesktopWorkstationServer]** and **[HardwareIds.scsi.iaStor_DesktopWorkstationServer]** sections in the txtsetup.oem file.

9. Type the following line to the bottom of the two sections:

id = "USB\VID_xxxx&PID_xxxx", "usbstor"

```
[HardwareIds.SCSI.Napa_i386_ahci8086]
id= "PCI\VEN_1002&DEV_4392&CC_0104", "ahcix86"
id= "PCI\VEN_1002&DEV_4391&CC_0106", "ahcix86"
id= "PCI\VEN_1002&DEV_4393&CC_0104", "ahcix86"
id= "USB\VID_03EE&PID_6901", "usbstor"

[HardwareIds.SCSI.Napa_amd64_ahci]
id= "PCI\VEN_1002&DEV_4392&CC_0104", "ahcix64"
id= "PCI\VEN_1002&DEV_4391&CC_0106", "ahcix64"
id= "PCI\VEN_1002&DEV_4393&CC_0104", "ahcix64"
id= "USB\VID_03EE&PID_6901", "usbstor"
```



Add the same line to both sections.



The VID and PID vary with different vendors.

10. Save and exit the file.

Multiple GPU support

6

6.1 AMD® CrossFireX™ technology

The motherboard supports the AMD® CrossFireX™ technology that allows you to install multi-graphics processing units (GPU) graphics cards. Follow the installation procedures in this section.

6.1.1 Requirements

- In Dual CrossFireX mode, you should have two identical CrossFireX-ready graphics cards or one CrossFireX-ready dual-GPU graphics card that are AMD® certified.
- Ensure that your graphics card driver supports the AMD CrossFireX technology. Download the latest driver from the AMD website (www.amd.com).
- Ensure that your power supply unit (PSU) can provide at least the minimum power required by your system. See **Chapter 1** for details.



-
- We recommend that you install additional chassis fans for better thermal environment.
 - Visit the **AMD Game website** (<http://game.amd.com>) for the latest certified graphics card and the supported 3D application list.
-

6.1.2 Before you begin

For AMD CrossFireX to work properly, you have to uninstall all existing graphics card drivers before installing AMD CrossFireX graphics cards to your system.

To uninstall existing graphics card drivers:

1. Close all current applications.
2. For Windows XP, go to **Control Panel > Add/Remove Programs**.
For Windows 7/Vista, go to **Control Panel > Programs and Features**.
3. Select your current graphics card driver/s.
4. For Windows XP, select **Add/Remove**.
For Windows 7/Vista, select **Uninstall**.
5. Turn off your computer.

6.1.3 Installing two CrossFireX™ graphics cards



The following pictures are for reference only. The graphics cards and the motherboard layout may vary with models, but the installation steps remain the same.

1. Prepare two CrossFireX-ready graphics cards.

2. Insert the two graphics card into the PCIEX16 slots. If your motherboard has more than two PCIEX16 slots, refer to Chapter 1 in this user manual for the locations of the PCIEX16 slots recommended for multi-graphics card installation.

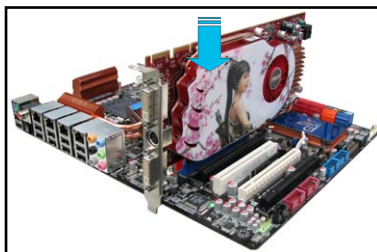

3. Ensure that the cards are properly seated on the slots.

4. Align and firmly insert the CrossFireX bridge connector to the goldfingers on each graphics card. Ensure that the connector is firmly in place.

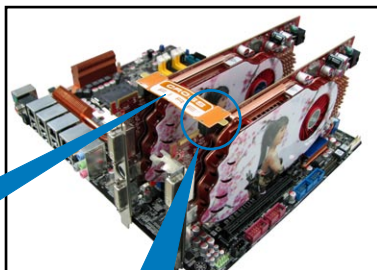

CrossFireX bridge
(bundled with
graphics cards)

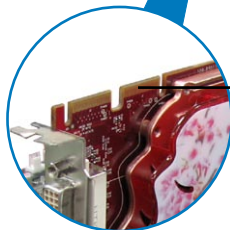

Goldfingers

5. Connect two independent auxiliary power sources from the power supply to the two graphics cards separately.

6. Connect a VGA or a DVI cable to the graphics card.

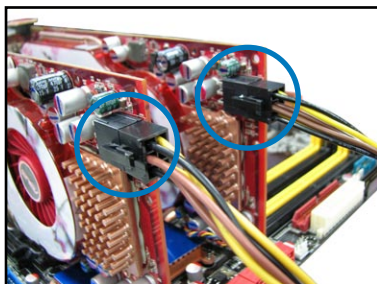

6.1.4 Installing the device drivers

Refer to the documentation that came with your graphics card package to install the device drivers.



Ensure that your PCI Express graphics card driver supports the AMD® CrossFireX™ technology. Download the latest driver from the AMD website (www.amd.com).

6.1.5 Enabling the AMD® CrossFireX™ technology

After installing your graphics cards and the device drivers, enable the CrossFireX™ feature through the AMD VISION Engine Control Center in Windows environment.

Launching the AMD VISION Engine Control Center

To launch the AMD VISION Engine Control Center:

Right-click on the Windows® desktop and select **AMD VISION Engine Control Center**.

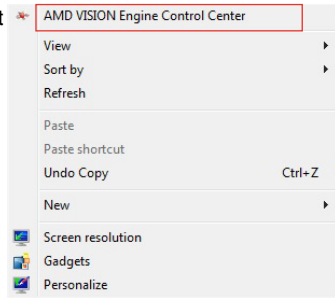

Enabling Dual CrossFireX technology

1. In the Catalyst Control Center window, click **Performance > AMD CrossFireX™**.
2. Select **Enable CrossFireX™**.
3. Select a GPU combination from the drop-down list.
4. Click **Apply** to save and activate the GPU settings made.

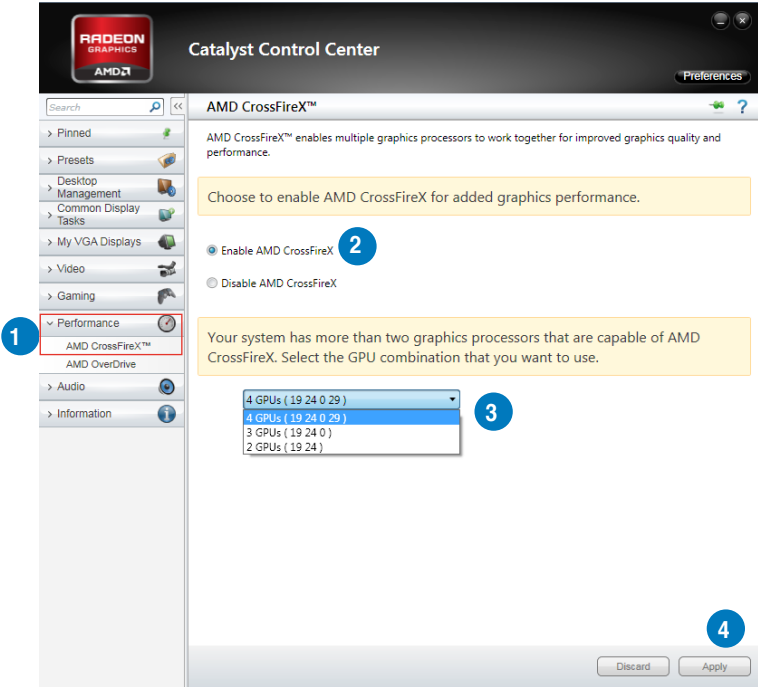

Appendices

Notices

Federal Communications Commission Statement

This device complies with Part 15 of the FCC Rules. Operation is subject to the following two conditions:

- This device may not cause harmful interference.
- This device must accept any interference received including interference that may cause undesired operation.

This equipment has been tested and found to comply with the limits for a Class B digital device, pursuant to Part 15 of the FCC Rules. These limits are designed to provide reasonable protection against harmful interference in a residential installation. This equipment generates, uses and can radiate radio frequency energy and, if not installed and used in accordance with manufacturer's instructions, may cause harmful interference to radio communications. However, there is no guarantee that interference will not occur in a particular installation. If this equipment does cause harmful interference to radio or television reception, which can be determined by turning the equipment off and on, the user is encouraged to try to correct the interference by one or more of the following measures:

- Reorient or relocate the receiving antenna.
- Increase the separation between the equipment and receiver.
- Connect the equipment to an outlet on a circuit different from that to which the receiver is connected.
- Consult the dealer or an experienced radio/TV technician for help.



The use of shielded cables for connection of the monitor to the graphics card is required to assure compliance with FCC regulations. Changes or modifications to this unit not expressly approved by the party responsible for compliance could void the user's authority to operate this equipment.

IC: Canadian Compliance Statement

Complies with the Canadian ICES-003 Class B specifications. This device complies with RSS 210 of Industry Canada. This Class B device meets all the requirements of the Canadian interference-causing equipment regulations.

This device complies with Industry Canada license exempt RSS standard(s). Operation is subject to the following two conditions: (1) this device may not cause interference, and (2) this device must accept any interference, including interference that may cause undesired operation of the device.

Cet appareil numérique de la Classe B est conforme à la norme NMB-003 du Canada. Cet appareil numérique de la Classe B respecte toutes les exigences du Règlement sur le matériel brouilleur du Canada.

Cet appareil est conforme aux normes CNR exemptes de licence d'Industrie Canada. Le fonctionnement est soumis aux deux conditions suivantes :

- (1) cet appareil ne doit pas provoquer d'interférences et
- (2) cet appareil doit accepter toute interférence, y compris celles susceptibles de provoquer un fonctionnement non souhaité de l'appareil.

Canadian Department of Communications Statement

This digital apparatus does not exceed the Class B limits for radio noise emissions from digital apparatus set out in the Radio Interference Regulations of the Canadian Department of Communications.

This class B digital apparatus complies with Canadian ICES-003.

VCCI: Japan Compliance Statement

VCCI Class B Statement

情報処理装置等電波障害自主規制について

この装置は、情報処理装置等電波障害自主規制協議会（VCCI）の基準に基づくクラスB情報技術装置です。この装置は家庭環境で使用することを目的としていますが、この装置がラジオやテレビジョン受信機に近接して使用されると、受信障害を引き起こすことがあります。

取扱説明書に従って正しい取り扱いをして下さい。

KC: Korea Warning Statement

B급 기기 (가정용 방송통신기자재)

이 기기는 가정용(B급) 전자파적합기기로서 주로 가정에서 사용하는 것을 목적으로 하며, 모든 지역에서 사용할 수 있습니다.

*당해 무선설비는 전파혼신 가능성이 있으므로 인명안전과 관련된 서비스는 할 수 없습니다.

REACH

Complying with the REACH (Registration, Evaluation, Authorisation, and Restriction of Chemicals) regulatory framework, we published the chemical substances in our products at ASUS REACH website at <http://csr.asus.com/english/REACH.htm>.



DO NOT throw the motherboard in municipal waste. This product has been designed to enable proper reuse of parts and recycling. This symbol of the crossed out wheeled bin indicates that the product (electrical and electronic equipment) should not be placed in municipal waste. Check local regulations for disposal of electronic products.



DO NOT throw the mercury-containing button cell battery in municipal waste. This symbol of the crossed out wheeled bin indicates that the battery should not be placed in municipal waste.

ASUS Recycling/Takeback Services

ASUS recycling and takeback programs come from our commitment to the highest standards for protecting our environment. We believe in providing solutions for you to be able to responsibly recycle our products, batteries, other components as well as the packaging materials. Please go to <http://csr.asus.com/english/Takeback.htm> for detailed recycling information in different regions.

ASUS contact information

ASUSTeK COMPUTER INC.

Address	15 Li-Te Road, Peitou, Taipei, Taiwan 11259
Telephone	+886-2-2894-3447
Fax	+886-2-2890-7798
E-mail	info@asus.com.tw
Web site	www.asus.com.tw

Technical Support

Telephone	+86-21-38429911
Online support	support.asus.com

ASUS COMPUTER INTERNATIONAL (America)

Address	800 Corporate Way, Fremont, CA 94539, USA
Telephone	+1-812-282-3777
Fax	+1-510-608-4555
Web site	usa.asus.com

Technical Support

Telephone	+1-812-282-2787
Support fax	+1-812-284-0883
Online support	support.asus.com

ASUS COMPUTER GmbH (Germany and Austria)

Address	Harkort Str. 21-23, D-40880 Ratingen, Germany
Fax	+49-2102-959911
Web site	www.asus.de
Online contact	www.asus.de/sales

Technical Support

Telephone	+49-1805-010923*
Support Fax	+49-2102-9599-11
Online support	support.asus.com

* EUR 0.14/minute from a German fixed landline; EUR 0.42/minute from a mobile phone.

DECLARATION OF CONFORMITY

Per FCC Part 2 Section 2.1077(a)



Responsible Party Name: **Asus Computer International**

Address: **800 Corporate Way, Fremont, CA 94539.**

Phone/Fax No: **(510)739-3777/(510)608-4555**

hereby declares that the product

Product Name : Motherboard

Model Number : M5A97 R2.0

Conforms to the following specifications:

- FCC Part 15, Subpart B, Unintentional Radiators

Supplementary Information:

This device complies with part 15 of the FCC Rules. Operation is subject to the following two conditions: (1) This device may not cause harmful interference, and (2) this device must accept any interference received, including interference that may cause undesired operation.

Representative Person's Name : Steve Chang / President

Signature : *Steve Chang*
Date : Jun. 04, 2012

Ver.: 120901

EC Declaration of Conformity



We, the undersigned,

Manufacturer: **ASUSTeK COMPUTER INC.**
Address, City: **4F, No. 150, LI-TE RD., PEITOLI, TAIPEI 112, TAIWAN**
Country: **TAIWAN**
Authorized representative in Europe: **ASUS COMPUTER GmbH**
Address, City: **HARKORT STR. 21-23, 40880 RATINGEN**
Country: **GERMANY**

declare the following apparatus:

Product name : **Motherboard**
Model name : **M5A97 R2.0**

conform with the essential requirements of the following directives:

2004/108/EC-EMC Directive

- EN 55022:2010
- EN 55024:2010
- EN 55013:2001/A1:2003/A2:2006
- EN 55020:2007/A1:2011

1989/56/EEC-R&TTE Directive

- EN 300 328 V1.7.1(2005-10)
- EN 300 440-1 V1.5.1(2010-08)
- EN 300 440-2 V1.4.1(2002-08)
- EN 300 440-3 V1.3.1(2005-11)
- EN 301 511 V5.0.2(2003-03)
- EN 301 908-1 V5.2.1(2011-05)
- EN 301 908-2 V1.1(2007-11)
- EN 301 889 V1.6.1(2011-11)
- EN 301 488-3A V1.5.1(2010-09)
- EN 302 544-2 V1.1.1(2009-01)
- EN 302 326-2 V1.1(2009-02)
- EN 302 326-3 V1.3.1(2007-09)
- EN 302 326-4 V1.4.1(2008-11)
- EN 300 330-2 V1.5.1(2010-02)
- EN 50169:2001
- EN 62311:2008

2006/95/EC-LVD Directive

- EN 60950-1/A11:2009
- EN 60950-1/A12:2011

2009/123/EC-EP Directive

- Regulation (EC) No. 1752/2008
- Regulation (EC) No. 642/2009

2011/65/EU-RoHS Directive

- Regulation (EC) No. 2762/2009

Ver. 121001



(EC conformity marking)

Position : **CEO**
Name : **Jerry Shien**

Jerry Shien

Signature : _____

Declaration Date: **Jan. 04, 2013**
Year to begin affixing CE marking: **2013**

Free Manuals Download Website

<http://myh66.com>

<http://usermanuals.us>

<http://www.somanuals.com>

<http://www.4manuals.cc>

<http://www.manual-lib.com>

<http://www.404manual.com>

<http://www.luxmanual.com>

<http://aubethermostatmanual.com>

Golf course search by state

<http://golfingnear.com>

Email search by domain

<http://emailbydomain.com>

Auto manuals search

<http://auto.somanuals.com>

TV manuals search

<http://tv.somanuals.com>