



# K8V-MX

User Guide

# Motherboard

**E2125**

**First Edition V1.00**

**July 2005**

**Copyright © 2005 ASUSTeK COMPUTER INC. All Rights Reserved.**

No part of this manual, including the products and software described in it, may be reproduced, transmitted, transcribed, stored in a retrieval system, or translated into any language in any form or by any means, except documentation kept by the purchaser for backup purposes, without the express written permission of ASUSTeK COMPUTER INC. ("ASUS").

Product warranty or service will not be extended if: (1) the product is repaired, modified or altered, unless such repair, modification or alteration is authorized in writing by ASUS; or (2) the serial number of the product is defaced or missing.

ASUS PROVIDES THIS MANUAL "AS IS" WITHOUT WARRANTY OF ANY KIND, EITHER EXPRESS OR IMPLIED, INCLUDING BUT NOT LIMITED TO THE IMPLIED WARRANTIES OR CONDITIONS OF MERCHANTABILITY OR FITNESS FOR A PARTICULAR PURPOSE. IN NO EVENT SHALL ASUS, ITS DIRECTORS, OFFICERS, EMPLOYEES OR AGENTS BE LIABLE FOR ANY INDIRECT, SPECIAL, INCIDENTAL, OR CONSEQUENTIAL DAMAGES (INCLUDING DAMAGES FOR LOSS OF PROFITS, LOSS OF BUSINESS, LOSS OF USE OR DATA, INTERRUPTION OF BUSINESS AND THE LIKE), EVEN IF ASUS HAS BEEN ADVISED OF THE POSSIBILITY OF SUCH DAMAGES ARISING FROM ANY DEFECT OR ERROR IN THIS MANUAL OR PRODUCT.

SPECIFICATIONS AND INFORMATION CONTAINED IN THIS MANUAL ARE FURNISHED FOR INFORMATIONAL USE ONLY, AND ARE SUBJECT TO CHANGE AT ANY TIME WITHOUT NOTICE, AND SHOULD NOT BE CONSTRUED AS A COMMITMENT BY ASUS. ASUS ASSUMES NO RESPONSIBILITY OR LIABILITY FOR ANY ERRORS OR INACCURACIES THAT MAY APPEAR IN THIS MANUAL, INCLUDING THE PRODUCTS AND SOFTWARE DESCRIBED IN IT.

Products and corporate names appearing in this manual may or may not be registered trademarks or copyrights of their respective companies, and are used only for identification or explanation and to the owners' benefit, without intent to infringe.

# Contents

Notices .....	vi
Safety information .....	vii
About this guide .....	viii
K8V-MX specifications summary .....	ix

## Chapter 1: Product Introduction

1.1 Welcome! .....	1-2
1.2 Package contents .....	1-2
1.3 Special features .....	1-2
1.3.1 Product highlights .....	1-2
1.3.2 ASUS unique features .....	1-4
1.4 Before you proceed .....	1-5
1.5 Motherboard overview .....	1-6
1.5.1 Motherboard layout .....	1-6
1.5.2 Placement direction .....	1-7
1.5.3 Screw holes .....	1-7
1.6 Central Processing Unit (CPU) .....	1-8
1.6.1 Overview .....	1-8
1.6.2 Installing the CPU .....	1-8
1.7 System memory .....	1-10
1.7.1 Overview .....	1-10
1.7.2 Memory configurations .....	1-10
1.7.3 Installing a DIMM .....	1-13
1.7.4 Removing a DIMM .....	1-13
1.8 Expansion slots .....	1-14
1.8.1 Installing an expansion card .....	1-14
1.8.2 Configuring an expansion card .....	1-14
1.8.3 PCI slots .....	1-16
1.8.4 AGP slot .....	1-16
1.9 Jumpers .....	1-17
1.10 Connectors .....	1-19
1.10.1 Rear panel connectors .....	1-19
1.10.2 Internal connectors .....	1-21

# Contents

## Chapter 2: BIOS Information

2.1	Managing and updating your BIOS.....	2-2
2.1.1	Creating a bootable floppy disk.....	2-2
2.1.2	Using AFUDOS to copy the current BIOS.....	2-2
2.1.3	Using AFUDOS to update the BIOS.....	2-3
2.1.4	Using ASUS EZ Flash to update the BIOS .....	2-5
2.2	BIOS Setup program .....	2-6
2.2.1	BIOS menu screen.....	2-7
2.2.2	Menu bar .....	2-7
2.2.3	Navigation keys.....	2-7
2.2.4	Menu items.....	2-8
2.2.5	Sub-menu items .....	2-8
2.2.6	Configuration fields .....	2-8
2.2.7	Pop-up window.....	2-8
2.2.8	Scroll bar .....	2-8
2.2.9	General help.....	2-8
2.3	Main menu .....	2-9
2.3.1	System Time .....	2-9
2.3.2	System Date .....	2-9
2.3.3	Legacy Diskette A.....	2-9
2.3.4	Diskette Write .....	2-9
2.3.5	Primary/Secondary IDE Master/Slave.....	2-10
2.3.6	System Information .....	2-11
2.4	Advanced menu.....	2-12
2.4.1	CPU Configuration .....	2-12
2.4.2	Chipset .....	2-15
2.4.3	Onboard Devices Configuration .....	2-19
2.4.4	PCI PnP.....	2-21
2.4.5	System Frequency/Voltage Configuration .....	2-22
2.5	Power menu.....	2-23
2.5.1	Suspend Mode .....	2-23
2.5.2	Repost Video on S3 Resume .....	2-23
2.5.3	ACPI 2.0 Support .....	2-23
2.5.4	ACPI APIC Support .....	2-23
2.5.5	APM Configuration .....	2-24
2.5.6	Hardware Monitor.....	2-26
2.6	Boot menu .....	2-27
2.6.1	Boot Device Priority.....	2-28
2.6.2	Boot Settings Configuration .....	2-29
2.6.3	Security .....	2-30
2.7	Exit menu.....	2-31

# Contents

## Chapter 3: Software Support

3.1	Installing an operating system .....	3-2
3.2	Support CD information .....	3-2
3.2.1	Running the support CD.....	3-2
3.2.2	Drivers menu .....	3-3
3.2.3	Utilities menu.....	3-3
3.2.4	Contacts menu .....	3-4

# Notices

## Federal Communications Commission Statement

This device complies with Part 15 of the FCC Rules. Operation is subject to the following two conditions:

- This device may not cause harmful interference, and
- This device must accept any interference received including interference that may cause undesired operation.

This equipment has been tested and found to comply with the limits for a Class B digital device, pursuant to Part 15 of the FCC Rules. These limits are designed to provide reasonable protection against harmful interference in a residential installation. This equipment generates, uses and can radiate radio frequency energy and, if not installed and used in accordance with manufacturer's instructions, may cause harmful interference to radio communications. However, there is no guarantee that interference will not occur in a particular installation. If this equipment does cause harmful interference to radio or television reception, which can be determined by turning the equipment off and on, the user is encouraged to try to correct the interference by one or more of the following measures:

- Reorient or relocate the receiving antenna.
- Increase the separation between the equipment and receiver.
- Connect the equipment to an outlet on a circuit different from that to which the receiver is connected.
- Consult the dealer or an experienced radio/TV technician for help.



---

To assure compliance with FCC regulations, use shielded cables to connect the monitor to the graphics card. Changes to this unit not expressly approved by the party responsible for compliance can void the user's authority to operate this equipment.

---

## Canadian Department of Communications Statement

This digital apparatus does not exceed the Class B limits for radio noise emissions from digital apparatus set out in the Radio Interference Regulations of the Canadian Department of Communications.

**This class B digital apparatus complies with Canadian ICES-003.**

# Safety Information

## Electrical safety

- To prevent electrical shock hazard, disconnect the power cable from the electrical outlet before relocating the system.
- When adding or removing devices to or from the system, ensure that the power cables for the devices are unplugged before the signal cables are connected. If possible, disconnect all power cables from the existing system before you add a device.
- Before connecting or removing signal cables from the motherboard, ensure that all power cables are unplugged.
- Seek professional assistance before using an adapter or extension cord. These devices can interrupt the grounding circuit.
- Set your power supply to the correct voltage in your area. If you are not sure about the voltage of the electrical outlet you are using, contact your local power company.
- If the power supply is broken, do not try to fix it by yourself. Contact a qualified service technician or your retailer.

## Operational safety

- Before installing the motherboard and adding devices on it, carefully read all the manuals that came with the package.
- Before using the product, make sure all cables are correctly connected and the power cables are not damaged. If you detect any damage, contact your dealer immediately.
- To avoid short circuits, keep paper clips, screws, and staples away from connectors, slots, sockets, and circuitry.
- Avoid dust, humidity, and temperature extremes. Do not place the product in any area where it can get wet.
- Place the product on a stable surface.
- If you encounter technical problems with the product, contact a qualified service technician or your retailer.

# About This Guide

## Conventions used in this guide

To make sure that you perform certain tasks properly, take note of the following symbols used throughout this guide.



**WARNING:** Information to prevent injury to yourself when trying to complete a task.



**CAUTION:** Information to prevent damage to the components when trying to complete a task.



**IMPORTANT:** Instructions that you **MUST** follow to complete a task.



**NOTE:** Tips and additional information to help you complete a task.

## Where to find more information

Refer to the following sources for additional information and for product and software updates.

### 1. ASUS websites

The ASUS websites worldwide provide updated information on ASUS hardware and software products. Refer to the ASUS contact information.

### 2. Optional documentation

Your product package may include optional documentation, such as warranty flyers, that may have been added by your dealer. These documents are not part of the standard package.



# K8V-MX Specifications Summary

<b>CPU</b>	Socket 754 for AMD Athlon™ 64 processor with 800 MHz FSB frequency and built-in L2 cache up to 1 MB AMD Athlon™ 64 architecture supports simultaneous 32-bit and 64-bit computing
<b>Chipset</b>	VIA K8M800 VIA VT8237R
<b>System bus</b>	1600MT/s
<b>Memory</b>	2 x 184-pin DDR DIMM sockets for up to 2 GB unbuffered ECC, non-ECC DDR 400/333/266 DRAM memory
<b>Expansion slots</b>	1 x AGP8X 3 x PCI
<b>VGA</b>	Integrated Graphics
<b>Storage</b>	2 x Serial ATA, RAID 0, RAID 1, JBOD 2 x UltraDMA 133/100/66
<b>Audio</b>	ADI AD1888 SoundMAX 6-channel audio CODEC S/PDIF out interface
<b>LAN</b>	Integrated 10/100 Mbps LAN controller in the southbridge with Realtek RTL8201CL LAN PHY
<b>USB 2.0</b>	Supports up to 8 USB 2.0 ports
<b>Rear panel I/O ports</b>	1 x Parallel port 1 x Serial port 1 x PS/2 keyboard port 1 x PS/2 mouse port 1 x VGA port 1 x Audio I/O port 1 x LAN (RJ-45) port 4 x USB 2.0 ports

(Continued on the next page)

# K8V-MX Specifications Summary

<b>Internal I/O connectors</b>	2 x USB connectors supports additional 4 USB ports 20-pin ATX power connector 4-pin ATX 12V power connector CD/AUX audio in Chassis Intrusion CPU/chassis fan connectors Front panel audio connector S/PDIF out connector
<b>BIOS features</b>	4Mb Flash ROM, AMI BIOS, (TCAV), PnP, DMI2.0, WfM2.0, SM BIOS 2.3, ASUS EZ Flash, ASUS CrashFree BIOS 2
<b>Industry standard</b>	PCI 2.2, USB 2.0/1.1
<b>ASUS Special features</b>	Adjustable FSB/DDR ratio ASUS C.P.R. ASUS MyLogo 2 SFS (Stepless Frequency Selection) from 200MHz up to 240MHz at 1MHz increment
<b>Manageability</b>	WfM 2.0, DMI 2.0, WOR, WOL by PME, WOR by PME, WO USB, WO KB/MS
<b>Support CD</b>	Drivers ASUS PC Probe Anti-Virus Software ASUS LiveUpdate
<b>Accessory</b>	User's manual Ultra DMA cable FDD cable I/O shield SATA cable
<b>Form factor</b>	microATX, 9.6" x 9.6" (24.5cm x 24.5cm)

Specifications are subject to change without notice.

# Chapter 1

This chapter describes the features of this motherboard. It includes brief explanations of the special attributes of the motherboard and the new technology it supports.

## Product Introduction

# 1.1 Welcome!

Thank you for buying the ASUS® K8V-MX motherboard!

The ASUS K8V-MX motherboard delivers a host of new features and latest technologies making it another standout in the long line of ASUS quality motherboards!

Before you start installing the motherboard, and hardware devices on it, check the items in your package with the list below.

## 1.2 Package Contents

Check your K8V-MX package for the following items.

- ✓ ASUS K8V-MX motherboard
- ✓ ASUS motherboard support CD
- ✓ 1 x Ultra DMA cable
- ✓ 2 x Serial ATA cables
- ✓ 1 x FDD cable
- ✓ I/O shield
- ✓ User guide



---

If any of the above items is damaged or missing, contact your retailer.

---

## 1.3 Special Features

### 1.3.1 Product highlights

#### AMD Athlon™ 64 processor support



The K8V-MX supports AMD Athlon 64 and AMD Sempron processors: The AMD Athlon 64 processor is based on AMD 64 technology, which represents the landmark introduction of the industry's first x86-64 technology. 64-bit computing, the next generation technology to replace current 32-bit architecture, delivers advanced system performance, faster memory access and increased productivity. This motherboard provides excellent compatibility and flexibility.

#### Serial ATA RAID



The on board VT8237R southbridge provides the complete solution to your RAID requirements on different disk array standards, and supports RAID 0,1 and JBOD on 2 Serial ATA ports.

## VIA K8M800 and VT8237R chipset



The VIA K8M800 northbridge is a 64-bit processor controller that utilizes the HyperTransport™ bus link to interconnect with the AMD 64 processor. The VIA K8M800 features an Integrated Graphics Processor (IGP) to deliver exceptional integrated graphics and video playback performance.

The VT8237R southbridge employs the VIA DriveStation™ Controller Suite that enables multiple drive configuration through native Serial ATA, RAID, and Parallel ATA/133 support. This chip also supports USB 2.0, MC97, PCI and LPC interfaces and allows 6-channel audio through the VIA Vinyl Audio technology. When Serial ATA installing OS, there is no need to set up drive.

### DDR400 support



DDR 400 (PC3200), the latest and fastest DDR memory standard, supports bandwidth up to 3.2GB/s to provide enhanced system performance.

### Integrated 10/100 Mbps LAN



The on-board LAN controller is a highly integrated FAST Ethernet controller. It is enhanced with an ACPI management function to provide efficient power management for advanced operating systems.

## 6 Channel Audio & SoundMAX Digital Audio System

The SoundMAX Digital Audio System is the industry's highest performance and most reliable audio solution for business professionals, audiophiles, musicians, and gamers. SoundMAX Digital Audio System can output 5.1 channel surround sound and features state.

### AGP 8X support



AGP 8X (AGP 3.0) is the next generation VGA interface specification that enables enhanced graphics performance with high bandwidth speeds of up to 2.12 GB/s.

### USB 2.0 technology



USB 2.0 is the latest connectivity standard for next generation components and peripherals.

Backwards compatible with current USB 1.1 peripherals, USB 2.0 delivers transfer speeds up to 40 times faster at 480MB/s, for easy connectivity.

## S/PDIF out

The K8V-MX's S/PDIF-out function turns your computer into a high-end entertainment system with digital connectivity to powerful speaker systems. **See page 1-17.**

## AMD Cool 'n' Quiet! Technology

The K8V-MX supports AMD Cool 'n' Quiet! Technology, which monitors system operation and automatically adjusts CPU voltage and frequency for a cool and quiet environment..

## 1.3.2 ASUS unique features

### EZ Flash BIOS

With the ASUS EZ Flash, you can easily update the system BIOS even before loading the operating system. No need to use a DOS-based utility or boot from a floppy disk. **See page 2-5.**

### Q-Fan Technology

The ASUS Q-Fan technology smartly adjusts the fan speeds according to the system loading to ensure quiet, cool, and efficient operation.

### CrashFree BIOS 2

Whenever BIOS gets corrupted, ASUS CrashFree BIOS2 allows users to reboot the computer and perform an smart auto-recovery procedure through the motherboard support CD.

### C.P.R. (CPU Parameter Recall)

When the system hangs due to overclocking failure, there is no need to open the case to clear CMOS data. Just simply restart the system, the BIOS would show the previous setting and then users can amend the CPU setting again.

# 1.4 Before You Proceed

Take note of the following precautions before you install motherboard components or change any motherboard settings.



- Unplug the power cord from the wall socket before touching any component.
- Use a grounded wrist strap or touch a safely grounded object or to a metal object, such as the power supply case, before handling components to avoid damaging them due to static electricity.
- Hold components by the edges to avoid touching the ICs on them.
- Whenever you uninstall any component, place it on a grounded antistatic pad or in the bag that came with the component.
- Before you install or remove any component, ensure that the ATX power supply is switched off or the power cord is detached from the power supply. Failure to do so may cause severe damage to the motherboard, peripherals, and/or components.

## Onboard LED

The motherboard comes with a standby power LED that lights up to indicate that the system is ON, in sleep mode, or in soft-off mode. This is a reminder that you should shut down the system and unplug the power cable before removing or plugging in any motherboard component.

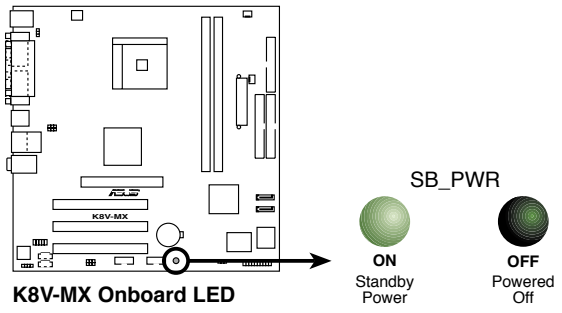

# 1.5 Motherboard Overview

## 1.5.1 Motherboard layout

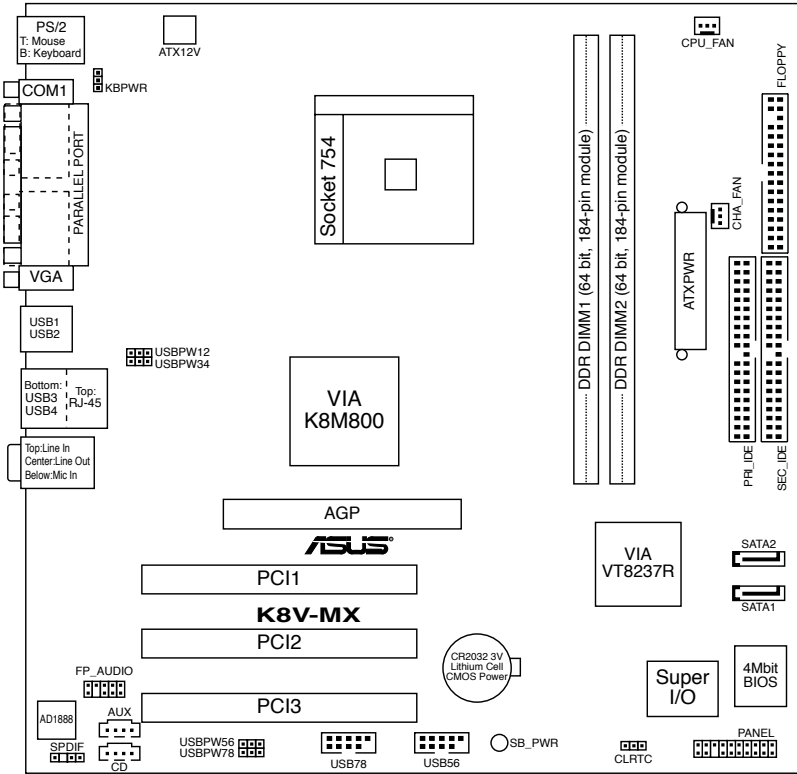



## 1.5.2 Placement direction

When installing the motherboard, make sure that you place it into the chassis in the correct orientation. The edge with external ports goes to the rear part of the chassis as indicated in the image below.

## 1.5.3 Screw holes

Place eight (8) screws into the holes indicated by circles to secure the motherboard to the chassis.



Do not overtighten the screws! Doing so may damage the motherboard.

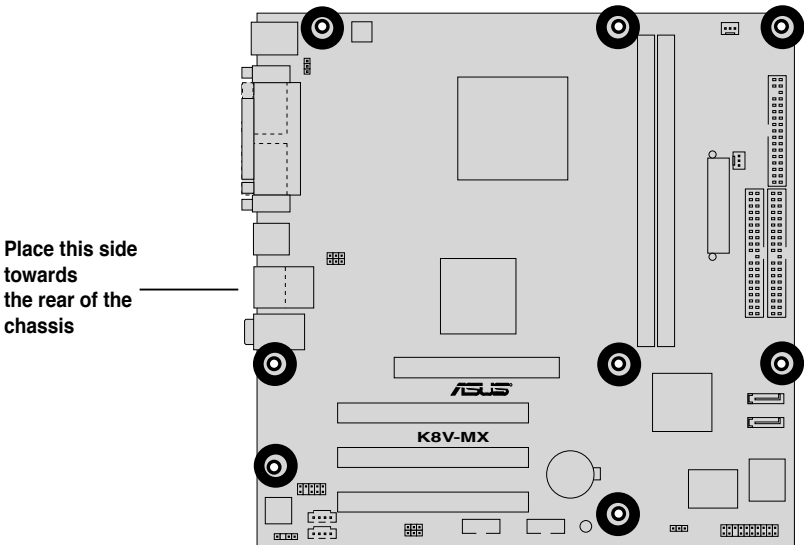

# 1.6 Central Processing Unit (CPU)

## 1.6.1 Overview

The AMD Athlon™ 64 processor has a gold triangle in one corner. This mark indicates the processor Pin A1 that should match a specific corner of the CPU socket.

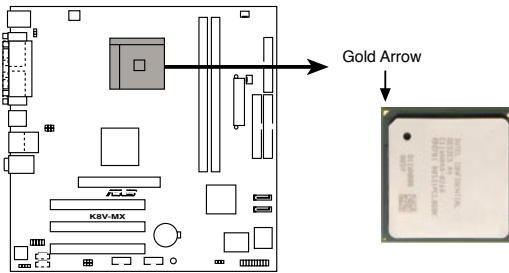

**K8V-MX CPU Socket 754**



Incorrect installation of the CPU into the socket may bend the pins and severely damage the CPU!

## 1.6.2 Installing the CPU

Follow these steps to install a CPU.

1. Locate the 754-pin ZIF socket on the motherboard.
2. Unlock the socket by pressing the lever sideways, then lift it up to a 90°-100° angle.



Make sure that the socket lever is lifted up to 90°-100° angle, otherwise the CPU does not fit in completely.

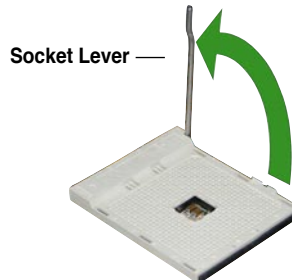

3. Position the CPU above the socket such that the CPU corner with the gold triangle matches the socket corner with a small triangle.
4. Carefully insert the CPU into the socket until it fits in place.

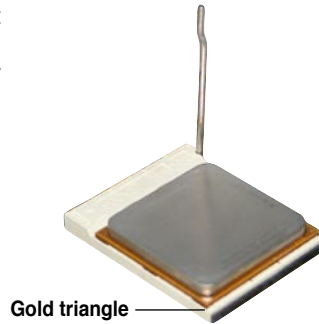

---

The CPU fits only in one correct orientation. DO NOT force the CPU into the socket to prevent bending the pins and damaging the CPU!

---

5. When the CPU is in place, push down the socket lever to secure the CPU. The lever clicks on the side tab to indicate that it is locked.
6. Install a CPU heatsink and fan following the instructions that came with the heatsink package.
7. Connect the CPU fan cable to the CPU\_FAN connector on the motherboard.

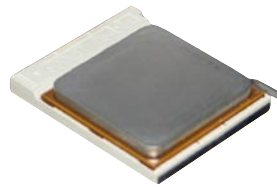

# 1.7 System memory

## 1.7.1 Overview

The motherboard comes with two Double Data Rate (DDR) Dual Inline Memory Module (DIMM) sockets. These sockets support up to 2GB system memory using 184-pin PC3200/PC2700/PC2100 unbuffered DDR DIMMs and allow up to 3.2 GB/s data transfer rate.

The following figure illustrates the location of the DDR DIMM sockets.

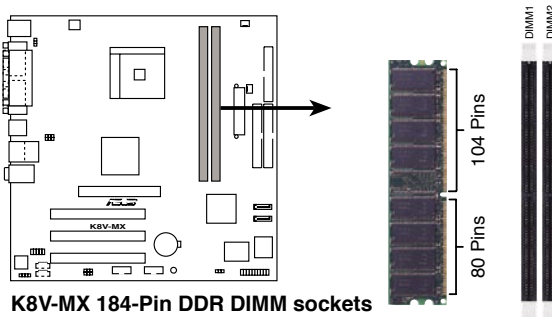

## 1.7.2 Memory configurations

You may install 64 MB, 128 MB, 256 MB, 512 MB and 1 GB DDR DIMMs into the DIMM sockets.



---

For optimum compatibility, it is recommended that you obtain memory modules from qualified vendors. See the Qualified Vendors List (QVL) next page.

---

## Qualified DDR400 DIMMs

The following table lists the PC3200 (DDR400) memory modules that have been tested and qualified for use with this motherboard.



Obtain DDR DIMMs only from qualified vendors for better system performance.

### DDR400 Qualified Vendor List (QVL)

Size	Vendor	Model	Brand	Side(s)	Component	DIMM support	A* B*
256MB	KINGSTON	KVR400X64C3A/256	Hynix	SS	HY5DU56822BT-D43		•
512MB	KINGSTON	KVR400X64C3A/512	Hynix	DS	HY5DU56822BT-D43		• •
256MB	KINGSTON	KVR400X64C3A/256	PSC	SS	A2556D308TP		• •
512MB	KINGSTON	KVR400X64C3A/512	Hynix	SS	HY5DU12822BT-D43		• •
256MB	KINGSTON	KVR400X64C3A/256	KINGSTON	SS	D3208DL3T-5A		•
512MB	KINGSTON	KVR400X64C3A/512	KINGSTON	DS	D3208DH1T-5		• •
256MB	KINGSTON	KVR333X64C25/256	KINGSTON	SS	D3208DH1T-6		•
512MB	KINGSTON	KVR333X64C25/512	KINGSTON	DS	D3208DH1T-6		•
256MB	KINGSTON	KVR333X64C25/256	Hynix	DS	HY5DU56822BT-D43		• •
1GB	KINGSTON	KVR400X64C3A/1G	Infineon	DS	HYB25D512800BE-5B		• •
256MB	Infineon	HY564D32300GU-5-C	Infineon	SS	HYB25D256800CE-5C		• •
512MB	Infineon	HY564D64320GU-5-C	Infineon	DS	HYB25D256800CE-5C		• •
512MB	Infineon	HY564D64300GU-5-B	Infineon	SS	HYB25D512800CE-5B		• •
256MB	Infineon	HY564D32300GU-5-C	Infineon	SS	HYB25D256800CE-5C		• •
512MB	Infineon	HY564D64320GU-5-C	Infineon	DS	HYB25D256800CE-6C		• •
256MB	HY	HYMD232646D8J-D43	Hynix	SS	HY5DU56822DT-D43		• •
512MB	HY	HYMD264646D8J-D43	Hynix	DS	HY5DU56822DT-D43		• •
256MB	HY	HYMD232646D8J-J	Hynix	SS	HY5DU56822BT-J		• •
512MB	HY	HYMD264646D8J-J	Hynix	DS	HY5DU56822BT-J		• •
256MB	CORSAIR	VS256MB400	Value select	SS	VS32M8-5 2B0409		• •
256MB	CORSAIR	XMS3202V3.1	Infineon	SS	HYB25D256807BT-5B		• •
512MB	CORSAIR	XMS3205V1.2	Winbond	DS	W942508CH-5		•
512MB	CORSAIR	VS512MB400	Value select	DS	VS32M8-5 2B0402		• •
256MB	CORSAIR	XMS2700V1.1	Winbond	SS	W942508BH-6		• •
256MB	CORSAIR	VS256MB333	SAMSUNG	SS	K4H5608380-TCB3		• •
512MB	CORSAIR	XMS2702V3.1	Mosel	DS	V58C2256804SAT6		• •
512MB	CORSAIR	XMS3205V1.2	Winbond	DS	W942508CH-6		• •
512MB	MICRON	MT16VDDT6464AG-335GB	MICRON	DS	MT46V32M8TG-6TG		• •
256MB	MICRON	MT8VDDT3264AG-335GB	MICRON	SS	MT46V32M8TG-6TG		• •
256MB	MICRON	MT8VDDT3264AG-40GB	MICRON	SS	MT46V32M8TG-5BG		• •
512MB	MICRON	MT16VDDT6464AG-40BCB	MICRON	DS	MT46V32M8TG-5BC		• •
256MB	SAMSUNG	M368L3223FTN-CCC	SAMSUNG	SS	K4H560838F-TCCC		• •
512MB	SAMSUNG	M368L6423FTN-CCC	SAMSUNG	DS	K4H560838F-TCCC		• •
256MB	SAMSUNG	M368L3223FTN-CB3	SAMSUNG	SS	K4H560838F-TCB3		• •
512MB	SAMSUNG	M368L6423FTN-CB3	SAMSUNG	DS	K4H560838F-TCB3		• •
256MB	Winbond	U24256ADWBG6H20	Winbond	SS	W942508CH-5		• •
256MB	Winbond	U24256AAWBG6H20	Winbond	SS	W942508CH-6		• •
512MB	Winbond	DDR333-512	Winbond	DS	W942508BH-6		• •
512MB	Winbond	U24512ADWBG6H20	Winbond	DS	W942508CH-5		• •
256MB	Elpida	U24256ADWBG6H20	Elpida	SS	DD2508AKTA-5C		• •
512MB	Elpida	U24512ADWBG6H20	Elpida	DS	DD2508AMTA		• •
256MB	Transcend	DDR400-256	SAMSUNG	SS	K4H560838F-TCCC		• •
256MB	Transcend	DDR400-256	Mosel	SS	V58C2256804SAT5B		• •
256MB	Transcend	103004-0720	PSC	SS	A2556D308TP		• •
512MB	Transcend	102709-0001	PSC	DS	A2556D30ATP		• •
512MB	Transcend	DDR400-512	Mosel	DS	V58C2256804SAT5B		• •
512MB	Transcend	DDR400-512	SAMSUNG	DS	K4H560838F-TCCC		• •
256MB	Transcend	111448-0214	PSC	SS	A2556D308TP		• •
512MB	Transcend	DDR333-512	Hynix	DS	HY5DU56822CT-J		• •
256MB	Pmi	3208GATA07-04A7	Pmi	SS	PM4D328550403DU		• •
512MB	Pmi	3208GATA01-04A4	Pmi	DS	PM4D328550403DU		• •
256MB	KINGMAX	MPMB62D-38LT3R	Mosel	SS	V58C2256804SAT6		• •
512MB	KINGMAX	MPMC22D-38HT3R	Hynix	DS	HY5DU56822BT-J		• •
256MB	KINGMAX	MPXB62D-38KT3R	KINGMAX	SS	KDL388P4LA-50		• •

(Continued on the next page)

## DDR400 Qualified Vendors List

Size	Vendor	Model	Brand	Side(s)	Component	DIMM support	A* B*
256MB	Mosel	V826632K24SATG-D3	Mosel	SS	V58C2256804SAT5		• •
512MB	Mosel	V826664K24SATG-D3	Mosel	DS	V58C2256804SAT5		•
256MB	NANYA	NT256D64S88B1G-5T	NANYA	SS	NT5DS32M88T-5T		• •
512MB	NANYA	NT512D64S88B1G-5T	NANYA	DS	NT5DS32M88T-5T		• •
256MB	Apacer	77.10636.46G	SAMSUNG	SS	K4H560838E-TCCC		• •
512MB	Apacer	77.90728.U1G	Apacer	DS	AM3A568AJT-6B		• •
256MB	Apacer	77.10636.56G	Mosel	SS	V58C2256804Sat5B		• •
512MB	Apacer	77.10736.11G	Infineon	DS	HYB25D256800BT-5B		•
256MB	Smart	U24256ADSRG6H20	Smart	SS	D32M8XS50H3X4AMV		•
256MB	Smart	U24256ADSRG6H20	Smart	SS	D32M8XS60HBX4AMV		• •
512MB	Smart	U24512ADSRG6H20	Smart	DS	D32M8XS50H3X4AMV		•
512MB	Smart	U24512ADSRG6H20	Smart	DS	D32M8XS60HBX4AMV		• •
256MB	TwinMOS	DDR333-256	TwinMOS	SS	TMD7608F8E60B		• •
256MB	TwinMOS	M2G9I08A-TT	TwinMOS	SS	TMD7608F8E501		• •
512MB	TwinMOS	M2G9J16A-TT	TwinMOS	DS	TMD7608F8E501		•
256MB	Promos	V826632K24SCTG-D0	Promos	SS	V58C2256804SCT5B		• •
512MB	Promos	V826664K24SCTG-D0	Promos	DS	V58C2256804SCT5B		• •
512MB	BiaoXing	BXXC22D-38KT3B	BiaoXing	DS	VM256D328BT-5		• •
256MB	Vdata	MDYVD6F4G2880B1E0H	Vdata	SS	VDD9616A8A-5C		• •

### Legend:

- A - supports one module inserted into either slot, in a Single-channel memory configuration.
- B - supports on pair of modules inserted into either the blue slots or the black slots as one pair of Dual-channel memory configuration.

SS - Single-sided

DS - Double-sided

## 1.7.3 Installing a DIMM



Make sure to unplug the power supply before adding or removing DIMMs or other system components. Failure to do so may cause severe damage to both the motherboard and the components.

Follow these steps to install a DIMM.

1. Locate the DIMM sockets in the motherboard.
2. Unlock a DIMM socket by pressing the retaining clips outward.
3. Align a DIMM on the socket such that the notch on the DIMM matches the break on the socket.

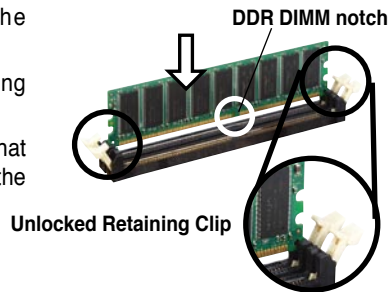

A DDR DIMM is keyed with a notch so that it fits in only one direction. DO NOT force a DIMM into a socket to avoid damaging the DIMM.

4. Firmly insert the DIMM into the socket until the retaining clips snap back in place and the DIMM is properly seated.

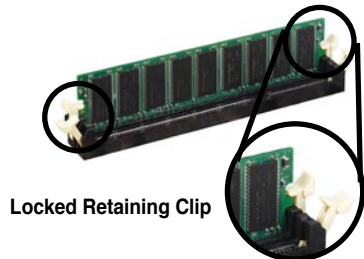

## 1.7.4 Removing a DIMM

Follow these steps to remove a DIMM.

1. Simultaneously press the retaining clips outward to unlock the DIMM.

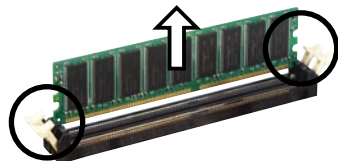

Support the DIMM lightly with your fingers when pressing the retaining clips. The DIMM might get damaged when it flips out with extra force.

2. Remove the DIMM from the socket.

# 1.8 Expansion slots

In the future, you may need to install expansion cards. The following sub-sections describe the motherboard slots and the expansion cards that they support.



---

Make sure to unplug the power cord before adding or removing expansion cards. Failure to do so may cause you physical injury and damage motherboard components.

---

## 1.8.1 Installing an expansion card

Follow these steps to install an expansion card.

1. Before installing the expansion card, read the documentation that came with it and make the necessary hardware settings for the card.
2. Remove the system unit cover (if your motherboard is already installed in a chassis).
3. Remove the bracket opposite the slot that you intend to use. Keep the screw for later use.
4. Align the card connector with the slot and press firmly until the card is completely seated on the slot.
5. Secure the card to the chassis with the screw you removed earlier.
6. Replace the system cover.

## 1.8.2 Configuring an expansion card

After installing the expansion card, configure the card by adjusting the software settings.

1. Turn on the system and change the necessary BIOS settings, if any. See Chapter 2 for information on BIOS setup.
2. Assign an IRQ to the card. Refer to the tables on the next page.
3. Install the software drivers for the expansion card.



## Standard Interrupt Assignments

IRQ	Priority	Standard Function
0	1	System Timer
1	2	Keyboard Controller
2	N/A	Programmable Interrupt
3	11	Communications Port (COM2)
4*	12	Communications Port (COM1)
5*	13	Sound Card (sometimes LPT2)
6	14	Floppy Disk Controller
7*	15	Printer Port (LPT1)
8	3	System CMOS/Real Time Clock
9*	4	ACPI Mode when used
10*	5	IRQ Holder for PCI Steering
11*	6	IRQ Holder for PCI Steering
12*	7	PS/2 Compatible Mouse Port
13	8	Numeric Data Processor
14*	9	Primary IDE Channel
15*	10	Secondary IDE Channel

\* These IRQs are usually available for ISA or PCI devices.

## IRQ assignments for this motherboard

	INT A	INT B	INT C	INT D
PCI slot 1	shared	—	—	—
PCI slot 2	—	shared	—	—
PCI slot 3	—	—	shared	—
AGP slot	shared	—	—	—



When using PCI cards on shared slots, ensure that the drivers support “Share IRQ” or that the cards do not need IRQ assignments; otherwise, conflicts will arise between the two PCI groups, making the system unstable and the card inoperable.

### 1.8.3 PCI slots

The PCI slots support LAN, SCSI, USB, and other PCI cards that comply with PCI specifications. The figure below shows a LAN card installed on a PCI slot.

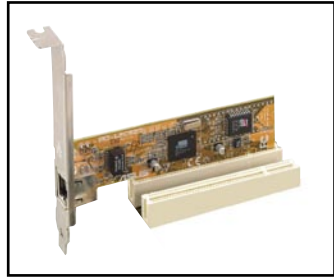

### 1.8.4 AGP slot

The Accelerated Graphics Port (AGP) slot supports AGP 8X (AGP 3.0) specification. Note the notches on the card golden fingers to ensure that they fit the AGP slot on your motherboard.



Install only 1.5V AGP cards on this motherboard! 3.3V AGP cards are not supported in this motherboard.

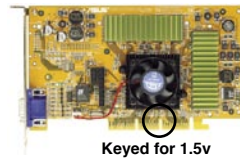
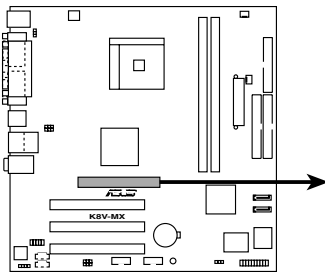

**K8V-MX Accelerated Graphics Port (AGP)**

# 1.9 Jumpers

## 1. Clear RTC RAM (CLRRTC)

This jumper allows you to clear the Real Time Clock (RTC) RAM in CMOS. You can clear the CMOS memory of date, time, and system setup parameters by erasing the CMOS RTC RAM data. The RAM data in CMOS, that include system setup information such as system passwords, is powered by the onboard button cell battery.

To erase the RTC RAM:

1. Turn OFF the computer and unplug the power cord.
2. Remove the onboard battery.
3. Move the jumper cap from pins 1-2 (default) to pins 2-3. Keep the cap on pins 2-3 for about 5~10 seconds, then move the cap back to pins 1-2.
4. Replace the battery.
5. Plug the power cord and turn ON the computer.
6. Hold down the <Del> key during the boot process and enter BIOS setup to re-enter data.



Except when clearing the RTC RAM, never remove the cap on the CLRRTC jumper default position. Removing the cap will cause system boot failure!

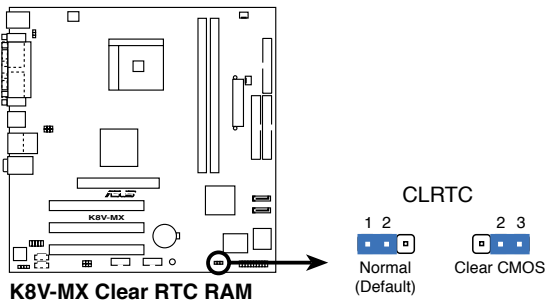

## 2. Keyboard power (3-pin KBPWR)

This jumper allows you to enable or disable the keyboard wake-up feature. Set this jumper to pins 2-3 (+5VSB) if you wish to wake up the computer when you press a key on the keyboard (the default value is [Disabled]). This feature requires an ATX power supply that can supply at least 1A on the +5VSB lead, and a corresponding setting in the BIOS (see section 2.5.5 APM Configuration).

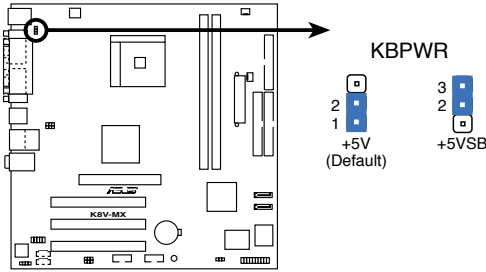

**K8V-MX Keyboard power setting**

## 3. USB device wake-up (3-pin USBPWR12, USBPWR34, USBPWR56, USBPWR78)

Set these jumpers to +5V to wake up the computer from S1 sleep mode (CPU stopped, DRAM refreshed, system running in low power mode) using the connected USB devices. Set to +5VSB to wake up from S3 sleep mode (no power to CPU, DRAM in slow refresh, power supply in reduced power mode).

The USBPWR12 and USBPWR34 jumpers are for the rear USB ports. The USBPWR56 and USBPWR78 jumpers are for the internal USB connectors that you can connect to additional USB ports.

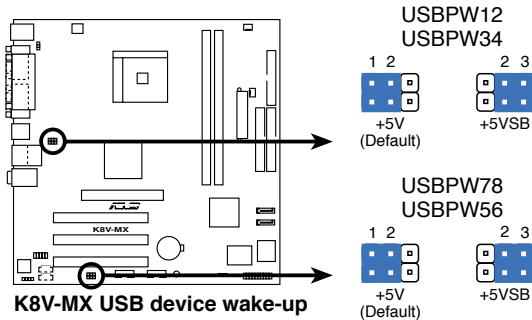

**K8V-MX USB device wake-up**



- The USB device wake-up feature requires a power supply that can provide 500mA on the +5VSB lead for each USB port; otherwise, the system would not power up.
- The total current consumed must NOT exceed the power supply capability (+5VSB) whether under normal condition or in sleep mode.

# 1.10 Connectors

This section describes and illustrates the rear panel and internal connectors on the motherboard.

## 1.10.1 Rear panel connectors

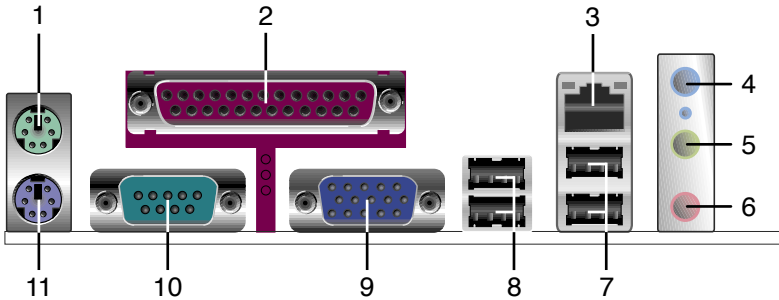

1. **PS/2 mouse port (green).** This 6-pin port is for a PS/2 mouse.
2. **Parallel port.** This 25-pin port connects a parallel printer, a scanner, or other devices.
3. **LAN (RJ-45) port.** This port allows connection to a Local Area Network (LAN) through a network hub.
4. **Line In port.** This Line In (light blue) port connects a tape player or other audio sources. In 4- or 6-channel mode, the function of this port becomes Rear Speaker Out.
5. **Line Out port.** This Line Out (lime) port connects a headphone or a speaker. In 4- or 6-channel mode, the function of this port becomes Front Speaker Out.
6. **Microphone port.** This Mic (pink) port connects a microphone. In 6-channel mode, the function of this port becomes Bass/Center Speaker.



The functions of the Line Out, Line In, and Microphone ports change when you select the 4- or 6-channel audio configuration as shown in the following table.

### Audio ports function variation

Audio ports	Headphone /2-Channel	4-Channel	6-Channel
Light Blue	Line In	Rear Speaker Out	Rear Speaker Out
Lime	Line Out	Front Speaker Out	Front Speaker Out
Pink	Mic In	Mic In	Bass/Center

7. **USB 2.0 ports 3 and 4.** These two 4-pin Universal Serial Bus (USB) ports are available for connecting USB 2.0 devices.
8. **USB 2.0 ports 1 and 2.** These two 4-pin Universal Serial Bus (USB) ports are available for connecting USB 2.0 devices
9. **Video Graphics Adapter port.** This 15-pin port is for a VGA monitor or other VGA-compatible devices.
10. **Serial port.** This 9-pin COM1 port is for pointing devices or other serial devices.
11. **PS/2 keyboard port (purple).** This port is for a PS/2 keyboard.

## 1.10.2 Internal connectors

### 1. Floppy disk drive connector (34-pin FLOPPY)

This connector is for the provided floppy drive (FDD) signal cable. Insert one end of the cable to this connector, then connect the other end to the signal connector at the back of the floppy disk drive.



Pin 5 on the connector is removed to prevent incorrect cable connection when using an FDD cable with a covered Pin 5.

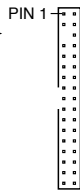
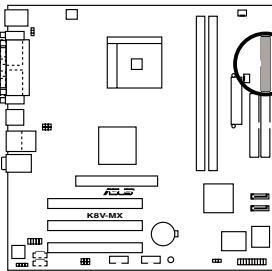

#### FLOPPY

**NOTE:** Orient the red markings on the floppy ribbon cable to PIN 1.

**K8V-MX Floppy disk drive connector**

### 2. Internal audio connector (4-pin CD, AUX)

These connectors allow you to receive stereo audio input from sound sources such as a CD-ROM, TV tuner, or MPEG card.

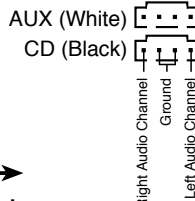
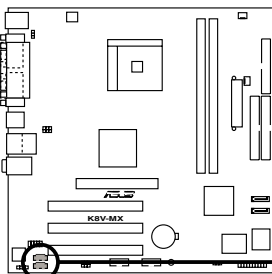

**K8V-MX Internal audio connectors**

### 3. IDE connectors (40-1 pin PRI\_IDE, SEC\_IDE)

These connectors support the provided Ultra ATA/133 IDE hard disk ribbon cable. Connect the cable's blue connector to the primary (recommended) or secondary IDE connector, then connect the gray connector to the Ultra ATA/133 slave device (hard disk drive) and the black connector to the Ultra ATA/133 master device. Connecting non-Ultra ATA/133 devices to the secondary IDE connector is recommended.

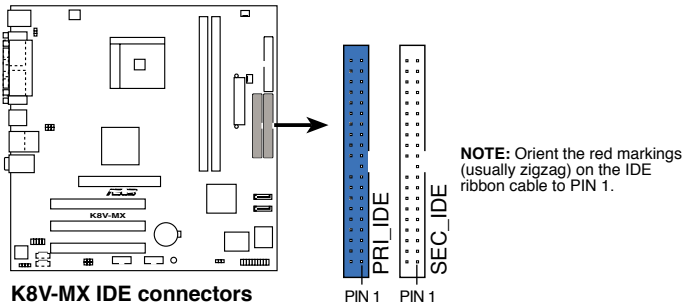

- Pin 20 on each IDE connector is removed to match the covered hole on the Ultra ATA cable connector. This prevents incorrect orientation when you connect the cables.
- For Ultra ATA/133 IDE devices, use an 80-conductor IDE cable.
- The hole near the blue connector on the Ultra ATA/133 cable is intentional.

### 4. Digital audio connector (3- pin SPDIF)

This connector is for the S/PDIF audio module that allows digital sound input.



- Use 75 ohm impedance matched coaxial cables for your S/PDIF connection.
- The S/PDIF module is purchased separately.

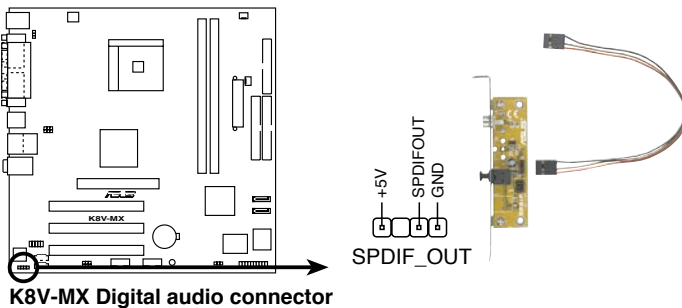



## 5. CPU and chassis fan connectors (3-pin CPU\_FAN, CHA\_FAN)

The fan connectors support cooling fans of 350mA~740mA (8.88W max.) or a total of 1A~2.22A (26.64W max.) at +12V. Connect the fan cables to the fan connectors on the motherboard, making sure that the black wire of each cable matches the ground pin of the connector.



Do not forget to connect the fan cables to the fan connectors. Insufficient air flow within the system can damage the motherboard components. These are not jumpers! DO NOT place jumper caps on the fan connectors!

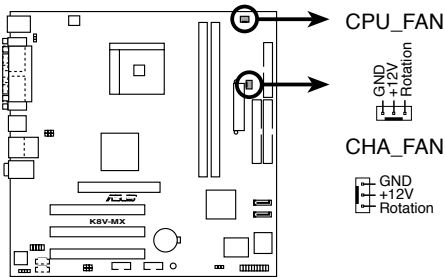

**K8V-MX Fan connectors**

## 6. ATX power connectors (20-pin ATXPWR, 4-pin ATX12V)

These connectors are for an ATX 12V power supply. The plugs from the power supply are designed to fit these connectors in only one orientation. Find the proper orientation and push down firmly until the connectors fit completely.



- Do not forget to connect the 4-pin ATX +12V power plug; otherwise, the system does not boot up.
- Make sure that your ATX 12V power supply can provide 12A on the +12V lead and at least 1A on the +5-volt standby lead (+5VSB). The minimum recommended wattage is 300 W, or 350 W for a fully configured system. The system can become unstable or will not boot up if the power is inadequate.

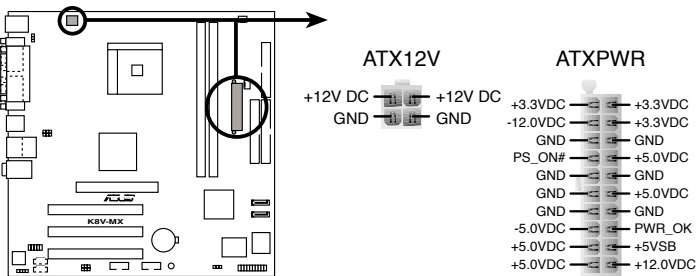

**K8V-MX ATX power connectors**

### 7. Serial ATA connectors (7-pin SATA1, SATA2)

These connectors support the thin Serial ATA cables for Serial ATA hard disks. If you installed Serial ATA hard disks, you may create a RAID 0 or RAID 1 configuration.

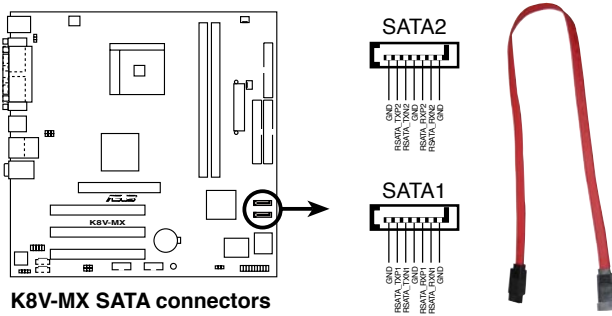

### 8. Front panel audio connector (10-1 pin FP\_AUDIO)

This interface for the Intel® front panel audio cable allows convenient connection and control of audio devices.

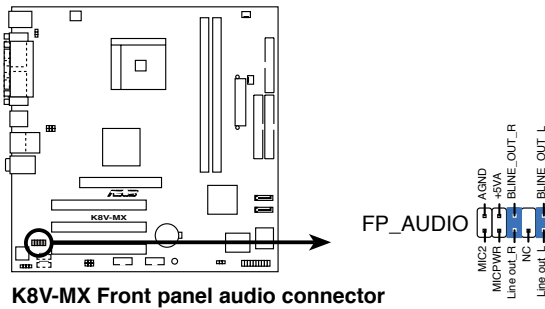

## 9. USB connectors (10-1 pin USB56, USB78)

These connectors are for USB 2.0 ports. Connect the USB module cable to any of these connectors, then install the module to a slot opening at the back of the system chassis. These USB connectors comply with USB 2.0 specification that supports up to 480 Mbps connection speed.



NEVER connect a **1394 cable** to the USB connectors. Doing so will damage the motherboard!

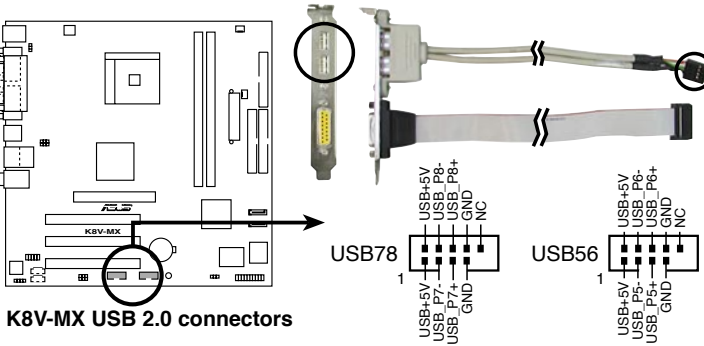

The USB module is purchased separately.

## 10. System panel connector (20-pin PANEL)

This connector supports several system chassis-mounted functions.

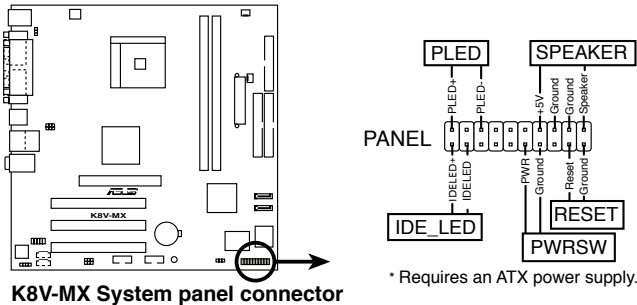

**K8V-MX System panel connector**

- **System power LED**

This connector is for the system power LED. Connect the chassis power LED cable to this connector. The system power LED lights up when you turn on the system power, and blinks when the system is in sleep mode.

- **System warning speaker**

This connector is for the chassis-mounted system warning speaker. The speaker allows you to hear system beeps and warnings.

- **Reset button (2-pin RESET)**

This connector is for the chassis-mounted reset button for system reboot without turning off the system power.

- **ATX power button/soft-off button (2-pin PWRBTN)**

This connector is for the system power button. Pressing the power button turns the system on or puts the system in sleep or soft-off mode depending on the BIOS settings. Pressing the power switch for more than four seconds while the system is ON turns the system OFF.

- **System Management Interrupt (2-pin SMI)**

This connector is for the chassis-mounted suspend switch that allows you to manually place the system into a suspend mode, or “green” mode. When in suspend mode, the system activity is instantly decreased to save power and to expand the life of certain system components.

- **Hard disk drive activity LED (2-pin HDLED)**

This connector is for the HDD Activity LED. Connect the HDD Activity LED cable to this connector. The IDE LED lights up or flashes when data is read from or written to the HDD.

# Chapter 2

This chapter tells how to change system settings through the BIOS Setup menus, and provides detailed descriptions of the BIOS parameters.

## BIOS Information

## 2.1 Managing and Updating Your BIOS

The following utilities allow you to manage and update the motherboard Basic Input/Output System (BIOS) setup.

1. **AFUDOS** (Updates the BIOS in DOS mode using a bootable floppy disk.)
2. **ASUS EZ Flash** (Updates the BIOS using a floppy disk during POST.)
3. **ASUS CrashFree BIOS 2** - Updates the BIOS using a bootable floppy disk or the mother board support CD.

Refer to the corresponding section for each utility.



- Save a copy of the original motherboard BIOS file to a bootable floppy disk in case you need to restore the BIOS in the future. Copy the original motherboard BIOS using the AFUDOS utility.
- Refer to the system builder's website for details about updating the BIOS.

### 2.1.1 Creating a bootable floppy disk

1. Do either one of the following to create a bootable floppy disk.

#### DOS environment

Insert a 1.44MB floppy disk into the drive. At the DOS prompt, type:

**format A:/S** then press <Enter>.

#### Windows® XP environment

- a. Insert a 1.44MB floppy disk into the floppy disk drive.
  - b. From your Windows® desktop, click on **Start**, then select **My Computer**.
  - c. Select the **3 1/2 Floppy Drive** icon.
  - d. Click **File** from the menu, then select **Format**. A **Format 3 1/2 Floppy Disk** window appears.
  - e. Select **Create an MS-DOS startup disk** from the format options field, then click **Start**.
2. Copy the original (or the latest) motherboard BIOS to the bootable floppy disk.

### 2.1.2 Using AFUDOS to copy the current BIOS

The AFUDOS.EXE utility can also be used to copy the current system BIOS settings to a floppy or hard disk. The copy can be used as a backup in case the system BIOS fails or gets corrupted.

1. At the DOS prompt, type the command line:

**afudos /o[filename]**

where "filename" can be any user-provided filename of not more than eight alphanumeric characters for the main filename and three alphanumeric characters for the extension name.

Press <Enter>.



---

The BIOS information on the screen is for reference only. What you see on your screen may not be exactly the same as shown.

---

**Main filename    Extension name**

```
A:\>afudos /oMYBIOS03.rom
AMI Firmware Update Utility - Version 1.10
Copyright (C) 2002 American Megatrends, Inc. All rights reserved.
Reading flash ..... 0x0008CC00 (9%)
```

2. The utility will copy the current system BIOS by default to the floppy disk. Make sure that the floppy disk is not write-protected and has enough space (at least 600KB) to store the file.

```
A:\>afudos /oMYBIOS03.rom
AMI Firmware Update Utility - Version 1.10
Copyright (C) 2002 American Megatrends, Inc. All rights reserved.
Reading flash ..... done

A:\>
```

When the BIOS copy process is complete, the utility returns to the DOS prompt.

### 2.1.3 Using AFUDOS to update the BIOS

The AFUDOS is a DOS-based application that lets you update the BIOS file using a bootable floppy diskette. AFUDOS also allows you to copy the original BIOS file to a floppy diskette.

To update the BIOS using the AFUDOS.EXE:

1. Download the latest BIOS file from the website provided by the system builder.



---

Write the BIOS filename on a piece of paper. You need to type the exact BIOS file name at the prompt.

---

2. Copy the AFUDOS.EXE utility from the support CD to the bootable floppy disk that contains the BIOS file.
3. Boot the system from the floppy disk.

- At the DOS prompt, type the command line:

**afudos /i[filename.rom]**

where [filename.rom] means the latest (or original) BIOS file that you copied to the bootable floppy disk.

- Press <Enter>. The screen displays the status of the update process.



---

The BIOS information on the screen is for reference only. What you see on your screen may not be exactly the same as shown.

---

```
A:\>afudos /iK8V-MX.rom
AMI Firmware Update Utility - Version 1.10
Copyright (C) 2002 American Megatrends, Inc. All rights reserved.
  Reading file .... done
  Erasing flash ... done
  Writing flash ... 0x0008CC00 (9%)
```



---

DO NOT shut down or reset the system while updating the BIOS! Doing so can cause system boot failure!

---

When the BIOS update process is complete, the utility returns to the DOS prompt.

```
A:\>afudos /iK8V-MX.rom
AMI Firmware Update Utility - Version 1.10
Copyright (C) 2002 American Megatrends, Inc. All rights reserved.
  Reading file .... done
  Erasing flash ... done
  Writing flash ... 0x0008CC00 (9%)
  Verifying flash .. done
A:\>
```

- Reboot the system from the hard disk.



## 2.1.4 Using ASUS EZ Flash to update the BIOS

The ASUS EZ Flash feature allows you to easily update the BIOS without having to go through the long process of booting from a floppy disk and using a DOS-based utility. The EZ Flash is built-in the BIOS LPC chip so it is accessible by simply pressing <Alt> + <F2> during the Power-On Self Tests (POST).

### To update the BIOS using ASUS EZ Flash:

1. Visit the system builder website to download the latest BIOS file for your motherboard and rename it to **K8V-MX.ROM**. Save the BIOS file to a floppy disk.
2. Reboot the system.
3. To launch EZ Flash, press <Alt> + <F2> during POST to display the following.

```
User recovery requested. Starting BIOS recovery...
Checking for floppy...
```



- If there is no floppy disk in the drive, the error message "Floppy not found!" appears.
- If the correct BIOS file is not found in the floppy disk, the error message "K8V-MX.ROM not found!" is displayed.

4. Insert the floppy disk that contains the BIOS file. If the **K8V-MX.ROM** file is found in the floppy disk, EZ Flash performs the BIOS update process and automatically reboots the system when done.



DO NOT shut down or reset the system while updating the BIOS! Doing so can cause system boot failure!

```
User recovery requested. Starting BIOS recovery...
Checking for floppy...
Floppy found!
Reading file "k8v-mx.rom". Completed.
Start flashing...
Flashed successfully. Rebooting.
```

## 2.2 BIOS Setup Program



---

The BIOS software is constantly being updated so the BIOS setup screens and descriptions in this section are for reference purposes only, and may not exactly match what you see on your screen.

---

This motherboard supports a programmable Low Pin Count (LPC) chip that you can update using the provided utility described in section “2.1 Managing and updating your BIOS.”

Use the BIOS Setup program when you are installing a motherboard, reconfiguring your system, or prompted to “Run Setup”. This section explains how to configure your system using this utility.

Even if you are not prompted to use the Setup program, you can change the configuration of your computer in the future. For example, you can enable the security password feature or make changes to the power management settings. This requires you to reconfigure your system using the BIOS Setup program so that the computer can recognize these changes and record them in the CMOS RAM of the LPC chip.

The LPC chip on the motherboard stores the Setup utility. When you start up the computer, the system provides you with the opportunity to run this program. Press <Delete> during the Power-On Self Test (POST) to enter the Setup utility; otherwise, POST continues with its test routines.

To enter Setup after POST, restart the system by pressing <Ctrl+Alt+Delete>, or by pressing the reset button on the system chassis. You can also restart by turning the system off and then back on. Do this last option only if the first two fail.

The Setup program is designed to make it as easy to use as possible. Being a menu-driven program, it lets you scroll through the various sub-menus and make your selections among the predetermined choices.

## 2.2.1 BIOS menu screen

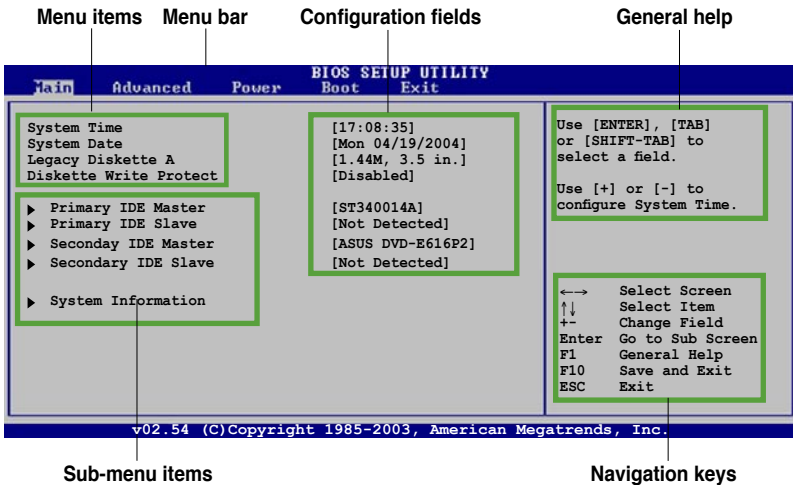

## 2.2.2 Menu bar

The menu bar on top of the screen has the following main items:

- Main** For changing the basic system configuration
- Advanced** For changing the advanced system settings
- Power** For changing the advanced power management (APM) configuration
- Boot** For changing the system boot configuration
- Exit** For selecting the exit options and loading default settings

To select an item on the menu bar, press the right or left arrow key on the keyboard until the desired item is highlighted.

## 2.2.3 Navigation keys

At the bottom right corner of a menu screen are the navigation keys for that particular menu. Use the navigation keys to select items in the menu and change the settings.



Some of the navigation keys differ from one screen to another.

## 2.2.4 Menu items

The highlighted item on the menu bar displays the specific items for that menu. For example, selecting **Main** shows the Main menu items.

The other items (Advanced, Power, Boot, and Exit) on the menu bar have their respective menu items.

## 2.2.5 Sub-menu items

A solid triangle before each item on any menu screen means that the item has a sub-menu. To display the sub-menu, select the item, then press <Enter>.

## 2.2.6 Configuration fields

These fields show the values for the menu items. If an item is user-configurable, you can change the value of the field opposite the item. You cannot select an item that is not user-configurable.

A configurable field is enclosed in brackets, and is highlighted when selected. To change the value of a field, select it then press <Enter> to display a list of options. Refer to “2.2.7 Pop-up window”.

## 2.2.7 Pop-up window

Select a menu item then press <Enter> to display a pop-up window with the configuration options for that item.

## 2.2.8 Scroll bar

A scroll bar appears on the right side of a menu screen when there are items that do not fit on the screen. Press the Up/Down arrow keys or <PageUp> / <PageDown> keys to display the other items on the screen.

## 2.2.9 General help

At the top right corner of the menu screen is a brief description of the selected item.

## 2.3 Main Menu

When you enter the BIOS Setup program, the Main menu screen appears, giving you an overview of the basic system information.



Refer to section “2.2.1 BIOS menu screen” for information on the menu screen items and how to navigate through them.

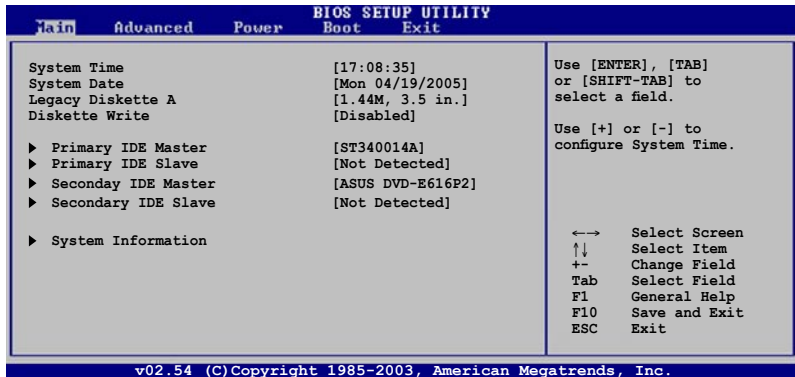

### 2.3.1 System Time [xx:xx:xxxx]

Allows you to set the system time.

### 2.3.2 System Date [Day xx/xx/xxxx]

Allows you to set the system date.

### 2.3.3 Legacy Diskette A [1.44M, 3.5 in.]

Sets the type of floppy drive installed. Configuration options: [Disabled] [360K, 5.25 in.] [1.2M, 5.25 in.] [720K, 3.5 in.] [1.44M, 3.5 in.] [2.88M, 3.5 in.]

### 2.3.4 Diskette Write [Disabled]

Enabling this item allows you to write to a floppy disk. If set to [Disabled], the floppy disk is write-protected. Configuration options: [Disabled] [Enabled]

## 2.3.5 Primary/Secondary IDE Master/Slave

While entering Setup, BIOS automatically detects the presence of IDE devices. There is a separate sub-menu for each IDE device. Select a device item then press <Enter> to display the IDE device information.

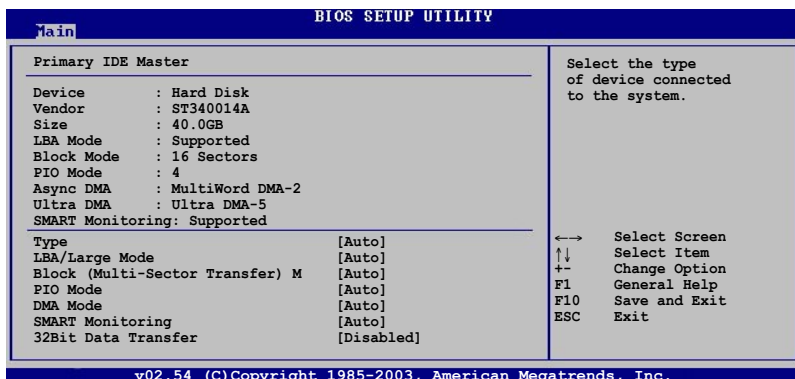

The BIOS automatically detects the values opposite the dimmed items (Device, Vendor, Size, LBA Mode, Block Mode, PIO Mode, Async DMA, Ultra DMA, and SMART monitoring). These values are not user-configurable. These items show N/A if no IDE device is installed in the system.

### Type [Auto]

Selects the type of IDE drive.

Configuration options: [Auto] [Not Installed] [CDROM] [ARMD]

### LBA/Large Mode [Auto]

Enables or disables the LBA/Large mode. Setting to Auto enables the LBA/Large mode if the device supports this mode, and if the device was not previously formatted with LBA mode disabled. Configuration options: [Auto] [Disabled]

### Block (Multi-Sector Transfer) [Auto]

Enables or disables data multi-sectors transfers. When set to Auto, the data transfer from and to the device occurs multiple sectors at a time if the device supports multi-sector transfer feature. When set to Disabled, the data transfer from and to the device occurs one sector at a time.

Configuration options: [Auto] [Disabled]

### PIO Mode [Auto]

Selects the PIO mode. Configuration options: [Auto] [0] [1] [2] [3] [4]

## DMA Mode [Auto]

Selects the DMA mode. Configuration options: [Auto] [SWDMA0] [SWDMA1] [SWDMA2] [MWDMA0] [MWDMA1] [MWDMA2] [UDMA0] [UDMA1] [UDMA2] [UDMA3] [UDMA4] [UDMA5]

## SMART Monitoring [Auto]

Sets the Smart Monitoring, Analysis, and Reporting Technology. Configuration options: [Auto] [Disabled] [Enabled]

## 32Bit Data Transfer [Disabled]

Enables or disables 32-bit data transfer. Configuration options: [Disabled] [Enabled]

## 2.3.6 System Information

This menu gives you an overview of the general system specifications. The items in this menu are auto-detected by the BIOS.

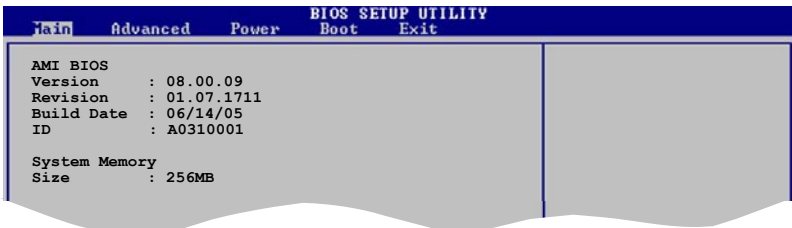

### AMI BIOS

Displays the auto-detected BIOS information.

### System Memory

Displays the auto-detected system memory.

## 2.4 Advanced menu

The Advanced menu items allow you to change the settings for the CPU and other system devices.



Take caution when changing the settings of the Advanced menu items. Incorrect field values can cause the system to malfunction.

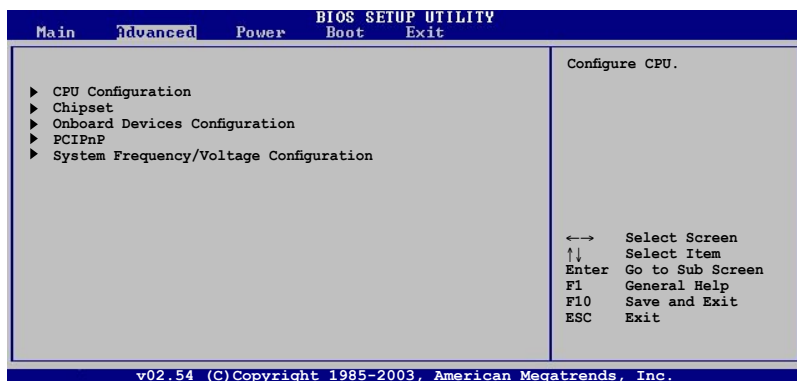

### 2.4.1 CPU Configuration

The items in this menu show the CPU-related information that the BIOS automatically detects.

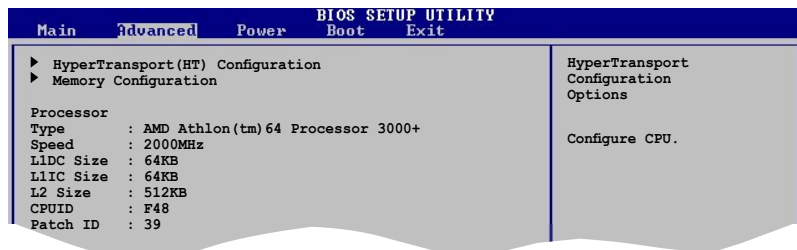



## HyperTransport (HT) Configuration

Advanced		BIOS SETUP UTILITY	
HT Frequency	[800 MHz]	K8CPU to AGP HyperTransport Frequency Selection	
HT DATA Width (Upstream)	[16BIT]		
HT DATA Width (Downstream)	[16BIT]		

### HT Frequency [800MHz]

Allows frequency selection of Hyper Transport transfer from K8 CPU to AGP.  
Configuration options: [200MHz] [400MHz] [600MHz] [800MHz]

### HT DATA Width (Upstream) [16BIT]

Allows selection of Hyper Transport upstream data width. Configuration options:  
[16BIT] [8BIT]

### HT DATA Width (Downstream) [16BIT]

Allows selection of Hyper Transport downstream data width. Configuration options:  
[16BIT] [8BIT]

# Memory Configuration

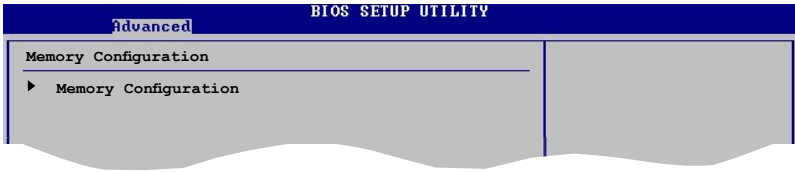

## Memory Configuration

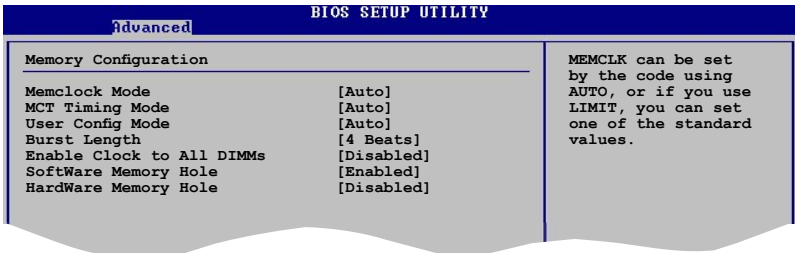

### Memclock Mode [Auto]

Allows you to set the memory clock mode. Set by the code using [Auto] or select [Manual] to set using one of the standard values. Configuration options: [Auto] [Limit]

### MCT Timing Mode [Auto]

Allows you to set the MCT Timing Mode manually or auto. Configuration options: [Auto] [Manual]

### User Config Mode [Auto]

Sets the User Config Mode. Configuration options: [Auto] [Manual]

### Burst Length [4 Beats]

Sets the Burst Length. Configuration options: [8 Beats] [4 Beats] [2 Beats]

### Enable Clock to All DIMMs [Disabled]

Allows you to enable or disable the Clock to All DIMM. Configuration options: [Disabled] [Enabled]

### SoftWare Memory Hole [Enabled]

Allows you to enable or disable the SoftWare memory Hole. Configuration options: [Disabled] [Enabled]

### HardWare Memory Hole [Enabled]

Allows you to enable or disable the HardWare memory Hole. Configuration options: [Disabled] [Enabled]

## 2.4.2 Chipset

The Chipset menu allows you to change the advanced chipset settings. Select an item then press <Enter> to display the sub-menu.

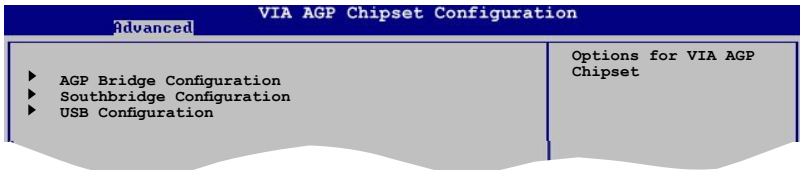

### AGP Bridge Configuration

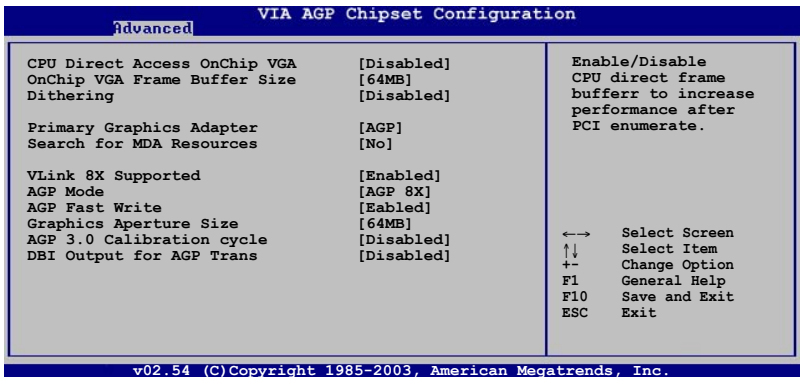

#### CPU Direct Access OnChip VGA [Disabled]

Enables or disables the CPU direct frame buffer. Configuration options: [Disabled] [Enabled]

#### OnChip VGA Frame Buffer Size [64MB]

Sets the size of the main memory shared as video RAM. Configuration options: [None] [8MB] [16MB] [32MB] [64MB]

#### Dithering [Disabled]

Enables or disables support for 18-bit LCD panel to 24-bit color depth under different resolutions. Configuration options: [Disabled] [Enabled]

#### Primary Graphics Adapter [AGP]

Allows you to select the mode of Primary Graphics Adapter. Configuration options: [AGP] [PCI]

### Search for MDA Resources [No]

Sets whether to allow search for MDA resources. Configuration options: [No] [Yes]

### VLink 8X supported [Enabled]

Enables or disables support for VLink 8X. Configuration options: [Disabled] [Enabled]

### AGP Mode [AGP 8X]

This motherboard supports the AGP 8X interface that transfers video data at 2.12GB/s. AGP 8X is backward-compatible, so you can keep the default [AGP 4X] mode even if you are using an AGP 8X video card. When set to [AGP 4X] mode, the AGP interface only provides a peak data throughput of 1.06GB/s even if you are using an AGP 8X video card. Configuration options: [AGP 8X] [AGP 4X]



---

The [AGP 8X] option appears only when you install an AGP 8X graphics card.

---

### AGP Fast Write [Enabled]

Enables or disables the AGP Fast Write feature. Configuration options: [Enabled] [Disabled]

### Graphics Aperture Size [64MB]

Allows you to select the size of mapped memory for AGP graphic data. Configuration options: [256MB] [128MB] [64MB] [32MB]

### AGP 3.0 Calibration cycle [Disabled]

Enables or disables the AGP Calibration mechanism. Configuration options: [Disabled] [Enabled]

### DBI Output for AGP Trans [Disabled]

Enables or disables the DBI output for AGP Trans. Configuration options: [Disabled] [Enabled]

## Southbridge Configuration

VIA South Chipset Configuration		
Advanced		
MPS Revision	[1.4]	Sets to MPS revision value
PCI Delay Transaction	[Enabled]	

### MPS Revision [1.4]

Sets the MPS revision value. Configuration options: [1.1] [1.4]

### PCI Delay Transaction [Enabled]

Enables or disables the PCI delay transaction feature.  
Configuration options: [Disabled] [Enabled]

## USB Configuration

BIOS SETUP UTILITY	
Advanced	
<b>USB Configuration</b>	Enables 1.1 USB host controllers.
Module Version - 2.24.0-7.4	
USB Devices Enabled : None	
USB 1.1 Ports Configuration	[USB 8 Ports]
USB 2.0 Controller	[Enabled]
Legacy USB Support	[Auto]
USB 2.0 Controller Mode	[HiSpeed]
▶ USB Mass Storage Device Configuration	
	←→ Select Screen ↑↓ Select Item +- Change Option F1 General Help F10 Save and Exit ESC Exit
v02.54 (C)Copyright 1985-2003, American Megatrends, Inc.	



The Module Version and USB Devices Enabled items show the auto-detected values. If no USB device is detected, the item shows None.

## USB 1.1 Ports Configuration [USB 8 Ports]

Allows you to set the number of USB ports to activate.

Configuration options: [Disabled] [USB 2 Ports] [USB 4 Ports] [USB 6 Ports] [USB 8 Ports]

## USB 2.0 Controller [Enabled]

Allows you to enable or disable the USB 2.0 controller.

Configuration options: [Enabled] [Disabled]

## Legacy USB Support [Auto]

Allows you to enable or disable support for legacy USB devices. Setting to Auto allows the system to detect the presence of USB devices at startup. If detected, the USB controller legacy mode is enabled. If no USB device is detected, the legacy USB support is disabled. Configuration options: [Auto] [Disabled] [Enabled]

## USB 2.0 Controller Mode [HiSpeed]

Allows you to configure the USB 2.0 controller to HiSpeed (480Mbps) or FullSpeed (12Mbps). Configuration options: [HiSpeed] [FullSpeed]



When you use a USB mass storage device, a USB mass storage device configuration option will display. And this option is hid if no USB mass storage detected.

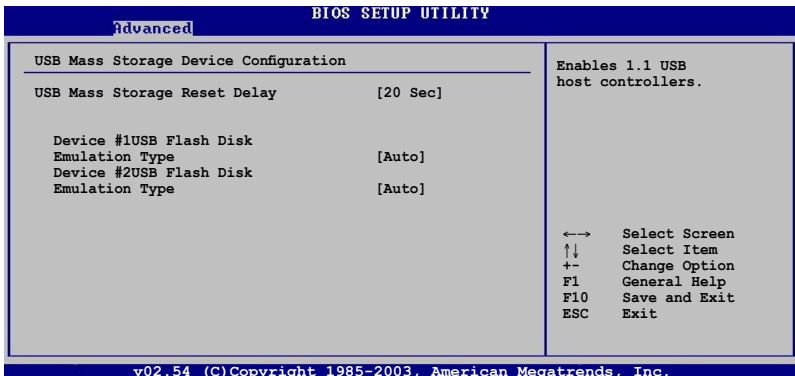

### USB Mass Storage Reset Delay [20 Sec]

Allows you to set the time USB Mass Storage Reset Delay will cost.  
Configuration options: [10 Sec] [20 Sec] [30 Sec] [40 Sec]

### Device #1USB Flash Disk

#### **Emulation Type [Auto]**

Allows you to set the Emulation Type for #1 USB Flash Disk.

Configuration options: [Auto] [Floppy] [Forced FDD] [Hard Disk] [CDROM] [No Emulation]

### Device #2USB Flash Disk

#### **Emulation Type [Auto]**

Allows you to set the Emulation Type for #2 USB Flash Disk.

Configuration options: [Auto] [Floppy] [Forced FDD] [Hard Disk] [CDROM] [No Emulation]

## 2.4.3 Onboard Devices Configuration

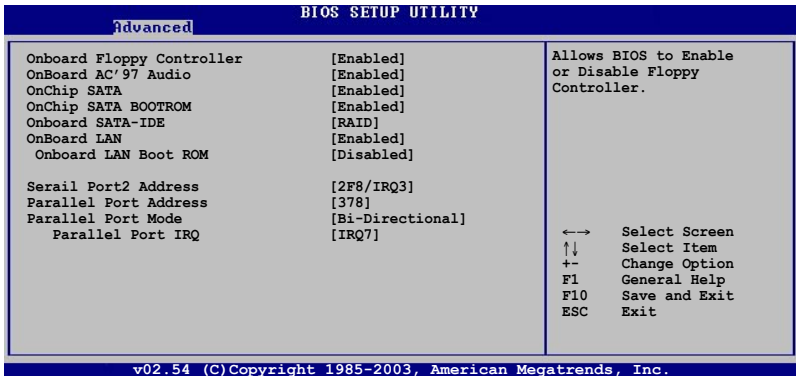

### **Onboard Floppy Controller [Enabled]**

Enables or disables the Onboard Floppy Controller.  
Configuration options: [Enabled] [Disabled]

### **OnBoard AC'97 Audio [Enabled]**

Selecting [Enabled] allows the BIOS to detect whether you are using any audio device. If an audio device is detected, the onboard audio controller is enabled. If no audio device is detected, the controller is disabled. Configuration options: [Enabled] [Disabled]

### **OnChip SATA [Enabled]**

Enables or disables the OnChip Serial ATA. Configuration options: [Enabled] [Disabled]

### **OnChip SATA BOOTROM [Enabled]**

Enables or disables the Serial ATA Boot ROM. Configuration options: [Enabled] [Disabled]

### **OnBoard SATA-IDE [RAID]**

Allows you to set the mode of the OnBoard SATA-IDE mode. Configuration options: [RAID] [SATA]

### **OnBoard LAN [Enabled]**

Allows you to enable or disable the onboard LAN controller. Configuration options: [Enabled] [Disabled]

### **OnBoard LAN Boot ROM [Disabled]**

Allows you to enable or disable the onboard LAN Boot ROM. Configuration options: [Disabled] [Enabled]

### **Serial Port2 Address [2F8/IRQ3]**

Allows you to select the Serial Port2 base address. Configuration options: [Disabled] [3F8/IRQ4][2F8/IRQ3] [3E8/IRQ4] [2E8/IRQ3]

### **Parallel Port Address [378]**

Allows you to select the Parallel port base addresses. Configuration options: [Disabled] [378] [278] [3BC]

### **Parallel Port Mode [Bi-Directional]**

Allows you to select the Parallel port mode. Configuration options: [Normal] [Bi-Directional] [EPP] [ECP]

### **Parallel Port IRQ [IRQ7]**

Allows you to select the Parallel Port IRQ. Configuration options: [IRQ5] [IRQ7]



## 2.4.4 PCI PnP

The PCI PnP menu items allow you to change the advanced settings for PCI/PnP devices. The menu includes setting IRQ and DMA channel resources for either PCI/PnP or legacy ISA devices.



Take caution when changing the settings of the PCIPnP menu items. Incorrect field values can cause the system to malfunction.

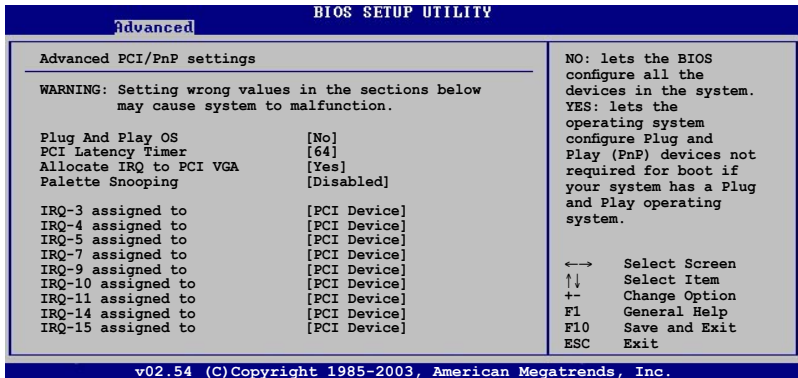

### Plug And Play O/S [No]

When set to [No], BIOS configures all the devices in the system. When set to [Yes] and if you installed a Plug and Play operating system, the operating system configures the Plug and Play devices not required for boot. Configuration options: [Yes] [No]

### PCI Latency Timer [64]

Allows you to select the value in units of PCI clocks for the PCI device latency timer register. Configuration options: [32] [64] [96] [128] [160] [192] [224] [248]

### Allocate IRQ to PCI VGA [Yes]

When set to [Yes], BIOS assigns an IRQ to PCI VGA card if the card requests for an IRQ. When set to [No], BIOS does not assign an IRQ to the PCI VGA card even if requested. Configuration options: [No] [Yes]

### Palette Snooping [Disabled]

When set to [Enabled], the palette snooping feature informs the PCI devices that an ISA graphics device is installed in the system so that the latter can function correctly. Configuration options: [Disabled] [Enabled]

### IRQ xx [Available]

When set to [Available], the specific IRQ is free for use of PCI/PnP devices. When set to [Reserved], the IRQ is reserved for legacy ISA devices. Configuration options: [PCI Device] [Reserved]

## 2.4.5 System Frequency/Voltage Configuration

The System Frequency/Voltage Configuration menu items allow you to config the advanced settings for system frequency and voltage.

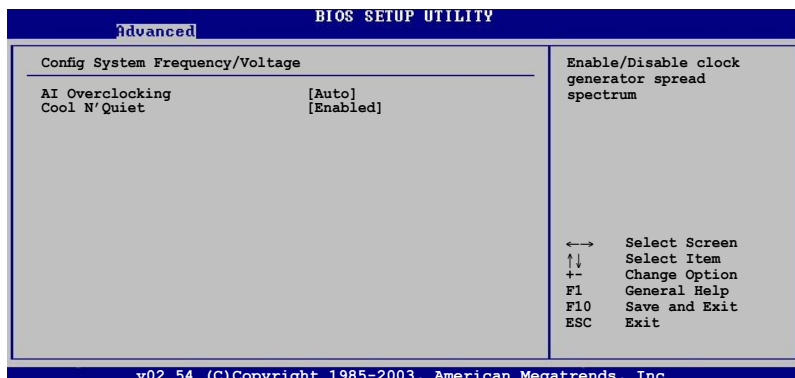

### AI Overclocking [Auto]

Allows you to select the frequency to overclock the CPU speed through AI Overclocking. Configuration options: [Auto] [Manual] [Standard] [Overclock 3%] [Overclock 5%] [Overclock 7%] [Overclock 10%] [Adaptive Overclocking]

### Cool N'Quiet [Enabled]

Allows you to enable or disable the Cool N'Quiet function. Configuration options: [Disabled] [Enabled]

## 2.5 Power menu

The Power menu items allow you to change the power settings. Select an item then press <Enter> to display the configuration options.

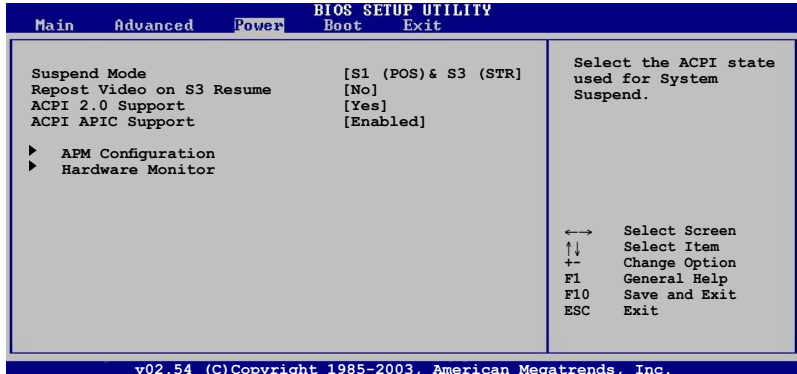

### 2.5.1 Suspend Mode [S1 (POS) & S3 (STR) Auto]

Allows you to select the ACPI state to be used for system suspend. Configuration options: [S1 (POS) Only] [S3 Only] [S1 (POS) & S3 (STR) Auto]

### 2.5.2 Repost Video on S3 Resume [No]

Determines whether to invoke VGA BIOS POST on S3/STR resume. Configuration options: [No] [Yes]

### 2.5.3 ACPI 2.0 Support [Yes]

Allows you to add more tables for ACPI 2.0 specifications. Configuration options: [No] [Yes]

### 2.5.4 ACPI APIC Support [Enabled]

Enables or disables the ACPI support in the ASIC. When set to Enabled, the ACPI APIC table pointer is included in the RSDT pointer list. Configuration options: [Disabled] [Enabled]

## 2.5.5 APM Configuration

BIOS SETUP UTILITY		
Power		
Power Management/APM	[Enabled]	Enable or disable the Advanced Power Management (APM) feature.
Power Button Mode	[On/Off]	
Suspend Power Saving Type	[C3]	
Restore on AC Power Loss	[Last State]	
Standby Time Out	[Disabled]	
Resume On Ring	[Disabled]	
Power On Lan	[Disabled]	
Power On FME	[Disabled]	
Power on PS/2 KeyBoard	[Disabled]	
Power on PS/2 Mouse	[Disabled]	
Power on OnBoard Lan	[Disabled]	
		←→ Select Screen
		↑↓ Select Item
		+− Change Field
		F1 General Help
		F10 Save and Exit
		ESC Exit

v02.54 (C)Copyright 1985-2003, American Megatrends, Inc.

### Power Management/APM [Enabled]

Allows you to enable or disable the Advanced Power Management (APM) feature. Configuration options: [Disabled] [Enabled]



The following items appear only when the Power Management/APM item is set to [Enabled].

### Power Button Mode [On/Off]

Allows the system to go into On/Off mode or suspend mode when the power button is pressed. Configuration options: [On/Off] [Suspend]

### Suspend Power Saving Type [C3]

Allows you to set the suspend power saving type. Configuration options: [C3] [S1]

### Restore on AC Power Loss [Last State]

When set to Power Off, the system goes into off state after an AC power loss. When set to Power On, the system goes on after an AC power loss. When set to Last State, the system goes into either off or on state whatever was the system state before the AC power loss. Configuration options: [Last State] [Power Off] [Power On]

### Standby Time Out [Disabled]

Allows you to select the specified time at which the system goes on suspend mode. Configuration options: [Disabled] [1 Minute] [2 Minutes] [4 Minutes] [8 Minutes] [10 Minutes] [20 Minutes] [30 Minutes] [40 Minutes] [50 Minutes] [60 Minutes]

### **Resume On Ring [Disabled]**

Allows you to enable or disable Resume On Ring. Configuration options: [Disabled] [Enabled]

### **Power On Lan [Disabled]**

Allows you to enable or disable the Power On Lan. Configuration options: [Disabled] [Enabled]

### **Power On PME [Disabled]**

Allows you to enable or disable the Power On PEM. Configuration options: [Enabled] [Disabled]

### **Power On PS/2 KeyBoard [Disabled]**

Allows you to use specific keys on the keyboard to turn on the system. When set to [S5], the item Wake-up Key is enabled. This feature requires an ATX power supply that provides at least 1A on the +5VSB lead. Configuration options: [Disabled] [Enabled]

### **Power On PS/2 Mouse [Disabled]**

When set to [Enabled], this parameter allows you to use the PS/2 mouse to resume the system. This feature requires an ATX power supply that provides at least 1A on the +5VSB lead. Configuration options: [Disabled] [Enabled]

### **Power On OnBoard LAN [Enabled]**

When set to [Enabled], this option allows you to use the onboard LAN to turn on the system. Configuration options: [Enabled] [Disabled]

## 2.5.6 Hardware Monitor

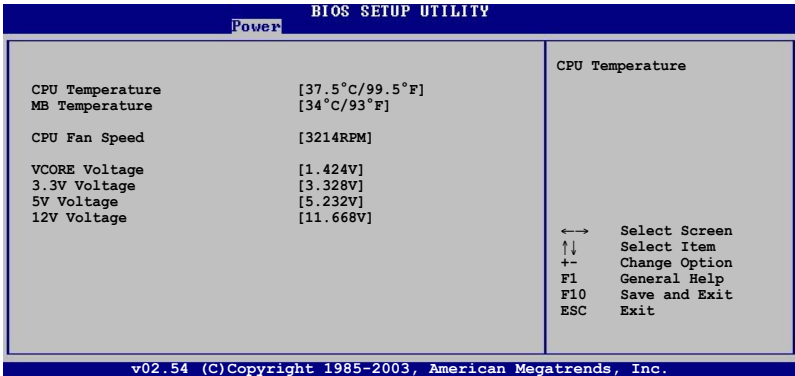

### CPU Temperature [xxx°C/xxx°F]

### MB Temperature [xxx°C/xxx°F]

The onboard hardware monitor automatically detects and displays the CPU and motherboard temperatures.

### CPU Fan Speed [xxxxRPM]

The onboard hardware monitor automatically detects and displays the CPU fan speed in rotations per minute (RPM). If the fan is not connected to the motherboard, the specific field shows N/A. Configuration options: [xxxxRPM] [N/A]

### VCORE Voltage, 3.3V Voltage, 5V Voltage, 12V Voltage

The onboard hardware monitor automatically detects the voltage output through the onboard voltage regulators.



If any of the monitored items is out of range, the following error message appears: "Hardware Monitor found an error. Enter Power setup menu for details". You will then be prompted to "Press F1 to continue or DEL to enter SETUP".

# 2.6 Boot menu

The Boot menu items allow you to change the system boot options. Select an item then press <Enter> to display the sub-menu.

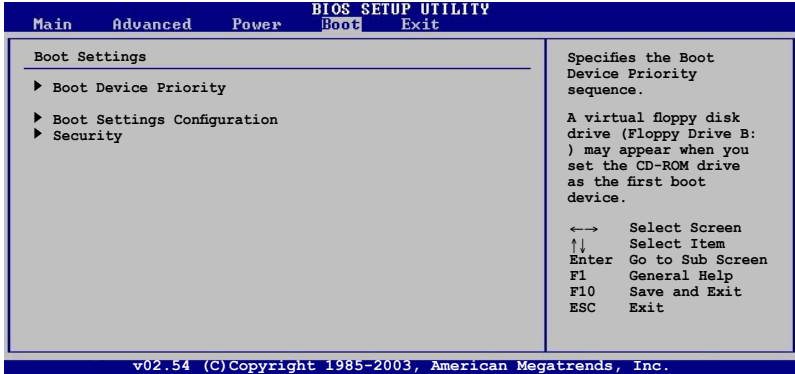

A Hide option will display if removable boot device is detected.

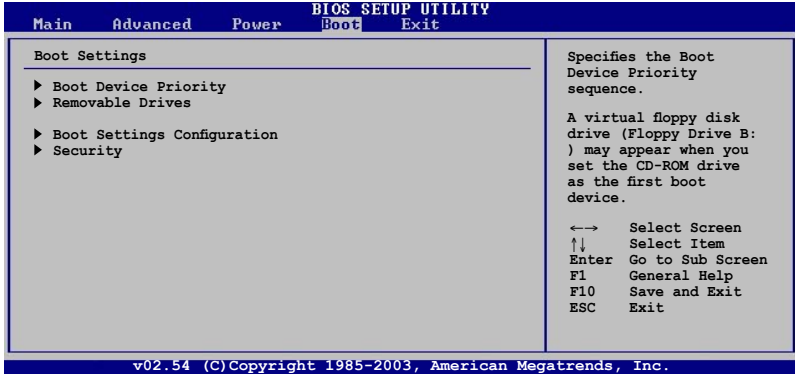

## 2.6.1 Boot Device Priority

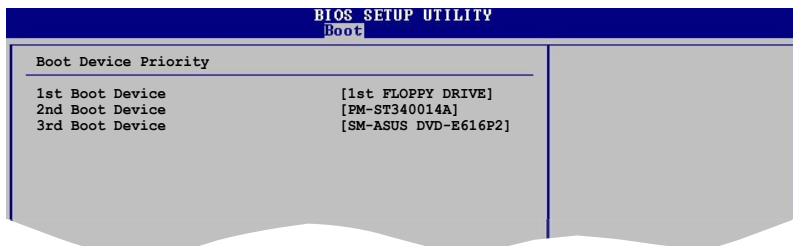

### 1st ~ xxth Boot Device [1st FLOPPY DRIVE]

These items specify the boot device priority sequence from the available devices. The number of device items that appear on the screen depends on the number of devices installed in the system. Configuration options: [xxxxx Drive] [Disabled]



## 2.6.2 Boot Settings Configuration

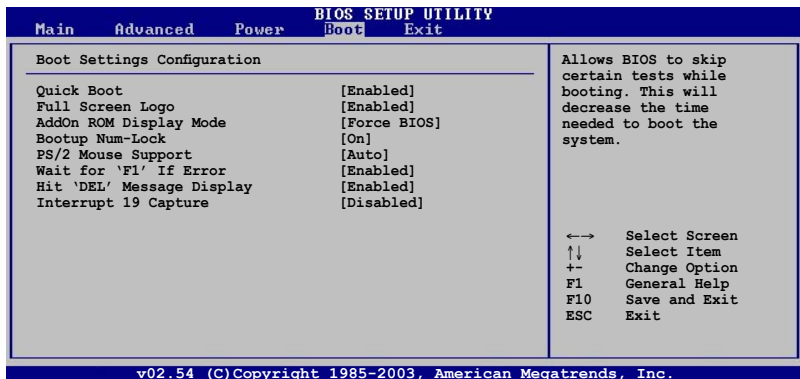

### Quick Boot [Enabled]

Enabling this item allows BIOS to skip some power on self tests (POST) while booting to decrease the time needed to boot the system. When set to [Disabled], BIOS performs all the POST items. Configuration options: [Enabled] [Disabled]

### Full Screen Logo [Enabled]

Allows you to enable or disable the full screen logo display feature. Configuration options: [Enabled] [Disabled]



Set this item to [Enabled] to use the ASUS MyLogo™ feature.

### AddOn ROM Display Mode [Force BIOS]

Sets the display mode for option ROM. Configuration options: [Force BIOS] [Keep Current]

### Bootup Num-Lock [On]

Allows you to select the power-on state for the NumLock. Configuration options: [On] [Off]

### PS/2 Mouse Support [Auto]

Allows you to enable or disable support for PS/2 mouse. Configuration options: [Auto] [Disabled] [Enabled]

### Wait for 'F1' If Error [Enabled]

When set to [Enabled], the system waits for F1 key to be pressed when error occurs. Configuration options: [Enabled] [Disabled]

## Hit 'DEL' Message Display [Enabled]

When set to [Enabled], the system displays the message "Press DEL to run Setup" during POST. Configuration options: [Enabled] [Disabled]

## Interrupt 19 Capture [Disabled]

When set to [Enabled], this function allows the option ROMs to trap Interrupt 19. Configuration options: [Disabled] [Enabled]

## 2.6.3 Security

The Security menu items allow you to change the system security settings. Select an item then press <Enter> to display the configuration options.

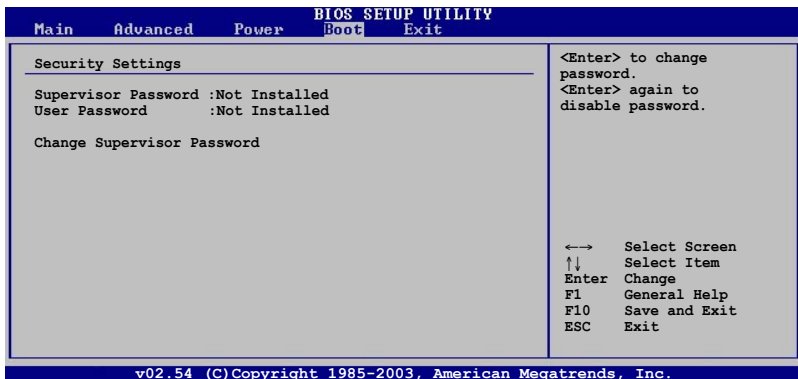

### Change Supervisor Password

Select this item to set or change the supervisor password. The Supervisor Password item on top of the screen shows the default **Not Installed**. After you have set a password, this item shows **Installed**.

To set a Supervisor Password:

1. Select the Change Supervisor Password item and press <Enter>.
2. On the password box that appears, type a password composed of at least six letters and/or numbers, then press <Enter>.
3. Confirm the password when prompted.

The message "Password Installed" appears after you successfully set your password. The Supervisor Password item now shows "Installed". To change the supervisor password, follow the same steps as in setting a user password.

To clear the supervisor password, select the Change Supervisor Password then press Enter. The message "Password Uninstalled" appears.

To clear the supervisor password, select the Change Supervisor Password then press Enter. The message "Password Uninstalled" appears.

## 2.7 Exit menu

The Exit menu items allow you to load the optimal or failsafe default values for the BIOS items, and save or discard your changes to the BIOS items.

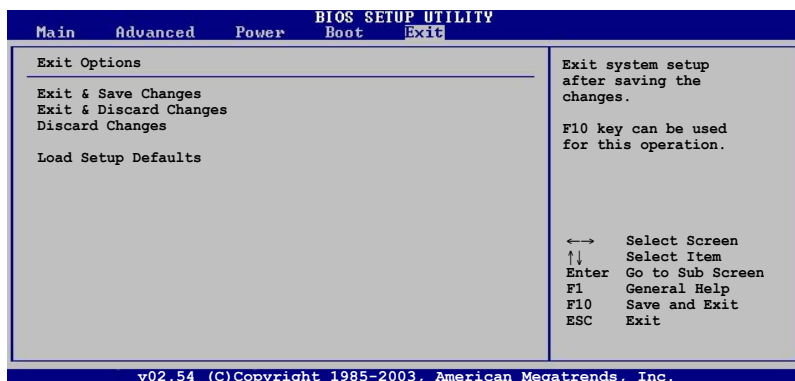

Pressing <Esc> does not immediately exit this menu. Select one of the options from this menu or <F10> from the legend bar to exit.

### Exit & Save Changes

Once you are finished making your selections, choose this option from the Exit menu to ensure the values you selected are saved to the CMOS RAM. The CMOS RAM is sustained by an onboard backup battery and stays on even when the PC is turned off. When you select this option, a confirmation window appears. Select [Yes] to save changes and exit.



If you attempt to exit the Setup program without saving your changes, the program prompts you with a message asking if you want to save your changes before exiting. Pressing <Enter> saves the changes while exiting.

### Exit & Discard Changes

Select this option only if you do not want to save the changes that you made to the Setup program. If you made changes to fields other than system date, system time, and password, the BIOS asks for a confirmation before exiting.

### Discard Changes

This option allows you to discard the selections you made and restore the previously saved values. After selecting this option, a confirmation appears. Select [Yes] to discard any changes and load the previously saved values.

### Load Setup Defaults

This option allows you to load the default values for each of the parameters on the Setup menus. When you select this option, or if you press <F5>, a confirmation window appears. Select [Yes] to load the default values. Select Exit & Save Changes or make other changes before saving the values to the non-volatile RAM.



# Chapter 3

This chapter describes the contents of the support CD that comes with the motherboard package.

## Software Support

# 3.1 Installing an operating system

This motherboard supports Windows® 2000/XP operating systems (OS). Always install the latest OS version and corresponding updates to maximize the features of your hardware.



Motherboard settings and hardware options vary. Use the setup procedures presented in this chapter for reference only. Refer to your OS documentation for detailed information.

# 3.2 Support CD information

The support CD that came with the motherboard package contains the drivers, software applications, and utilities that you can install to avail all motherboard features.



The contents of the support CD are subject to change at any time without notice. Visit the ASUS website(www.asus.com) for updates.

## 3.2.1 Running the support CD

Place the support CD to the optical drive. The CD automatically displays the Drivers menu if Autorun is enabled in your computer.



Click an icon to display support CD/motherboard information

Click an item to install



If Autorun is NOT enabled in your computer, browse the contents of the support CD to locate the file ASSETUP.EXE from the BIN folder. Double-click the ASSETUP.EXE to run the CD.

## 3.2.2 Drivers menu

The drivers menu shows the available device drivers if the system detects installed devices. Install the necessary drivers to activate the devices.

### VIA 4 in 1 drivers

Install 4 in 1 in 1 Driver.

### AD1888 SoundMAX Audio Driver

Install AD1888 SoundMAX Audio Driver.

### V39FVIA LAN Driver

Install V39FVIA LAN Driver.

### USB 2.0 Driver

Install USB 2.0 driver.

### Cool 'n' Quiet readme

Show some information you need to know.

### Cool 'n' Quiet Driver

AMD Cool 'n' Quiet! Technology allows the system to dynamically and automatically select the CPU speed, Voltage and Power combination that match the instantaneous user performance need. These changes can happen as often as 30 times per second.



The screen display and drivers option may not be the same for different operating system versions.

## 3.2.3 Utilities menu

The Utilities menu shows the applications and other software that the motherboard supports.



## Microsoft DirectX 9.0c Dirver

The Microsoft DirectX® 9.0c is a multimedia technology that enhances computer graphics and sounds. DirectX® improves the multimedia features of your computer so you can enjoy watching TV and movies, capturing videos, or playing games in your computer.

## ASUS PC Probe

This smart utility monitors the fan speed, CPU temperature, and system voltages, and alerts you of any detected problems. This utility helps you keep your computer in healthy operating condition.

## ASUS Update

The ASUS Update utility allows you to update the motherboard BIOS in Windows® environment. This utility requires an Internet connection either through a network or an Internet Service Provider (ISP). See pages 2-5 to 2-6 for details.

## ADOBE Acrobat Reader V5.0

The Adobe Acrobat® Reader V5.0 is for opening, viewing, and printing documents in Portable Document Format (PDF).

## ASUS Screen Saver

Bring life to your idle screen by installing the ASUS screen saver.

## Cool 'n' Quiet Software

Install ASUS CoolQuiet Software.

## 3.2.4 Contacts menu

Click the Contact tab to display the ASUS contact information. You can also find this information on the inside front cover of this user guide.





## Free Manuals Download Website

<http://myh66.com>

<http://usermanuals.us>

<http://www.somanuals.com>

<http://www.4manuals.cc>

<http://www.manual-lib.com>

<http://www.404manual.com>

<http://www.luxmanual.com>

<http://aubethermostatmanual.com>

Golf course search by state

<http://golfingnear.com>

Email search by domain

<http://emailbydomain.com>

Auto manuals search

<http://auto.somanuals.com>

TV manuals search

<http://tv.somanuals.com>