

**DLO | HomeDock Deluxe™**  
USER MANUAL

# Contents

Getting Started	4
Setting Up HomeDock Deluxe	6
Connecting Your iPod	8
HomeDock Deluxe Modes	9
On-Screen Music Navigation	10
HomeDock Deluxe Settings	13
Playing and Controlling Music	14
Playing Photo Slideshows	16
Watching iPod Videos	18
Using with PC or Mac	20
Troubleshooting & Tips	21
Tech Specs	23
Warranty	24

© 2006 Digital Lifestyle Outfitters  
HomeDock Deluxe, Digital Lifestyle Outfitters and  
DLO logo are trademarks of Digital Lifestyle Outfitters.  
iPod is a registered trademark of Apple Computer, Inc.  
All Rights Reserved  
Printed in Taiwan  
M99765-060224D

# Getting Started

Congratulations on your purchase of the DLO HomeDock Deluxe Dock for iPod with On-Screen Navigation, the iPod dock that lets you enjoy your iPod's music, photos and videos in your living room. Connecting HomeDock Deluxe to your home entertainment center is a snap. We'll get you started in three easy steps.

## STEP 1 - ASSEMBLE YOUR HOMEDOCK DELUXE

Attach the HomeDock Deluxe iPod Support Stand and make the proper power, audio and video connections to your Home Entertainment Center. See [page 6](#).

## STEP 2 - CONNECT YOUR IPOD AND ADJUST HOMEDOCK DELUXE STAND

Adjust the HomeDock Deluxe Stand to fit your particular iPod. See [page 8](#).

## STEP 3 - SELECT YOUR MUSIC, A PHOTO SLIDESHOW OR VIDEO AND PLAY

Turn on HomeDock Deluxe, select some music, pictures or a video on your iPod and press Play. To use **On-Screen Music Navigation**, press the **Mode button**  ([page 15](#)) on the top-left of your HomeDock Deluxe remote control.

**NOTE:** The current Apple iPods do not allow on-screen navigation of photos or videos - only music. However, you still can start and control the playback of photos and videos with your HomeDock Deluxe. To select and play photo slideshows and videos, be sure to set your HomeDock Deluxe to **iPod Mode**.

Your HomeDock Deluxe arrives in **iPod Mode**. This mode allows you to select music, photos and videos directly from your iPod, then control all basic transport functions (like Play/Pause, Fast Forward, Reverse, etc.) with the HomeDock Deluxe remote control from the couch.

To use **On-Screen Music Navigation**, switch your HomeDock Deluxe to **On-Screen Music Navigation Mode** by simply pushing the **Mode button** on the top-left of your HomeDock Deluxe remote control. For more information on **HomeDock Deluxe Modes**, please carefully read [page 9](#).

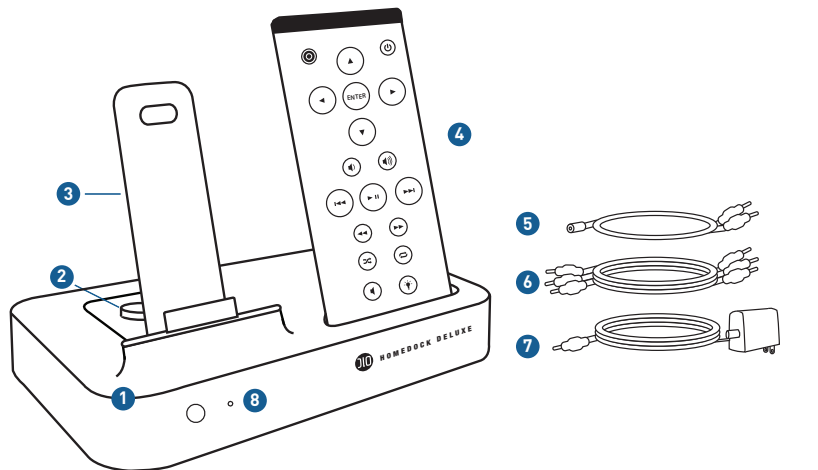

- |                           |                             |                            |                             |
|---------------------------|-----------------------------|----------------------------|-----------------------------|
| <b>1</b> HOMEDOCK DELUXE  | <b>3</b> IPOD SUPPORT STAND | <b>5</b> MINI-TO-RCA CABLE | <b>7</b> AC POWER ADAPTER   |
| <b>2</b> ADJUSTMENT SCREW | <b>4</b> REMOTE CONTROL     | <b>6</b> AV CABLE          | <b>8</b> POWER STATUS LIGHT |

# Setting Up HomeDock Deluxe

## ASSEMBLING YOUR DLO HOMEDOCK DELUXE

1. Remove the adjustment screw on top of the Dock
2. Fit the iPod Support Stand into the cavity on top of the HomeDock Deluxe.  
**NOTE:** Be sure to line up the Support Stand's cutout slot with the adjustment screw on the Dock.
3. Tighten the Support Stand's adjustment screw to secure the Stand in place. Do not over-tighten the screw.

## CONNECTING HOMEDOCK DELUXE

There are several different ways you can connect HomeDock Deluxe to your existing Home Entertainment Center. Generally we recommend you connect the L and R Audio Out to your stereo directly, and Video Out directly to your TV. But it's perfectly fine to connect Audio and Video to your TV. HomeDock Deluxe works great connected solely to your home stereo, although you wouldn't be able to use **On-Screen Navigation**. If you want use your Homedock Deluxe in **On-Screen Navigation Mode** or to select and view videos from your iPod, you need to hook it up to your TV.

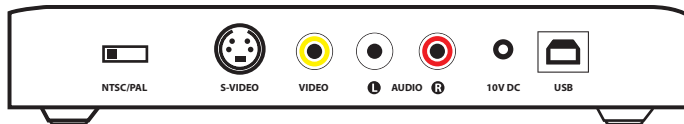

## BASIC CONNECTION OF HOMEDOCK DELUXE TO YOUR HOME STEREO AND TV

1. Plug the included AC power adapter into the back of the HomeDock Deluxe base, and the other end into any available AC power outlet.
2. Plug the included A/V Cable into the back of the HomeDock Deluxe base. Be sure to match the color on the A/V plugs (red, white and yellow) with the corresponding jack color or input type.
3. Plug the other end of the A/V Cable into the corresponding jacks of any available input on your home stereo receiver and/or TV. White plug-Left audio, Red plug-Right audio and Yellow plug-Video.  
**NOTE:** S-Video can be used for even better video performance (S-Video cable is sold separately).
4. Using your HomeDock Deluxe Remote Control, turn on your HomeDock Deluxe. Also turn on your home stereo and/or TV to then select the correct input for the HomeDock Deluxe.

## USING HOMEDOCK DELUXE WITH POWERED SPEAKERS

1. Plug the included AC power adapter into the back of the HomeDock Deluxe base, then into any available AC power outlet.
2. Connect the included RCA-to-mini Audio Adapter to the Left and Right Outputs on the back of your HomeDock Deluxe.
3. Using a mini-to-mini cable (included with most powered speakers), connect your HomeDock Deluxe to the Input on the powered speakers.
4. Using your HomeDock Deluxe Remote Control, turn on your HomeDock Deluxe. Also turn on your powered speakers.

## ADJUSTING HOMEDOCK DELUXE TO FIT YOUR IPOD

The HomeDock Deluxe can fit any dockable iPod. It can even be used with many iPod cases left on. The first time you use your iPod, and if you ever use another size iPod, you should adjust the HomeDock's Support Stand to accommodate your particular iPod. Follow these steps to do so.

1. Loosen the Support Stand Screw and slide the Support Stand as far back as it can go.
2. Connect your iPod by carefully lowering it onto the iPod dock connector of the HomeDock Deluxe.
3. Slide the Support Stand toward the iPod until the iPod is gently resting against the Support Stand Pad. The back of the iPod should be parallel with the Support Stand and not leaning more forward or backward.
4. Tighten the Support Stand Screw to keep it in place.

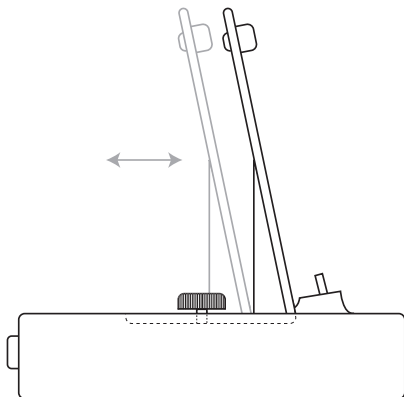

HomeDock Deluxe has two distinct modes: **On-Screen Navigation Mode** and **iPod Mode**. It's very important to understand the differences in the two.

**NOTE:** Your HomeDock Deluxe arrives in **iPod Mode**. To toggle between **iPod Mode** and **On-Screen Navigation Mode**, simply push the **Mode button** on the top-left of your HomeDock Deluxe remote control.

## ON-SCREEN NAVIGATION MODE

Use **On-Screen Navigation Mode** when:

- HomeDock Deluxe is connected to a TV
- you want to view and select your iPod's music from your TV screen
- you wish to see iPod's currently playing song and information

**On-Screen Navigation Mode** allows you to view, navigate and select your iPod's music on your TV screen. You can change display settings, view currently playing song info, view songs by category, or use iPod's song info as a screensaver.

## IPOD MODE

Use **iPod Mode** when:

- you want to view iPod photo slideshows or iPod videos from your iPod
- you're using HomeDock Deluxe connected to your stereo (but not your TV)
- you want to play iPod's music without turning on your TV

**iPod Mode** lets you browse and select music, pictures and video directly on your iPod. You can navigate iPod's menu screens via the arrow buttons on the HomeDock Deluxe's remote control or directly on the iPod itself while docked on top of your HomeDock Deluxe.

# On-Screen Music Navigation

## TO SELECT MUSIC USING ON-SCREEN NAVIGATION

Use **On-Screen Navigation Mode** to control and display your iPod's music, including playlists, albums, artists, songs, etc. You can also choose your own Color Themes and Screen Savers to customize your HomeDock Deluxe. To navigate through the categories of your music:

1. Select **Music** from the Main Menu screen
2. Select the listing of music you would like to view: **Playlists, Artists, Albums, Songs, Genres, Composers or Audiobooks.**
3. Scroll up or down to select the particular song you would like to play. Then with the song highlighted, press **Enter** or hit the **Right Nav Arrow.**

From the Main Menu screen, you can also go immediately to your iPod's **Playlists** and choose one to listen to. You can even choose **Shuffle Songs** to play songs randomly from your library.

Any time that you have a track playing from your iPod using the HomeDock Deluxe, the current track info is displayed at the top of your TV screen. The HomeDock also displays a track countdown timer, the track progress bar, the name of your iPod, as well as album and playlist (if applicable) information.

**NOTE:** The current Apple iPods do not allow on-screen navigation of photos or videos - only music. However, you still can control the playback of slideshows and video (like Play/Pause, Fast Forward, etc) with your HomeDock Deluxe. To select and play photo slideshows and videos, be sure to set your HomeDock Deluxe to **iPod Mode.**



## BASIC ON-SCREEN MUSIC NAVIGATION

1. Select Music from the Main Menu screen
2. Select the music you would like to view by: Playlists, Artists, Albums, Songs, Genres, Composers or Audiobooks.
3. Scroll up or down to select the particular song you would like to play. Then with the song highlighted, press Play or hit the **Right Nav Arrow** on the Remote Control

## On-Screen Music Navigation Tips & Tricks

---

### SHUFFLE FUNCTIONS DURING ON-SCREEN NAVIGATION

There are two ways to use Shuffle with your HomeDock Deluxe in **On-Screen Navigation Music Mode**:

1. To immediately begin shuffling your entire music library, simply select Shuffle Songs from the HomeDock Deluxe Main Menu.
2. Shuffle your music in any song list, such as Playlists, Artists, Albums, Songs, etc. Simply press the Shuffle button on your Remote and your HomeDock Deluxe will then randomly select and play songs from your current list. The shuffle icon will appear in the right corner of your Status Bar when you are playing songs in Shuffle Mode.

### SPEED-SCROLL FUNCTION

Since your iPod might contain thousands of songs, the HomeDock Deluxe features a handy Speed-Scroll feature that lets you rapidly scroll through giant lists in seconds. By holding the **Down Nav Arrow** or **Up Nav Arrow** button, your HomeDock Deluxe will scroll through several screens of selections and then begin Speed Scrolling through multiple pages until you arrive at your particular choice.

You can personalize your HomeDock Deluxe by selecting "HomeDock Settings" in the Main Menu screen. From there you can choose different Color Themes, Screen Savers and Screen Saver times.

### THEMES

Choose between 4 different HomeDock Deluxe Color Themes to match your room decor or personal taste. Themes include Aqua, Forest Green, Metal and Teal.

### SCREEN SAVERS

A Screen Saver will automatically come on after a period of user inactivity. Music will continue to play either way. Select from the following:

**Status Bar** - displays the current song information and play status

**DLO Logo** - bounces your favorite logo around the screen

**Black** - displays a dark screen

The push of any key on the remote will wake the HomeDock Deluxe screen.

### SCREEN SAVER TIME

Set your Screen Saver to appear after 2 minutes, 5 min., 10 min. or Never.

**Tip:** You can start up your HomeDock Deluxe Screen Saver at any time by simply pressing the **Backlight button** on your Remote Control.

# Playing and Controlling Music

The HomeDock Deluxe lets you enjoy your iPod's music through your home stereo, powered speakers and television. You can either select your music directly from your iPod (**iPod Mode**) or you can view, navigate and select your music using HomeDock Deluxe's super cool **On-Screen Music Navigation (On-Screen Navigation Mode)**. Refer to the diagram on the opposite page to learn how to direct your music using the HomeDock Deluxe Remote Control.

## Tips & Tricks for Playing Music

### USE PLAYLISTS

Playlists are a good way to group music by moods, genres, new albums. etc. For example: set up a "cocktails" Playlist, then a "dinner" Playlist, then an "after dinner" Playlist.

**NOTE:** **Next Music Playlist** and **Previous Music Playlist** buttons operate in **iPod Mode** only

### ADJUST VOLUME FOR BEST SOUND QUALITY

If your iPod's music through your HomeDock Deluxe sounds unusually low or noisy, be sure that your HomeDock Deluxe's volume is set at an adequate level. The balance of volume between your HomeDock Deluxe and Stereo/TV can affect the audio quality significantly.

## CONTROLLING YOUR MUSIC IN ON-SCREEN NAVIGATION MODE OR IPOD MODE

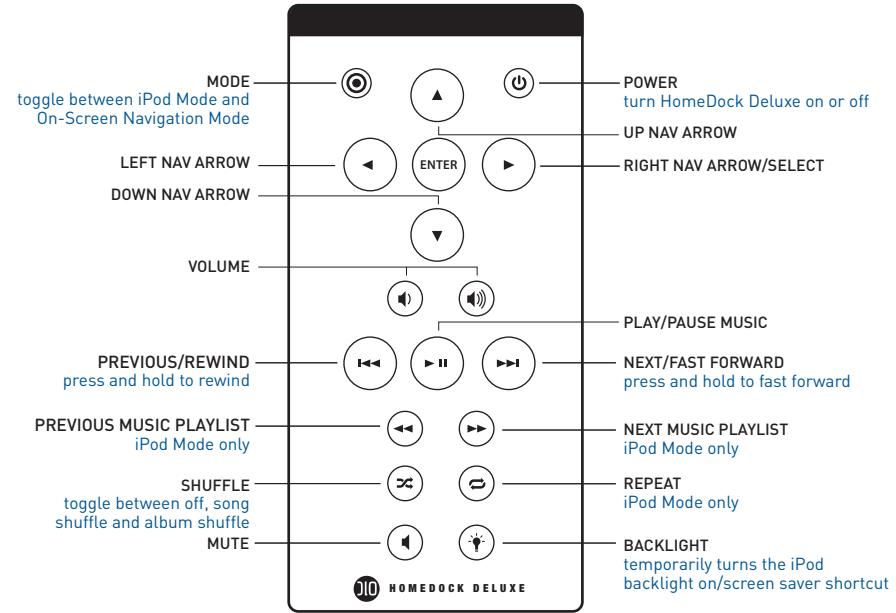



# Playing Photo Slideshows

Family vacation slideshows are back with the HomeDock Deluxe. Load up hundreds of pictures on your photo compatible iPod and follow these simple steps:

1. Dock your iPod onto your HomeDock Deluxe (make sure it's in **iPod Mode**)
2. Navigate, select and play a Slideshow from your iPod. You can use the Remote's Nav arrows to navigate your iPod's menus and make your selection. Be sure to select "TV ON" when prompted by your iPod.
3. Control Play/Pause, Next Slide, Previous Slide and more from the comfort of your couch with the HomeDock Deluxe remote control.

Refer to the diagram on the opposite page to learn how to direct your photo slideshows using the HomeDock Deluxe Remote Control.

**NOTE:** If you have questions or need help setting up your iPod for Photos and Slideshows, please visit Apple Support at [www.apple.com/support/ipod](http://www.apple.com/support/ipod).

## Tips & Tricks for Playing Photo Slideshows

### SELECT A GOOD SOUNDTRACK FOR THE SHOW

Slideshows are so much better with the right music accompanying your living room iPod picture show. On your iPod, choose a song for each slideshow and it will play through your HomeDock Deluxe loud and clear.

### IPOD NANO IS A SLIDESHOW NO-GO

Unfortunately, the iPod nano does not currently support external playback of its internal photos. However, all music functions, including **On-Screen Music Navigation**, work just great with the iPod nano.

## CONTROLLING YOUR PHOTOS IN IPOD MODE

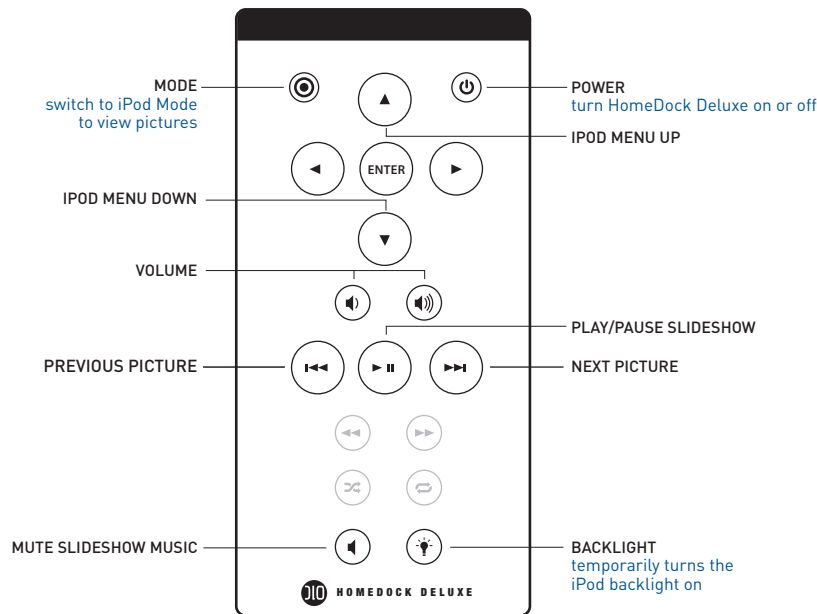

# Watching iPod Videos

The HomeDock Deluxe will display your iPod's videos on your television with video compatible iPods. Load up your favorite sitcom on your video compatible iPod and follow these simple steps:

1. Dock your iPod onto your HomeDock Deluxe (make sure it's in **iPod Mode**)
2. Navigate, select and play a Video from your iPod. You can use the Remote's Nav arrows to navigate your iPod's menus and make your selection. Be sure to select "TV ON" when prompted by your iPod.
3. Control Play/Pause, Fast Forward, Reverse and more from the comfort of your couch with the HomeDock Deluxe remote control.

Refer to the diagram on the next page to learn how to direct your video slideshows using the HomeDock Deluxe Remote Control.

**NOTE:** If you have questions or need help setting up your iPod for videos, please visit Apple Support at [www.apple.com/support/ipod](http://www.apple.com/support/ipod).

## NOT QUITE DVD QUALITY JUST YET

The iPod videos are very watchable on a full size TV, but don't expect perfect DVD quality. Video currently available at the iTunes Store is highly compressed down to 320x240 pixels. That's 1/4 the size of regular broadcast quality (640x480).

Video compatible iPods do an amazing job of upconverting its smaller videos to broadcast quality, but again don't expect a DVD quality picture, it's more like a VCR. For the best picture quality possible, do connect your HomeDock Deluxe to your TV using the S-Video output (S-Video Cable sold separately).

## CONTROLLING YOUR VIDEOS IN IPOD MODE

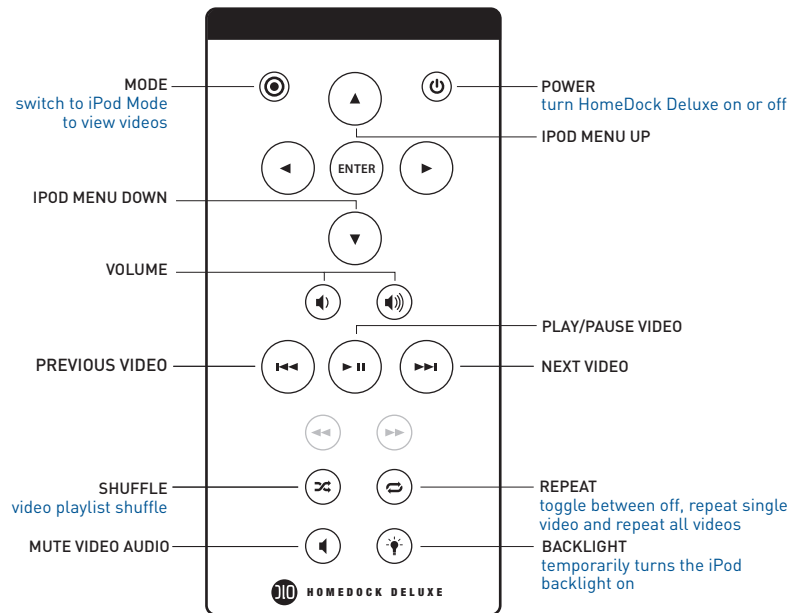

## Tips & Tricks for Playing iPod Videos

### WHY CAN'T I USE ON-SCREEN NAVIGATION TO BROWSE AND SELECT MY VIDEOS AND SLIDESHOWS USING THE HOMEDOCK DELUXE?

The current Apple iPod firmware requires that you select and start video or photo slideshows on the iPod itself. **It does not allow on-screen navigation of videos or photos - only music.** You can, however control playback and transport functions of videos and photos like Play/Pause, Fast Forward, Rewind, etc. using the HomeDock Deluxe Remote. To see the many functions you can control with the HomeDock Deluxe Remote Control, refer to **Playing Photo Slideshows** or **Watching iPod Videos**. [See pages 14-16]

### SET YOUR IPOD'S "TV OUT" SETTING TO ON TO SAVE A STEP

On your iPod, you can set your "TV Out" setting to "TV On" and it won't ask you every time you watch a video whether a TV is hooked up or not. If you ever want to watch a video on your iPod screen again, simply go to "Video Settings" and change the preference back.

The HomeDock Deluxe can also act as a desktop dock for your iPod to sync your iPod to any PC or Mac. Simply connect the HomeDock Deluxe to your computer via USB cable (not included) and update your iPod in iTunes by simply sliding your iPod onto your HomeDock Deluxe.

### CONNECTING HOMEDOCK DELUXE TO YOUR PC OR MAC

1. Use any standard USB 2.0 compatible A-to-B cable (not included) to connect the HomeDock Deluxe base to your home computer.
2. Your iPod will now sync with your computer + iTunes using the HomeDock Deluxe as your desktop iPod dock.
3. You can now control your iPod using the HomeDock Deluxe Remote Control. But to hear your iPod directly, you have to connect your HomeDock Deluxe audio output to your computer's audio input.

### TIPS & TRICKS FOR USING WITH MAC OR PC

To enjoy your iPod's music while it is docked on your desk, either connect your HomeDock Deluxe to a pair of Powered Speakers or plug it into the input of your computer to play through its speakers.

Be sure to update your iTunes software to the most recent version to insure the best results using your HomeDock Deluxe with your Mac or PC.

# Tips and Troubleshooting

## WHY CAN'T I USE ON-SCREEN NAVIGATION TO BROWSE AND SELECT MY VIDEOS AND SLIDESHOWS USING THE HOMEDOCK DELUXE?

The current Apple iPod firmware requires that you select and start video or photo slideshows on the iPod itself. **It does not allow on-screen navigation of videos or photos - only music.** You can, however control playback and transport functions of videos and photos like Play/Pause, Fast Forward, Rewind, etc. using the HomeDock Deluxe Remote. To see the many functions you can control with the HomeDock Deluxe Remote Control, refer to **Playing Photo Slideshows** or **Watching iPod Videos**. [\[See pages 14-16\]](#)

## DOES THE HOMEDOCK DELUXE CHARGE MY IPOD'S BATTERY?

Yes. The HomeDock Deluxe fully charges and powers your iPod whenever your iPod is connected.

## DO I HAVE TO USE A TV WITH THE HOMEDOCK DELUXE?

No. The only time you need a TV is to view Videos or Photos from a Video or Photo compatible iPod or for on-screen navigation of your music. With all other uses, the HomeDock Deluxe is a music-based, remote controlled home docking system for your iPod that requires nothing but a stereo or powered speakers to play your iPod's music.

Of course, to get the most out of your HomeDock Deluxe, you should connect it to a TV and home stereo. Remember, in order to use **On-Screen Music Navigation** to select and choose your music, you have to connect your HomeDock Deluxe to your TV.

## WHERE ARE MY PODCASTS WHEN I'M USING ON-SCREEN NAVIGATION?

The HomeDock Deluxe categorizes your Podcasts under Genres. Just select Genres from the Music Menu and find the Podcast you'd like to hear. If you want, you can organize your Podcasts into a Playlist in iTunes and then access them on your television using the HomeDock Deluxe.

**NOTE:** Your iPod will sometimes organize certain Podcasts under Albums or Artists, so be sure to check there as well.

## MY HOMEDOCK DELUXE ISN'T WORKING, WHAT'S THE DEAL?

First, be sure that your HomeDock Deluxe is powered on. Next, make sure that you are in the desired mode - **On-Screen Navigation** or **iPod**. To change modes, simply push the **Mode button** on your Remote Control.

## I'VE SELECTED A VIDEO OR PHOTO SLIDESHOW TO PLAY ON MY TV BUT INSTEAD IT'S ONLY PLAYING ON MY IPOD'S SCREEN.

On your iPod, check to see that your "TV Out" setting under Video/Slideshow Settings is set to either "Ask" or "On." Your Video or Slideshow will not play on your TV unless you select "TV On" when prompted by your iPod in the "Ask" setting, or you have selected "On" under "TV Out" in Video Settings. Your iPod arrives in the "Ask" setting, so you will have to select "TV On" each time you start up a video or photo slideshow unless you change your iPod's Settings.

## NTSC - PAL SWITCHING

The HomeDock Deluxe's default broadcast format is NTSC. However, it is PAL compatible too. If you have a TV that is formatted for PAL and your iPod's TV signal is set for PAL, simply select the PAL setting on the back of the HomeDock Deluxe base unit.

## INPUTS/OUTPUTS

**Left/Right Audio:** analog audio output

**Video:** composite video output

**S-Video:** separated analog video output

**Power Adapter Input:** 100-240VAC, 47-63 Hz

**Power Adapter Output:** 10VDC, 1.5 amps max

**USB-A:** standard universal serial bus, USB 2.0

## REMOTE CONTROL

**Battery:** 3V, type CR2032 or equivalent

## TELEVISION VIDEO FORMAT

NTSC/PAL (switchable)

## IPOD MODELS SUPPORTED

**Music Compatibility:**

**All Dockable iPods (excluding 3G iPod)**

- iPod mini (4GB, 6GB)
- 4G iPod with Click Wheel (20GB, 30GB, 40GB, 60GB, U2)
- 4G iPod with Color Display (20GB, 30GB, 40GB, 60GB, U2)
- iPod nano (1GB, 2GB, 4GB)
- 5G iPod with Video (30GB, 60GB)

**Picture Compatibility:**

**All iPods with Color Display (excluding iPod nano)**

- 4G iPod with Color Display (20GB, 30GB, 40GB, 60GB, U2)
- 5G iPod with Video (30GB, 60GB)

**Video Compatibility:**

**All iPods with Video capability**

- 5G iPod with Video (30GB, 60GB)

**NOTE:** Apple iPod models listed as of March 2006

## Digital Lifestyle Outfitters Limited Manufacturer's Warranty

**What This Warranty Covers.** DLO (Digital Lifestyle Outfitters) warrants this product against defects in materials and workmanship. This limited warranty applies only to products manufactured by or for DLO.

**What This Warranty Does Not Cover.** This warranty does not apply to damage caused by: (a) accident, abuse, misuse, misapplication, ordinary wear, improper maintenance, failure to follow instructions, or products not manufactured by or for DLO; and (b) aftermarket services (including upgrades and expansions).

**How Long This Warranty Lasts.** This warranty lasts for a period of ninety (90) days from the date of original retail purchase.

**What DLO Will Do.** If a defect exists, DLO will exchange the product, at its option, with a product that is new or has been manufactured from new or serviceable used parts and that is at least functionally equivalent to the original product. DLO will warrant a replacement product against defects in materials and workmanship for a period of ninety (90) days from the date of replacement.

**How To Get Service.** In order to be eligible for this warranty, you MUST register your purchase at [www.dlo.com/register](http://www.dlo.com/register) within thirty (30) days of purchasing this product. If you believe that this product is defective in materials or workmanship, please e-mail [customerservice@dlo.com](mailto:customerservice@dlo.com) with a brief description of the problem, for further instructions.

**No Change To Warranty.** No DLO reseller, agent or employee is authorized to make any modification, extension, or addition to this warranty.

**How State Law Applies.** This warranty gives you specific legal rights, and you also may have other rights that vary from state to state, or country.

**Restrictions On Implied Warranties.** All implied warranties, including, without limitation, warranties of merchantability and fitness for a particular purpose, are limited in duration to the duration of this warranty. Some states do not allow limitations on how long an implied warranty lasts, so the above limitation may not apply to you.

**Restrictions On Damages.** DLO is not responsible for direct, special, incidental or consequential damages resulting from any breach of warranty or condition or under any other legal theory (including, without limitation, lost profits; downtime; goodwill; damage to or replacement of equipment and property; failure to maintain the confidentiality of data stored on the product; and any costs of recovering, reprogramming or reproducing any program or data stored in or used with products manufactured by or for DLO). Some states and countries do not allow the exclusion or limitation of incidental or consequential damages, so the above limitation or exclusion may not apply to you.

W1000-050803-B

## Federal Communications Commission Interference Statement

This equipment has been tested and found to comply with the limits for a class B digital devices, pursuant to Part 15 of the FCC Rules. These limits are designed to provide reasonable protection against harmful interference in a residential installation. This equipment generates, uses, and can radiate radio frequency energy and, if not installed and used in accordance with the instructions, may cause harmful interference to radio communications. However, there is no guarantee that interference will not occur in a particular installation. If this equipment does cause harmful interference to radio or television reception, which can be determined by turning the equipment off and on, the user is encouraged to try to correct the interference by one or more of the following measures:

- Reorient or relocate the receiving antenna.
- Increase the separation between the equipment and receiver.
- Connect the equipment into an outlet on a circuit different from that to which the receiver is connected.
- Consult the dealer or an experienced radio/TV technician for help.

## CAUTION:

**To assure continued FCC compliance:** Any changes or modifications not expressly approved by the grantee of this device could void the user's authority to operate the equipment.

Thanks again for your  
purchase of the **DLO HomeDock Deluxe**.  
**Where your iPod lives - at home.**



## Free Manuals Download Website

<http://myh66.com>

<http://usermanuals.us>

<http://www.somanuals.com>

<http://www.4manuals.cc>

<http://www.manual-lib.com>

<http://www.404manual.com>

<http://www.luxmanual.com>

<http://aubethermostatmanual.com>

Golf course search by state

<http://golfingnear.com>

Email search by domain

<http://emailbydomain.com>

Auto manuals search

<http://auto.somanuals.com>

TV manuals search

<http://tv.somanuals.com>