

# TriplePlay

## MULTIZONE SATELLITE AUDIO RECEIVER



Thank You! .....	3
Installing TriplePlay.....	3
? Parts List .....	3
? Positioning the Antenna.....	3
? Mounting the Antenna .....	4
? Housing TriplePlay.....	5
Activating TriplePlay.....	5
Operating TriplePlay.....	6
? Default Display .....	7
? Powering On TriplePlay.....	7
? Changing Zones .....	7
? Changing Categories .....	7
? Changing Channels .....	7
? Setting and Recalling Presets .....	8
Configuring Options .....	8
? Entering SETUP Mode.....	8
? Blocking Channels.....	9
? Skipping Channels.....	10
? Displaying SIRIUS ID Numbers.....	10
Using the Remote Control .....	11
Integration with Distributed Audio Control Systems .....	11
Technical Assistance.....	11
12 Month Limited Warranty.....	12
Appendix A: Music and Entertainment Streams.....	13



Antex Electronics Corporation  
1125 W. 190<sup>th</sup> Street  
Gardena, California 90248  
USA

www.antex.com

Copyright © 2003 Antex Electronics Corporation. All Rights Reserved. No portion of this manual may be reproduced without prior written consent from Antex Electronics. The copyright protection claimed here includes photocopying, translation, and/or reformatting of the information contained in this manual.

Printed in the United States of America.

Document No.: 9000-2467-7006 Rev. A

### FCC Compliance Statement for United States Users

This equipment has been tested and found to comply with the limits for a Class B device, pursuant to Part 15 of the FCC Rules. In order to maintain compliance with FCC regulations, shielded cables must be used with this equipment. Operation with non-approved equipment or unshielded cables is likely to result in interference to radio and TV reception. Changes or modifications made to this equipment not expressly approved by Antex Electronics could void the user's authority to operate the equipment.

### IMPORTANT SAFETY INSTRUCTIONS

- ? Read Instructions – Read all Safety Instructions before operating equipment.
- ? Retain Instructions – Save these instructions for future reference.
- ? Heed Warnings – All warnings on the product and these instructions should be adhered to.
- ? Follow Instructions – All operating and use instructions should be followed.
- ? Cleaning – Do not use liquid cleaners or aerosol cleaners. Use a damp cloth for cleaning.
- ? Attachments – Do not use attachments not recommended by the manufacturer as they may cause hazards.
- ? Water and Moisture – Do not use this product near water – for example near a bathtub, wash bowl, kitchen sink or a room where moisture is likely to occur.
- ? Accessories – Do not place on an unstable surface (cart table or tripod) where tipping is a possibility.
- ? Ventilation – Install unit in well ventilated area where self generated heat may escape. Book cases or cabinets should have proper venting to allow heat to escape.
- ? Power outlet – A properly grounded wall outlet must be used. Do not use a plug adapter that bypasses the three-terminal ground plug.
- ? Power Cord Protection – Route your power cords out of traffic way so as not to be walked on or traveled over by carts wheels. Do not place items on top of or against the cord so as to pinch the cord.
- ? Outdoor Antenna Grounding – The antenna and coaxial cable connecting to the unit must be properly grounded to provide some protection against voltage surges and built-up static charges. Article 810 of the National Electrical Code, ANSI/NFPA 70, provides information with regard to proper grounding of the mast and supporting structure, grounding of the lead-in wire to an antenna discharge unit, size of grounding conductors, location of antenna-discharge unit, connection to grounding electrodes, and requirements for the grounding electrode.
- ? Power Lines – An outside antenna system should not be located in the vicinity of overhead power lines or electric light or power circuits, or where they can fall into such power lines or circuits. When installing an outside antenna system, extreme care should be taken to keep from touching such power lines or circuits as contact with them might be fatal.
- ? Overloading – Do not overload wall outlets, extension cords, or integral convenience receptacles as this can result in a risk of fire or electrical shock.
- ? Object and Liquid Entry – Never push objects of any kind into this product through openings as they may short-out parts that could cause a fire. Never spill liquid of any kind on the product.
- ? Servicing – Do not attempt to service this product yourself, there are no customer serviceable parts inside. Refer all servicing to qualified service personnel.  
A product and cart combination should be moved with care. Quick stops, excessive force, and uneven surfaces may cause the product and cart combination to overturn.
- ? Damage Requiring Service – Unplug this product from the wall outlet and refer servicing to a qualified service person under the following conditions:
  - a) When the power-supply cord or plug is damaged.
  - b) If liquid has been spilled, or objects have fallen into the product.
  - c) If product has been exposed to rain or water.
  - d) If the product does not operate normally by following the operating instructions. Adjust only those controls that are covered by the operating instructions as an improper adjustment of other controls may result in damage and will often require extensive work by a qualified technician to restore the product to its normal operation.
  - e) If the product has been dropped or damaged in any way.
  - f) When the product exhibits a distinct change in performance – this indicates a need for service.
- ? Replacement Parts – When replacement parts are required, be sure the service technician has used replacement parts specified by the manufacturer or have the same characteristics as the original part. Unauthorized substitutions may result in fire, shock, or other hazards.
- ? Safety Check – Upon completion of any service or repairs to this product, ask the service technician to perform safety checks to determine that the product is in proper operating condition.
- ? Heat – The product shall be situated away from sources such as radiators, heat resistors, heat registers, stoves, or amplifier that produce heat.

## Thank You!

Thank you for choosing the world's first high-fidelity, 3-zone satellite radio receiver. Only Antex Electronics' TriplePlay™ uses the revolutionary SIRIUS® Satellite Radio technology.

### 60 Channels of Music

SRX-3 TriplePlay lets you select from 60 original music channels, 24 hours a day, 7 days a week. Hear today's hits to R&B oldies to classical masterpieces, from authentic country and real bluegrass to cool jazz, hot Latin, reggae, rock, dance, gospel, new age and even kid's music.

### 40 Non-Music Channels

TriplePlay also gives you instant access to 40 plus channels of world class news, sports and entertainment from CNBC, CNN, BBC World Service, E! Entertainment Radio, ABC News & Talk, NPR Now, ESPN, The Speed Channel, and engaging entertainment from the golden age of radio on Radio Classics and Radio Disney.

### Three Listening Zones

TriplePlay gives you the option to select programming for three independent listening zones and independently control the operation of the receiver within each of those zones. With TriplePlay, you can listen to the latest Top 10 in your living room, sports in the family room, and the latest breaking news around the world in your bedroom.

A list of SIRIUS music and entertainment streams is provided for you in Appendix A. For the most up to date listings, go to [www.sirius.com](http://www.sirius.com).

## Installing TriplePlay

**Antex Electronics strongly recommends that the SRX-3 TriplePlay unit and its antenna be installed by a professional installer. Brief instructions are presented here for reference purposes only.**

### Parts List

Before installing your SRX-3 TriplePlay, make sure you have all the parts listed below:

- |                         |                        |
|-------------------------|------------------------|
| ? SRX-3 TriplePlay unit | ? Power cord           |
| ? Antenna               | ? RCA audio cables (3) |
| ? Remote control        |                        |

### Power Requirements

Power requirements for the TriplePlay are 100-140VAC, 50-60Hz, 50 Watts.

### Positioning the Antenna

Prior to mounting the antenna or finding a permanent home for your SRX-3 TriplePlay, you first want to validate the position of the antenna.

1. Power on TriplePlay to make sure the unit has power.  
You should see a startup screen with Antex and SIRIUS logos, followed by the main display (similar to that shown Figure 4 on page 7).
2. Power off TriplePlay, and then connect the audio cables, IR, and RS232 control interfaces to the other components in your audio system.
3. Using RG58U, 50 Ohm coaxial cable, connect the antenna to TriplePlay.

4. Position the antenna outdoors within 30 feet of the TriplePlay unit (or within 100 feet if you are using an inline amplifier).
5. Position the flat receiving dish straight up and with an unobstructed view to the SIRIUS satellites—that is, an unobstructed view toward the "X" Figure 1.

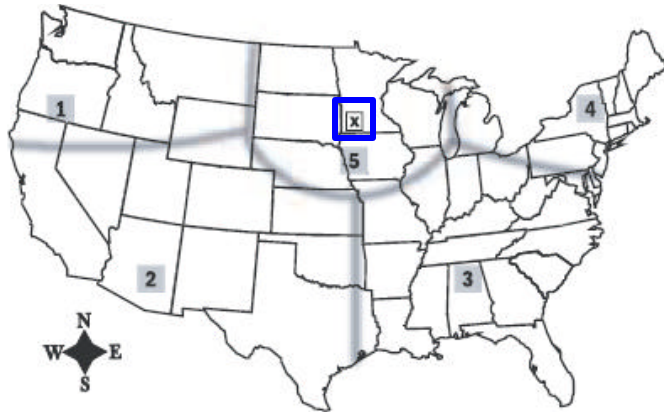

**Figure 1** Your antenna must have an unobstructed path to the satellites (marked by the "X" on the map).

6. Power on your sound system and turn the amplifier to a low volume.
7. Power on TriplePlay and tune to channel 184, a free preview channel. Press 1-8-4 on the front panel NUMERIC buttons.

If the system is working, you will hear SIRIUS programming on this channel and can proceed to Step 8.

If the antenna does not have a clear path to the satellites, TriplePlay's front panel display will read "Acquiring Signal" or "Antenna Not Connected." Reposition the antenna until you hear music playing.

8. Finish installing TriplePlay.
  - a) Mount the antenna in its permanent location. Follow the instructions in the section, "Mounting the Antenna."
  - b) House TriplePlay in its permanent location. Follow the instructions in the section, "Housing TriplePlay," starting on page 5.

- c) Activate the unit following the instructions on page 5.

## Mounting the Antenna

The antenna, as shown in Figure 2, must be mounted outdoors within 30 feet of the TriplePlay unit (or within 100 feet when using an inline amplifier). Its versatile mount allows it to be clamped to various objects or fastened directly to a rigid structure. For example, the antenna can be mounted to a wall or eave, screwed directly into the roof, or "mast mounted" to a plumbing vent pipe or other antenna mast such as the support post of a satellite TV dish.

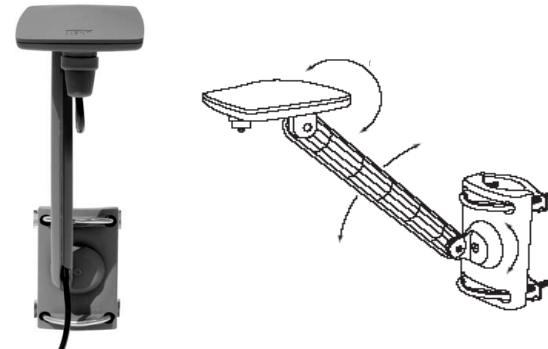

**Figure 2** Point the antenna's flat surface straight up.

The flat surface of the antenna's receiving dish should be installed to point straight up and have an unobstructed path (view) between it and the SIRIUS satellites—that is, the "X" in Figure 1. The path between your antenna and the SIRIUS satellites depends on your location in the U.S.

The best location for the antenna depends on where you live, the orientation of your home, and the locations of any obstructions that could prevent the satellite signal from reaching the antenna. The location of the "X" on the map in Figure 1 must be visible to the antenna. Table 1 defines the unobstructed view needed between your antenna and the satellites.

Before mounting the antenna, hold the antenna in the desired mounting location with the TriplePlay unit set up and powered on

to make sure that the system works with the antenna in that location.

**Table 1 Antenna mounting instructions.**

In this section...	Mount the antenna with an unobstructed view:
1	East or Northeast
2	North or Northeast
3	North or Northwest
4	West or Northwest
5	Straight up

When the antenna is securely mounted with a clear view up, run the RG58U 50 ohms coaxial cable to TriplePlay unit. Screw the cable connector to the antenna "finger tight" (do not over tighten with a wrench) and secure the antenna cable inside the arm of the antenna.

## Housing TriplePlay

House the TriplePlay unit in a component rack or other suitable location that provides adequate ventilation. **The maximum ambient temperature should never exceed 120 degrees Fahrenheit.**

After mounting the antenna, connect the audio cables (or optional TOSLINK), IR, and RS232 control interfaces to the other components in the system. Turn the volume control of amplifiers to a low level, then connect the power cable to the TriplePlay unit and power it on. A startup screen with Antex and SIRIUS logos will appear briefly, followed by the default display (see Figure 4 on page 7).

Tune to channel 184, a free preview channel, by pressing 1-8-4 on the front panel NUMERIC buttons. If the system is working, you will hear SIRIUS programming and can proceed to activating the unit. If the front panel display reads "Acquiring Signal" or "Antenna Not Connected," reposition the antenna until you hear music playing.

## Activating TriplePlay

After the channel 184 verification test, you must activate your SRX-3 TriplePlay to access all SIRIUS channels. To do so you must first obtain the SIRIUS ID numbers of your unit. The unit contains three ID numbers that are used to activate each of the three independent tuners (hereafter referred to as "zones").

Follow the instructions below to obtain the SIRIUS ID numbers and activate your SIRIUS radio service.

1. Press and HOLD the POWER button for four (4) sections to access the SETUP menu, as shown below.

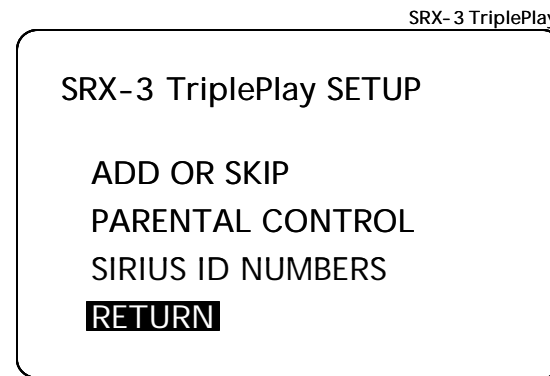

2. Press the CHANNEL down button to scroll to "SIRIUS ID NUMBERS," and then press the SELECT button. The SIRIUS ID NUMBERS screen appears. Record the ID numbers for each zone in the space below.  
 ZONE 1 ID: \_\_\_\_\_  
 ZONE 2 ID: \_\_\_\_\_  
 ZONE 3 ID: \_\_\_\_\_
3. Press the SELECT button to return to the default display.
4. Activate your SIRIUS radio service by: (a) going to [www.siriusradio.com](http://www.siriusradio.com), and then clicking the "JOIN" or "Activate Now" icon; or (b) calling SIRIUS at 1-888-539-7474. A friendly customer care representative will assist you in activating your unit.

## Operating TriplePlay

SRX-3 TriplePlay provides intuitive control of its various functions via its front panel buttons (as shown in Figure 3), the remote control, its hardwired IR, and the RS232 port (for local and remote operation). TriplePlay is essentially three completely independent SIRIUS satellite tuners—that is “zones”—each of which can be tuned independently so that different audio channels play in different rooms.

Within each zone you can:

- ? Change channels and music categories<sup>1</sup>
- ? Punch in a channel number to tune to it directly
- ? Set and tune to preset channels—10 in each zone.

You can also use the SETUP menu to block specific channels, as well as add and skip channels. Instructions for all these features are provided in this section.

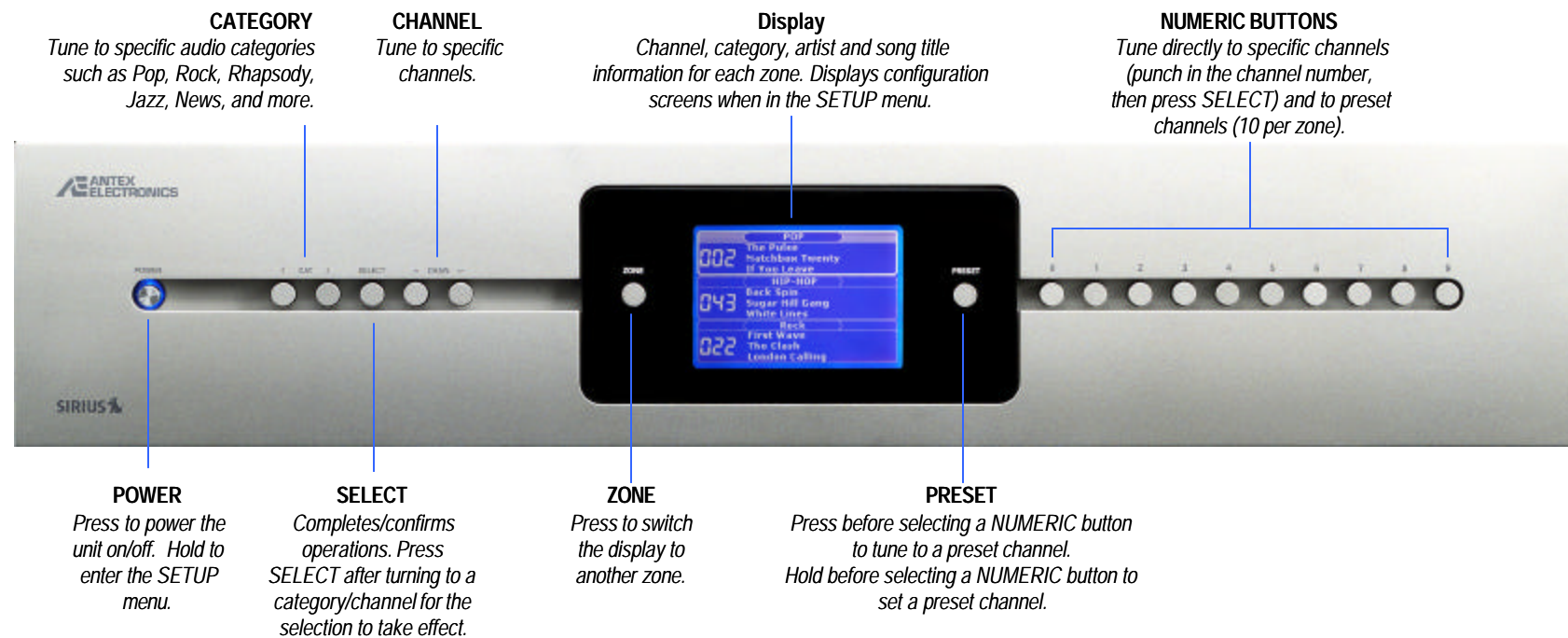
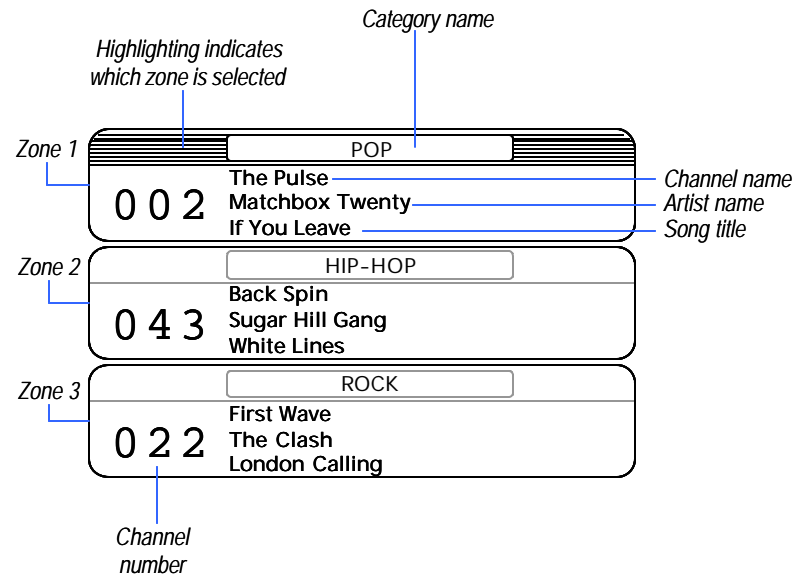

**Figure 3** TriplePlay buttons and multi-zone display.

<sup>1</sup> See Appendix A for a list of SIRIUS music and entertainment streams. For the most up to date listings, go to [www.sirius.com](http://www.sirius.com).

## Default Display

The default display, as shown below, provides detailed information about the channel each zone is currently tuned to, including category name, channel number, channel name, artist name, and song title.



**Figure 4** Highlighting indicates which zone in the display is currently selected.

## Powering On TriplePlay

With the unit and antenna properly installed, and the unit activated, press and release the POWER button to turn on the unit. The SIRIUS and Antex logos will appear for 2 seconds, followed by the default display. (If the SETUP menu appears, you held the POWER button too long. Press the SELECT button to return to the default display.)

## Changing Zones

The ZONE button is used to select the zone in which you want to change categories or channels. Press the ZONE button to cycle through the three zones in sequence. A highlighted zone in the default display (for example, zone 1 in Figure 4) is the one to which any channel and category changes are applied.

The zones corresponding to audio outputs 1, 2, and 3 are numbered from top to bottom. As shown in Figure 4, zone 1 is at the top of the display, zone 2 in the middle, and zone 3 at the bottom.

## Changing Categories

The audio channels<sup>1</sup> of the SIRIUS service are conveniently organized into categories such as Pop, Rock, News, Sports etc. The category of each zone is displayed in the title box of each zone. Press the CATEGORY up/down buttons to tune to a different category. After scrolling to the category you desire, press the SELECT button to confirm the category selection. Note that the category name, channel name, artist name, and song title information in the display changes to reflect the new category.

## Changing Channels

You can change music channels<sup>1</sup> using any of the following:

- ? Channel up/down to scroll through channels
- ? Numbered buttons to tune directly to a specific channel
- ? Preset button to tune to a preset channel

Use the **CHANNEL up/down** buttons to scroll through the channel within a zone. After scrolling to the channel you desire, press the SELECT button to confirm the channel selection. Note that the channel name, artist name, and song title information in the display changes to reflect the new channel.

You must press the SELECT button within four seconds of choosing a new channel or the channel change does not take effect.

You can also tune to a specific channel directly simply by pressing in its channel number using the **NUMERIC buttons**.

- ? When you enter a three-digit channel number, such as 1-8-4, TriplePlay automatically changes to that channel.
- ? When you enter a two-digit channel number, such as 1-8, you must then press the SELECT button for the channel change to take effect. (If you enter the channel number as 0-1-8, TriplePlay will make the change automatically.)

When preset channels have been set, you can access those presets simply by pressing the PRESET button, then an appropriate numeric button. For example, if preset 0 were set to Rock, preset 1 to Pop, and preset 2 to News, you could jump to the News channel quickly by pressing "PRESET-2."

## Setting and Recalling Presets

Each zone can have 10 channel presets (numbered 0 to 9). To assign a preset for the selected zone, first tune to a desired audio channel. Press and hold the PRESET button for one second, followed by a numeric button. For example, if you want to set channel 44 to preset 9, press and hold the PRESET button for one second, then press the numeric button "9." Note that the title bar display changes to "PRESET" to let you know that TriplePlay is ready to assign a preset channel.

To recall a stored preset, press (but don't hold) the PRESET button and then the desired numeric button (0-9).

## Configuring Options

TriplePlay's SETUP mode allows you to configure TriplePlay options (blocking, skipping, and adding channels) and obtain the unit's SIRIUS ID numbers for activation.

### Entering SETUP Mode

To enter the SETUP mode, press and hold the POWER button for four seconds. The menu shown in Figure 5 appears.

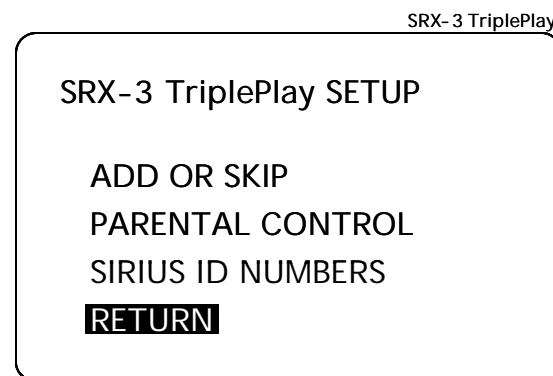

**Figure 5 SETUP mode menu.**

In SETUP mode:

- ? The CHANNEL up/down buttons are used to scroll through the menu options.
- ? The SELECT button is used to confirm selections.



## Blocking Channels

Using the Parental Control feature, you can block specific channels so that can be accessed only with a pass code that you define. Parents find this feature useful for preventing their children access to specific content.

To block a channel:

1. Press and hold the POWER button to enter SETUP mode.
2. Press the CHANNEL down button to highlight "PARENTAL CONTROL," and then press the SELECT button. A screen similar to that shown below appears.

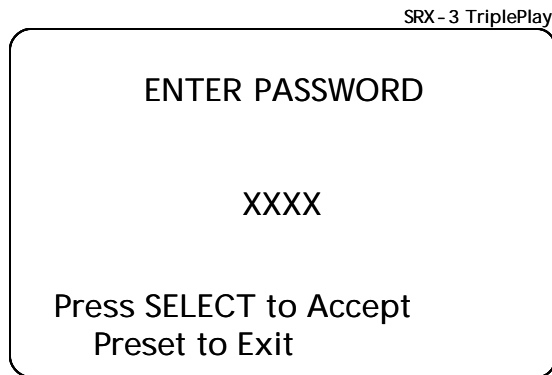

"XXXX" will appear for the password. You must set a password (if this is the first time at this menu) or enter a previously set password to proceed. Be careful to use a familiar number. Write this number down for future reference.

Pass code: \_\_\_\_\_

3. Enter 4 digits with the numeric buttons or remote, and then press SELECT. (To exit this menu without setting or entering the password and return to the previous menu, press the PRESET button.)

After you have entered the password successfully, the following menu will appear.

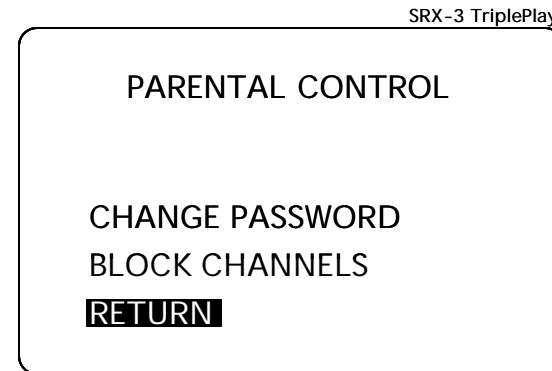

Note that you can change the password by repeating steps 1 through 3.

4. Scroll to highlight "BLOCK CHANNELS", and then press the SELECT button. A menu similar to that shown below appears.

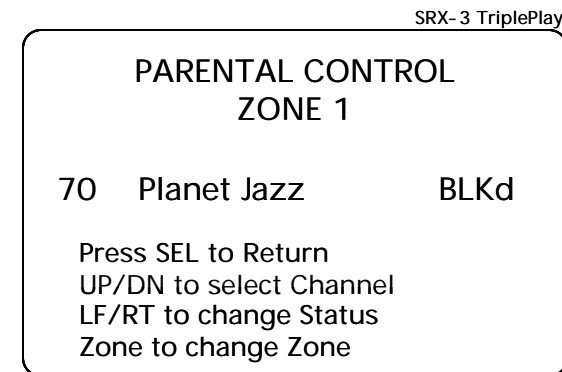

- Use the CHANNEL up/down buttons to scroll to the channel you want to block.
  - Use the CATEGORY left/right buttons to toggle the status between blocked "BLKd" or unblocked "NRML".
5. Block (or unblock) as many channels as you choose. When finished, press the SELECT button to return to the default display.

## Skipping Channels

In the course of using TriplePlay you may find that there are specific channels you prefer not to listen to and would rather skip over. Using TriplePlay's SKIP feature, you can program the unit to skip over these channels when scrolling using the CHANNEL up/down buttons or remote control. (Note that you can still access the "skipped" channels using the direct tune method.)

To configure a channel to be skipped when scrolling:

1. Press and hold the POWER button to enter SETUP mode.
2. Press the CHANNEL down button to highlight "ADD OR SKIP," and then press the SELECT button. A screen similar to that shown below appears.

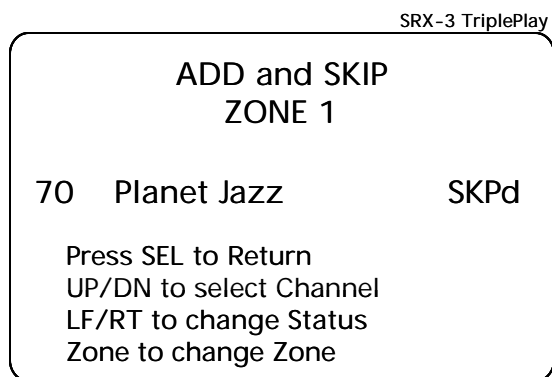

- Use the CHANNEL up/down buttons to scroll to the channel you want to skip (or add back a currently skipped channel).
  - Use the CATEGORY left/right buttons to toggle the status between skipped "SKPd" or not skipped "NRML".
3. Add and Skip as many channels as you prefer. When finished, press the SELECT button to return to the default display.

## Displaying SIRIUS ID Numbers

After initial activation it is unlikely that you will need to access the SIRIUS ID numbers again. If you do, please follow the instructions below.

1. Press and hold the POWER button to enter SETUP mode.
2. Press the CHANNEL down button to highlight "SIRIUS ID NUMBERS," and then press the SELECT button. A screen similar to that shown below appears.

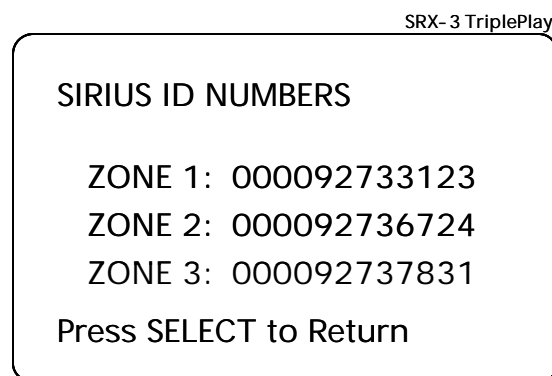

3. Press the SELECT button to return to the default display.

## Using the Remote Control

TriplePlay's remote control provides identical functionality to the buttons on the front panel.

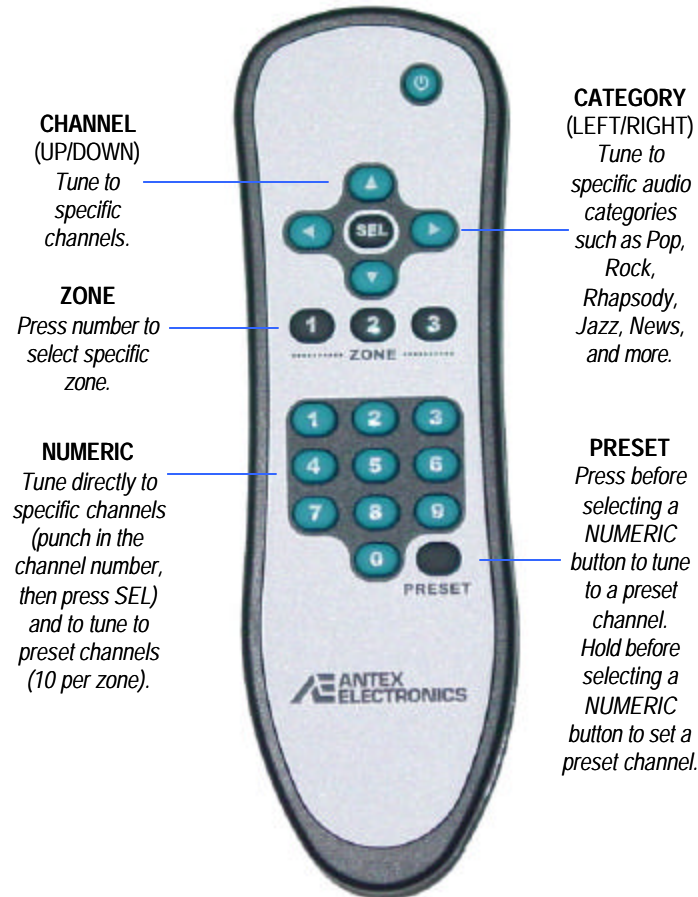

## Integration with Distributed Audio Control Systems

SRX-3 TriplePlay has been design for easy integration into distributed audio systems by professional installers. Three methods of interface are provided: the front IR receiver, rear hardwired IR Port on 3.5mm connector, and the rear RS232 port. Please contact your professional installer or visit our website [www.antex.com](http://www.antex.com) for more information, command sets, and available macros for third party control systems.

## Technical Assistance

Technical assistance is available from Antex via:  
email: [asupport@antex.com](mailto:asupport@antex.com)

Web: [www.antex.com](http://www.antex.com)

Phone: (310) 532-3092, ext 18 or 33, 7AM to 5PM PDT

## 12 Month Limited Warranty

Antex Electronics Corporation, (the Company) warrants to the original purchaser of this product that should this product or any part thereof, under normal use and conditions, be proven defective in material or workmanship within 12 months of the original date of purchase, such defect(s) will be repaired or replaced with new or reconditioned product (at the Company's option) without charge for parts and labor.

To obtain repair or replacement within the terms of this Warranty, the product is to be delivered with proof of warranty coverage (i.e. dated sales receipt), specification of the defect(s), and transportation prepaid to the Company at the address shown below.

This Warranty does not extend to the elimination of externally generated static or noise, to correction of antenna problems, to costs incurred for installation, removal or reinstallation of the product, or damage to other components.

This Warranty does not apply to any product or part thereof which, in the opinion of the Company, has suffered or been damaged through alteration, improper installation, mishandling, misuse, neglect, accident, or by removal of any factory applied markings. THE EXTENT OF THE COMPANY'S LIABILITY UNDER THIS WARRANTY IS LIMITED TO THE REPAIR OR REPLACEMENT PROVIDED ABOVE, AND, IN NO EVENT, SHALL THE COMPANY'S LIABILITY EXCEED THE PURCHASE PRICE PAID BY PURCHASER FOR THE PRODUCT.

This Warranty is in lieu of all other express warranties or liabilities. ANY IMPLIED WARRANTIES, INCLUDING AN IMPLIED WARRANTY OF MERCHANTABILITY, SHALL BE LIMITED TO THE DURATION OF THIS WRITTEN WARRANTY. ANY ACTION FOR BREACH OF ANY WARRANTY HEREUNDER INCLUDING ANY IMPLIED WARRANTY OF MERCHANTABILITY MUST BE BROUGHT WITHIN A PERIOD OF 12 MONTHS FROM DATE OF ORIGINAL PURCHASE. IN NO CASE SHALL THE COMPANY BE LIABLE FOR ANY CONSEQUENTIAL OR INCIDENTAL DAMAGES FOR BREACH OF THIS OR ANY OTHER WARRANTY, EXPRESS OR IMPLIED, WHATSOEVER. No person or representative is authorized to

assume for the Company any liability other than expressed herein in connection with the sale of this product.

Some states do not allow limitations on how long an implied warranty lasts or the exclusion or limitation of incidental or consequential damage so the above limitations or exclusions may not apply to you. This Warranty gives you specific legal rights and may also have other rights which vary from state to state.

Antex Electronics Corporation  
1125 West 190th Street  
Gardena, CA 90248  
(310) 532-3092

## Appendix A: Music and Entertainment Streams

Listed here for your reference are SIRIUS music and entertainment streams. For the most up-to-date list of music and entertainment streams, visit [www.sirius.com](http://www.sirius.com)

### Music Streams

#### Pop

- 1: US-1 (Top 40 Hits)  
The songs at the top of the pop charts and the latest pop hits breaking out across America.
- 2: The Pulse (The '90s & Now)  
The best variety of the '90s and now.
- 3: StarLite (Adult Contemporary)  
The brightest stars of today and yesterday, singing the hits.
- 4: Movin' Easy (Easy Listening)  
Easy listening vocal and instrumental favorites.
- 5: Sirius Gold (Best of the '50s)  
The roots of rock n' roll.
- 6: '60s Vibrations (Best of the '60s)  
Relive the musical revolution of the '60s.
- 7: Totally '70s (Best of the '70s)  
Let the music take you back.
- 8: Big '80s (The Best of the '80s)  
Experience the reemergence of pop music.
- 10: Spirit (Christian Hits)  
The power and positive impact of Christian music.

#### Rock

- 15: The Rock (Classic Rock)  
The top tracks from the legends of classic rock.
- 16: The Vault (Deeper Classic Rock)  
Deeper cuts from rock's legendary performers.
- 17: Jam Central (Jam Bands)  
A new rock stream playing the latest jam bands.
- 18: The Trend (Adult Album Alternative)  
40 years of "world-class rock."

- 20: Octane (Modern Rock)  
The home of high-powered pure rock.
- 21: Alt Nation (Alternative Rock)  
The diverse sounds of current alternative music.
- 22: First Wave (Classic Alternative)  
The music that kicked off alternative rock.
- 23: Big Rock (Stadium Rock)  
The best of stadium rock.
- 24: Organic Rock (Eclectic Rock)  
Musical territory with no boundaries.
- 25: The Bridge (Mellow Rock)  
The soft side of classic rock.
- 26: Left Of Center (Underground . Independent)  
Indie, underground, and unsigned bands.
- 27: Hard Attack (Metal)  
A nonstop barrage of music with attitude for true metal heads.
- 28: Sirius Blues (Blues)  
The many shades of blues music.

#### Country

- 31: New Country (Today's Country Hits)  
The sound of today's country music.
- 32: Country Road (Country Mix)  
Bridging country's classic sound with today's favorite hits.
- 35: Road House (Classic Country)  
Country gold from the legends.
- 36: The Border (Alternative Country)  
A rough-around-the-edges sound from just this side of Nashville.
- 37: Bluegrass (Bluegrass)  
Bluegrass is handmade, heartfelt American music.

#### Hip-Hop

- 40: Hip-Hop Nation (Today's Rap)  
The raw, uncensored jointz.
- 41: Planet Rhyme (International Rap . Spoken Word)  
The international sound of hip-hop.
- 42: Wax (Turntablism . Freestyle)  
World-class DJs show off their cutting and scratching skills.
- 43: Back Spin (Old Skool Rap)  
The pioneers of old skool, upfront and in the mix.
- 44: Street Beat (Rap Hits)  
All rap, all the time.

### **R&B**

- 50: Hot Jamz (Urban Contemporary)  
Sizzling hits of today's hip-hop and R&B culture.
- 51: Heart & Soul (R&B Hits)  
The biggest R&B hits from the '80s, '90s and today.
- 52: Slow Jamz (Soul Ballads)  
The softer side of today's R&B.
- 53: Soul Revue (Classic Soul)  
The sounds of the golden age of R&B.

### **Dance**

- 60: House Party (House Music)  
Innovative, pulsating, nonstop house music.
- 62: The Rave (Non-Stop Club Mix)  
The nonstop energy of the club and rave nightlife.
- 63: Planet Dance (Mainstream Dance)  
From house to trance to techno and beyond.
- 64: The Vortex (Electronica)  
The full spectrum of electronic dance music.
- 66: The Beat (Dance Hits)  
The nonstop beat of today's biggest dance hits and remixes.
- 68: The Strobe (Disco)  
The disco inferno, boogie fever, and more.

### **Jazz/Standards**

- 70: Planet Jazz (Contemporary Jazz)  
The continuing evolution of today's jazz!
- 71: Jazz Café (Smooth Jazz)  
A sophisticated soundtrack of smooth instrumentals and vocals.
- 72: Pure Jazz (Classic Jazz)  
The sounds and styles of the masters, past and present.
- 73: Swing Street (Swing)  
This joint is jumping with authentic jazz swing bands!
- 75: Fantasy Ballroom (Standards)  
From the crooners to the cabarets, all the timeless standards.
- 77: Broadway's Best (Show Music)  
Round-the-clock entertainment from Broadway past and present.

### **Classical**

- 80: Symphony Hall (Symphonic)  
Classical music at its best, heard in its entirety.

- 82: Vista (Chamber Works)  
The intimate, personal side of classical music.
- 85: Classical Voices (Classical Voices)  
Music celebrating the glory of the human voice.

### **Variety**

- 90: Universo Latino (Latin Pop Mix)  
A vibrant and rhythmic blend of the greatest Latin music.
- 91: Mexicana (Mexicana)  
Regional Mexican music at its best.
- 92: Reggae Rhythms (Reggae)  
Reggae music from its '60s roots to today's exciting sounds.
- 94: Folk Town (Folk)  
The grand tradition of minstrels, troubadours, and trios.
- 95: Praise (Gospel)  
Let the music lift you up as high as the music soars.
- 96: Kids Stuff (Kids)  
Music, stories, and more for the younger set.
- 98: Soundscapes (New Age)  
A perfect blend of new age and ambient music.
- 99: Horizons (World Music)  
Rock the global village with music spanning six continents.
- 100: Sirius Sessions (LIVE Features)  
LIVE music direct from the SIRIUS Studios, along with an ever-changing listening experience.

## **Entertainment Streams**

### **News**

- 101: CNBC  
The latest in business and financial news from around the world.
- 102: Bloomberg Radio  
Up-to-the-minute coverage of the financial markets.
- 103: ABC News & Talk  
News and information dedicated to keeping listeners informed.
- 104: CNN Headline News  
Up-to-the-minute news and headlines.
- 105: FOX News Channel  
\*The Network America Trusts For Fair And Balanced News.
- 106: NPR Now  
News, entertainment, and all of your NPR favorites.

## 107: NPR Talk

The best call-in talk shows public radio has to offer.

## 108: PRI's Public Radio Channel

Connecting the world to your life.

## 109: TWC Radio Network, National

Current weather and extended forecasts throughout the country.

## 110: TWC Radio Network, East

Weather from Maine to Mississippi.

## 111: TWC Radio Network, Central

Weather from Kansas to Texas.

## 112: TWC Radio Network, West

Weather West of the Rockies.

## 113: C -SPAN Radio

Gavel-to-gavel, live public affairs coverage without the spin.

## 114: BBC World Service News

The world's reference point.

## 115: World Radio Network

An international tour of the news from broadcasters worldwide.

## 116: BBC Mundo

International news and issues affecting Latin America.

## Sports

## 120: ESPN Radio

The best in sports programming from the worldwide leader in sports.

## 121: ESPNEWS

The definitive 24 hour sports news network.

## 122: Sports Byline USA

Interactive sports talk, news, interviews, and highlights.

## 123: Sirius Sports Action

Complete sports coverage and play-by-play action.

## 124: Sports 1

Love it Live.

## 125: Sports 2

Love it Live.

## 126: Sports 3

Love it Live.

## 128: Radio Deportivo

Sports talk and LIVE event coverage.

## Entertainment

## 130: Radio Disney

Music and information for kids and 'tweens.

## 131: STN: Sirius Trucking Network

News and information for the commercial driver.

## 132: WSM Entertainment

Home of the Grand Ole Opry.

## 133: RadioClassics

Classic shows from the Golden Age of Radio.

## 134: Court TV, Plus

Reality radio from Court TV.

## 135: Sirius Entertainment

Your all-access pass into the lives of your favorite stars.

## 136: E! Entertainment Radio

Your daily dose of entertainment industry news.

## 137: A&amp;E Satellite Radio

The best of A&E Television Networks programming.

## 138: Discovery Channel Radio

Real-world entertainment and information.

## 139: La Red Hispana

International news, business, and current events.

## 140: Radio Amigo

Political commentary and information.

## 141: Radio Mujer

Programming that touches the lives of Latinas in the US.

## 142: The Word Network

The undisputed source for urban ministries and Gospel music.

## 143: WISDOM Radio

Programming dedicated to life improvement.

## 144: Sirius Right

Your home for conservative talk.

## 145: Sirius Left

Your SIRIUS Talk Alternative.

## 146: Sirius Talk

Information, entertainment, and the unknown.

## 147: Sirius Comedy

Stand-up and more.

## 149: OutQ

News, information, and entertainment for the Gay and Lesbian community.





## Free Manuals Download Website

<http://myh66.com>

<http://usermanuals.us>

<http://www.somanuals.com>

<http://www.4manuals.cc>

<http://www.manual-lib.com>

<http://www.404manual.com>

<http://www.luxmanual.com>

<http://aubethermostatmanual.com>

Golf course search by state

<http://golfingnear.com>

Email search by domain

<http://emailbydomain.com>

Auto manuals search

<http://auto.somanuals.com>

TV manuals search

<http://tv.somanuals.com>