



AMERICAN AUDIO®
6122 S. Eastern Ave.
Los Angeles Ca. 90040
Rev. 9/10

VLP 2500

User Instructions



This symbol is intended to alert the user to the presence of non insulated "dangerous voltage" within the product's enclosure that may be of sufficient magnitude to constitute a risk of electric shock to persons.



This symbol is intended to alert the user of the presence of important operating and maintenance (servicing) instructions in the literature accompanying the product.

CAUTION: Risk of the electrical shock - **DO NOT OPEN!**

CAUTION: To reduce the risk of electrical shock, do not remove cover. No user serviceable parts inside. Refer all servicing to qualified service personnel.

WARNING: To prevent electrical shock or fire hazard, do not expose this amplifier to rain or moisture. Before using this amplifier, read the user manual for further warnings.



Este símbolo tiene el propósito de alertar al usuario de la presencia de "voltaje peligroso" que no tiene aislamiento dentro de la caja del producto que puede tener una magnitud suficiente como para constituir riesgo de corrientazo.



Este símbolo tiene el propósito de alertar al usuario de la presencia de instrucciones importantes sobre la operación y mantenimiento en la literatura que viene con el producto.

PRECAUCIÓN: Riesgo del choque eléctrico - **NO SE ABRA**

PRECAUCIÓN: Para disminuir el riesgo de choque eléctrico, no quite la cubierta. No hay piezas adentro que el usuario puede reparar. Deje todo mantenimiento a los técnicos cualificados.

ADVERTENCIA: Para prevenir choque eléctrico o riesgo de incendios, no deja expuesto a la lluvia o a la humedad este amplificador. Antes de usar este amplificador, lea más advertencias en la guía de operación.



Ce symbole est utilisé pour indiquer à l'utilisateur la présence à l'intérieur de ce produit de tension non-isolée dangereuse pouvant être d'intensité suffisante pour constituer un risque de choc électrique.



Ce symbole est utilisé pour indiquer à l'utilisateur qu'il trouvera d'importantes instructions importantes sur l'utilisation et l'entretien de l'appareil dans la littérature accompagnant le produit.

ATTENTION: Risque de choc électrique - **NE PAS OUVRIR!**

ATTENTION: Afin de réduire le risque de choc électrique, ne pas enlever le couvercle. Il ne se trouve à l'intérieur aucune pièce pouvant être réparée par l'utilisateur. Confier l'entretien à un personnel qualifié.

AVERTISSEMENT: Afin de prévenir les risques de décharge ou de feu, n'exposez pas cet appareil à la pluie ou à l'humidité. Avant d'utiliser cet amplificateur, lisez les avertissements supplémentaires situés dans le guide.



Dieses Symbol soll den Anwender vor unisolierten gefährlichen Spannungen innerhalb des Gehäuses warnen, die von Ausreichender Stärke sind, um einen elektrischen Schlag verursachen zu können.



Dieses Symbol soll den Benutzer auf wichtige Instruktionen in der Bedienungsanleitung aufmerksam machen, die Handhabung und Wartung des Produkts betreffen.

VORSICHT: Risiko - Elektrischer Schlag! Nicht öffnen!

VORSICHT: Um das Risiko eines elektrischen Schlages zu vermeiden, nicht die Abdeckung entfernen. Es befinden sich keine Teile darin, die vom Anwender repariert werden könnten. Reparaturen nur von qualifizierter Fachpersonal durchführen lassen.

ACHTUNG: Um einen elektrischen Schlag oder Feuergefahr zu vermeiden, sollte dieses Gerät nicht dem Regen oder Feuchtigkeit ausgesetzt werden. Vor Inbetriebnahme unbedingt die Bedienungsanleitung lesen.



CAUTION
**Do not open -
risk of electric shock**



CAUTION: TO REDUCE THE RISK OF ELECTRIC SHOCK, DO NOT REMOVE THE COVER. THERE ARE NO USER SERVICEABLE PARTS INSIDE. REFER ALL SERVICE TO YOUR AUTHORIZED AMERICAN AUDIO® DEALER.



The lightning flash with an arrow triangular symbol is intended to alert the user to the presence of non insulated “dangerous voltage” within the products enclosure, and may be of sufficient magnitude to constitute a risk of electric shock.



The exclamation point triangular symbol is intended to alert the user to the presence of important operating and maintenance (servicing) instructions in the user manual accompanying the amplifier.



FOR OPTIMUM PERFORMANCE AND RELIABILITY DO NOT PRESENT THE AMPLIFIER WITH A SPEAKER LOAD OF LESS THAN 2 OHMS OR ANY COMBINATION OF SPEAKERS THAT TOGETHER ARE LESS THAN 2 OHMS!

USING ONE SPEAKER, IT MUST BE RATED AT 4 OR MORE OHMS.

USING TWO SPEAKERS, THEY MUST RATED EACH AT 4 OR MORE OHMS.

USING THREE SPEAKERS, THEY MUST BE RATED EACH AT 8 OR MORE OHMS.



POUR ASSURER LA FIABILITE ET OBTENIR UNE PERFORMANCE OPTIMALE, NESOUMETTE JAMAIS L'AMPLIFICATEUR A UNE CHARGE D'IMPEDANCE TOTALE INFERIEURE A 2 OHMS, NI AVEC UN H.P. NI EN COMBINAISON DES H.P.

AVEC UN H.P., IL FAUT UNE CHARGE D'IMPEDANCE MINIMUM DE 2 OHMS.

AVEC DEUX H.P., FAUT POUR CHAOUN UNE CHARGE D'IMPEDANCE MINIMUM DE 4 OHMS.

AVEC TROIS H.P., FAUT POUR CHAOUN UNE CHURGE D'IMPEDANCE MINIMUM DE 8 OHMS.

CONTENTS:

Safety Precautions.....	4
Introduction.....	4
Front Panel.....	5
Rear Panel.....	6
Inputs.....	7
Outputs.....	7
Speakon Output Connector Assembly.....	9
Operating Modes.....	10
Protection Circuitry	
Limiter.....	11
Short Circuit Protection.....	11
Thermal Protection.....	12
Amplifier Features.....	12
Speaker Setup.....	13
Warranty.....	14
Specifications.....	15

Important Precautions

- To reduce the risk of electrical shock or fire, do not expose this unit rain or moisture.
- Do not spill water or other liquids into or on to your unit.
- Do not attempt to operate this unit if the power cord has been frayed or broken.
- Do not attempt to remove or break off the ground prong from the electrical cord. This prong is used to reduce the risk of electrical shock and fire in case of an internal short.
- Disconnect main power before making any type of connection
- Do not remove the cover under any conditions. There are no user serviceable parts inside.
- Never plug this unit in to a dimmer pack.
- Always be sure to mount this unit in an area that will allow proper ventilation. Allow about 6" (15cm) between this device and a wall.
- Do not attempt to operate this unit, if it becomes damaged.
- This unit is intended for indoor use only, use of this product outdoors voids all warranties.
- During long periods of non-use, disconnect the unit's main power.
- Always mount this unit in a safe and stable manner.
- Power cords should be routed so they are not likely to be walked on, pinched by items placed upon or against them.
- Cleaning -The outside of the unit should be wipe down with a soft cloth and mild cleaner when needed.
- Heat -The appliance should be situated away from heat sources such as radiators, heat registers, stoves, or other appliances (including amplifiers) that produce heat.
- The fixture should be serviced by qualified service personnel when:
 - A. The power-supply cord or the plug has been damaged.
 - B. Objects have fallen on, or liquid has been spilled into the unit.
 - C. The appliance has been exposed to rain or water.
 - D. The fixture does not appear to operate normally or exhibits a marked change in performance.

Introduction

Introduction: Congratulations and thank you for purchasing this American Audio® VLP 2500 amplifier. This amplifier is a representation of American Audio's continuing commitment to produce the best and highest quality products all at an affordable price. Please read and understand this manual completely before attempting to operate your new amplifier. This booklet contains important information concerning the proper and safe operation of your new amplifier.

Unpacking: Every VLP 2500 amplifier has been thoroughly tested and has been shipped in perfect operating condition. Carefully check the shipping carton for damage that may have occurred during shipping. If the carton appears to be damaged, carefully inspect your unit for any damage and be sure all accessories necessary to operate the unit has arrived intact. In the event damage has been found or parts are missing, please contact our toll free customer support number for further instructions. Please do not return the amplifier to your dealer without contacting customer support first.

Installation: This amplifier is designed to mount into a standard 19" rack. The front panel provides four holes used to screw the unit into a rack. The unit also provides a way to rear mount the unit into a rack for added security. Rear mounting the unit is especially recommended for this amplifier if the unit is to mounted into a mobile rack.

Customer Support: American Audio® provides a toll free customer support line, to provide set up help and to answer any question should you encounter problems during your set up or initial operation. You may also visit us on the web at www.americanaudio.us for any comments or suggestions. For service related issue please contact American Audio®. Service Hours are Monday through Friday 9:00 a.m. to 5:00 p.m. Pacific Standard Time.

Voice: (800) 322-6337 E-mail: support@americanaudio.com

Fax: (323) 582-2941

Front Panel VLP2500

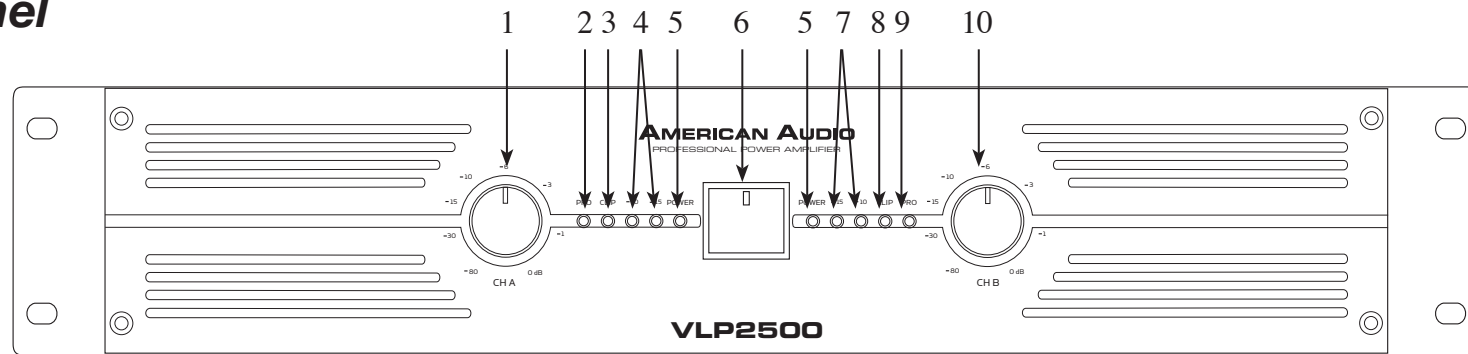

Figure 1

1. Channel 1 Gain Control - This rotary knob is used to control the output signal of channel one. Turning the knob in a clockwise direction will increase signal output.

2. Channel 1 Protect Indicator - The red Protect LED will begin to glow when the channel goes into protect mode. When the channel goes into protect mode all output for that channel will turn off. This is to protect any speakers connected to the channel.

3. Channel 1 Clip Indicator - This red LED will begin to flash when channel one begins to overload (clip). At this point channel one will begin to distort. Under heavy clipping activity lower the channel one gain control to reduce the risk of damage to your speakers and amplifier. This LED may glow when the unit has been turned off, this is normal.

4. Channel 1 Signal Indicators - These green and yellow LED's will glow according to the average signal output.

5. Function Indicators - These indicators detail the operating mode of the amplifier. These LEDs will also function as a power indicator.

6. Power Switch - This switch is used to control the units main power.

7. Channel 2 Signal Indicators - These green and yellow LED's will glow according to the average signal output.

8. Channel 2 Clip Indicator - This red LED will begin to flash when channel one begins to overload (clip). At this point channel one will begin to distort. Under heavy clipping activity lower the channel one gain

control to reduce the risk of damage to your speakers and amplifier. This LED may glow when the unit has been turned off, this is normal.

9. Channel 2 Protect Indicator - The red Protect LED will begin to glow when the channel goes into protect mode. When the channel goes into protect mode all output for that channel will turn off. This is to protect any speakers connected to the channel.

10. Channel 2 Gain Control - This rotary knob is used to control the output signal of channel two. Turning the knob in a clockwise direction will increase signal output.

Rear Panel Control VLP2500

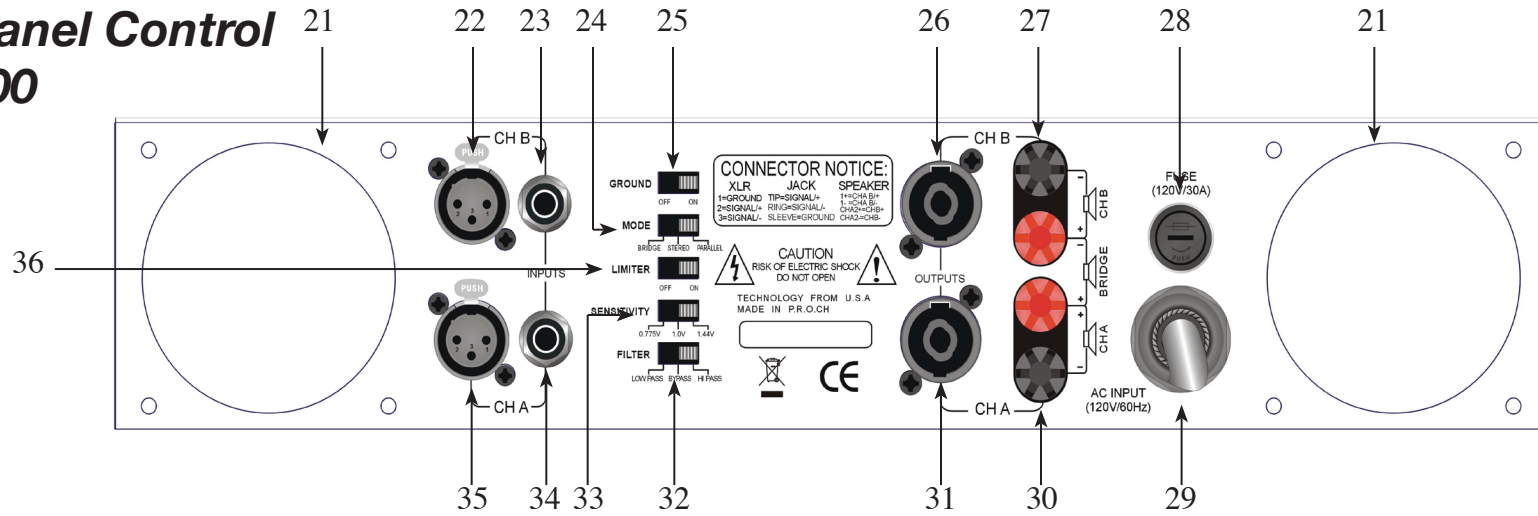

Figure 2

21. Cooling Fans - Dual high speed cooling fans

22. Channel 2 XLR Input - Channel two 3-pin XLR balanced input jack. See page 9 for more details.

23. Channel 2 TRS Input - Channel two 1/4" female jack. Expects either a balanced or unbalanced plug. See page 9 for more details.

24. Mode Switch - This switch controls the amplifier's operating mode. The amplifier can operate in three different modes; Mono Bridge, Stereo, or Parallel Mono. The amplifier is shipped in stereo mode.

25. Ground On/Off Switch - If hear a hum or any interference, put the Ground switch in the "On" position .

26. Channel 2 Speakon Output - Optional speaker output connections. Use pins 1+ and 1- of this 4-pole Speakon connector to connect to your speaker's Speakon input jack.

27. Channel 2 Output Jack/5 way Binding Post - Connect to your speaker's input jack. Red is positive signal and Black is negative signal.

28. Fuse Holder - This housing stores 30 amp GMA protective fuse for the 120V version and 15 amp GMA fuse for the 230/245V version. Never defeat the fuse, the fuse is designed to protect the electronics in the event of severe power fluctuations. Always be sure to replace the fuse with an exact match as the one being replaced, unless otherwise told to do so by an authorized American Audio® service technician.

29. AC Cord - Plug this cable into a standard wall outlet. Check that the voltage in your area matches the amplifiers required voltage.

30. Channel 1 Output Jack/5 way Binding Post - Connect to your speaker's input jack. Red is positive signal and Black is negative signal.

31. Channel 1 Speakon Output - Optional speaker output connections. Use pins 1+ and 1- of this 4-pole Speakon connector to connect to your speaker's Speakon input jack.

32. Filter Switch - This switch controls the amplifier's filter mode. The amplifier can operate in three different filter modes; High Pass, Low Pass, and By-Pass.

33. Sensitivity Switch - This switch lets you choose the input sensitivity.

34. Channel 1 TRS Input - Channel one 1/4" female jack. Expects either a balanced or unbalanced plug. See page 9 for more details.

35. Channel 1 XLR input - Channel one 3-pin XLR balanced input jack. See page 9 for more details.

36. Limiter Switch - This switch is used to limit the input level. Use this function to avoid damage to your speakers.

Set Up

INPUTS - The VLP 2500 amplifier allows you to use two types of input connector per a channel, a XLR jack for balanced connections and a 1/4" female jack that will accept balanced and unbalanced connectors. Use these connections to connect the output signal from a mixer, cross-over or EQ to your VLP 2500 amplifier. A balanced connection is recommended for cable runs longer than 20ft. When constructing your own XLR cables follow the pin configuration describe below for proper connections. For cable runs shorter than 20ft. you may choose the 1/4" unbalanced input option. The 1/4" unbalanced input option may be more convenient for most users due to the abundant supply of prefabricated cables available at your local audio dealer.

Male XLR Pin Configuration: US ITT Standard

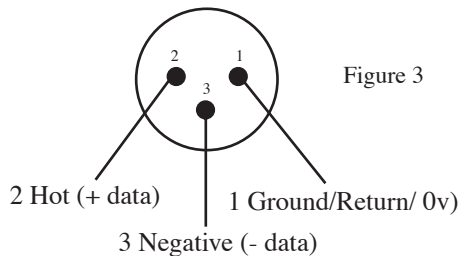

Balanced TRS 1/4" Plug

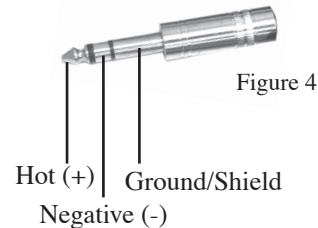

Unbalanced TS 1/4" Plug

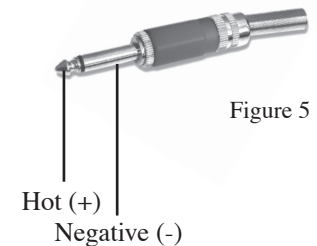

OUTPUTS:

Binding Post/Banana Plug - Connect your speakers to the binding post outputs on the rear of the amplifier. The speaker wire may be connect by bare wire (directly connected, usually for permanent connections), banana plug, or spade connector. Connections are made to Channels 1 and 2 output's for stereo mode or across the red terminals of Channels 1 and 2 for Mono Bridge Mode.

Important Notice: Although a speaker will operate with the positive and negative leads plugged into either terminal on the amplifier binding post, be sure to plug the negative lead into the black terminal and positive lead into the red terminal. Ensuring proper polarity will avoid speakers being out of phase, that can cause a loss of bass response.

Important Notice: Banana Plugs - When connecting your speakers to the amplifier using banana jacks; Be sure that the red and black caps on the binding post are completely screwed in. Insert the banana jacks into the caps of the binding post, be sure that the banana jack is inserted securely to avoid the risk of it popping out.

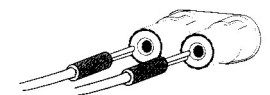

Figure 6

Bare Wire Connections: (Figure 7)

When connecting your speakers to the amplifier using bare wire; Unscrew the red and black caps on the binding post, be sure not to completely remove or unscrew the red and black caps. Strip back the wire insulation 1/2" (13mm). Insert the bare wire into the hole that was revealed by unscrewing the binding post cap. After inserting the wire into the binding post hole, screw the binding post cap down on the wire. To reduce the risk of shock or damage to your amplifier, be sure that the wire connected to one binding post does not come in contact with that of another.

Spade Connector: (Figure 8)

When connecting your speakers to the amplifier using spade connector; Unscrew the red and black caps on the binding post, be sure not to completely remove or unscrew the red and black caps. Insert the spade connector in to the binding post and tighten the caps down on the spade connector. To reduce the risk of shock or damage to your amplifier, be sure that the wire connected to one binding post does not come in contact with that of another.

When connecting your speakers to the amplifier using banana jacks; Be sure that the red and black caps on the binding post are tighten down completely. Insert the banana jacks into the caps of the binding post, be sure that the banana jack is inserted securely to avoid the risk of it popping out.

Mono Bridge Connections:

Mono bridge operation connections will follow the above descriptions however, when operating in mono bridge operation the speaker connections will run between the two positive (red) leads. Use channel two positive output terminal for the negative connection and the channel one positive output terminal for the positive connection.

Stereo Connections Using the Neutrik Speakon output connectors:

Recent regulatory requirements in Europe have outlawed the use of the dual banana plug and force amp users to terminate their speaker cables with spade lugs or bare wire ends. This is not advantageous to most users that want to reconfigure their systems or quickly change out an amp. The Neutrik Speakon® connector provides the most convenient solution to this problem, eliminating the need for spade plugs or bare wire end cables. Major speaker manufacturers have been using Speakon connectors on their products for years, so chances are you are ready to use the Speakon connection. With Speakon connectors, you can connect straight from the amplifier to the speaker. The Speakon connector used on this amplifier meets all known safety regulations. Once wired correctly, the connector cannot be plugged in backwards, causing the type of inverted polarity situations that have become common with banana hookups. This connection will provide a safe, secure and reliable method of connecting your speakers to your new amplifier. You can purchase the Speakon® NL4FC connectors from your local audio dealer.

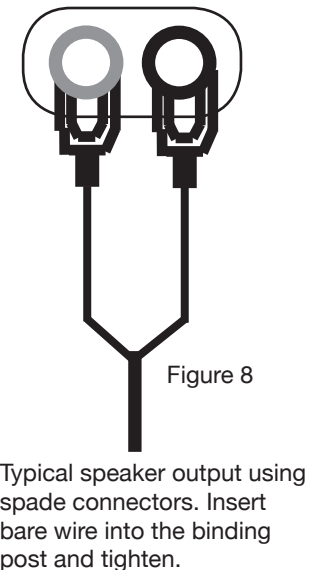
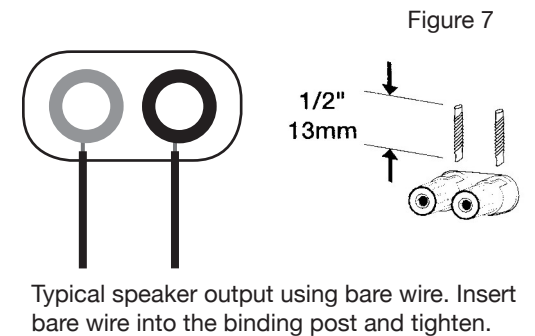

SPEAKON ASSEMBLY: You will need a pair of Neutrik Speakon® NL4FC connectors. You will also need high-quality two or four conductor speaker cable, a pair of needle-nosed pliers and a 1.5-mm Allen key to assemble the Speakon connectors to your speaker wire. To assemble the Neutrik Speakon NL4FC connector, complete the following steps:

1. Strip back 3/4-inch of the cable casing. Strip off 1/4-inch from the end of each of the conductors down to bare wire, and insert the brass fittings. See Figure 9.
2. Slide the cable tension clip (D) and the speakon coupler (E) through the cable end. See Figure 10.
3. Insert each wire with the brass fittings into the top of appropriate slot of the connector insert (B) as shown in Figures 10 and 11. Use a 1.5-mm Allen key to tighten the connection. See Figure 11.
4. Be sure to properly match the positive (+) and negative (-) leads of each wire. See Figure 12.
5. Slide the connector insert (B) into the connector housing (A), making sure that the large notch on the outer edge of the insert lines up with the large groove on the inside of the connector housing. The insert should slide easily through the housing and out the other side until it extends approximately 3/4-inch from the end of the housing.
6. Slide the cable tension clip (D) along the cable and insert into the housing (A), making sure that the large notch lines up with the large groove on the inside of the connector housing (A). The cable tension clip (D) should slide easily into the housing until only 3/8-inch of the cable tension clip (D) extends from the back end of the connector.
7. Slide the coupler (E) along the cable and screw it onto the end of the housing (A). Before tightening, you may want to test the connector to make sure it has been assembled properly.

Figure 9

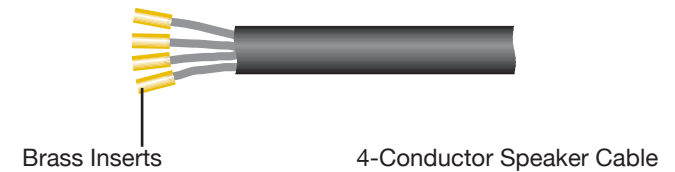

Figure 10

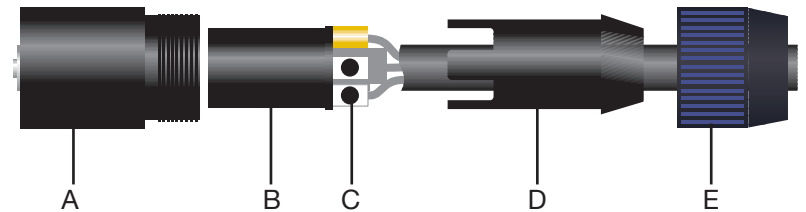

Figure 11

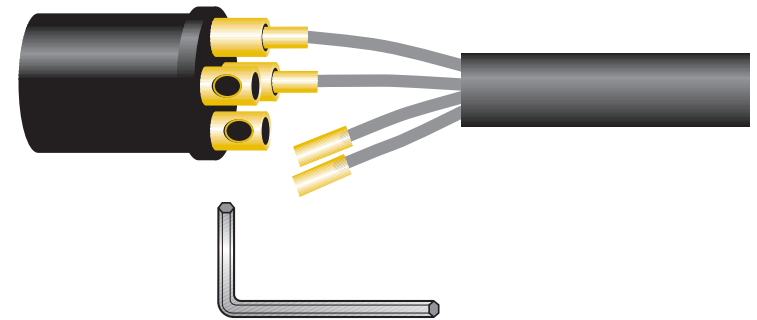
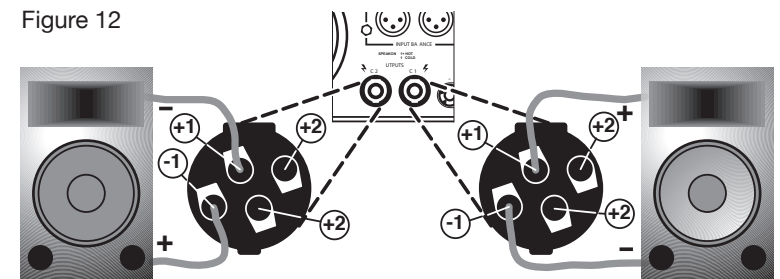

Figure 12



OPERATING MODES: Always configure your amplifier operating mode before beginning operation. If you want to change it during performance. You must decrease the gain controls to their lowest levels to protect the speakers from any popping noise.

Stereo Operation - Page 13/Figure 13 details an example of a typical stereo set-up. Connect your inputs into channels one and two of the amplifier. Connect your speakers to the outputs on the rear of the amplifier. Be sure that your front gain controls are turned down to their lowest level (full counter-clockwise). Turn your amp on. Turn your input source level up. Use your front gain controls to regulate the output volume. Be sure not to raise the volume to the clip level, however an intermittent clip signal is acceptable.

Mono Bridge Operation - Page 13/Figure 16 details a mono bridge set-up. Be sure your amplifier and all other audio equipment is powered down. Flip the Stereo/Mono Bridge switch to the Mono Bridge position. Connect an input signal to channel one. Connect your speaker across the red output binding post on the rear of your amplifier. Turn your equipment on (your amplifier should always be the last item you turn on). Apply an input source signal to your amplifier. Turn channel two gain up. Use the channel one gain to regulate your amplifier output.

Bridged-Mono Mode Caution - The voltage across the output terminals of a bridged VLP 2500 amplifier may equal or exceed 100 volts RMS and may be as high as 130 volts. Use fully insulated CLASS ONE wiring, and the load must be rated for up to 2500 watts (@4 ohms)

Parallel Mono - "Parallel" ties the two channel line inputs together so that they will both be driven by the same signal, without the need for external jumpers or wiring. Both amplifier channels will operate independently. Though they carry the same signal, their gain controls affect only their respective channels, and they both must use their respected speaker outputs. Never attempt to parallel the speaker outputs, this may cause serious damage to your amplifier! This mode is recommended when using the VLP 2500 to run bass speakers, to achieve better low end. To run in parallel mono mode connect your system as you would if you were going to run in stereo mode. Then flip the mode switch to "MONO." Be sure the amp is off or the power is disconnected before making any changes.

Mono Subwoofer - This operation is similar to the Stereo Subwoofer operation but in mono. When running subwoofers it is usually recommended to run them in mono mode to achieve a cleaner tighter low end. This operation allows you to run several subwoofers down to a minimum of 4 ohms. To avoid amplifier overheating, never run the amplifier below 8 ohms in this mode. Set up this mode as you would a standard stereo set up. Be sure both channels are set to "SUBWOOF" and the mode switch is set to "MONO." In this mode you may use the frequency adjustment on the rear of the amp, to control the bass frequency output level. Frequencies may be adjusted from 20Hz to 200Hz.

One Channel Normal/One Channel Subwoofer (BI-AMP) - You may also use your amp to bi-amp your system. You may use one side of the amp to power a subwoofer and the other side to power a full range speaker. Follow the set up guides listed above to mix and match your operations.

PROTECTION:

Limiter - The VLP 2500 comes with a built in limiter. When the input signal overloads, the "CLIP LED's" indicate a signal overload, at this time, the master volume should be lowered to reduce distortion. If the input gain level is not reduced the built-in limiter will activate. During signal overload, the limiter will reduce the input audio signal enough to minimize the amount of clipping. A limiter takes the gain of an overloading signal and reduces it, the reduction in gain reduces distortion that can cause damage to your speakers and amplifier. During normal operation below clipping, and momentary clips on peaks, the limiter does not affect the audio signal and is inaudible. It will allow brief clipping of peaks and will only activate when continuous, hard clipping occurs. During excessive clipping the limiter will reduce the audio signal enough to minimize the amount of clipping. When the input signal decreases enough that clipping ends, the limiter will deactivate and cease its gain reduction. The limiter has a fixed threshold and can not be adjusted.

Safe Power Levels at Different Output Loads:

8-Ohm Loads: The amplifier can operate at practically any power level without risk of overheating. However, if it is pushed hard enough to continually light the "CLIP " indicator, the amplifier's average output power can reach 150 watts.

4-Ohm Loads: If the "CLIP" indicator flashes occasionally, the amplifier is approaching its maximum long-term power capacity. If it is lit about half the time, the amplifier channel will probably go into thermal protection within a few minutes.

Short Circuit Protection - The VLP 2500 amplifiers all come with built-in Output Short Circuit Protects. The Output Short Circuit Protection protects the output devices of the amplifier from short circuits and stressful loads. If your speaker lines short, the amplifier automatically detects this problem and discontinues operation for that channel. If one side of your amplifier becomes shorted and goes into protect mode, the other side will continue to operate normally. During short circuit protection, the "Clip" LED and "Protect" LED will light simultaneously indicating amplifier fault. All channel output during the "Short Circuit Protection" will be interrupted (i.e. no sound out

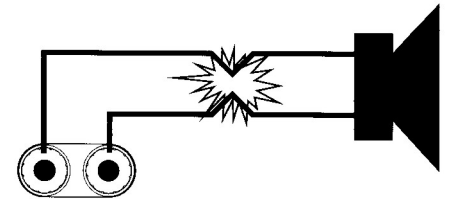

put). *Short Circuit Protection* can usually be traced back to the signal output line (i.e. speaker line). Check the line from the output terminal of the amplifier to the speaker. If this line good, check the internal speaker connections and components. A short circuit will usually be traced to a bad cable or a bad speaker component and is rarely traced to the amplifier itself.

Thermal Protection - Dual variable speed fans on the VLP 2500 amplifier provide adequate cooling. During low level output the fans run at normal speeds. During high output and as heat raises, (exceeding 90°C.), the fans will run at higher speeds to aid the cooling process. If the heatsink temperature exceeds 91°C., the amplifier will mute until the amplifier cools down. When the amplifier cools below 90°C., the amplifier will return to normal operations. Be sure not to operate your amplifier below the minimum load ratings to reduce the risk of overheating problems.

Input/Output Protection - The input circuits are isolated by 10k resistors. An ultrasonic network uncouples **RF** from the output and helps keep the amplifier stable with reactive loads.

Operating Voltage (AC Mains) - The serial number label indicates the correct AC main voltage. Connecting to the wrong voltage is dangerous and may damage the amplifier. Always be sure the source voltage for your areas matches the required voltage for your amplifier.

Gain Controls - The gain controls are located on the front panel and are calibrated in 2dB of attenuation from full gain. It is best to adjust the amplifier so no “hissing” is heard from speakers with no music being played, this will ensure the lowest possible distortion during normal operation.

AMPLIFIER FEATURES:

GROUND LIFT SWITCH - Applying or lifting the ground switch will change the level for background noise and hum, if the noise level remains the same in either position, it is better to keep the ground lift switch in the ground position. This will eliminate 60Hz cycle hum that is sometimes induced when mounting several units in the same rack.

OPERATING VOLTAGE (AC MAINS) - The serial number label indicates the correct AC main voltage. Connecting to the wrong voltage is dangerous and may damage the amplifier.

GAIN CONTROLS - The gain controls are located on the front panel and are calibrated in 2dB of attenuation from full gain. It is best to adjust the amplifier so no “hissing” is heard from speakers with no music being played, this will ensure the lowest possible distortion during normal operation.

LED INDICATORS - Each channel has five LEDs. Two green LEDs indicate signal level activity. One yellow LED indicates signal clipping. One red LED indicates protection mode for shorts/ overload. One blue LED indicates power for each individual channel.

TYPICAL STEREO OUTPUT CONNECTIONS

Figure 13

Use Speakon or Banana Jacks

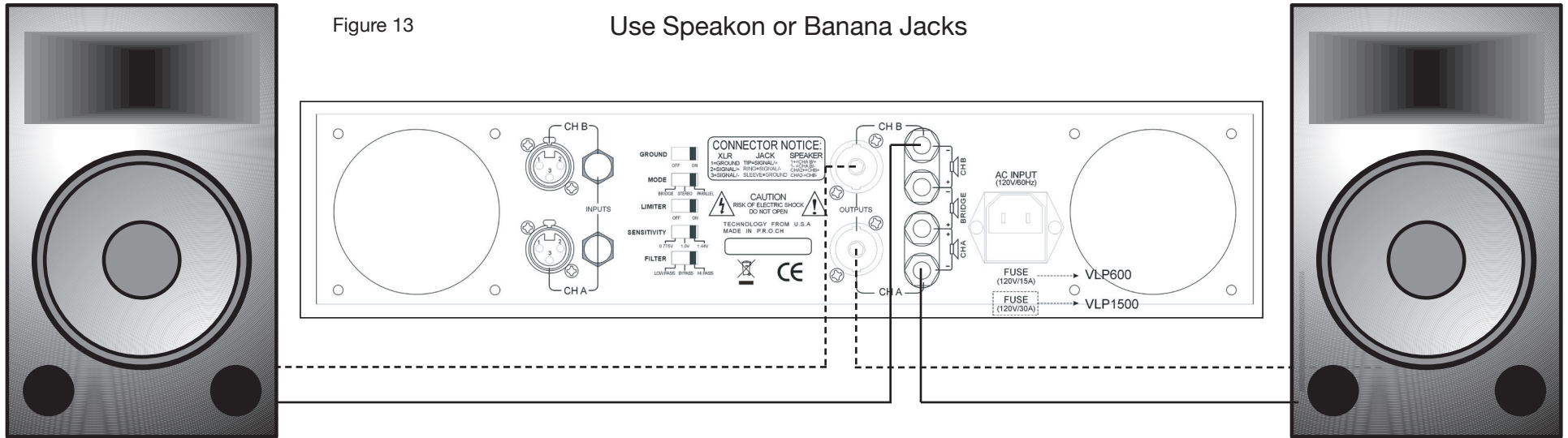

SPEAKERS
4 OHM MINIMUM

SPEAKERS
4 OHM MINIMUM

TYPICAL MONO BRIDGE SET-UP

Use Channel 1 Inputs Only (XLR or 1/4" Jacks)

Figure 14

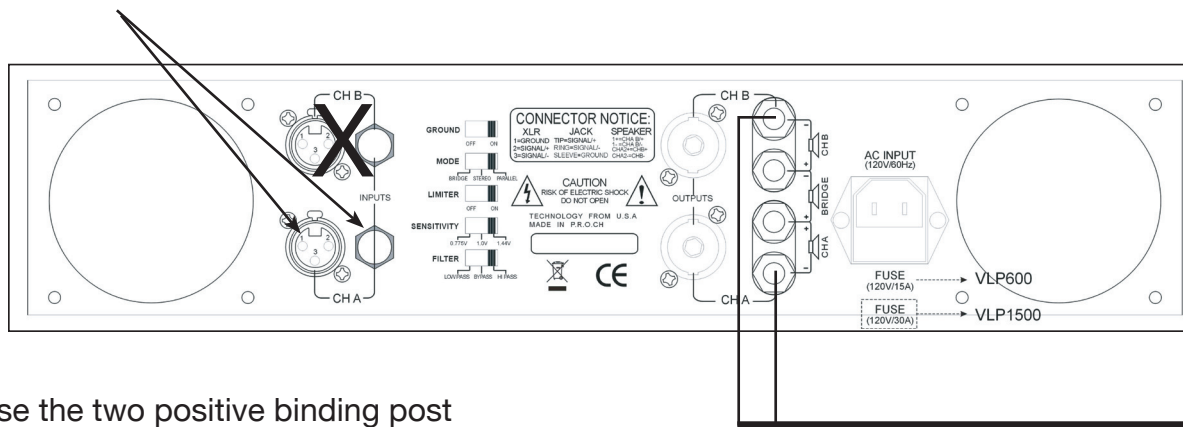

Use the two positive binding post terminals (red) for speaker output.

SPEAKERS
8 OHM MINIMUM

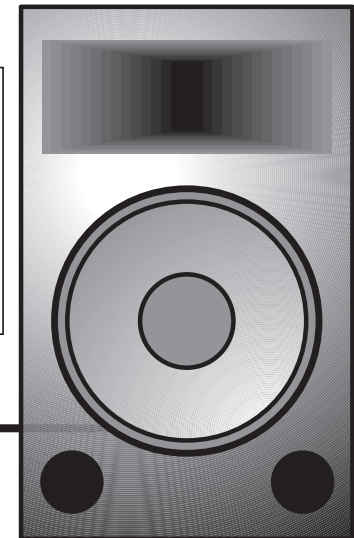

The VLP 2500 carries a one year limited warranty. We recommend you fill out the enclosed warranty card to validate your purchase. All returned service items whether under warranty or not, must be freight pre-paid and accompany a R.A. (return authorization) number. If the mixer is under warranty, you must provide a proof of purchase invoice. You may obtain a R.A. number by contacting our customer support team on our toll free number. Please contact American Audio® customer support at (800) 322-6337 for a R.A. number. All package not displaying a R.A. number on the outside of the package will be returned to the shipper.

1-YEAR LIMITED WARRANTY

A. American Audio® hereby warrants, to the original purchaser, American Audio® products to be free of manufacturing defects in material and workmanship for a period of 1 Year (365 days) from the date of purchase. This warranty shall be valid only if the product is purchased within the United States of America, including possessions and territories. It is the owner's responsibility to establish the date and place of purchase by acceptable evidence, at the time service is sought.

B. For warranty service, send the product only to the American Audio® factory. All shipping charges must be pre-paid. If the requested repairs or service (including parts replacement) are within the terms of this warranty, American Audio® will pay return shipping charges only to a designated point within the United States. If the entire instrument is sent, it must be shipped in its original package. No accessories should be shipped with the product. If any accessories are shipped with the product, American Audio® shall have no liability whatsoever for loss of or damage to any such accessories, nor for the safe return thereof.

C. This warranty is void if the serial number has been altered or removed; if the product is modified in any manner which American Audio® concludes, after inspection, affects the reliability of the product; if the product has been repaired or serviced by anyone other than the American Audio® factory unless prior written authorization was issued to purchaser by American Audio®; if the product is damaged because not properly maintained as set forth in the instruction manual.

D. This is not a service contract, and this warranty does not include maintenance, cleaning or periodic check-up. During the period specified above, American Audio® will replace defective parts at its expense, and will absorb all expenses for warranty service and repair labor by reason of defects in material or workmanship. The sole responsibility of American Audio® under this warranty shall be limited to the repair of the product, or replacement thereof, including parts, at the sole discretion of American Audio®. All products covered by this warranty were manufactured after January 1, 1990, and bear identifying marks to that effect.

E. American Audio® reserves the right to make changes in design and/or improvements upon its products without any obligation to include these changes in any products theretofore manufactured.

F. No warranty, whether expressed or implied, is given or made with respect to any accessory supplied with products described above. Except to the extent prohibited by applicable law, all implied warranties made by American Audio® in connection with this product, including warranties of merchantability or fitness, are limited in duration to the warranty period set forth above. And no warranties, whether expressed or implied, including warranties of merchantability or fitness, shall apply to this product after said period has expired. The consumer's and or Dealer's sole remedy shall be such repair or replacement as is expressly provided above; and under no circumstances shall American Audio® be liable for any loss or damage, direct or consequential, arising out of the use of, or inability to use, this product.

G. This warranty is the only written warranty applicable to American Audio® products and supersedes all prior warranties and written descriptions of warranty terms and conditions heretofore published.

VLP 2500 SPECS

Power supply: AC 100V, 50/60Hz (Japan) AC 110V, 60Hz (Colombia) AC 120V, 60Hz (U.S.A. and Canada) AC 127V, 60Hz (Mexico) AC 220V, 50Hz (Chile and Argentina) AC 220V, 60Hz (Philippines and Korea) AC 230V, 50Hz (Europe, New Zealand, South Africa, and Singapore) AC 240V, 50Hz (Australia and U.K.)	
MODEL:	VLP2500
Output Power:	700W RMS per Channel @ 8 Ohms, 1kHz, 0.1% THD (Stereo) 1100W RMS @ 4 Ohms, 1kHz, 1% THD (Stereo) Bridged Mono: 2800W RMS @ 4 Ohms, 1kHz, 1% THD
Total Harmonic Distortion (THD):	Less Than 0.5% (20Hz - 20kHz @ 8 Ohms)
Frequency Response:	(+/-0.5db, @ rated output power, 8 Ohms): 20Hz - 20kHz
Slew Rate:	20V Per use
Damping Factor @ 8 Ohm:	+ 450
Impedance:	20K Ohms Balanced 10K Ohms Unbalanced
Dimensions (LxWxH):	17.8" x 19" x 3.5" 453 x 482 x 88mm
Weight:	49.8lbs/22.6Kgs

©American Audio® World Headquarters:
6122 S. Eastern Ave. Los Angeles, CA 90040 USA
Tel: 323-582-3322 Fax: 323-725-6100
Web: www.AmericanAudio.us E-mail: info@americanaudio.us

American DJ Europe
Junostraat 2
6468 EW Kerkrade
Netherlands
service@americandj.eu / www.americandj.eu
Tel: +31 45 546 85 00 / Fax: +31 45 546 85 99

Free Manuals Download Website

<http://myh66.com>

<http://usermanuals.us>

<http://www.somanuals.com>

<http://www.4manuals.cc>

<http://www.manual-lib.com>

<http://www.404manual.com>

<http://www.luxmanual.com>

<http://aubethermostatmanual.com>

Golf course search by state

<http://golfingnear.com>

Email search by domain

<http://emailbydomain.com>

Auto manuals search

<http://auto.somanuals.com>

TV manuals search

<http://tv.somanuals.com>